



**AALBORG UNIVERSITY**  
DENMARK

**Aalborg Universitet**

## **Impact of Power Converters and Battery Lifetime on Economic Profitability of Residential Photovoltaic Systems**

Sandelic, Monika; Sangwongwanich, Ariya; Blaabjerg, Frede

*Published in:*  
IEEE Open Journal of Industry Applications

*DOI (link to publication from Publisher):*  
[10.1109/OJIA.2022.3198366](https://doi.org/10.1109/OJIA.2022.3198366)

*Creative Commons License*  
CC BY 4.0

*Publication date:*  
2022

*Document Version*  
Publisher's PDF, also known as Version of record

[Link to publication from Aalborg University](#)

*Citation for published version (APA):*  
Sandelic, M., Sangwongwanich, A., & Blaabjerg, F. (2022). Impact of Power Converters and Battery Lifetime on Economic Profitability of Residential Photovoltaic Systems. *IEEE Open Journal of Industry Applications*, 3, [9855838]. <https://doi.org/10.1109/OJIA.2022.3198366>

### **General rights**

Copyright and moral rights for the publications made accessible in the public portal are retained by the authors and/or other copyright owners and it is a condition of accessing publications that users recognise and abide by the legal requirements associated with these rights.

- Users may download and print one copy of any publication from the public portal for the purpose of private study or research.
- You may not further distribute the material or use it for any profit-making activity or commercial gain
- You may freely distribute the URL identifying the publication in the public portal -

### **Take down policy**

If you believe that this document breaches copyright please contact us at [vbn@aub.aau.dk](mailto:vbn@aub.aau.dk) providing details, and we will remove access to the work immediately and investigate your claim.

Received 9 March 2022; revised 6 July 2022; accepted 8 August 2022. Date of publication 15 August 2022; date of current version 25 August 2022. The review of this article was arranged by Associate Editor Luca Solero.

Digital Object Identifier 10.1109/OJIA.2022.3198366

# Impact of Power Converters and Battery Lifetime on Economic Profitability of Residential Photovoltaic Systems

**MONIKA SANDELIC**  (Student Member, IEEE), **ARIYA SANGWONGWANICH**  (Member, IEEE),  
**AND FREDE BLAABJERG**  (Fellow, IEEE)

AAU Energy, Aalborg University, 9220 Aalborg, Nordjylland, Denmark

CORRESPONDING AUTHOR: MONIKA SANDELIC (e-mail: mon@energy.aau.dk)

This paper is the extension of the conference paper titled 'Impact of Power Converters and Battery Lifetime on Return of Investment of Photovoltaic Systems' authored by M. Sandelic, A. Sangwongwanich and F. Blaabjerg that was presented at the 2020 IEEE 9th International Power Electronics and Motion Control Conference (IPEMC2020-ECCE Asia), Nanjing, China, 29 Nov.–2 Dec. 2020. This work was supported by the Reliable Power Electronic-Based Power System (REPEPS) project at the AAU Energy, Aalborg University as part of the Villum Investigator Program funded by the Villum Foundation.

**ABSTRACT** The installations of the residential photovoltaic (PV) systems with integrated battery energy storage are strongly dependent on their economic profitability. The Net Present Value (NPV), which is a metric to evaluate the cost-effectiveness of PV-battery systems, can be strongly influenced by the replacement cost. Thus, the lifetime of the reliability-critical components such as power converters and battery plays an important role and needs to be considered during the economic evaluation. In this paper, an impact of power converters and battery lifetime on the economic profitability of the PV-battery system for different installation sites is analyzed. A comprehensive model, consisting of system performance, lifetime, and economic profitability aspects as well as their interconnections is developed in this paper. A case study reveals that the NPV can be significantly over-estimated if the power converters and battery need to be replaced several times during the entire lifespan of the PV-battery system. Hence, the lifetime analysis should be included in the economic assessment and reflected with a more realistic component replacement cost during the planning stage of the residential PV-battery projects.

**INDEX TERMS** Photovoltaic system, battery, power electronics, economic profitability, lifetime, net present value, reliability.

## I. INTRODUCTION

Photovoltaic (PV) technology is considered as the key enabling technology for reaching carbon-neutral power supply in the near future. In 2020, more new power generation capacity was provided by PV than any other generating technology in European Union [1]. PV systems can range from hundreds of MW utility-scale systems to only a few kW rooftop residential systems [2]. The latter has become an attractive solution due to the increased electricity cost saving opportunities for private home owners. This is driven by the increasing price of the utility electricity, where the cost saving opportunities due to the internal power supply are evident [3]. Additionally, in some electricity markets, such as Germany, supplementary incentives (e.g., feed-in tariff) influenced the

escalated deployment of the grid-connected residential PV systems [4].

To provide additional flexibility, a large share of the residential PV systems nowadays are integrated with the energy storage system [5]. For instance, about 50% of all newly installed PV systems on the residential level in Germany in 2020 were coupled with battery storage [6]. Moreover, the total number of PV-battery systems has increased 10 times from 2013 to 2018 and similar trend is seen in the rest of the countries with high PV power penetration [5], [7]. This is especially important as the PV power generation and household load demand are often mismatched. In fact, the peak PV power generation during a typical day corresponds to the period with the decreased household load consumption. Therefore,

the excess PV power generation can be stored in the energy storage system and used at later times when the load demand is increased [8]. Batteries are often preferred energy storage option due to their suitable technical characteristics, substantial improvements in technology and continuous decrease in price [7], [9].

To fully utilize the benefits of PV-battery system, it is necessary to ensure optimal design solution. The two important aspects during design process are economic profitability and the longevity/reliability of the system [10]. In fact, it is highly favorable that all newly installed PV-battery projects are cost-effective with long lifetime and high reliability. A PV-battery system designed with a poor reliability can have a substantial impact on its economic profitability. In that case, the reliability-critical components need to be replaced several times during the entire system operation. This can lead to unplanned system downtime, where the residential load cannot rely on energy supply from the system [11], [12]. This also increases the maintenance and replacement cost. If such cost is not being considered during the design, the PV-battery system economic profitability can be significantly misjudged, leading to a poor investment. Thus, to avoid such deteriorating scenarios, it is necessary to account for the two aforementioned aspects and their interaction during the design.

However, the impact of lifetime and reliability of the key component such as power converter and battery on the economic profitability have not been considered in the previous research. In fact, the reliability evaluation of the two components are usually treated independently. For example, from the economic profitability point of view, the majority of the research is focused on the impact of different incentive schemes [13] and battery sizing methodologies [14], [15], [16]. By implementing smart control strategies [17], [18] and optimization algorithms, considering the existing incentives, the economic profitability of the PV-battery system can be improved.

From a lifetime and reliability point of view, most of the research is focused on investigating the impact of the components lifetime (e.g., power converters and batteries) on the overall system reliability [19]. For example, PV panel size influence on the system reliability was investigated in [20], while the impact of battery operation on the power converter reliability was investigated in [21]. The knowledge gained from the aforementioned studies is then used to develop strategies for increasing system lifetime and reliability.

Accordingly, the impact of power converters and battery lifetime on the economic profitability of the system is investigated in this paper. Lifetime of the reliability-critical components is determined for a mission profiles representing the expected operating conditions at the installation site. The results obtained from the lifetime evaluation are then translated into the replacement cost and included in the economic model. By doing so, the influence of the component reliability is reflected in the economic evaluation, providing a more realistic scenario in the design and optimization of the

PV-battery system. This paper is an extension of the previous investigation presented in [22], where influence of key components lifetime on economic profitability was investigated. The analysis in this paper is extended to the investigation of different installation site conditions influence on the replacement cost occurrence. In fact, it provides a more comprehensive analysis of the impacts of the components lifetime on the economic profitability. The outcome of such analysis can be used in cost-effective, reliability-oriented design of the residential PV-battery systems covering wide range of installation site conditions.

With respect to that, the rest of this paper is organized as follows. In Section II, PV-battery system configuration and its energy management strategy are presented. In Section III, the lifetime modelling of the reliability-critical components is outlined. The economic profitability assessment of PV-battery systems is presented in Section IV. The impact study of the replacement cost of the reliability-critical components on the economic profitability is carried in Section V. This is followed by the impact study of mission profile variations covering variety of the installation sites conditions on the lifetime and profitability of the system in Section VI. Finally, concluding remarks are given in Section VII.

## II. SYSTEM PERFORMANCE MODEL

In order to investigate the impact of the components lifetime and reliability on the economic profitability of the system, the suitable models and their interactions are required, as shown in Fig. 1. The input parameters are solar irradiance  $S$ , ambient temperature  $T_a$ , and household load profile  $P_{load}$ . They need to be mapped to the evaluation parameter for the economic profitability such as net present value  $NPV$ . Firstly, the system performance model is required for determining the PV power generation and energy distribution in the system. Furthermore, the stress profiles of the components during the operation are also obtained from the system performance model (which includes the power converter electro-thermal model and battery dynamic model). Those stress parameters are later on used in the lifetime model to evaluate the time-to-failure of the components and thereby the replacement cost in the economic model. Finally, the energy generation and distribution in the system is used to evaluate the economic profitability where replacement cost is included.

The proposed framework includes the PV-battery system specifications and conditions commonly seen in practice. However, the framework can also be applied for a range of different PV-battery system specifications and conditions. Hence, for each model, the necessary information and implementation options are also discussed. Furthermore, the proposed model can be used during the PV-battery design procedure, as shown in Fig. 2. It can serve to obtain the optimal sizing of PV, battery, and power converter considering performance, lifetime and economic aspects. In the following, a more detailed explanation of the performance model is provided.

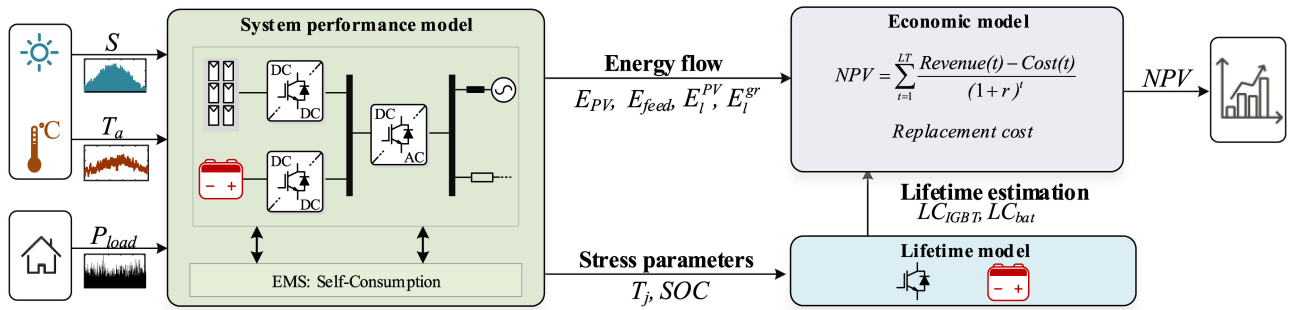

**FIG. 1.** PV-battery system model for the evaluation of the economic profitability influenced by the lifetime of the reliability-critical components. Model input are solar irradiance  $S$ , ambient temperature  $T_a$ , and load demand  $P_{load}$ . Model output is net present value  $NPV$ .  $SOC$  and  $LC_{bat}$  are battery state-of-charge and lifetime consumption, respectively;  $T_j$  and  $LC_{IGBT}$  are switch junction temperature and lifetime consumption, respectively.

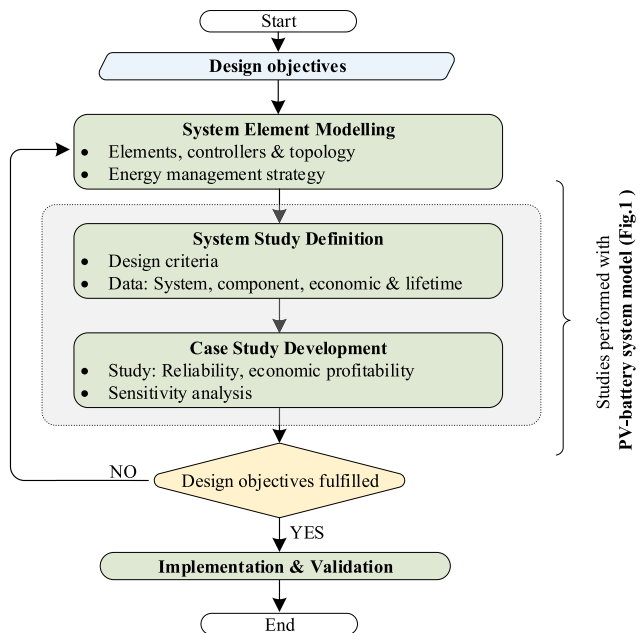
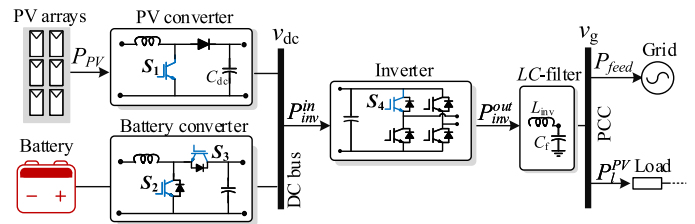

**FIG. 2.** PV-battery system design procedure. Gray area indicates the steps in the design procedure where the developed PV-battery model consisting of the performance, lifetime and economic aspects can be used for optimal PV-battery design.

## A. ENERGY FLOW MODELLING

The main aim of the system performance model is to obtain the generation and loading profiles of the units in the system. Thus, the information about the system topology and energy management strategy are required. They enable definition of the energy equations which provide required information on energy flow and the interaction of the system with the grid.

In this case, a single-phase, grid-connected, DC-coupled PV-battery topology shown in Fig. 3 is used. Furthermore, a self-consumption control strategy, which prioritizes the load supply from the PV system over grid electricity, is implemented. This energy management strategy is reported to be most suitable strategy for maximizing the economic benefits of the end users [23], [24]. Such is aligned with the report



**FIG. 3.** Diagram of the grid-connected, single-phase PV-battery system under study, where  $P_{PV}$  is PV arrays power output,  $P_{inv}^{in}$  and  $P_{inv}^{out}$  are input and output power of the inverter,  $P_{feed}$  is excess power from the system fed to the grid, and  $E_l^{PV}$  is the proportion of the load energy demand that are covered by PV.

in [25] where end customer monitor data shown significant increase in the share of self-consumption for solar electricity in recent decades. Moreover, it is expected that it will prevail in the future, where escalated grid electricity prices are expected.

With the self-consumption control strategy, the power produced by PV is either supplied to the load or absorbed by the battery system. In that way, the grid electricity is delivered to the load only when the PV power generation and battery are not available, maximizing the self-consumed PV energy production [26]. This operation principle is summarized in (1)-(5) and energy flow are given in Figs. 3 and 4. The input power of the PV inverter,  $P_{inv}^{in}$ , is calculated by the following:

$$P_{inv}^{in} = P_{PV} - P_{bat} \quad (1)$$

where  $P_{PV}$  is the output power of the PV arrays including the power loss in the PV converter, and  $P_{bat}$  is the battery set-point including the power loss in the battery converter. The inverter output power  $P_{inv}^{out}$  is calculated by subtracting the inverter power losses,  $P_{loss}$ , from the inverter input power  $P_{inv}^{in}$ . Considering that this power is delivered to the load and fed to the grid, it can be expressed as:

$$P_{inv}^{out} = P_{in} - P_{loss} = P_l^{PV} + P_{feed} \quad (2)$$

where  $P_l^{PV}$  is the load demand that is covered by the PV power and  $P_{feed}$  is the excess power that is fed to the grid and defined

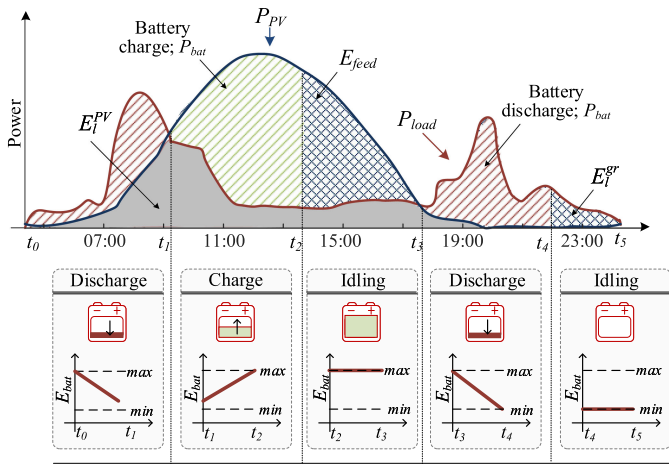

**FIG. 4.** Typical one day PV power generation  $P_{PV}$  and load demand  $P_{load}$  curves. Energy distribution and battery operation  $P_{bat}$  are defined based on the self-consumption energy management strategy.  $E_{feed}$  is excess energy from the system fed to the grid, and  $E_l^{PV}$  and  $E_l^{gr}$  are the proportions of the energy demand by the household load that are covered by PV and grid, respectively.

as:

$$P_{feed} = \begin{cases} P_{inv}^{out} - P_{load} & , P_{inv}^{out} > P_{load} \\ 0 & , \text{otherwise} \end{cases} \quad (3)$$

If power produced by the PV-battery system,  $P_l^{PV}$ , is not sufficient to cover the load demand,  $P_{load}$ , the load demand is supplied from the grid,  $P_l^{gr}$ . Considering that,  $P_{load}$  is written as:

$$P_{load} = P_l^{PV} + P_l^{gr} \quad (4)$$

where  $P_l^{gr}$  is defined as follows:

$$P_l^{gr} = \begin{cases} P_{load} - P_{inv}^{out} & , P_{load} > P_{inv}^{out} \\ 0 & , \text{otherwise} \end{cases} \quad (5)$$

The output parameters of the performance system:  $E_{PV}$ ,  $E_{feed}$ ,  $E_l^{PV}$  and  $E_l^{gr}$  are then obtained by integration of the associated power variables defined in (1)-(5) over time. For energy management strategy differing from self-consumption, the energy flow defined in (1)-(5) needs to adjusted to fit the requirements and specifications of chosen energy management strategy.

### B. STRESS PARAMETERS EVALUATION

The loading conditions of the power converters and the battery unit during operation directly influence their lifetime. Therefore, it is necessary to evaluate the loss of lifetime for input mission profile. To do so, the stress of the units equivalent to the electrical loading needs to be determined.

In case of power converters, junction temperature  $T_j$  of the Insulated-Gate Bipolar Transistor (IGBT) is the relevant stress parameter [27]. To determine  $T_j$  for certain operating conditions, the electro-thermal model needs to be developed. The IGBT losses  $P_{loss}$  are determined first by the power loss

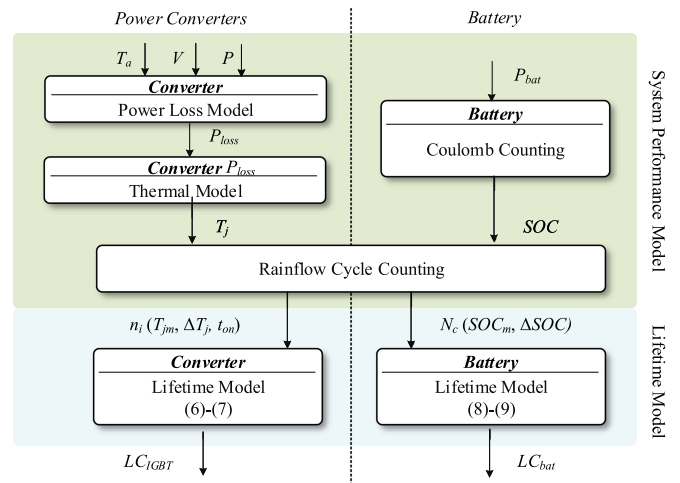

**FIG. 5.** Lifetime consumption estimation procedure for power converters  $LC_{IGBT}$  and battery  $LC_{bat}$ , where the input operating conditions (power  $P$ , voltage  $V$ , ambient temperature  $T_a$ ) are obtained in the system performance model.

model that considers the electrical characteristics of IGBT i.e., switching and conduction behavior. In the next step, a thermal model (e.g., Foster mode, Cauer model) is developed based on the IGBT thermal impedance information. By means of this model,  $T_j$  can be determined for a range of input operating conditions (power, voltage, temperature) reflected in  $P_{loss}$ . A relevant stress parameter of the battery unit is state-of-charge,  $SOC$ . This parameter is influenced by the input power that needs to be supplied or delivered to the battery  $P_{bat}$ . The  $SOC$  is then defined as the ratio of the available capacity at certain time instant and nominal capacity. The battery operation is divided into cycling and idling. During cycling, the  $SOC$  profile is characterized by the cycles with different duration and depth depending on the frequency of use. During idling, battery is not being used and its  $SOC$  is constant. In both cases, the battery is experiencing performance degradation. To account for loss of life with respect to two conditions, the  $SOC$  profile is first determined by means of a Coulomb counting which determines the available capacity of the battery.

The obtained dynamic stress profiles, i.e.,  $T_j$  and  $SOC$ , are further decompose to the set of simple stress reversals by means of Rainflow cycle counting algorithm. Such is done to obtain information about the occurrence of different stress levels in the dynamic stress profiles. These information are used to estimate the loss of life for each stress level experienced during the operation. The overview of the whole process, as well as its connection the lifetime model, is shown in Fig. 5.

### III. LIFETIME MODEL

To investigate time-to-failure of the reliability-critical components, the relevant lifetime models need to be considered. They are needed to evaluate the impact of stress profiles obtained in the performance model on the lifetime of the power converters and battery unit. In this case, only the dominant

**TABLE 1** Parameters of IGBT Lifetime Model [28]

Factor	Value	Description	Constant	Value
			$\beta_1$	-4.416
$I$	10 A	Bond wire current	$\beta_2$	1285
$V$	0.6 kV	Blocking voltage	$\beta_3$	-0.463
$D$	300 $\mu\text{m}$	Bond wire diameter	$\beta_4$	-0.716
$K$	$2.03 \times 10^{14}$	Technology factor	$\beta_5$	-0.761
			$\beta_6$	-0.5

failure mechanisms of the main reliability-critical components are considered. To investigate influence of secondary failure mechanisms or other components of the system, relevant lifetime models need to be added to the existing one. Moreover, the necessary stress parameters of the additional lifetime models need to be obtained during the stress parameter evaluation within the performance model.

### A. POWER CONVERTERS

In the power converter unit, IGBTs and capacitors are the components prone to the failure the most [27], [29]. In this paper, the focus is put on the lifetime investigation of IGBTs. Majority of the IGBT failures are related to the high thermal stress conditions (e.g., thermal cycling and mean junction temperature). To assess the damage during operation, the temperature-related lifetime model, representing the bond-wire lift off and solder fatigue failure mode, is used [30], where the number of cycles to failure,  $N_f$ , is expressed as:

$$N_f = K \cdot (\Delta T_j)^{\beta_1} \cdot e^{\frac{\beta_2}{T_{jm}+273}} \cdot (t_{on})^{\beta_3} \cdot I^{\beta_4} \cdot V^{\beta_5} \cdot D^{\beta_6} \quad (6)$$

where  $T_{jm}$  is the mean junction temperature,  $\Delta T_j$  the cycle amplitude, and  $t_{on}$  is the cycle period. The rest of the model parameters are provided in Table 1. The Miner's rule is used to evaluate the component lifetime consumption,  $LC_{IGBT}$ , as:

$$LC_{IGBT} = \sum_i \frac{n_i}{N_{fi}} \quad (7)$$

where  $n_i$  is the number of cycles for a certain set of operating conditions ( $T_{jm}$ ,  $\Delta T_j$ , and  $t_{on}$ ) extracted from the stress profiles in the performance model (see Fig. 5).  $LC_{IGBT}$  provides information regarding the amount of IGBT life that has been consumed. Thus, it starts from 0 at the beginning-of-life and it accumulates to 1 when the IGBT reaches its end-of-life. The power converter replacement is then taking place when the  $LC_{IGBT} = 1$ . For the system under study, there are 4 IGBTs in total (see Fig. 3), for which stress levels are evaluated during the operation. IGBT  $S_1$  is a part of the PV converter and once its  $LC_{IGBT}$  accumulates to 1, the PV converter needs to be replaced. IGBTs  $S_2$  and  $S_3$  are part of the battery converter. Once either one of the two  $LC_{IGBT}$  reaches 1, the battery converter needs to be replaced. Similar consideration is also applied for inverter when IGBT  $S_4$  is being evaluated.

**TABLE 2** Parameters of Battery Lifetime Model [31]

Parameter	Value	Description
$b_{cyc}$	1	Cycle aging parameter
$a_{idl}$	$6.6269 \times 10^{-4}$	Idle aging parameter
$a_w$	151245.25	Wöhler parameter
$b_w$	-0.968423	Wöhler parameter

### B. BATTERY

During battery operation, its lifetime is being consumed by the reduction of its available capacity. The lifetime model of lithium iron phosphate (LFP) battery calculates capacity fade based on of the state-of-charge (SOC) stress factor (evaluated in the performance model) following [31]:

$$C_f = a_{cyc} \cdot N_c (\Delta SOC)^{b_{cyc}} + a_{idl} \cdot k_T \cdot k_V \cdot t_l \quad (8)$$

where the first summation term accounts for the capacity fade under the cycling stress condition and the second is related to the capacity fade under the idling stress conditions. The coefficient  $a_{cyc}$  is the function of the mean SOC,  $SOC_m$ , and the cycle amplitude,  $\Delta SOC$ , which are extracted from the stress profile in the performance model (see Fig. 5).  $N_c(\Delta SOC)$  represents the equivalent full cycles determined based on the Wöhler function.  $k_T$  and  $k_V$  are Arrhenius and Tafel expressions, respectively and  $t_l$  is time during which the battery is idling. The rest of the parameters are provided in Table 2.

Battery lifetime consumption,  $LC_{bat}$ , is evaluated by using the following expression:

$$LC_{bat} = \sum_i C_{fi} \quad (9)$$

where  $C_{fi}$  is the capacity fade for the certain operating conditions reflected in the SOC stress profile. Once  $LC_{bat}$  accumulates to 1, the battery is reached to its end-of-life. This corresponds to 20% capacity fade, after which the battery packs need to be replaced [31].

### IV. ECONOMIC MODEL

In order to analyze the economic profitability, two main parameters of the economic model - cost and revenue need to be determined for the PV-battery system. Furthermore, the evaluation metric for assessing the economic profitability under certain cost and revenue is required. Finally, the impact of the lifetime on the economic profitability needs to be included through the component replacement cost.

#### A. COST

Cost in the system can in general be divided as:

##### 1) CAPITAL AND OPERATION AND MAINTENANCE COST

Capital cost represents the initial investment at the beginning of the project. It includes the cost of the components such as PV arrays, battery units, power electronic converters, and the balance of the system, as well as their installation [32]. The operation and maintenance (O&M) cost accounts for performance monitoring and site management that is presented

during the entire project lifetime, and it is usually accounted on a yearly basis [33].

## 2) REPLACEMENT COST

This cost accounts for the cost due to the replacement of the components. As elaborated in Section III, once battery or a power converter unit reaches its end-of-life, the investment in the new component needs to be made. In this work, it is assumed that the converter replacement cost,  $C_{rep}^{conv}$ , is constant over years of the project lifetime,  $LT$ . Contrary, the battery replacement cost,  $C_{rep}^{bat}$ , is decreasing with time. This is mainly due to expectations of battery packs price decrease in the future, e.g., up to 60% by 2030 [34].

## B. REVENUE

The revenue from the PV-battery system with self-consumption consists of two parts:

### 1) SAVINGS BY PV-BATTERY ELECTRICITY GENERATION

As elaborated in Section II, it is more profitable to supply the load demand with power generated from PV array instead of purchasing electricity from the grid. This is mainly due to a higher cost of grid electricity compared the one generated by the PV system. Thus, utilizing the power generated from the PV-battery system for supplying the load demand can generate the system revenue. In that case, the revenue can be defined as a difference between the ideal cost in the conventional system and the real cost from the PV-battery system. Hence, it is a difference between the cost of electricity that the consumer would have to pay if the load is only supplied from the grid and the cost of electricity partly delivered from the grid and partly from the PV-battery system as:

$$R_{sav} = E_{load} \cdot C_{gr} - (E_l^{PV} \cdot LCOE + E_l^{gr} \cdot C_{gr}) \quad (10)$$

where  $E_{load}$  is the overall energy required to supply the load,  $E_l^{PV}$  is the proportion of the overall load demand that is supplied from the PV-battery system and  $E_l^{gr}$  is the proportion of the overall load demand that is supplied from the grid. The proportion of the energy supplied by each source is determined by the energy management strategy, i.e., self-consumption. Furthermore,  $C_{gr}$  is the cost of the grid electricity [35]. It is expected that in 20 years, the projected cost will be 1.5 times the reference one, which is included in the model and linearly approximated as:

$$C_{gr}(t) = C_{gr}^{ref} \cdot \left( \frac{t}{t_{pred}} + 1 \right) \quad (11)$$

where  $C_{gr}$  is the current electricity price,  $C_{gr}^{ref}$  is the reference electricity price during the first year of PV-battery operation and  $t_{pred}$  is the time interval in the future for which the prediction is being made. In (10), the cost of electricity delivered from the PV-battery system is represented through the leveled cost of energy (LCOE), which is defined as:

$$LCOE = \frac{C_{sys}}{E_{sys}} \quad (12)$$

where  $C_{sys}$  and  $E_{sys}$  represent the overall cost of the system and total energy delivered from the system over project lifetime  $LT$ , respectively:

$$C_{sys} = \sum_{t=1}^{LT} \frac{C_{cpt}^{PV} + C_{cpt}^{bat} + C_{o\&m}^{PV} + C_{o\&m}^{bat}}{(1+r)^t} \quad (13)$$

$$E_{sys} = \sum_{t=1}^{LT} \frac{E_{PV}(t)}{(1+r)^t} \quad (14)$$

where investment expenditures of the PV and battery are denoted with  $C_{cpt}^{PV}$  and  $C_{cpt}^{bat}$ , respectively and the operation and maintenance expenditures are denoted with  $C_{o\&m}^{PV}$  and  $C_{o\&m}^{bat}$  of the PV and battery over time  $t$ .  $r$  is the project discount rate,  $LT$  is PV-battery project operational lifetime, and  $E_{PV}$  is the total energy delivered by the system over time.

### 2) GRID FEED-IN

In certain cases (e.g. days with high solar irradiation), there could be a surplus power generated by the PV that exceeds the load demand and battery capacity. In such case, the excess power will be fed to the grid, resulting in additional revenue through the feed-in tariff:

$$R_{feed} = E_{feed} \cdot C_{feed} \quad (15)$$

where  $E_{feed}$  is the excess energy fed to the grid,  $C_{feed}$  is the feed-in tariff (i.e., the price of selling the electricity to the grid). In some countries such as Germany, different tariff rates may be applied after a certain years of operation (e.g., 20 years), which should also be taken into account [35].

## C. PROFITABILITY EVALUATION METRIC

In order to analyze the project profitability, an adequate evaluation metrics need to be chosen. It needs to include the aforementioned revenue and cost considerations in order to account for performance and lifetime aspect of the system. In this case, an evaluation metric in terms of  $NPV$  is used. It measures the amount of the profit the project generates over its operation time  $LT$ , which is defined as follows [36]:

$$NPV = \sum_{t=1}^{LT} \frac{R_{tot}(t) - C_{tot}(t)}{(1+r)^t} \quad (16)$$

where the time value of the cash flow is accounted by means of the discount rate  $r$ , and the total revenue  $R_{tot}$  and the total cost  $C_{tot}$  are defined as:

$$R_{tot} = R_{sav} + R_{feed} \quad (17)$$

$$C_{tot} = C_{cpt}^{PV} + C_{cpt}^{bat} + C_{o\&m}^{PV} + C_{o\&m}^{bat} + C_{rep}^{conv} + C_{rep}^{bat} \quad (18)$$

The impact of  $R_{tot}$  and  $C_{tot}$  on the profitability curve is illustrated in Fig. 6.

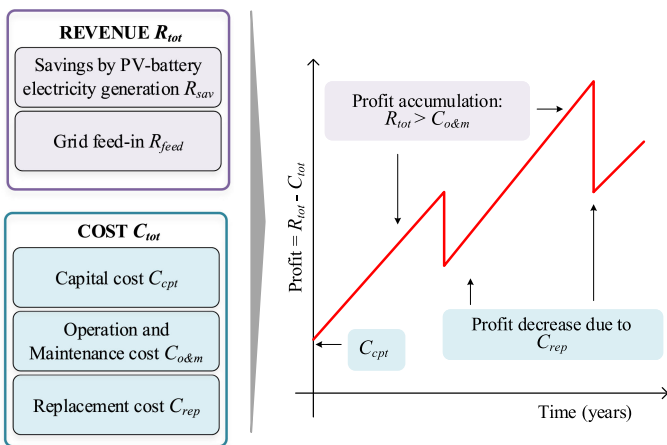

**FIG. 6.** Diagram illustrating influence of different cost and revenue components on the profitability curve of the system.  $R_{tot}$  is the total revenue of the system consisting of  $R_{sav}$  and  $R_{feed}$  being revenues due to savings by PV-battery electricity generation and grid feed-in, respectively.  $C_{tot}$  is total cost of the system that includes capital cost  $C_{cpt}$ , operation and maintenance cost  $C_{o\&m}$  and replacement cost  $C_{rep}$ .

**TABLE 3** Case Study: Relevant PV-Battery Configuration Parameters Used in System Performance Model

PV converter rated power	6 kW (3 kW x 2 units)
Battery converter rated power	3 kW
PV inverter rated power	6 kW
DC-link capacitor	$C_{dc} = 1100 \mu F$
LC-filter	$L_{inv} = 4.8 \text{ mH}$ , $C_f = 4.3 \mu F$
Switching frequency	DC/DC converters: $f_{sw} = 20 \text{ kHz}$ Full-Bridge inverter: $f_{inv} = 10 \text{ kHz}$
DC-link voltage	$v_{dc}^* = 450 \text{ V}$
Grid nominal voltage (RMS)	$V_g = 230 \text{ V}$
Grid nominal frequency	$\omega_0 = 2\pi \times 50 \text{ rad/s}$

**V. IMPACT OF THE KEY COMPONENTS LIFETIME ON PROFITABILITY**

In this section, the application of the developed model for the sizing of the PV-battery system is demonstrated. Furthermore, a mission profile in Germany is used to investigate the impact of reliability-critical components lifetime on the economic profitability.

**A. CASE STUDY DEFINITION**

The economic analysis is performed for a case study of the PV-battery installed in Germany with the system diagram shown in Fig. 3. The main system parameters are provided in Table 3, and they are based on the data in [21]. Furthermore, a complete list of all necessary parameters for the economic model is provided in Table 4, and it is based on the data reports in [9], [35]. The feed-in tariff of 0.14 USD/kWh is considered for the first 20 years, after which, it is decreased to 0.05 USD/kWh. Additionally, a regulation stating that only 70% of the total energy generation can be fed to the grid is here adopted. A one-year mission profile of solar irradiance  $S$  and ambient temperature  $T_a$  is shown in Fig. 7. Load profile used in this analysis represents a four-member household with the

**TABLE 4** Case Study: Relevant Economic Parameters Used in Economic Model

Parameter	Value	Description
$C_{cpt}^{PV}$	1550 USD/kW	PV investment cost
$C_{cpt}^{bat}$	400 USD/kWh	Battery investment cost
$C_{o\&m}^{PV}$	14.15 USD/kW	PV O&M cost
$C_{o\&m}^{bat}$	7 USD/kWh	Battery O&M cost
$C_{rep}^{conv}$	18% of $C_{cpt}^{PV}$	Converter replacement cost
$C_{rep}^{bat}$	20% of $C_{cpt}^{bat}$	Battery replacement cost
$C_{gr}^{ref}$	0.32 USD/kWh	Grid electricity reference cost
$t_{pred}$	25 years	Price prediction time interval
$C_{feed}$	0.14 USD/kWh	Feed-in tariff
$r$	3%	Discount rate
$LT$	25 years	PV-battery project lifetime

yearly energy consumption of 4650 kWh. This yearly mission profile is repetitively used until  $LT$  is reached.

To investigate the impact of lifetime on the economic profitability, different PV arrays and battery sizes are considered. A sizing matrix with PV array power rating ranging from 3.5 kW to 8.5 kW and the battery capacity ratings between 3.5 kWh and 8.5 kWh is created.

**B. LIFETIME OF RELIABILITY-CRITICAL COMPONENTS**

Lifetime analysis results for the reliability-critical components are shown in Fig. 8. As a part of each lifetime diagram, a plane fulfilling lifetime  $LT = 25$  requirement is shown to indicate the project lifetime. For the sizing combination with the component lifetime higher than 25 (being above the plane in the diagram), no replacement of the components (e.g., power converters and batteries) are required within the operational time. In fact, the PV converter lifetime is higher than 25 years for all combinations of the sizing matrix. Hence, no PV power converter replacement is needed and, therefore, it is not shown in Fig. 8. The main influence on the battery lifetime has the PV panel size. In general, the higher the PV size, the lower the battery lifetime is achieved. This is because the battery needs to absorb a larger amount of excess PV power, resulting in the additional stress during the daily operation. On the other hand, the battery converter lifetime is not significantly sensitive to the PV and battery size. However, due to the high dynamics in power flow associated with the battery unit, the battery converter is highly stressed during the operation. This results in the lifetime lower than the project lifetime  $LT$  for all considered sizes and the battery converter needs to be replaced at least once during the operation. Similarly, the inverter lifetime is also strongly influenced by the PV panel size. In case of a high PV power size, the inverter is highly loaded during the operation. Additionally, the battery size influences the inverter lifetime as well, but less significant than the PV size. The larger the battery size, the higher the inverter lifetime is achieved due to the reduced loading, e.g.,



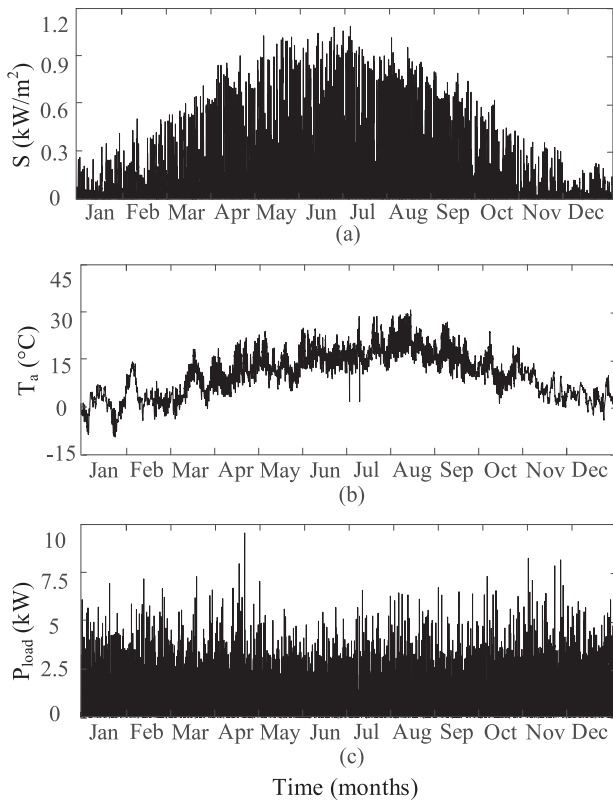

**FIG. 7.** A one-year mission profile of the PV-battery system installation site in Germany: (a) solar irradiance  $S$ , (b) ambient temperature  $T_a$ , and (c) load demand  $P_{load}$ .

during charging period. In the following, the influence of the lifetime results on the economic profitability of the PV-battery sizes is investigated.

### C. LIFETIME EFFECT ON ECONOMIC PROFITABILITY

Simulation results are shown in Fig. 9, where the assessment of the economic profitability is carried out for two cases: 1) with considering the replacement cost and 2) without considering the replacement cost. Higher  $NPV$  is achieved for the cases with the smaller PV and battery sizes, while the  $NPV$  decreases as the PV or battery size increase. This trend is applied for both cases - with and without considering the replacement cost. The lifetime influence on the economic profitability has the highest impact in the case of larger sizes. This trend is aligned with the lifetime results presented in Fig. 8, where the lowest lifetime of all three examined components is obtained for the largest examined PV size. The lowest  $NPV$  value for the case when the replacement cost is not considered is obtained for the PV panel size of 8.5 kW and the battery size of 3 kW/8.5 kWh. For the same size combination, lifetime analysis results indicate that the battery converter, the inverter, and the battery unit each need to be replaced at least once during operation. By taking the cost of their replacement into consideration, the actual  $NPV$  value is only 60% of the one obtained in the previous calculation when the replacement

cost is neglected. The same trend is also applied for other sizing combinations as well, where even for the best case, the  $NPV$  is still around 10%. Hence, it can be concluded that lifetime impact of the reliability-critical components plays a significant role in the economic profitability of the PV-battery systems. Furthermore, neglecting this aspect in the economic study can result in misleading profitability conclusions and discrepancies in the real-field implementation.

### D. DISCOUNT RATE IMPACT ON ECONOMIC PROFITABILITY

The value of the discount rate  $r$  defined in (16) has direct impact on the  $NPV$  of the system. Therefore, its influence on the optimal sizing of PV-battery system with considered lifetime of the reliability-critical components is investigated. The procedure for  $NPV$  determination is repeated for different values of discount rate  $r$ , i.e.  $r = \{1\%, 3\%, 5\%, 10\%\}$ . The  $NPV$  results for a combination of the PV and battery sizes under different  $r$  are shown in Fig. 10. They indicate that the change in the discount rate  $r$  has significant impact on the  $NPV$  value. However, it does not impact the shape of the curve, as in case of replacement cost. This refers that the discount rate  $r$  does not impact the optimal PV-battery sizing, but has influence on the profitability of the system regardless the chosen PV and battery size. Therefore, it is necessary to include a representative discount rate with respect to the economic indicators present during the PV-battery design, where the results in Fig. 10 can serve as reference.

## VI. IMPACT OF MISSION PROFILE VARIATION ON LIFETIME AND PROFITABILITY

The previous analysis for installation site in Germany shows that the lifetime of key components strongly affects the profitability of the system. The analysis of system shown in Fig. 1 identified mission profile as a parameter which can impact the results of the analysis. To investigate if the same conclusions can also be applied to other installation sites with different environmental conditions, mission profiles from Colorado and Spain are considered in this section. The results of this analysis can demonstrate the flexibility of the proposed method under different mission profiles.

### A. MISSION PROFILES CHARACTERIZATION

The mission profiles of the installation sites in Colorado and Spain are given in Fig. 11. The intensity and the variations in environmental conditions strongly impact the loading of the key components. To investigate those values, a probability density plot of solar irradiance  $S$  and ambient temperature  $T_a$  for different mission profiles are shown in Fig. 12. In case of solar irradiance  $S$ , the installation site in Germany has significantly lower yearly average than the sites in Colorado and Spain. In case of ambient temperature  $T_a$ , the installation site in Colorado has a higher average yearly value than Germany and Spain, as well as the largest variations in the temperature. To investigate the impact of mission profile on lifetime of key components and economic profitability, the rest of the

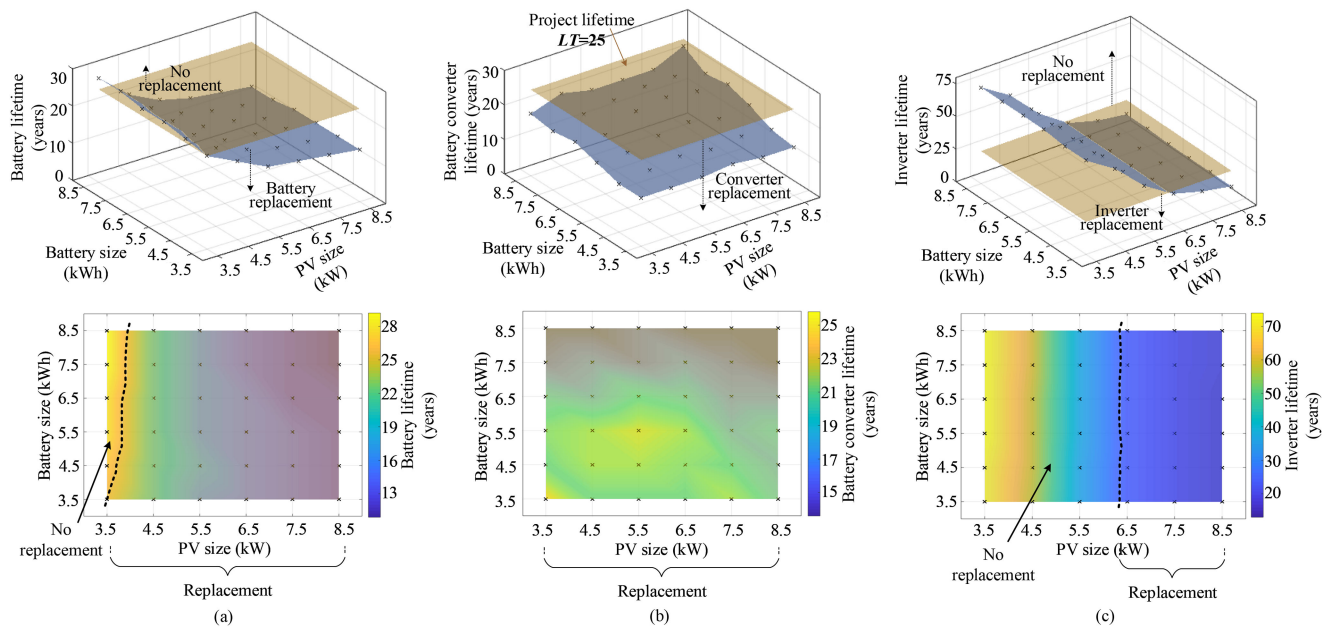

**FIG. 8.** 2D and 3D representation of the reliability-critical components lifetime, where the planes (marked in brown) at 25 years representing the project lifetime  $LT$  are set as a reference: (a) battery unit, (b) battery converter, and (c) inverter.

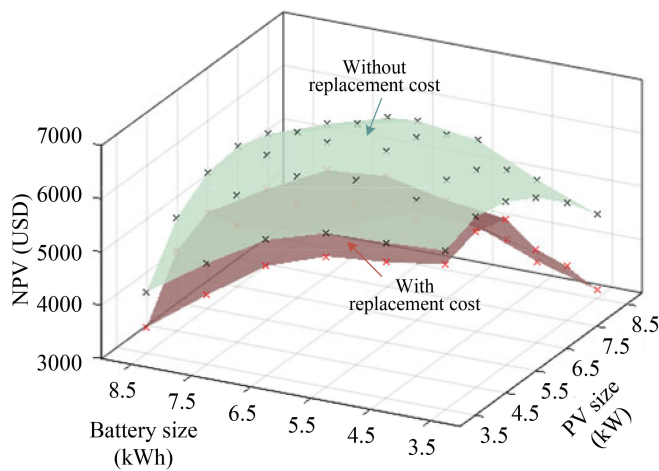
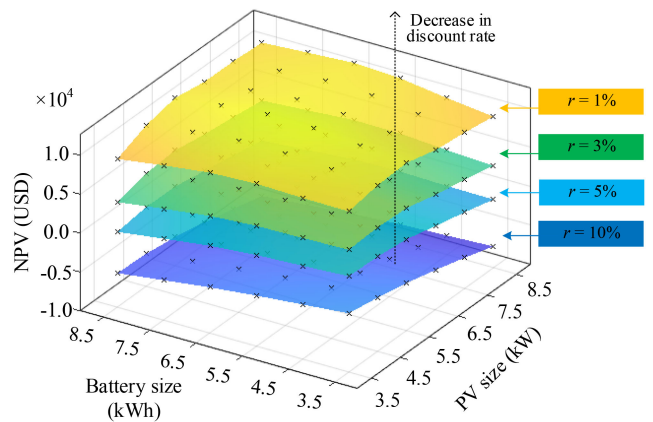

**FIG. 9.** Case study results: Net Present Value  $NPV$  for the combination of the PV power and battery energy capacity sizes. Red marks denote case in which lifetime influence on the economic profitability is taken into account through the replacement cost. Black marks denote case in which the replacement cost is not considered in the economic evaluation.

case study conditions remain unchanged from ones defined in Section V.

**B. LIFETIME OF RELIABILITY-CRITICAL COMPONENTS UNDER MISSION PROFILE VARIATIONS**

The lifetime of the reliability-critical components under mission profile variations is illustrated for two distinctive cases. In Case 1, nominal PV array size is 5.5 kW and nominal battery energy capacity is 5.5 kWh. This corresponds to the sizing combination, which yields the maximum  $NPV$  for mission

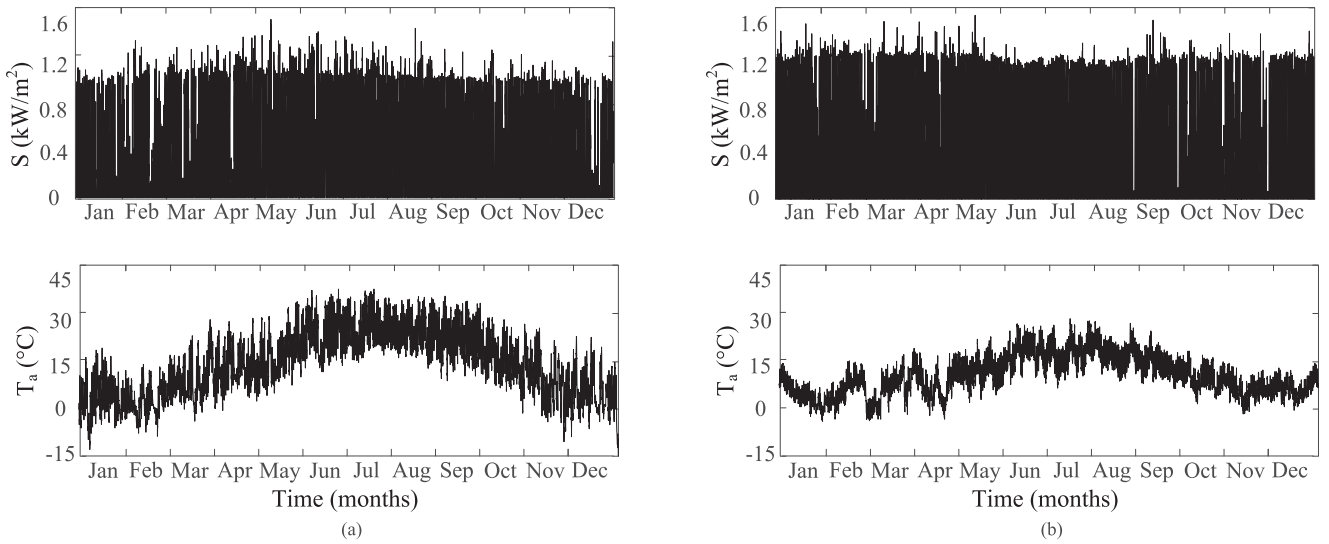

**FIG. 10.** Case study results: Net Present Value  $NPV$  for the combination of the PV power and battery energy capacity sizes under influence of different values of the discount rate  $r$ .

profile in Germany. Furthermore, in Case 2, the optimal PV array and battery energy capacity are 3.5 kW and 8.5 kWh respectively, which is the optimal sizing for maximization of  $NPV$  value for mission profiles in Colorado and Spain. The two optimal sizes are determined by following the same procedure as in case of mission profile in Germany described in Section V.

**1) CASE 1 RESULTS**

The lifetime results of the reliability-critical components for the two cases under the aforementioned mission profiles are shown in Fig. 13. In Case 1, the lifetime of the components is



**FIG. 11.** A one-year mission profile (solar irradiance  $S$  and ambient temperature  $T_a$ ) of the PV-battery system installation site in: (a) Colorado (b) Spain.

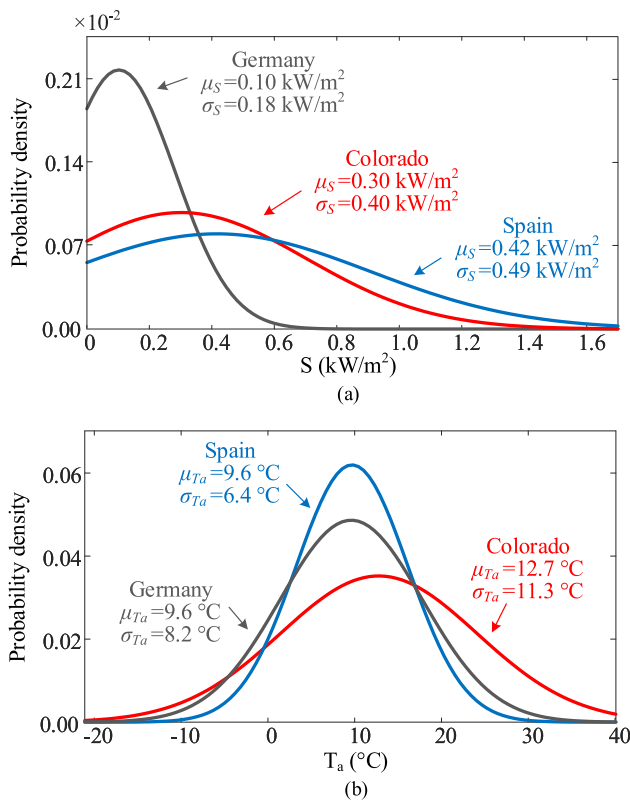

**FIG. 12.** A density plot representing the distribution of mission profile for the three considered installation sites (Germany, Colorado, Spain): (a) solar irradiance  $S$  and, (b) ambient temperature  $T_a$ .

the highest for mission profile in Germany. This corresponds to mission profile characteristics, where energy yield by the system is low due to the low solar irradiance year-round. For the same PV size, the PV power generation for mission

profiles in Colorado and Spain is higher, resulting in a higher stress of the system components.

The smallest difference in the lifetime for the three mission profiles is obtained for battery converter. The lowest lifetime is obtained for mission profile in Colorado, while its lifetime for mission profile in Germany and Spain is higher for three and six years respectively. However, the lifetime of the battery unit differs greatly for the three mission profiles. To investigate this further, one-day operational curves shown in Fig. 14 are used. Battery *SOC* profile for mission profile in Spain is characterized by the long idling periods at the *SOC* limits. During one-day operation in Fig. 14(b), the battery is fully charged and discharged (one deep cycle). In fact, a combination of a high PV power production and battery capacity limitations results with battery underutilization. This is reflected in reduced battery converter stress and its higher lifetime. On the contrary, such operation leads to the accelerated battery degradation due to idling, which results in a low lifetime of the battery unit. Furthermore, the inverter lifetime is the highest for mission profile in Germany. This is aligned with mission profile characteristics, which indicate that the PV power generation in Germany is significantly lower than the one in Colorado and Spain due to a lower solar irradiance year-round. The lowest lifetime is obtained for a mission profile with large variations in Colorado. This is also reflected in one-day inverter power curve (see Fig. 14(c)). The dynamic input power profile (due to frequent changes in environmental conditions) cause an additional stress to the inverter and results in the damage accumulation.

## 2) CASE 2 RESULTS

In Case 2, the lifetime of the reliability-critical components is higher than in Case 1 for all three mission profiles, as

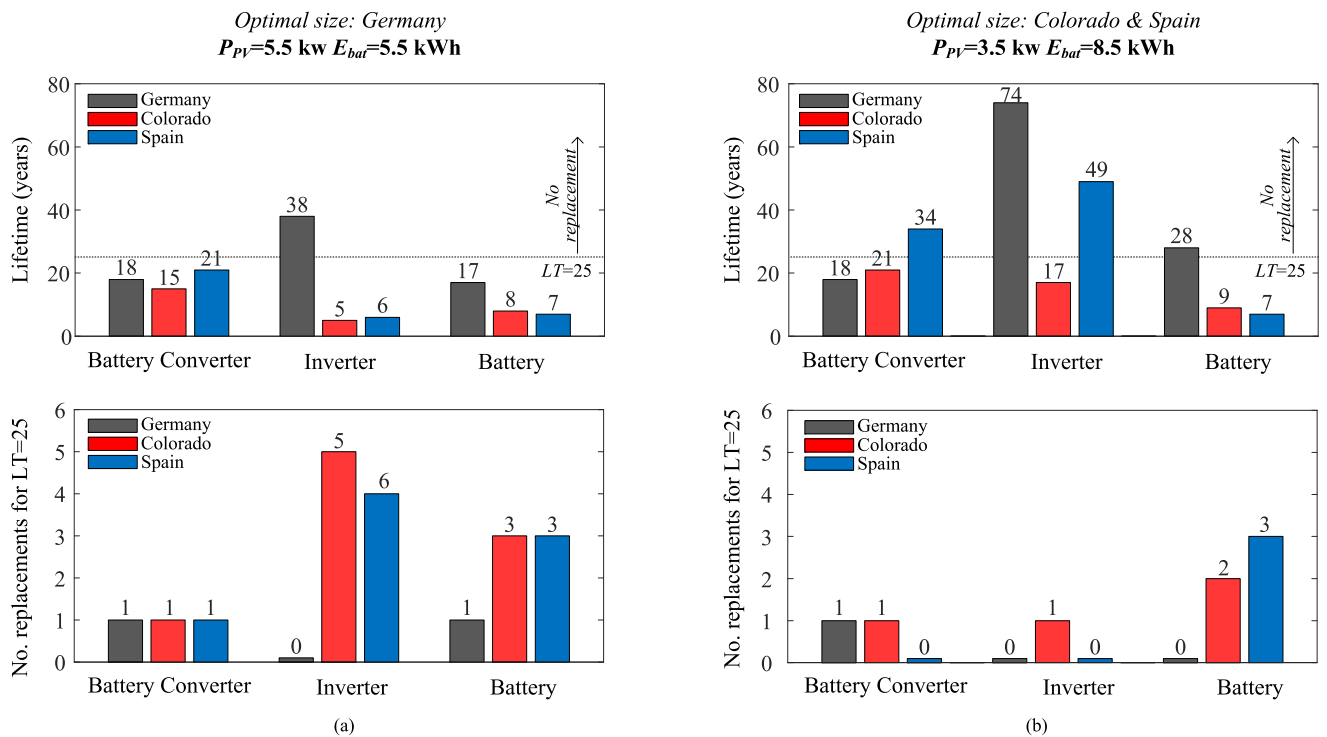

**FIG. 13.** Lifetime of reliability-critical components and number of replacement during the project lifetime  $LT$  of 25 years for: (a) Case 1, where PV and battery sizes are set to  $P_{pv}=5.5$  kW  $E_{bat}=5.5$  kWh representing the optimal size for mission profile in Germany and, (b) Case 2, where PV and battery sizes are set to  $P_{pv}=3.5$  kW  $E_{bat}=8.5$  kWh representing the optimal size for mission profiles in Colorado and Spain.

shown in Fig. 13(b). This corresponds to reduction in the PV array nominal power and increase in the battery energy capacity.

Inverter lifetime is affected the most by the changes in the PV and battery sizes. The most significant lifetime increase is obtained for mission profile in Germany. An example of one-day operation (in Fig. 14), shows that the reduction in PV power generation leads to the decrease in the inverter loading. However, a less substantial increase in the inverter lifetime is seen for Colorado mission profile. Similarly to Case 1, the large variations in environmental conditions impact the operating conditions of the inverter. This leads to the additional stress and a larger decrease in lifetime than in case of mission profiles in Germany and Spain. Accordingly, it can be concluded that the inverter design needs to take into account the mission profile characteristics and the size of the system components. In fact, non-optimal design can result with inverter that is under-utilized (Case 2 for mission profile in Germany) or over-utilized (Case 1 for mission profile in Colorado and Spain) during the operation. The battery lifetime changes insignificantly compared to Case 1 for mission profiles in Colorado and Spain. On the contrary, the lifetime of the battery converter increases compared to Case 1. PV power generation is lower due to reduced nominal power of the PV array system. In such case, there is less excess PV power generation (compared to Case 1), which impacts the loading of the battery converter.

### C. MISSION PROFILE EFFECT ON ECONOMIC PROFITABILITY

The number of replacements for the two cases due to ageing of reliability-critical components for these mission profiles is shown in Fig. 13. Furthermore, the associated economic profitability value  $NPV$  is provided in Table 5.

For the mission profile in Germany, a higher  $NPV$  is achieved in Case 1, where the units are replaced more frequently. Therefore, it is more profitable to replace units often, than invest in the more expensive, over-dimensioned units that will be under-utilized during the operation. However, as the number of replacement increases (as in case of Colorado and Spain), a more frequent replacement imposes the additional cost. This cost cannot be covered with the revenue generated during the project lifetime. As a result, a lower  $NPV$  is achieved, as shown on the example of Case 1 for the mission profile in Colorado and Spain.

In both cases, it is shown that the impact of the replacement cost is substantial. Therefore, the lifetime and reliability of key components plays an important role in PV-battery system profitability. Excluding this aspect during the system planning can result in substantial error in optimal design. Moreover, it can lead to non-optimal design solution and lower actual economic profitability during the system operation. Furthermore, the obtained results also suggest that the suitable design characteristics for one mission profile are not suitable for installation sites with different mission profile characteristics.

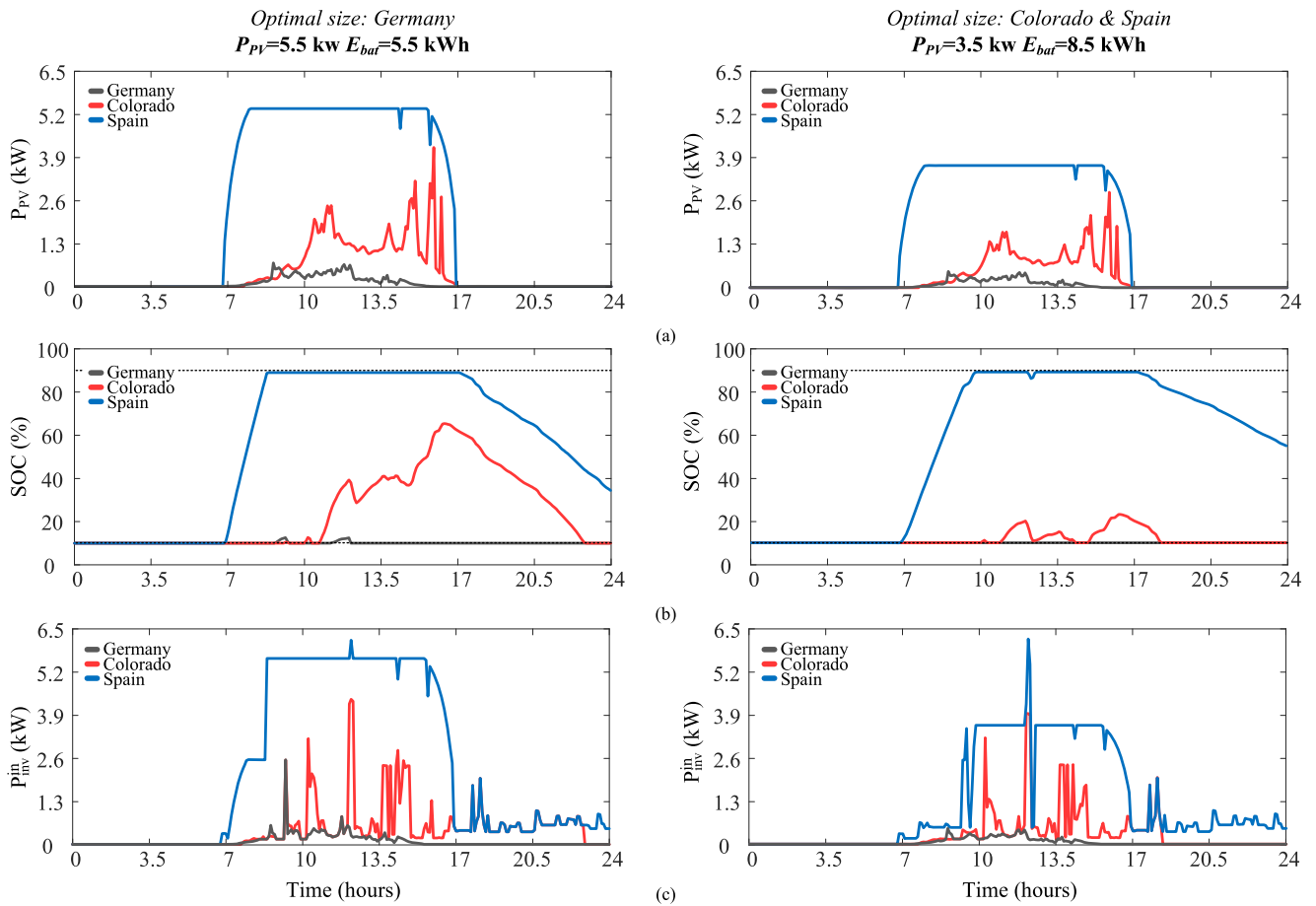

FIG. 14. Mission profile influence on reliability and economic profitability for two cases investigated: (a) PV power generation  $P_{PV}$ , (b) Battery state-of-charge SOC, (c) Inverter input power  $P_{in}^{inv}$ .

TABLE 5 Mission Profile Influence on Reliability and Economic Profitability: Summary of Case Study Results

	Case 1: Optimal size for Germany			Case 2: Optimal size for Colorado & Spain		
	$P_{PV}=5.5$ kW $E_{bat}=5.5$ kWh			$P_{PV}=3.5$ kW $E_{bat}=8.5$ kWh		
Mission Profile	Germany	Colorado	Spain	Germany	Colorado	Spain
Net Present Value $NPV$	6125 USD	17250 USD	19860 USD	5055 USD	20700 USD	23755 USD
No. replacements for $LT=25$	2 units	9 units	8 units	1 unit	4 units	4 units

Thus, it is necessary to include the lifetime and reliability aspect, as well as the mission profile characteristics in the residential PV-battery system planning in the future.

## VII. CONCLUSION

In this work, the impact of the battery and power converters lifetime on the economic profitability of the PV-battery system is investigated. An example of the residential PV-battery system in Germany shows that the lifetime of the reliability-critical components plays an important role in the profitability of the PV-battery projects. Furthermore, the impact of the mission profile variation on the lifetime and profitability results are investigated for mission profiles in Colorado and Spain.

It is concluded that neglecting the replacement cost due to the reliability and lifetime of the components can result in an unrealistic estimation of the economic profitability. Therefore, it is necessary to include both, the mission profile characteristics and lifetime-related impacts during the design of future, profitable PV-battery systems.

## REFERENCES

- [1] REN21, "Renewables 2021: Global Status Report(GRS)," 2021. [Online]. Available: <http://www.ren21.net>
- [2] E. Kabir, P. Kumar, S. Kumar, A. A. Adelodun, and K.-H. Kim, "Solar energy: Potential and future prospects," *Renew. Sust. Energ. Rev.*, vol. 82, pp. 894–900, 2018.

- [3] US Energy Information Administration, "European residential electricity prices increasing faster than prices in United States," 2018. [Online]. Available: <https://www.eia.gov>
- [4] Harry Wirth, ISE Fraunhofer, "Recent facts about photovoltaics in Germany," 2021. [Online]. Available: <https://www.ise.fraunhofer.de>
- [5] A. Rath, "100 000 homes in Germany now have battery storage systems connected to the grid," 2018. [Online]. Available: <https://qz.com>
- [6] S. Amelang, "Number of residential solar batteries increases by 50% in Germany," 2021. [Online]. Available: <https://www.cleanenergywire.org>
- [7] SolarPower Europe, "Global market outlook 2018–2022," 2018. [Online]. Available: <http://www.solarpowereurope.org>
- [8] V. Muenzel, I. Mareels, J. de Hoog, A. Vishwanath, S. Kalyanaram, and A. Gort, "PV generation and demand mismatch: Evaluating the potential of residential storage," in *Proc. Innov. Smart Grid Technol.*, Washington, DC, USA, 2015, pp. 1–5.
- [9] International Renewable Energy Agency, "Renewable power generation cost in 2018," 2019. [Online]. Available: <https://www.irena.org/>
- [10] M. Shabani, E. Dahlquist, F. Wallin, and J. Yan, "Techno-economic impacts of battery performance models and control strategies on optimal design of a grid-connected PV system," *Energy Convers. Manag.*, vol. 245, pp. 114617–114638, 2021.
- [11] National Renewable Energy Laboratory (NREL), "Best practices for operation and maintenance of photovoltaic and energy storage systems," Tech. Rep. No. NREL/TP-7A40-73822, 2018.
- [12] M. Alramlawi and P. Li, "Design optimization of a residential PV-battery microgrid with a detailed battery lifetime estimation model," *IEEE Trans. Ind. Appl.*, vol. 56, no. 2, pp. 2020–2030, Mar./Apr. 2020.
- [13] A. I. Nousedilis, G. C. Kryonidis, E. O. Kontis, G. K. Papagiannis, G. C. Christoforidis, and I. P. Panapakidis, "Economic viability of residential PV systems with battery energy storage under different incentive schemes," in *Proc. IEEE Int. Conf. Environ. Elect. Eng., IEEE Ind. Commercial Power Syst. Europe*, Palermo, Italy, 2018, pp. 1–6.
- [14] J. von Appen and M. Braun, "Sizing and improved grid integration of residential PV systems with heat pumps and battery storage systems," *IEEE Trans. Energy Convers.*, vol. 34, no. 1, pp. 562–571, Mar. 2019.
- [15] B. Mohandes, M. Wahbah, M. S. E. Moursi, and T. H. El-Fouly, "Renewable energy management system: Optimum design and hourly dispatch," *IEEE Trans. Sustain. Energy*, vol. 12, no. 3, pp. 1615–1628, Jul. 2021.
- [16] A. Aichhorn, M. Greenleaf, H. Li, and J. Zheng, "A cost effective battery sizing strategy based on a detailed battery lifetime model and an economic energy management strategy," in *Proc. Power Energy Soc. Gen. Meeting*, San Diego, California, USA, 2012, pp. 1–8.
- [17] M. Ruiz-Cortés et al., "Optimal charge/discharge scheduling of batteries in microgrids of prosumers," *IEEE Trans. Energy Convers.*, vol. 34, no. 1, pp. 468–477, Mar. 2019.
- [18] S. K. Bhoi and M. R. Nayak, "Optimal scheduling of battery storage with grid tied PV systems for trade-off between consumer energy cost and storage health," *Microprocessors Microsystems*, vol. 79, pp. 103274–103281, 2020.
- [19] Y. Yang, A. Sangwongwanich, and F. Blaabjerg, "Design for reliability of power electronics for grid-connected photovoltaic systems," *CPSS Trans. Power Electron. Appl.*, vol. 1, no. 1, pp. 92–103, 2016.
- [20] A. Sangwongwanich, Y. Yang, D. Sera, F. Blaabjerg, and D. Zhou, "On the impacts of PV array sizing on the inverter reliability and lifetime," *IEEE Trans. Ind. Appl.*, vol. 54, no. 4, pp. 3656–3667, Jul./Aug. 2018.
- [21] A. Sangwongwanich et al., "Enhancing PV inverter reliability with battery system control strategy," *CPSS Trans. Power Electron. Appl.*, vol. 3, no. 2, pp. 93–101, 2018.
- [22] M. Sandelic, A. Sangwongwanich, and F. Blaabjerg, "Impact of power converters and battery lifetime on return of investment of photovoltaic systems," in *Proc. IEEE 9th Int. Power Electron. Motion Control Conf.*, 2020, pp. 1395–1401.
- [23] International Energy Agency Photovoltaic Power System Programme, "Trends in photovoltaic applications," Tech. Rep. IAE PVPS T1-41:2021, 2021.
- [24] A. Jager-Waldau et al., "Self-consumption of electricity produced from PV systems in apartment buildings - comparison of the situation in Australia, Austria, Denmark, Germany, Greece, Italy, Spain, Switzerland and the USA," in *Proc. IEEE 7th World Conf. Photovolt. Energy Convers. (Joint Conf. 45th IEEE PVSEC, 28th PVSEC & 34th EU PVSEC)*, Waikoloa, HI, USA, 2018, pp. 1424–1430.
- [25] M. Guled, "Self consumption solutions increasingly important for additional photovoltaic capacities," 2021. [Online]. Available: <https://www.eupd-research.com/en>
- [26] J. Dehler et al., "Chapter 27 - self-consumption of electricity from renewable sources," in *Europe's Energy Transition*, M. Welsch, S. Pye, D. Keles, A. Faure-Schuyler, A. Dobbins, A. Shivakumar, P. Deane, and M. Howells, Eds., San Francisco, CA, USA: Academic Press, 2017, pp. 225–236.
- [27] Y. Zhang, H. Wang, Z. Wang, Y. Yang, and F. Blaabjerg, "Impact of lifetime model selections on the reliability prediction of IGBT modules in modular multilevel converters," in *Proc. Energy Convers. Congr. Expo.*, Cincinnati, OH, USA, 2017, pp. 4202–4207.
- [28] M. Sandelic, A. Sangwongwanich, and F. Blaabjerg, "Reliability evaluation of PV systems with integrated battery energy storage systems: DC-coupled and AC-coupled configurations," *Electronics*, vol. 8, no. 9, pp. 1059–1078, 2019.
- [29] A. Gupta, O. P. Yadav, D. DeVoto, and J. Major, "A review of degradation behavior and modeling of capacitors," in *Proc. Int. Electron. Packag. Tech. Conf. Exhib.*, San Francisco, CA, USA, 2018, pp. 1–10.
- [30] R. Bayerer, T. Herrmann, T. Licht, J. Lutz, and M. Feller, "Model for power cycling lifetime of IGBT modules - various factors influencing lifetime," in *Proc. 5th Int. Conf. Integr. Power Electron. Syst.*, Nuremberg, Germany, 2008, pp. 1–6.
- [31] G. Angenendt, S. Zurmühlen, H. Axelsen, and D. U. Sauer, "Comparison of different operation strategies for PV battery home storage systems including forecast-based operation strategies," *Appl. Energy*, vol. 229, pp. 884–899, 2018.
- [32] National Renewable Energy Laboratory (NREL), "U.S solar photovoltaic system and energy storage cost benchmark: Q1 2020," Tech. Rep. No. NREL/TP-6A20-77324, 2021.
- [33] I. E. Kosmadakis, C. Elmasides, G. Koulinas, and K. P. Tsagarakis, "Energy unit cost assessment of six photovoltaic-battery configurations," *Renewable Energy*, vol. 173, pp. 24–41, 2021.
- [34] International Renewable Energy Agency, "Electricity storage and renewables: Costs and markets to 2030," 2017. [Online]. Available: <https://www.irena.org/>
- [35] International Renewable Energy Agency, "Cost and competitiveness indicators: Rooftop solar PV," 2017. [Online]. Available: <https://www.irena.org/>
- [36] R. A. Chadderton, *Purposeful Engineering Economics*, Berlin, Germany: Springer, 2015.