

A Vertex-Weighted Tutte Symmetric Function, and Constructing Graphs with Equal Chromatic Symmetric Function

José Aliste-Prieto*

Departamento de Matemáticas
Universidad Andres Bello
Santiago, Chile

jose.aliste@unab.cl

Logan Crew

Department of Mathematics
University of Pennsylvania
Philadelphia, PA, U.S.A.

lcrew@uwaterloo.ca

Sophie Spirkl†

Department of Mathematics
Princeton University
Princeton, NJ, U.S.A.

sspirkl@uwaterloo.ca

José Zamora*

Departamento de Matemáticas
Universidad Andres Bello
Santiago, Chile

josezamora@unab.cl

Current address (Crew, Spirkl):

Department of Combinatorics and Optimization
University of Waterloo
Waterloo, ON, Canada

lcrew@uwaterloo.ca; sspirkl@uwaterloo.ca

Submitted: Nov 13, 2020; Accepted: Mar 27, 2021; Published: Apr 9, 2021

© The authors. Released under the CC BY-ND license (International 4.0).

Abstract

This paper has two main parts. First, we consider the Tutte symmetric function XB , a generalization of the chromatic symmetric function. We introduce a vertex-weighted version of XB , show that this function admits a deletion-contraction relation, and show that it is equivalent to a number of other vertex-weighted graph

*Supported by CONICYT FONDECYT REGULAR 1160975

†This material is based upon work supported by the National Science Foundation under Award No. DMS-1802201. Supported by the Natural Sciences and Engineering Research Council of Canada (NSERC), (funding reference number RGPIN-2020-03912). Cette recherche a été financée par le Conseil de recherches en sciences naturelles et en génie du Canada (CRSNG), (numéro de référence RGPIN-2020-03912).

functions, namely the W -polynomial, the polychromate, and the weighted (r, q) -chromatic function. We also demonstrate that the vertex-weighted XB admits spanning-tree and spanning-forest expansions generalizing those of the Tutte polynomial, and show that from this we may also derive a spanning-tree formula for the chromatic symmetric function.

Second, we give several methods for constructing nonisomorphic graphs with equal chromatic and Tutte symmetric functions, and use them to provide specific examples. In particular, we show that there are pairs of unweighted graphs of arbitrarily high girth with equal Tutte symmetric function, and arbitrarily large vertex-weighted trees with equal Tutte symmetric function.

Mathematics Subject Classifications: 05E05, 05C31

Note: this paper was originally announced in [13] with the working title “Using Deletion-Contraction to Construct Graphs with Equal Chromatic Symmetric Function”.

1 Introduction

The chromatic symmetric function X_G of a graph G , introduced by Stanley in the 1990s [42], is an extension of the chromatic polynomial that (among other things) counts for each integer partition $\lambda = (\lambda_1, \dots, \lambda_k)$ the number of partitions of $V(G)$ into stable sets of sizes $\lambda_1, \dots, \lambda_k$. This function has seen a recent resurgence of interest, including research focusing on the expansion of X_G in the bases of elementary symmetric functions [9, 15, 16, 23] and Schur functions [37, 38, 45], and the conjecture that X_G distinguishes nonisomorphic trees [3, 26]. Other results have extended the definition of X_G in various ways to include representation theoretic and graph theoretic considerations, including chromatic quasisymmetric functions [1, 22, 41] and chromatic symmetric functions in noncommuting variables [17, 24].

In [13], the second and third authors extended the chromatic symmetric function to graphs G equipped with vertex weights in the form of a function $w : V(G) \rightarrow \mathbb{N}$. The extended function $X_{(G,w)}$ satisfies a natural deletion-contraction relation, which can be used to extend identities of X_G to this broader class of graphs, and prove new results.

In this paper, we continue the work of [13] in multiple ways. Following an exposition in Section 2 of necessary background on graphs and symmetric functions, in Section 3 we extend the function $X_{(G,w)}$ to include Stanley’s Tutte symmetric function [43], which is a natural extension of the Tutte polynomial. We show that the resulting function $XB_{(G,w)}(t, x_1, x_2, \dots)$ of t and variables x_1, x_2, \dots satisfies an edge deletion-contraction relation generalizing that of $X_{(G,w)}$.

In Section 4 we show that $XB_{(G,w)}$ is a specialization of the V -polynomial of Ellis-Monaghan and Moffatt [19], and is thus closely related to many other graph functions. For example, we demonstrate that up to a change of variables the vertex-weighted version of XB is equivalent to the W -polynomial of Noble and Welsh [35] by showing that the two functions satisfy the same base cases and recurrence relations, providing a strengthening of Noble and Welsh’s analogous result on the equivalence of unweighted XB and the unweighted W -polynomial (or U -polynomial). We similarly show that the vertex-weighted

XB is equivalent to a natural vertex-weighted extension of the polychromate of Brylawski [7] and the weighted (r, q) -chromatic function of Klazar, Loeb, and Moffatt [27], generalizing proofs of equivalence in unweighted graphs made in the aforementioned references as well as the work of Merino and Noble [33] and Sarmiento [40].

In Section 5 we use the relationship between XB and the V -polynomial to derive spanning-tree and spanning-forest expansions for XB . We show that the spanning-tree expansion specializes to a well-known analogous expansion of the Tutte polynomial, and is a natural improvement of the p -basis expansion formula for XB originally introduced in [10]. From this formula we likewise derive an expansion of the chromatic symmetric function in terms of spanning trees with no external activity, and show that this expansion refines its classical p -basis expansion [42].

In Section 6, we use deletion-contraction relations to provide multiple original methods for constructing pairs of nonisomorphic graphs with equal X_G and/or XB_G . In particular, we demonstrate graph pairs with arbitrarily high girth whose Tutte symmetric functions agree.

In Section 7, we further use the equivalence between XB_G and the W -polynomial of G to find additional families of vertex-weighted graphs with the same XB , and in particular we show how to construct arbitrarily large vertex-weighted paths with equal XB (similar results are found in the independent work [2] by Aliniaiefard, Wang, and van Willigenburg).

We conclude in Section 8 with further directions and conjectures. We note how the examples in Sections 6 and 7 suggest new lines of research related to open problems regarding the chromatic symmetric function, particularly the conjecture that the chromatic symmetric function distinguishes nonisomorphic trees.

2 Background

2.1 Fundamentals of Symmetric Functions and Graphs

An *integer partition* (or just *partition*) is a tuple $\lambda = (\lambda_1, \dots, \lambda_k)$ of positive integers such that $\lambda_1 \geq \dots \geq \lambda_k$. The integers λ_i are the *parts* of λ . If $\sum_{i=1}^k \lambda_i = n$, we say that λ is a partition of n , and we write $\lambda \vdash n$, or $|\lambda| = n$. The number of parts k is the *length* of λ , and is denoted by $l(\lambda)$. The number of parts equal to i in λ is given by $r_i(\lambda)$.

A function $f(x_1, x_2, \dots) \in \mathbb{R}[[x_1, x_2, \dots]]$ is *symmetric* if

$$f(x_1, x_2, \dots) = f(x_{\sigma(1)}, x_{\sigma(2)}, \dots)$$

for every permutation σ of the positive integers \mathbb{N} . The *algebra of symmetric functions* Λ is the subalgebra of $\mathbb{R}[[x_1, x_2, \dots]]$ consisting of those symmetric functions f that are of bounded degree (that is, there exists a positive integer n such that every monomial of f has degree $\leq n$). Furthermore, Λ is a graded algebra, with natural grading

$$\Lambda = \bigoplus_{d=0}^{\infty} \Lambda^d$$

where Λ^d consists of symmetric functions that are homogeneous of degree d [29, 44].

Each Λ^d is a finite-dimensional vector space over \mathbb{R} , with dimension equal to the number of partitions of d (and thus, Λ is an infinite-dimensional vector space over \mathbb{R}). Some commonly-used bases of Λ that are indexed by partitions $\lambda = (\lambda_1, \dots, \lambda_k)$ include:

- The monomial symmetric functions m_λ , defined as the sum of all distinct monomials of the form $x_{i_1}^{\lambda_1} \dots x_{i_k}^{\lambda_k}$ with distinct indices i_1, \dots, i_k .
- The power-sum symmetric functions, defined by the equations

$$p_n = \sum_{k=1}^{\infty} x_k^n, \quad p_\lambda = p_{\lambda_1} p_{\lambda_2} \dots p_{\lambda_k}.$$

- The elementary symmetric functions, defined by the equations

$$e_n = \sum_{i_1 < \dots < i_n} x_{i_1} \dots x_{i_n}, \quad e_\lambda = e_{\lambda_1} e_{\lambda_2} \dots e_{\lambda_k}.$$

We also make use of the *augmented monomial symmetric functions*, defined by

$$\tilde{m}_\lambda = \left(\prod_{i=1}^{\infty} r_i(\lambda)! \right) m_\lambda.$$

Given a symmetric function f and a basis b of Λ , we say that f is *b-positive* if when we write f in the basis b , all coefficients are nonnegative.

We define the *symmetric function involution* ω by $\omega(p_\lambda) = (-1)^{|\lambda| - l(\lambda)} p_\lambda$.

A *graph* $G = (V, E)$ consists of a *vertex set* V and an *edge multiset* E where the elements of E are (unordered) pairs of (not necessarily distinct) elements of V . An edge $e \in E$ that contains the same vertex twice is called a *loop*. If there are two or more edges that each contain the same two vertices, they are called *multi-edges*. A *simple graph* is a graph $G = (V, E)$ in which E does not contain loops or multi-edges (thus, $E \subseteq \binom{V}{2}$). If $\{v_1, v_2\}$ is an edge, we will write it as $v_1 v_2 = v_2 v_1$. The vertices v_1 and v_2 are the *endpoints* of the edge $v_1 v_2$. We will use $V(G)$ and $E(G)$ to denote the vertex set and edge multiset of a graph G , respectively.

Two graphs G and H are said to be *isomorphic* if there exists a bijective map $f : V(G) \rightarrow V(H)$ such that for all $v_1, v_2 \in V(G)$ (not necessarily distinct), the number of edges $v_1 v_2$ in $E(G)$ is the same as the number of edges $f(v_1) f(v_2)$ in $E(H)$.

The *complement* of a simple graph $G = (V, E)$ is denoted \overline{G} , and is defined as $\overline{G} = (V, \binom{V}{2} \setminus E)$, so in \overline{G} every edge of G is replaced by a nonedge, and every nonedge is replaced by an edge.

A *subgraph* of a graph G is a graph $G' = (V', E')$ where $V' \subseteq V$ and $E' \subseteq E|_{V'}$, where $E|_{V'}$ is the set of edges with both endpoints in V' . An *induced subgraph* of G is a graph $G' = (V', E|_{V'})$ with $V' \subseteq V$. The induced subgraph of G using vertex set V' will be denoted $G|_{V'}$. A *stable set* of G is a subset $V' \subseteq V$ such that $E|_{V'} = \emptyset$. A *clique* of G is a subset $V' \subseteq V$ such that for every pair of distinct vertices v_1 and v_2 of V' , $v_1 v_2 \in E(G)$.

A *path* in a graph G is a nonempty sequence of edges $v_1v_2, v_2v_3, \dots, v_{k-1}v_k$ such that $v_i \neq v_j$ for all $i \neq j$. The vertices v_1 and v_k are the *endpoints* of the path. A *cycle* in a graph is a nonempty sequence of distinct edges $v_1v_2, v_2v_3, \dots, v_kv_1$ such that $v_i \neq v_j$ for all $i \neq j$. Note that in a simple graph every cycle must have at least 3 edges, although in a nonsimple graph there may be cycles of size 1 (a loop) or 2 (multi-edges).

A graph G is *connected* if for every pair of vertices v_1 and v_2 of G there is a path in G with v_1 and v_2 as its endpoints. The *connected components* of G are the maximal induced subgraphs of G which are connected. The number of connected components of G will be denoted by $c(G)$.

The *complete graph* K_n on n vertices is the unique simple graph having all possible edges, that is, $E(K_n) = \binom{V}{2}$ where $V = V(K_n)$.

Given a graph G , there are two commonly used operations that produce new graphs. One is *deletion*: given an edge $e \in E(G)$, the graph of G with e deleted is the graph $G' = (V(G), E(G) \setminus \{e\})$, and is denoted $G \setminus e$. Likewise, if S is a multiset of edges, we use $G \setminus S$ to denote the graph $(V(G), E(G) \setminus S)$.

The other operation is the *contraction of an edge* $e = v_1v_2$, denoted G/e . If $v_1 = v_2$ (e is a loop), we define $G/e = G \setminus e$. Otherwise, we create a new vertex v^* , and define G/e as the graph G' with $V(G') = (V(G) \setminus \{v_1, v_2\}) \cup v^*$, and $E(G') = (E(G) \setminus E(v_1, v_2)) \cup E(v^*)$, where $E(v_1, v_2)$ is the set of edges with at least one of v_1 or v_2 as an endpoint, and $E(v^*)$ consists of each edge in $E(v_1, v_2) \setminus e$ with the endpoint v_1 and/or v_2 replaced with the new vertex v^* . Note that this is an operation on a (possibly nonsimple) graph that identifies two vertices while keeping and/or creating multi-edges and loops.

There is also a different version of edge contraction that is defined only on simple graphs. In the case that G is a simple graph, we define the *simple contraction* $G \dagger e$ to be the same as G/e except that after performing the contraction operation, we delete any loops and all but a single copy of each multi-edge so that the result is again a simple graph.

Let $G = (V(G), E(G))$ be a (not necessarily simple) graph. A map $\kappa : V(G) \rightarrow \mathbb{N}$ is called a *coloring* of G . This coloring is called *proper* if $\kappa(v_1) \neq \kappa(v_2)$ for all v_1, v_2 such that there exists an edge $e = v_1v_2$ in $E(G)$. The *chromatic symmetric function* X_G of G is defined as

$$X_G(x_1, x_2, \dots) = \sum_{\kappa} \prod_{v \in V(G)} x_{\kappa(v)}$$

where the sum runs over all proper colorings κ of G . Note that if G contains a loop then $X_G = 0$, and X_G is unchanged by replacing each multi-edge by a single edge.

2.2 Vertex-Weighted Graphs and their Colorings

A *vertex-weighted graph* (G, w) consists of a graph G and a weight function $w : V(G) \rightarrow \mathbb{N}$.

Given two vertex-weighted graphs (G_1, w_1) and (G_2, w_2) , we call a map $f : V(G_1) \rightarrow V(G_2)$ a *w-isomorphism* if f is an isomorphism of G_1 with G_2 , and also for all $v \in V(G_1)$ we have $w_1(v_1) = w_2(f(v_1))$.

Given a vertex-weighted graph (G, w) and a non-loop edge $e = v_1v_2 \in E(G)$ we define its *contraction by e* to be the graph $(G/e, w/e)$, where w/e is the weight function such that $(w/e)(v) = w(v)$ if v is not the contracted vertex v^* , and $(w/e)(v^*) = w(v_1) + w(v_2)$ (if e is a loop, we define the contraction of (G, w) by e to be $(G \setminus e, w)$).

In [13], the authors extended X_G to vertex-weighted graphs as

$$X_{(G,w)} = \sum_{\kappa} \prod_{v \in V(G)} x_{\kappa(v)}^{w(v)}$$

where again the sum ranges over all proper colorings κ of G . In this setting the chromatic symmetric function admits the deletion-contraction relation [13]

$$X_{(G,w)} = X_{(G \setminus e, w)} - X_{(G/e, w/e)} \tag{1}$$

as well as the version

$$X_{(G,w)} = X_{(G \setminus e, w)} - X_{(G/e, w/e)} \tag{2}$$

using simple contraction in the case that G is simple.

Note also that if two vertex-weighted graphs are w -isomorphic, then they must have the same chromatic symmetric function. The converse is not true even in the unweighted case [42].

3 The Weighted Version of the Tutte Symmetric Function

In this section, we extend the definition of the vertex-weighted chromatic symmetric function to include *all* colorings of a graph, not just the proper ones. To this end, for a given (not necessarily proper) coloring κ of G , we define

$$x_{\kappa}(G, w, t) = (1+t)^{c_{\kappa}(G)} \prod_{v \in V(G)} x_{\kappa(v)}^{w(v)}$$

where $c_{\kappa}(G)$ is the number of edges $v_1v_2 \in E(G)$ such that $\kappa(v_1) = \kappa(v_2)$. We then define the *Tutte symmetric function of a vertex-weighted graph*¹ (G, w) to be the following analogue of the Tutte symmetric function introduced by Stanley in [43]:

$$XB_{(G,w)}(t, x_1, x_2, \dots) = \sum_{\kappa} x_{\kappa}(G, w, t) \tag{3}$$

where the sum is over all colorings κ of G (not just the proper ones). This name comes from the fact that the original function admits the Tutte polynomial $T_G(x, y)$ as a specialization via the relation

$$XB_G(t, \underbrace{1, 1, \dots, 1}_n, 0, 0, \dots) = n^{c(G)} t^{|V(G)| - c(G)} T_G\left(\frac{t+n}{n}, t+1\right) \tag{4}$$

¹The function is also known as the *bad-coloring chromatic symmetric function*, hence the notation XB . We continue using XB as it is more common in the literature and less confusing in this context than the original $X_G(\mathbf{x}; t)$.

where $c(G)$ is the number of connected components of G .

Given a partition π of $V(G)$ (into nonempty blocks), let $e(\pi)$ be the number of edges of G whose endpoints lie in the same block of π , and $\lambda(\pi)$ the partition whose parts are the total weights of the blocks of π . We may verify the following lemma, an extension of the corresponding result on unweighted graphs:

Lemma 1 ([21]).

$$XB_{(G,w)} = \sum_{\pi \vdash V(G)} (1+t)^{e(\pi)} \tilde{m}_{\lambda(\pi)} \quad (5)$$

Proof. For $\lambda = (\lambda_1, \dots, \lambda_k)$ it suffices to show that the coefficient of $x_1^{\lambda_1} \dots x_k^{\lambda_k}$ in $XB_{(G,w)}$ is given by

$$\sum_{\substack{\pi \vdash V(G) \\ \lambda(\pi) = \lambda}} (1+t)^{e(G)} \left(\prod_{i=1}^{\infty} r_i(\lambda)! \right).$$

From the defining equation (3) it is clear that we may only get the monomial $x_1^{\lambda_1} \dots x_k^{\lambda_k}$ by choosing a coloring κ of G with vertices of total weight λ_i receiving the color i for each i , and then giving it the coefficient $(1+t)^{c_\kappa(G)}$. Each such coloring κ corresponds to a partition $\pi \vdash V(G)$ into k blocks where the i^{th} block consists of vertices colored i by κ , and these receive a coefficient of $(1+t)^{e(\pi)}$ since the monochromatic edges are exactly those that are entirely contained within a block of π .

Conversely, each $\pi \vdash V(G)$ contributes (with coefficient $(1+t)^{e(\pi)}$) exactly $(\prod_{i=1}^{\infty} r_i(\lambda)!)$ colorings with monomial $x_1^{\lambda_1} \dots x_k^{\lambda_k}$: the one where the i^{th} block of π gets color i , permuting the color choices among blocks of the same total weight, and the conclusion follows. \square

We use the convention $0^0 = 1$, so that when $t = -1$ we have

$$XB_{(G,w)}(-1, x_1, x_2, \dots) = X_{(G,w)}(x_1, x_2, \dots).$$

On vertex-weighted graphs, $XB_{(G,w)}$ admits the following deletion-contraction relation that generalizes the deletion-contraction relation of [13]:

Lemma 2. *Let (G, w) be a vertex-weighted graph. For all $e \in E(G)$,*

$$XB_{(G,w)} = XB_{(G \setminus e, w)} + tXB_{(G/e, w/e)}. \quad (6)$$

Proof. First, note that when $t = -1$, the deletion-contraction relation (6) reduces to (1), so we may assume $t \neq -1$. Furthermore, the case when e is a loop follows immediately from the definition of XB , so we may assume that e is not a loop.

Let v_1 and v_2 be the endpoints of e . We start with the right-hand side of (6) and expand using the definition (3) of XB :

$$XB_{(G \setminus e, w)} + tXB_{(G/e, w/e)} = \left(\sum_{\kappa: V(G \setminus e) \rightarrow \mathbb{N}} x_\kappa(G \setminus e, w, t) \right) + t \left(\sum_{\kappa: V(G/e) \rightarrow \mathbb{N}} x_\kappa(G/e, w/e, t) \right).$$

Note that all colorings of G are also colorings of $G \setminus e$, and vice versa. We split the κ in the first summand based on $\kappa(v_1)$ and $\kappa(v_2)$. In those κ where $\kappa(v_1) \neq \kappa(v_2)$, we have $c_\kappa(G \setminus e) = c_\kappa(G)$, so $x_\kappa(G \setminus e, w, t) = x_\kappa(G, w, t)$. In all κ with $\kappa(v_1) = \kappa(v_2)$, we have $c_\kappa(G \setminus e) = c_\kappa(G) - 1$ because of the missing edge e , so for these κ , we have $x_\kappa(G \setminus e, w, t) = (1 + t)^{-1}x_\kappa(G, w, t)$.

For the second summand, note that every coloring κ of G/e corresponds naturally to a coloring κ of G with $\kappa(v_1) = \kappa(v_2)$, and vice-versa (we will use the same κ to denote both of these colorings in a slight abuse of notation). For these κ we will have $c_\kappa(G/e) = c_\kappa(G) - 1$ since we are missing the contracted edge e , and thus for each such κ we will have $x_\kappa(G/e, w/e, t) = (1 + t)^{-1}x_\kappa(G, w, t)$. Putting everything together, we have

$$\begin{aligned} XB_{(G \setminus e, w)} + tXB_{(G/e, w/e)} &= \sum_{\kappa: V(G \setminus e) \rightarrow \mathbb{N}} x_\kappa(G \setminus e, w, t) + t \sum_{\kappa: V(G/e) \rightarrow \mathbb{N}} x_\kappa(G/e, w/e, t) \\ &= \sum_{\substack{\kappa: V(G) \rightarrow \mathbb{N} \\ \kappa(v_1) \neq \kappa(v_2)}} x_\kappa(G, w, t) + \sum_{\substack{\kappa: V(G) \rightarrow \mathbb{N} \\ \kappa(v_1) = \kappa(v_2)}} (1 + t)^{-1}x_\kappa(G, w, t) \\ &\quad + t \sum_{\substack{\kappa: V(G) \rightarrow \mathbb{N} \\ \kappa(v_1) = \kappa(v_2)}} (1 + t)^{-1}x_\kappa(G, w, t) \\ &= \sum_{\kappa: V(G) \rightarrow \mathbb{N}} x_\kappa(G, w, t) \\ &= XB_{(G, w)} \end{aligned}$$

as desired. □

As a consequence of this relation, we can derive a p -basis expansion formula by simply replacing (-1) s with ts in ([13], Lemma 3) to give the following analogue of the original formula in [43]:

Corollary 3.

$$XB_{(G, w)}(t, x_1, x_2, \dots) = \sum_{S \subseteq E(G)} t^{|S|} p_{\lambda(G, w, S)}. \tag{7}$$

where $\lambda(G, w, S)$ is the integer partition whose parts are the total weights of the connected components of $((V(G), S), w)$.

4 Relating the Tutte Symmetric Function With Other Graph Functions

Note that the deletion-contraction relation (6) together with $XB_{(G, w)} = p_{(w_1, \dots, w_k)}$ when (G, w) is a graph with no edges and vertices of weights $w_1 \geq \dots \geq w_k$ can be taken as an alternative definition of $XB_{(G, w)}$.

This formulation is closely related to the more general V -polynomial, defined as a function $V(G, J, w, \{x_j : j \in J\}, \{\gamma_e : e \in E(G)\})$ where

- G is a graph;
- J is a torsion-free commutative semigroup (e.g. $(\mathbb{N}, +)$ or $(2^{\mathbb{N}}, \cap)$);
- $w : V(G) \rightarrow J$ is a vertex-weight function;
- The function uses a set of commuting indeterminates x_j indexed by elements $j \in J$, and a set of commuting indeterminates γ_e indexed by edges $e \in E(G)$.

For brevity, in what follows we will often fix J and the variables x_j , and consider V as a function $V_{(G,w)}$ on vertex-weighted graphs. Given these inputs, the V -polynomial is defined by the following relations [19]:

- If (G, w) is a graph with no edges and vertices of weights w_1, \dots, w_k , we have $V_{(G,w)} = x_{w_1} \dots x_{w_k}$.
- If $e \in E(G)$ is a loop, $V_{(G,w)} = (\gamma_e + 1)V_{(G \setminus e, w)}$.
- If $e \in E(G)$ is not a loop, $V_{(G,w)} = V_{(G \setminus e, w)} + \gamma_e V_{(G/e, w/e)}$.

It may be shown from these relations that the V -polynomial satisfies [19]

$$V_{(G,w)} = \sum_{S \subseteq E(G)} \prod_{c \in C_G(S)} x_{|c|} \prod_{e \in S} \gamma_e \tag{8}$$

where $C_G(S)$ is the set of connected components of the graph $(V(G), S)$, and for $c \in C_G(S)$, $|c|$ is the sum (using the operation of J) of the weights of the vertices in c .

Using either the recurrence relations or the expansion (8), we may verify that $XB_{(G,w)}$ is a special case of the V -polynomial in which $J = (\mathbb{N}, +)$, $\gamma_e = t$ for all $e \in E(G)$, and each variable x_n is replaced by the power-sum symmetric function $p_n(x_1, x_2, \dots)$. That is,

$$V(G, (\mathbb{N}, +), w, p_1, p_2, \dots; t) = XB_{(G,w)}(t, x_1, x_2, \dots). \tag{9}$$

The function $XB_{(G,w)}$ is also closely related to other specializations of the V -polynomial. A notable example is the W -polynomial from invariant theory [35] (and its unweighted version, the U -polynomial), which has been studied both in its own right [34] and in relation to the chromatic symmetric function [3, 4].

This (nonsymmetric) function $W_{(G,w)}(y, x_1, x_2, \dots)$ on vertex-weighted graphs is defined by the following relations:

- If (G, w) is a graph with no edges and vertices of weights $w_1 \geq \dots \geq w_k$, we have $W_{(G,w)} = x_{w_1} \dots x_{w_k}$.
- If $e \in E(G)$ is a loop, $W_{(G,w)} = yW_{(G \setminus e, w)}$.

- If $e \in E(G)$ is not a loop, $W_{(G,w)} = W_{(G \setminus e, w)} + W_{(G/e, w/e)}$.

Note that if $J = (\mathbb{N}, +)$ and $\gamma_e = y - 1$ for all $e \in E(G)$, then

$$V_{(G,w)} = (y - 1)^{|V(G)|} W_{(G,w)}(y, x_1(y - 1)^{-1}, x_2(y - 1)^{-1}, \dots) \quad (10)$$

so the W -polynomial may be derived from the V -polynomial [19].

One can prove either by specializing (8) or induction on the number of edges as in [35] that the W -polynomial satisfies

$$W_{(G,w)}(y, x_1, x_2, \dots) = \sum_{S \subseteq E(G)} x_{c_1} \dots x_{c_k} (y - 1)^{|S|+k-|V(G)|} \quad (11)$$

where c_1, \dots, c_k are the total weights of the connected components of the vertex-weighted graph $((V(G), S), w)$.

We say that two functions on vertex-weighted graphs (G, w) are *equivalent* if given one, we can entirely recover the other, without knowing the graph (G, w) . We show the following generalization of ([35], Theorem 6.2):

Lemma 4. *The functions $XB_{(G,w)}(t, x_1, x_2, \dots)$ and $W_{(G,w)}(y, x_1, x_2, \dots)$ are equivalent.*

Proof. We actually prove a stronger statement, that given $W_{(G,w)}$, we may recover the p -basis expansion of $XB_{(G,w)}$ via the substitution

$$XB_{(G,w)} = t^{|V(G)|} W_{(G,w)} \left(t + 1, \frac{p_1}{t}, \frac{p_2}{t}, \dots, \frac{p_k}{t}, \dots \right) \quad (12)$$

and conversely, given the p -basis expansion of $XB_{(G,w)}$, we may recover $W_{(G,w)}$ by dividing by $t^{|V(G)|}$, setting $t = y - 1$, and replacing each p_k with tx_k . This stronger statement may be proven as a simple vertex-weighted generalization of the argument from ([35], Theorem 6.2) by showing that these substitutions take (7) to (11) and vice-versa.

We provide a different proof by showing that this substitution works not just for these equations, but for the base cases and inductive steps of the recursive definitions for $XB_{(G,w)}$ and $W_{(G,w)}$. In this sense these functions are not only equivalent, but essentially the same up to a change of variables.

The base cases for both functions are vertex-weighted graphs with no edges. Let (G, w) be a vertex-weighted graph with no edges and vertices of weights $w_1 \geq \dots \geq w_k$. Then $XB_{(G,w)} = p_{w_1} \dots p_{w_k}$, $W_{(G,w)} = x_{w_1} \dots x_{w_k}$, and we now verify that the substitution works. Going from W to XB we have:

$$x_{w_1} \dots x_{w_k} \mapsto t^k \left(\frac{p_{w_1}}{t} \right) \dots \left(\frac{p_{w_k}}{t} \right) = p_{w_1} \dots p_{w_k}$$

and the converse is analogous.

For the inductive step, assume that we have demonstrated that this substitution is valid for graphs with at most m edges for some m . Let (G, w) be a vertex-weighted graph with $m + 1$ edges and let e be an edge of G . Starting with the W -polynomial and using

deletion-contraction we have two cases. First, if e is a loop, then $W_{(G,w)} = yW_{(G \setminus e, w)}$. Then applying our substitution we may derive $(t + 1)XB_{(G \setminus e, w)} = XB_{(G,w)}$, and the converse is analogous.

If e is not a loop, then $W_{(G,w)} = W_{(G \setminus e, w)} + W_{(G/e, w/e)}$ (note that $G \setminus e$ and G/e have a different number of vertices). We make the substitution $x_i = \frac{p_i}{t}$, $y = t + 1$, and multiply by $t^{|V(G)|}$. Then by the inductive hypothesis the resulting function is $XB_{(G \setminus e, w)} + tXB_{(G/e, w/e)} = XB_{(G,w)}$ as desired, and again the converse process of recovering W from XB is analogous. \square

The function $XB_{(G,w)}$ is also related to the weighted (r, q) -chromatic function of [27]. For a vertex-weighted graph (G, w) with n vertices, this function is defined as

$$M_{(G,w)}(r, q) = \sum_{S \subseteq E(G)} (-1)^{|S|} \prod_{c \in C(S)} \sum_{i=0}^{n-1} r^{w(c)q^i}$$

where $C(S)$ is the set of connected components of $(V(G), S)$, and $w(c)$ is the total weight of the component c .

This function has a natural extension with an additional parameter in the form

$$B_{(G,w)}(r, q, t) = \sum_{S \subseteq E(G)} t^{|S|} \prod_{c \in C(S)} \sum_{i=0}^{n-1} r^{w(c)q^i}. \quad (13)$$

Note that from (13) it is clear that $B_{(G,w)}$ (and thus also $M_{(G,w)}$) may be derived from the V -polynomial by taking $J = (\mathbb{N}, +)$ and $\gamma_e = t$ for all e , and then substituting $x_n = \sum_{i=0}^{n-1} r^{w(c)q^i}$.

Using the arguments from ([27], Section 3) and adjusting them to the vertex-weighted case it is easy to show that

Lemma 5. $M_{(G,w)}(r, q)$ is equivalent to $X_{(G,w)}(x_1, x_2, \dots)$, and $B_{(G,w)}(r, q, t)$ is equivalent to $XB_{(G,w)}(t, x_1, x_2, \dots)$.

Finally, we mention a closely related graph function that is not a specialization of the V -polynomial. Retaining the notation used for the \tilde{m} -basis expansion of XB given in (5), define the *polychromate* of a vertex-weighted graph (G, w) as

$$\nu_{(G,w)}(y, x_1, x_2, \dots) = \sum_{\pi \vdash V(G)} y^{e(\pi)} x_{\lambda(\pi)} \quad (14)$$

where here letting $\lambda = \lambda(\pi)$ we have $x_{\lambda(\pi)} = x_{\lambda_1} \cdots x_{\lambda_{l(\lambda)}}$.

This is a vertex-weighted generalization of a function originally introduced by Brylawski [7]. Unfortunately, even in this vertex-weighted form, $\nu_{(G,w)}$ is not a specialization of the V -polynomial, as when (G, w) has no edges and vertices of weights w_1, \dots, w_k we find that $\nu_{(G,w)}$ is equal to the sum of $x_{w_1} \cdots x_{w_k}$ and all of the x_λ where λ is a coarsening of the partition (w_1, \dots, w_k) . Even modifying the weight set J does not give a reasonable fix to this problem.

Nonetheless, we may easily see by comparing (14) with (5) that the vertex-weighted polychromate is equivalent to the vertex-weighted XB and thus to the vertex-weighted (r, q) -chromatic function and the W -polynomial. This extends previously known results that showed the equivalence of these four functions on unweighted graphs [27, 33, 40]. A more thorough summary of these functions and their properties on unweighted graphs is given in [21].

It is reasonable to ask what advantages are introduced by using the vertex-weighted Tutte symmetric function as opposed to any of these equivalent graph functions. For one, the theory of symmetric function bases may be applied to find encoded information that is much more difficult to detect using the other functions. It is already known that the chromatic and Tutte symmetric functions on vertex-weighted graphs encode information, such as an enumeration of ordered pairs of acyclic orientations and certain maps on their sinks [13, 14] or intersections of maximal stable sets [12], that to the best of the authors' knowledge have not been replicated by these other functions. Furthermore, as the Tutte polynomial is the universal graph polynomial with a deletion-contraction relation [18], it is natural to try to extend its properties to vertex-weighted graphs. In the next section we will derive further expansions of the Tutte symmetric function that naturally generalize classical expansions of the Tutte polynomial, lending solid evidence to the claim that the Tutte symmetric function is in some sense the natural vertex-weighted extension of the Tutte polynomial.

5 Spanning Tree and Spanning Forest Expansions for XB

Properties of the V -polynomial specialize naturally to properties of XB . In particular, by considering results in [31] we may derive spanning tree and spanning forest expansions for XB that are natural generalizations of well-known formulas for the Tutte polynomial.

We will need the following definitions: A *spanning forest* of a graph G is an acyclic subgraph that contains all vertices of G . A *spanning tree* of G is a spanning forest of G with the same number of connected components as G . In what follows, we assume that the edges of G have been given some arbitrary total ordering. Given a fixed spanning tree T of G , we say that an edge $f \in T$ is *internally active with respect to T* if it is the smallest edge in the set $\{e \in E(G) : (T \setminus f) \cup e \text{ is a spanning tree}\}$, and *internally inactive with respect to T* otherwise. An edge $f \notin T$ is said to be *externally active with respect to T* if f is the smallest edge in the unique cycle of $T \cup f$, and *externally inactive with respect to T* otherwise. We may also extend the notion of external activity to spanning forests F by defining an edge $f \notin F$ to be externally inactive with respect to F if $F \cup f$ is acyclic, and otherwise applying the same definition as for trees.

Theorem 6 ([31], Theorems 5.1 and 6.2). *Let (G, w) be a vertex-weighted graph with some arbitrary total order on its edges, and let $T(G)$ be the set of spanning trees of G . For any $T \in T(G)$, let $ii(T)$, $ia(T)$, $ei(T)$, $ea(T)$ denote respectively the number of internally inactive, internally active, externally inactive, and externally active edges of G with respect to $T \in T(G)$. Also, let $II(T)$ be the set of internally inactive edges of G with respect to $T \in T(G)$.*

respect to T . Then

$$XB_{(G,w)} = \sum_{T \in T(G)} t^{ii(T)} (t+1)^{ea(T)} XB_{(T,w)/II(T)}. \quad (15)$$

Additionally, let $F(G)$ be the set of spanning forests of G . For $F \in F(G)$, let $|F|$ denote the number of edges of F , let $ea(F)$ denote the number of externally active edges of F , and let $\lambda(F)$ denote the partition whose parts are the total weights of the connected components of F . Then

$$XB_{(G,w)} = \sum_{F \in F(G)} t^{|F|} (t+1)^{ea(F)} p_{\lambda(F)}. \quad (16)$$

The spanning forest expansion (16) was also already known in an equivalent form for the W -polynomial [35]. Upon taking $t = -1$ (and $0^0 = 1$) this formula reduces to a vertex-weighted generalization of the chromatic symmetric function analogue of Whitney's Broken Circuit Theorem ([42], Theorem 2.9).

On the other hand, by using the substitution formula (4) between XB and the Tutte polynomial, we may verify that equation (15) is a direct generalization of the well-known formula

$$T_G(x, y) = \sum_{T \in T(G)} x^{ia(T)} y^{ea(T)}$$

which provides further strong justification for the choice of XB as the natural symmetric function analogue of T_G .

Furthermore, retaining the total order on the edges in Theorem 5, consider the mapping $M : 2^{E(G)} \rightarrow T(G)$ defined as follows:

1. Input $S \subseteq E(G)$ and the total order of $E(G)$. We will output T , the edges of a spanning tree of G . We start with $T = S$.
2. Inspect each edge of S in order from least to greatest. When inspecting an edge e , if it is part of a cycle in $(V(G), T)$, remove it from T .
3. Then, inspect each edge of $G \setminus S$ in order from least to greatest. When inspecting an edge e , if adding it to $(V(G), T)$ will not create a cycle, add e to T .
4. Output $M(S) = (V(G), T)$.

Conversely, for $T \in T(G)$, let $II(T)$ be the set of internally inactive edges of T , and $EI(T)$ the set of externally inactive edges. Then it is easy to verify that $M^{-1}(T)$ will consist of those $S \subseteq E(G)$ such that $II(T) \subseteq S$ and $EI(T) \cap S = \emptyset$ (and where S can contain any subset of the internally and externally active edges of T).

Thus, starting from the spanning tree formula (15), if for each $T \in T(G)$ we expand $(t+1)^{ea(T)}$ and $XB_{(T,w)/II(T)}$ using the p -basis expansion (7), the monomials of the form $t^i p_\lambda$ will be exactly those monomials of the p -basis formula for the whole graph (G, w) coming

from $S \in M^{-1}(T)$. In this manner, the spanning tree expansion (15) also represents a way to refine the full p -basis expansion of XB .

Furthermore, specializing at $t = -1$ yields

$$X_{(G,w)} = \sum_{\substack{T \in \mathcal{T}(G) \\ ea(T)=0}} (-1)^{ii(T)} X_{(T,w)/H(T)} \quad (17)$$

which provides a spanning tree formula for the chromatic symmetric function. This is interesting in its own right, and will be discussed further in Section 8.

6 Constructing Graphs with Equal Chromatic and Tutte Symmetric Functions

As with any graph function, it is natural to consider the extent to which the chromatic symmetric function distinguishes nonisomorphic graphs. The original chromatic symmetric function X_G fails to distinguish nonisomorphic graphs with as few as five vertices [42], and Orellana and Scott [36] used a modular relation on triangles to construct families of infinitely many pairs of graphs with equal chromatic symmetric function².

The deletion-contraction relation on $X_{(G,w)}$ and $XB_{(G,w)}$ is a powerful and simple tool for finding such constructions. Throughout this section, we will repeatedly use the following simple but fundamental lemma:

Lemma 7. *Let (G_1, w_1) and (G_2, w_2) be vertex-weighted graphs, and let $e_1 \in E(G_1)$ and $e_2 \in E(G_2)$ be edges.*

- *If $X_{(G_1 \setminus e_1, w_1)} = X_{(G_2 \setminus e_2, w_2)}$ and $X_{(G_1 \uparrow e_1, w_1/e_1)} = X_{(G_2 \uparrow e_2, w_2/e_2)}$, then $X_{(G_1, w_1)} = X_{(G_2, w_2)}$.*
- *If $XB_{(G_1 \setminus e_1, w_1)} = XB_{(G_2 \setminus e_2, w_2)}$, and $XB_{(G_1/e_1, w_1/e_1)} = XB_{(G_2/e_2, w_2/e_2)}$, then $XB_{(G_1, w_1)} = XB_{(G_2, w_2)}$.*

Proof. These claims follow immediately from equation (2) and Lemma 2 respectively. \square

In particular both parts of Lemma 7 hold when their equalities are replaced by w -isomorphism of the corresponding graphs. Note that in the case of XB we cannot replace contraction by simple contraction because unlike with the chromatic symmetric function, graphs that differ only by replacing edges with multi-edges or vice versa still have different XB .

²In fact, a recent result of Penaguiao [39] shows that in every pair of nonisomorphic graphs with the same chromatic symmetric function, one may be transformed into the other via finitely many applications of the relation from [36].

6.1 Constructions with Split Graphs

A *bipartite graph* is a graph that has a proper 2-coloring, that is, a graph whose vertices may be partitioned into two stable sets. A *split graph* is a graph that arises from taking a simple bipartite graph G with $V(G)$ partitioned into nonempty stable sets S_1 and S_2 , and switching all of the nonedges in either (but not both) of $G|_{S_1}$ and $G|_{S_2}$ to edges. Thus, the vertices of a split graph may be partitioned (not necessarily uniquely) into a stable set and a clique. The class of split graphs can also be characterized by the property that they contain no induced subgraph isomorphic to a five-vertex cycle, a four-vertex cycle, or the complement of a four-vertex cycle [25].

There is a natural way noted by Loeb and Sereni [28] to associate to any possibly non-simple (unweighted) graph a corresponding simple split graph: given a graph $G = (V, E)$, with $V(G) = \{v_1, \dots, v_n\}$ and $E(G) = \{e_1, \dots, e_m\}$. Then the *split graph* $sp(G)$ corresponding to G has vertex set $V(sp(G)) = \{t_1, t_2, \dots, t_n, t_{n+1}, \dots, t_{n+m}\}$, and edge set $E(sp(G)) = \{t_i t_j : 1 \leq i < j \leq n\} \cup \{t_i t_{n+j}, t_i t_{n+j} : e_j = v_i v_{i'} \text{ in } G\}$. In other words, $sp(G)$ is formed by taking the vertices of G , making them into a clique, and then adding a “hat” corresponding to each edge of G . Using the above notation, we say that vertex t_{n+j} of $sp(G)$ is the *splitting vertex* of the edge $e_j = v_i v_{i'}$ in G . The construction is illustrated in Figure 1.

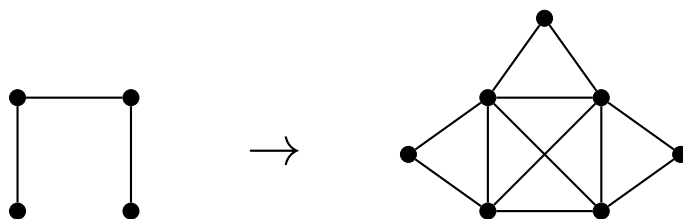

Figure 1: An example of the split graph construction.

For any two nonisomorphic graphs of more than three vertices the corresponding split graphs are clearly nonisomorphic (since the largest clique of the split graph must correspond to the vertex set of the original graph), so distinguishing split graphs is (up to some processing) equivalent to distinguishing all graphs. This motivates considering which functions distinguish split graphs; in [28] Loeb and Sereni conjecture that the U -polynomial (equivalently the Tutte symmetric function XB) does.

It is natural to consider whether the chromatic symmetric function itself already distinguishes split graphs. Unfortunately it does not, and in particular, the following lemma allows for the construction of infinitely many pairs of split graphs that have equal chromatic symmetric functions.

This construction will make use of graph automorphisms. An *automorphism* of a graph G is an isomorphism f of G with itself, and likewise a w -*automorphism* of a vertex-weighted graph (G, w) is a map f that is a w -isomorphism of (G, w) with itself.

Additionally, for $v_1, v_2 \in V(G)$, if $v_1 v_2 \notin E(G)$, we use the shorthand $G \cup v_1 v_2$ to mean the graph $(V(G), E(G) \cup v_1 v_2)$. For brevity if $v \in V(G)$ we also use v to refer to

the corresponding vertex of $sp(G)$.

Lemma 8. *Let G be an unweighted graph. Suppose G has (not necessarily distinct) vertices u, u', v, v' such that:*

- $uv \notin E(G)$ and $u'v' \notin E(G)$.
- *There is some automorphism of G that maps u to u' , and some (possibly different) automorphism of G that maps v to v' .*

Then $X_{sp(G \cup uv)} = X_{sp(G \cup u'v')}$.

Proof. Throughout this proof we will omit the weight function w from (G, w) ; the vertex weights will always all be 1 unless otherwise specified. Let G be as stated. In $sp(G \cup uv)$, let x be the splitting vertex of uv , and likewise in $sp(G \cup u'v')$ let x' be the splitting vertex of $u'v'$. By applying Lemma 7 to edge ux of $sp(G \cup uv)$ and edge $u'x'$ of $sp(G \cup u'v')$ it suffices to show that the graphs $sp(G \cup uv) \setminus ux$ and $sp(G \cup u'v') \setminus u'x'$ are w -isomorphic, and that the graphs $sp(G \cup uv) \upharpoonright ux$ and $sp(G \cup u'v') \upharpoonright u'x'$ are w -isomorphic.

Note that if $f : V(G) \rightarrow V(G)$ is an automorphism of G , we may extend it to an automorphism of $sp(G)$ by defining that for $z \in V(sp(G)) \setminus V(G)$, if z is the splitting vertex of ab , $f(z)$ is the splitting vertex of $f(a)f(b)$.

Let G_x denote $sp(G \cup uv) \setminus ux$, and let $G_{x'}$ denote $sp(G \cup u'v') \setminus u'x'$. Then $V(G_x) \setminus \{x\} = V(G_{x'}) \setminus \{x'\}$ and $E(G_x) \setminus \{vx\} = E(G_{x'}) \setminus \{v'x'\}$. By hypothesis there is an automorphism f of G with $f(v) = v'$, which may be extended to an automorphism of $sp(G)$ as described above. It is easy to verify that if we extend f once more to a function $f : V(G_x) \rightarrow V(G_{x'})$ by defining $f(x) = x'$, then f is a w -isomorphism of the (unweighted) graphs G_x and $G_{x'}$.

We now address the graphs with contracted edges. Upon applying simple contraction to the edge $ux \in sp(G \cup uv)$, we let z be the vertex formed by contraction (now with weight 2), and as we are applying simple contraction. Likewise, when applying contraction to the edge $u'x' \in sp(G \cup u'v')$, we let z' be the vertex formed by contraction (now with weight 2).

Let G_z denote $sp(G \cup uv) \upharpoonright ux$ and let $G_{z'}$ denote $sp(G \cup u'v') \upharpoonright u'x'$. Then $V(G_z) \setminus \{z\} = V(G_{z'}) \setminus \{z'\}$. By hypothesis there is an automorphism of G taking u to u' that extends to an automorphism of $sp(G)$. By extending f to a function $f : V(G_z) \rightarrow V(G_{z'})$ with $f(z) = z'$ (instead of $f(u) = u'$), this f is a w -isomorphism of $sp(G \cup uv) \upharpoonright ux$ and $sp(G \cup u'v') \upharpoonright u'x'$. \square

Thus, when $G \cup uv$ is not isomorphic to $G \cup u'v'$, the graphs $sp(G \cup uv)$ and $sp(G \cup u'v')$ are nonisomorphic split graphs with equal chromatic symmetric functions. One way to generate such examples easily is by taking an arbitrary noncomplete connected graph G , and choosing any nonedge ab in G . Then we construct $2G$ as the disjoint union of graphs G and G^* , where G^* is isomorphic to G (that is, $V(2G) = V(G) \sqcup V(G^*)$, and $E(2G) = E(G) \sqcup E(G^*)$). Let $f : V(G) \rightarrow V(G^*)$ be an isomorphism of G and G^* . In the statement of Lemma 8, let $u = u' = a$ and $v = b$ be vertices of the component G , and $v' = f(b)$ a vertex of the component G^* . Then it is simple to verify that these

choices for u, u', v, v' satisfy the lemma, and that the two graphs $2G \cup uv$ and $2G \cup u'v'$ are nonisomorphic, since the latter is connected, and the former is not.

We can also use Lemma 8 to produce two nonisomorphic graphs, both connected, such that their split graphs have equal chromatic symmetric functions, as shown in Figure 2. Note that in this figure $G \cup uv$ is not isomorphic to $G \cup u'v'$ because, for example, $G \cup uv$ contains a triangle (K_3), and $G \cup u'v'$ does not.

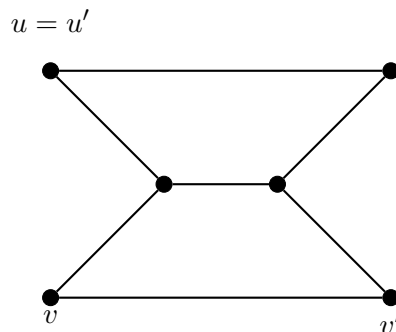

Figure 2: An unweighted connected graph G such that $X_{sp(G \cup uv)} = X_{sp(G \cup u'v')}$.

However, Lemma 8 can not generalize directly to XB because \dagger does not admit a simple deletion-contraction relation on XB . If we instead use normal contraction $/$ on the edge ux , we get a multi-edge between u and v , and likewise for u' and v' . Thus, to generalize Lemma 8 we would need a single automorphism of G that takes u to u' and v to v' simultaneously; but then clearly $G \cup uv$ and $G \cup u'v'$ would be isomorphic!

6.2 Further Constructions of Graphs with Equal X_G

In much of the recent literature on the chromatic symmetric function, examples of pairs of graphs with equal chromatic symmetric function have been generated using a result of Orellana and Scott. We reiterate it here and also prove that it extends to vertex-weighted graphs:

Theorem 9 ([36], Theorem 4.2). *Let (G, w) be a simple, vertex-weighted graph with distinct vertices v_1, v_2, v_3, v_4 such that*

- $v_1v_2, v_2v_3, v_3v_4 \in E(G)$, and $v_1v_3, v_1v_4, v_2v_4 \notin E(G)$.
- *There exists a w -automorphism f of $G \setminus v_2v_3$ such that $f(\{v_1, v_3\}) = \{v_2, v_4\}$ and $f(\{v_2, v_4\}) = \{v_1, v_3\}$.*

Then the graphs $G \cup v_1v_3$ and $G \cup v_2v_4$ have equal chromatic symmetric function.

Proof. Let $G_1 = G \cup v_1v_3$ and let $G_2 = G \cup v_2v_4$. By applying Lemma 7 to edges v_1v_3 of G_1 and v_2v_4 of G_2 , it suffices to show that $G_1 \dagger v_1v_3$ is w -isomorphic to $G_2 \dagger v_2v_4$.

The portions of these graphs induced by v_1, v_2, v_3, v_4 and their contractions are illustrated in Figure 3. It is clear from this figure that the automorphism f given by hypothesis induces a w -isomorphism of $G_1 \dagger v_1v_3$ and $G_2 \dagger v_2v_4$, so we are done. \square

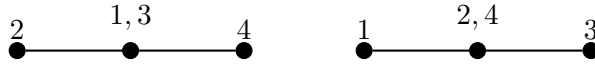

Figure 3: The portions of $G_1 \upharpoonright v_1v_3$ and $G_2 \upharpoonright v_2v_4$ induced by v_1, v_2, v_3, v_4 .

In addition to Lemma 8 and Theorem 9, we present one more method for constructing graphs with equal chromatic symmetric function. This method is inspired by the case $u = u'$ of Lemma 8, but can be used in slightly more general contexts and is more akin to Theorem 9.

Given a simple graph G and a vertex $v \in V(G)$, we define the *neighborhood* of v to be $N(v) = \{u \in V(G) : uv \in E(G)\}$ (note that $v \notin N(v)$).

Lemma 10. *Let (G, w) be a simple vertex-weighted graph, and let v_1, v_2, v_3 be distinct vertices of G satisfying*

- $v_1v_2 \in E(G)$, and $v_1v_3, v_2v_3 \notin E(G)$.
- $N(v_3) \subseteq N(v_1) \cap N(v_2)$.
- *There is a w -automorphism f of $G \setminus v_3$ such that $f(v_1) = v_2$ and $f(v_2) = v_1$.*

Then the graphs $G \cup v_1v_3$ and $G \cup v_2v_3$ have equal chromatic symmetric functions.

Proof. We let $e_1 = v_1v_3$ and $e_2 = v_2v_3$ be nonedges of G . By applying Lemma 7 to edge e_1 of $G \cup e_1$ and to edge e_2 of $G \cup e_2$, it suffices to show that $(G \upharpoonright e_1, w/e_1)$ and $(G \upharpoonright e_2, w/e_2)$ are w -isomorphic (and from now on, we suppress mention of the weight functions).

In what follows, we let u_1 be the contracted vertex (of weight 2) in $G \upharpoonright e_1$, and we let u_2 be the contracted vertex (of weight 2) in $G \upharpoonright e_2$. Furthermore, $G \upharpoonright e_1$ contains v_2 but not v_1 , and $G \upharpoonright e_2$ contains v_1 but not v_2 , and otherwise these graphs have the same vertex set, all of weight 1 except for u_1 or u_2 .

Let f be the w -automorphism of $G \setminus v_3$ that swaps v_1 and v_2 . We define the map $g : V(G \upharpoonright e_1) \rightarrow V(G \upharpoonright e_2)$ by $g(v) = f(v)$ if $v \neq u_1, v_2$, $g(u_1) = u_2$, and $g(v_2) = v_1$. Clearly this g is a w -isomorphism if it is an isomorphism. All edge and nonedge relations between vertices of $G \upharpoonright e_1$ other than u_1 and v_2 are preserved in $G \upharpoonright e_2$ by g since they were preserved by f , so it suffices to look at edges and nonedges involving u_1 and v_2 .

Let $G_1 = G \upharpoonright e_1$ and $G_2 = G \upharpoonright e_2$. Using the definition of contraction and the hypotheses we have

$$N_{G_1}(u_1) = N_G(v_1) \cup N_G(v_3) = N_G(v_1),$$

and

$$N_{G_2}(u_2) = N_G(v_2) \cup N_G(v_3) = N_G(v_2) = g(N_G(v_1))$$

so the neighborhood of u_1 is mapped to the neighborhood of u_2 by g . Additionally,

$$g(N_{G_1}(v_2)) = g(N_G(v_2)) = N_G(v_1) = N_{G_2}(v_1)$$

so the neighborhood of v_2 is mapped to the neighborhood of v_1 , and this concludes the proof. \square

6.3 Graphs with Equal XB

Relative to X_G , only a few examples of nonisomorphic graphs with equal Tutte symmetric functions are known. An example with a minimum number of vertices and edges is given by Markstrom [30]³. Additionally, Brylawski [7] uses the rotor-like graph given in Figure 4 to construct a family of graph pairs with arbitrarily high connectivity and equal Tutte symmetric function⁴.

We modify Brylawski's result to construct graph pairs with arbitrarily high girth and equal Tutte symmetric function.

Theorem 11. *Let $k > 2$ be a positive integer, and let (G, w) be a (not necessarily simple) vertex-weighted graph with distinct vertices a, b , and c such that there exists a w -automorphism f of (G, w) satisfying $f(a) = b, f(b) = c$, and $f(c) = a$. Modify the graph (G, w) by replacing every edge with an unweighted path of length k (that is, for each edge $u_1u_2 = e \in E(G)$, delete e , add weight-1 vertices e_1, \dots, e_{k-1} to G , and add edges $u_1e_1, e_1e_2, \dots, e_{k-1}u_2$ to G). Then construct the vertex-weighted graphs (G_1, w) and (G_2, w) by retaining the weight function w and setting*

- $V(G_1) = V(G_2) = V(G) \cup \{v_1, v_2, \dots, v_{k-1}, x_1, x_2, \dots, x_k\}$ (where these vertices all have weight 1),
- $E(G_1) = E(G) \cup \{av_1, v_1v_2, \dots, v_{k-1}b, bx_1, x_1x_2, \dots, x_kc\}$,
- $E(G_2) = E(G) \cup \{av_{k-1}, v_{k-1}v_{k-2}, \dots, v_1c, cx_1, x_1x_2, \dots, x_kb\}$.

Then

$$XB_{(G_1, w)} = XB_{(G_2, w)}.$$

Proof. Note that the modified version of G still admits f as a w -automorphism with $f(a) = b, f(b) = c$, and $f(c) = a$ by extending its definition to the newly formed vertices. We apply Lemma 7 to the edges bx_1 of (G_1, w) and cx_1 of (G_2, w) . We may check that the graph $(G_1 \setminus bx_1, w)$ is w -isomorphic to $(G_2 \setminus cx_1, w)$ by extending f to a map $f : V(G_1) \rightarrow V(G_2)$ and defining $f(v_i) = v_i$ and $f(x_i) = x_i$ for all appropriate i , and verifying that f^2 is the desired w -isomorphism. Likewise, if we instead define $f(v_i) = x_{k-i+1}$ and $f(x_i) = v_{i-1}$, we may verify that f is a w -isomorphism from $(G_1/bx_1, w/bx_1)$ to $(G_2/cx_1, w/cx_1)$ upon also letting f map the vertex formed by contraction in G_1 to the vertex formed by contraction in G_2 , and this concludes the proof. \square

Thus, we may use Theorem 11 to construct pairs of (unweighted) graphs of arbitrarily high girth with equal Tutte symmetric function given a single graph G such that the resulting graphs G_1 and G_2 are always nonisomorphic. It is straightforward to verify

³The example of [30] is also Example 259 of the authors' list of pairs of graphs with equal chromatic symmetric function [11].

⁴This construction depends in part on the fact that the Tutte symmetric function of a simple graph G uniquely determines that of G 's complement. This fact is not obvious from the definition of XB , but is clear from the definition of the equivalent polychromate.

that the graph of Brylawski as given in Figure 4 is one such example. This construction is particularly noteworthy since there has not previously been shown even triangle-free graphs with the same chromatic symmetric function!

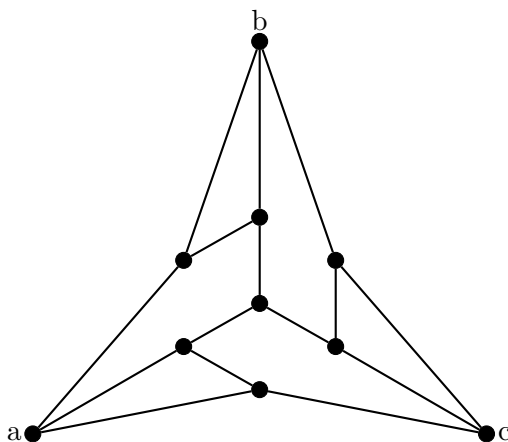

Figure 4: A graph G giving rise to nonisomorphic graphs G_1 and G_2 with the same Tutte symmetric functions and arbitrarily large girth.

We also give two pairs of small graphs with equal Tutte symmetric functions that do not fit the requirements of Theorem 11. In the figures that follow, the numbers next to the vertices are labels rather than weights, so that graphs can be redrawn to illustrate isomorphisms. Vertex weights from an edge contraction will be denoted by simply listing each original vertex label that corresponds to a vertex formed by edge contraction.

First, we consider the graphs shown in Figure 5.

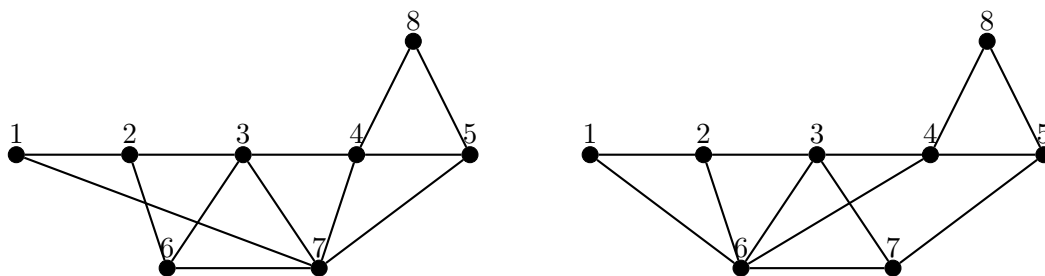

Figure 5: Graphs G_1 and G_2 with equal XB .

Let the graph on the left be called G_1 , and the graph on the right G_2 . First, note the graphs are indeed nonisomorphic, since for example G_1 has the vertex 1 with degree two that is not part of a triangle, but in G_2 both vertices of degree two are in triangles.

To show that these graphs have the same Tutte symmetric function, we apply Lemma 7 to the edge $(6, 7)$ in both graphs, and reduce to showing that the edge-deleted graphs

are w -isomorphic, and the edge-contracted graphs are w -isomorphic. It is easy to verify that both edge-contracted graphs are isomorphic to the graph in Figure 6.

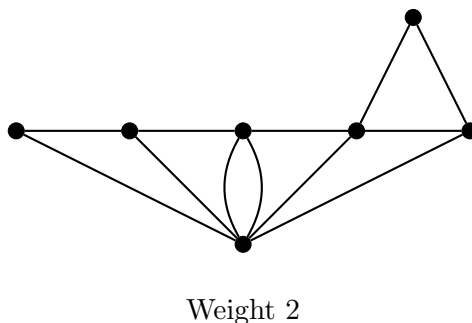

Figure 6: The graph formed by contracting $(6, 7)$ in G_1 or G_2 .

To see that the edge-deleted graphs are isomorphic, take the first graph, delete the edge $(6, 7)$ and then rearrange the vertices as in Figure 7.

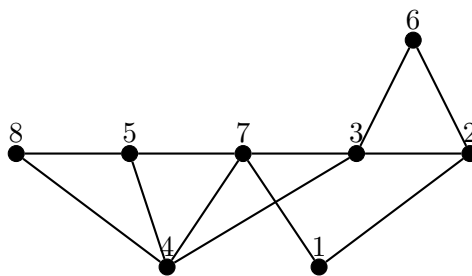

Figure 7: G_1 with the edge $(6, 7)$ deleted.

Using this figure, it is easy to see that $G_1 \setminus (6, 7)$ is w -isomorphic to $G_2 \setminus (6, 7)$, and this shows that the graphs G_1 and G_2 have equal Tutte symmetric functions.

For a second example, we consider the graphs in Figure 8 (with the edges highlighted in red that we will apply Lemma 7). Let the graph on the top of this figure be H_1 , and the graph on the bottom be H_2 .

First, we verify that H_1 and H_2 are nonisomorphic. Both graphs have exactly two vertices of degree 2, namely vertices 5 and 7 in H_1 and vertices 5 and 1 in H_2 . However, in H_2 these two vertices have a common neighbor, as they are both adjacent to 8, but the corresponding vertices do not have a common neighbor in H_1 .

To show that H_1 and H_2 nonetheless have equal Tutte symmetric function, we apply Lemma 7 to the edges marked in red in Figure 8. Clearly the graphs with these edges deleted are isomorphic. The contracted graphs are shown in Figure 9.

The graphs in Figure 9 are not w -isomorphic, but it suffices to show that they have equal XB , which also provides an example of a pair of non-trivially weighted graphs with

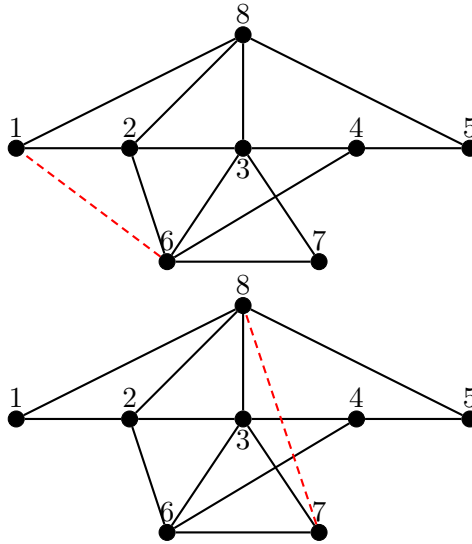

Figure 8: Graphs H_1 and H_2 with nonequal XB .

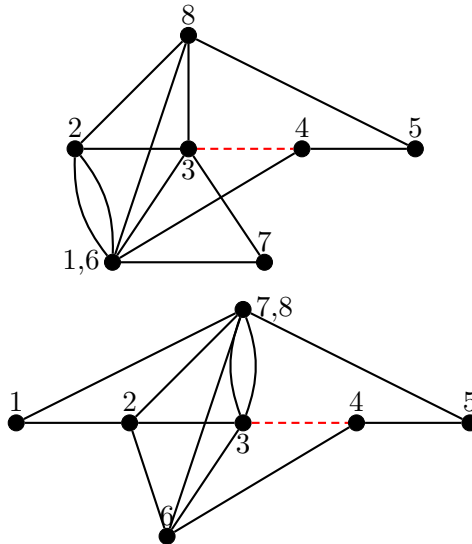

Figure 9: H_1 and H_2 after contraction.

equal Tutte symmetric function. To do so, we again apply Lemma 7. First, in this figure, we rearrange the top graph $H_1/(1,6)$ into the graph in Figure 10.

Clearly now the graphs in Figure 9 are w -isomorphic with the red edges deleted. We show that they are also w -isomorphic with the red edges contracted. Those graphs correspond to H_1 and H_2 with two edges contracted and are shown in Figure 11.

To illustrate that the two graphs in Figure 11 are w -isomorphic, we redraw the top graph as shown in Figure 12, making the w -isomorphism apparent.

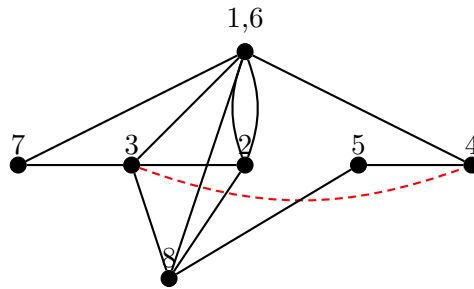

Figure 10: $H_1/(1, 6)$ rearranged.

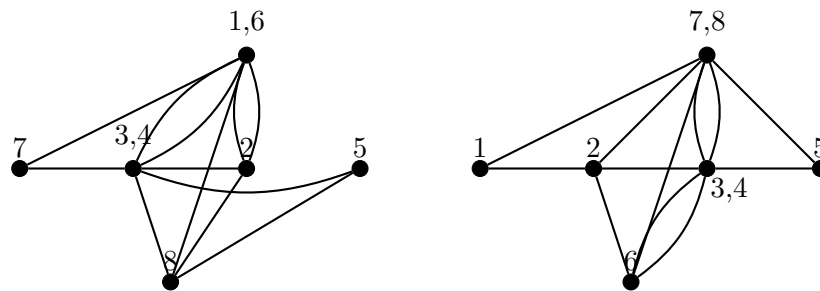

Figure 11: H_1 and H_2 with two edges contracted.

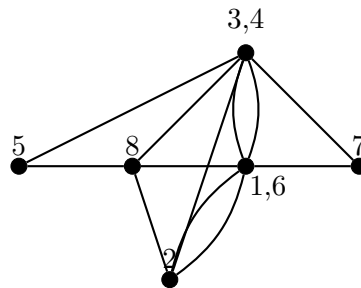

Figure 12: H_1 with two edges contracted rearranged.

7 Further Constructions via the W -polynomial

In [13], the second and third authors noted that vertex-weighted trees are not always distinguished by their chromatic symmetric functions, but the counterexample given in that paper had trees that were isomorphic when unweighted. Other examples of vertex-weighted paths with the same chromatic symmetric function appear in [28]. In this section we will develop an algebraic method to construct vertex-weighted graphs with the same W -polynomial; by Lemma 4 this method also yields vertex-weighted graphs with the same XB . The method extends some of the constructions in [4] by the first and fourth authors.

In an independent work [2], Aliniaiefard, Wang and van Willigenburg obtained results similar to the ones presented in this section, but written completely in the language of symmetric functions.

A *2-pointed vertex-weighted graph* is a tuple (G, w, s, t) , where (G, w) is a vertex-weighted graph, and s and t are (possibly the same) vertices of G . When w, s , and t are clear, we will often just write G in a slight abuse of notation. Given two 2-pointed vertex-weighted graphs (G, w, s, t) and (H, w', s', t') , define $(G, w, s, t) \cdot (H, w', s', t') = (G \cdot H, w \cdot w', s, t')$, where $G \cdot H$ is the graph formed by taking the disjoint union of G and H and then adding an edge between t and s' , and the weight function $w \cdot w'$ assigns to each vertex the weight it had in G or H . Second, define $(G, w, s, t) \odot (H, w', s', t')$ as the 2-pointed vertex-weighted graph $(G \odot H, w \odot w', s, t')$ where $G \odot H = (G \cdot H)/e$ where e is the edge connecting t and s' , and $w \odot w' = (w \cdot w')/e$. Finally, if (G, w, s, t) is a 2-pointed vertex-weighted graph, its *reversal* is the 2-pointed vertex-weighted graph (G, w, t, s) . When simply using G as shorthand to denote (G, w, s, t) , we will write G^* to denote its reversal.

An *integer composition* is a sequence $\beta = \beta_1\beta_2 \dots \beta_k$ where each β_i is positive. Given a composition β , its reversal β^* is the composition $\beta_k\beta_{k-1} \dots \beta_1$. Given two compositions α and β , we say that $\beta \geq \alpha$ if β can be obtained by adding consecutive elements of α , e.g. $4\ 5 \geq 1\ 2\ 1\ 3\ 2$. Clearly this forms a partial order on integer compositions.

Given two compositions $\beta = \beta_1 \dots \beta_k$ and $\beta' = \beta'_1 \dots \beta'_{k'}$, define $\beta \cdot \beta'$ to be the integer composition $\beta_1 \dots \beta_k \beta'_1 \dots \beta'_{k'}$ and $\beta \odot \beta'$ to be the integer composition $\beta_1 \dots \beta_{k-1}(\beta_k + \beta'_1)\beta'_2 \dots \beta'_{k'}$. Given a composition $\beta = \beta_1\beta_2 \dots \beta_l$, we associate to it the 2-pointed vertex-weighted path $P_\beta = (P, w, s, t)$ where $P = v_1v_2 \dots v_l$, $w(v_i) = \beta_i$ for each i and $s = v_1$ and $t = v_l$. It is not difficult to check that $P_{\beta \cdot \beta'} = P_\beta \cdot P_{\beta'}$ and $P_{\beta \odot \beta'} = P_\beta \odot P_{\beta'}$. The \mathcal{L} -polynomial of β , introduced in [4], is defined by

$$\mathcal{L}_\beta(\mathbf{x}) = \sum_{\gamma \geq \beta} \mathbf{x}_{\lambda(\gamma)},$$

where \mathbf{x} is shorthand for the variables x_1, x_2, \dots , $\lambda(\gamma)$ denotes the partition obtained from γ after reordering its elements and $\mathbf{x}_\lambda = x_{\lambda_1}x_{\lambda_2} \dots x_{\lambda_l}$ if λ has length l .

Lemma 12. *The following statements hold:*

1. *Given two 2-pointed vertex-weighted graphs (G, w, s, t) and (H, w', s', t') , we have*

$$W_{G \cdot H}(\mathbf{x}, y) = W_G(\mathbf{x}, y)W_H(\mathbf{x}, y) + W_{G \odot H}(\mathbf{x}, y). \quad (18)$$

2. *For every composition β we have*

$$W_{P_\beta}(\mathbf{x}, y) = \mathcal{L}_\beta(\mathbf{x})$$

3. *Given two compositions β and β' , we have*

$$\mathcal{L}_{\beta \cdot \beta'} = \mathcal{L}_\beta \mathcal{L}_{\beta'} + \mathcal{L}_{\beta \odot \beta'}. \quad (19)$$

Proof. The first assertion follows directly from applying deletion-contraction to $G \cdot H$ and the edge e connecting t with s' and the definitions of \cdot and \odot .

For the second assertion, we proceed by induction on the length of β . The base case follows easily, since if $\beta = \beta_1$, then $\mathcal{L}_\beta(\mathbf{x}) = x_{\beta_1}$, which is the same as the W -polynomial of an isolated vertex with weight β_1 . For the inductive step, we suppose that the assertion holds for compositions of length n and let $\beta = \beta' \circ \beta_{n+1}$ be any integer composition of length $n + 1$, where β' is a composition of length n . It is easy to check that $\beta' \odot \beta_{n+1} \geq \beta'$ and that if $\gamma \geq \beta$ but $\gamma \not\geq \beta' \odot \beta_{n+1}$, then $\gamma = \gamma' \circ \beta_{n+1}$ where $\gamma' \geq \beta'$. Thus

$$\mathcal{L}_\beta(\mathbf{x}) = \sum_{\gamma \geq \beta} x_{\lambda(\gamma)} = \sum_{\gamma \geq \beta' \odot \beta_{n+1}} x_{\lambda(\gamma)} + \sum_{\gamma' \geq \beta'} x_{\lambda(\gamma' \circ \beta_{n+1})} = \mathcal{L}_{\beta' \odot \beta_{n+1}}(\mathbf{x}) + \mathcal{L}_{\beta'}(\mathbf{x})x_{\beta_{n+1}}.$$

Hence, by the induction hypothesis, we get from the last equality

$$\mathcal{L}_\beta(\mathbf{x}) = W_{P_{\beta' \odot \beta_{n+1}}}(\mathbf{x}, y) + W_{P_{\beta'}}(\mathbf{x}, y)W_{P_{\beta_{n+1}}}(\mathbf{x}, y) = W_{P_\beta}(\mathbf{x}, y),$$

where the last equality follows from (18). This finishes the proof of the second assertion. The third assertion is a direct consequence of the previous two assertions. \square

Next, we will see how to use this lemma to construct arbitrarily large families of vertex-weighted trees with the same W -polynomial by gluing together several copies of a seed graph. For a 2-pointed vertex-weighted graph G , we denote the graph $G \cdot G \cdot \dots \cdot G$ by G^i and the graph $G \odot G \odot \dots \odot G$ by $G^{\odot i}$ (in each definition the graph G is repeated i times).

If G a 2-pointed vertex-weighted graph and β is an integer composition, then define

$$\beta \circ G := G^{\odot \beta_1} \cdot G^{\odot \beta_2} \cdot \dots \cdot G^{\odot \beta_k}.$$

Similarly, if γ is another integer composition, we can define

$$\beta \circ \gamma := \gamma^{\odot \beta_1} \cdot \gamma^{\odot \beta_2} \cdot \dots \cdot \gamma^{\odot \beta_k}.$$

It is not difficult to check that $\beta \circ P_\gamma = P_{\beta \circ \gamma}$ and that

$$(\alpha * \beta) \circ \gamma = (\alpha \circ \gamma) * (\beta \circ \gamma), \tag{20}$$

where α, β are compositions, γ can be either a 2-pointed vertex-weighted graph or a composition, and $*$ may be either \cdot or \odot .

Lemma 13. *The operation \circ in the set of integer compositions is associative. Moreover, if (G, w, s, t) is a 2-pointed vertex-weighted graph and α and β are integer compositions, then*

$$(\alpha \circ \beta) \circ G = \alpha \circ (\beta \circ G).$$

Proof. The associativity of \circ for integer compositions is shown in [6, Proposition 3.3]. The second assertion will be shown by induction on the length of α . If $\alpha = \alpha_1$, then

$$\alpha_1 \circ (\beta \circ G) = (\beta \circ G)^{\odot \alpha_1} = (G^{\odot \beta_1} \cdot \dots \cdot G^{\odot \beta_k})^{\odot \alpha_1}$$

$$\begin{aligned}
&= (G^{\odot\beta_1} \dots G^{\odot\beta_k}) \odot (G^{\odot\beta_1} \dots G^{\odot\beta_k}) \odot \dots \odot (G^{\odot\beta_1} \dots G^{\odot\beta_k}) \\
&= G^{\odot\beta_1} \dots G^{\odot\beta_k} \odot G^{\odot\beta_1} \dots G^{\odot\beta_k} \odot \dots \odot G^{\odot\beta_1} \dots G^{\odot\beta_k} \\
&= G^{\odot\beta_1} \dots G^{\odot\beta_{k-1}} \cdot (G^{\odot\beta_k+\beta_1} \cdot G^{\odot\beta_2} \dots G^{\odot\beta_{k-1}})^{\alpha_1-1} G^{\odot\beta_k} \\
&= \left(\beta_1 \cdots \beta_{k-1} ((\beta_k + \beta_1)\beta_2 \cdots \beta_{k-1})^{\alpha_1-1} \beta_k \right) \circ G = (\alpha_1 \circ \beta) \circ G,
\end{aligned}$$

which shows the base case. For the inductive step, given any composition α of length l , we may write it as $\alpha = \alpha' \alpha_l$ where α' is a composition of length $l - 1$. By applying (20), we get

$$(\alpha' \alpha_l) \circ (\beta \circ G) = (\alpha' \circ (\beta \circ G)) \cdot (\alpha_l \circ (\beta \circ G)).$$

By applying the induction hypothesis twice and then (20) again, the expression in the right hand side of the last equation becomes

$$((\alpha' \circ \beta) \circ G) \cdot ((\alpha_l \circ \beta) \circ G) = ((\alpha' \circ \beta) \cdot (\alpha_l \circ \beta)) \circ G = (\alpha \circ \beta) \circ G.$$

This finishes the induction, and hence the proof. \square

The utility of the \circ operation is that the W -polynomial of $\beta \circ G$ can be computed in terms of the \mathcal{L} -polynomial of β and the W -polynomial of G .

Theorem 14. *Let (G, w, s, t) be a 2-pointed vertex-weighted graph and β a composition. We have*

$$W_{\beta \circ G}(\mathbf{x}, y) = \mathcal{L}_\beta(x_i \mapsto W_{G^{\odot i}}(\mathbf{x}, y)) \quad (21)$$

Proof. We do the proof by induction on the length l of β . For the base case, assume $l = 1$ and check that $\beta \circ G = G^{\odot\beta_1}$ and $\mathcal{L}_\beta(x) = x_{\beta_1}$. Thus, substituting $x_{\beta_1} \mapsto W_{G^{\odot\beta_1}}(\mathbf{x}, y)$ yields the assertion when $l = 1$.

Now, using the inductive hypothesis, we will assume that the assertion holds for all compositions of length k and consider $\beta = \beta' \beta_{k+1}$, where $\beta' = \beta_1 \dots \beta_k$. By the definition of \circ , we have

$$\beta \circ G = (\beta' \circ G) \cdot (\beta_{k+1} \circ G).$$

thus, applying (18) yields

$$W_{\beta \circ G}(\mathbf{x}, y) = W_{\beta' \circ G}(\mathbf{x}, y) W_{\beta_{k+1} \circ G}(\mathbf{x}, y) + W_{(\beta' \circ G) \odot (\beta_{k+1} \circ G)}(\mathbf{x}, y). \quad (22)$$

It is easy to check that $(\beta' \circ G) \odot (\beta_{k+1} \circ G) = (\beta' \odot \beta_{k+1}) \circ G$. On the other hand, by the induction hypothesis,

$$\begin{aligned}
W_{\beta' \circ G}(\mathbf{x}, y) &= \mathcal{L}_{\beta'}(x_i \mapsto W_{G^{\odot i}}(\mathbf{x}, y)), \\
W_{\beta_{k+1} \circ G}(\mathbf{x}, y) &= \mathcal{L}_{\beta_{k+1}}(x_i \mapsto W_{G^{\odot i}}(\mathbf{x}, y))
\end{aligned}$$

and

$$W_{(\beta' \odot \beta_{k+1}) \circ G}(\mathbf{x}, y) = \mathcal{L}_{(\beta' \odot \beta_{k+1})}(x_i \mapsto W_{G^{\odot i}}(\mathbf{x}, y)).$$

Combining these into (22), we get

$$W_{\beta \circ G}(\mathbf{x}, y) = (\mathcal{L}_{\beta'} \mathcal{L}_{\beta_{k+1}} + \mathcal{L}_{\beta' \odot \beta_{k+1}})(x_i \mapsto W_{G^{\odot i}}(\mathbf{x}, y)) \quad (23)$$

and thence the assertion follows by applying (19) to the last equation. \square

Corollary 15. *Let β be an integer composition and (G, w, s, t) be a 2-pointed vertex-weighted graph. Then for every composition γ such that $\mathcal{L}_\gamma = \mathcal{L}_\beta$ we have*

$$W_{\beta \circ G}(\mathbf{x}, y) = W_{\gamma \circ G}(\mathbf{x}, y).$$

This motivates us to characterize the class of compositions with the same \mathcal{L} -polynomial as a given composition. This characterization was obtained in [6] in the language of ribbon Schur functions and later recast in [4] to the language we are using here. If a composition β is written in the form $\beta_1 \circ \beta_2 \circ \cdots \circ \beta_k$, then we call this a *factorization* of β . We say that the factorization $\beta = \beta_1 \circ \beta_2$ is *trivial* if any of the following conditions hold:

1. one of β_1, β_2 are equal to 1,
2. the lengths of β_1 and β_2 are both equal to 1,
3. the compositions β_1 and β_2 both have all parts equal to 1.

A factorization $\beta = \beta_1 \circ \cdots \circ \beta_k$ is *irreducible* if no $\beta_i \circ \beta_{i+1}$ is a trivial factorization, and each β_i admits only trivial factorizations. In this case, each β_i is called an *irreducible factor*.

Theorem 16 ([6, 4]). *The irreducible factorization of any integer composition is unique. Moreover if $\beta = \beta_1 \circ \beta_2 \circ \cdots \circ \beta_l$ and $\gamma = \gamma_1 \circ \gamma_2 \circ \cdots \circ \gamma_k$ are two compositions with given irreducible factorizations, then β and γ have the same \mathcal{L} -polynomial if and only if*

$$l = k \quad \text{and} \quad \gamma_i \in \{\beta_i, \beta_i^*\} \text{ for all } i \text{ in } \{1, \dots, k\}.$$

Remark 17. By the second assertion of Lemma 4 and (12) and the fact that X can be recovered from XB by setting $t = -1$ (which is equivalent to setting $y = 0$ in the W -polynomial) we check that substituting each variable x_i by $-p_i$ in \mathcal{L}_β yields the weighted chromatic symmetric function of P_β . On the other hand, if we substitute each variable x_i by $-h_i$, where h_i is the i -th complete homogeneous symmetric function, we obtain the ribbon Schur function associated with β . It follows that the homomorphism U of Λ defined by sending each p_λ to h_λ and then extending linearly transforms the chromatic symmetric function of the weighted path P_β into the the ribbon Schur function associated with β . This observation is implicit in [4] and the morphism U is studied in detail in [2].

Combining Corollary 15 and Theorem 16 we get

Corollary 18. *Let (G, w, s, t) be a 2-pointed weighted graph and β an integer composition. Suppose we have an irreducible factorization $\beta = \beta_1 \circ \beta_2 \circ \cdots \circ \beta_k$. Then, all vertex-weighted graphs in the set*

$$\text{Sym}(\beta \circ G) = \{\gamma_1 \circ \gamma_2 \circ \cdots \circ \gamma_i \circ G \mid \text{for each } i, \gamma_i \in \{\beta_i, \beta_i^*\}\}$$

have the same W -polynomial as $\beta \circ G$.

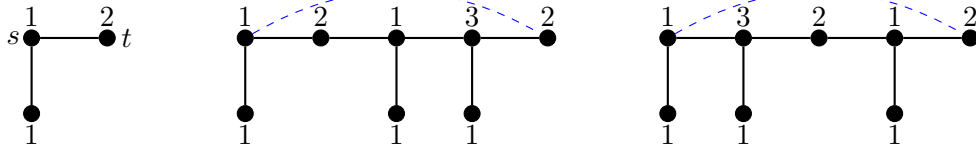

Figure 13: The seed tree T , and the trees $12 \circ T$ and $21 \circ T$. The latter two trees have the same W -polynomial (the dashed line is a non-edge).

Finally, we apply these results to give two examples of weighted trees with the same W -polynomial (and hence Tutte symmetric function). For the first example we consider the 2-pointed vertex-weighted tree T depicted in Figure 13 and the composition $\beta = 12$. Then, it follows that the weighted trees $\beta \circ T$ and $\beta^* \circ T$ have the same W -polynomial but they are not w -isomorphic. In fact, they are not even isomorphic as unweighted trees. These trees are also shown in Figure 13. However, in this case, there is an alternate way of checking that the trees have the same W -polynomial: It may be checked that the graphs are w -isomorphic when adding the dashed non-edge and when contracting the dashed non-edge, so it follows from Lemma 7. Our construction can also be used to obtain a more complicated pair of examples (that cannot be constructed by the direct use of deletion-contraction operations). Consider $\beta \circ T$ and $\gamma \circ T$ where T is the same 2-pointed vertex-weighted tree depicted in Figure 13, $\beta = 12132 = 12 \circ 12$ and $\gamma = 13212 = 21 \circ 12$. By applying Corollary 15 we see that these weighted trees have the same W -polynomial, but clearly they are not w -isomorphic; they are depicted in Figure 14.

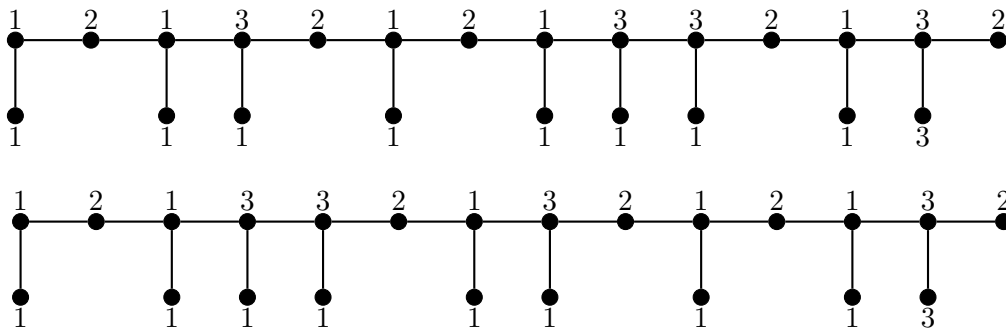

Figure 14: Weighted trees with the same Tutte symmetric function.

8 Further Research

We conclude with some data and further possible considerations for research.

Using deletion-contraction relations, we computed X_G and XB_G for simple graphs with at most 8 vertices using data provided by [32]. We found many pairs of such graphs with equal chromatic symmetric function, and for all of these pairs we also determined whether the graphs are distinguished by XB . This information and more may be viewed at [11].

We find that triangles seem to play an important role in graphs with equal chromatic symmetric function. Note that in the 1000 pairs of graphs with equal chromatic symmetric function noted in [11], every graph contains a triangle. Furthermore, each of the three methods given in Sections 5.1 and 5.2 for constructing graphs with equal chromatic symmetric function always produces a pair of graphs containing triangles. In the case of Lemma 8 and Theorem 9 this is explicit. In the case of Lemma 10, suppose that we have a graph G satisfying the assumptions of the lemma. If $N(v_3) = \emptyset$, then $G \cup v_1v_3$ is isomorphic to $G \cup v_2v_3$ since by assumption there is an automorphism of $G \setminus v_3$ swapping v_1 and v_2 . If there is a vertex $x \in N(v_3)$, then by assumption also $x \in N(v_1)$ and $x \in N(v_2)$, so in $G \cup v_1v_3$ there is a triangle with vertices v_1, v_3, x and in $G \cup v_2v_3$ there is a triangle with vertices v_2, v_3, x . Thus, every G satisfying the conditions of Lemma 10 either produces two isomorphic graphs, or two graphs with equal chromatic symmetric function that both contain triangles. Finally, we also note the recent result of Penaguiao [39] showing that given any two nonisomorphic graphs with equal chromatic symmetric function, one may be transformed into the other by a finite number of applications of the triangular modular relation of Orellana and Scott [36].

Indeed, prior to the discovery of the construction given in Section 6.3, the authors considered whether triangle-free graphs may be distinguished by the chromatic symmetric function! It would be useful if it could be demonstrated an explicit sequence of applications of the modular relation of [36] that takes these triangle-free graphs to each other. As far as distinguishing graphs goes, the next logical question is to determine whether there are bipartite graphs with equal chromatic symmetric function.

The spanning tree formula (17) for the chromatic symmetric function is new, and may be useful to ongoing research. Furthermore, the sum runs over those spanning trees of a graph G with no external activity. It is worth noting that the number of this particular kind of spanning tree in a graph G is equal to the number of G -parking functions with respect to any vertex, and the number of acyclic orientations of G with exactly one sink [5]. It would be interesting to see if there are similar expansions to (17) that run over one of these sets.

Additionally, there is an expansion of the Tutte polynomial as a sum over G -parking functions given in [8] as

$$T_G(x, y) = \sum_f x^{cb(f)} y^{w(f)}$$

where $cb(f)$ is the number of critical bridge vertices of G with respect to f (as defined in [8]), and $w(f) = |E(G)| - |V(G)| - \sum_{v \in V(G)} f(v)$. In the same way that the spanning tree formula (15) for XB is an extension of a similar formula for T_G , perhaps there is a natural formula for XB that extends this G -parking function expansion of T_G .

Finally, there appear to be many rich, unexplored connections between the Tutte symmetric function and other functions derived from the V -polynomial. For example, one can use a specialization of the V -polynomial as a natural list-coloring polynomial [20]. It would be interesting to see if the Tutte symmetric function could be modified to consider this or other V -polynomial specializations.

Acknowledgments

The authors would like to thank Jo Ellis-Monaghan for telling us about the V -polynomial, Martin Loeb1 for discussions about the split graph construction and the U -polynomial, and Steve Noble, Bruce Sagan, Darij Grinberg, Steph van Willigenburg, Farid Aliniaiefard and Victor Wang for many helpful comments. We would like to thank the anonymous referee for their thoughtful comments and suggestions.

The authors would also like to acknowledge Brendan McKay’s webpage of combinatorial data [32]. Its database of graphs and trees has been a valuable resource for creating and testing our conjectures, and was helpful for creating [11].

The first version of this article did not contain the results of Section 7. While working on this version of the article, the authors became aware of the independent work [2].

This material is based upon work supported by the National Science Foundation under Award No. DMS-1802201. We acknowledge the support of the Natural Sciences and Engineering Research Council of Canada (NSERC), [funding reference number RGPIN-2020-03912]. J.A.-P. and J.Z. acknowledge support from CONICYT FONDECYT REGULAR 1160975.

References

- [1] Per Alexandersson and Greta Panova. LLT polynomials, chromatic quasisymmetric functions and graphs with cycles. *Discrete Mathematics*, 341(12):3453–3482, 2018.
- [2] Farid Aliniaiefard, Victor Wang, and Stephanie van Willigenburg. Extended chromatic symmetric functions and equality of ribbon Schur functions. [arXiv:2010.00147](https://arxiv.org/abs/2010.00147), 2020.
- [3] José Aliste-Prieto, Anna de Mier, and José Zamora. On trees with the same restricted U -polynomial and the Prouhet–Tarry–Escott problem. *Discrete Mathematics*, 340(6):1435–1441, 2017.
- [4] José Aliste-Prieto and José Zamora. Proper caterpillars are distinguished by their chromatic symmetric function. *Discrete Mathematics*, 315:158–164, 2014.
- [5] Brian Benson, Deeparnab Chakrabarty, and Prasad Tetali. G -parking functions, acyclic orientations and spanning trees. *Discrete Mathematics*, 310(8):1340–1353, 2010.
- [6] Louis J Billera, Hugh Thomas, and Stephanie van Willigenburg. Decomposable compositions, symmetric quasisymmetric functions and equality of ribbon Schur functions. *Advances in Mathematics*, 204(1):204–240, 2006.
- [7] Tom Brylawski. Intersection theory for graphs. *Journal of Combinatorial Theory, Series B*, 30(2):233–246, 1981.
- [8] Hungyung Chang, Jun Ma, and Yeong-Nan Yeh. Tutte polynomials and G -parking functions. *Advances in Applied Mathematics*, 44(3):231–242, 2010.

- [9] Soojin Cho and JiSun Huh. On e -positivity and e -unimodality of chromatic quasi-symmetric functions. *SIAM Journal on Discrete Mathematics*, 33(4):2286–2315, 2019.
- [10] Timothy Y Chow. Symmetric function generalizations of graph polynomials. *MIT PhD Diss.*, 1995.
- [11] Logan Crew and Sophie Spirkl. Examples of pairs of small graphs with equal chromatic symmetric function. <https://sites.google.com/site/ltcrewmath/exampl.pdf>, 2019.
- [12] Logan Crew and Sophie Spirkl. A complete multipartite basis for the chromatic symmetric function. [arXiv:2009.14141](https://arxiv.org/abs/2009.14141), 2020.
- [13] Logan Crew and Sophie Spirkl. A deletion–contraction relation for the chromatic symmetric function. *European Journal of Combinatorics*, 89:103143, 2020.
- [14] Logan Crew and Sophie Spirkl. Modular relations of the Tutte symmetric function. [arXiv:2103.06335](https://arxiv.org/abs/2103.06335), 2021.
- [15] Samantha Dahlberg, Adrian She, and Stephanie van Willigenburg. Schur and e -positivity of trees and cut vertices. *Electronic Journal of Combinatorics*, 27(1), 2020.
- [16] Samantha Dahlberg and Stephanie van Willigenburg. Lollipop and lariat symmetric functions. *SIAM Journal on Discrete Mathematics*, 32(2):1029–1039, 2018.
- [17] Samantha Dahlberg and Stephanie van Willigenburg. Chromatic symmetric functions in noncommuting variables revisited. *Advances in Applied Mathematics*, 112:101942, 2020.
- [18] Joanna A Ellis-Monaghan and Criel Merino. Graph polynomials and their applications i: The Tutte polynomial. In *Structural analysis of complex networks*, pages 219–255. Springer, 2011.
- [19] Joanna A Ellis-Monaghan and Iain Moffatt. The Tutte–Potts connection in the presence of an external magnetic field. *Advances in Applied Mathematics*, 47(4):772–782, 2011.
- [20] Joanna A Ellis-Monaghan and Iain Moffatt. A note on recognizing an old friend in a new place: list coloring and the zero-temperature Potts model. *Annales de l’institut Henri Poincaré D*, 1:429–442, 2015.
- [21] Joanna A Ellis-Monaghan and Iain Moffatt (editors). *Handbook of the Tutte polynomial*. Chapman & Hall/CRC Press, to appear.
- [22] Brittney Ellzey. A directed graph generalization of chromatic quasisymmetric functions. [arXiv:1709.00454](https://arxiv.org/abs/1709.00454), 2017.
- [23] Angèle M Foley, Chinh T Hoàng, and Owen D Merkel. Classes of graphs with e -positive chromatic symmetric function. *Electronic Journal of Combinatorics*, 26.3:#P3–51, 2019.
- [24] David D Gebhard and Bruce E Sagan. A chromatic symmetric function in noncommuting variables. *Journal of Algebraic Combinatorics*, 13(3):227–255, 2001.

- [25] Peter L Hammer and Stéphane Földes. Split graphs. *Congressus Numerantium*, 19:311–315, 1977.
- [26] Sam Heil and Caleb Ji. On an algorithm for comparing the chromatic symmetric functions of trees. *Australasian Journal of Combinatorics*, 75.2:210–222, 2019.
- [27] Martin Klazar, Martin Loeb, and Iain Moffatt. The Potts model and chromatic functions of graphs. *Annales de l’institut Henri Poincaré D*, 1.1:47–60, 2014.
- [28] Martin Loeb and Jean-Sébastien Sereni. Isomorphism of weighted trees and Stanley’s conjecture for caterpillars. *Annales de l’institut Henri Poincaré D*, 6.3:357–384, 2019.
- [29] Ian Grant Macdonald. *Symmetric functions and Hall polynomials*. Oxford University Press, 1998.
- [30] Klas Markström. From the Ising and Potts models to the general graph homomorphism polynomial. In *Graph Polynomials*, pages 123–138. Chapman and Hall/CRC, 2016.
- [31] Leslie M McDonald and Iain Moffatt. On the Potts model partition function in an external field. *Journal of Statistical Physics*, 146(6):1288–1302, 2012.
- [32] Brendan McKay. Combinatorial data. <https://users.cecs.anu.edu.au/~bdm/data/>.
- [33] Criel Merino and Steven D. Noble. The equivalence of two graph polynomials and a symmetric function. *Combinatorics, Probability and Computing*, 18(4):601–615, 2009.
- [34] Steven D. Noble. Evaluating a weighted graph polynomial for graphs of bounded tree-width. *The Electronic Journal of Combinatorics*, pages R64–R64, 2009.
- [35] Steven D. Noble and Dominic J. A. Welsh. A weighted graph polynomial from chromatic invariants of knots. In *Annales de l’institut Fourier*, volume 49, pages 1057–1087, 1999.
- [36] Rosa Orellana and Geoffrey Scott. Graphs with equal chromatic symmetric functions. *Discrete Mathematics*, 320:1–14, 2014.
- [37] Alexander Paunov. Planar graphs and Stanley’s chromatic functions. [arXiv:1702.05787](https://arxiv.org/abs/1702.05787), 2017.
- [38] Brendan Pawlowski. Chromatic symmetric functions via the group algebra of S_n . [arXiv:1802.05470](https://arxiv.org/abs/1802.05470), 2018.
- [39] Raul Penaguiao. The kernel of chromatic quasisymmetric functions on graphs and hypergraphic polytopes. *Journal of Combinatorial Theory, Series A*, 175:105258, 2020.
- [40] Irasema Sarmiento. The polychromate and a chord diagram polynomial. *Annals of Combinatorics*, 4(2):227–236, 2000.
- [41] John Shareshian and Michelle L Wachs. Chromatic quasisymmetric functions. *Advances in Mathematics*, 295:497–551, 2016.

- [42] Richard P Stanley. A symmetric function generalization of the chromatic polynomial of a graph. *Advances in Mathematics*, 111(1):166–194, 1995.
- [43] Richard P Stanley. Graph colorings and related symmetric functions: ideas and applications a description of results, interesting applications, & notable open problems. *Discrete Mathematics*, 193(1-3):267–286, 1998.
- [44] Richard P Stanley and S Fomin. Enumerative combinatorics. vol. 2, volume 62 of. *Cambridge Studies in Advanced Mathematics*, 1999.
- [45] David GL Wang and Monica MY Wang. Non-Schur-positivity of chromatic symmetric functions. [arXiv:2001.00181](https://arxiv.org/abs/2001.00181), 2020.