

Bachelor's Final Thesis

**Bachelor's Degree in Industrial Technologies Engineering**

Simulating an automation plan in a 3D printing  
manufacturing factory

**REPORT**

**Author:**

Sergi Gonzàlez Navarro

**Director:**

Héctor Ortíz Valencia

**Call:**

June 2022





## Abstract

Additive manufacturing technologies are growing in interest and it is clear that in a short time they have improved enormously. From being a lab technology for fast and small prototyping to enabling stable manufacturing of high-volume products.

Every year, more manufacturers choose to adopt 3D printing technologies to produce end-user parts and sell them to compete with other more traditional methods.

In this context, this thesis shows the path of using the HP MJF 5200 3D printing technology to scale up a 3D printing manufacturing plant and optimizing to achieve the highest profitability possible.

To do so, a twin model and a cost model are built to allow fast and precise simulation and economic analysis of each scenario that the manufacturer would like to improve, providing production KPI's and seeing the results before building and buying new equipment.

The twin model will be validated with theoretical calculations to make sure it is accurate and it works as expected and all the simulation results will be presented and explained.

At the end, when the plant is optimized using existing HP solutions, an automation plan will be defined to select the best automation projects in order to further increase the productivity and profitability of the factory.

## Table of contents

<b>1. Glossary</b>	<b>6</b>
<b>2. Introduction</b>	<b>7</b>
2.1. Objective	7
2.2. Scope	8
2.3. Limitations	8
2.4. Background	9
<b>3. State of the art</b>	<b>14</b>
3.1. Value Stream Mapping	14
3.2. Siemens Plant Simulation software	15
3.3. OOE and OEE	16
3.4. Capital Expenditure (CapEx)	18
<b>4. 3D printing production line design</b>	<b>18</b>
4.1. Design and description of the MJF system	19
4.1.1. Equipment	19
4.1.2. Workers	20
4.1.3. Processes description	21
4.1.4. Process time and capacity analysis	31
4.1.5. Layout	34
4.2. Plant cost model	36
4.3. Plant Simulation model	39
4.4. Baseline analysis results	40
4.4.1 Results of the simulation	41
4.4.2 Economic analysis	42
<b>5. Optimization of the production line</b>	<b>45</b>
5.1. Theoretical optimization	45

5.2. Model Plant Simulation	49
5.3. Economic analysis	56
<b>6. Automation of the 3D printing production line</b>	<b>59</b>
6.1. Step 1: Identify potential improvement projects	60
6.2. Step 2: Propose solutions to the projects	61
6.3. Step 3: Simulating the new scenarios	63
6.4. Step 4: Economic analysis	65
<b>7. Economic analysis of this project</b>	<b>67</b>
<b>8. Environmental impact</b>	<b>69</b>
<b>Conclusions</b>	<b>69</b>
<b>Acknowledgement</b>	<b>72</b>
<b>Contents</b>	<b>73</b>
<b>References</b>	<b>75</b>

## 1. Glossary

In this section there is a list and meaning of all the acronyms and complex terms used during the research.

IPQC: In Progress Quality Control

MJF: Multy Jet Fusion

DFM: Design For Manufacturing

PS: Processing Station

AB: Airblasting/Airblaster

SB: Sandblasting/Sandblaster

AUS: HP MJF 5200 Automatic Unpacking Station

PS: HP Processing Station

BU: HP MJF 5200 Build Unit

NCU: HP MJF 5200 Natural Cooling Unit

TL: Top-line

FB: Full Bucket

MUR: Machine Utilization Rate

TC: Theoretical Capacity

AT: Actual Capacity

KPI: Key Performance Indicator.

RP: Return Period

ROI: Return of Investment

## 2. Introduction

Manufacturers face new challenges to overcome such as supply chain disruptions around the world, new parts requirements and increasing speed and flexibility of the production. Customers demand more personalized final products delivered in record times and traditional manufacturing technologies are not well suited to meet these requirements. Technologies such as extrusion or injection molding only allow to produce the same part in high volumes, making it very difficult to adapt the solution to each customer.

3D printing opened a new world for personalization to explore, with very different materials such as soft plastics, hard plastics, metals, etc. The potential of this technology is to provide each customer with their uniquely designed solution, in very short times, and in high, medium or low volumes. However, the current state of 3D printing technology does not allow high-volume production as described.

Some companies are investing a lot to unlocking the potential of 3D printing manufacturing, and moving away from prototyping into high-volume 3D printing production, with some industrial applications already in the market.

### 2.1. Objective

The broad goal of the study is to design a process to optimally automate a 3D printing plant, which is initially very human-dependent, in order to achieve the desired high-volume production, utilizing a current market solution for 3D printing manufacturing and improving it to maximize its capacity.

To do it, different types of technologies are presented, to find the best fit for the task and different optimization methods are examined and applied.

At the end, the study aims to have a highly optimized 3D printing plant, capable of producing large numbers of end-user parts to be more competitive and level-up from the fast-prototyping state.

As a very important factor in the Industry 4.0, not only will the final solution be important, but also how the method was implemented. Besides, the objective is to show how a digital twin model of the production plant and a cost model is used to calculate all the scenarios beforehand and use it as a decision-making tool.

As in any business, the focus is reducing the production cost or equivalently to increase the profit.

## 2.2. Scope

This project will target only one selected technology, in this case HP MJF 5200, to implement a high-volume production line that can be flexible and can deliver a good quality final part with a competitive price. This doesn't mean that the same objective would be achievable with other technologies.

The goal is not to improve the core technology of 3D printing, but to improve the end-to-end process design, in order to look for improvements in the capacity on the line, focus on inefficiencies and industrialize the technology.

All of this is done with 2 tools to validate the results. The first tool is a twin model of the plant using Siemens Tecnomatix Plant Simulation, that has all the steps and variables precisely modelled. The second tool is a cost model created in Excel that will contain every single expense in the 3D printing factory.

The part quality will also not be a focus point, the study will start with a baseline yield given by the manufacturer's specifications.

## 2.3. Limitations

To simplify the analysis, there are assumptions made to fill any gaps that are not fully defined.

The production line has some extra steps not considered in this analysis due to its high dependence on the specific order. For instance, Design For Manufacturing (DFM) step, Metrology and logistics within the factory.



In a production line, every shift and every worker are different. The night shift could be less productive than the morning shift. Nevertheless, in this thesis all workers and shifts are considered to have the same efficiency and parameters, with slight variations being averaged out.

The powder management in the HP MJF production line is also an important factor of the final part and cost. If not properly controlled, the powder can become a part quality and a cost problem. Some examples are powder degrading, powder contamination and powder mixing. In this study it is assumed that the powder management is done correctly and following HP recommendations and only the final result of the good recycling process is considered. It won't be considered any cost increase due to bad powder management.

When calculating Return of Investment (ROI) analysis over long production periods the possibility of the machine breaking down will not be considered, because it is assumed that a good maintenance is followed and thanks to HP's warranty it won't affect the production line during the first years.

## 2.4. Background

The 3D printing Technology has been developing for over 40 years with different types of methods. This technology, also called Additive Manufacturing, is defined as the process of making three-dimensional objects from a digital file by applying successive layers of material.

Depending on how the material is applied, different types of 3D printing technologies can be defined.

It is important to understand how the material deposition method affects the final part quality, durability and speed of the production. Among all the applications, only a few are feasible to become high-volume production technologies.

- **Fused Deposition Modelling (FDM)**

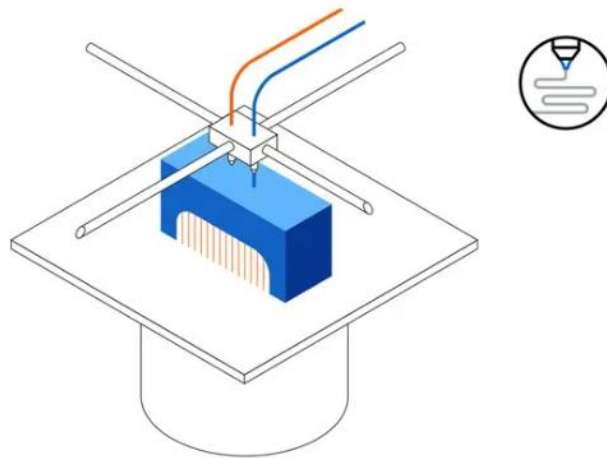

*Figure 2.1: FDM schematics [5]*

Fused deposition modelling (FDM) is a common desktop 3D printing technology for plastic parts. An FDM printer functions by extruding a plastic filament layer-by-layer onto the build platform. It's a cost-effective and quick method for producing physical models. There are some instances when FDM can be used for functional testing but the technology is limited due to parts having relatively rough surface finishes and lacking strength. [4]

The way it usually works is that a spool of filament is loaded into the 3D printer and fed through to a printer nozzle in the extrusion head. The printer nozzle is heated to the desired temperature, whereupon a motor pushes the filament through the heated nozzle, causing it to melt. [4]

The printer then moves the extrusion head along with specified coordinates, laying down the molten material onto the build plate, where it cools down and solidifies. Once a layer is complete, the printer proceeds to lay down another layer. This process of printing cross-sections is repeated, building layer-upon-layer until the object is fully formed. [4]

Depending on the object's geometry, it is sometimes necessary to add support structures, for example, if a model has steep overhanging parts. [4]

- **Stereolithography (SLA)**

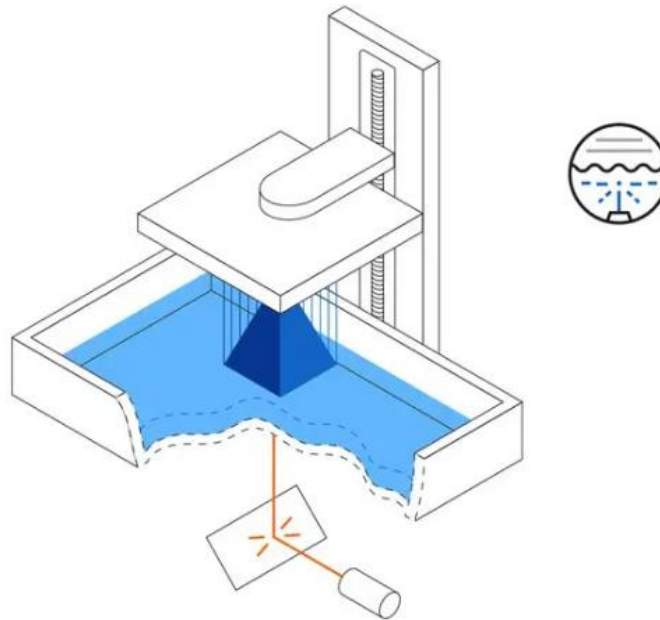

*Figure 2.2: SLA schematics [5]*

SLA holds the historical distinction of being the world's first 3D printing technology. Stereolithography was invented by Chuck Hull in 1986, who filed a patent on the technology and founded the company 3D Systems to commercialize it. [4]

An SLA printer uses mirrors, known as galvanometers or galvos, with one positioned on the X-axis and another on the Y-axis. These galvos rapidly aim a laser beam across a vat of resin, selectively curing and solidifying a cross-section of the object inside this building area, building it up layer by layer. [4]

Most SLA printers use a solid-state laser to cure parts. The disadvantage of these types of 3D printing technology using a point laser is that it can take longer to trace the cross-section of an object when compared to our next method (DLP), which hardens an entire layer at once. [4]

- **Selective Laser Sintering (SLS)**

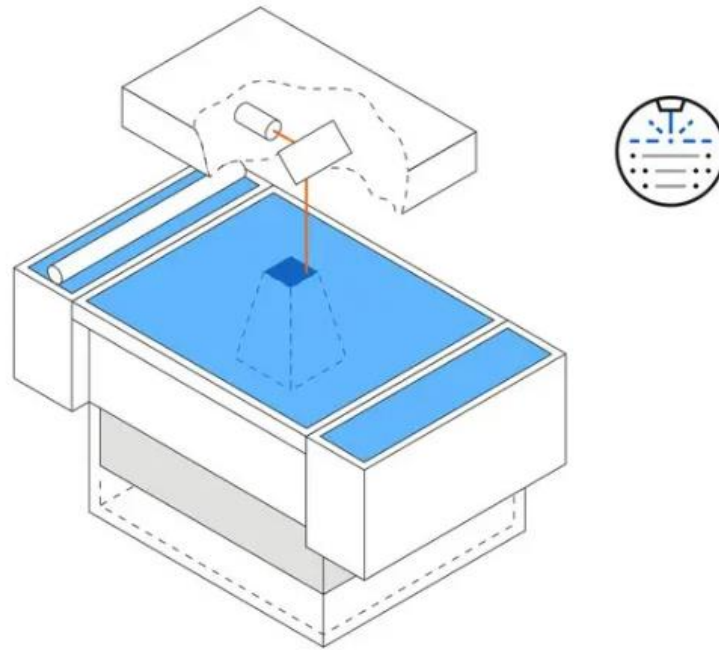

*Figure 2.3: SLS schematics [4]*

Creating an object with powder bed fusion technology and polymer powder is generally known as selective laser sintering (SLS). As industrial patents expire, these types of 3D printing technologies are becoming increasingly common and lower cost. [4]

First, a bin of polymer powder is heated to a temperature just below the polymer's melting point. Next, a recoating blade or wiper deposits a very thin layer of the powdered material – typically 0.1 mm thick – onto a build platform. A CO<sub>2</sub> or fiber laser then begins to scan the surface. The laser selectively sinters the powder and solidifies a cross-section of the object. Just like SLA, the laser is focused on the correct location by a pair of galvos. [4]

When the entire cross-section is scanned, the build platform will move down one layer thickness in height. The recoating blade deposits a fresh layer of powder on top of the recently scanned layer, and the laser will sinter the next cross-section of the object onto the previously solidified cross-sections. [4]

These steps are repeated until all objects are entirely manufactured. The powder that hasn't been sintered remains in place to support the object, which reduces or eliminates the need for support structures. [4]

- **Multy Jet Fusion (MJF)**

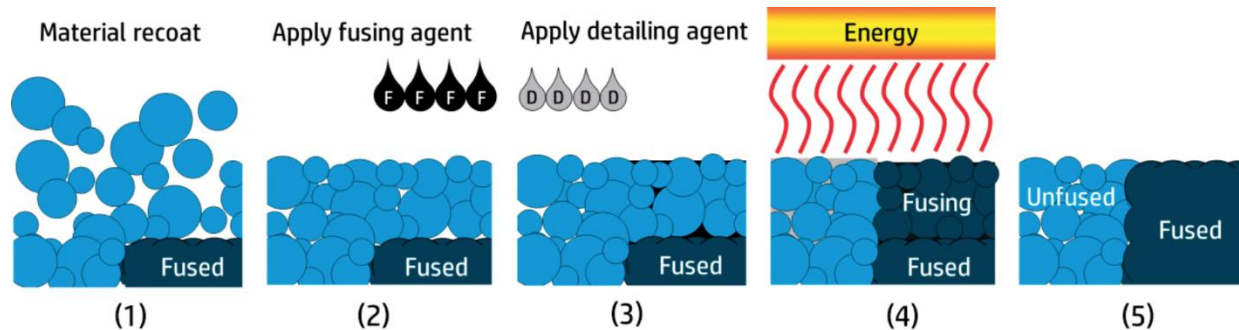

Figure 2.4: MJF schematics [6]

Multi Jet Fusion is an additive manufacturing method invented and developed by the company Hewlett-Packard (HP). It creates parts additively thanks to a multi-agent printing process. Your plastic part is created layer by layer, according to your 3D model. [7]

In this process a fusing agent is applied on a material layer where the particles are destined to fuse together. Then a detailing agent is applied to modify fusing and create fine detail and smooth surfaces. To finish, the area is exposed to energy that will lead reactions between the agents and the material to create the part. [7]

When the printing process is complete, the build box is removed from the printer. An operator carefully extracts the parts from the build box and removes the remaining powder thanks to brushes and air blowers. [7]

### 3. State of the art

#### 3.1. Value Stream Mapping

Value Stream Mapping (VSM) or also called lean process mapping is defined as a lean tool that employs a flowchart documenting every step in the process. Many lean practitioners see VSM as a fundamental tool to identify waste, reduce process cycle times, and implement process improvement. [21]

Some key concepts are used in this thesis to construct the workflows and production plant designs.

**Key concepts:**[28]

**Bottleneck:** Operation that causes others to slow down. (Longest cycle per unit) Sets the limit for the operation.

**Buffer:** Time between operations.

**Changeover:** Set up time. Preparation time for a given process.

**Cycle time:** Time required to complete an operation.

**Downtime:** Time when equipment is not available.

**Pull:** Production triggered by customer demand. Opposite *push*.

**Push:** Operations at full capacity regardless the demand.

**Lead time:** Time before an action begins.

**Throughput:** Frequency or pace of production required to meet customer demand.

**Value-Adding-time:** Time spent on activities that add value to the product.

**Non-value-adding time:** Time spent on activities that do not directly add value to the product.

**Process lead time or process time:** Total time required to handle an item in a process step. (Order, preparation, run time, moving, inspection and put-away).

**Operation time** = Changeover time + Process time.

**Process efficiency** = Process time (value adding time) / Lead time. *AKA flow-time efficiency.*

**Quality rate:** Acceptable products. Opposite defects rate.

**Uptime:** The time when equipment is ready for production.

**Waiting time:** Idle time.

**Capacity:** Number of parts the plant can produce in a period.

### 3.2. Siemens Plant Simulation software

Plant Simulation software enables the simulation, visualization, analysis and optimization of production systems and logistics processes. Using Plant Simulation enables companies to optimize material flow, resource utilization, and logistics for all levels of plant planning. The simulation tool can be leveraged to analyse global facilities, an entire plant, or simply a few machines in a production line. [8]



Figure 3.1: Plant Simulation model example [29]

In times of increasing cost and time pressures in production along with ongoing globalization, logistics has become a key factor in the success of a company. The need to deliver on time and in sequence, introduce lean manufacturing principles, plan and build new sustainable production



facilities, and manage global production networks requires objective decision criteria to help management evaluate and compare alternative approaches. [8]

Plant Simulation helps to create digital models of logistics systems so companies can explore system characteristics and optimize their performance. The digital model not only enables users to run experiments and what-if scenarios without disturbing an existing production system, but it can be used in the planning process long before the real system is installed. Extensive analysis tools, statistics and charts let users evaluate different manufacturing scenarios and make fast, reliable decisions in the early stages of production planning. [8]

Plant Simulation helps manufacturers to:

- Detect and eliminate problems that otherwise would require cost and time-consuming corrective measures during production ramp up.
- Minimize the investment cost of production lines without jeopardizing required output.
- Optimize the performance and energy usage of existing production systems by taking measures that have been verified in a simulation environment prior to implementation.

### 3.3. OOE and OEE

OOE (**Overall Operations Effectiveness**) is a manufacturing metrics which takes unscheduled time into account, taking total operations time as the maximum. [17]

OEE and OOE are similar, but one differs from the other in terms of the amount of time they take into consideration. OOE **takes account of unscheduled time, for instance, if a machine is not working due to maintenance**. On the contrary, OEE only considers scheduled time. OEE calculation ignores if a machine is down due to maintenance, or inspection. [17]



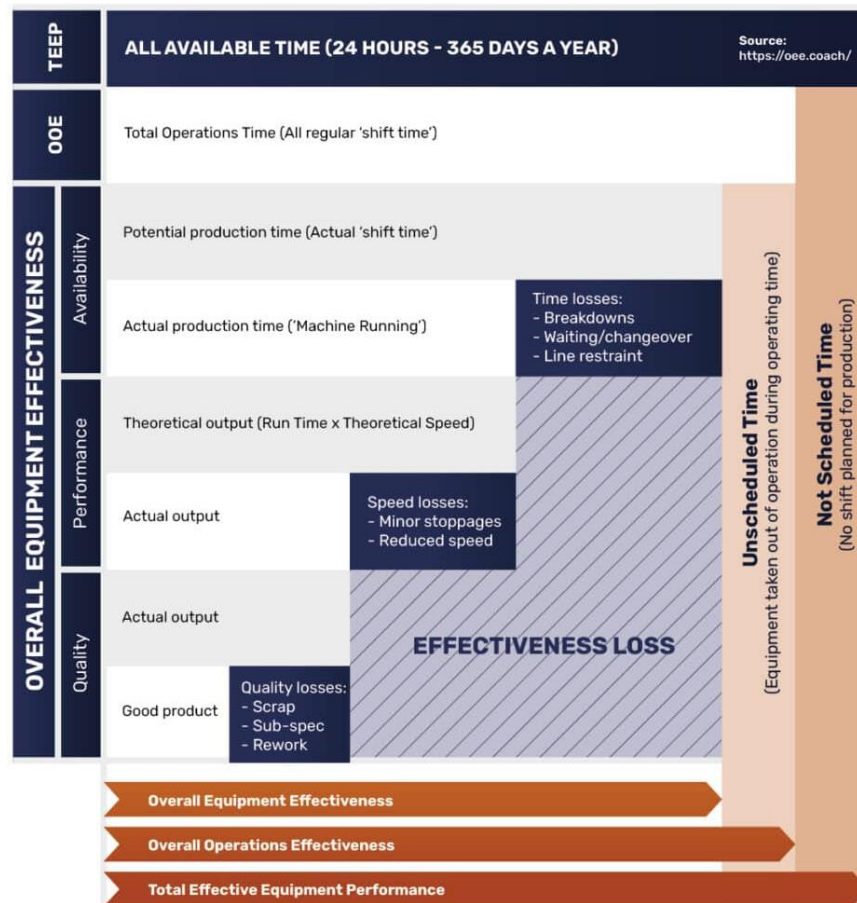

Figure 3.2: OEE summary [30]

$$OEE = Availability \times Performance \times Utilization$$

Equation 3.1

So, as a benchmark, the OEE score is considered a “good” OEE following these indications:

OEE BENCHMARKS [32]

- 100% OEE is perfect production: manufacturing only good parts, as fast as possible, with no stop time.

- 85% OEE is considered world class for discrete manufacturers. For many companies, it is a suitable long-term goal.
- 60% OEE is fairly typical for discrete manufacturers, but indicates there is substantial room for improvement.
- 40% OEE is not at all uncommon for manufacturing companies that are just starting to track and improve their manufacturing performance.

### 3.4. Capital Expenditure (CapEx)

Capital expenditures (CapEx) are funds used by a company to acquire, upgrade, and maintain physical assets such as property, plants, buildings, technology, or equipment. CapEx is often used to undertake new projects or investments by a company. Making capital expenditures on fixed assets can include repairing a roof, purchasing a piece of equipment, or building a new factory. This type of financial outlay is made by companies to increase the scope of their operations or add some economic benefit to the operation. [16]

Capital expenditures are the investments that companies make to grow or maintain their business operations. Unlike operating expenses, which recur consistently from year to year, capital expenditures are less predictable. For example, a company that buys expensive new equipment would account for that investment as a capital expenditure. Accordingly, it would depreciate the cost of the equipment over the course of its useful life. [16]

## 4. 3D printing production line design

In this project the HP 3D printing technology is chosen because it is one of the most advanced and mature solution [25] for implementing an industrial additive manufacturing facility with the most positive Key Performance indicators (KPI) [24], such as having one of the biggest printing volumes per job, very high yield, very good finishings, repeatability, etc. Another reason is that with this technology there are already a lot of small manufacturing labs [26] that are using the technology and could benefit from this study.

It is important to note that, despite choosing HP solution, there are other possibilities with other providers that won't be evaluated that could also achieve the same goal.

#### 4.1. Design and description of the MJF system

The baseline of the plant, from which will be optimized, is the recommended configuration from HP when buying the MJF system.

Once the baseline is defined and studied, the next step will be to improve its capacity.

##### 4.1.1. Equipment

The MJF technology consists in a system of devices that allow a very fast and high-volume production with end-to-end capabilities. It is intended to be installed in an industrial or lab environment and can be used for casual fast prototyping on end-user printed parts.

The minimum setup, which will be the first baseline of this study, consists in one unit of each equipment of the HP MJF 5200.

The Printer, the Processing Station (PS), the Automatic Unpacking Station (AUS), the Build Unit (BU), the Natural Cooling Unit (NCU), the Airblaster (AB) and the Sandblaster (SB).



Figure 4.1: HP MJF 5200 system [31]

When purchasing the HP MJF 5200, the AB and SB are not included, but HP recommends using them and acquiring them from third party providers, such as *ABShot*. Therefore, it was selected as a provider with both AB and SB machines.

Some secondary equipment and tools are needed to support the production line. They are listed below:

- Maintenance tools: any tool that may be used to do maintenance work and repairs to the system.
- Drums to carry and store powder: when buying the HP MJF system one drum is included, but more than one drum would be needed to store and manage the powder.
- Forklift: it is used to lift and move NCU's around, from the racks to the PS. The NCU weight is too high to be carried by hand.
- Vacuum ATEX: according to the regulation, when managing this kind of fine plastic powders, a proper anti explosion vacuum system is needed.
- IPQC equipment: it includes small and big scales, mechanical impact devices to record young module and other parameters, measuring tools, lamps, lenses, etc.

The official UG recommends applying some sort of finishing to the final parts to improve its visual feeling. However, it is not mandatory to consider a product as finished.

#### **4.1.2. Workers**

As this thesis is focused on the 3D printing technology, the object to study will be the workers that operate the equipment of the top-line.

In an ideal scenario, a production plant should be operating 24 hours per day, all year round. The reason is that every minute the machine is not in use it is costing money (Due to renting, amortization, etc).

Therefore, it is considered a 3 shifts/day, 7 days per week. In each shift, as a baseline, there will only be one worker that operates the top-line production.

### 4.1.3. Processes description

In the production line, there are different stations where the powder is transformed and the printed parts are cleaned by a worker.

The main unit to be monitored is the job or bucket, and not the printed part. The reason is that depending on the order type, the final printed part could be very different: from a bucket with multiple small parts to a bucket with one big part.

The top-line procedures (starting with powder and finishing with the final part) go from TL1 to TL9.

#### TL1 Loading

This is the first step in the production line. The process starts by filling the BU with a mix of recycled and fresh powder. This process is done in the PS.

At this station, there are drums containing fresh powder and various reclaimed powders, and the BU is received empty from the BU parking area. There are 2 types of powder:

1. Fresh powder (Offloading)
2. Recycled unpack powder (AUS)
3. Recycled AB powder

First, the BU must be inserted inside the PS and all the drums must be connected. The hose must be inserted in the BU and then the loading can start.

The output of this process is the BU full of the powder already mixed and ready to insert to the Printer.

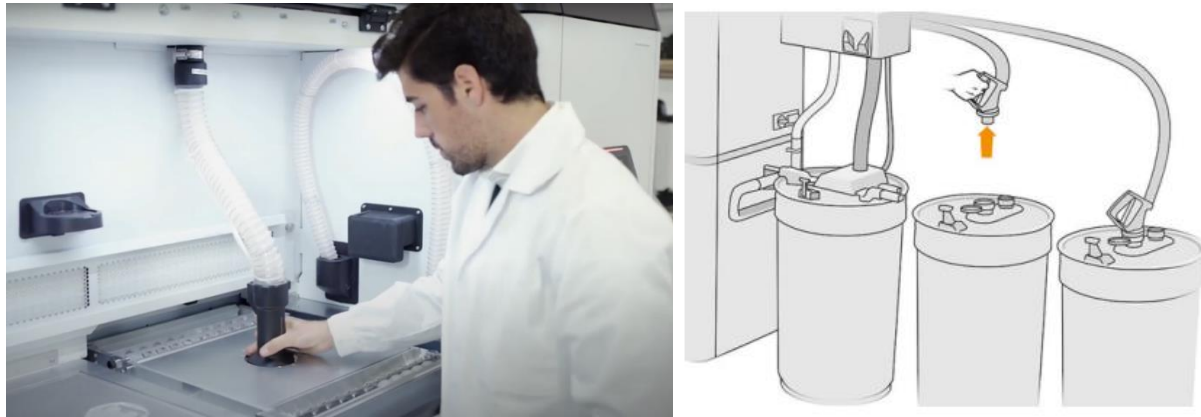

Figure 4.2: HP MJF 5200 Loading process [6]

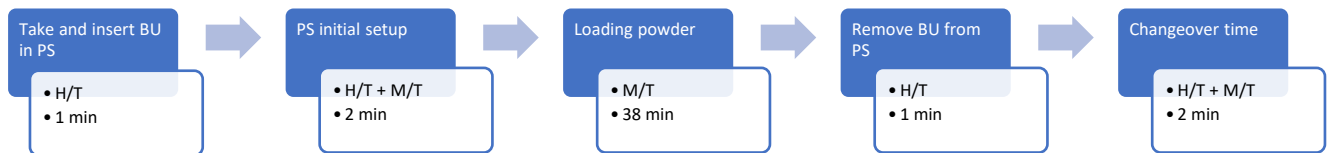

Figure 4.3: Workflow of TL1 Loading

## TL2 Printing

This procedure describes the printing process. From preparing the Printer, to setting up the BU until the printing process ends.

At this station, the BU is received from the loading process (TL1).

The printing process includes the printer's calibration, sensor verification and baseline calibration.

The output of this process is the printed parts inside the BU ready to be extracted and unpacked (TL3).

After the printing has finished, the worker must perform an after-job maintenance before starting to print again.

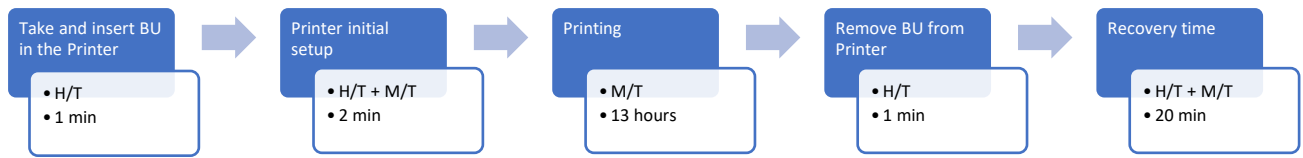

Figure 4.4: Workflow of TL2 Printing



Figure 4.5: Insert BU into the Printer operation [14]

### TL3 Extract

When the printing has finished, the process of extracting the printed parts out of the BU can start.

At this station, the BU is received from the printing process (TL2) at high temperatures. After inserting both the BU and NCU, the PS extracts all the material from the BU to the NCU.

The output of this process is the printed parts extracted from the BU ready to be cooled.



Figure 4.6: HP MJF Extract from BU to NCU operation. [9]



Figure 4.7: Workflow of TL3 Extract



## TL4 Cooling

Once the NCU is filled with the powder and printed parts, the NCU is parked in a controlled area where it is cooled from over 100°C to less than 50°C.

The cooling time depends on the material and the height of the printed job. In this case, the material studied is PA12, so it needs at least 30 hours of cooling.

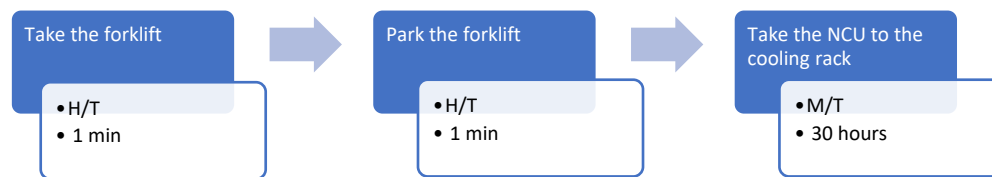

Figure 4.8: Workflow of the TL4 Cooling.

## TL5 Unpacking

This procedure describes the process of removing the printed parts from the remaining powder inside the NCU. To do it, it can be done manually inside the PS or automatically using the AUS.

The AUS is the latest improvement to the MJF system that allows a much faster automated unpacking process.

To start the process, the NCU is placed on the AUS using a forklift. After that, the unpack can be started. The output of this process are the printed parts, ready to be cleaned.

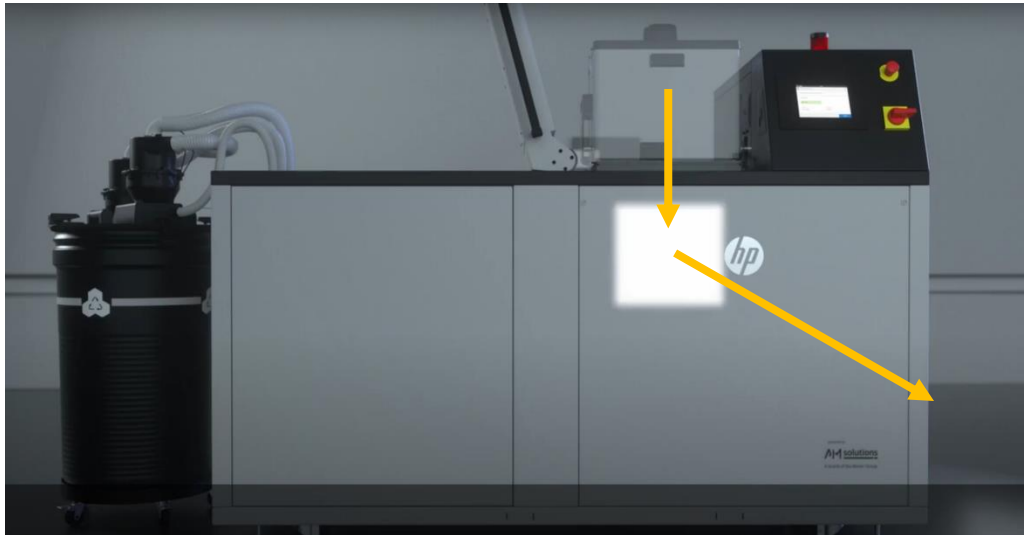

Figure 4.9: HP MJF Unpack from NCU operation. [9]

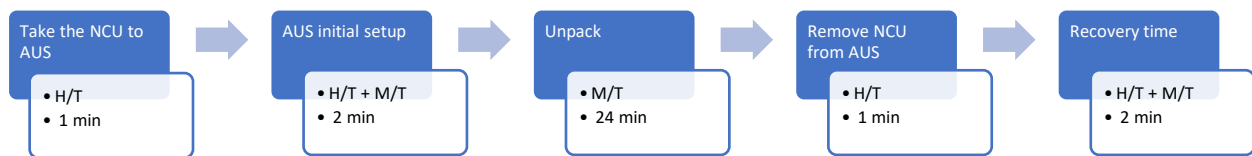

Figure 4.10: Workflow of TL5 Unpack.

## TL6 Airblasting

In this procedure the cleaning process begins. Here, the printed parts are using high pressure air that recovers the remaining powder.

The equipment used is the HP suggested brand for MJF post processing: ABSShot.

In this station, each printed part is cleaned using an air gun from the inside of the machine.

The powder recovered in this station is recycled.



Figure 4.11: ABShot S9 equipment. [10]

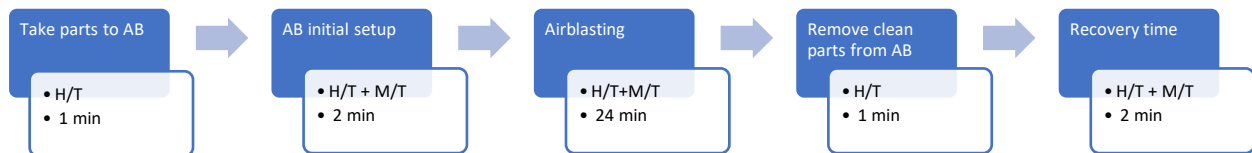

Figure 4.12: Workflow of TL6 Airblasting.

### TL7 Sandblasting

This procedure describes the second cleaning process of the remaining powder adhered to the surface.

that the Airblaster could not remove, using a Sandblasting machine.

At this station, the parts container is received from the TL6 process partially clean. Similarly, to Airblasting, the worker cleans each part inside the machine using an abrasive gun that uses fine abrasives.

This equipment is very similar to the Air blaster ABShot S9.

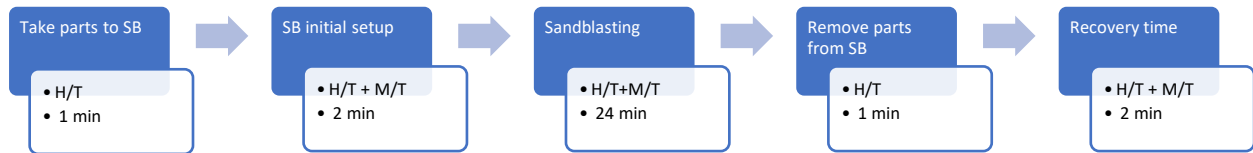

Figure 4.13: Workflow of TL7 Sandblasting.

### TL8 In Progress Quality Control (IPQC)

In this station, the worker inspects each part with different methods to ensure the good quality of the job.

Depending on the material, application and use of the printed part there could be a lot of different tests to be conducted. Given the objective of this thesis, only the most common tests will be considered:

- **Look & Feel:** this test is a visual inspection that searches any imperfection or aesthetic defect that may impact the performance of the part.
- **Weighing:** this parameter ensures there is no hidden powder adhered or that the part is not printed completely.
- **Mechanical impact:** a short impact is made to the part to ensure that it is not compromised and will resist the long use.
- **Measuring:** the critical dimensions of the printed part are measured to check the tolerance.

In this station the bad parts are discarded.

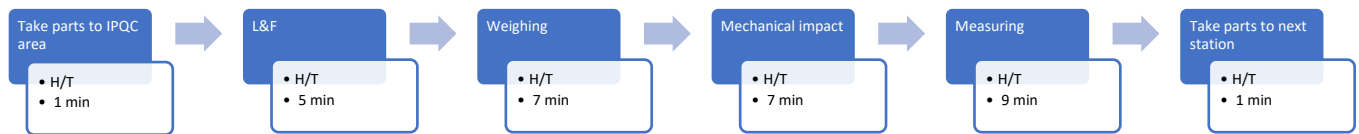

Figure 4.14: Workflow of TL8 IPQC.

### TL9 Packing & Shipping

In this station, the final parts are packaged in groups depending on the order type and size. After that, the job is shipped to the final customer.

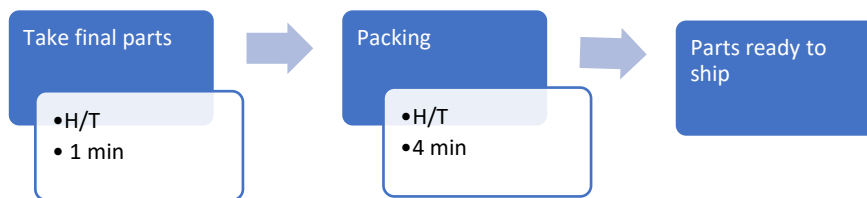

Figure 4.15: Workflow of TL9 P&S.

The Figure 4.16: HP MJF end-to-end production workflow shows the sum-up process workflow of the whole production line and all the steps required in each station according to the HP 5200 MJF UG.

This information is extracted from the official HP MJF 5200 UG, from the step-by-step procedures for each station.

With this information, the processes times can be calculated.

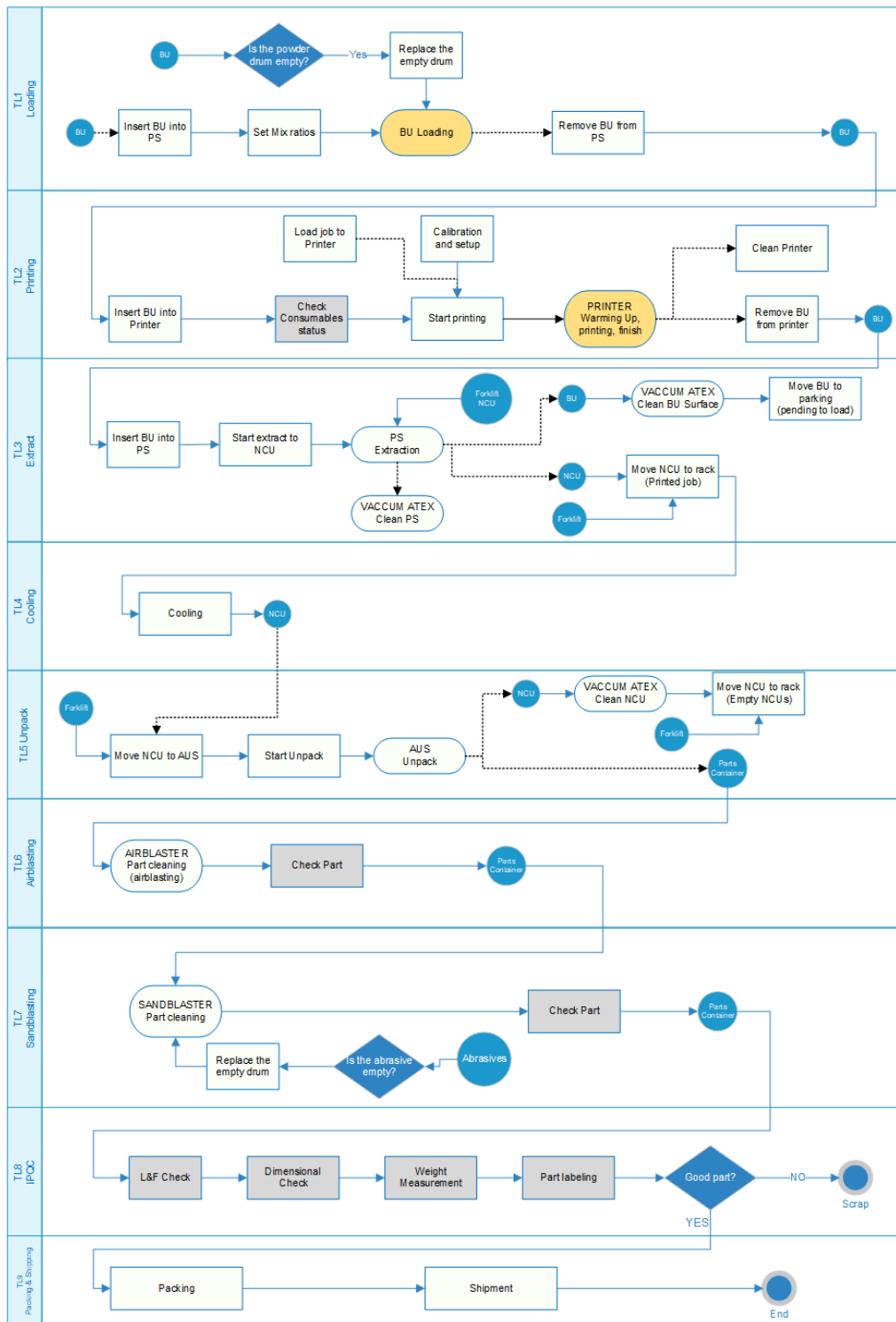

Figure 4.16: HP MJF end-to-end production workflow

#### 4.1.4. Process time and capacity analysis

Once all processes have been defined, we can begin to calculate the baseline capacity of the system.

This calculation includes one unit of each equipment and the layout is defined and optimized afterwards.

The method of production is *push*. This method consists in a continuous production of goods that uses all the available capacity. This decision is made because the goal is to understand the maximum capacity and the demand is not known.

This table shows a sum-up of the total lead process time, the percentage of which occupies a worker and the total human time per station.

	P/T per job	H/T %	H/T per job
<b>Loading</b>	45 min	14%	7 min
<b>Printing</b>	13.5 hours	4.2%	34 min
<b>Extract</b>	30 min	20%	6 min
<b>Cooling</b>	30 hours	0%	-
<b>Unpack</b>	30 min	20%	6 min
<b>Airblasting</b>	30 min	100%	30 min
<b>Sandblasting</b>	30 min	100%	30 min
<b>IPQC</b>	30 min	100%	30 min
<b>Packing</b>	5 min	100%	5 min

Table 4.1: Process times

With these numbers, the theoretical maximum capacity can be calculated.

Considering the printer alone, the printer **theoretical capacity** (TC) is:

$$TC_{Printer} = \frac{24 \frac{\text{hours}}{\text{day}}}{13.5 \frac{\text{hours}}{\text{job}}} = 1.788 \frac{\text{jobs}}{\text{day}} \quad \text{Equation 4.1}$$

Moreover, to calculate the system **theoretical capacity** (Printer + subsystems) all the process times are added:

$$TC_{system} = \frac{24 \frac{\text{hours}}{\text{day}}}{46.34 \frac{\text{hours}}{\text{job}}} = 0.554 \frac{\text{jobs}}{\text{day}} \quad \text{Equation 4.2}$$

This result shows that the whole configuration reduces the capacity by a 68.8%.

This can be solved by trying to run some processes in parallel while other steps are carried out.

To calculate this scenario, a Gantt diagram is used.

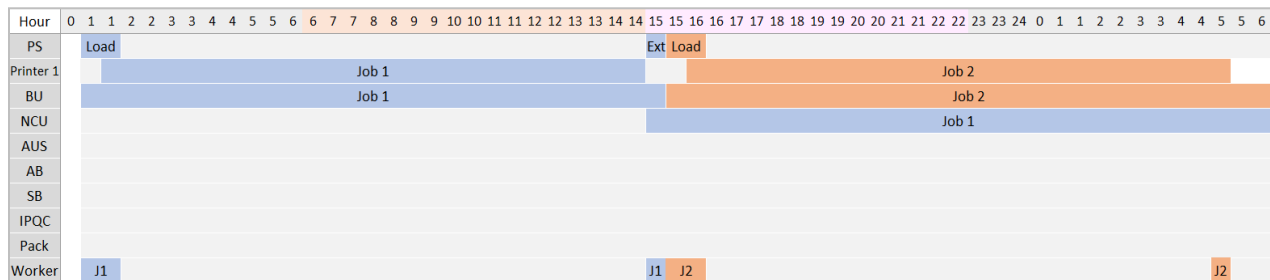

Figure 4.17: Gantt diagram of the first printed jobs.

In the Gantt diagram each asset is represented in a row. Assets cannot be used simultaneously for more than one job. Columns represent half hours (each column represents 30 minutes). It can be seen how the first job (in blue) advances while the job 2 (in orange) also starts when the job 1 is not finished yet.

The column 1 shows that the loading is starting in the PS with the BU. Before finishing the first hour, the BU is transferred to the printer and the printing process starts, freeing the PS up. From the hour 2 to 14 the BU and the Printer are blocked while the printing process does not finish.



This diagram displays the first 4 shifts of the production and how the activities of the first and second job are parallelized. During the first shift's hour, the worker first the BU to start the printing. After the printing has finished (hour 15), the worker can extract the printed parts into the NCU and, as soon as the BU is empty, the worker can load it again to start printing the second job. When the second job finishes the printing process, the operator can remove the BU from the printer but the printer must be parked waiting to a free NCU. In this period the after-job printer maintenance is done.

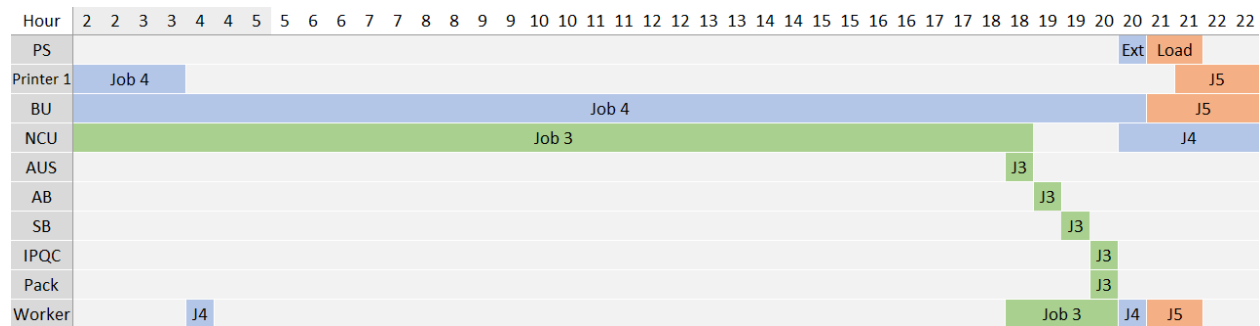

Figure 4.18: Fragment of the Gantt diagram. Third and fourth printed jobs.

This other fragment of the Gantt diagram shows the end of the third job and the beginning of the fourth, when the production is stable.

As the job 3 is blocking the NCU, the BU of the job 4 must be parked waiting for a free NCU, although it is still counting as cooling time.

When the job 3 finishes the cooling, the worker can start the unpacking, cleaning, quality inspection and packing to finish the third job.

As soon as the worker is free, the job 4 can be extracted to the NCU and, soon after, the worker can load the next one.

As a result, running the Gantt diagram for several shifts, the production stabilizes and the system's **actual capacity** (AC) can be calculated dividing the total printed jobs by the hours needed:

$$AC_{system} = \frac{4 \text{ jobs}}{106 \text{ hours}} = 0.0377 \frac{\text{jobs}}{\text{hour}} = 0.91 \frac{\text{jobs}}{\text{day}} \quad \text{Equation 4.3}$$

After applying the parallel activities, we could increase a 64.26% from the system theoretical capacity. However, we are still far from the 1.778 jobs/(printer\*day) printer capacity.

The TC and AC does not include the OEE yet.

## OEE

In order to calculate the OEE, as seen in Equation 3.1, we determine the following parameters:

- ❖ Yield: 90% according to HP documentation
- ❖ Processes efficiency: it is assumed to be 90% after some manual operations done by the workers.
- ❖ Machine uptime: 90% according to all maintenance operations described in the HP MJF 5200 Maintenance Guide [6].

Then, multiplying the three factors we obtain:

$$OEE = 0.9 \times 0.9 \times 0.9 = 0.729 \quad \text{Equation 4.4}$$

This result is in line with the industry-standards benchmark as seen in 3.3. OOE and OEE.

This value will be used through all this study.

### 4.1.5. Layout

Once all the equipment needed for the production has been identified, it can be distributed in such way to enhance the production flow.

This layout includes all necessary spaces to complement the production, such as shipping area, packing area, racks, etc.

In total, it would occupy a total area of 400 m<sup>2</sup>.

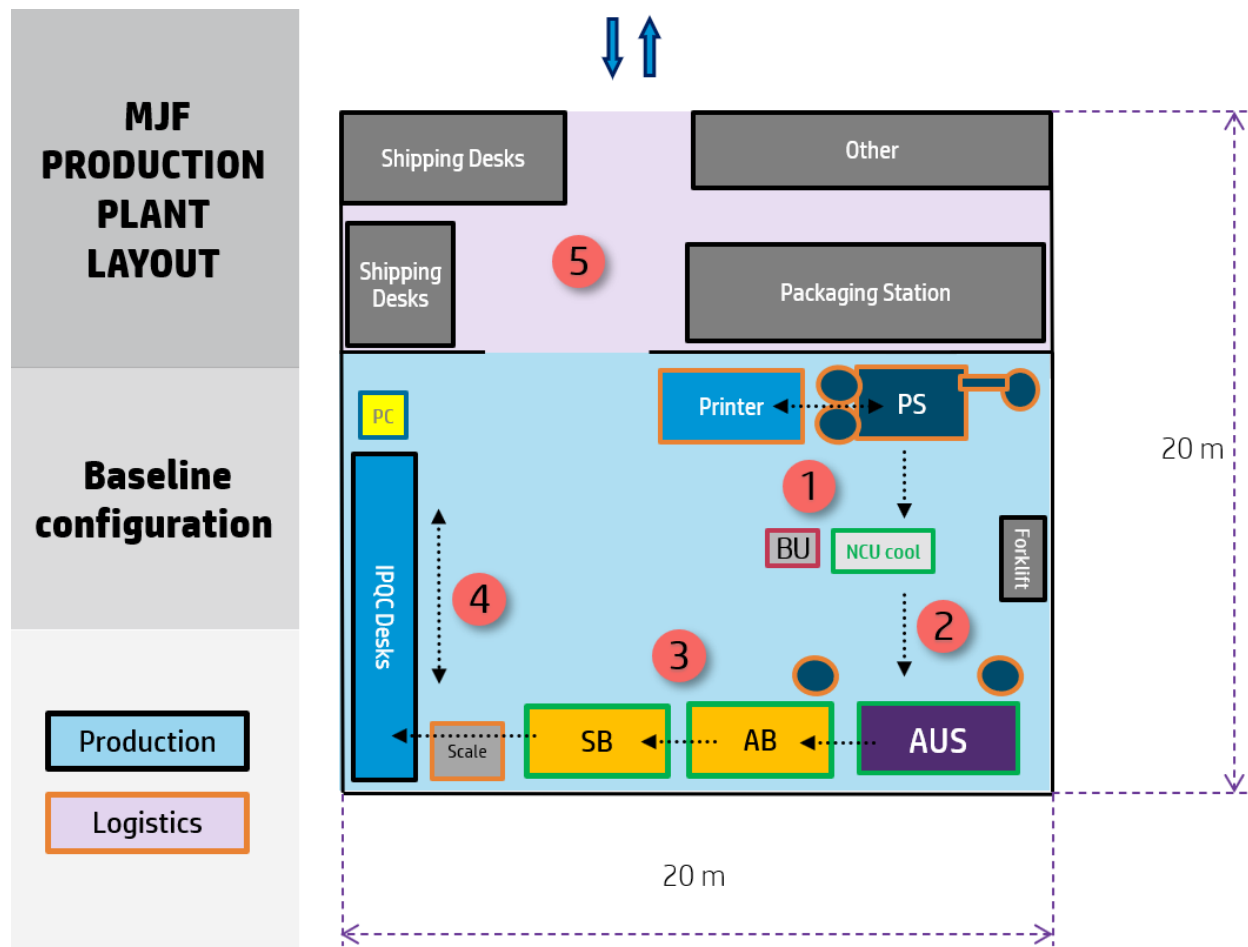

Figure 4.19: HP MJF baseline optimized layout.

Going through all the spaces, we find:

- 1 Processing station, powder management and printing area with BU parking.
- 2 Cooling, NCU rack and Unpack area.
- 3 Cleaning area.
- 4 Quality Inspection area, scale and pc.
- 5 Logistics area with racks, shipping, packing and other storage.

## 4.2. Plant cost model

A cost model is a tool used to automatically calculate the factory value, variable expenses and fixed expenses associated. It is done modifying the initial parameters, such as number of buckets produced, workers shift, number of machines and so on.

This tool is made using an Excel file that has all the formulas programmed.

	UNIT	FY21	Q1F22	Week 1	Week 2	Week 3	Week 4	Nov	Dec	Jan	Q1F22
CONCEPT											
DEMAND & PRINTING CAPACITY											
GENERAL MODEL ASSUMPTIONS											
HP CONSUMABLES ASSUMPTIONS											
OPERATORS PROCESS TIMES											
HW CONNECT RATES											
INSTALLED BASED											
NEW UNITS											
HW COSTS & PRICES - CAPEX											
HW INVESTMENT (CAPEX)											
OTHER INVESTMENT (CAPEX)											
TOTAL INVESTMENT CAPEX(\$)											
HW COSTS & PRICES - non-CAPEX											
HW INVESTMENT (non-CAPEX)											
Other INVESTMENT (non-CAPEX)											
TOTAL INVESTMENT non-CAPEX(\$)											
UNITARY VARIABLE COSTS											
USAGE OF VARIABLE COSTS											
VARIABLE COST (\$)											
TOTAL UNITARY VARIABLE COSTS											
FACTORY VARIABLE COSTS											
USAGE OF FACTORY VARIABLE COSTS											
FACTORY VARIABLE COST (\$)											
TOTAL FACTORY VARIABLE COSTS											
BARCELONA FACTORY COSTS											
SPACE NEEDS											
USAGE OF FACTORY RESOURCES											
FACTORY COSTS (CM)											
TOTAL FACTORY COST											
Engineering FACTORY											
Engineering FACTORY											
Engineering FACTORY											
TOTAL COST OF FACTORY											
DMC: Powder											
DMC: PrintHeads											
DMC: Other Production consumables											
Factory SW Licenses											
Maintenance: Carepack-shared											
Rental & Utilities											
Operators & Technicians											
Factory mngmt. Personnel											
Uncertainty (10%)											
Depreciation											
PRODUCTION EXPENSES											

Figure 4.20: Cost model screenshot.

Each line is a variable with its own formula. Each row is a time period. It is grouped by weeks, months and quarters.

The sections of the cost model are the following:

### Initial parameters:

Here the initial scenario is defined. From these parameters, all the calculations are made.

- Desired number of buckets: Equal to the Actual Capacity, result of the Plant Simulation analysis.
- Yield (Good jobs / Total jobs): 90%.
- Machine uptime (maintenances, downtimes, etc.): 90%.
- Extra Capacity buffer: 0% in this study.
- Labour days per Week/Year: 30 working days per month used in the simulation.
- Amount of Production Shifts: 3.
- Number of Printers: Initially 1.
- Process time (of each process): Found in the Table 4.1.

**Calculated parameters:**

Complementary parameters that are used to calculate the economic KPI's.

- System OEE (Overall Operations Effectiveness).
- Jobs reprinted (due to bad parts).
- Number of theoretical printers needed to achieve demand.
- Total capacity needed.
- Jobs printed per day and per printer.

**HW connection rates & investment:**

The cost model calculates how many of each machine are needed to achieve the demand and it gives a capex investment for the current period.

- HW connections rates (explained in 5.1. Theoretical optimization)
- Installed units
- New units needed
- HW cost

**Variable cost:**

This cost is directly related to the number of parts printed and would be zero with zero parts.

- Cost of powder: Based on current market prices.

- Cost of printer consumables (fusing agent, detailing agent, cleaning rolls, etc): Average.
- Cost of energy: Based on current market prices.
- Cost of packaging: Average.
- Cost of abrasive: Based on current A3Shot market prices.
- Other factory consumables.

### Factory fixed costs:

These costs are not linked to the number of parts, and will exist even with zero production.

- Facilities rental (m<sup>2</sup>) based on HW installed: Approximation based on current industry standards.
- Maintenance (fixed people): Average hours of maintenance per machine.
- Power and other services (water, pressured air, energy, etc): Based on current market prices.
- Waste management.
- Worker's salary: Current medium worker salary.
- Other personnel.
- 10% mark-up.

### Engineering cost:

This technology requires a team of engineers that can evaluate projects, design custom solutions, improve the factory, design the bucket design, etc.

- Number of engineers: Initially one engineer.
- Engineers' salary. Average Spanish medium to senior salary.

### Output of the cost model:

- Total **powder** cost: PA12 powder.
- Total **consumables** cost: specific consumables of the machines (Printheads, agents, fusing lamps, etc)
- Total general **factory supplies**: material and consumables linked to running a factory.
- **Rental & utilities**: space and services rented to run the factory.

- **Personnel:** Including workers, technicians and engineers.
- **Depreciation:** Calculated with an interest rate of 12% and 8 years of amortization [15] using the Excel tool.
- **Maintenance:** Average cost per machine.
- **Uncertainty:** Based on the variability of material cost, factory expenses and other payments.

### 4.3. Plant Simulation model

The final tool that is used to calculate the production scale-up of the HP MJF plant is Tecnomatrix Plant Simulation.

For the purpose of this study, a virtual model of the 3D printing facility has been created, with all the stations modelled to simulate and calculate all the production KPI's in order to optimize the line.

The elements of the model are:

- Clock: to set up the initial and final time of the simulation.
- Shift calendar: to model the workers.
- Sanky Diagram: to analyse the workers' path and optimize the layout.
- Cost analyser: it will not be used. The cost model will be used instead.
- Automatic report: it will output all the graphs and KPIs of the current simulation.
- Experiment Manager: tool used to determine the best number of assets and variables.
- Bottleneck analyser: suggest possible bottlenecks.
- Worker pool: defines each type of worker and its parameters.
- Order table: define the type of buckets to print and all the specification for that order. It also specifies the order entry date and time and all the processes times.
- Individual stations: each step in the top line is modelled.

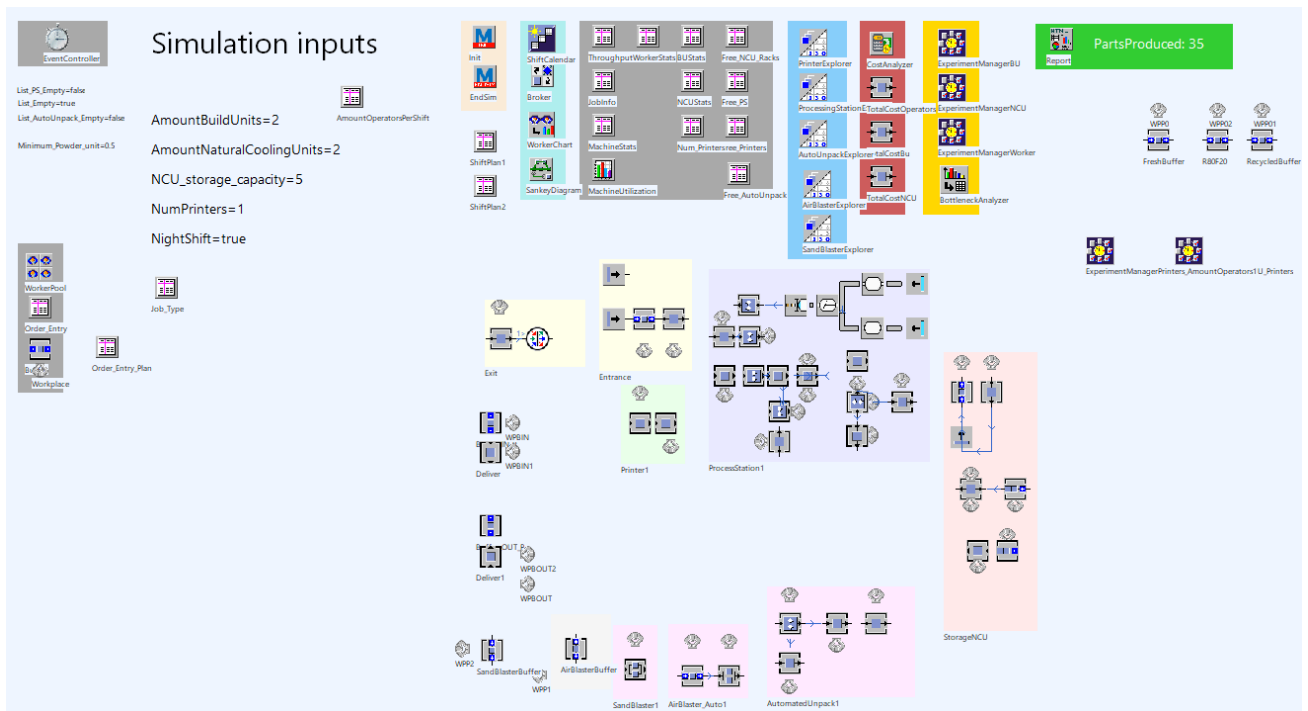

Figure 4.21: Twin model of the MJF production line made with Plant Simulation.

#### 4.4. Baseline analysis results

After constructing all the tools to model the HP MJF (Theoretical Model, cost model and plant simulation model), a production simulation can be run to calculate its economic parameters.

Before starting the simulation, some **assumptions** were needed to simplify the model. The assumptions and justifications are the following:

- Worker's efficiency: 90%, which means that only 90% of their 8 hours shift is dedicated to the top-line activities.
- Printer yield: 90%. It is a highly variable value which depends a lot on the type of part printed. This value is the mean between many kinds of parts and sizes and an industry standard. [6]
- OEE equipment: 72.9% as seen in Equation 4.4.
- No failure statistical model is applied.
- No variation between shifts.



The production was simulated during a 30-day period, with 3 shifts (8 hours each), with one worker per shift and working all days of the week.

#### 4.4.1 Results of the simulation

After setting up and running the Plant Simulation model we obtain the following results:

- Total buckets printed: 20 (23 in total and 3 bad jobs)
- Weekly throughput: 5 good jobs printed per week.
- Machine utilization rate:

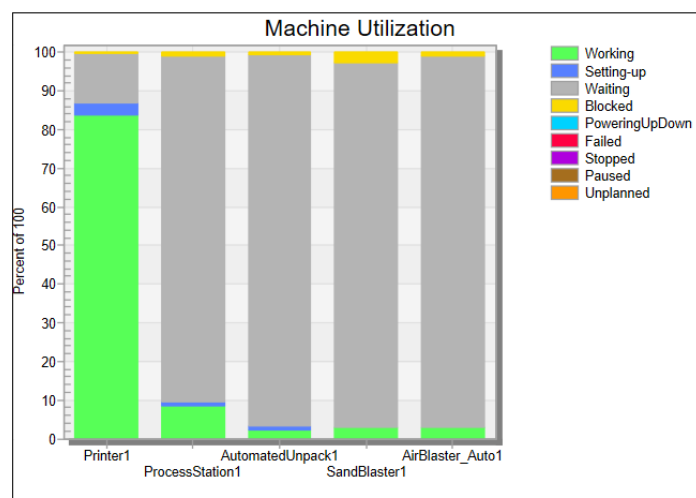

Figure 4.22: MUR of baseline simulation during 1 month.

- BU utilization rate: 100%
- NCU utilization rate: 90%
- Worker utilization rate:

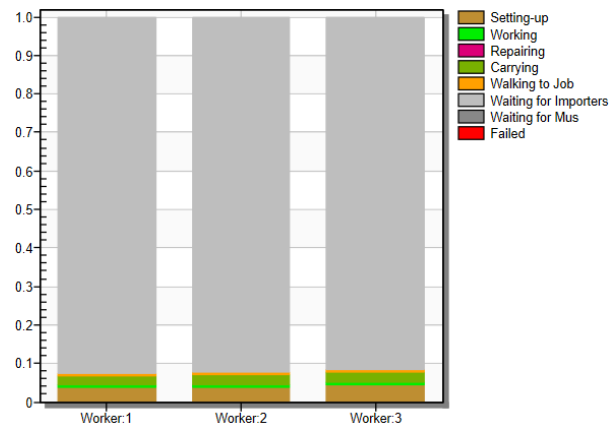

Figure 4.23: Worker's utilization rate of baseline 30 days simulation.

As expected, the production capacity is very low due to the equipment being underused. The cause is the clear bottleneck of the BU and NCU.

The overall equipment effectiveness (OEE) of this setup compared to the theoretical printer capacity (TC) is 47%.

#### 4.4.2 Economic analysis

After all the production calculations are finished, the economic analysis can be done. To do it, the cost model will be used, in conjunction with a cash flow and ROI analysis.

The first thing to find is the market base price for the full printed bucket.

To do it, Fast Radius [13] has been selected as a baseline HP MJF parts provider. Using its platform, a 3D design can be uploaded and then setting up all the printing parameters the webpage returns a price budgeted for that configuration.

In this case, a 3D cube with a total volume of 1714 mm<sup>3</sup> and 13x11x11 mm of size has been uploaded. The specifications chosen were the most basic possible (colour, finishing and inspection).

The printing volume of the HP MJF 5200 is 406x305x406 mm.

By ordering 1000 the final price was 860\$ (at that specific time). Knowing that and adjusting for a 10% packing density [12] (balance for quality and quantity) the approximate full bucket price is **\$2500**.

To get another market example, another manufacturer was analysed. The company Saratech [14] published an economic report about producing insoles with the HP MJF technology. According to them, in one full bucket 82 insoles pairs can be fitted, with a maximum production cost of \$30 per pair which leave a full bucket production cost of \$2468, on par with the other company.

With this base selling price of \$2500, the cost model can be prepared.

The results of the cost model are the following:

Production	Baseline 24 full buckets / month
Initial HW investment (CAPEX)	\$500k [11]
	Monthly
Total variable cost	\$29.4k
Total fixed cost	\$39.2k
	Breakdown
Powder	\$6.4k
Consumables	\$17.7k
Factory supplies	\$9.3k
Rental & Utilities	\$8.2k
Personal	\$16.2k
Depreciation	\$4.6k
Maintenance	\$900
Uncertainty	\$5.3k
Total	\$69.8k
Full bucket price	\$2860 / FB

Table 4.2: Cost model results of the MJF 5200 baseline configuration.

These values are obtained assuming a continuous production and prices at the time of this study.

The conclusion of this analysis is that the total production cost of one full bucket is way above the market price, \$2860 vs \$2500 (+15%). This cost is only result of printing a full bucket without making any profit. Therefore, in order to make profit from selling parts, the product price would be even higher and, as a result, it is considered not feasible as a business solution.

## 5. Optimization of the production line

At this point, the HP MJF technology has been displayed and described end-to-end. Moreover, the baseline system configuration has been analysed with the conclusion that it cannot be used alone to be profitable for selling parts on the current market.

The results of the simulations also show how underused the system is by just using one asset of each kind.

In this section, the goal is to optimize the line as much as possible before resorting to other technologies of automations in the line.

To do it, 3 steps will be followed:

1. Calculate a theoretical optimization.
2. Run several simulations to find the optimum and compare it with the theoretical analysis.
3. Make an economic analysis of the result.

### 5.1. Theoretical optimization

Before starting the simulation, a calculation is done to collect a second result to compare the simulation with.

The main tool that will be used is the machine **connection rate**. This number relates each machine in the production line with the number of printers installed. The printer is taken as the central machine, so all the other equipment depend on the number of printers installed in the plant.

The formula of the connection rate is the asset time divided by the printing time.

This result answers how many assets we need per printer installed. For instance, the connection rate of the PS is calculated like:

$$PS \text{ Connection Rate} = \frac{\sum PS \text{ Process times}}{\text{Printing time}} = \frac{(0.75 + 0.5)}{13.5} = 0.093 \frac{PS}{Printer} \quad \text{Equation 5.1}$$

The result of this operation means that for each printer we need 0.093 PS, or doing the inverse, for each PS we can have up to 10 printers.

In the following table there is a sum up of all process times per machine and all the connection rates are calculated.

Number of Printer per Printer	Connect rate	<b>1</b>
Printing Time per job	hours/job	13.5
Number of PS per Printer	Connect rate	<b>0.093</b>
Loading time per job (PS)	hours/job	0.75
Extract to BC time per job	hours/job	0.5
PS maintenance per job	hours/job	0
Number of BU per printer	Connect rate	<b>1.09</b>
Loading time per job	hours/job	0.75
Printing Time per job	hours/job	13.5
Cooling time per job (in BU)	hours/job	0
Extract to BC time per job	hours/job	0.5
Number of BC per BU	Connect rate	<b>2.3</b>
Cooling time per job (in NCU)	hours/job	30
Extract to BC time per job	hours/job	0.5
Unpack time (from NCU) per job	hours/job	0.5
Number of Airblasters per printer	Connect rate	<b>0.04</b>
Airblasting time per job	hours/job	0.5
Number of Sandblasters per printer	Connect rate	<b>0.04</b>
Sandblasting time per job	hours/job	0.5
Number of AUS per printer	Connect rate	<b>0.04</b>
Unpack time (from NCU) per job	hours/job	0.5

Table 5.1: Machines connection rates.

With these results, the first thing that can be observed is that there are two types of machines:

- ❖ Connection rate > 1: Every time a printer is increased, this type of machines also increases in number. It is assumed that for each printer these machines will be bought as needed because these are not a cost driver compared to the other type.
- ❖ Connection rate < 1: One machine can serve many printers and it is a limiting factor every time the number of printers gets close to the maximum capacity of this type of machine. These are cost drivers.

From this table, the usage rate of each limiting machine can be extracted. In the graph below, there are two lines. The orange line for the PS and the blue one for AUS, AB & SB (as they share the same value).

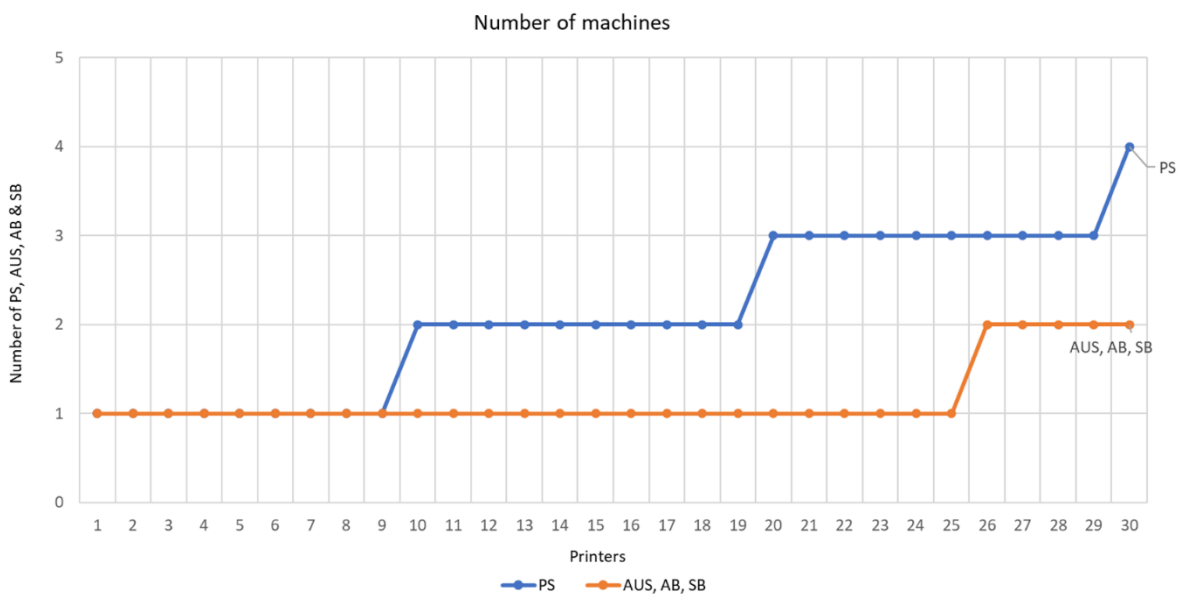

Figure 5.1: Evolution of PS, AUS, AB & SB per number of printers.

This graph shows the increase in number of PS, AUS, AB and SB when the number of printers also increases. In this result, the OOE is not computed yet.

To find the optimal scenario, the machine utilization rate of all machines is calculated and maximized.

The **machine utilization rate** (MUR) is calculated from the connection rates:

$$MUR = \text{Number of printers} \times \text{Connection Rate} \times 100 \quad \text{Equation 5.2}$$

If there are more than one machines the result will be greater than 100%, so it has to be divided by the number of machines to share the use between machines.

For each printer, a machine utilization rate is averaged and the OOE (machine uptime of 90% × 90% efficiency) equal to 80% is added to all connection rates. The following graph shows the evolution of the average machine utilization rates of all the limiting machines (PS, AUS, AB, SB) when increasing printers.

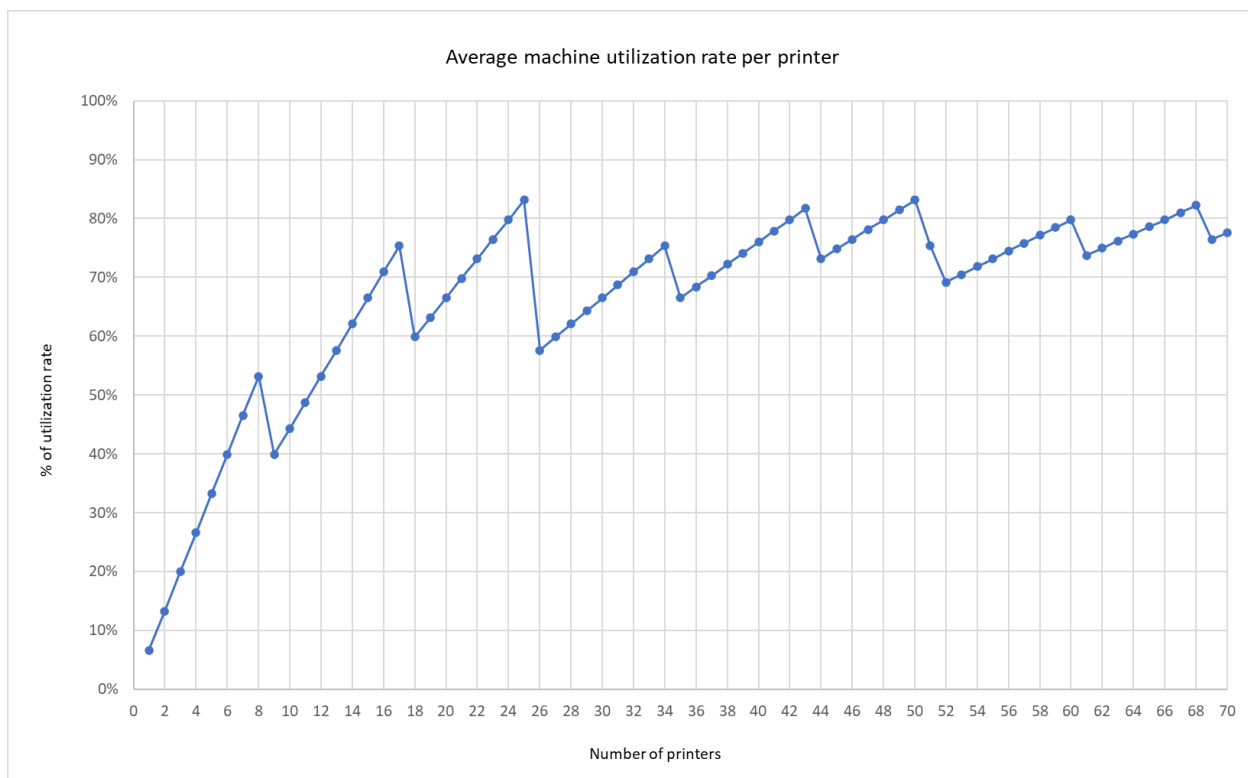

Figure 5.2: Average combined MUR of the MJF equipment.

The outcome of this representation is that the first optimal scenario is found with 8 printers at 53%, the second with 17 printers at 75% and the rest maintain around a similar level of uptime that stabilizes at 80% as the number of printers increases.



In this study, the optimal scenario that will be chosen is first maximum of MUR with 8 printers. The reason is that it would constitute a base 3D printing production line with an optimal layout. The next optimal is found at 18 printers, which means a much higher initial investment and a very little improvement in full bucket price (seen later on 5.3. Economic analysis).

With the initial connection rates Table 5.1: Machines connection rates., we can calculate the optimal theoretical configuration:

Printers	PS	BU	NCU	AB	SB	AUS
8	2	9	19	1	1	1

Table 5.2: HP MJF optimized configuration.

### 5.2. Model Plant Simulation

In this section, a new Plant Simulation model will be constructed to calculate all the production variables.

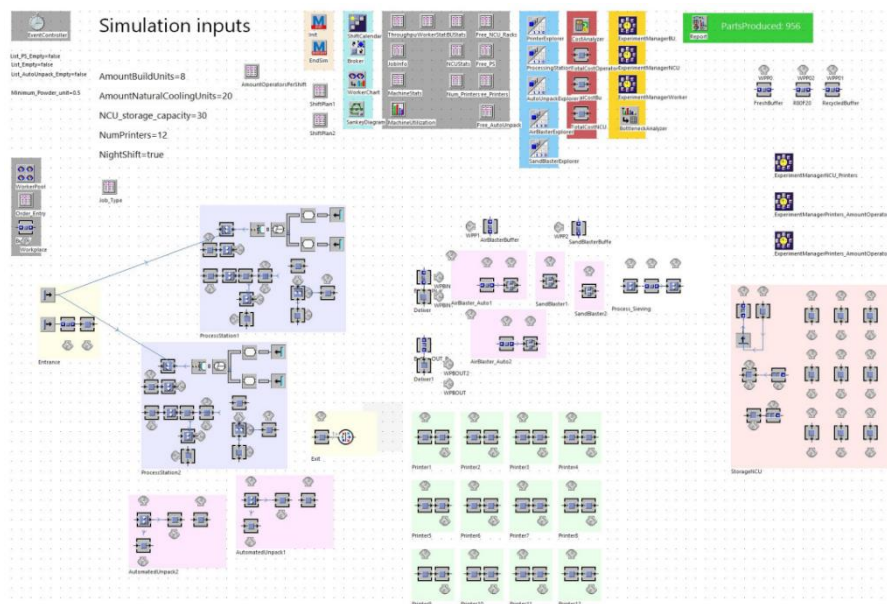

Figure 5.3: Twin model with Plant Simulation of the optimized configuration.

With the new model, many simulations have been run to determine how each variable impacts the production when increased in number. The model is optimized slowly varying slowly the number of assets until the optimum is found.

This particular simulation run doesn't determine the final capacity, but the optimal number of machines.

Here are the results:

- **Printer analysis**

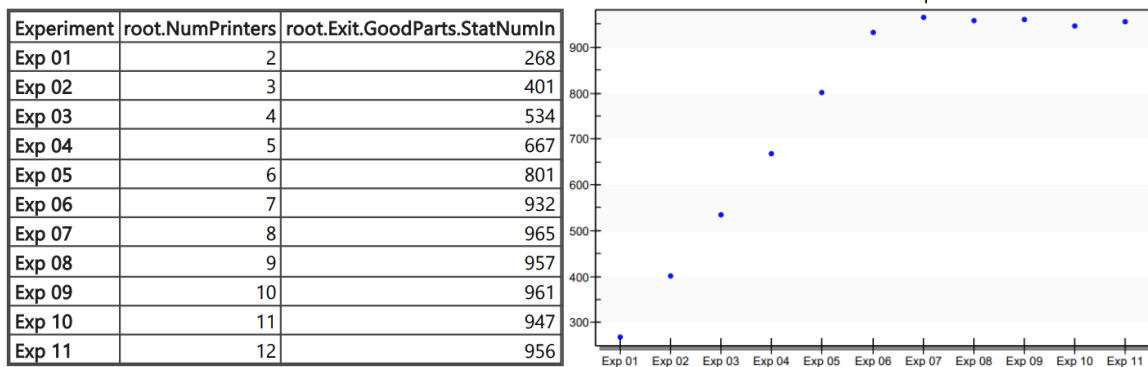

Figure 5.4: Experiment analysis results to find the optimal number of Printers'.

It is seen with the current scenario that the optimal number of printers is the experiment 06, with 7 printers. However, when checking the Printer's uptime (over 95%), we see that it is too high and therefore not realistic. One more printer is suggested, taking 8 Printers at the end. This value matches with what was calculated previously. From 9 printers the capacity does not increase any further.

• **Processing Station analysis**

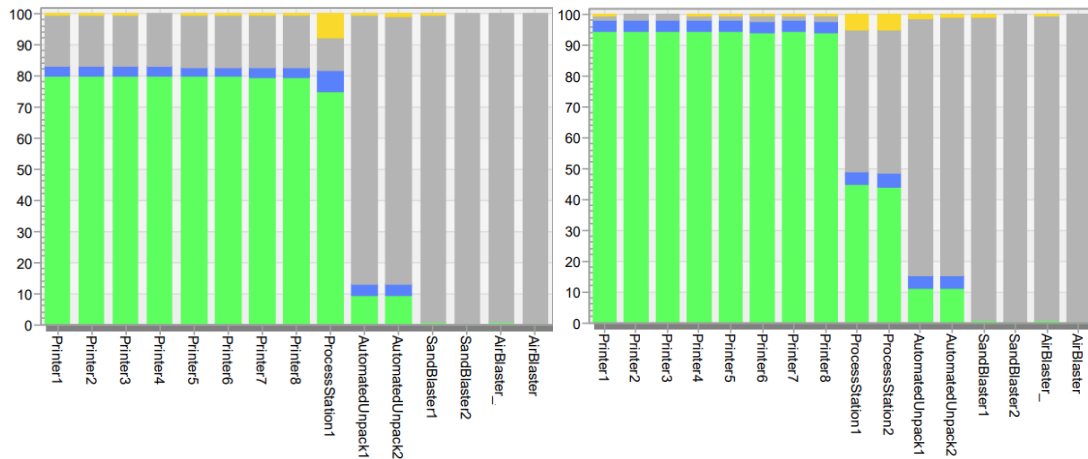

Figure 5.5: Experiment analysis results to find the optimal amount of PS's.

With 8 printers and redundant assets, this simulation shows how one PS (ProcessingStation1) is saturated and decreases the whole capacity by a 15%. With 2 PS, the utilization rate of both assets is 45% and they stop being a bottleneck.

The optimal number matches the theoretical calculation.

• **BU analysis**

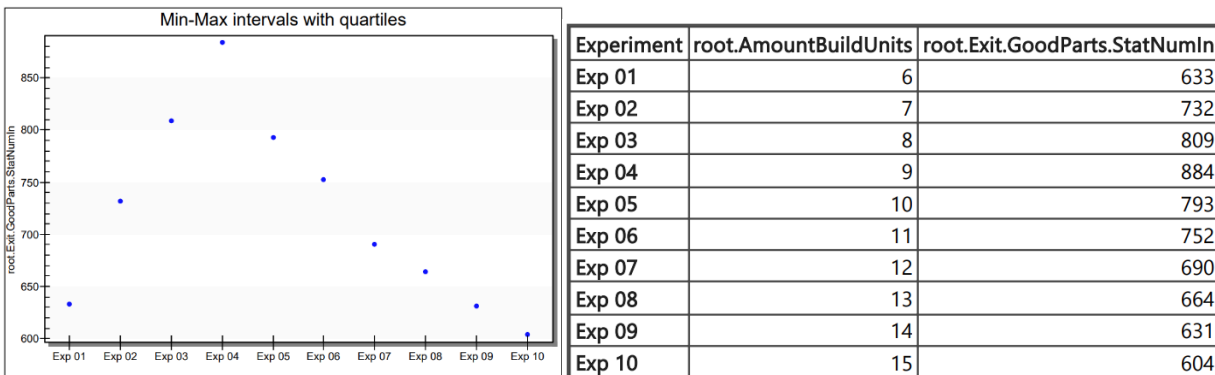

Figure 5.6: Experiment analysis results to find the optimal amount of BU's.

With the BU, it is clear that the optimal number of BU 9 units, where the capacity of the system is maximized, as seen in the vertical axis of plant throughput.

In this case, it is noticeable how the overall capacity decreases when adding more BU. It is due to the simulation methodology, that always forces workers to use all assets, at the end causing new inefficiencies like, for example, making extra loadings with the empty BU's.

This the BU number also matches the previously calculated result.

- **NCU analysis**

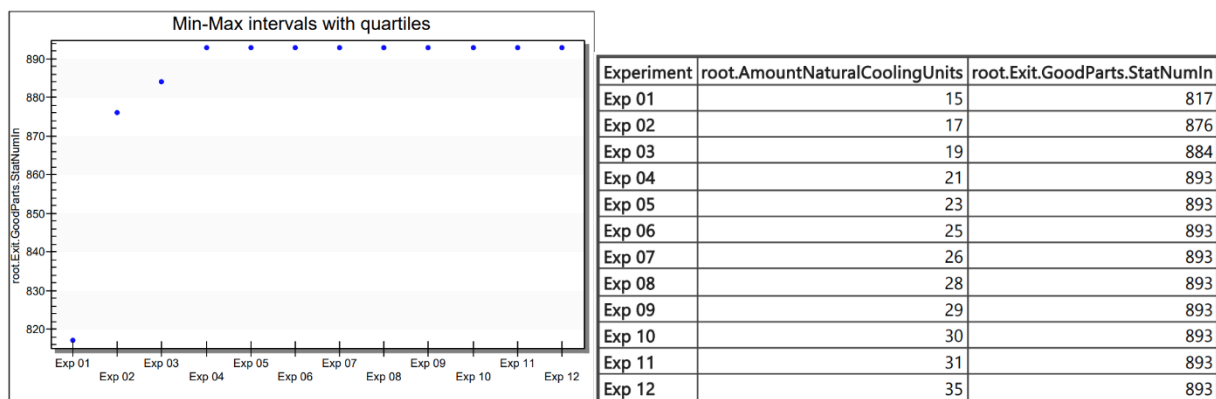

Figure 5.7: Experiment analysis results to find the optimal amount of NCU's.

With the NCU's, it is very clear that with 21 NCU's or more, the capacity doesn't change. Moreover, between 19 and 21 NCU's the capacity only increases a 1.1%.

Therefore, the optimal value taken is 19 NCU's, matching as well the initial calculated value and minimizing the costs.

- **Worker's analysis**

To perform the workers analysis, a complete one-month simulation was performed changing from 1 worker per shift (3 per day), to 3 workers per shift (9 per day).

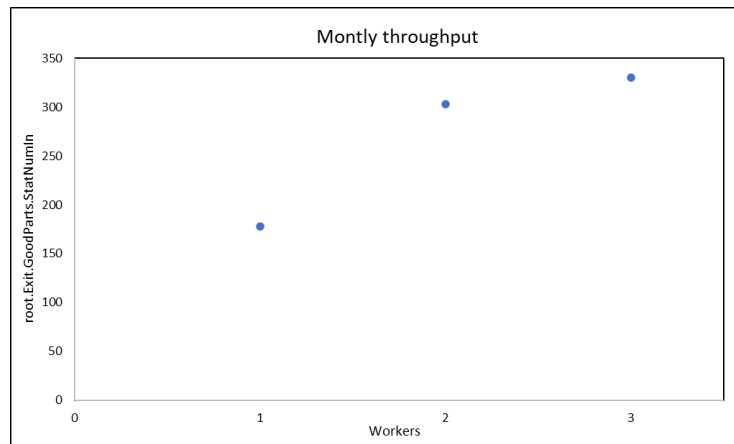

Figure 5.8: Experiment analysis results to find the optimal number of workers.

The scenario with 1 worker is discarded. To decide between 2 or 3 workers per shift, two more simulation of each scenario are performed. The first simulation with 2 workers resulted in a throughput of 300 buckets/month and the simulation with 3 workers per shift resulted in 330 buckets/month.

The results are the following:

	2 worker / shift	3 worker / shift
Monthly throughput	303	330
Printer utilization rate	80%	88%

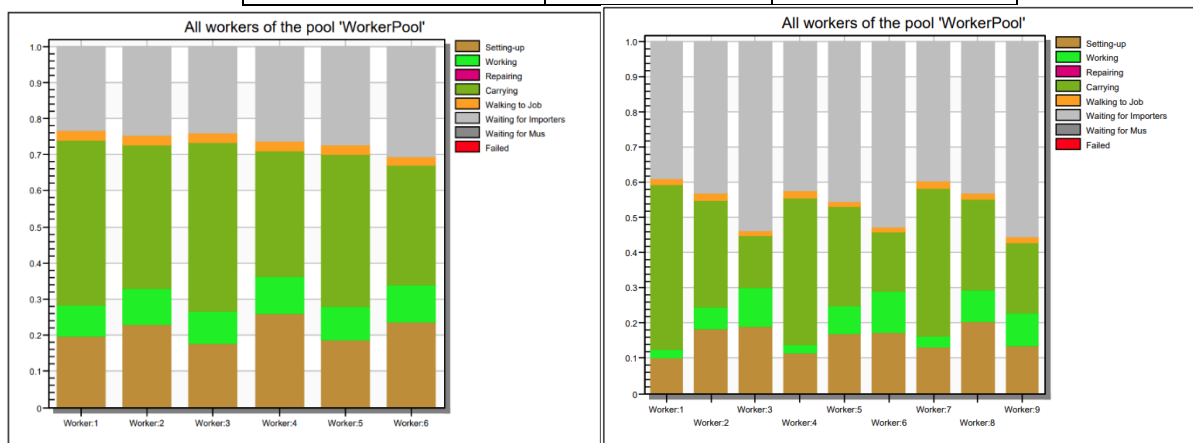

Figure 5.9: Second analysis results to find the optimal number of workers.

The scenario of 3 workers shows that the overall operating time is very low compared to 2 workers / shift. On the other hand, the throughput barely increases with high extra operating costs due to 3 extra workers per day.

Then, the optimal number of workers with 8 printers is 2 workers per shift.

• **Final plant analysis**

With all the parameters defined, the Plant Simulation model is run for one month and the results obtained are:

	Build jobs
Hour	0.40
Day	10.00
Week	70.10
Month	300.30
Year	3503.90

  

Carrier	Working	Setting-up	Waiting	Failed	Stopped	Paused
BU 1	0.77	0.01	0.22	0.00	0.00	0.00
BU 2	0.77	0.01	0.22	0.00	0.00	0.00
BU 3	0.77	0.01	0.22	0.00	0.00	0.00
BU 4	0.77	0.01	0.22	0.00	0.00	0.00
BU 5	0.77	0.01	0.23	0.00	0.00	0.00
BU 6	0.77	0.01	0.22	0.00	0.00	0.00
BU 7	0.77	0.01	0.22	0.00	0.00	0.00
BU 8	0.77	0.01	0.22	0.00	0.00	0.00
BU 9	0.77	0.01	0.23	0.00	0.00	0.00

- Hardware**
- BUs: 9
  - NCUs: 19
  - Printers: 8
  - Processing Stations: 2

- Labor**
- Workers per shift: 6
  - Simulated days per year: 360
  - Schedule:

Shift	From	To	Mo	Tu	We	Th	Fr	Sa	Su	Pauses
Shift-1	6:00	14:00	●	●	●	●	●	●	●	12:00-12:45
Shift-2	14:00	22:00	●	●	●	●	●	●	●	19:00-19:45
Shift-3	22:00	6:00	●	●	●	●	●	●	●	1:00-1:45

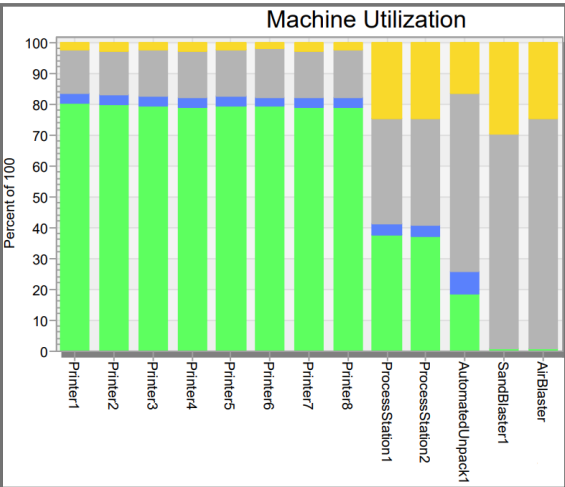

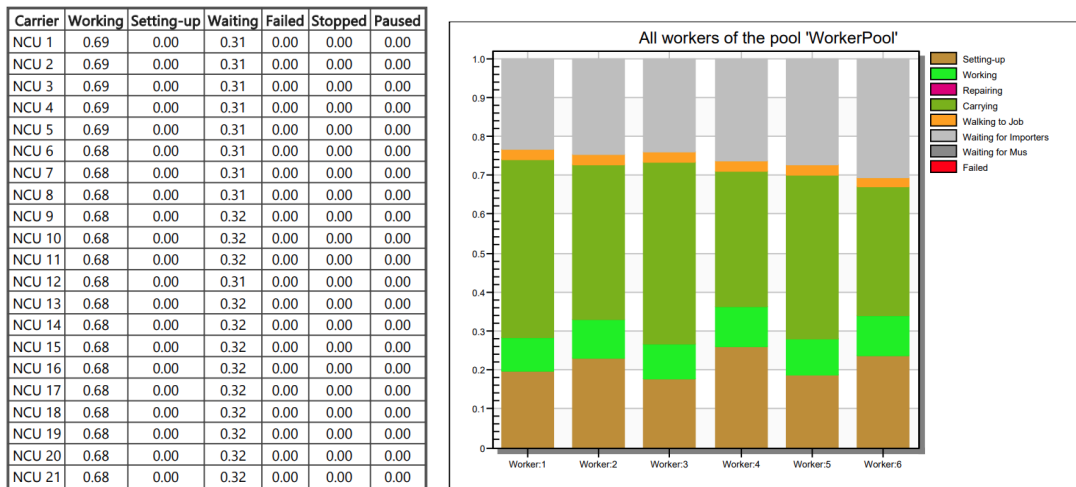

Figure 5.10: Fragment of the complete Plant Simulation result for the optimize MJF configuration.

To sum up, the final result shows the production results for a layout with 8 printers and its optimal number of assets. All the assets are optimized to maximize the utilization rate and minimize costs.

The number of workers is equal between shifts in order to simplify the analysis. By adding a seventh worker per day the throughput would increase even more, but it would complicate the workflow between shifts.

The monthly throughput of this scenario is 300 full buckets. Then, knowing the printer Theoretical Capacity (TC) of 1.778 jobs/(printer\*day), we can calculate that the optimized plant can perform at an Actual Capacity (AC) of 70.5% out of the total theoretical capacity. After the baseline optimization, the productivity has increased by 23.5 percentage points.

To give some perspective, using the *Saratech* business case of insoles (4.4.2 Economic analysis), with the current plant almost 300k insole pairs (600k parts) could be printed in one year.

The HP MJF 5200 technology has been studied at its basic level and has been optimized to its maximum. What this means is that at this point, the only thing that the user can do to increase the throughput is adding more equipment or personnel, but the user won't be able to increase the efficiency of the plant any further with the current system.

With these numbers the cost analysis can be done.

### 5.3. Economic analysis

The main goal at this point is to analyse what is the economic value of the HP MJF 3D printing plant, find out the return period and determine the investment productivity.

Using the cost model with all the parameters updated with the optimum scenario, these results are obtained:

<b>Production</b>	<b>Optimal 300 full buckets / month</b>
<b>Initial HW investment (CAPEX)</b>	\$1.851M
	Monthly
<b>Total variable cost</b>	\$129k
<b>Total fixed cost</b>	\$137k
	Breakdown
<b>Powder</b>	\$80400
<b>Consumables</b>	\$27500
<b>Factory supplies</b>	\$9300
<b>Rental &amp; Utilities</b>	\$27400
<b>Personal</b>	\$76500
<b>Depreciation</b>	\$17000
<b>Maintenance</b>	\$7100
<b>Uncertainty</b>	\$21100
<b>Total</b>	\$266220
<b>Full bucket price</b>	\$876 / FB

*Table 5.3: Cost model results of the MJF optimized configuration.*

This economic result really shows how much the full bucket cost is reduced.



The main factors for this decrease are the fixed expenses distributed among all buckets and reducing as much as possible all kind of wastes (inefficiencies, timeouts, machine idle time, etc). At the end, a stopped machine still contributes to rise operating expenses. Certainly, this optimization has achieved exactly that, reducing as much as possible the plant idle time and boosting the buckets produced.

As a result, the full bucket production cost has been reduced from \$2860 to \$885, a 70% cost reduction. On the other hand, the initial investment has been notably increased by a 270% from the baseline initial investment.

The difference between the baseline and the optimal is that the optimal can operate with the current full bucket market price and the return of investment clearly shows that in the next section.

- **Return of Investment (ROI)**

To finalise this analysis, the return of investment (ROI) is calculated to determine the performance of this investment and also the return period.

To do it, the cumulative cashflow of the 3D printing factory is calculated. The main values are:

- Initial investment: \$1851000
- Monthly operational cost: \$267000
- Monthly full buckets produced: 300
- Sale price of full bucket: \$2500

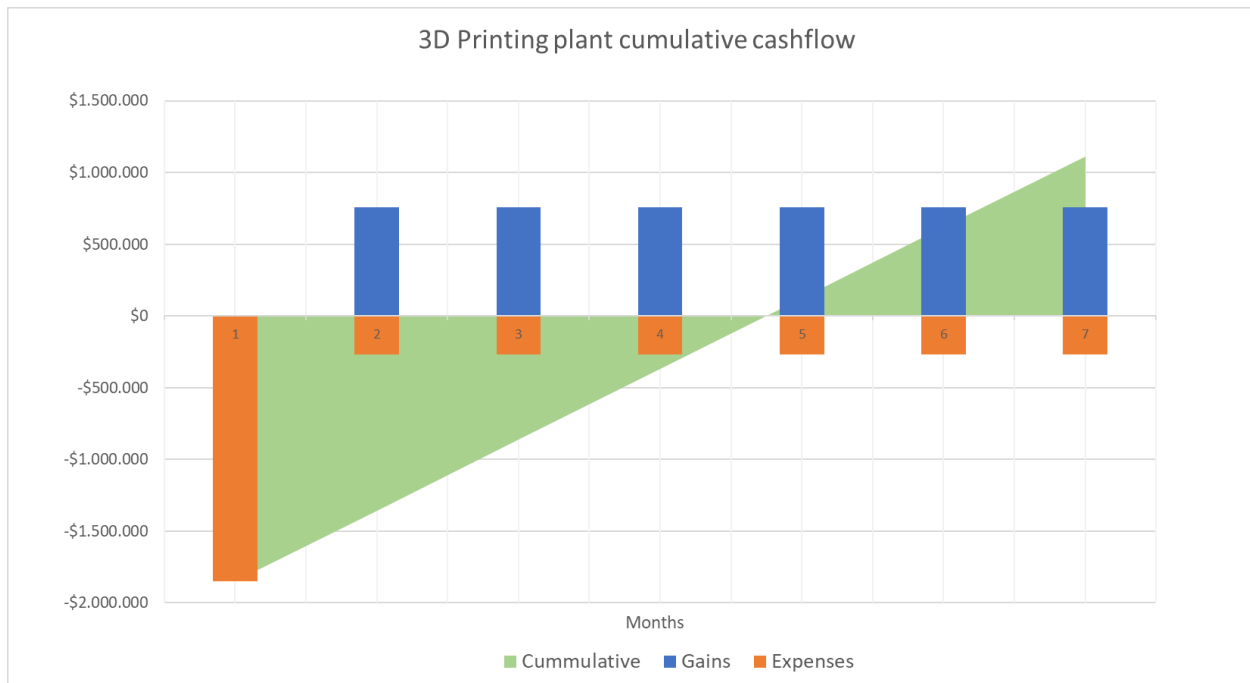

Figure 5.11: Cumulative cash flow of the MJF optimized configuration.

As seen in the graph, in only 5 months all the investment is returned and the balance is positive from this point. In this graph it is assumed that all printed buckets are sold at the market price.

With this information, we can also calculate the annualized ROI of 1 year using this formula:

$$ROI = \frac{\text{Net benefit per year}}{\text{Investment}} = \frac{300 \times 2500 \times 12}{1851000} \times 100 = 486\% \quad \text{Equation 5.3}$$

This KPI can be read as for each dollar invested in the project per year, the investor obtains 4.86 dollars.

This KPI value is very positive despite the high initial investment. This altogether with the short return period (RP) of only 5 months makes this 3D printing factory a very viable project, economically speaking (with the assumptions made above).

## 6. Automation of the 3D printing production line

At this stage, the HP MJF 5200 technology has been showed to have the potential to produce 20 buckets full of printed parts each month using the baseline configuration (one unit of each asset) for this technology. However, this setup does not have a competitive scale on the current market as an end-user manufacturing facility, due to high production costs.

After the baseline optimization done in the previous section, the monthly throughput has increased to 300 full buckets, achieving a plant productivity of 70.5%. With these improvements, the technology has been proven to be economically viable as a parts manufacturing facility.

The final goal is to define a methodology to further improve this technology and 3D printing factory and to determine one automation solution to begin with.

To do so, there are many ways to do it focusing on increasing profits:

- **Improve part quality:** This would allow the manufacturer to either raise prices or increase sells.
- **Producing more parts:** This can be done by growing the production line or by improving the factory efficiency.
- **Reducing operational costs:** This can be done by reducing process times, automating tasks, etc.

In this study, the main objective will be to reduce the operational cost of the plant and improving the overall efficiency through automating processes.

To do so, first a methodology is presented, then some automation projects will be chosen to finally show the results with the best automation solution.

### Automation plan

In this section, it is intended to identify potential processes to be automated and decide which one to choose. To achieve it, the Plant Simulation and Cost Model will be used.

The reasons to automate a production line are many. Here are some examples:

- ❖ Reduce operational cost.
- ❖ Improve part quality by eliminating hand-based operations.
- ❖ Reduce the throughput time.
- ❖ Improve plant efficiency by improving a bottleneck.

With this in mind, the first thing to do is to identify potential areas of improvement.

### 6.1. Step 1: Identify potential improvement projects

To start, each of the factors listed above is reviewed to find potential automation projects.

In a production line, one of the first KPI's to evaluate are **bottlenecks**.

A bottleneck is defined as an operation that is already working at its maximum capacity, and so cannot accept any additional work beyond its current production level. [19]

The bottlenecks can be listed in order as they start to appear. When you deal with the first one, the second process stopper appears. And I continue indefinitely with all processes.

This step can be done manually, using Gantt charts or Excel tables. However, this task performed in a complex industry could be impossible to do manually. Here is when current simulating technologies come into place.

Using a *digital twin* simulated model, the bottleneck list can be automatically generated and each project to solve it can be studied beforehand.

So, in this step, a bottleneck list is created using the bottleneck analyser in Plant Simulation with the current plant model. The first 3 bottlenecks found are the following:

1. Printing
2. Cooling
3. Loading

These bottlenecks can be overcome either by adding more machines (Printers, NCU's or PS) or by improving the base technology.

Therefore, there are no automations proposed from this analysis.

Regarding the **part quality** improvement, the main HP MJF should be modified to see any significant benefit. Therefore, no automation project is suggested in this area.

When it comes to **reducing throughput time**, there is a station that has the potential to be improved.

In this setup, the IPQC is done manually one part at a time. This process could be automated using an automated checking system that perform multiple verifications through a conveyor.

Finally, among many projects to improve **the operational cost**, it is proposed an automation in the part cleaning station, where now every part is cleaned manually by the worker. Using an automatic cleaning machine that could do several parts per cycle could reduce the personnel cost of this area of the plant.

## 6.2. Step 2: Propose solutions to the projects

### Project 1 - IPQC solution

The first automation proposed is a set of machines to perform the IPQC operations. Except for the L&F step, the other operations can be automated with current technologies.

The machine proposed is: Automatic weighing and scanner machine

To calculate the cost of this project, some machines with acceptable specifications have been selected. It is important to note that the final machine could be different as a result of different final parts. However, the main goal is to have a good picture of what would be a project of this characteristics.

The machine and its specifications are described below:



Figure 6.1: Automatic weighing and scanning machine. [33]

- Functions: Weighing, 3D scanning, dimensioning and conveyor.
- Throughput: Around 1 part per second.
- Price: \$20000.
- Engineering cost of the project: 30 hours (including project design, installation qualification, etc)

These specifications will be used to compare the project with the other candidate.

### **Project 2 - Part cleaning solution**

The other proposal is automating the cleaning process to remove the need for manual operations.

In this step there are two types of cleaning. Airblasting and Sandblasting.

The machine proposed is able to do either Airblasting and sandblasting with abrasive. Two machines are needed to fully automate the cleaning process.



Figure 6.2: Automatic cleaning machine with conveyor. [34]

- Functions: Airblasting, Sandblasting, conveyor.
- Throughput: Around 1 part per minute.
- Price: \$16000 dollars each one. \$32000 both of them.
- Engineering cost of the project: 30 hours (including project design, installation qualification, etc)

### 6.3. Step 3: Simulating the new scenarios

Once that we have the projects defined, it is time to model the scenario using Plant Simulation and perform a one month run to extract the production results.

#### Project 1 - IPQC solution

Assuming that one worker can process one part of the bucket in 25 seconds, we can calculate the proportional part of the time dedicated to measuring and reporting with a factor of 1/25. The other steps in IPQC are not modified.

The results may vary depending on the number of printed parts inside a full bucket.

Averaging it out, the result of process time after the improvement is:

	P/T per job	H/T %	H/T per job
New IPQC	8 min	75%	6 min

Table 6.1: Project 1 process time estimation after automation the automation.

The simulation results show that the need of workers goes from 6.8 workers per day (2.3 per shift) to 5.7 workers per day.

These numbers translated to throughput show that with the initial scenario the 6 workers could not unlock all the installed capacity of the plant. But, with this automation, the capacity is release, going from 300 full buckets per month to 311.

With this improvement, the productivity of the plant has increased to 72.5%.

Note that in both scenarios the number of workers operating are 6, in order to maintain the same number of workers per shift. In one scenario the 6 workers cannot fully operate the plant but in the second scenario the 6 workers have more time available to do it.

## Project 2 - Cleaning solution

With the installation of both machines, the stations TL6 and TL7 are connected now, eliminating a lot of human times of moving parts and manual cleaning. The cleaning time needed for each job is not reduced though, due to the cleaning method is the same (air + abrasive)

Between operations there is no set up time or recovery time thanks to a continuous operation. The only human operation needed is periodical maintenance and periodic abrasive refill.

The process times results are:

	P/T per job	H/T %	H/T per job
New TL6	25 min	4%	1 min
New TL7	25 min	4%	1 min

Table 6.2: Project 2 process time estimation after automation the automation.

The simulation results show that the need of workers goes from 6.8 workers per day (2.3 per shift) to 5.3 workers per day (1.8 per shift).



These numbers translated to throughput, similarly as the previous scenario, are from 300 full buckets per month to 323.

With this improvement, the productivity of the plant has increased to 75.3%.

#### 6.4. Step 4: Economic analysis

Now that we have all the production results for each candidate, the cumulative cashflow, ROI and return period can be calculated.

For both projects, it is assumed that both require the same design and installation time and the extra capacity created is also sold.

Inserting the new parameters into the cost model, we create 2 new parallel scenarios to the previous optimized plant that can be compared.

The comparison sum-up is:

	Optimized scenario	Project 1: IPQC	Project 2: Cleaning
<b>Monthly throughput</b> (full buckets / month)	300	310	323
<b>Productivity (AC/TC)</b>	70.5%	72.8%	75.8%
<b>Initial investment</b>	-	\$20k	\$32k
<b>Fixed cost</b>	\$138k	\$121k	\$132k
<b>Variable cost</b>	\$128k	\$130k	\$135k
<b>Full bucket price</b>	\$885	\$809	\$824
<b>Monthly gains</b> (Bucket sales – production costs)	\$483k	\$524k	\$540k

Table 6.3: Simulation results for each project compared to the optimized scenario.

With the results, the ROI can be calculated for each project using the formula:

$$ROI = \frac{\text{Net benefit}}{\text{Investment}} \times 100 \quad \text{Equation 6.1}$$

$$\text{Project 1 ROI} = \frac{\$524000 - \$483000}{\$20000} \times 100 = 205\% \quad \text{Equation 6.2}$$

$$\text{Project 2 ROI} = \frac{540000 - 483000}{32000} \times 100 = 178\% \quad \text{Equation 6.3}$$

And then, the return period (RP) is also calculated:

$$RP = \frac{\text{Investment}}{\text{Net benefit}} \quad \text{Equation 6.4}$$

$$\text{Project 1 RP} = \frac{20000}{524000 - 483000} = 0.5 \text{ months} = 15 \text{ days} \quad \text{Equation 6.5}$$

$$\text{Project 2 RP} = \frac{32000}{540000 - 483000} = 0.57 \text{ months} = 18 \text{ days} \quad \text{Equation 6.6}$$

After seeing that the return period is almost the same, the ROI result is used to decide which automation project will be performed first.

In this case, the *Project 1: IPQC* automation is chosen for having a lower initial investment and also having a better ROI. This project is able to reduce the operating cost more than the project 2 despite producing less parts and the cost reduction makes the project more appealing.

Nonetheless, the project 2 is also very positive for the plant economics that further increases its productivity and might be a very good candidate for the next investment.

This decision process can be done with all the stations, looking for ways to reduce attended tasks, to shorten process times or to robotize the movement of parts.

## 7. Economic analysis of this project

This section focuses on the actual cost to run this academic thesis during the past months. The duration of the project and task program is defined below.

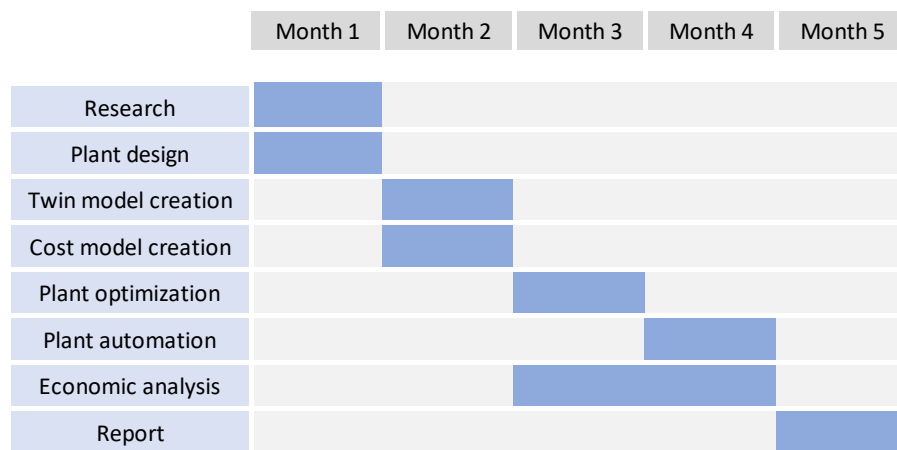

Figure 7.1: Gantt diagram of the project planification.

It is assumed that this project is run by an entry level engineer on his own and only during an 8 working hours per day. All the materials, software and appliances needed during the time of the project are considered.

All the parameters evaluated are:

- Engineering time: hours spend by an engineer to complete this thesis. It is calculated by the average year salary of \$30000 (15,62€/hour) and the 360 hours equivalent to 12 ECTS. Multiplying the salary by the hours we obtain an engineering cost of 5625€.
- Software licencing: there are 2 programs required during the project are:
  - Microsoft Office: 69€/year, 45 days of working (8hours/day). Multiplying it results in 9€ during this project.
  - Plant Simulation: Can vary depending on the deal. 10k€/year for a single license, and run for 45 days of working. Dividing 10000€ by 365 days per year and multiplying the 45 days of the project we obtain a cost of 1323€.

- Computer: a high-performance computer is needed to run Plant Simulation software costing 2000€/unit. The cost is calculated based on a product lifespan of 5 years and computed in the 45 days period. Multiplying 45 days by 2000€/5 years we obtain a cost of 50€ for this project.
- Electricity used during this period: The average cost of electricity during the day is about 0.3 €/kWh [35]. Knowing that the average computer consumes 100W, it results in 0.8kWh/day and multiplying by 45 days we obtain a 36€ expense of electricity.

The results can be found in the following table:

	Amount	Total cost
Engineering	360 hours	5625€
Office	45 days	9€
Plant Simulation	45 days	1232€
Computer	45 days	50€
Electricity	36kWh	36€
<b>Total</b>		<b>6952€</b>

Table 7.1: Cost analysis results of this thesis.

The cost of this project is orders of magnitude lower than the range of initial investments for the 3D printing factory. In this scenario, the cost is completely justified because this study allows the investor to greatly optimize the equipment.

However, assuming the factory is already running, the cost of this project and analysis is, on average, a 27% of the initial automation investments. Considering that the automation projects have a very high profitability with a ROI of 2 (for each dollar invested the project returns 2 dollars), and many improvement projects can be done at once, this project is justified.

## 8. Environmental impact

This project has a carbon footprint associated with the energy consumption by the electricity consumed by the computer and also one visit done to HP facilities.

Regarding the electricity emissions, according to *Red Eléctrica* [22] the last calculated CO<sub>2</sub> emissions per electricity generated were on average in Spanish territory 190 kg CO<sub>2</sub>/MWh.

Taking the result from the Table 7.1: Cost analysis results of this thesis. the total CO<sub>2</sub> can be calculated by multiplying 0.19kg of CO<sub>2</sub>/MWh by 36 kWh. In total, there were emitted 6.48 kg of CO<sub>2</sub> by the electricity consumed.

Moreover, the CO<sub>2</sub> emitted by the car trip to the HP facilities is added considering an average car emission of 0.14352 kg/km [23] and applying a 40 km trip it equals a total of 5.74 kg of CO<sub>2</sub>.

Adding up both emissions we get a total project carbon foot-print of about 196 kg of CO<sub>2</sub>.

Despite these emissions, this project aims to highly optimize industrial equipment so that it can produce much more parts with an existing setup, increasing the efficiency and reducing the emissions per part produced. Furthermore, when executing the optimization process, it helps preventing the need for more machines by extracting as much capacity as possible from the existing ones.

## Conclusions

The HP MJF technology has been proven very capable of achieving a high-volume production line capable of delivering up to 600k profitable parts with the business case presented.

The digital twin simulation model has been validated after performing a second calculated optimization analysis and comparing both scenarios with very similar results. In both, the

parameters closely match and the simulation can as well present many more KPI's and graphs to understand them. Furthermore, the Plant Simulation model can monitor many other parameters, such as worker speed or layout design, that the theoretical analysis can't take into consideration. As a result, the twin model can output much precise and closer to real-life production analysis.

Thanks to having a production line digital twin, any improvement projects scenarios can be analysed and tested in advance. This allows to make a decision based on best production results validated with the simulation. It has been very helpful in this use case of automating the 3D printing factory where the proposed automations have been tested in the simulation with very fast results.

By also having a cost model, all the scenarios can be very easily analysed to find out which improvement project have a bigger and faster economic return and how the different changes affect the fixed and variables expenses of the plant. It is also useful to identify which parameters are the biggest cost drivers and how that impact in the final bucket price.

These tools have enabled a way to define a scale-up path to follow every time the production needs to increase, by finding out the plant bottleneck, understanding production inefficiencies, tracking machine utilization rate and many other production parameters. With this understanding, it is easier to make a decision on which new equipment is needed and when will be needed, without acquiring more machines that are not really needed. Thus, the machine unused time is greatly reduced.

This study has found the optimal minimum-cost MJF setup with a productivity of 70.5% from the theoretical output of 8 HP 5200 Printers, complementing them with the minimum equipment needed to maximize their actual capacity. In spite of having a high initial investment, the ROI analysis and the return period show that, providing a sufficient demand, the project is financially attractive and viable.

Without stopping here, the technology has achieved a productivity even higher thanks to adding automation solutions to the existing optimal plant. The automations have proved to increase the productivity of the plant further than the technology can achieve. Thanks to that, the plant is able to produce more parts and to reduce the final printed parts, making the 3D printing factory even more profitable.

Despite all the benefits of this simulating resources, they have a cost associated with performing the analysis that have to be added to the whole project, for instance, the Siemens software or the high-end computer. Still, if this practice becomes a habit, the factory can keep reducing costs in a long term by analysing the performance of the plant and improve it to a great extent while amortizing the simulation cost.

The time needed to build the first twin model and fine tune it cannot be overlooked. It is true that the first attempts and the learning curve take at least one or two months and it may also discourage manufacturers from adopting this tool. However, once the twin model is completed, the learning curve accelerates and every new scenario to analyse is much more agile and fast than the first time. As a result, the more this tool is used the better can work, thanks to continuous improvement.

The study finalises with the first automation project simulated and analysed so that the manufacturer can see the first iteration of a plant automation, followed by a second automation suggestion also analysed. Therefore, leaving the engineers with a very easy path to keep improving the productivity and efficiency of their 3D printing plant or even any other manufacturing facility that could benefit from this study.

## Acknowledgement

This project would have not been possible without the help of the 3D printing Factory Engineering team from HP Barcelona. They gave me the chance to work during my internship with state-of-the-art technology of many fields which allowed me to develop this study and gain a lot of knowledge that I would later use here. Furthermore, I had the chance to use their Plant Simulation software for my research.

Therefore, I want to express my gratitude to the whole team for the help, the time they spent teaching me and helping me to grow as an engineer.

Special thanks to Francesc Salas for all the continuous support the whole time and also to Pablo Murciego for giving me this opportunity and unlocking all the resources I could use during this thesis.

I would also like to thank Mr. Hector Ortiz for his guidance and mentoring throughout the research.

Last but not least, I want to thank all my family and friends that supported me a lot helping me to finish this thesis, specially to Arnau Canyadell for all the effort and close support during the execution of this thesis.



# Contents

## Figures

Figure 2.1: FDM schematics [5]..... 10

Figure 2.2: SLA schematics [5]..... 11

Figure 2.3: SLS schematics [4]..... 12

Figure 2.4: MJF schematics [6] ..... 13

Figure 3.1: Plant Simulation model example [29] ..... 15

Figure 3.2: OEE summary [30]..... 17

Figure 4.1: HP MJF 5200 system [31]..... 19

Figure 4.2: HP MJF 5200 Loading process [6]..... 22

Figure 4.3: Workflow of TL1 Loading ..... 22

Figure 4.4: Workflow of TL2 Printing..... 23

Figure 4.5: Insert BU into the Printer operation [14] ..... 23

Figure 4.6: HP MJF Extract from BU to NCU operation. [9] ..... 24

Figure 4.7: Workflow of TL3 Extract..... 24

Figure 4.8: Workflow of the TL4 Cooling..... 25

Figure 4.9: HP MJF Unpack from NCU operation. [9]..... 26

Figure 4.10: Workflow of TL5 Unpack..... 26

Figure 4.11: ABSshot S9 equipment. [10]..... 27

Figure 4.12: Workflow of TL6 Airblasting..... 27

Figure 4.13: Workflow of TL7 Sandblasting..... 28

Figure 4.14:Workflow of TL8 IPQC..... 29

Figure 4.15: Workflow of TL9 P&S..... 29

Figure 4.16: HP MJF end-to-end production workflow..... 30

Figure 4.17: Gantt diagram of the first printed jobs..... 32

Figure 4.18: Fragment of the Gantt diagram. Third and fourth printed jobs..... 33

Figure 4.19: HP MJF baseline optimized layout..... 35

Figure 4.20: Cost model screenshot..... 36

Figure 4.21: Twin model of the MJF production line made with Plant Simulation..... 40

Figure 4.22: MUR of baseline simulation during 1 month..... 41

Figure 4.23: Worker’s utilization rate of baseline 30 days simulation..... 42

Figure 5.1: Evolution of PS, AUS, AB & SB per number of printers..... 47

Figure 5.2: Average combined MUR of the MJF equipment..... 48

Figure 5.3: Twin model with Plant Simulation of the optimized configuration. ....	49
Figure 5.4: Experiment analysis results to find the optimal number of Printers'. ....	50
Figure 5.5: Experiment analysis results to find the optimal amount of PS's. ....	51
Figure 5.6: Experiment analysis results to find the optimal amount of BU's. ....	51
Figure 5.7: Experiment analysis results to find the optimal amount of NCU's.....	52
Figure 5.8: Experiment analysis results to find the optimal number of workers. ....	53
Figure 5.9: Second analysis results to find the optimal number of workers. ....	53
Figure 5.10: Fragment of the complete Plant Simulation result for the optimize MJF configuration. ....	55
Figure 5.11: Cumulative cash flow of the MJF optimized configuration. ....	58
Figure 6.1: Automatic weighing and scanning machine. [33] .....	62
Figure 6.2: Automatic cleaning machine with conveyor. [34].....	63
Figure 7.1: Gantt diagram of the project planification. ....	67

## Equations

Equation 3.1 .....	17
Equation 4.1 .....	32
Equation 4.2.....	32
Equation 4.3.....	34
Equation 4.4.....	34
Equation 5.1 .....	45
Equation 5.2.....	48
Equation 5.3.....	58
Equation 6.1 .....	66
Equation 6.2.....	66
Equation 6.3.....	66
Equation 6.4.....	66
Equation 6.5.....	66
Equation 6.6.....	66

## Tables

Table 4.1: Process times .....	31
Table 4.2: Cost model results of the MJF 5200 baseline configuration.....	44
Table 5.1: Machines connection rates.....	46
Table 5.2: HP MJF optimized configuration. ....	49
Table 5.3: Cost model results of the MJF optimized configuration.....	56
Table 6.1: Project 1 process time estimation after automation the automation. ....	64
Table 6.2: Project 2 process time estimation after automation the automation. ....	64
Table 6.3: Simulation results for each project compared to the optimized scenario.....	65
Table 7.1: Cost analysis results of this thesis. ....	68

## References

- [1] BCN 3D, *When Was 3D printing Invented? The History of 3D printing - (bcn3d.com)*, [<https://www.bcn3d.com/the-history-of-3d-printing-when-was-3d-printing-invented/>], 15<sup>th</sup> of May 2020]
- [2] MATT AHART, *Types of 3D printing Technology Explained*, [<https://www.protolabs.com/resources/blog/types-of-3d-printing/>], 3<sup>rd</sup> of June 2019]
- [3] 3DPRINTING.COM, *What is 3D printing? How does a 3D printer work? Learn 3D printing*, [<https://3dprinting.com/what-is-3d-printing/>], 20<sup>th</sup> of June 2022]
- [4] ALL3DP, *The Types of 3D printing Technology in 2022*, [<https://all3dp.com/1/types-of-3d-printers-3d-printing-technology/>], 28<sup>th</sup> of October 2021]
- [5] FORMLABS, *3D printing Technology Comparison: FDM vs. SLA vs. SLS*, [<https://formlabs.com/blog/fdm-vs-sla-vs-sls-how-to-choose-the-right-3d-printing-technology/>], 15<sup>TH</sup> of March 2022]
- [6] HP 3D PRINTING, *HP Jet Fusion 5200 Series 3D printing Solution. Product Documentation User Guide, 2021*, [<https://support.hp.com/sq-en/product/hp-jet-fusion-5200-3d-printer/29090107/manuals>].
- [7] SCULPTEO, *HP Multi Jet Fusion Technology for 3D Printing*, [<https://www.sculpteo.com/en/materials/jet-fusion-material/>], 17<sup>th</sup> of April 2022]

- [8] ENGINEERING THE DIGITAL TRANSFORMATION COMPANY, *Siemens Tecnomatix Plant Simulation*, [<https://www.engusa.com/en/product/siemens-tecnomatix-plant-simulation>], 11<sup>th</sup> of June 2022]
- [9] HP 3D PRINTING AND COMPUTING, *HP jet fusion 5200 how it works*, [<https://www.youtube.com/watch?v=FDIDPRszBpA>], 3<sup>rd</sup> of July 2019]
- [10] ABSHOT TECNICS, S9 « *ABshot Tecnics S.L. – Air blasting ABSHOT*, [<https://abshot.es/productos/maquinas-de-chorrear-arena/maquinas-estandar/s9/>], 13<sup>TH</sup> of June 2022]
- [11] MASTER GRAPHICS, *How much does the HP 3D printer cost?*, [[https://blog.mastergraphics.com/expert\\_advice/how-much-does-the-hp-3d-printer-cost](https://blog.mastergraphics.com/expert_advice/how-much-does-the-hp-3d-printer-cost)], 12<sup>th</sup> of September 2019]
- [12] MIKE LUKER, *7 tips on HP MJF 3D printing (multi jet fusion) - Motion X*, [<https://www.motionx.com.au/7-tips-on-hp-mjf-3d-printing/>], 4<sup>th</sup> of April 2020]
- [13] FAST RADIUS, *Cloud Manufacturing & Digital Supply Chain*, [<https://www.fastradius.com/>], 20<sup>th</sup> of June 2022]
- [14] SARATECH, *Manufacturing insoles with HP MJF technology*, [[https://saratech.com/wp-content/uploads/2019/07/Manufacturing-Insoles-with-HP-Multi-Jet-Fusion-Technology-HP-3D-MJF\\_SARATECH.pdf](https://saratech.com/wp-content/uploads/2019/07/Manufacturing-Insoles-with-HP-Multi-Jet-Fusion-Technology-HP-3D-MJF_SARATECH.pdf)], July 2019]
- [15] IBERLEY, *Tablas de coeficientes de amortización del Impuesto sobre Sociedades*, [<https://www.iberley.es/temas/tablas-amortizacion-i-sociedades-30681>], 26<sup>th</sup> of May 2022]
- [16] JASON FERNANDO, MARGARET JAMES, SUZANNE KVILHAUG, *Capital Expenditure (CapEx) Explained with Examples*, [<https://www.investopedia.com/terms/c/capitalexpenditure.asp>], 9<sup>th</sup> of February 2022]
- [17] LUCILA BARONE, *Manufacturing Metrics: TEEP, OOE, OEE, and Takt*, [<https://4iplatform.com/blog/manufacturing-metrics-teep-ooe-oeo-and-takt-time/>], 12<sup>TH</sup> of April 2022]
- [18] LEAN PRODUCTION, *Understanding OEE in Lean*, [<https://www.leanproduction.com/oeo/>], 14<sup>th</sup> of June 2022]
- [19] ACCOUNTING TOOLS, *Bottleneck definition*, [<https://www.accountingtools.com/articles/bottleneck>], 17<sup>th</sup> of May 2022]

- [20] IBM, *What is a digital twin?*, [ <https://www.ibm.com/topics/what-is-a-digital-twin>, 19<sup>th</sup> of June 2022]
- [21] ASQ, *Value Stream Mapping Tutorial - What is VSM?*, [ <https://asq.org/quality-resources/lean/value-stream-mapping>, 20<sup>th</sup> of June 2022]
- [22] RED ELECTRICA ESPAÑOLA, *Emissions from the Spanish electricity system have fallen by 30 million tonnes in the last 5 years*, [ <https://www.ree.es/en/press-office/news/featured-story/2020/06/emissions-spanish-electricity-system-have-fallen-30-million-tonnes-last-5-years>, 4<sup>th</sup> of June 2020]
- [23] LUIS REYES, *Calcular el CO2 del coche a partir de consumo de combustible*, [ <https://www.autonocion.com/calcular-el-co2-a-partir-del-consumo/>, 16<sup>th</sup> of November 2021]
- [24] DAVIDE, POLYD, *Pros and cons of 3D printing technologies: FDM, MJF and INJECTION*, [ <https://polyd.com/en/blog/fdm-mjf-injection>, 11<sup>th</sup> of June 2021]
- [25] HUBS, *What is Multi Jet Fusion (MJF)? Explained by Hubs*, [ <https://www.hubs.com/knowledge-base/what-is-multi-jet-fusion/#faq>, 23<sup>th</sup> of June 2022]
- [26] HP PRINTING AND COMPUTING, *Digital Manufacturing Network*, [ <https://reinvent.hp.com/us-en-3dprint-digitalmanufacturing>, 21<sup>th</sup> of June 2022]
- [27] SHIVENDRA HAZARI, DR. NAGENDRA SOHANI, *Capacity Planning and Layout Optimization, 2017, International Journal of Scientific Engineering and Research (IJSER), Paper ID: IJSER171664, pp. 152-157*  
[ <https://www.ijser.in/archives/v5i7/IJSER171664.pdf>]
- [28] JOSEIN LANGSRAIN, *An introduction to value stream mapping analysis, 2016, Linkoping University*, [ <https://www.diva-portal.org/smash/get/diva2:945581/FULLTEXT01.pdf>]
- [29] AVANTEK CT SOLUTIONS, *Tecnomatix Plant Simulation: ventajas y funcionalidades*, [ <https://avantek.es/productos/tecnomatix/tecnomatix-plant-simulation/>, 20<sup>th</sup> of June 2022]
- [30] OEE COACH, *Implantar la OEE y mejorarla en 3 pasos* [ <https://oee.coach/>, 20<sup>th</sup> of June 2022]

- [31] KAUT-BULLINGER, *HP 3D Automatische Entpackungsanlage 5200*, [[https://www.printingsolutionpartner.de/hp-3d-automatische-entpackungsanlage-5200-a\\_52\\_alle.php](https://www.printingsolutionpartner.de/hp-3d-automatische-entpackungsanlage-5200-a_52_alle.php), 20<sup>th</sup> of June 2022]
- [32] OEE.COM, *What Is OEE (Overall Equipment Effectiveness)?*, [[www.oee.com](http://www.oee.com), 20<sup>th</sup> of June 2022]
- [33] SENAD ROBOTS, *Transportador de pesaje automático, máquina de escaneo 3d, escáner de correa, sistema de almacén automático*, [[https://spanish.alibaba.com/p-detail/Automatic-1600542120448.html?spm=a2700.galleryofferlist.normal\\_offer.d\\_title.fd997b41hd3a0j](https://spanish.alibaba.com/p-detail/Automatic-1600542120448.html?spm=a2700.galleryofferlist.normal_offer.d_title.fd997b41hd3a0j), 20<sup>th</sup> of June 2022]
- [34] HANGZHOU KAFAN MACHINERY & EQUIPMENT, *Automática De Chorro De Sandblast Cabinet Conveyor*, [[https://spanish.alibaba.com/p-detail/Automatic-62417448161.html?spm=a2700.galleryofferlist.normal\\_offer.d\\_image.2b9836876INQ8G&s=p](https://spanish.alibaba.com/p-detail/Automatic-62417448161.html?spm=a2700.galleryofferlist.normal_offer.d_image.2b9836876INQ8G&s=p), 22<sup>th</sup> of June 2022]
- [35] ESIOS, *Termino de facturación de energía activa del PVPC 2.0 TD*, [[https://www.esios.ree.es/es/analisis/1001?vis=1&start\\_date=01-01-2021T00%3A00&end\\_date=27-06-2022T23%3A00&compare\\_start\\_date=31-12-2020T00%3A00&groupby=day&compare\\_indicators=1013,1014,1015&level=1](https://www.esios.ree.es/es/analisis/1001?vis=1&start_date=01-01-2021T00%3A00&end_date=27-06-2022T23%3A00&compare_start_date=31-12-2020T00%3A00&groupby=day&compare_indicators=1013,1014,1015&level=1), 27<sup>th</sup> of June 2022]

