

2022-07

Development of integrated sensor network for agro-meteorological data collection in Tanzania

Mathew, Gaudence

NM-AIST

<https://dspace.nm-aist.ac.tz/handle/20.500.12479/1625>

Provided with love from The Nelson Mandela African Institution of Science and Technology

**DEVELOPMENT OF INTEGRATED SENSOR NETWORK FOR AGRO-
METEOROLOGICAL DATA COLLECTION IN TANZANIA**

Gaudence Mathew

**A Dissertation Submitted in Partial Fulfillment of the Requirements for the Degree of
Master's in Information and Communication Science and Engineering of the Nelson
Mandela African Institution of Science and Technology**

Arusha, Tanzania

July, 2022

ABSTRACT

Generally, the variation of meteorological conditions has a significant influence on the agriculture sector. In Tanzania, most of the existing automatic meteorological stations are not working, and during the data collection the surveyed manual meteorological stations record meteorological data in the cards daily, but cards are sent in a month to month time interval to the respective organs, this makes the concept of early warning difficult. Therefore, having near-real-time meteorological data will enable crop monitoring and forecasting systems to monitor crop development and provide early warning to the farmers and the government. The advancement of the Internet of Things (IoT) offers possibilities for developing an integrated sensors network to collect meteorological data on a near-real-time basis. In his study, the developed integrated sensor network includes sensors, which record remote meteorological data such as rainfall, humidity and temperature, a communication network, and a web application that enhance data visualisation in both graphical and tabular format. In the communication system, the LoRa technology was used, which is preferable compared to other Low Power Wide Area Network (LPWAN), technologies such as NB-IoT and SigFox for this application. The developed system uses the LoRa Gateway Operating system which provides capabilities to build a private network, and make it more cost-efficient by reducing the operation cost for account subscription, in online platforms such as The Things Network (TTN), ThingPark, ThingSpeak, and Lorient to avoid free accounts limitations. Moreover, the developed system can work in remote areas with limited Internet access as the meteorological stations can communicate with the gateway at a distance of up to 25 km.

DECLARATION

I, Gaudence Mathew, do hereby declare to the Senate of the Nelson Mandela African Institutions of Science and Technology that this dissertation is my original work and that it has neither been submitted nor being concurrently submitted for a degree award in any other institution.

Gaudence Mathew



02/08/2022

Name and Signature of Candidate

Date

The above declaration is confirmed by:

Dr. Mussa Ally Dida



2nd Aug. 2022

Name and Signature of Supervisor

Date

COPYRIGHT

This dissertation is a copyright material protected under the Berne Convention, the copyright Act of 1999 and other International and National enactments, in that behalf, an intellectual property. It should not be reproduced by any means, in full or in part, except for short extracts in fair dealing, for research or private study, critical scholarly review or discourse with an acknowledgement; and without a written permission of the Deputy Vice Chancellor for Academic, Research and Innovation, on behalf of both the author and the Nelson Mandela - African Institution of Science and Technology.

CERTIFICATION

The undersigned certifies that has read and hereby recommend for acceptance by the Senate of the Nelson Mandela African Institution of Science and Technology the dissertation entitled: “*Development of Integrated Sensor Network for Agro-Meteorological Data Collection in Tanzania*”, in Partial Fulfilment of the Requirements for the Degree of Master’s in Information and Communication Science and Engineering of the Nelson Mandela African Institution of Science and Technology.

Dr. Mussa Ally Dida

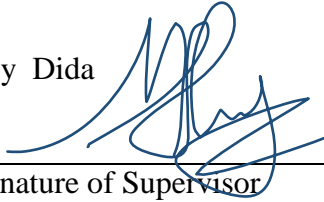

Name and Signature of Supervisor

2nd Aug. 2022

Date

ACKNOWLEDGEMENTS

My sincere gratitude to the all-powerful God for the gift of life, and his guidance throughout my life, particularly when I was pursuing my master's degree at Nelson Mandela African Institution of Science and Technology (NM-AIST).

Secondly, it is with incredible joy I accept this open door to pass my earnest gratitude to my supervisor Dr. Mussa Ally Dida for his guidance throughout the research work. I would also like to like to convey my gratitude to Dr. Anael Sam, and Dr. Han Komakech for their inputs on this research work.

Thirdly, I would like to thank my family, and friends for their support, and encouragement during my studies. In a special way, I would like to convey my appreciation to the Dean of students Madam Analyce Ichwekeleza for her encouragement and facilitation for me to resume my studies.

Lastly, my appreciation to the students and staff at NM-AIST for their support and hospitality during my time at NM-AIST.

TABLE OF CONTENTS

ABSTRACT.....	i
DECLARATION	ii
COPYRIGHT.....	iii
CERTIFICATION.....	iv
ACKNOWLEDGEMENTS	v
TABLE OF CONTENTS	vi
LIST OF TABLES	ix
LIST OF FIGURES.....	x
LIST OF APPENDICES	xii
LIST OF ABBRIVIATIONS AND SYMBOLS.....	xiii
CHAPTER ONE	1
INTRODUCTION.....	1
1.1 Background of the Problem.....	1
1.2 Statement of the Problem	2
1.3 Rationale of the Study	3
1.4 Research Objectives	3
1.4.1 Main Objective	3
1.4.2 Specific Objectives.....	3
1.5 Research Questions	4
1.6 Significance of the Study	4
1.7 Delineation of the Study.....	4
CHAPTER TWO.....	6
LITERATURE REVIEW.....	6
2.1 Introduction	6
2.2 History of Meteorological Data Collection in Tanzania	6
2.3 Meteorological Stations in Tanzania.....	6

2.4	The Impact of Information and Communication Technologies in Recording Meteorological Data.....	8
2.5	Wireless Transmission Technologies in Remote Sensing.....	9
2.5.1	ZigBee	10
2.5.2	Global System for Mobile Communication.....	10
2.5.3	General Packet Radio Services.....	11
2.5.4	Low Power Wide Area Network	11
2.6	Other Related Works	20
	CHAPTER THREE.....	22
	MATERIALS AND METHODS.....	22
3.1	Introduction	22
3.2	Research Design.....	22
3.3	The study Area	23
3.4	Sample Size and Sampling Technique	24
3.5	Data Collection Methods.....	24
3.5.1	Questionnaires	24
3.5.2	Guided Interview	24
3.5.3	Observation.....	24
3.6	Data Analysis Method	25
3.7	Designing of the Integrated Sensor Network for Agro-Meteorological Data Collection ..	25
3.7.1	Requirements Analysis.....	25
3.7.2	Functional Requirements	26
3.7.3	Non-Functional Requirements.....	26
3.8	System Development Approach.....	27
3.9	System Implementation	28
3.9.1	Meteorological Stations.....	28
3.9.2	Transmission Network.....	31
3.9.3	LoRaWAN Gateway.....	32

3.9.4	Web Application Development	35
3.10	System Testing and Validation.....	36
3.11	Assumptions and Dependencies	36
CHAPTER FOUR		37
RESULTS AND DISCUSSION		37
4.1	Results	37
4.1.1	Findings from the Meteorological Station.....	37
4.1.2	System Modelling.....	41
4.1.3	System Development.....	42
4.1.4	System Testing and Validation.....	54
4.2	Discussion	61
4.2.1	What are the system requirements for developing an integrated sensor network for agro-meteorological data collection?.....	61
4.2.2	How will the proposed system be developed to meet end-users expectations?	61
CHAPTER FIVE.....		63
CONCLUSION AND RECOMMENDATIONS.....		63
5.1	Conclusion.....	63
5.2	Recommendations	64
REFERENCES.....		65
APPENDICES.....		71
RESEARCH OUTPUTS		78

LIST OF TABLES

Table 1:	Meteorological stations in Tanzania.....	7
Table 2:	LoRa physical layer settings and their effect on communication performance	18
Table 3:	Overview and comparison of LPWAN technologies.....	19
Table 4:	Demographic information of consumers.....	38
Table 5:	Stations establishment and ownership.....	38
Table 6:	Meteorological station units testing results	55
Table 7:	The communication range testing between the LoRa gateway and meteorological stations (Nodes) in urban areas	56
Table 8:	The communication range testing between the LoRa gateway and meteorological stations (Nodes) in suburban areas.....	57
Table 9:	Long range communication testing between the LoRaWAN gateway and the meteorological stations (nodes).....	59
Table 10:	User authentication testing	60
Table 11:	User management unit test	60
Table 12:	Meteorological stations unit test.....	60
Table 13:	Meteorological data visualization unit test.....	61

LIST OF FIGURES

Figure 1:	TMA Synoptic meteorological stations by 2015 Machapisho Mamlaka ya Hali ya Hewa Tanzania (URT, 2015).....	7
Figure 2:	The estimated number of Internet users by 2020 (TCRA, 2021)	9
Figure 3:	SigFox communication stack	12
Figure 4:	Protocol stack for NB-IoT (Sinha <i>et al.</i> , 2017).....	14
Figure 5:	LoRaWAN communication stack (Park <i>et al.</i> , 2017).....	15
Figure 6:	ADR mechanism algorithm implemented in the end device (Haxhibeqiri, 2018) ..	17
Figure 7:	Processes in the Design Science Research (Ojeniyi <i>et al.</i> , 2019).....	22
Figure 8:	The study area map	23
Figure 9:	Rapid Application Development (RAD) lifecycle (Shyles, 2019)	28
Figure 10:	DHT 11, temperature and humidity sensor.....	29
Figure 11:	The rain gauge tipping bucket.....	29
Figure 12:	GPS module	30
Figure 13:	The Arduino MKR1300 LoRa module.....	30
Figure 14:	BotRF terrain simulation.....	32
Figure 15:	LoRaWAN gateway connected with raspberry pi 3	33
Figure 16:	LoRa Gateway Operating System application server interface	35
Figure 17:	Vandalized rain-gauge which was used in the automatic meteorological station	40
Figure 18:	Conceptual framework of the proposed system.....	42
Figure 19:	Developed meteorological station.....	43
Figure 20:	LoRaWAN gateway configuration	44
Figure 21:	The developed system database schema	45
Figure 22:	User log in page	46
Figure 23:	User password recovery page	46
Figure 24:	System administrator dashboard	47
Figure 25:	System administrator settings	49

Figure 26: System User account settings..... 50

Figure 27: System notification settings dashboard..... 50

Figure 28: Graphical visualization of humidity data 51

Figure 29: Graphical visualization of temperature data 51

Figure 30: Graphical visualization of rainfall data..... 52

Figure 31: Graphical visualization of weather parameters in graphical form 52

Figure 32: Tabular visualization of the recorded meteorological data..... 53

Figure 33: Meteorological data settings dashboard..... 54

Figure 34: Urban area communication range testing 56

Figure 35: LoRaWAN communication range in sub-urban area..... 57

Figure 36: BotRf simulation of a line of sight results between the node and the gateway 58

Figure 37: BotRf simulation of a line of sight results between the node and the gateway 59

LIST OF APPENDICES

Appendix 1:	Questionnaire for Data Collection.....	71
Appendix 2:	Sample Arduino Codes for Meteorological station	73
Appendix 3:	Sample PHP Codes for User Login in Web Application.....	77

LIST OF ABBREVIATIONS AND SYMBOLS

2G	Second Generation Cellular Network
3G	Third Generation Cellular Network
4G	Fourth Generation Cellular Network
ABP	activated by personalization
ADR	The Adaptive Data Rate mechanism
API	Application Programming Interface
API	Application Programming Interface
AppEUI	Application Identifier
AppKey	Application Key
AUC	Authentication Centre
BSC	Base Switching Center
BTS	Base Transceiver Station
BW	bandwidth
CSS	Cascading Style Sheet
D-BPSK	Differential Binary Phase Shift Key
DoM	Directorate of Meteorology
DSR	Design Science Research
EAMD	East African Meteorological Department
EIR	Equipment Identity Register
EIRP	Equivalent Isotropic Radiated Power
ERD	Entity Relationship Diagram
ETSI	European Telecommunications Standards Institute
FEC	Forward Error Correction
GFSK	Gaussian frequency shift keying
GMSC	Gateway Mobile Switching Center
GPRS	General Packet Radio Service
GPS	Global Positioning System
GSM	Global System for Mobile Communication
HLR	Home Location Register
HTML	Hypertext Mark-up Language
HTTP	Hyper-Text Transfer Protocol
ICT	Information and Communication Technologies
ID	Identification Number

IoT	Internet of Things
JSON	JavaScript Object Notation
LoRa	Long Range
LoRaWAN	Long Range Wide Area Network
LORIENT	Long-Range IoT
LPWAN	Low Power Wide Area Network
LSIs	Large Scale Integrated circuits
LTE	Long Term Evolution
MAC	Media Access Control
MIC	Message Integrity Check
MOA	Ministry of Agriculture, Livestock and Fisheries
MQTT	Message Queuing Telemetry Transport
MSC	Mobile Switching Center
NB-IoT	NarrowBand-Internet of Things
OMC	Operation Maintenance Center
OS	operating system
OTAA	over the air
QPSK	Quadrature Phase Shift Key
RAD	Application Development
SDLC	Software Development Life Cycle model
SF	spreading factor
SIM	Subscriber Identity Module
TCRA	Tanzania Communications Regulatory Authority
TMA	Tanzania Meteorological Agency
TTN	The Things Network
VLR	Visitor Location Register
WPAN	Wireless Personal Area Networks
WSNs	Wireless Sensor Networks

CHAPTER ONE

INTRODUCTION

1.1 Background of the Problem

Access to reliable meteorological data is very crucial in the agriculture sector since it provides vital inputs in crop growth. Therefore, the availability of meteorological data measured in near-real-time such as rainfall, relative humidity, wind and solar radiation can be used in crop monitoring and forecasting systems (Toreti *et al.*, 2019), and providing early warning to both farmers and the government.

Tanzania Meteorological Agency (TMA) and the Ministry of Agriculture, Livestock and Fisheries (MOA) have installed several manual and automatic meteorological stations across the country. Even though the existing meteorological stations face some challenges, they provide crucial input to the agriculture sector. The manual meteorological stations are not only facing the problem of delaying meteorological data to reach the respective organs but also digitalizing all the collected meteorological data is a challenge. The survey done in nine manual meteorological stations owned by the Ministry of Agriculture, Livestock and Fisheries around the Arumeru district in the Arusha region found that weather data is recorded in cards daily; however, cards are sent in a month to month interim to the respective organs this delay make crop growth monitoring difficult. The study by Kondela *et al.* (2015) found most of automatic meteorological stations are not functioning due to several reasons, including poor communication systems. The push to densification and replacing non-working automated meteorological stations is hindered by significant expenses in maintaining and purchasing the new ones. Hence having local owned automated meteorological stations won't just diminish the purchasing and maintenance expenses yet, also, will provide full access and control on collected meteorological data.

The ongoing progression of the Wireless Sensor Networks (WSNs) and Internet of Things (IoT) provides the possibility of developing an integrated sensor network for agro-meteorological data collection by deploying Low Power Wide Area Network (LPWAN). With the ability to deploy a private network and adaptive data rate makes LoRa technology preferable compared to NB-IoT and SigFox technologies. Furthermore, LoRa has an unlimited maximum number of messages per day and higher data rate, which makes it better than SigFox which has only 140 uplink and 4 downlink messages per day. Again LoRa has higher noise immunity and coverage distance compared to NB-IoT (Mekki *et al.*, 2019), and in addition to that, LoRa can send recorded meteorological from rural areas where there is limited network infrastructure (Byanyuma *et al.*, 2013). For the reasons

mentioned above, this study aimed to use the LoRaWAN network to develop a wireless sensor network for agro-meteorological data collection in Tanzania.

1.2 Statement of the Problem

In Tanzania, several efforts have been made to install the local owned automatic meteorological station, such as the SAWS project in 2003, and the CASELLA project in 2004 (Kondel *et al.*, 2015). The SAWS project was deployed by the team from South Africa collaborating with TMA, and they installed six automatic meteorological stations in the regions of Arusha, Tanga, Singida, Mwanza, Dodoma and Zanzibar. Initially, the project was successful, and the meteorological stations were using GSM technology to transmit the recorded meteorological data, but it later failed due to high communication service charges resulting from firmware failure in the GSM circuit as it was unable to terminate calls. The CASELLA project installed 11 meteorological stations in the regions of Morogoro, Manyara, Iringa, Njombe, Kagera, Mbeya, Mtwara, Kigoma, Pwani and Tabora. The designed meteorological stations used the GSM/GPRS for data transmission, but it didn't work.

Despite efforts of deploying automatic meteorological stations in Tanzania, most of them are not working (Kondela *et al.*, 2015) due to several reasons including poor data management, poor communication system, and vandalism. The commercially available automatic weather stations such as Vaisala, Tahmo and Devis are not only expensive cost above \$2000 per complete station something which hinders replacement of non-functioning stations and instalment of the new stations, but also they don't provide full control of the recorded data.

The survey done in nine manual meteorological stations owned by MOA, TMA and Pangani basin around the Arumeru district in the Arusha region reveals that there is a delay of the recorded data to reach the respective organs that is TMA, MOA and Pangani basin since the meteorological data are recorded in cards daily, but they are sent via post office at a month time interval and make it hard to be used in early warning systems. Delaying of the recorded meteorological data is not the only challenge in manual meteorological stations, but also the process of digitalising the recorded data is also a challenge.

Along these lines, this study intends to develop an integrated sensor network for agro-meteorological data collection in Tanzania, which will be less expensive, locally owned, and record near real-time meteorological data with and interval of a second.

1.3 Rationale of the Study

Access to reliable meteorological data is very crucial in the agriculture sector since it provides vital inputs in crop growth. Tanzania Meteorological Agency (TMA) and the Ministry of Agriculture, Livestock and Fisheries (MOA) have installed several manual and automatic meteorological stations across the country. Even though the existing meteorological stations face some challenges, they provide crucial input to the agriculture sector. The manual meteorological stations are not only facing the problem of delaying meteorological data to reach the respective organs but also digitalizing all the collected meteorological data is a challenge. The survey done in nine manual meteorological stations owned by the Ministry of Agriculture, Livestock and Fisheries around the Arumeru district in the Arusha region found that weather data is recorded in cards daily; however, cards are sent in a month to month interim to the respective organs this delay make crop growth monitoring difficult. The ongoing progression of the Wireless Sensor Networks (WSNs) and Internet of Things (IoT) provides the possibility of developing an integrated sensor network for agro-meteorological data collection by deploying Low Power Wide Area Network (LPWAN). With the ability to deploy a private network and adaptive data rate makes LoRa technology preferable compared to NB-IoT and SigFox technologies. Furthermore, LoRa has an unlimited maximum number of messages per day and higher data rate, which makes it better than SigFox which has only 140 uplink and 4 downlink messages per day. For the reasons mentioned above, this study aimed to use the LoRaWAN network to develop a wireless sensor network for agro-meteorological data collection in Tanzania.

1.4 Research Objectives

1.4.1 Main Objective

To develop an integrated sensor network for agro-meteorological data collection in Tanzania.

1.4.2 Specific Objectives

The specific objectives of this study were:

- (i) To analyse the challenges facing the existing agro-meteorological weather stations.
- (ii) To develop the integrated sensor network for agro-meteorological data collection.
- (iii) To validate the developed integrated sensor network.

1.5 Research Questions

The research questions of this study were:

- (i) What are the challenges facing the existing meteorological stations, and what are the requirements for the developed system?
- (ii) How does an integrated sensor network for agrometeorological data collection be developed and enhance near-real-time monitoring?
- (iii) How effective and efficient is the developed integrated sensor network for agrometeorological data collection in Tanzania when tested in the real environment?

1.6 Significance of the Study

Knowing how important is the near-real-time meteorological data in the agriculture sector, this is expected to have the following impacts:

- (i) Enabling near-real-time meteorological data visualisation; these can be used in monitoring the crop growth and in the early warning systems.
- (ii) The locally owned developed system will make maintenance easy, and at a reduced cost. Moreover, the developed system provides a full control of the recorded data servers, and therefore use the data for a different purpose, including research.
- (iii) The developed system uses the LoRaWAN network in transmission of the recorded data from the node (meteorological station) to the gateway. This will offer an advantage compared to systems that use only the GSM/GPRS technologies in areas with the limited network coverage.

1.7 Delineation of the Study

The present study aimed at developing an integrated sensor network for agro-meteorological data collection in Tanzania by deploying Low Power Wide Area Network (LPWAN). With the ability to deploy a private network and adaptive data rate makes LoRa technology preferable compared to NB-IoT and SigFox technologies. This study intends to crack down on the problems encountered by the existing meteorological stations by providing access to reliable and real-time meteorological data. Therefore the intended stakeholders are the MOA, who need the meteorological data to monitor the crop growth, the TMA which is the main organ responsible for collecting

meteorological data in Tanzania, researchers who need meteorological data for scientific researches, the government which need the data to be used in early warning system and farmers who need meteorological data to make the right choice of the crop to cultivate and when to cultivate.

CHAPTER TWO

LITERATURE REVIEW

2.1 Introduction

This Chapter presents an overview of the main concepts used to develop an integrated sensor network for agro-meteorological data collection in Tanzania. It begins with a brief history of meteorological data collection in Tanzania, then it covers the current situation of the existing meteorological stations in Tanzania. It also describes the impact of ICT in collecting meteorological data, and the wireless transmission technologies in remote sensing. Finally, it covers the related studies from other researchers on the development of integrated sensor networks for agro-meteorological data collection, by highlighting their strengths and weakness.

2.2 History of Meteorological Data Collection in Tanzania

The history of meteorological data collection in Tanzania began in 1886 along the coast, where the first meteorological observations were made in Stone Town, Zanzibar. Later the service was extended to Tanzania mainland with rainfall observing stations being installed in the towns of Tanga, Bagamoyo and Bukoba. It was in the year 1929 when British meteorological services fully operated meteorological stations in Tanzania mainland. The East African Meteorological Department (EAMD) took over after the British meteorological services departure, and it was responsible for meteorological data collection in all the countries under the former East Africa Community. The parliamentary Act No. 6 of 1978, established the Directorate of Meteorology (DoM) which was a specialized department to deal with meteorological services in Tanzania. In 1997 Tanzania Meteorological Agency (TMA) was established, this is the successor of DoM and it is still in operation (The United Republic of Tanzania; Tanzania Meteorological Agency, 2020).

2.3 Meteorological Stations in Tanzania

In Tanzania, the TMA has been mandated as the National Meteorological Authority and entrusted with the task to provide weather and climate information, and regulation of meteorological services. Since the establishment of TMA in 1997, it has achieved to install several meteorological stations across the country. For instance, by the year 2015 TMA had 500 manual rainfall stations whereby all of them were in operation. The synoptic manual stations were 28 and all of them were in operation, and agro-meteorological manual stations were 15 and also all of them were in operation. The TMA also established the automatic meteorological stations whereby 14 out of 23 synoptic

meteorological stations were operated, 14 out of 23 rainfall stations were operated, one weather radar, and one weather satellite (Kondela *et al.*, 2015). Table 1 summarizes the existing meteorological stations operated by TMA by the year 2015.

Table 1: Meteorological stations in Tanzania

Meteorological stations	The total number	Synoptic stations	Rainfall stations	Agro-met stations	Upper-Air	Satellite	Weather radar
Manual stations	Established	28	500	15	0	0	0
	Operated	28	500	15	0	0	0
Automatic stations	Established	23	23	0	1	1	1
	Operated	14	14	0	0	1	1

Kondela *et al.* (2015)

The parameters measured in synoptic stations are; wind speed, wind direction, rainfall, relative humidity, atmospheric pressure, mean sea level visibility, cloudy cover, thunder, and evaporation.

Figure 1 shows a Tanzania map with established synoptic meteorological stations.

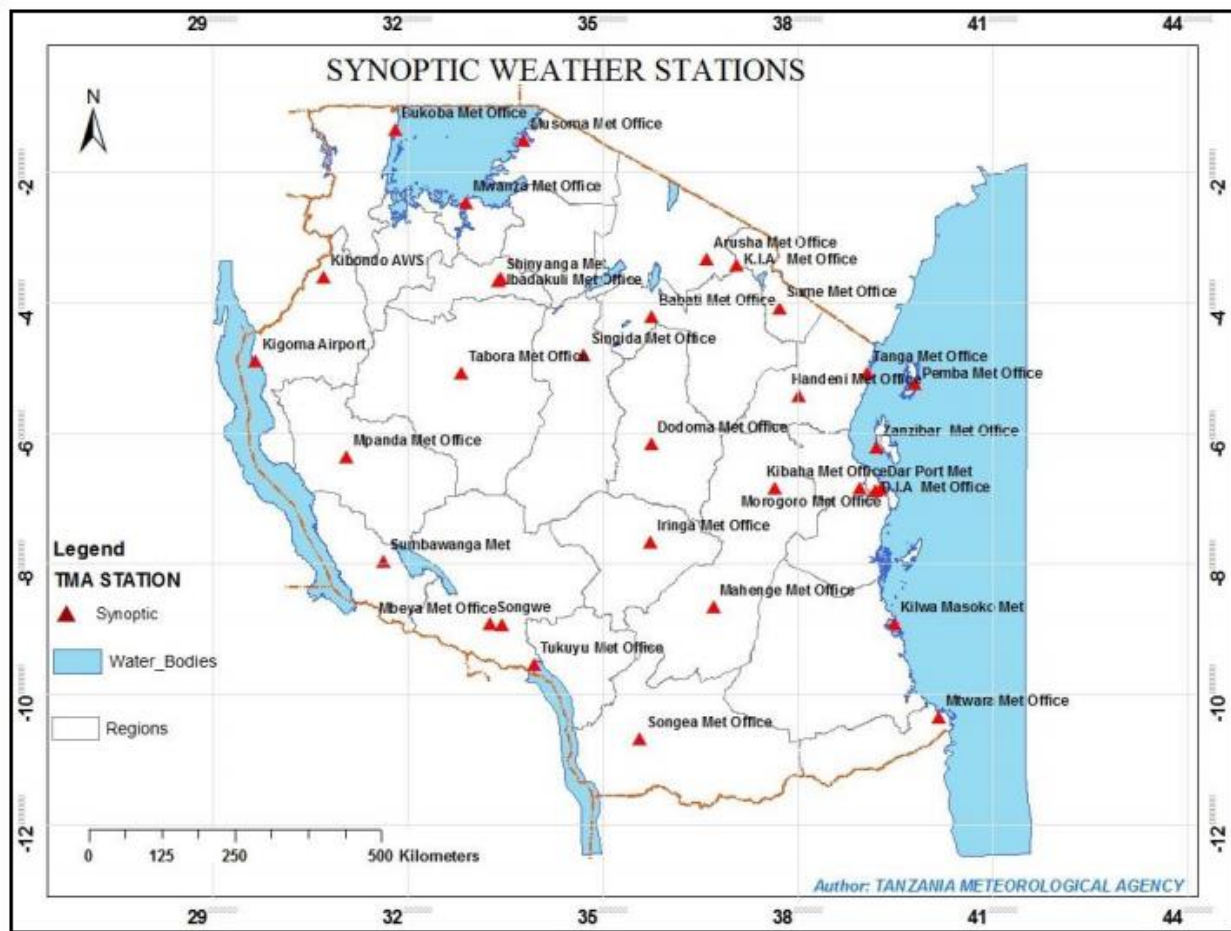

Figure 1: TMA Synoptic meteorological stations by 2015 Machapisho Mamlaka ya Hali ya Hewa Tanzania (URT, 2015)

The manual meteorological stations consist of equipment that reads meteorological data, but unlike automatic meteorological stations, the manual meteorological stations require manpower to record the readings and store them. Most of the manual meteorological station readings are done once a day, but with automatic meteorological stations, meteorological readings can be done several times a day.

Even though manual meteorological stations pioneered the science of recording ground meteorological data, but due to the advancement of science and technology automatic meteorological stations are preferable. The automatic meteorological stations have several strengths over the manual ones, such as providing the possibility of continuous recording of meteorological data many times a day and hence providing more meteorological information, automatic recording of meteorological data reduces the needed manpower, elimination of observer error readings since sensor readings are taken as electrical signals and there is no human intervention, and lastly it makes the digitalization of meteorological data readings easy.

2.4 The Impact of Information and Communication Technologies in Recording Meteorological Data

From the late 1950s to the 1970s the world witnessed the digital revolution, whereby digital electronics started replacing mechanical and analogue electronic technology (Duque *et al.*, 2006). The digital technology revolution have a great impact on the telecommunication and information and communication technology industries (Küng *et al.*, 2016). The advancement of ICT played a great role in the improvement of meteorological science, as the first automatic meteorological station was developed by the Bureau of Aeronautics in northern America and it was set to full operational by the year 1941 (Wood, 1946). This station transmitted meteorological data using the radio frequency. The gasoline-electric plant was used to power the station and the whole station weighed one ton. The station measured temperature, pressure, wind speed, relative humidity and rainfall. Eight observations were made every 24 hours and the fuel consumption was 80 gallons of gasoline per four months in hot weather, and the same amount of fuel was used in two months during the cold weather as the considerable heating was required. With the discovery of semiconductors (Iwai & Ohmi, 2002), particularly, Large Scale Integrated circuits (LSIs), has boosted various sectors including the meteorological science. With the LSIs, scientists have been able to come up with small size, low cost, low weight, low power consumption, and reliable automatic meteorological stations.

Over the past two decades, sub-Saharan Africa experienced a rapid expansion of cellular communication networks than any other continent worldwide (Dipolelo, 2016). This transform the

way people get, use and share their information in the daily activities (Taghandiki *et al.*, 2016). In Tanzania, the usage of ICT has increased rapidly in recent years, whereas the number of Internet users has increased by 81.6% from the year 2014 to the year 2019, this is according to Tanzania Communication Regulatory Authority (TCRA) every quarter statics report published in March 2021.

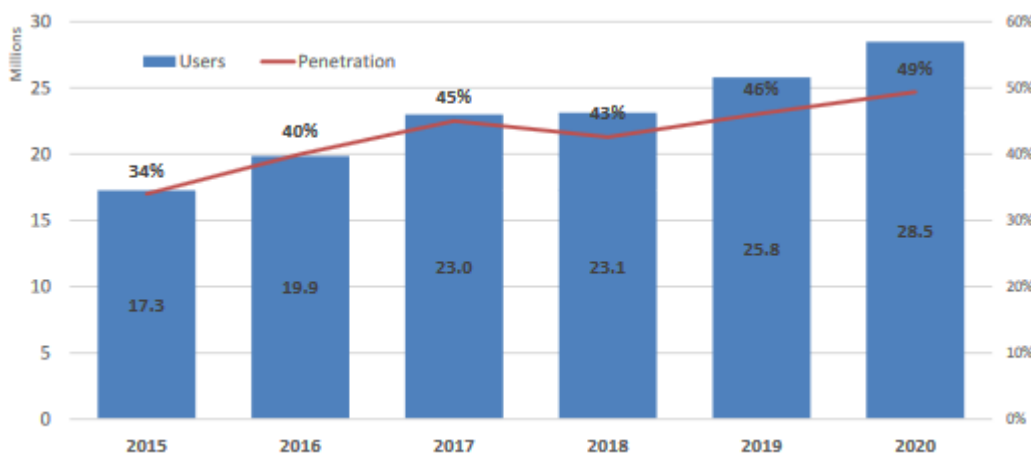

Figure 2: The estimated number of Internet users by 2020 (TCRA , 2021)

From Fig. 2, it is vivid that the Internet penetration rate over the past five years has also increased from 29% in 2014 to 46% in 2019. This makes the application of IoT in Tanzania possible, in different fields, including in meteorological science.

The existing automatic meteorological stations are categorized into two. The first category is the automatic meteorological stations without a transmission system, in this category the meteorological station contains meteorological sensors, which record meteorological parameters without any human intervention, and the readings are stored in a data logger (Weerasinghe *et al.*, 2011). The meteorological readings cannot be accessed remotely, hence it requires manpower to retrieve the readings from the data logger. The second category is the automatic meteorological stations with the transmission system. These are more preferable since users can access meteorological readings from remote areas without any human intervention hence reducing human power.

2.5 Wireless Transmission Technologies in Remote Sensing

Data transmission can be done by either wired or wireless connection. The wired transmission requires a physical cable connection between devices. The most used cables in wired transmission are copper cables, twisted pair cables, coaxial cables and fibre optics. The data signal is transmitted in form of electricity in most of the cables, with exception of fibre optics cables which transmit signal in form of light (Alam & Tariq, 2019). Even though the wired transmission has advantages

over wireless transmission in reliability, security, and data rate, but wireless transmission is more preferable for IoT applications (Alam & Tariq, 2019). Among the reasons which make wireless transmission more preferable in IoT applications is the availability of flexibility where devices can communicate from different locations. In addition to that, the wireless transmission has low installation costs, as it doesn't require the installation of connecting cables. Last but not least, the network maintenance is easier in wireless transmission compared to wired transmission. The most used wireless technologies for IoT applications including weather monitoring systems are ZigBee, GSM, GPRS and LPWAN (Mengdi & Mengdi, 2016).

2.5.1 ZigBee

The ZigBee technology is a Wireless Personal Area Networks (WPAN) and it was developed by ZigBee alliance. The name ZigBee originated from the honey bees zigzagging patterns, between flowers, representing mesh network topology between the nodes (Home - Zigbee Alliance, 2020). The ZigBee standard is supported by the ZigBee alliance and it uses IEEE802.15.4.network transport services (Dhillon & Sadawarti, 2014). The ZigBee node consumes very low power (1mV or less) and can cover a distance range of up to 150 meters outdoor. This technology operates in unlicensed ISM frequency bands of 915 MHz (North America and Australia), 868 MHz (Europe) and 2.4GHz (worldwide) (Dhillon & Sadawarti, 2014). This technology is more suitable in areas with limited power supply, and applications with low range coverage (Chaudhary *et al.*, 2011).

2.5.2 Global System for Mobile Communication

The European Telecommunications Standards Institute (ETSI) developed the GSM technology as the standard [3GPP 1998]. The GSM is the Second Generation (2G) of digital cellular networks used by mobile phones (Cattaneo *et al.*, 2013). The 2G was developed to replace the First Generation (1G) of digital cellular networks by adding some enhanced features. The main difference between the two technologies is the introduction of digital radio signals in 2G, while the 1G used the analogue signal. The main motive of this technology is to provide secured and reliable communication (Rahnema, 1993). With the digital communication network, the multiplexing technique was introduced, where multiple network users share the same communication channel. The GSM architecture comprises components such as; the User Equipment (UE) this is an end device or node, Gateway Mobile Switching Centre (GMSC), Operation Maintenance Centre (OMC), Base Switching Centre (BSC), Base Transceiver Station (BTS), and the Mobile Switching Centre (MSC) consists of databases such as the Equipment Identity Register (EIR), Home Location Register (HLR), Visitor Location Register (VLR), and Authentication Centre (AUC) (Rahnema, 1993).

The GSM module transmits the measured sensor values from sensor nodes to the server, using GSM technology. The GSM module is inserted with Subscriber Identity Module (SIM) card to enable it to send recorded sensors data and the IP Address via a Short Message Service (SMS). The receiver side contains Application Programming Interface (API), which decodes the received message and store a measured value (Vasavi *et al.*, 2017). The ability of the GSM module to send the received sensors data to the server makes it suitable for IoT applications including the automatic meteorological system (Alam, 2019).

2.5.3 General Packet Radio Services

The GPRS provides a means for mobile equipment to access the Internet (Hoff *et al.*, 2015) and it was designed for a packet switched data transmission. This technology uses the same network infrastructure and the GSM technology, to provide end to end packet-switched data services (Lin & Chlamtac, 2001). The GPRS technology is suitable for IoT applications as the end devices use packet switched data (Internet) to send the recorded sensors values from the sensors nodes to the gateway or server. Just like in GSM technology, the server-side contains the API which decodes and store the sensor data to the server. The GPRS is more preferable in the IoT applications than the GSM as it allows to send longer messages for the cheaper communication rates.

2.5.4 Low Power Wide Area Network

In recent years LPWAN has become popular among scientists and researchers around the globe, as it offers low cost, low power consumption, and a long-range communication. The LPWAN technologies have a communication distance of 10 to 40 km in sub-urban area and up to 5 km in urban area (Mekki *et al.*, 2019). The message transmitted in LPWAN must be small and simple, this will enable long-range communication between devices.

There are several wireless technologies using LPWAN, such as Low Range (LoRa), Narrowband Internet of Things (NB-IoT), Dash7, GreenOFDM, Symphony, WAVIoT and SigFox. All these technologies have low consuming power, and long communication range devices, although they differ in some characteristic features such as the data rate, coverage distance and the operating frequencies, where some of them use unlicensed frequency bands while other use licensed bands. Even though LPWAN has many technologies but the leading technologies for IoT large scale deployment are the NB-IoT, SigFox and LoRa (Mekki *et al.*, 2018), as they are very suitable for IoT applications including meteorological data collection. This section will provide an overview of LoRa, SigFox and NB-IoT, by comparing their characteristic features and highlighting the most suitable technology for meteorological data collection.

(i) **SigFox Technology**

The SigFox technology is a part of LPWAN and was it was deployed in the year 2010 and founded by Ludovic Le Moan and Christophe Fourtet (SigFox, 2020), with the motive of connecting every physical object to a digital world. This technology utilizes unlicensed industrial, scientific, and medical (ISM) frequency bands, that 433 MHz in Asia, 915 MHz in North America, and 868 MHz in Europe. The SigFox technology uses Gaussian frequency-shift keying (GFSK), and Differential Binary Phase Shift Key (D-BPSK) modulation techniques for which each message sent has a speed of 600bps (for the U.S. standard) or 100 bps (for the European standard). These modulation techniques are part of ultra-narrow band modulation that consumes low power on the communication devices. Other advantages obtained from the use of ultra-narrow band modulation are the very high noise immunity, low cost in antenna designing and high receiver sensitivity. SigFox technology operates in a star topology, and has a duty cycle from 0.1% to 10%, depending on the frequency of operation and the region's communication restrictions.

The SigFox technology covers the communication range of tens of kilometres and has a data rate of up to 100 bps. The SigFox communication stack as shown in the Fig. 3.

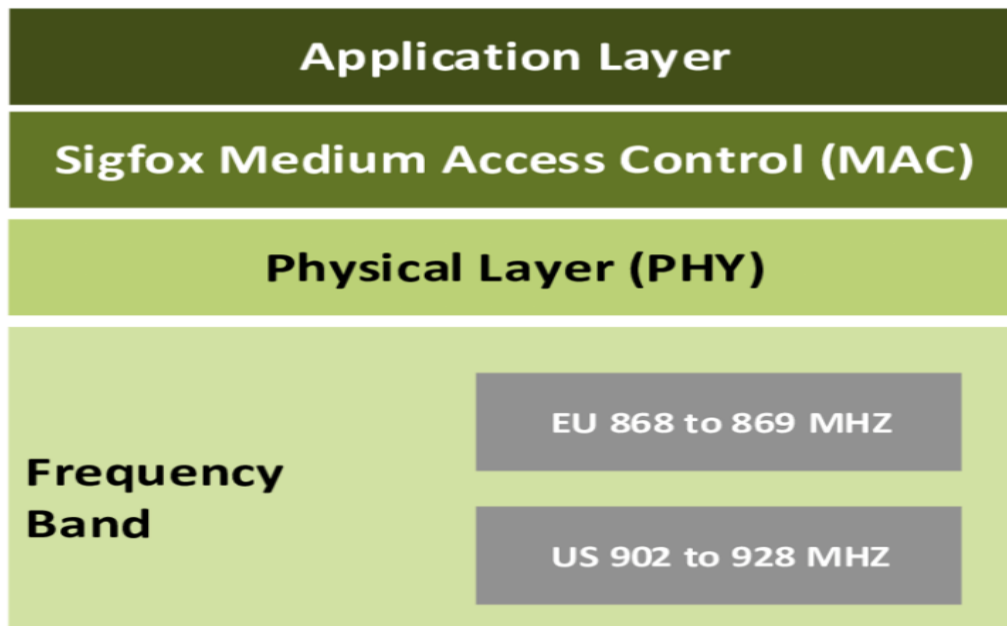

Figure 3: SigFox communication stack

Has the lowest layer which contains the radio frequency layer which includes all the modulation frequencies, depending on the region of operation. The Physical layer has the modulation schemes, and the Media Access Control (MAC) layer has the error detection and control mechanisms, and the channel access. The Application layer is the highest in the communication stack and it defines the user requirements and specifications (Sethi & Sarangi, 2017).

To ensure communication reliability, SigFox transmits data redundantly in three separate channels to ensure frequency diversity, and also at three different time intervals to ensure time diversity. The redundancy technique makes SigFox robust to noise and interference and hence more reliable communication. The SigFox technology uses a bi-directional communication scheme, where end devices can communicate to the gateway (uplink communication), and the gateway can communicate to the end devices (downlink communication). In uplink communication and the end device, is allowed to send only 140 messages per day with of 12 bytes maximum payload, and in downlink communication, the gateway is allowed to send only four messages per day with the 8 bytes maximum payload. These restrictions are set to ensure power efficiency and adhere to “gentleman’s agreement” as stated on SigFox official website (Sigfox the Internet of Things [IoT], 2020). The SigFox end devices have very low power consumption which allows them to transmit data for decades without changing the batteries (Gomez *et al.*, 2019). For example, the AX-SIGFOX ON Semiconductor module consumes an electric current of 19 mA when the out power is 0 dBm, and 49 mA with the output power of 14 dBm (Lavric *et al.*, 2019). All mentioned features and advantages make SigFox one of the LPWAN suitable for IoT applications including meteorological data collection.

(ii) NarrowBand Internet of Things

The NarrowBand Internet of Things (NB-IoT) technology is the part of LPWAN family, and it is built on the functionalities of the existing Long Term Evolution (LTE). This technology can operate in three different modes which are; the in-band mode, standalone mode, and within a guard band of the existing LTE technology (Ratasuk *et al.*, 2016). These operation modes intend to offer flexibility depending on available spectrum, and use cases. Unlike SigFox technology, the NB-IoT uses Quadrature Phase Shift Key (QPSK) modulation technique (Mangalvedhe *et al.*, 2016) and it operates in licensed frequency bands used by LTE technology. The NB-IoT has a peak data rate of 234.7 kbps for DL and 204.8 kbps for UL communication. The communication protocol stack for NB-IoT both for the control plane and user plane shown in Fig. 4, is generally the fundamental protocol stack used by LTE technology.

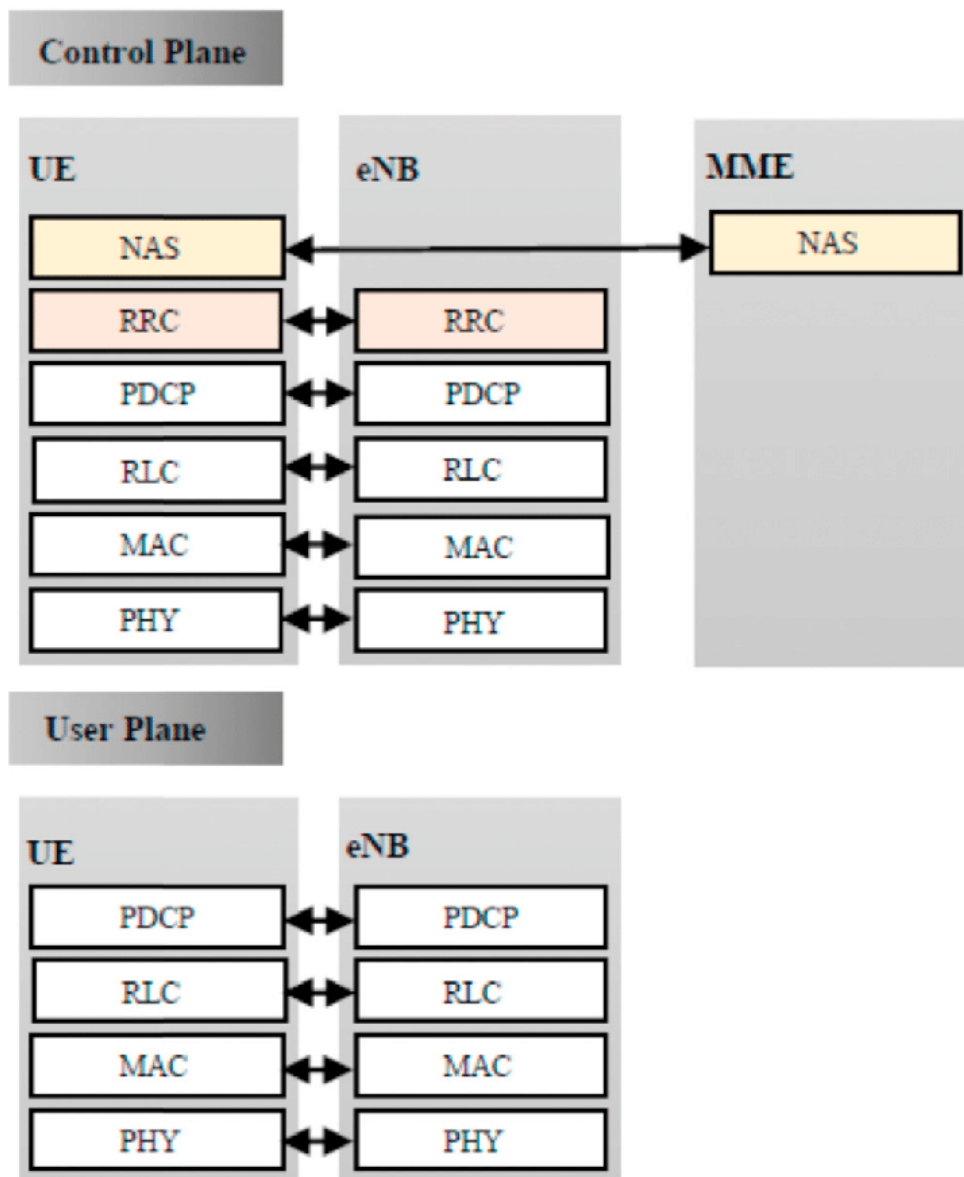

Figure 4: Protocol stack for NB-IoT (Sinha *et al.*, 2017)

The NB-IoT, like other LPWAN technologies, consume a small amount of power, whereby the end devices consume 5 μ A in sleeping mode, and 120/130 mA as the peak current (Sinha *et al.*, 2017a), and hence make the end devices operate for years without changing the batteries.

(iii) Long Range (LoRa) Technology

Cycleo developed LoRa radio modulation technology and it was later acquired and patented by Semtech in 2014 (Sornin *et al.*, 2016). Unlike NB-IoT technology, which operates in licensed LTE frequency band, the LoRa physical layer operates in the ISM radio bands that is 868 MHz and 433 MHz in Europe and 915 MHz in North America. The ability to spread the signal over wide frequency bands makes LoRa stronger against interference and jamming. The LoRa uses the Chirp Spread Spectrum (CSS) modulation technique, whereby the signal consists of chirps signals, whose frequency decreases and increases with time (Cattani *et al.*, 2017). The LoRa technology has two

different types of chirps that is the base chirp and modulated chirp. The base chirp starts with the minimum frequency of:

$$f_{\min} = -\frac{Bw}{2} \tag{1}$$

and the maximum frequency of:

$$f_{\max} = +\frac{Bw}{2} \tag{2}$$

Bw donates signal’s bandwidth, while the modulated chirp is cyclically time shifted base chirp (Haxhibeqiri, 2018).

The LoRa’s chirps facilitate LoRa signal to travel over long range (Haxhibeqiri, 2018) of five kilometres in urban, and more than 10 km in sub-urban areas. The LoRa modulation has a link budget of above 140 dB with the 14 dBm transmission power and the -137 dBm receiver sensitivity, these allow it to cover a long communication range (Lavric, 2019).

Figure 5 presents the LoRaWAN communication stack. The physical layer of LoRaWAN communication uses LoRa modulation (Lavric & Petrariu, 2018), and it enables a long-range communication link. The LoRa Alliance standardized the LoRaWAN MAC layer. The LoRaWAN communication protocol provides solution for IoT applications. The LoRaWAN communication protocols and the network architecture contributes to the end nodes battery capacity, network security, type of services offered by the network, and the quality of service (Workgroup, 2015).

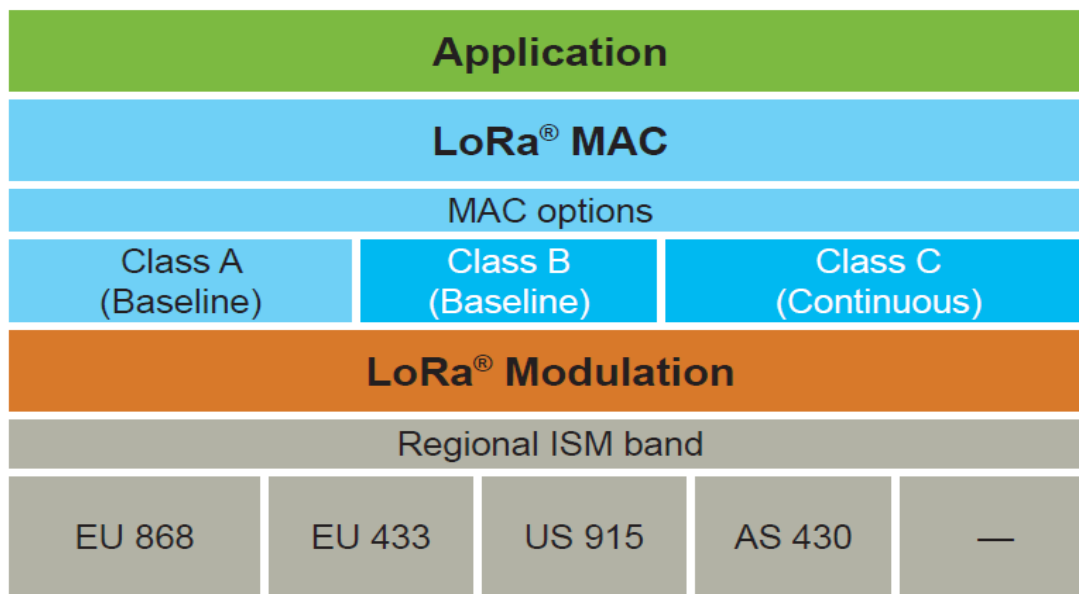

Figure 5: LoRaWAN communication stack (Park et al., 2017)

The LoRaWAN network supports star topology, with the multiple end devices send data to a single LoRaWAN gateway, and a single cloud server and receive data from multiple LoRaWAN gateways. The role of LoRaWAN gateways are to forward data packets from the end devices to the cloud server. The LoRaWAN standard supports three classes of end devices namely A, B, and C depending on the requirement of the IoT application. A Class A device has the basic settings and options that are implemented by every LoRa end device for them to join the LoRaWAN network. This class of devices supports uplink and downlink communication, in which a device's uplink transmission is followed by a short downlink receiving window. When an end device sends an uplink message, it waits for acknowledgements (Fehri *et al.*, 2018), and if no acknowledgement is received, the LoRaWAN uses the backoff algorithm that has been implemented in the LoRaWAN application layer to calculate waiting time before the retransmission of the message (Polonelli *et al.*, 2019). The message retransmission process proceeds until the acknowledgement is received or the maximum number of retransmissions is attained (Fehri *et al.*, 2018). Most of the time, class A devices are in sleeping mode and hence consume the least power. Class B devices consume more power compared to class A devices, and this is because Class B devices open more receiving window for downlink communication. The class B devices resemble class A devices in network joining procedures, and uplink message transmission since they both use ALOHA-like channel access. Class C devices are the most power-consuming devices since they continuously open the downlink receive window except the time for uplink transmission.

The Adaptive Data Rate (ADR) mechanism is implemented on LoRa network to dynamic manage the end devices link parameters, and to increase communication reliability in the network. The ADR mechanism allows the end devices to adapt the transmission rate and the transmission power depending on the changes in the transmission link (Li *et al.*, 2018). When an end device sends a large number of uplink messages back to back without a downlink response from the network server, the end devices assume the network connection loss and resolve the problem by decrease the data rate and increase the transmission power until the connection is regained.

The variation of LoRa physical layer settings include the bandwidth (BW), spreading factor (SF), and coding rate affect LoRa communication performance. The BW is the range of frequencies used to transmit the message, and LoRa technology permits the utilization of scalable BW of 125 Kilohertz, 250 Kilohertz, or 500 Kilohertz (Noreen *et al.*, 2017). With the higher bandwidth, you can achieve more data rate, but as a trade-off for receiver sensitivity and communication coverage distance. Another physical layer setting is SF, where LoRa offers the flexibility of utilizing spreading factors at the range of 6 to 12 (Boano *et al.*, 2017) which results in spreading rate ranging from 2^6 to 2^{12} Chips/symbol. The higher the spreading factor, the higher the signal to noise ratio

and the radio sensitivity, but this results in more power consumption. To increase receiver sensitivity, LoRa uses Forward Error Correction (FEC) technique. This technique controls errors in a communication channel, whereby end devices send redundant bits, which enables the receiver in detecting and correcting errors in a transmitted message. The variable number of redundant bits ranges from 1 to 4, whereby when transmitting with the maximum code rate of 4/8 makes the channel more resilient to interference and reduces the message decoding errors. However, sending more redundant bits increases the size of the packet, and therefore more power will be used during transmission. By considering the mentioned LoRa physical layer settings above, more communication range can be obtained by deploying the narrow bandwidth, high SF and high code rate though it comes at the expense of transmission power.

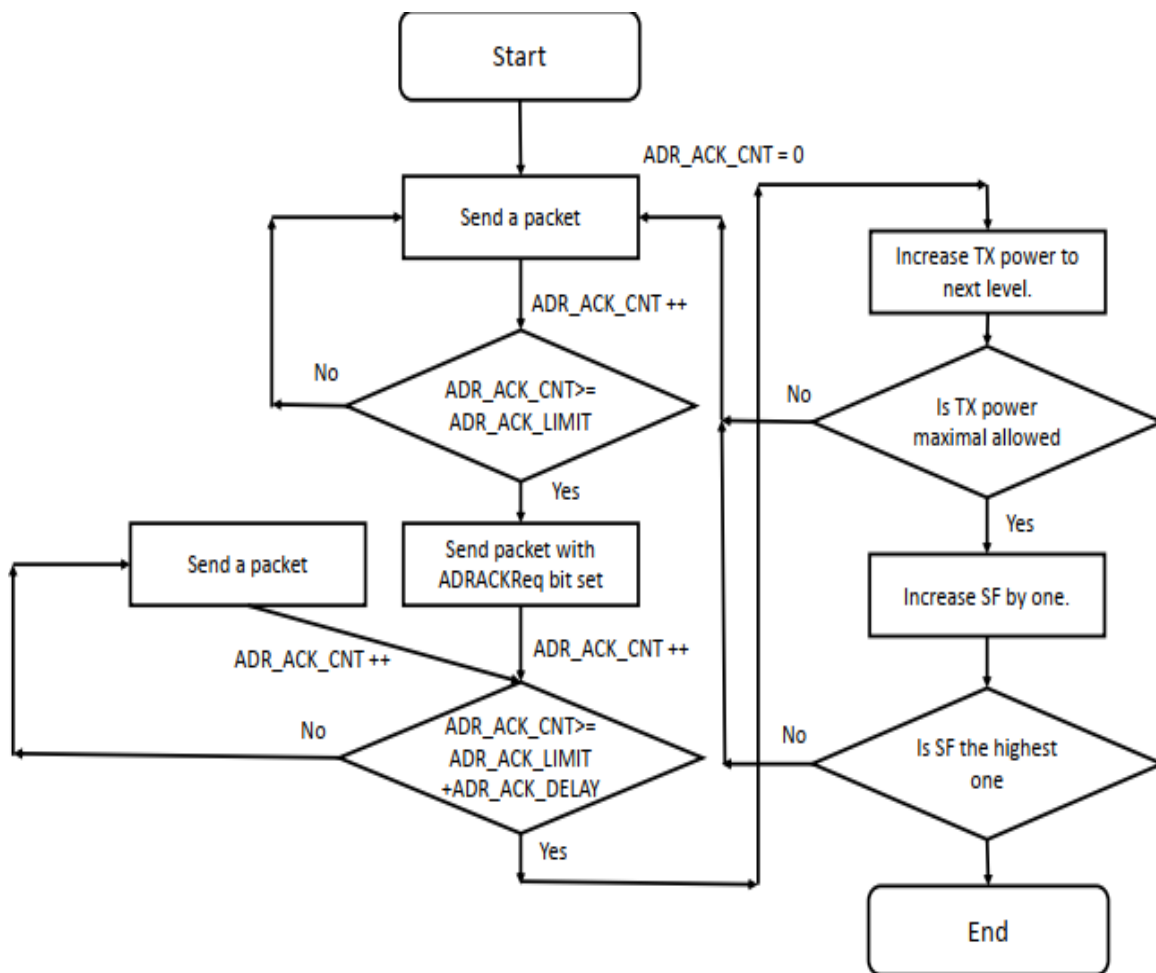

Figure 6: Adaptive Data Rate mechanism algorithm implemented in the end device (Haxhibeqiri, 2018)

Table 2: LoRa physical layer settings and their effect on communication performance

Settings	Values	Impact on communication performance
Bandwidth	125, 250, or 500 kHz.	Transmitting at higher bandwidth will result in shorter transmission time but at the expense of sensitivity and hence, shorter communication coverage range.
Spreading factor	6 to 12	Signal transmission with the spreading factor of 2^{12} Chips/symbol has the highest SNR and hence higher sensitivity and communication distance.
Code Rate	4/5, 4/6, 4/7, and 4/8	Using a maximum code rate of 4/8 increases channel error detection and correction capabilities and hence make the channel more resilience to noise and interference, and therefore more communication coverage range can be achieved.

The LoRaWAN implements security features to ensure only authorized devices can join the network. Messages transmitted on the LoRaWAN network are originally protected against integrity attacks, replay attacks, and they are also encrypted and authenticated. The end devices that join the network need to be activated and personalized. The end devices are either activated by personalization (ABP) or by over the air (OTAA). A number of keys are required for the network joining procedures, as well as in communication. In the OTAA method, the end devices send the join requests to the network. The networks check the Application Key (AppKey) and Application Identifier (AppEUI) provided by the devices if they are valid in the network. If AppEUI and AppKey are valid the joining accept messages are sent back to the devices and the devices join the network. In the ABP activation method, there is no handshake between the end devices and a network, soon after the end devices join the network, they start sending data (Gemalto, 2017). The OTAA is a more secured method as the session key is derived from AppEUI and AppKey on every connection.

The theory suggests LoRa can cover the distance of up to 5 km in urban areas and 15 km in rural areas (Dambal *et al.*, 2018) although the study (Jovalekic *et al.*, 2017) indicates that LoRa can achieve a communication range of up to 316 km. More communication range can be attained by using antennas with high gain in both ends. By considering the Friis Transmission Equation:

$$P_r = \frac{P_t G_r G_t \lambda^2}{(4\pi d)^2} \quad (3)$$

Where P_r is the power received, G_r is the receiving antenna gain, P_t is the transmitted power, G_t is the transmitting antenna gain, d is a distance between the two antennas, and λ donates the signal wavelength. The increase in receiving antenna gain G_r and transmitting antenna gain G_t increases the coverage distance between the two antennas. Although when choosing a transmitting and receiving antennas, it is also important to observe the maximum allowed EIRP (Equivalent Isotropic Radiated Power) in that specific region. Tanzania uses the European standard which allows the maximum transmission EIRP of 16 dBm (Lora Alliance, 2017).

(iv) Comparison of Low Power Wide Area Network Technologies

Considering the three LPWAN technologies, LoRa is more suitable to be used in the development of an integrated sensor network for agro-meteorological data collection in Tanzania. The LoRa has the adaptive data rate, and ability to build a private network, and hence make it preferable compared to NB-IoT and SigFox technologies. Moreover, LoRa has unlimited number of messages per day, and a network security mechanism that gives it advantages over SigFox technology. Furthermore, LoRa uses an unlicensed frequency band, which makes it cheaper to operate in comparison to NB-IoT technology. Table 3 shows an overview and comparison of LPWAN technologies.

Table 3: Overview and comparison of LPWAN technologies

		SigFox	NB-IoT	LoRa
1.	Ability to build a private network	No	No	Yes
2.	Maximum number of messages per day	140 uplink, 4 downlink	Unlimited messages	Unlimited messages
3.	Frequency of operation	Unlicensed ISM frequency bands	Licensed frequency bands	Unlicensed ISM frequency bands
4.	Operating bandwidth	100 Hz	200 KHz	125 KHz and 250 KHz
5.	Adaptive data rate	No	No	Yes
6.	Maximum payload length	12 bytes uplink, 8 bytes downlink	1600 bytes	243 bytes
7.	Data rate	100 bps	200 kbps	50 kbps
8.	Modulation technique	BPSK	QPSK	CSS
9.	Immunity to interference	high	low	High
10.	Authentication & encryption	No	Yes	Yes
11.	Localization	Yes (RSSI)	No	Yes (TDOA)

2.6 Other Related Works

There are several works done by researchers on the development of sensor networks, to collect meteorological data using different wireless networks technologies. This section covers most related works from different studies.

The study conducted in Malaysia by Rahman *et al.* (2018) focused on the development of a weather monitoring system through field measurement, and it used the LoRaWAN network to transmit data recorded data from the end devices to the gateway. The unavailability of mobile network coverage especially in the eastern part of Malaysia was the main challenge that lead to the deployment of LoRa technology. The LoRa was used to transmit recorded weather data from areas with less mobile network coverage to the gateway placed in an area with good network coverage. The weather data received by the gateway was forwarded to ThingSpeak. This is an online platform, for data visualization and it works with Particle Photon, MATLAB, Arduino, and Electron, ESP8266 Wifi Module, Libelium, Raspberry Pi, Things Network, Senet, LoRaWAN and Beckhoff. Even though ThingSpeak has a lot of features, but the free account is limited to some features including the number of messages allowed per account per day. Despite the standard account costs USD 650 per year which makes the operation higher, but also it is limited to the number of messages per day, and the number of channels.

Another study conducted by Murdyantoro *et al.* (2019) is based on developing a prototype weather station using LoRa technology. The prototype station contained several meteorological measurement sensors, but just like the previous study, the data analysis was done on the ThingSpeak platform. The ThingSpeak platform has limitations on a free account, hence you have to pay USD 650 per year to get a standard account, which also has some limitations, and hence it increases the network operation costs.

The study conducted by Davcev *et al.* (2018) explored the use of IoT agriculture system based on LoRaWAN. The developed system contained meteorological sensors such as humidity sensor, and temperature sensor. The sensors were used to record meteorological values and the LoRaWAN network was used to transmit recorded data from sensor nodes to the gateway. The gateway forwarded the received values to the TTN IoT platform. Then REST API was used to retrieve measured values from TTN to the user database, where data is analysed and stored. The web platform was developed to enable users to access the data. Even though the system worked fine but it is complicated as the data had to pass through the TTN platform before being forwarded to the user database. Moreover, the TTN network limits the number of uplink time per device to 30 sec

and downlink messages to 10. These limitations will force premium account subscription to be able to send recorded meteorological data within a short time interval.

Last but not least is the study done by Kodali and Mandal (2017). This study aimed to develop an IoT based weather station. The developed station had sensors that record meteorological values, and it used the GPRS module to send the recorded data to the user as an email. Even though the developed system recorded the meteorological conditions, but it had neither a database to store the recorded data nor a web platform to visualize them.

CHAPTER THREE

MATERIALS AND METHODS

3.1 Introduction

This Chapter covers in details on materials and methods used to take on the study. It unveils the study area, the techniques used in data collection, materials used in the system development, and system validation.

3.2 Research Design

Research design is a framework used by researchers that contain techniques, steps and methods chosen by researcher to collect, analyse data and come up with a suitable solution to a specific research problem.

The Design Science Research (DSR) approach was used in this study as the research design framework. This was the preferred approach as it enables the researchers to pen down their research procedures from the problem statement to problem solution evaluation accurately and collaboratively (Carstensen & Bernhard, 2018). Even though there is a number of DSR models from the literatures, but in this study the DSR was grouped into five main processes, namely: Creating awareness of the problem, suggestion, development, evaluation and conclusion (Ojeniyi *et al.*, 2019). Figure 7 illustrates the main DRS stages followed in this study.

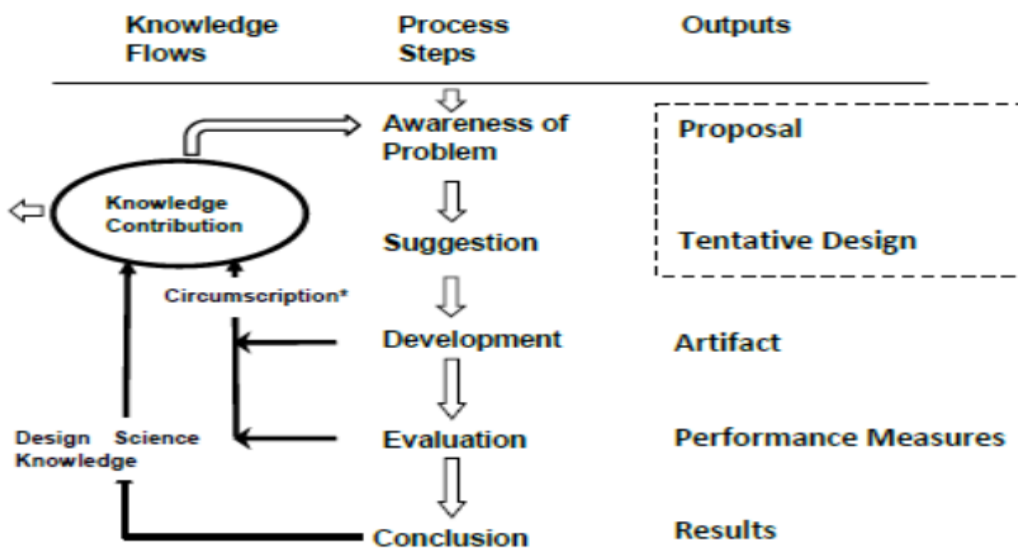

Figure 7: Processes in the Design Science Research (Ojeniyi *et al.*, 2019)

The awareness phase contains the research problem identification and analysis, whereas the output of this phase is gathering the functional and non-functional requirements of the system. The next phase is the suggestion phase which is directly connected to the development phase. The suggestion phase analyses the technologies, and materials to be used in the system development. The development phase contains the technical implementation of the system based on the functionalities, and materials and methods analysed in the problem awareness phase, and suggestion phase. Last but not least is the evaluation phase, which contains the system testing to ensure the system functional and non-functional requirements are met.

3.3 The study Area

This study was carried out in the Arumeru district, in Arusha region which is located in northern Tanzania. This area was selected due to its proximity to the university and the availability of agro-meteorological stations in the area. Moreover, it was suitable for range testing as it has some suburban areas where the range testing of LoRaWAN network communication range was done. Figure 8 shows the Arumeru district map with agro-meteorological stations visited during the study.

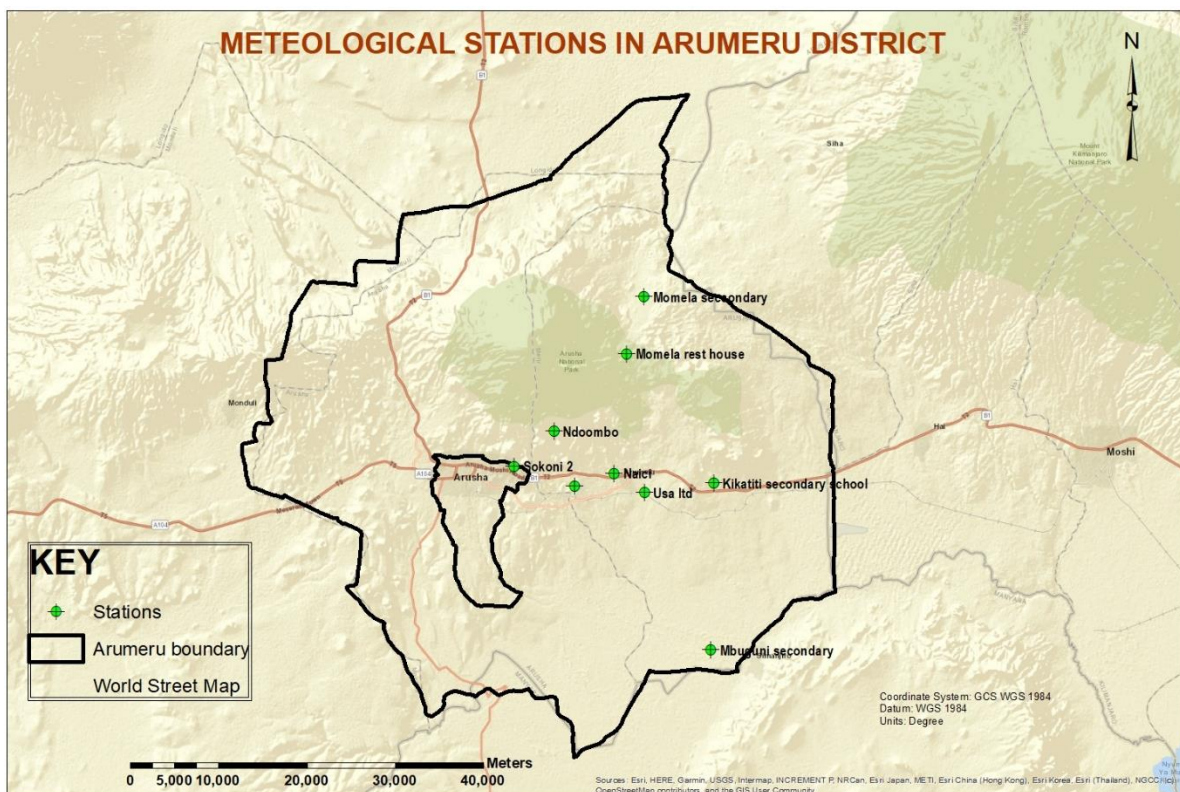

Figure 8: The study area map

Therefore, both the data collection and the system validation was done in Arumeru district in Arusha region.

3.4 Sample Size and Sampling Technique

The study targeted to determine the extent of the problem and identify the functional and non-functional requirements to develop the integrated sensor network for agro-meteorological data collection. To achieve this, the target sample size was all the agro-meteorological stations in the study area. During the study, they were nine agro-meteorological stations owned by MOA and the Pangani basin in Arumeru district. Two of the agro-meteorological stations were owned by both the MOA and the Pangani basin, while the rest of them are owned by the MOA.

3.5 Data Collection Methods

The data collection of this study was done from March 2019, in a five days duration in the stipulated study area. Several techniques were deployed in data collection including questionnaires, observation and interviews.

3.5.1 Questionnaires

Questionnaires were used to gather data from the existing agro-meteorological stations. The designed questionnaire contained close-ended questions, open-ended questions, multiple choice questions, scaled and ranking. It contained several structures questions which intended to acquire information about the existing agro-meteorological stations such as the owner of the station, the station status (working or not working), the station type whether it is manual or automatic, the weather parameters recorded in a particular station, and station location coordinates (Appendix 1).

3.5.2 Guided Interview

The questions were presented to agro-meteorological station managers, to collect more information about the stations and their experience in managing the stations. In this section, crucial information about reading meteorological data challenges was obtained and preferred station manufacturers. Moreover, other challenges regarding stations security and management were obtained.

3.5.3 Observation

This data collection method played a major role in acquiring details on the station positioning. This provided details on the existence of the blockages which prevent obtaining accurate data such as trees above the rain gauges, and blockages that prevent accurate reading of the wind speed. Moreover, this method helped to obtain details on stations vandalism, and hence provide details on functional requirements to develop integrated sensor networks for agro-meteorological.

3.6 Data Analysis Method

This method aims to order, structure, and provide meaningful information from the data collected which enables the researcher to investigate the collected data variables with their relationship, effects, and the involvement pattern (Jung, 2019).

Data obtained from the distributed questionnaire, observation, and structured interview were categorized into two groups which are quantitative data, and qualitative data. Python was used to analyse quantitative data since it is a suitable programming language for data analysis. The data collected through a structured questionnaire are quantitative, the percentages and frequencies were interpreted, and the inferences were drawn.

On the other hand, the inductive approach was used to analyse the collected qualitative data. This method was used to analyse data collected from the observation, unstructured interviews, and literature review. The data obtained was organized, categorized, and analysed using the content analysis technique to identify the system functional and non-functional requirements (Lester *et al.*, 2020). Finally, the information obtained from both qualitative and quantitative data were compared to come up with an effective way to develop the proposed system.

3.7 Designing of the Integrated Sensor Network for Agro-Meteorological Data Collection

This section explains how an integrated sensor network for agro-meteorological data collection was designed and developed.

3.7.1 Requirements Analysis

The requirements analysis is the most common way of determining the users expectation for a new or modified system/product (Demirel & Das, 2018). These features are called requirements, and they should be quantifiable appropriate and detailed. All the customer expectations for the system to be developed are defined in requirement analysis, and it also answers all the system requirements as identified by the customer.

This study highlights the functional and non-functional requirements of the integrated sensor network for agro-meteorological data collection in Tanzania. The functional requirements present all the basic functionality of the system, while non-functional requirements present the qualities for the proposed system.

3.7.2 Functional Requirements

- (i) The system sensors must be able to record real time meteorological parameters. The developed system used the temperature sensor, humidity sensor, rain gauge, and GPS to track the location of a specific node.
- (ii) The LoRaWAN node must be able to record data from weather monitoring sensors and send them to the LoRa gateway using the LoRaWAN network.
- (iii) LoRaWAN gateway must be able to forward data received from several nodes to the server.
- (iv) Weather stations (nodes) must be able to listen to commands from the user, to get the time interval required for them to send meteorological data.
- (v) Users must log in to access the data sent from the meteorological stations.
- (vi) The developed web portal must display data received from the stations in real time without requiring the user to refresh a page.
- (vii) Data are displayed in both tabular and graphical formats.
- (viii) The user must be able to download data in pdf format for further reference.
- (ix) Users must be able to download the selected data in excel format for further analysis and research purposes.
- (x) Users must be notified whenever a certain weather parameter exceeds or goes below the desired value.

3.7.3 Non-Functional Requirements

(i) System Security

This is very important functionality to any developed system, this part prevents unauthorized intruders to access, modify or altering the system or the system data (Lee & Lee, 2021). The developed system has implemented security features in both the data network transmission channel, and the data server-side. In the network transmission, the meteorological stations use the OTAA method whereby a network join request contains DevEUI, JoinEUI, and DevNonce. This is an inbuilt LoRaWAN security feature to prevent network security attacks from intruders, and it will be described in detail in the system design. To ensure the system is secured in the web portal, and

server side, the MySQLi parameter binding was used. This feature prevents MySQL injection and hence improve the system security.

(ii) System Scalability

This refers to the ability of the system to increase or decrease the system performance, cost, or functionalities. Even though, the developed system records temperature, humidity, and rainfall but the system is scalable and additional sensors such as atmospheric pressure, wind speed, and wind direction sensors can be added to the system. Moreover, the system accepts an unlimited number of meteorological stations, and other stations can be added. The developed web portal supports system scalability as well, as it has room to visualize data to be collected by additional stations and sensors.

(iii) Accessibility

Based on the data collected from this study it shows the developed system must be accessible to users in different locations, and anytime. Therefore, the developed system uses a web portal that is online and can be accessible every time and everywhere, as long as the user has the login credentials.

(iv) Usability

The developed system allows users with different computer literacy can easily interact with it. The web portal menus are visible and self-explanatory, and hence make it easier for anyone to interact with the system.

3.8 System Development Approach

The Rapid Application Development (RAD) was deployed as the Software Development Life Cycle model (SDLC) as shown in Fig. 9. This was the preferred model because it emphasizes communication between the developer, and customer and enhances early delivery of the product as it meets a limited developments timeframe (Dawson *et al.*, 2010).

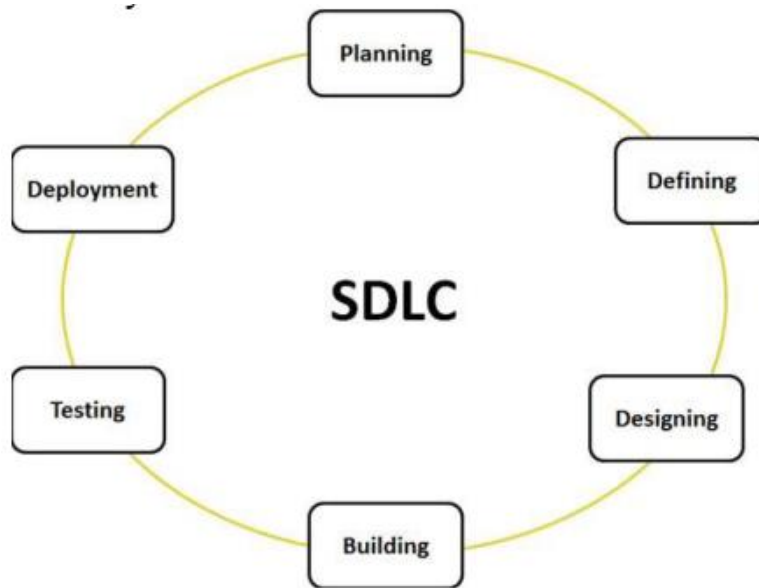

Figure 9: Rapid Application Development lifecycle (Shyles, 2019)

3.9 System Implementation

The system implementation used different software and hardware tools. This included the selections of suitable sensors for agro-metrological data collection, the suitable transmission network, web application for data visualization, and database management system. The selected tools are explained in detail in the following subsections:

3.9.1 Meteorological Stations

These are the main component of the developed system. The stations comprise sensors that record real time meteorological data, and the LoRa nodes which send collected data to the LoRa gateway through the LoRa network. The selected components were based on the design criteria established during the data collection to identify system requirements. These design criteria aimed to come up efficient, accurate, cost effective, scalable, and compatible system. Subsections below explain sensors used to collect meteorological data, and the nodes used to transmit data to the LoRa gateway.

(i) Temperature and Humidity Sensor

The DHT 11 is an affordable digital temperature and humidity sensor, and it is suitable for measuring temperature at the range of 0°C to 50°C, and humidity at the range of 20% to 100%, with an operating voltage of 3-5V. Moreover, the sensor operates with a low current of 0.3 mA during measuring and 60 uA on standby mode. Figure 10 shows the DHT 11 temperature and humidity sensor.

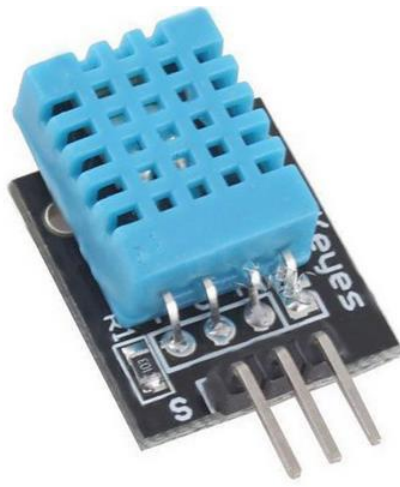

Figure 10: DHT 11, temperature and humidity sensor

As shown in Fig. 10, the DHT 11 has three pins, two of the pins are responsible for the power supply, and the rest of the pins is used for data transmission. The data pin sends both temperature and humidity as serial data in eight bits microcontroller to output. The sensor is also calibrated and hence can be easily interfaced with other microcontrollers. The sensor accuracy is $\pm 1^{\circ}\text{C}$ and $\pm 1\%$ for temperature and humidity respectively.

(ii) The Rain Gauge Tipping Bucket

Another sensor used on the node side is the rain gauge tipping bucket with a 0.2 mm resolution. The rain gauge tipping bucket has an accuracy of 0.0002 mm and it uses a reed switch to generate digital pulses after every 0.2 mm of rain. Figure 11 shows the rain gauge tipping bucket used for this study.



Figure 11: The rain gauge tipping bucket

The tipping bucket rain gauge has a funnel that collects and the rain into a small seesaw-like container. After 0.2 mm of rain, the reed switch trigger and send the pulse signal, which is later calculated by software to determine the total amount of rainfall recorded.

(iii) The Global Positioning System Module

The GPS module was also used on a node side and it served two main purposes. The first one was to track the location of the installed meteorological station, and secondly, but important as well is to generate timestamps for the measured meteorological data. Figure 12 show the GPS module used in the developed system.

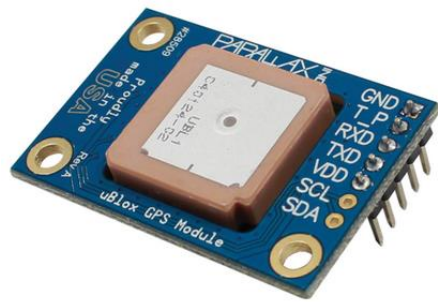

Figure 12: Global positioning system module

(iv) The Arduino MKR1300 LoRa Module

The Arduino MKR1300 module is designed to provide a cost effective, and practical way for developers who prefer using the LoRaWAN network for data transmission. It is designed to use 1.5V AA or AAA batteries or an external power supply with 5V, which can be switched automatically. Just like the Arduino board, the MKR1300 board has I/O interfaces to connect with sensors. The Figure 13 shows the MKR1300 board.

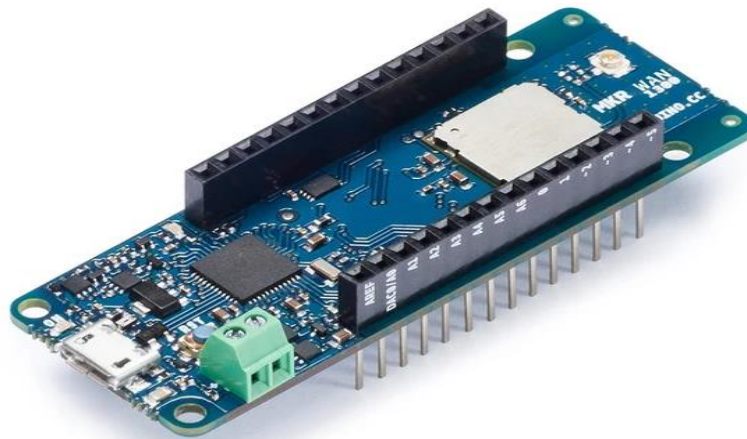

Figure 13: The Arduino MKR1300 LoRa module

This board has an antenna plugin interface, which facilitates the data transfer through the LoRaWAN network. The antenna connection interface offers flexibility to the user to select an antenna with preferable gain for data transmission.

3.9.2 Transmission Network

The LoRaWAN means Low power, wide area network, this is a private network with allows the end devices (Nodes) to send data in a wide range while using low power end devices (Clavier, 2017). This technology was developed by Cycleo and was acquired and patented by Semtech in 2014. The LoRa physical layer operates in the unlicensed industrial, scientific, and medical (ISM) radio bands that is 433 MHz and 868 MHz in Europe and 915 MHz in North America.

After sensors configurations and the MKRWAN 1300 board is also configured to enable transmission of sensor data to the gateway via the LoRaWAN network. For end devices to join the LoRaWAN network, they can either be activated by ABP or OTAA. These two activation mechanisms ensure the security of the network, though OTAA is more flexible and secured (Butun & Pereira, 2019), and recommended on higher security demanding applications. In this study, end devices use the OTAA activation method, whereby a network join request contains DevEUI, JoinEUI and DevNonce. The NwkKey is used to calculate Message Integrity Check (MIC), and only if the end device is permitted to join the network, the network server will respond with the join accept message, which contains DevAddr, JoinNonce and other parameters (Haxhibeqiri, 2018).

The Data sent from end devices is the station identification number (ID), measured temperature and humidity values, rainfall data, and data timestamp recorded by GPS. The station location with coordinates is directly registered to the server to reduce packet size.

(i) BotRf Simulation Software

For the LoRa node to communicate with the LoRaWAN gateway a line of sight is needed between the two devices. The BotRf simulation software was used to ensure there is a clear line of sight between the end device and the gateway. Even though there are many commercially available software intends to solve the same problem, but majority of them use digital elevation maps, while some are quite expensive, and others can only be used by the radio and antenna of a particular manufacturer (Zennaro *et al.*, 2019). The BotRF is an open-source wireless link planning tool running on Telegram software, and it is supported by any smartphone or computer with Telegram software installed. This software is capable of simulating a terrain profile of the specific area and calculating the path loss in a specified wireless link. For useful wireless link must have at least 60%

of the Fresnel zone cleared. Figure 13 shows the simulation results of the transmission link between the two selected points. The brown line represents the apparent earth's bulge, the green line represents the apparent terrain profile, and the magenta line represents 60 % of the first Fresnel zone. The simulation results show there is no obstruction between the two points, and therefore the link can be used for communication between the end device and the gateway.

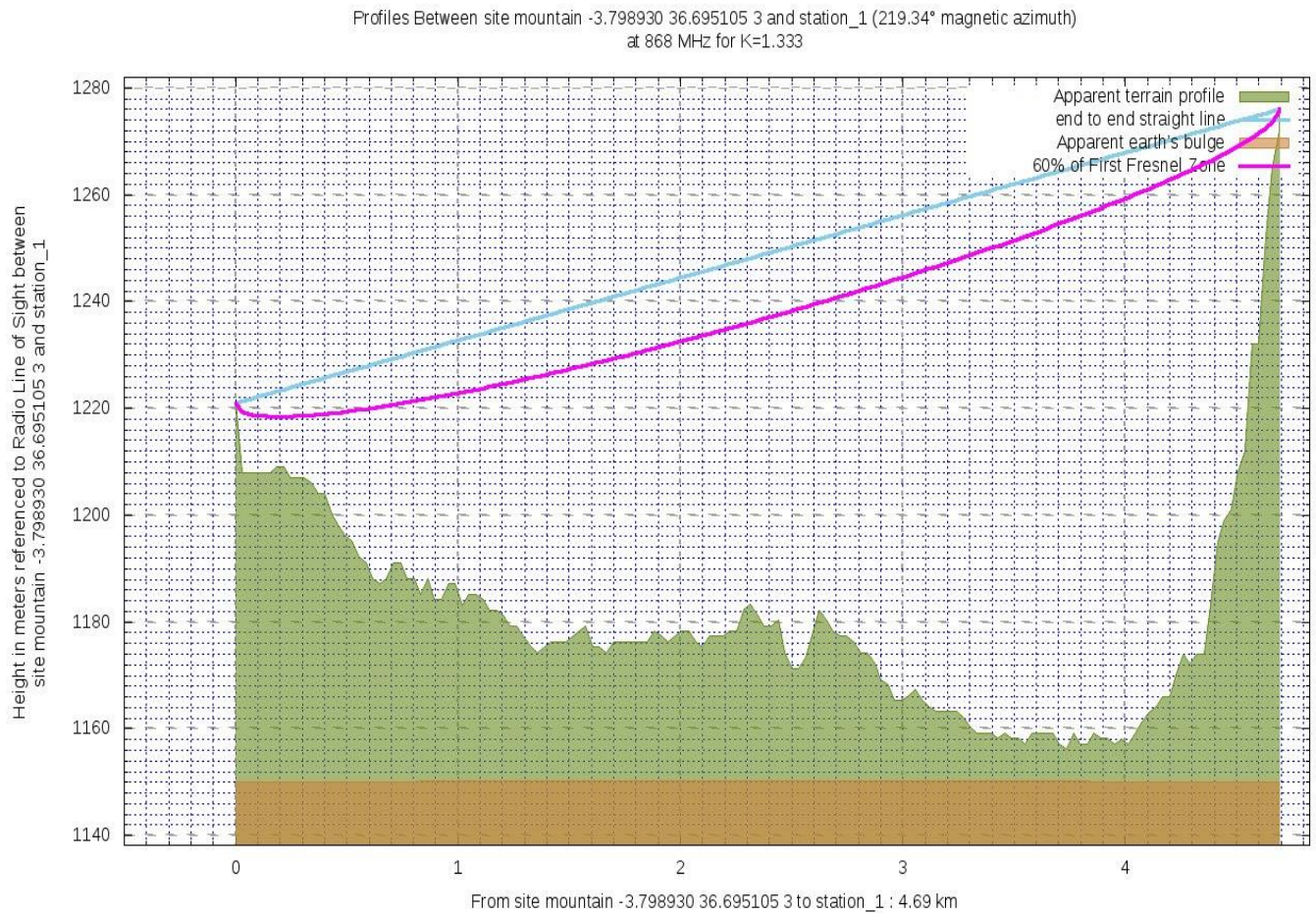

Figure 14: BotRF terrain simulation

3.9.3 LoRaWAN Gateway

The gateway consists of RisingHF RHF0M301 gateway, 6 dBi fibreglass antenna, raspberry pi 3 model B, and SD card for operating system (OS) installation. The RisingHF RHF0M301 gateway has a connection interface to connect with raspberry pi. The raspberry pi has an ARM quad-core processor and power specifications of 3.3V, 5V and 2A, which can either be supplied by grid or battery. The leading role of the gateway is to forward packets received from end devices via the LoRaWAN network to the network server database. To do so, the gateway requires Internet access. With raspberry pi 3, the gateway can access the Internet wirelessly or through an Ethernet cable connection. Figure 14 shows LoRaWAN gateway connected to raspberry pi 3.

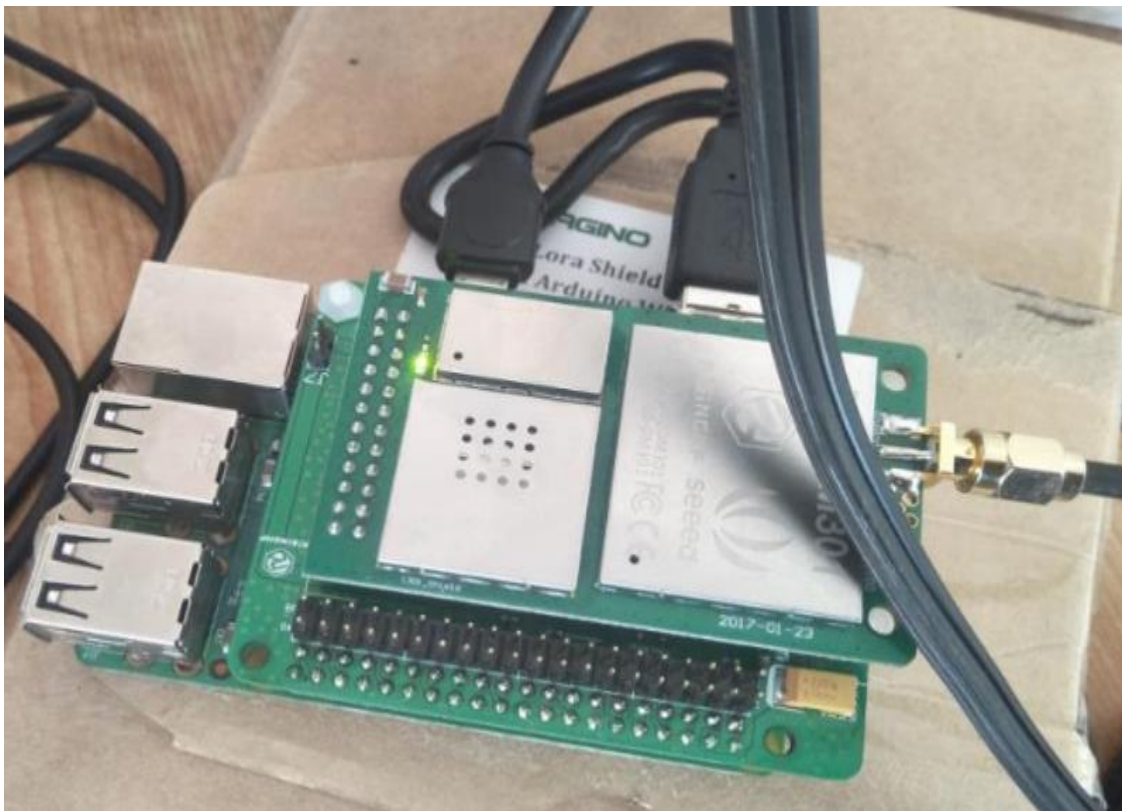

Figure 15: LoRaWAN gateway connected with raspberry pi 3

The gateway can be configured to forward end devices data to online platforms such as the Things Network (TTN), ThingPark and Long-Range IoT (LORIIOT). These platforms provide HyperText Transfer Protocol (HTTP) integration, which enables users to forward their sensors data from these platforms to their own servers' database. Even though these platforms are used by many, they have limitations to users with a free account. For instance, TTN allows an average of 30 seconds uplink time per day for every device and a maximum of 10 downlink messages per day per device, while the Loriot platform limits the number of user accounts, user applications, and only one gateway and a maximum of ten devices (Long-range IoT [LORIIOT], 2018) are allowed in a free account. The ThingPark platform allows only one gateway and a maximum of five devices (Home-ThingPark, 2019) in a free account.

To avoid limitations from the mentioned platforms, the LoRa Server Project developed a free and open-source LoRa Gateway Operating System, which provides full capabilities to build up a private network without limitations (ChirpStack, 2017). The RisingHF RHF0M301 gateway is among LoRa gateways, which support the LoRa Gateway Operating system. The other ones are LORIX One, IMST - iC880A, Kit RAK - RAK2245, Pi Supply - LoRa Gateway Hat, RAK - RAK831 Gateway Developer, IMST - iC980A, and Sandbox Electronics - LoRaGo PORT. This operating system comes in two versions, which are the base version and the full version. In this study, the full version was used, and it contains three main components, which are the LoRa Gateway Bridge, LoRa server and LoRa App server.

The LoRa Gateway Bridge: The service facilitates the communication between the gateway and the network server. It also converts LoRa packet-forwarder protocols into a LoRa Server standard protocol. It uses Semtech Packet forwarder to forward the received packets by the concentrator to a server through an IP/UDP link. It also translates UDP protocol from the gateway to JavaScript Object Notation (JSON) message and publishes it to Message Queuing Telemetry Transport (MQTT) implementation at the server (Albert & Haslhofer, 2017).

The LoRa Server is an open-source and the core application server of the LoRaWAN network. It keeps track of active end devices and the one that wants to join the network (Torres *et al.*, 2018). It also supports both OTAA and ABP activation mechanisms. For the end devices that want to join the network, it will check with the Application server to confirm if it is allowed to join the network, and if so, it verifies the end device by authenticating it and forwarding it to the application server. It also supports the ADR mechanism, and it also decrypts the received data payload before reaching the MQTT broker (Zinas *et al.*, 2018). Furthermore, it handles LoRaWAN mac-layer, the uplink packets received by the gateway(s), and the scheduling of downlink data transmissions (LoRa Server, 2019).

The LoRa App server is an open-source of the LoRaWAN application server that acts as a bridge between the IoT cloud and the LoRa Server. It has a web interface that enables end devices inventory by offering nodes and gateway administration by application and organization. It has RESTful and gRPC API for integration with external services; moreover, it provides different ways of sending and receiving device payloads that can either be through MQTT, HTTP or writing directly into an InfluxDB database. The communication with applications is through JSON and Application Programming Interfaces (APIs). Figure 15 shows the application server interface with is used to add end devices (nodes) to a specific gateway.

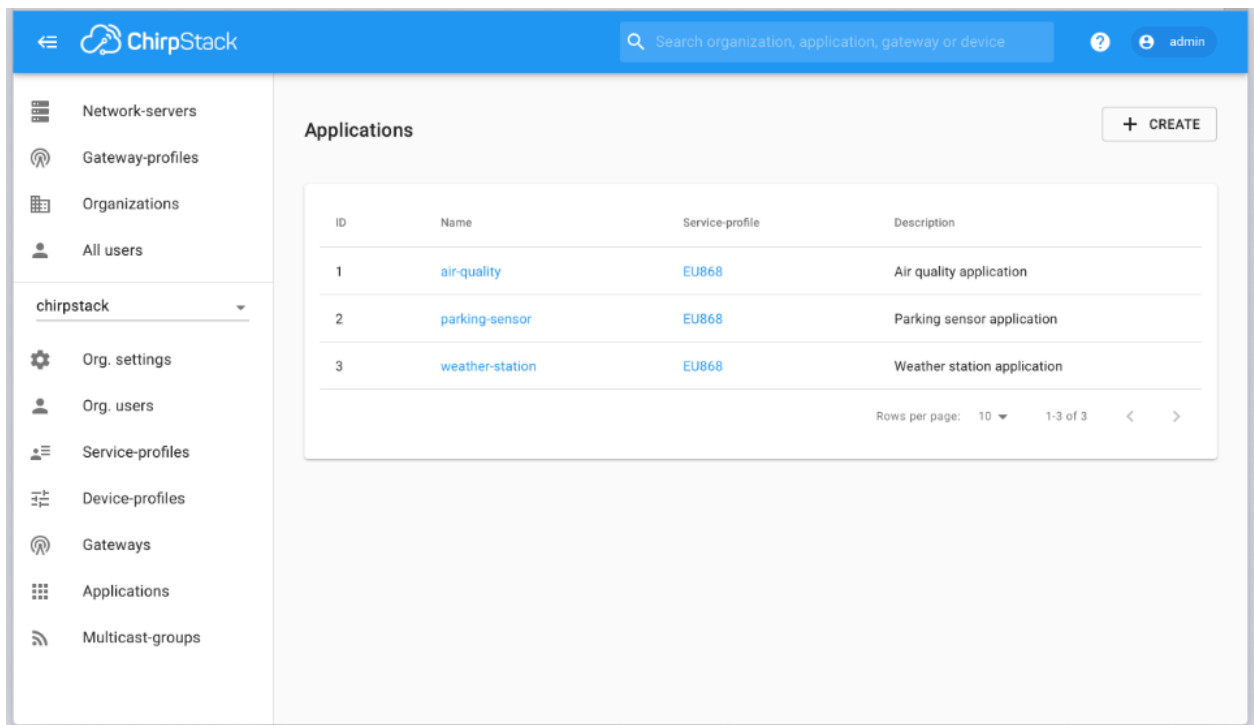

Figure 16: LoRa Gateway Operating System application server interface

3.9.4 Web Application Development

The web application development required different programming languages such as Hypertext Preprocessor (PHP), Hypertext Markup Language (HTML), Cascade Styling Sheet (CSS), JavaScript, and jQuery. The PHP is a server-side popular scripting language that is preferred by many developers, to develop a web application (Prokofyeva & Boltunova, 2017). In this study, PHP was selected because, it is free, compatible, secured, and open-source with many available databases. Moreover, PHP has a large support community. The web application interfaces were developed by using HTML and JavaScript languages. To ensure there is a good user interface the CSS was used to provide an excellent web interface and makes it more user-friendly and attractive. Also, CSS was used to build web applications responsive to various devices such as mobile phones, tablets, and computers with different screen resolutions. Lastly, Ajax library was used for fetching data dynamic to the web application interface without requiring a page to refresh.

In the server part, a free and open-source MySQL database was used; however, the MySQL database has a weakness in handling concurrent database reading and writing operations but provides real-time and efficient data storage services (Zhou *et al.*, 2019).

(i) JavaScript Object Notation

The LoRaWAN gateway communicated with the cloud server through Hypertext Transfer Protocol (HTTP) messages. The data transmitted is encrypted and encapsulated in JavaScript Object

Notation (JSON) format, which acts as the data interchange standard between clients and the servers (Joshi & Nagar, 2015).

3.10 System Testing and Validation

The system was tested basing on the three phases which were, the unit test, integration test, and system test. The unit test involved the single module functionality test before the module was integrated into a system. Integration testing was done when adding a module in the system to eliminate any logical or syntax errors prior introducing the next module. Finally, system testing and validation were performed to ensure that the developed system covers all the required functional and non-functional requirements as identified during requirement gathering. Finally, network communication testing was done, this includes mobile antenna testing and network range testing.

3.11 Assumptions and Dependencies

The following assumptions were considered during the development of the system:

- (i) There is no extreme weather condition of temperature below 9°C and above 51°C as the temperature sensor measures accurately temperature within the range of 0°C to 50°C.
- (ii) Humidity in the atmosphere should be in the range of 20% to 100%, as a humidity sensor is designed to measure humidity in that specified range.
- (iii) There is the availability of Internet connection in a LoRaWAN gateway as it requires the availability of Internet connection to forward data received from the nodes to the server.
- (iv) No emerging obstacle between the meteorological stations (nodes) with the LoRaWAN gateway as the line of sight is required for the gateway to receive nodes data.
- (v) The cloud server is secured and has enough storage, processing power, and work efficiently to provide services to the client application.
- (vi) A reliable cloud server, and available whenever users want to access data.
- (vii) All users know how to read and write.
- (viii) All users have Internet access.
- (ix) All users have computer knowledge, and they can use a web browser to access the weather monitoring system.

CHAPTER FOUR

RESULTS AND DISCUSSION

3.12 Results

This Chapter covers the results obtained from data collection in the study area and results obtained from the developed system and the system testing. Furthermore, this Chapter cover the details of the developed system, and network testing results.

4.1.1 Findings from the Meteorological Station

Meteorological stations data were collected to determine the problems associated with the current system, and how the proposed system would solve most of the existing problems. This section answers the first specific objective of the study, which was to analyse the challenges facing the existing agro-meteorological stations and gather the functional and non-functional requirements for the proposed system.

(i) Demographic Information of the Respondent

Since the study focused on the existing agro-meteorological stations, the respondents were the station managers who take care of the stations and record meteorological data. It is equally important to consider the demographic characteristics of the station managers as potential users of the system. The study considered demographic characteristics such as the gender, age and level of education. These data were important to access the usability of the proposed system.

Out of nine stations managers, five were males, while four were females. Majority of the station managers aged between 35 and 45 years old. Lastly, all of the respondents had at least an ordinary diploma. Table 4 shows the demographic information of all respondents.

Table 4: Demographic information of consumers

Demographic characteristics		Respondent	Percentage (%)
Gender	Male	5	55.6
	Female	4	44.4
Age (in Years)	Less than 25	0	0
	25-35	3	33.3
	35-45	4	44.4
	45-55	1	11.1
	Above 55	1	11.1
Education level	Non-formal education	0	0
	Primary education	0	0
	Secondary education	0	0
	Ordinary diploma	4	44.4
	Bachelor degree	5	55.6
	Postgraduate education	0	0

(ii) Meteorological Stations Establishment and Ownership

This study collected data regarding the establishment of the stations and station ownership. This information aimed to unveil the reliability and maintenance of the existing stations. The collected data shows six out of nine stations were established after 2014, while two of the stations had more than 15 years since establishment and one was unknown. This study identified two stations that were owned in collaboration with MOA and Pangani basin, one station is owned by the TMA and the rest are owned by MOA. Table 5 summarizes the stations establishment and ownership

Table 5: Stations establishment and ownership

Station Name	Year of establishment	Owner	Status
Ndoombo	2017	Pangani basin and MOA	Working
Momela secondary	2019	MOA	Working
Momela rest house	2014	MOA	Working
Mbuguni secondary	2019	Mbuguni	Working
Usa limited	More than 15 years	MOA	Working
Kikatiti secondary school	2019	MOA	Working
Naici	More than 20 years	MOA	Working
Sokoni 2	2019	TMA	Working
Chuo cha Mifugo	Unknown	Pangani basin, and MOA	Working

(iii) The Existing Meteorological Station Details

More details about the existing meteorological stations visited during this study will be covered in this section:

Meteorological Parameters Recorded

This study identified among the nine stations visited, seven of them only recorded only rainfall data. The other two stations record more than one meteorological parameter, for instance, Ndoombo station records rainfall, temperature, humidity, wind speed, atmospheric pressure, and wind direction, while Chuo cha Mifugo station records atmospheric pressure, temperature, rainfall, humidity, wind speed, wind direction and sunshine. From the questionnaires, interviews and literature review, this study identified temperature, humidity, and rainfall are the crucial weather parameters to be recorded in the agro-meteorological station.

Types of the Existing Meteorological Stations

This study aimed to collect information about types of the existing meteorological stations and their associated challenges to come up with a better system. The study conducted found only two automatic meteorological stations which were located at Ndoombo primary school and Chuo cha Mifugo, the rest of the stations were manual stations.

(iv) Challenges Facing the Existing Meteorological Stations

The first objective of this study was to identify the challenges facing the existing meteorological stations. This objective focused on improving the current system by solving some if not all of the challenges of the existing meteorological stations. Listed below are the challenges identified during the study and how the proposed system will overcome them:

- (i) In the existing manual stations, the meteorological data are recorded on cards daily but the recorded data are sent to the respective agencies (MOA, TMA, or Pangani basin) via the postal office in a month time interval. The postal office also takes a few days for the cards to reach the intended destination. The delay of data reaching the intended agency, especially the MOA makes the early warning concept in food security hard (Ginkel, 2021) to implement. Therefore, there is a need to come up with a system that records and sends real-time meteorological data.
- (ii) Even though this study found two installed automatic meteorological stations, but only one was working. The interview with the station manager at Chuo cha Mifugo highlighted that

the automatic station malfunctioned, but the maintenance failed because they couldn't invite the station equipment manufacturers for the station maintenance. Therefore, there is a need to have a local manufactured meteorological station with accessible personnel for quick and reliable maintenance.

- (iii) The station inspections and maintenance have not be done for a long time in most of the existing stations. This can question the accuracy of the data recorded (Hunziker *et al.*, 2017).
- (iv) From the observation, this study identified vandalism as one of the challenges facing the existing meteorological stations. Figure 17 shows vandalism on automatic meteorological at Chuo cha Mifugo.



Figure 17: Vandalized rain-gauge which was used in the automatic meteorological station

- (v) Lack of motivation to most station managers. Form the study conducted shows among the nine stations visited, only one station (Chuo cha Mifugo Station) had a paid employee, the rest of the stations were volunteers. This hinders the zeal of the station managers to clean and take good care of the station.

4.1.2 System Modelling

The design phase of the proposed system relied mainly on the following design criteria; cost, usability and efficiency. To develop a low cost system, the selection of the tools and equipment was considering the purchasing costs while ensuring the minimum system requirements were met. Moreover, the communication network from the stations to the gateway is free of charge while only the gateway uses Internet data. Usability of the system was taken to account during the system development as well. The developed system provides the basic functionalities to the system admin and other users. The web application is simple and recorded meteorological information are displayed in both tabular and graphical way. System efficiency stands for the ability of the system to deliver the intended services while using minimum resources, therefore system efficiency was considered during the development.

(i) System Design Architecture

The designed system uses the application of the IoT to record and send meteorological data to the server. The conceptual framework of the deigned system consists of meteorological stations (nodes), LoRaWAN network, LoRa gateway and cloud server. The functionalities of each component in the system are explained below:

Meteorological Station

These contain sensors that record meteorological data from the field, and send the recorded data to the LoRa gateway via LoRaWAN which operates in unlicensed ISM frequency bands of 868 MHz.

LoRa Gateway

This is the gateway between LoRaWAN and the Internet. The data sent by LoRa nodes through LoRaWAN are forwarded to the cloud server by the gateway through the Internet connection.

Application and Database Serve

The database server store the recorded data while the web application provides an interface for users to visualize the recorded data. Figure 18 illustrates a conceptual framework of the proposed integrated sensor network for agro-meteorological data collection in Tanzania.

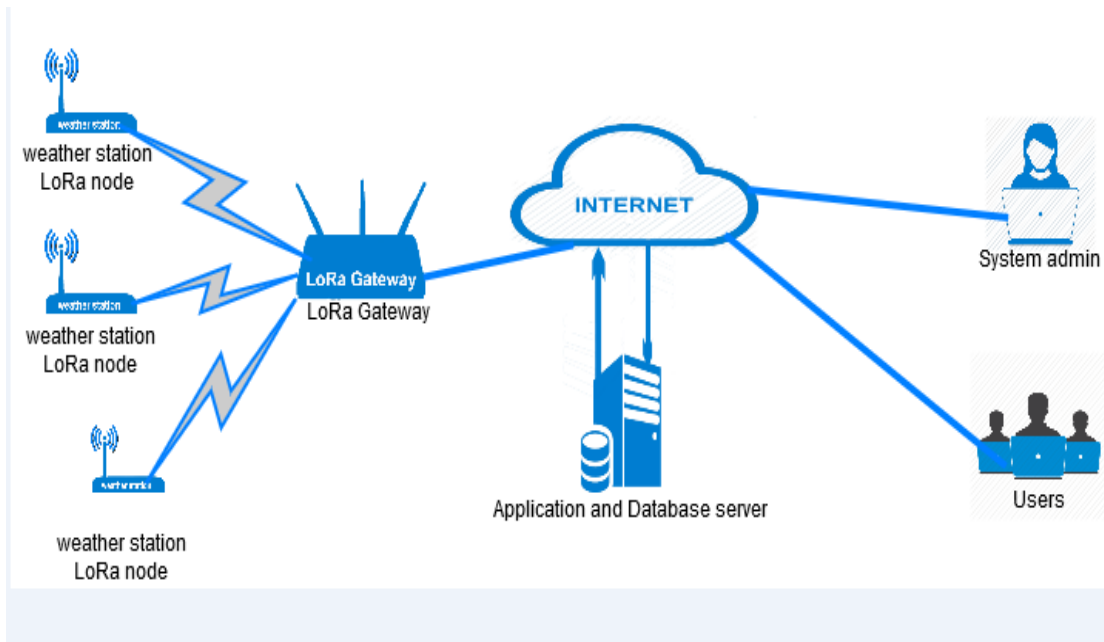

Figure 18: Conceptual framework of the proposed system

4.1.3 System Development

The development of the Integrated Sensor Network for Agro-meteorological data collection was divided into three phases. The first phase was to develop the meteorological station, the second phase was to configure the LoRa gateway and lastly was to develop a web application for data visualization, and data storage.

(i) Meteorological Station Development

The meteorological station contained three types of sensors namely, the DHT 11 temperature and humidity sensor, the rain gauge tipping bucket, and the GPS module. All these sensors were integrated to measure three different meteorological parameters which are rainfall, temperature, and humidity. Just like other Arduino boards, the Arduino MKR1300 LoRa module has analogue and digital inputs for connecting sensors. The mentioned sensors were connected to Arduino MKR1300 LoRa module interfaces and the module was programmed by C programming language. During the development, the integration of sensors was done one by one. One sensor was connected, programmed, and tested before connecting the other sensors. Lastly, the Arduino MKR1300 LoRa module was programmed to use the OTAA activation method, whereby a network join request contains DevEUI, JoinEUI and DevNonce, and the gateway is responsible to check if the end device is permitted to join the network (Haxhibeqiri, 2018). Figure 19 shows the meteorological station during development before it was taken to the field to collect data.

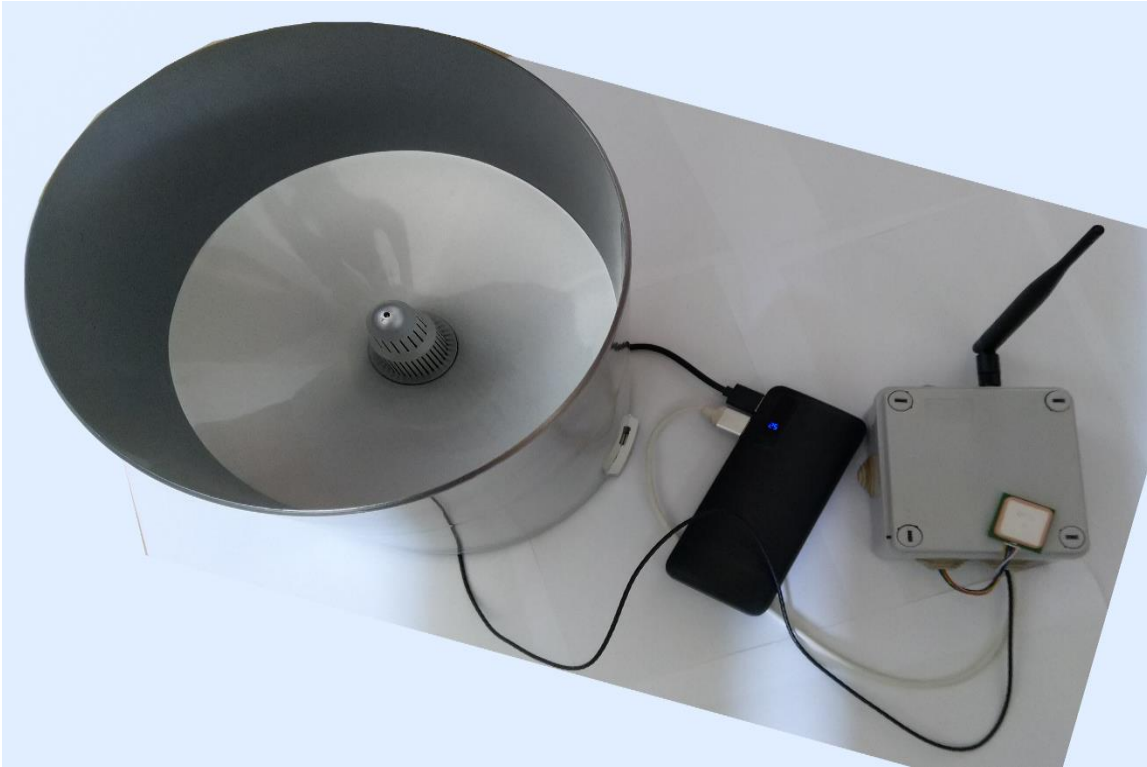

Figure 19: Developed meteorological station

(ii) LoRaWAN Gateway Configuration

The LoRaWAN gateway contained three main components, the RisingHF RHF0M301 module, the raspberry pi 3, and the communication antenna. The RisingHF RHF0M301 module is responsible for the security of the network by ensuring only the permitted end devices join the network. This is done by analyzing the DevEUI, JoinEUI, and DevNonce sent by the end nodes and the gateway used the NwkKey to calculate message integrity check (MIC) to determine whether the end device is allowed to join the network. Moreover, the RisingHF RHF0M301 module is responsible for receiving the sensor data from the nodes. The communication antenna was connected to the RisingHF RHF0M301 module to enable the gateway to receive data sent from the meteorological station via the LoRa network. In this study, the 6dbi gain antenna was used to boost the signal received from the nodes. Finally, the raspberry pi 3 was used to forward the data received from the nodes to the cloud server. It has input pins that were used to plug and connect the RisingHF RHF0M301 module. After the gateway was assembled, the configuration was done. To develop a system with a private network and avoid limitations from online platforms like TTN, ThingPark, ThingSpeak, and Lorient the LoRa Gateway Operating System was installed and configured in the raspberry pi 3. This provides functionality that enables the gateway to send data directly to the cloud server without integration with the mentioned platforms. Figure 20 shows the LoRa gateway during the device configuration.



Figure 20: LoRaWAN gateway configuration

The main function of the LoRa gateway was to forward the received meteorological data from meteorological stations (nodes) to the cloud server.

(iii) Developed Database

The database schema is an overview structure of the developed system database that identify database tables and how they are related to each other (Lukovi & Risti, 2014). Figure 21 shows the database schema of the developed system. The developed database has user management table, station details table, alert notification table, and meteorological collected data tables. The database server was developed using the MySQL database management system.

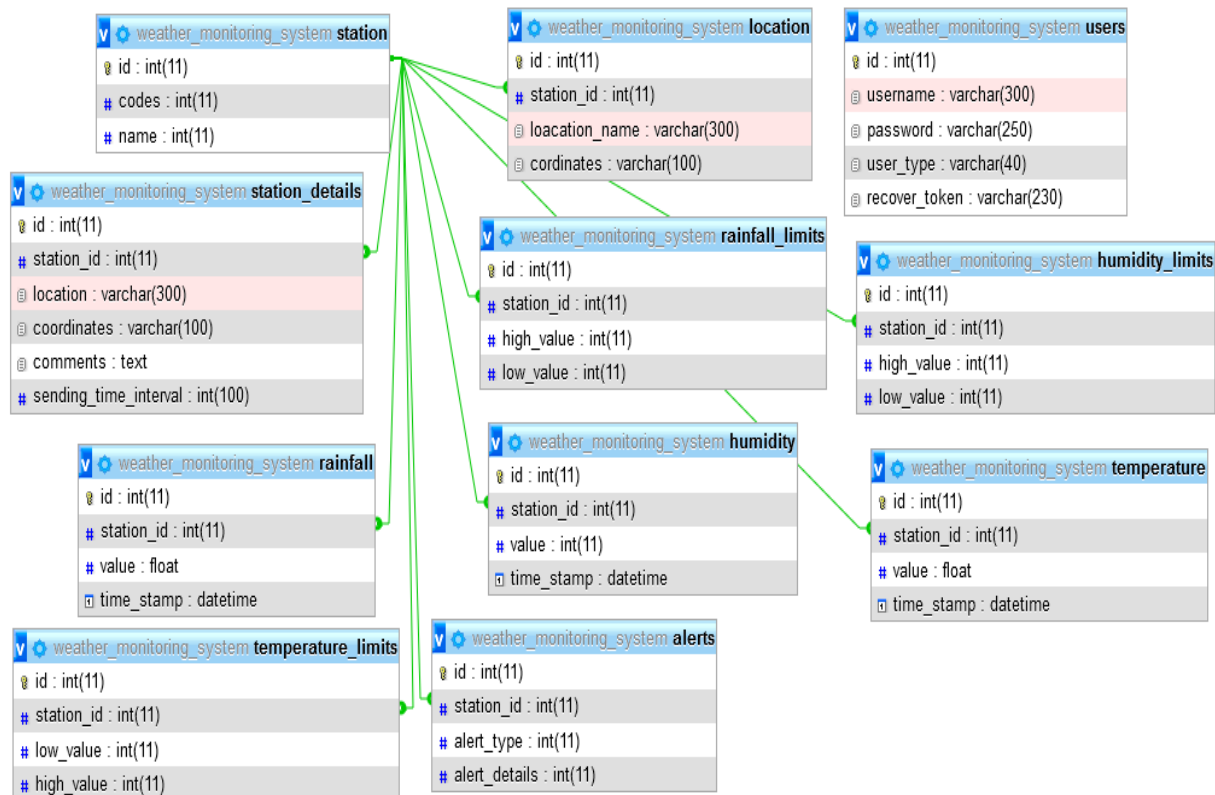

Figure 21: The developed system database schema

(iv) Web Application Development

The developed weather monitoring system targeted to provide all necessary functionalities suggested by stakeholders during the data collection. The functionalities provided by the system include user registration, user authentication, meteorological data storage, data visualization, setting warning alerts, and enabling users to download recorded data in a pre-described period. The sections below explain in detail the services provided by the developed system.

User Authentication

To ensure the security of the system, only registered users can log in to access the system resources. The developed system provides a user authentication feature, whereby all users have to log in to be able to access meteorological information. When a user accesses the web address, they will be required to enter a username and password. The web application also provides a way to retrieve the user's forgotten password. When a user click forgot password option will be directed to the password retrieval page where will be required to enter his/her username (email address) for his/her password link to be sent to his/her email address. To ensure security entered the users' passwords are encrypted by the MD5 algorithm (Ah Kioon *et al.*, 2015). Moreover, the system uses MySQLi which relational database driver used in PHP to provide an interface with MySQL database and therefore, to prevent database injection, the system use prepared statements, this is

the feature that executes SQL statements repeatedly with high efficiency. Figure 22 and 23 show the user login interface, and user recovery password interface respectively.

The Weather System

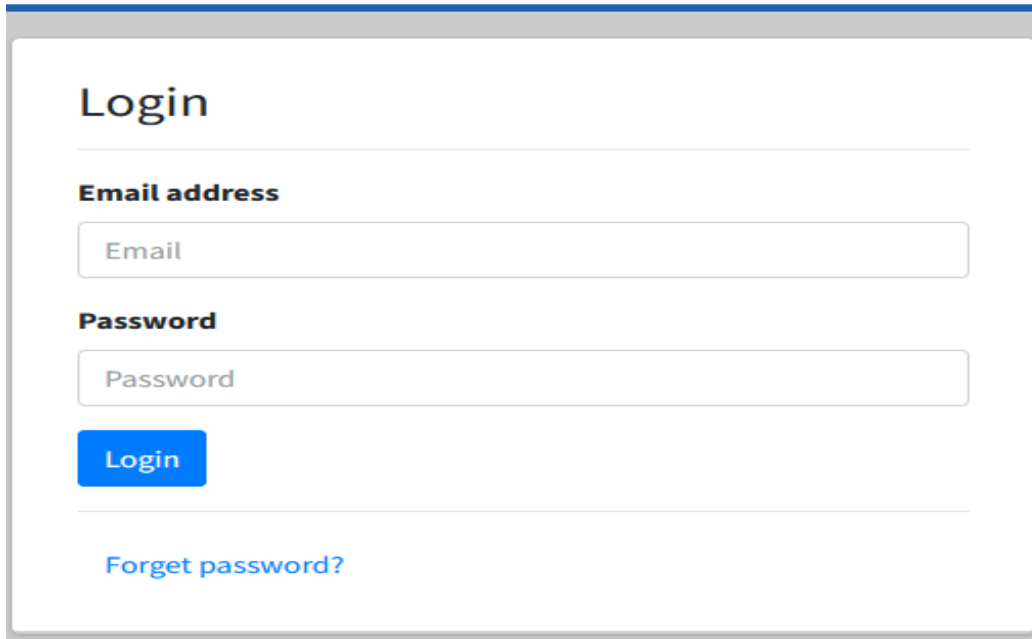

The image shows a user login page titled "Login". It features a form with two input fields: "Email address" and "Password". Below the "Password" field is a blue "Login" button. At the bottom of the form, there is a link labeled "Forget password?".

Figure 22: User log in page

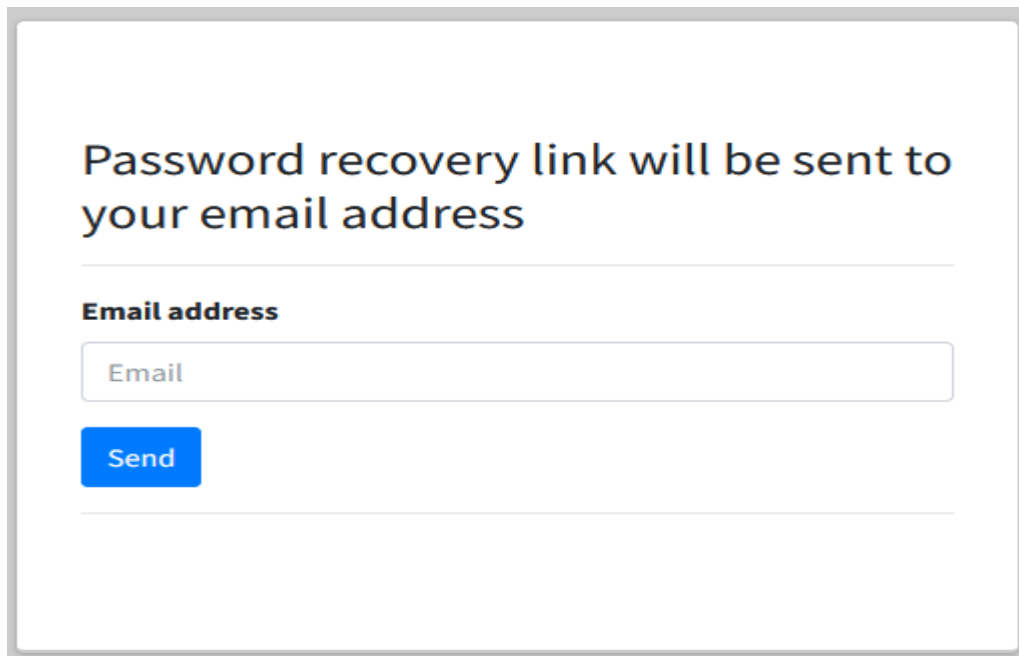

The image shows a user password recovery page. The main heading reads "Password recovery link will be sent to your email address". Below this is a form with an "Email address" label and an input field containing the placeholder text "Email". A blue "Send" button is positioned below the input field.

Figure 23: User password recovery page

Weather Monitoring System Dashboard

After a successful login users will be able to see the registered station with the data recorded, they will also be able to manage their account details. Figure 24 shows the admin dashboard after a successful login.

User: **mathew.**

Connected Devices (Nodes)

Node 1	Node 2	Node 3	
Node ID: W9HGYJK	Node ID: G1cToBO	Node ID: h1Cu6al	
Temperature: 26.40 °C	Temperature: 31.90 °C	Temperature: 23.90 °C	
Humidity: 57.00 %	Humidity: 32.30 %	Humidity: 48.40 %	
Rainfall: 0 mm	Rainfall: 0 mm	Rainfall: 0 mm	
Date&Time: 2021-11-30 08:47:29	Date&Time: 2021-06-06	Date&Time: 2021-06-06	
View More Details...	View More Details...	View More Details...	

Figure 24: System administrator dashboard

The developed system has two types of users, which are the system administrator and the other users. The system administrator account has more privileges such as adding a node (station), and user management. Moreover, under system setting the administrator account has more privileges like adding an email and phone number for email and SMS notification respectively.

System User Setting

The system setting contains three main components in the administrator account and only one on the users' accounts. The system administrator account has user account settings, email settings and SMS settings as shown in Fig. 25.

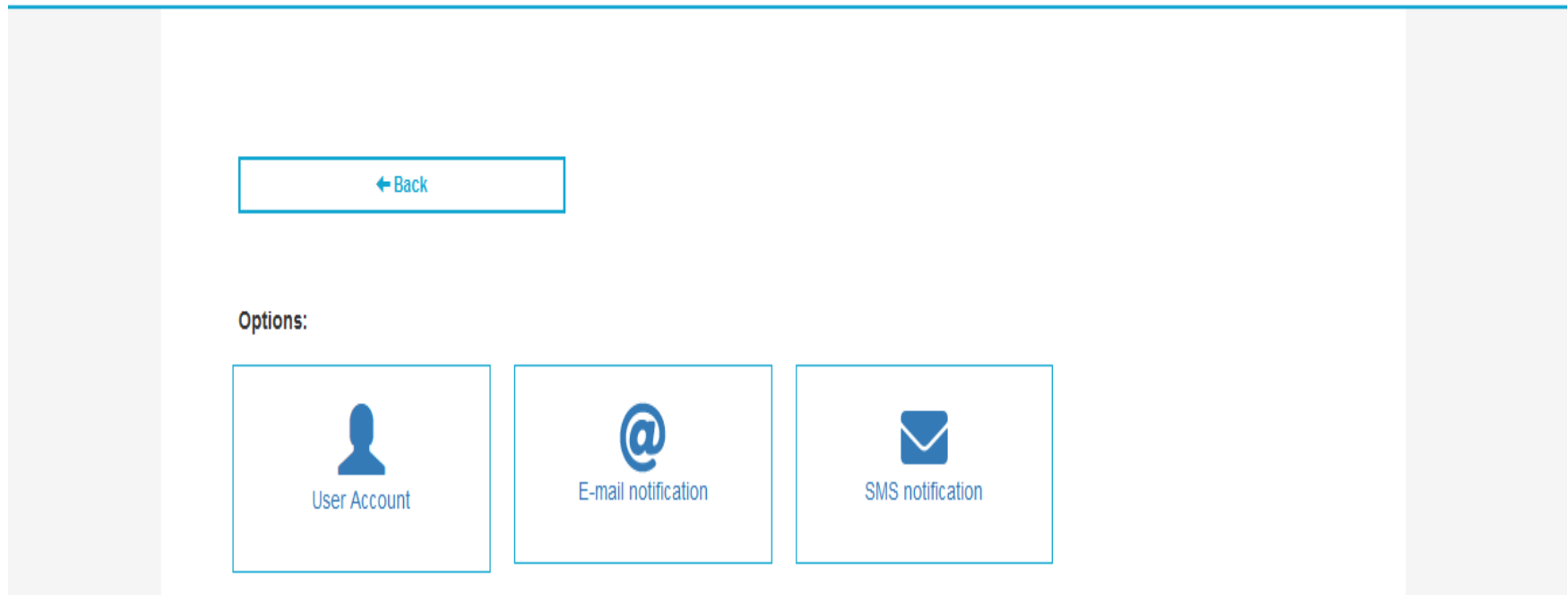

Figure 25: System administrator settings

The user account setting allows the user to change his/her username and password. Changing of username and password helps the user to secure his/her account from social engineering attacks. Whenever the user decides to change a username or password the system demands the current password to verify if he/she is the authenticated user. Figure 26(a) shows the username changing dashboard while Fig. 26(b) shows the user password changing dashboard.

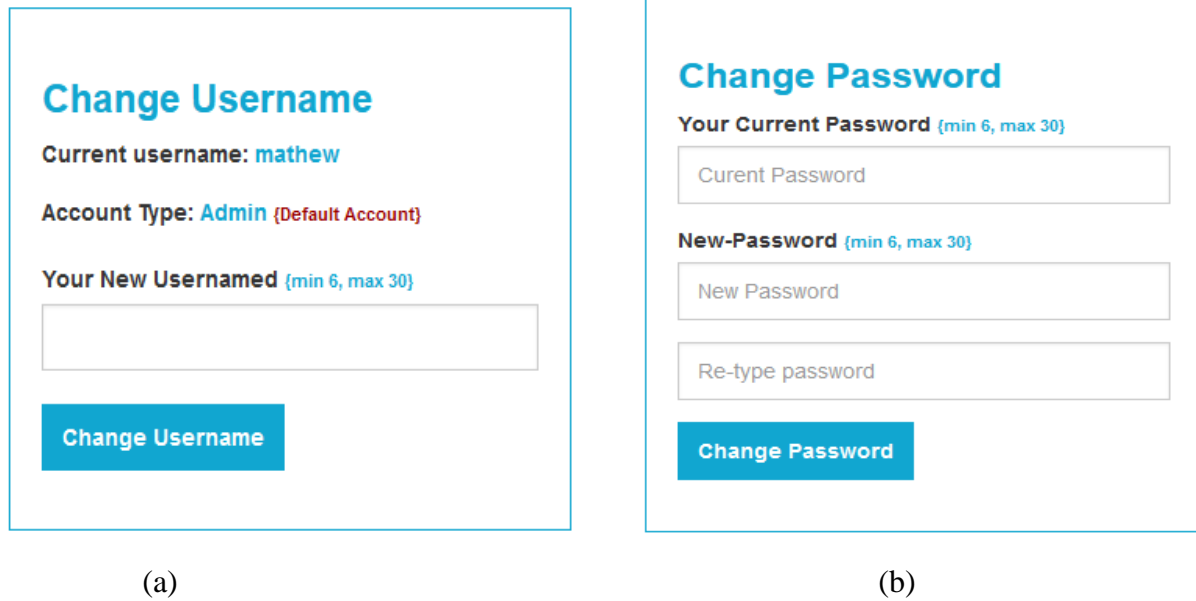

Figure 26: System User account settings

Apart from the user account setting, the system admin can access email and SMS notification settings. These settings are particular for receiving notifications when weather parameters go beyond the predefined desired range. Notifications can be sent to many email addresses as well as SMS to many phone numbers, as defined by the system administrator. Figure 27 (a) and (b) show the notifications setting dashboard for SMS and Email respectively.

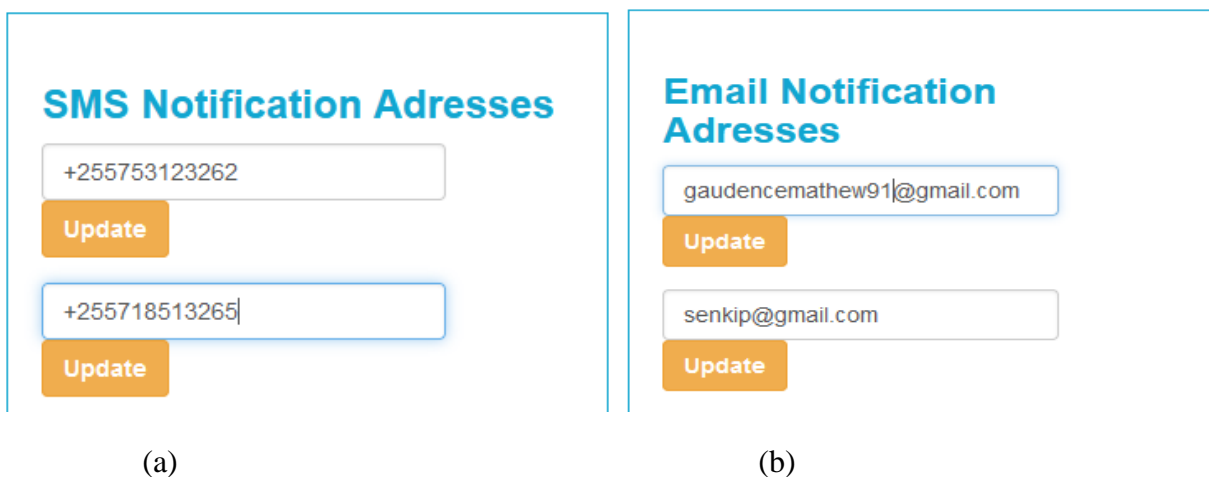

Figure 27: System notification settings dashboard

Weather Parameters Visualization

This is the core functionality of the developed system. The system was designed to record three weather parameters which are temperature, humidity and rainfall. Data recorded are stored in a database and the system provides an interface for users to view the recorded data. In the designed system data can be visualized in both graphical and tabular forms. The graphical visualization enables the user to visualize the weather parameters variation at every interval. Figure 28, 29, and 30 show graphical data visualization of the humidity, temperature, and rainfall recorded respectively.

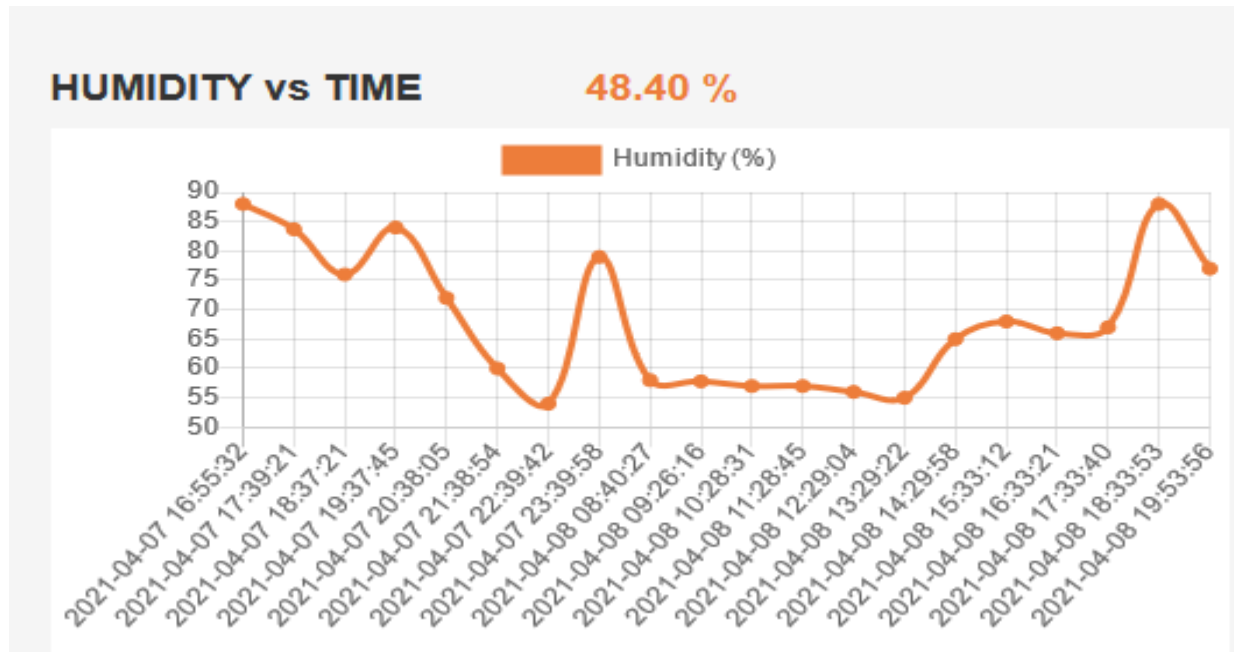

Figure 28: Graphical visualization of humidity data

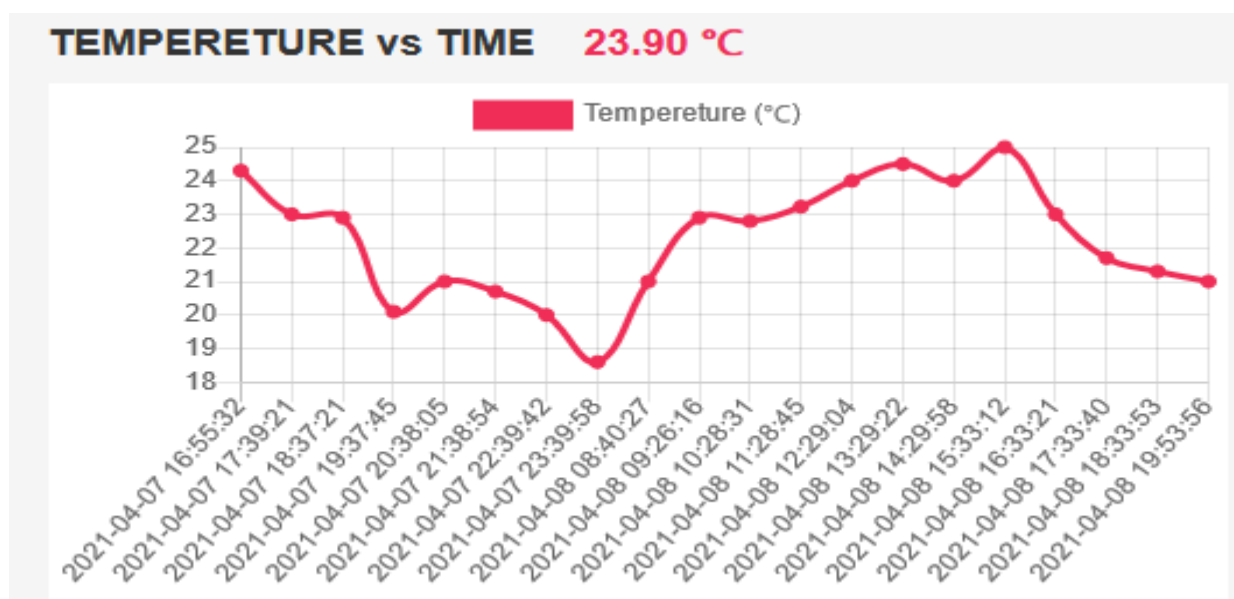

Figure 29: Graphical visualization of temperature data

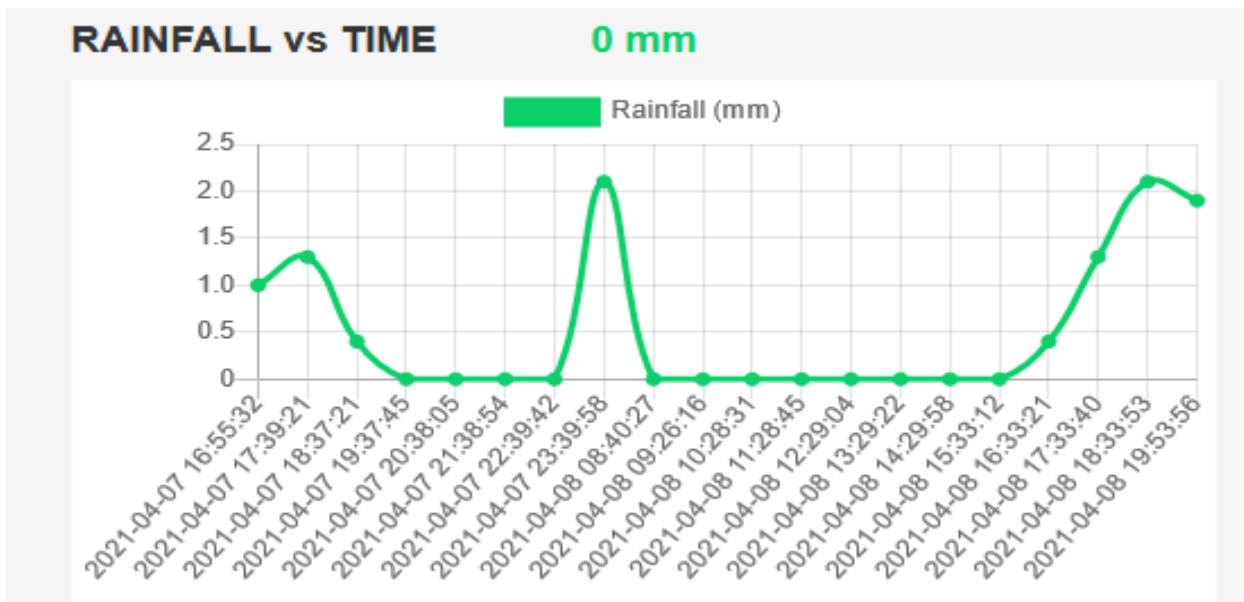

Figure 30: Graphical visualization of rainfall data

Moreover, to enable users to visualize how the recorded parameters are related to each other, the developed system provides an interface for users to view all parameters on one graph. This feature is crucial as it enables users to have a clear understanding of how the recorded parameters are related to each other. Figure 31 shows a table visualization of all recorded weather parameters combined.

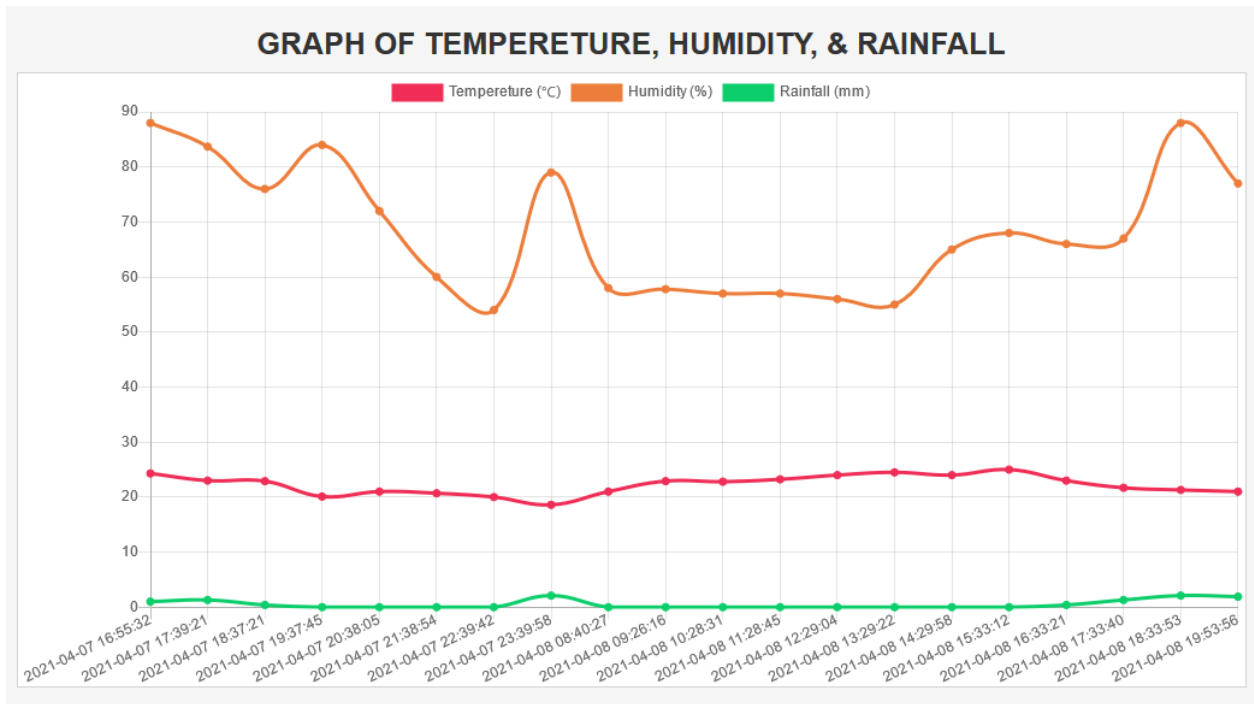

Figure 31: Graphical visualization of weather parameters in graphical form

Furthermore, the developed system enables users to visualize recorded meteorological data in tabular form as shown in Fig. 32.

Data Filter Options:

Column number	Select Order	Select Date	View Data	PDF File
50	None	2021-11-24		CSV

Node name: **Node1**

No	Date & Time	Temperature (°C)	Humidity (%)	Rainfall (mm)
1	2021-11-23 21:19:50	25.20	49.00	0
2	2021-11-23 21:20:40	24.90	54.00	0
3	2021-11-23 21:49:41	24.90	54.00	0
4	2021-11-23 22:19:42	24.90	54.00	0
5	2021-11-23 22:49:42	24.80	54.00	0
6	2021-11-23 23:19:44	24.70	55.00	0
7	2021-11-23 23:20:40	24.70	55.00	0
8	2021-11-23 23:49:41	24.60	55.00	0
9	2021-11-24 00:19:48	24.60	56.00	0
10	2021-11-24 00:49:44	24.50	56.00	0
11	2021-11-24 01:19:43	24.40	57.00	0
12	2021-11-24 01:42:39	24.40	57.00	0
13	2021-11-24 01:42:40	24.40	57.00	0
14	2021-11-24 01:43:41	24.40	58.00	0
15	2021-11-24 02:12:42	24.40	58.00	0
16	2021-11-24 02:42:42	24.30	58.00	0
17	2021-11-24 03:12:42	24.30	59.00	0
18	2021-11-24 03:42:39	24.20	59.00	0

Figure 32: Tabular visualization of the recorded meteorological data

Additionally, users can select the number of columns they want to view, the order of the data to be displayed, and the date at which they want to view the data. Lastly, users can download selected data in PDF format, and in CSV format for printing and further data analysis respectively.

Meteorological Data Settings

The system administrator has a privilege that enables him/her to set the time interval in which the meteorological station has to send data. Moreover, the system administrator can set the desired top and lowest meteorological data values, therefore when exceeding the interval it sends alerts. This feature was added to facilitate the concept of early warning. Figure 33 shows the dashboard to set alerts when meteorological parameters exceed the desired values, and the time interval setting for a meteorological station to send data.

Settings

Current Value: **1800s**

Update Time Interval

1800 { Seconds }

Update

Temperature limits

Max Value

Current Max Val: **30 °C**

30

Min Value

Current Min Val: **10 °C**

10

Update Temperature

Humidity limits

Max Value

Current Max Val: **80 %**

80

Min Value

Current Min Val: **30 %**

30

Update Humidity

Rainfall limits

Max Value

Current Max Val: **300 mm**

300

Min value

Current Min Val: **0 mm**

0

Update rainfall

Current Node Status: **Enabled**

Enable

{Enable this Node from sending data.}

Disable

{Disable this Node from sending data.}

Figure 33: Meteorological data settings dashboard

4.1.4 System Testing and Validation

After system development, unit testing was conducted to ensure that each system module is working fine. The performance of the system was subsequently carried out to determine whether the system send meteorological data correctly. Moreover, system communication range testing was done to determine how far meteorological stations can send data to the gateway via the LoRaWAN network. Finally, user acceptance testing was carried out by involving some of the station managers and other stakeholders.

(i) Meteorological Station Units

The meteorological station unit, which consists of the temperature sensor, humidity sensor, GPS, rain gauge tip bucket and LoRa node was tested to ensure meteorological data were recorded and transmitted to the LoRa gateway via LoRaWAN. Table 6 summarizes the tests performed on meteorological station units.

Table 6: Meteorological station units testing results

System Requirements	Results
The system sensors should record meteorological parameters which are rainfall, humidity, and temperature.	PASS
The system node should transmit the recorded meteorological data to the connected LoRa gateway.	PASS
The system should send meteorological parameters to the server after every predefined time interval.	PASS
The system gateway should send received meteorological data to the server.	PASS
Meteorological stations should be able to communicate with the gateway in a long distance of at least 15 kilometres in suburban areas.	PASS

(ii) LoRaWAN Transmission Testing

Among the benefits of the LoRaWAN network is the ability to send data in a long distance, this serves a purpose for the meteorological stations being able to send data to the gateway even if they are located in a remote area without an Internet connection. As the theory suggests, LoRaWAN can cover the distance of 5 km in urban areas and 15 km in suburban areas (Dambal *et al.*, 2017). The system was tested to ensure if the meteorological stations could communicate with a gateway in 15 km and beyond. To ensure there is a line of sight between the meteorological station (Node) and LoRa gateway BotRf simulation software was used to simulate the communication path before the devices were taken to the field. In this study two tests were conducted, one in the urban area, and another in suburban areas as explained in subsections below:

Urban Area Communication LoRaWAN Transmission Testing

This test was conducted in a congested area with many houses. The aim was to attain an urban environment where the radio signal is reflected, refracted, absorbed, and polarized when hitting different obstacles. The testing aimed to ensure the gateway and the nodes could communicate at a distance of more than five kilometres in urban areas as stated in the theory. The LoRa gateway was placed in a point located at the latitude -3.341772 and longitude 36.808865 as shown in Fig. 34. The LoRa nodes were plugged on a car moving at an average speed of 78 km/h. The gateway was able to receive 45.83% of the transmitted data from the node while attaining a maximum range of 8.3 km, and therefore, exceeded the expected 5 km distance.

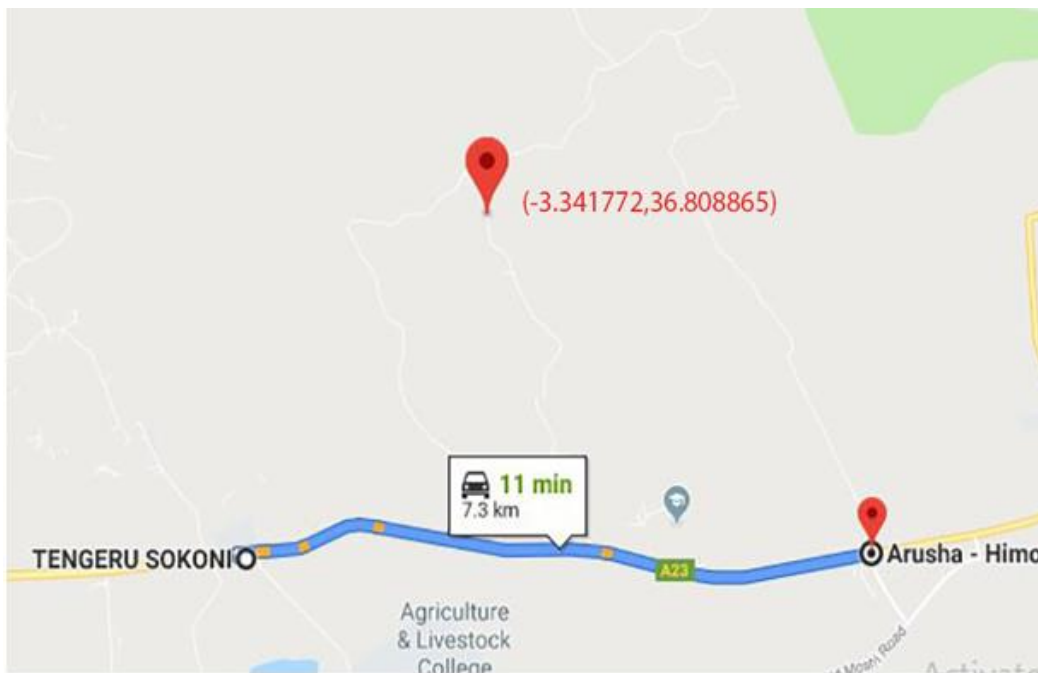

Figure 34: Urban area communication range testing

Table 7: The communication range testing between the LoRa gateway and meteorological stations (Nodes) in urban areas

System Requirements	Results
The meteorological stations should be able to communicate with the LoRa gateway via LoRaWAN in a range of 5 km	PASS

Sub-urban Area Communication LoRaWAN Transmission Testing

In this section two tests were conducted, both aim in getting the range at which LoRa nodes can communicate with the LoRa gateway via LoRaWAN. Before the testing, simulation was done using BotRf simulation software and the area had Fresnel zone is above 60%.

In the first test, the LoRaWAN gateway was placed stationary at Nambala primary school and the meteorological station was plugged on a moving vehicle at the average speed of 83 km/h heading to Mbuguni. The test aimed to determine how far the gateway can keep on receiving the meteorological data sent by the nodes. From the test, the gateway was able to receive meteorological data from the nodes up to a distance of 19.35 km. Figure 35 shows communication range between gateway and node.

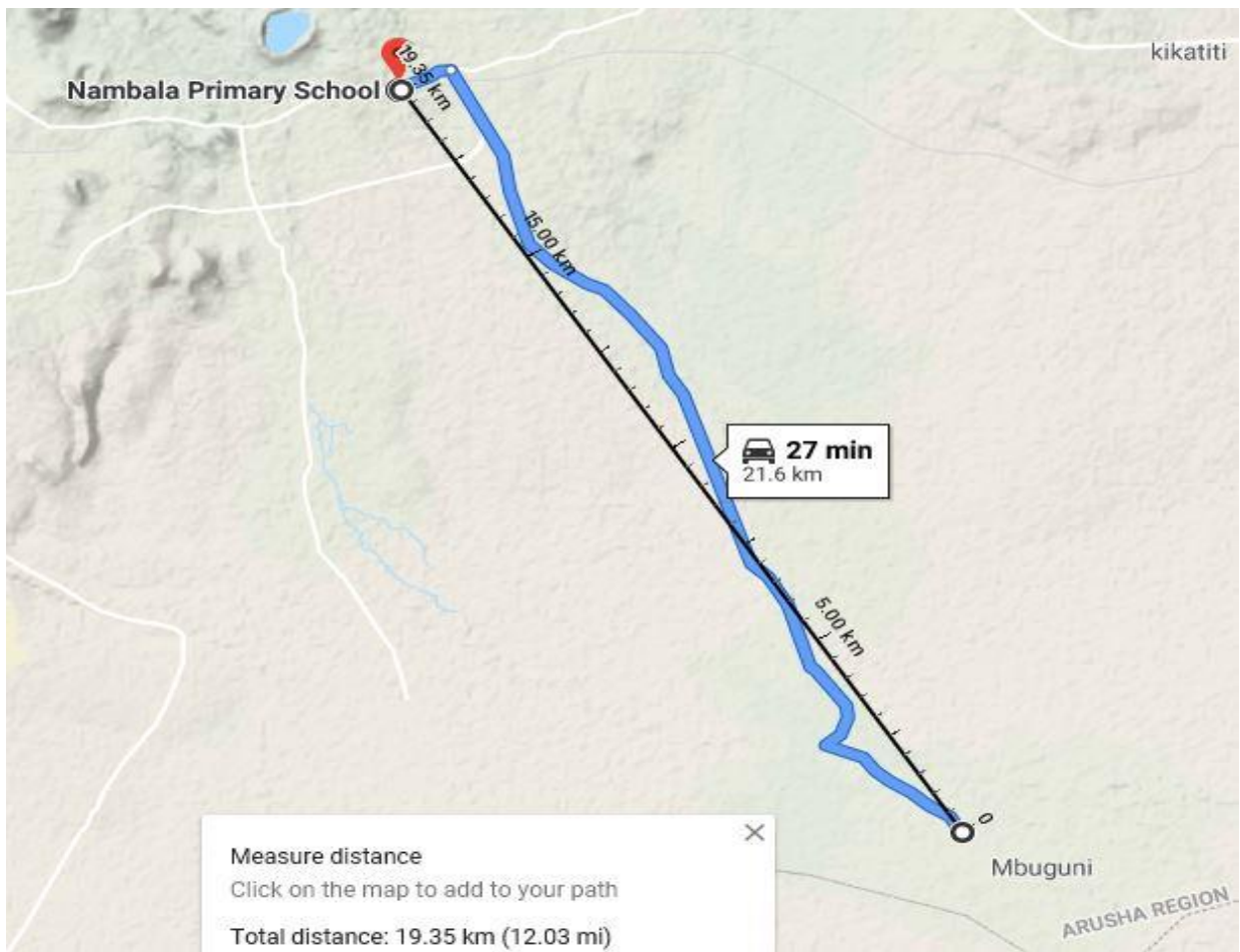

Figure 35: LoRaWAN communication range in sub-urban area

Table 8: The communication range testing between the LoRa gateway and meteorological stations (Nodes) in suburban areas

System Requirements	Results
The meteorological stations should be able to communicate with the LoRa gateway via LoRaWAN in a range of 15 km in suburban areas	PASS

Another communication range test was done by selecting a point with a good line of sight between a node and a gateway. This test aimed to determine whether a meteorological station (node) could communicate with the gateway above 20 km distance via LoRaWAN. The two point to place a node and a gateway were selected and BotRf simulation software was used to ensure there was a clear line of sight between the two devices. Figure 36 shows the line of sight simulation results.

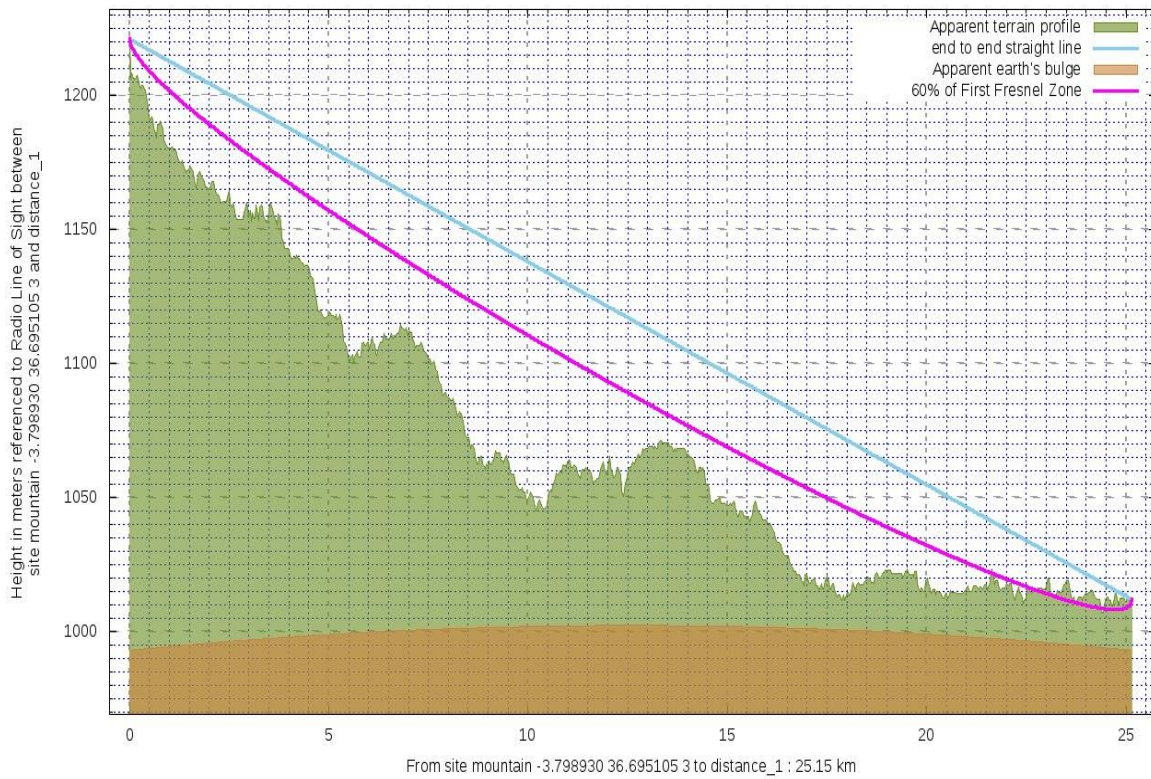

Figure 36: BotRf simulation of a line of sight results between the node and the gateway

The distance between the two points was 25.15 km, and from the simulation results there was a clear line of sight between the two points and the Fresnel zone was above 60%. The testing was conducted and the gateway was able to receive meteorological data from a node at this distance.

After successful meteorological data transmission at 25.15 km, another test was done to see whether the node and the gateway can communicate at a longer distance of near 50 km. Just like the previous test, the two points were selected and BotRf simulation software was used to ensure there was a clear line of sight between the two devices. Figure 37 shows the line of sight simulation results.

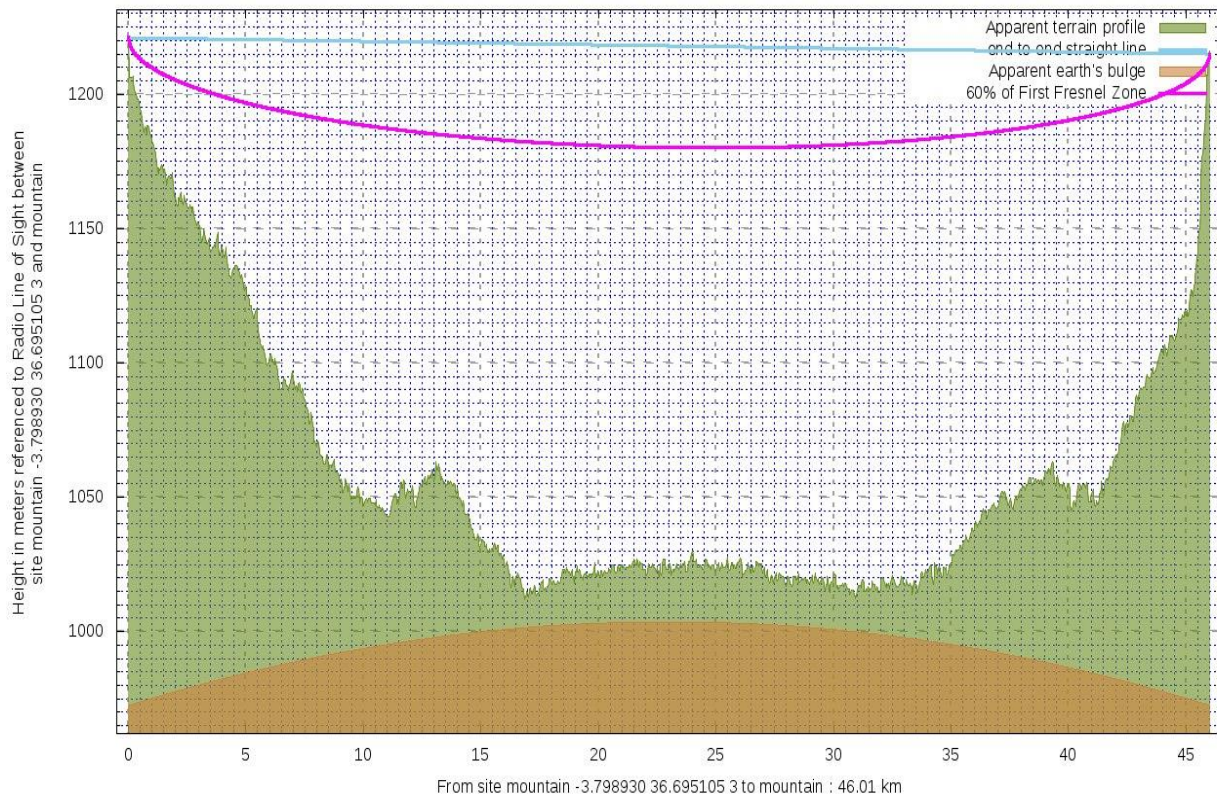

Figure 37: BotRf simulation of a line of sight results between the node and the gateway

The selected points were 46.01 km apart and the meteorological station (node) and the gateway were placed on the selected points. The test was conducted but the gateway couldn't receive meteorological data from the node at this distance.

Table 9: Long range communication testing between the LoRaWAN gateway and the meteorological stations (nodes)

System Requirements	Results
The meteorological stations should transmit data to the gateway over a long distance of up to 25.15 km	PASS
The meteorological stations should transmit data to the gateway over a long distance of up to 46.01 km	FAIL

(iii) Developed Web Portal Testing

Finally, the developed web portal testing was conducted. This testing was divided into four stages as explained below:

User Authentication Unit

The intention of this test was to check whether the registered system users can log in and log out of the developed web portal by using their credentials. Table 10 shows the testing results.

Table 10: User authentication testing

System Requirements	Results
Only the registered users should be able to log in and log out in the developed system, using their username and password	PASS
The system has a password recovery option for users who forgot their password	PASS

User Management

The intention of this test was to ensure the system admin has the privilege of managing system users are stated in Table 11.

Table 11: User management unit test

System Requirements	Results
The system administrator should be able to register new users	PASS
The system admin should be able to edit user details and delete user account when needed	PASS

Meteorological Stations Information

This test aimed to determine whether the developed system could store and display information of each meteorological station. Table 12 shows the details of the testing.

Table 12: Meteorological stations unit test

System Requirements	Results
The system should be able to list all the available stations and their details, including their location	PASS
The system should be able to display meteorological data of each station, without interfering with data from another station	PASS

Meteorological Data Visualization Unit

In this test, the aim was to check whether the recorded meteorological information can be viewed by the user as stated in the Table 15.

Table 13: Meteorological data visualization unit test

System Requirements	Results
The system user can view rainfall data in graphical form	PASS
The system user can view temperature data in graphical format	PASS
The system user can view humidity data in graphical format	PASS
The system user can display all recorded meteorological parameters on one graph, and see how those parameters are related	PASS
The system user can view the temperature, humidity and rainfall data in tabular form	PASS
The system user can download the recorded meteorological data in PDF format for printing and other uses	PASS
The system user can download the recorded meteorological data in CSV format for further data analysis and other uses	PASS

3.13 Discussion

This study was guided by two related research questions, and each question focused on addressing a specific stage of the research work. The findings for each research question are discussed below:

4.2.1 What are the system requirements for developing an integrated sensor network for agro-meteorological data collection?

The system requirements for this study were collected from the meteorological station managers and other secondary sources like related research work and reports. The findings from data collection highlighted among the critical features of the system, it must have the ability to display recorded meteorological data in near real-time. This will cover the delay of meteorological data to reach the respective organs for analysis and early warning implementation. Again, the developed system should enable users to download meteorological data in CSV file format to enable researchers to do further data analysis. Finally, the developed system should be affordable, reliable, and can easily be maintained.

4.2.2 How will the proposed system be developed to meet end-users expectations?

The developed system design was centered towards achieving system functional and non-functional requirements as gathered during the data collection. The web portal was designed to provide all the necessary information to the users. The system enables users to view meteorological data in graphical and tabular form in near real time as discussed in the system requirements. Moreover, the developed system enables users to download recorded meteorological data in CSV file format for further data analysis.

The developed system was designed to use a private network without any limitation from other online platforms such as The Things Network (TTN), ThingPark, ThingSpeak, and Loriot and hence make the system reliable, affordable and easy to maintain.

CHAPTER FIVE

CONCLUSION AND RECOMMENDATIONS

5.1 Conclusion

This study aimed to use the Internet of things to develop an integrated sensor network for agro-meteorological data collection in Tanzania. The study focused on the existing meteorological stations due to their significance in providing meteorological information for various uses especially in the agriculture sector. Among the challenges facing the existing manual meteorological stations is the delay in conveying meteorological data to the respective organs such as the TMA, MOA and Pangani basin, and therefore, monitoring of crop development and providing early warning to the farmers and the government becomes hard. Furthermore, the digitalization of the recorded meteorological data is a huge drawback of the existing manual meteorological stations.

Moreover, the available commercial meteorological stations are expensive and hard to repair whenever they malfunction, this has been witnessed during data collection as two automatic meteorological stations malfunctioned and their repair was stalled as they have to invite the equipment manufacturer for the repair. By analysing the existing challenges, this study came up with an integrated sensor network for agro-meteorological data collection. The developed system uses the LoRaWAN network to send meteorological data from the stations to the LoRa gateway. This feature enables the stations to be placed in remote areas with limited Internet access.

Therefore, apart from the existing systems, the developed system was designed to use Lora technology with a private network without any limitation from other online platforms such as The Things Network (TTN), ThingPark, ThingSpeak, and Lorient and hence provide full control of the data and system customization and modifications can easily be done. Apart from that, to ensure crop monitoring and early warning, the system sends alerts to responsible people whenever measured meteorological parameters exceed predefined values. Lastly, the system was developed using Mysqli (Extension) with parameters bind, this makes the system secured as it prevents all the Mysql injections.

5.2 Recommendations

From the data collection, site visit, and system development, this study recommends the following:

- (i) Station managers should be given incentives: From data collection found most of the station managers are volunteers and it has been hard for them to fulfil their responsibilities, including recording the meteorological data, and cleaning and maintaining the meteorological station. Therefore, for effective management of the existing meteorological station managers should be given incentives.
- (ii) Stations inspection and maintenance schedule should be set: The interview with station managers revealed that most of the stations had neither been inspected nor maintained since their establishment. This is a challenge as it may reduce the accuracy of the recorded meteorological data. Therefore, this study recommends the responsible organs that are TMA, MOA, and Pangani basin to schedule a timely station inspection and maintenance.
- (iii) The developed system should be used for meteorological data collection: The adoption of the developed system will solve most of the challenges facing the existing meteorological stations. The developed system was designed based on the requirements gathered during the data collection and it is specific for solving challenges in the existing system. Moreover, the developed system has room for expansion and adding more sensors to record more meteorological parameters like atmospheric pressure, wind speed, and wind direction.
- (iv) In future study a mobile application should be developed: Even though the developed web application is mobile user friendly, and alerts can be received through a mobile phone (by SMS or email), but there is an essence of developing a mobile application in the future study to quick data access.

REFERENCES

- Abd Rahman, N. H., Yamada, Y., Husni, M. H., & Aziz, N. A. (2018). Feasibility of LoRa implementation for remote weather monitoring system through field measurement and case study analysis. *International Journal of Integrated Engineering*, 10(7), 294–303.
- Advaith, A. P., Regi, H., Sruthi, A. M., Abhijith, V., Rajeev, S. P., & SD, B. S. (2022). TRAC 1-A Arduino based Trouble Detection and Caution System for Well Cleaners. In 2022 6th International Conference on Trends in Electronics and Informatics. <https://scholar.google.com>
- Alam, R., & Arslan, M. (2019). *A Survey on Wired and Wireless Network*. <https://scholar.google.com>
- Ah Kioon, M. C., Wang, Z. S., & Deb-Das, S. (2013). *Security Analysis of MD5 Algorithm in Password Storage*. <https://scholar.google.com>
- Pötsch, A., & Haslhofer, F. (2017). *Practical Limitations for Deployment of Lora Gateways*. In 2017 IEEE International Workshop on Measurement And Networking. <https://scholar.google.com>
- Boano, C. A., Cattani, M., & Römer, K. (2018). *Impact of Temperature Variations on the Reliability of Lora*. <https://scholar.google.com>
- Butun, I., Pereira, N., & Gidlund, M. (2018). Security risk analysis of LoRaWAN and future directions. *Future Internet*, 11(1), 1-22.
- Byanyuma, M., Kalolo, S., Mrutu, S. I., Nyakyi, C., & Sam, A. (2013). *Affordable Broadband Connectivity for Rural Areas*. In 2013 Pan African International Conference on Information Science, Computing and Telecommunications. <https://scholar.google.com>
- Carstensen, A. K., & Bernhard, J. (2019). Design science research: A powerful tool for improving methods in engineering education research. *European Journal of Engineering Education*, 44(1-2), 85-102.
- Cattaneo, G., De Maio, G., & Petrillo, U. F. (2013). Security Issues and Attacks on the GSM Standard: A Review. *Journal of Universal Computer Science*, 19(16), 2437-2452.
- Cattani, M., Boano, C. A., & Römer, K. (2017). An experimental evaluation of the reliability of lora long-range low-power wireless communication. *Journal of Sensor and Actuator Networks*, 6(2), 1-19.

- Chaudhary, K. B., Kaushik, K., & Kirat, P. (2011). *Computer Networks and Information Technologies*. <http://www.scopus.com>
- Clavier, L., Noreen, U., & Bounceur, A. (2017). *A Study of LoRa Low power and Wide Area Network Technology*. In *2017 International Conference on Advanced Technologies for Signal and Image Processing*. <http://www.scopus.com>
- ChirpStack Gateway OS. (2020). *ChirpStack Gateway OS Documentation*. <https://www.chirpstack.io/gateway-os/overview/>
- Dambal, V. A., Mohadikar, S., Kumbhar, A., & Guvenc, I. (2019). *Improving LoRa Signal Coverage in Urban and Sub-Urban Environments with UAVs*. In *2019 International Workshop on Antenna Technology*. <http://www.scopus.com>
- Davcev, D., Mitreski, K., Trajkovic, S., Nikolovski, V., & Koteli, N. (2018). *IoT Agriculture System based on LoRaWAN*. In *2018 14th IEEE International Workshop on Factory Communication Systems*. <https://scholar.google.com>
- Dawson, M., Burrell, D. N., Rahim, E., & Brewster, S. (2010). Integrating software assurance into the software development life cycle. *Journal of Information Systems Technology and Planning*, 3(6), 49-53.
- Demirel, S. T., & Das, R. (2018, March). *Software Requirement Analysis: Research Challenges and Technical Approaches*. In *2018 6th International Symposium on Digital Forensic and Security*. <https://scholar.google.com>
- Dhillon, P., & Sadawarti, H. (2014). A review paper on zigbee (ieee 802.15. 4) standard. *International Journal of Engineering Research and Technology*, 3(4), 141-145.
- Deva, S. V. S. V. P., & Akashe, S. (2017). Implementation of GSM Based Security System with IOT Applications. *International Journal of Computer Network and Information Security*, 9(6), 13-20.
- El Fehri, C., Kassab, M., Abdellatif, S., Berthou, P., & Belghith, A. (2018). LoRa technology MAC layer operations and Research issues. *Procedia Computer Science*, 130, 1096-1101.
- Gomez, C., Veras, J. C., Vidal, R., Casals, L., & Paradells, J. (2019). A sigfox energy consumption model. *Sensors*, 19(3), 681.
- Haxhibeqiri, J., De Poorter, E., Moerman, I., & Hoebeke, J. (2018). A survey of LoRaWAN for

- IoT: From technology to application. *Sensors*, 18(11), 3995.
- Hoff, S., Meyer, M., & Sachs, J. (1998). *Analysis of the General Packet Radio Service of GSM as Access to the Internet. In IEEE 1998 International Conference on Universal Personal Communications. Conference Proceedings* <https://scholar.google.com>
- “Home - Zigbee Alliance. (2020). *Zigbee Alliance*. <https://zigbeealliance.org>
- “Home-ThingPark LoRaWAN Developer Portal. (2019). *ThingPark LoRaWAN* <https://partners.thingpark.com/en>
- Hunziker, S., Gubler, S., Calle, J., Moreno, I., Andrade, M., Velarde, F., Ticona, L., Carrasco, G., Castellón, Y., Oria, C., & Croci- Maspoli, M. (2017). Identifying, attributing, and overcoming common data quality issues of manned station observations. *International Journal of Climatology*, 37(11), 4131-4145.
- Iwai, H., & Ohmi, S. I. (2002). Silicon integrated circuit technology from past to future. *Microelectronics Reliability*, 42(4-5), 465-491.
- Joshi, A. P., & Nagar, V. V. (2015). A Case Study: Performance Evolution Using JavaScript Object Notation Technology. *Computer Science*, 2277, 4–5.
- Jovalekic, N., Pietrosevoli, E., Rainone, M., & Zennaro, M. (2017). *Smart and very distant objects. In Proceedings of the 3rd Workshop on Experiences with the Design and Implementation of Smart Objects*. <https://scholar.google.com>
- Jung, Y. M. (2019). *Data Analysis in Quantitative Research*. <https://scholar.google.com>
- Kondela, E., Nungu, A., & Pehrson, B. (2015). *Status of Existing Weather Observation Station Network in Tanzania and the Possibility to Automate and Densify it*. <https://scholar.google.com>
- Küng, L., Kröll, A. M., Ripken, B., & Walker, M. (1999). Impact of the digital revolution on the media and communications industries. *Javnost-the Public*, 6(3), 29-47.
- Lavric, A. (2019). LoRa (long-range) high-density sensors for internet of things. *Journal of Sensors*, 2019, 1-10
- Lavric, A., Petrariu, A. I., & Popa, V. (2019). Long range sigfox communication protocol scalability analysis under large-scale, high-density conditions. *Access*, 7, 35816-35825.

- Lavric, A., & Petrariu, A. I. (2018, May). *LoRaWAN Communication Protocol: The New Era of IoT*. In *2018 International Conference on Development and Application Systems*. <https://scholar.google.com>
- Lee, J. Y., & Lee, J. (2021). Current research trends in IoT security: A systematic mapping study. *Mobile Information Systems*, 2021, 1-25.
- Lester, J. N., Cho, Y., & Lochmiller, C. R. (2020). Learning to do qualitative data analysis: A starting point. *Human Resource Development Review*, 19(1), 94-106.
- Li, S., Raza, U., & Khan, A. (2018). *How Agile is the Adaptive Data Rate Mechanism of LoRaWAN?*. In *2018 IEEE Global Communications Conference*. <https://scholar.google.com>
- Lin, Y. B., Rao, H. C. H., & Chlamtac, I. (2001). General Packet Radio Service: Architecture, Interfaces, and Deployment. *Wireless Communications and Mobile Computing*, 1(1), 77-92.
- Lora Alliance. (2017). *LoRaWAN 1.1 Regional Parameters*. <https://scholar.google.com>
- LoRa Server. (2019). *LoRa Server Server Documentation*. <https://www.loraserver.io/loraserver/overview/>
- LORIoT. (2019). Long Range Internet of Things Technology. <https://www.loriot.io/technology.html>.
- Luković, I., Ristić, S., & Mogin, P. (2003). *A Methodology of A Database Schema Design Using the Subschemas*. In *Proceedings of IEEE International Conference on Computational Cybernetics, Siofok, Hungary, CD ROM*. <https://scholar.google.com>
- Mangalvedhe, N., Ratasuk, R., & Ghosh, A. (2016). *NB-IoT Deployment Study for Low Power Wide Area Cellular IoT*. In *2016 IEEE 27th Annual International Symposium on Personal, Indoor, and Mobile Radio Communications*. <https://scholar.google.com>
- Mekki, K., Bajic, E., Chaxel, F., & Meyer, F. (2019). A comparative study of LPWAN technologies for large-scale IoT deployment. *Express*, 5(1), 1-7.
- Murdyantoro, E., Setiawan, R., Rosyadi, I., Nugraha, A. W., Susilawati, H., & Ramadhani, Y. (2019). *Prototype Weather Station uses LoRa Wireless Connectivity Infrastructure*. <https://scholar.google.com>
- Noreen, U., Bounceur, A., & Clavier, L. (2017). *A study of LoRa Low Power and Wide Area Network Technology*. In *2017 International Conference on Advanced Technologies for Signal*

and Image Processing. <https://scholar.google.com>

Ojeniyi, A., Taye, A., & Ang, M. T. (2019). Design of an Agent-Based Traffic Control System. *International Journal of Engineering and Advanced Technology*, 8(6S3), 71-76.

Park, S. K., Hwang, K. I., Kim, H. S., & Shim, B. S. (2017). *Challenges and experiment with Lorawan*. In *Advanced Multimedia and Ubiquitous Engineering*. <https://scholar.google.com>

Polonelli, T., Brunelli, D., Marzocchi, A., & Benini, L. (2019). Slotted aloha on Lorawan-Design, Analysis, and Deployment. *Sensors*, 19(4), 838.

Prokofyeva, N., & Boltunova, V. (2017). Analysis and practical application of PHP frameworks in development of web information systems. *Procedia Computer Science*, 104, 51-56.

Rahnema, M. (1993). Overview of the GSM system and protocol architecture. *Communications Magazine*, 31(4), 92-100.

Ratasuk, R., Vejlgard, B., Mangalvedhe, N., & Ghosh, A. (2016). *NB-Iot System for M2M Communication*. In *2016 IEEE Wireless Communications and Networking Conference*. <https://scholar.google.com/>

Sethi, P., & Sarangi, S. R. (2017). Internet of things: Architectures, protocols, and applications. *Journal of Electrical and Computer Engineering*, 2017, 1-26.

SigFox. (2020). The Global Communications Service Provider for the Internet of Things (IoT).” <https://www.sigfox.com/en>.

Sinha, R. S., & Wei, Y. H. (2017). Seung Hoon. “A survey on LPWA technology: LoRa and NB-IoT”. *ScienceDirect ICT Express*, 3, 14-21.

Shylesh, S. (2017). *A Study of Software Development Life Cycle Process Models*. In *National Conference on Reinventing Opportunities in Management, IT, and Social Sciences*. <https://scholar.google.com>

Taghandiki, K., Zaeri, A., & Shirani, A. (2016). A Supervised Approach for Automatic Web Documents Topic Extraction Using Well-Known Web Design Features. *International Journal of Modern Education & Computer Science*, 8(11), 20-27.

URT. (2020). *Tanzania Meteorological Agency*. <http://maproom.meteo.go.tz/maproom>

Toreti, A., Maiorano, A., De Sanctis, G., Webber, H., Ruane, A. C., Fumagalli, D., Ceglar, A.,

- Niemeyer, S., & Zampieri, M., 2019. Using reanalysis in crop monitoring and forecasting systems. *Agricultural Systems*, 168, 144-153.
- Torres, F., Soriano, J., & Riva, G. (2018). *First Steps in the Development of A Lorawan Testbench. In 2018 Ninth Argentine Symposium and Conference on Embedded Systems.* <https://scholar.google.com>
- Van Ginkel, M., & Biradar, C. (2021). Drought early warning in agri-food systems. *Climate*, 9(9), 134.
- Weerasinghe, R., Aroos, M. S. M., Pannila, A. S., Jayananda, M. K., & Sonnadara, D. U. J. (2011). Construction of an automated weather station for ground level weather measurements. *Annual Transactions*, 2011, 450-455.
- Wood, L. E. (1946). Automatic weather stations. *Journal of Atmospheric Sciences*, 3(4), 115-121.
- Workgroup, Technical Marketing. (2015). *A Technical Overview of LoRa ® and LoRaWAN ™ What is It?*. <https://lora-alliance.org/resource-hub/what-lorawantm>.
- Wu, M. (2017). *Wireless Communication Applications in Internet of Things.* <https://scholar.google.com>
- Zennaro, M., Rainone, M., & Pietrosevoli, E. (2016). *Radio Link Planning Made Easy with a Telegram Bot. In International Conference on Smart Objects and Technologies for Social Good (pp. 295-304).* Springer, Cham. <https://scholar.google.com>
- Zhou, Q., Zheng, K., Hou, L., Xing, J., & Xu, R. (2019). Design and implementation of open LoRa for IoT. *Access*, 7, 100649-100657.
- Zinas, N., Kontogiannis, S., Kokkonis, G., Valsamidis, S., & Kazanidis, I. (2017). *Proposed Open Source Architecture for Long Range Monitoring. The Case Study of Cattle Tracking at Pogoniani. In Proceedings of the 21st Pan-Hellenic Conference on Informatics.* <https://scholar.google.com>

APPENDICES

Appendix 1: Questionnaire for Data Collection

Section A: General respondent information.

1. What is your gender?
 - a) Male
 - b) Female
2. What is our age?
 - a) 18-25 years
 - b) 26-35 years
 - c) 36-45 years
 - d) 46-55 years
 - e) Above 56 years
3. What is your education level?
 - a) No formal education
 - b) Primary
 - c) Secondary
 - d) Certificate
 - e) Diploma
 - f) Bachelor degree
 - g) Postgraduate degree
4. Telephone number

Section B: Information about the existing meteorological stations.

1. The ward station is located?
2. The year the station was established?
3. Who is the station owner?
4. Station status
 - a) Working
 - b) Not working
5. Station type
 - a) Automatic
 - b) Manual
 - c) Both automatic and manual
6. What meteorological parameters are measured in the station?
7. What is the malfunctioned equipment in the station?

8. Who is the station manufacturer?
9. What kind of employee records meteorological data?
 - a) Employee
 - b) Volunteer
10. What is meteorological data recording interval?
11. Where are the recorded data sent?
12. Which media is used for the recorded data to reach the respective organization?
13. What time interval is taken for the recorded meteorological data to be sent to the respective organization?
14. Who does the station inspection?
15. After what time interval is an inspection done?
16. Who does the station maintenance?
17. After what time interval is maintenance done?
18. Who does the station maintenance?
19. Station remarks
20. Station location in Latitude and longitude

Appendix 2: Sample Arduino Codes for Meteorological station

```
/*  
  
Weather Station Node  
  
iotdynamics.xyz  
  
Developed by Gaudence Mathew  
  
*/  
  
#include<SPI.h>//include spi library  
  
#include<WiFi101.h>//include wifi library  
  
#include<RTCZero.h>//include rtc library  
  
#include<ArduinoJson.h>//include json library  
  
  
#include<Adafruit_Sensor.h>//include adafruit library  
  
#include<DHT.h>//include dgt library  
  
#include<DHT_U.h>//include dgt library  
  
#define DHTPIN 5// Digital pin connected to the DHT sensor  
  
#define DHTTYPE DHT11// DHT 11  
  
DHT_Unified dht(DHTPIN, DHTTYPE);  
  
char ssid[] = "TECNO-Y2"; // your network SSID (name)  
char pass[] = "0b73d4748d01g"; // your network password  
int keyIndex = 0; // your network key Index number (needed only for WEP)  
  
int status = WL_IDLE_STATUS;  
  
  
// Initialize the WiFi client library  
  
WiFiClient client;  
  
  
// server address:  
  
char server[] = "www.iotdynamics.xyz";  
  
bool sendRequest=true; //
```

```

/* Create an rtc object */

RTCZero rtc;

/*Initial setup variables for time*/

//timming variables

unsigned long long fire = 0; //variable for holding time to fire a request

unsigned long long current_time = 0; //variable to hold current time

unsigned long long data_interval = 10; //interval for sending data here

//Node Key

String Node_KEY = "W9HGYJk"; // Node Key is a unique 7 Digits Node identifier

//data

String data = "";

float temp;

float hum;

float rain;

void setup() {

  //Initialize Serial and wait for port to open:

  Serial.begin(115200);

  //DHT sensor

  dht.begin();

  sensor_t sensor;

  connectToAP(); // connect to Wi-Fi access point

  printWifiStatus();

```

```
rtc.begin(); //initializing RTC in 24H format
```

```
rtc.setTime(hours, minutes, seconds); //setting RTC initial time here
```

```
//setting time
```

```
fire = (hours*3600)+(minutes*60)+seconds; //our interval here
```

```
rtc.setDate(day, month, year); //setting date and time
```

```
}
```

```
void loop() {
```

```
  //listen for incoming data
```

```
  // from the server, read them and print them:
```

```
  if (client.available()) {
```

```
    data = client.readString();
```

```
  }
```

```
  //check time interval here getHours(),getMinutes(), getSeconds()
```

```
  current_time = (rtc.getHours() * 3600)+ (rtc.getMinutes()*60)+ rtc.getSeconds();
```

```
  //check for interval
```

```
  if (((current_time - fire))> data_interval){
```

```
    fire = current_time;
```

```
    //zero current time
```

```
    current_time = 0;
```

```
    //send data here
```

```
    sensors_event_t event;
```

```
    dht.temperature().getEvent(&event);
```

```
    if (isnan(event.temperature)) {
```

```
      //Serial.println(F("Error reading temperature!"));
```

```
    }
```

```
else {  
    //Serial.print(F("Temperature: "));  
    temp = event.temperature;  
    //Serial.println(F("°C"));  
}  
  
// Get humidity event and print its value.  
dht.humidity().getEvent(&event);  
if (isnan(event.relative_humidity)) {  
    Serial.println(F("Error reading humidity!"));  
}  
else {  
    //Serial.print(F("Humidity: "));  
    hum = event.relative_humidity;  
    //Serial.println(F("%"));  
}  
  
//send request here  
httpRequest();  
}  
  
}
```

Appendix 3: Sample PHP Codes for User Login in Web Application

```
<?php
session_start();
require('../config/config.php');

if(isset($_POST['user_login']))
{
    $user_email = $_POST['email'];
    $pass = $_POST['password'];
    $encry_pass = md5($pass);

    $sql = 'SELECT * FROM `users` WHERE email = ? AND `password` = ? ';
    $query = $link->prepare($sql);
    $query->bind_param("ss", $user_email, $encry_pass );
    /* execute query */
    $query->execute();
    $result = $query->get_result();
    if($result->num_rows > 0)
    {
        $_SESSION['email'] = $user_email;
        echo 1;
    }else
    {
        echo 'You have entered invalid username or password';
    }
}

?>
```

RESEARCH OUTPUTS

(i) **Publication**

Gaudence, L. M., & Mussa, A. D. (2022). Agro-Meteorological data Collection using a LoRaWAN-Based IoT Sensor Network. *International Journal of Advances in Scientific Research and Engineering*, 8(2), 110-118.

(ii) **Poster Presentation**