

2022-07

Smart tanks juice level monitoring system: a case study of Raha beverages company limited Arusha, Tanzania

Iradukunda, Yvonne

NM-AIST

<https://dspace.nm-aist.ac.tz/handle/20.500.12479/1613>

Provided with love from The Nelson Mandela African Institution of Science and Technology

**SMART TANKS JUICE LEVEL MONITORING SYSTEM: A CASE
STUDY OF RAHA BEVERAGES COMPANY LIMITED ARUSHA,
TANZANIA**

Yvonne Iradukunda

**A Project Report in Partial Fulfilment of the Requirements for the Degree of Master's
in Embedded and Mobile Systems of the Nelson Mandela African Institution of Science
and Technology**

Arusha, Tanzania

July, 2022

ABSTRACT

Tanzania is among the East African Countries with rapid economic development, and it is a low middle-income country. The development of industries is among the factors that contribute to the economic growth of the country. Tanzania has been developing beverages industries; however, these industries are facing a number of challenges including poor monitoring of tanks during liquid pumping from boiler tank to dilution process. This problem resulted in spilling fluids, tampered wine tests, and industrial accidents. The purpose of this project was to develop a system that can be able to monitor juice level within the tanks and regulate the pump using voice commands through Alexa echo dot. The pump in this system was controlled by voice commands, and an ultrasonic sensor was used to sense the juice level in the tank and send data to a microcontroller, which processed the data and displayed the juice level on a Liquid Crystal Display (LCD). Once the juice level reached a threshold level, the pump was automatically turned off. The developed system successfully stopped overflows, accidents, and changes in juice flavor during the dilution process, according to major findings from testing and validation of the developed system. Existing way, however, are manual methodology, on the other hand, are not interactive and are costly. The developed system also caters to the physically impaired person, allowing them to engage in tank monitoring without difficulties. The system was created for Raha Beverage Company Limited located in Arusha, Tanzania.

DECLARATION

I, Yvonne Iradukunda, do hereby declare to the Senate of Nelson Mandela African Institution of Science and Technology that this project report is my original work and that it has neither been submitted nor being concurrently submitted for degree award in any other institution.

Yvonne Iradukunda		19.07.2022
Name of Candidate	Signature	Date

The above declaration is confirmed by:

Dr. Silas Mirau		3.8.2022
Name of Supervisor 1	Signature	Date

Dr. Elizabeth Mkoba		03.08.2022
Name of Supervisor 2	Signature	Date

COPYRIGHT

This project report is a copyright material protected under the Berne Convention, the copyright Act of 1999 and other International and National enactments, in that behalf, an intellectual property. It should not be reproduced by any means, in full or in part, except for short extracts in fair dealing, for research or private study, critical scholarly review or discourse with an acknowledgement and without a written permission of the Deputy Vice Chancellor for Academic, Research and Innovation, on behalf of both the author and the Nelson Mandela African Institution of Science and Technology.

CERTIFICATION

The undersigned certify that they have read and hereby recommend for acceptance by The Nelson Mandela African Institution of Science and Technology, a project report titled, “*Smart Tanks Juice Level Monitoring System: A Case Study of Raha Beverages Company Limited Arusha, Tanzania*”, in partial fulfillment of the requirements for the degree of Master of science in Embedded and Mobile Systems of the Nelson Mandela African Institution of Science and Technology.

Dr. Silas Steven Mirau		03.08.2022
Name of Supervisor 1	Signature	Date

Dr. Elizabeth Mkoba		03.08.2022
Name of Supervisor 2	Signature	Date

ACKNOWLEDGEMENTS

I am extremely grateful to Lord Almighty who strengthen me, guided me, and kept me safe and healthy in this journey of master's studies and final project work to successfully accomplish them. God's love and blessings were upon me during this journey, glory be to God. I'd like to express my deepest thanks to the Centre of Excellence for Information and Communications Technology (ICT) in East Africa (CENIT@EA) for funding my entire Master's program including project works. I also thank The Nelson Mandela African Institution of Science and Technology (NM-AIST) for lecturing and hosting me, their contribution made me successfully accomplish my studies.

Furthermore, I would like to extend my deepest gratitude to my supervisors Dr. Silas Mirau and Dr. Elizabeth Mkoba. Their commitment, support, encouragements and consistence advices through entire final project and I recognize how they sacrifice themselves and work extra hours to make sure that they are always there for me.

I would like to pay my special regards to my industrial supervisor Eng. Mohammed Mfinanga, Operational Manager of Raha Beverages Company Limited for his support, valuable ideas and his entire team who provided me a very useful information which were used to successful accomplish this project work. Finally, I would like to thank my fellow classmates and my friends from NM-AIST, I appreciate their time and being kind to me, be blessed forever.

DEDICATION

I sincerely dedicate my project work to my lovely Mum and Dad, Ms. Jacqueline Mutegwaraba and Mr. Jean Bosco Hitimana for their encouragement and their love made me accomplish this master's studies.

TABLE OF CONTENTS

ABSTRACT	I
DECLARATION	II
COPYRIGHT	III
CERTIFICATION	IV
ACKNOWLEDGEMENTS.....	V
DEDICATION.....	VI
LIST OF TABLES	XI
LIST OF FIGURES	XII
LIST OF APPENDICES	XIV
LIST OF ABBREVIATIONS AND SYMBOLS	XV
CHAPTER ONE	16
INTRODUCTION	16
1.1 Background of the Problem	16
1.2 Statement of the Problem.....	3
1.3 Rationale of the Study	3
1.4 Objectives	4
1.4.1 Main Objective	4
1.4.2 Specific Objectives	4
1.5 Research Questions	4
1.6 Significance of the Study	5
1.7 Delineation of the Study	5
CHAPTER TWO	6
LITERATURE REVIEW.....	6

2.1	Liquid Level Monitoring System	6
2.2	Related Works	6
2.2.1	Application of Liquid Level Monitoring Systems	6
2.2.2	Fuel/Oil Tanks Level Monitoring Systems	7
2.3.2	Water Level Monitoring Systems	8
2.3.3	Smart Irrigation.....	10
2.3.4	Beverage Industry and Juice Tanks Level Monitoring System.....	10
CHAPTER THREE.....		13
MATERIALS AND METHODS.....		13
3.1	Area of the Study.....	13
3.2	Research Method.....	14
3.3	Target Population and Sample Size.....	15
3.4	Sampling Techniques	15
3.5	Data Collection Methods	15
3.5.1	Secondary Data Collection.....	16
3.5.2	Primary Data Collection.....	16
3.5.3	Level Distance Calculation.....	18
3.6	System Development Approach.....	19
3.6.1	Agile Software Development Methodology.....	19
3.6.2	System Analysis.....	20
3.7	System Design.....	29
3.7.1	System Design View	29
3.7.2	Block Diagram.....	31
3.7.3	Circuit Diagram	32
3.7.4	Use Case Diagram.....	33
3.7.5	Flowchart Diagram	33

3.7.6	System Development	34
3.7.7	System Validation.....	36
3.7.8	System Implementation.....	36
CHAPTER FOUR.....		37
RESULTS AND DISCUSSION.....		37
4.1	Identified System Requirements	37
4.1.1	Functional Requirements.....	37
4.1.2	Non-Functional Requirements.....	37
4.1.3	Observation and Level Measurement Results	38
4.2	System Development Results.....	39
4.2.1	Result on Software Configuration	39
4.3	Unit Testing Results	42
4.3.1	Liquid Crystal Display I2C Testing Result	42
4.3.2	Ultrasonic Sensor Testing Result.....	42
4.3.3	Buzzer Testing Result and Visualization	43
4.3.4	Alexa Echo Testing Result	43
4.4	Integration Testing Results	44
4.5	System Testing Results	44
4.6	System Validation Results	45
4.6.1	Developed System Validation to Users.....	45
4.6.2	System Requirements Validation.....	47
4.7	Discussion	47
CHAPTER FIVE		49
CONCLUSION AND RECOMMENDATIONS		49
5.1	Conclusion	49
5.1.1	Limitation of the Study	49

5.2	Recommendations	50
5.2.1	Implications to Policymakers	50
5.2.2	Implications to Practitioners	50
5.2.3	Scientific Contribution	50
5.2.4	Future Research	50
	REFERENCES	51
	APPENDICES	56

LIST OF TABLES

Table 1: Dilution tank length and corresponding liters	18
Table 2: Functional requirements of the developed system	37
Table 3: Non function requirements of the developed system	38
Table 4: Length of container and its corresponding liters and percentage	38
Table 5: Functional requirements testing results	44
Table 6: Nonfunctional requirements testing results.....	44
Table 7: Level state within tank	45
Table 8: Requirement's verification.....	47

LIST OF FIGURES

Figure 1:	Intellia IoT application of level monitoring system (Same,2020)	7
Figure 2:	Map location of Raha beverages company limited (Google, 2021).....	13
Figure 3:	Juice overflow in fermentation tank	14
Figure 4:	Interview with Operational Manager.....	17
Figure 5:	Tape measure	17
Figure 6:	Dilution tank	18
Figure 7:	Depth tank measurement process	18
Figure 8:	eXtreme Programming agile method.....	19
Figure 9:	Steel tank and plastic tank	20
Figure 10:	Micro submersible DC pump 12Volts.....	21
Figure 11:	Pipe	21
Figure 12:	HC-SR04 ultrasonic sensor.....	22
Figure 13:	General Purpose Input Output pins of ESP8266.....	23
Figure 14:	Node MCU ESP 8266.....	24
Figure 15:	Piezoelectric buzzer	25
Figure 16:	Relay 5 volts module	25
Figure 17:	16x2 LCD I2C module	26
Figure 18:	Amazon Alexa echo dot speaker	27
Figure 19:	Arduino IDE.....	28
Figure 20:	Alexa app	28
Figure 21:	ThingSpeak IoT cloud	29
Figure 22:	System design	30
Figure 23:	Block diagram of the developed system.....	31

Figure 24: Circuit diagram designed in Proteus design suite 32

Figure 25: Use case diagram..... 33

Figure 26: System flowchart..... 34

Figure 27: Length of the container for prototype 39

Figure 28: Pumping system in Sinric Pro 40

Figure 29: Device ID 40

Figure 30: Search for Sinric Pro, Sinric Pro linked together, pump connected via Sinric Pro
..... 41

Figure 31: Configuration of pump, all devices discovered, connecting a pump 41

Figure 32: LCD displays percentage level of juice 42

Figure 33: Visualizing ultrasonic sensed values 42

Figure 34: Visualizing buzzer 43

Figure 35: Communicating with Alexa echo dot speaker 43

Figure 36: Designed system prototype 45

Figure 37: Final developed system prototype 46

Figure 38: User feedback view 46

Figure 39: Final Prototype 71

LIST OF APPENDICES

Appendix 1: Interview Guide.....	56
Appendix 2: Questionnaire	57
Appendix 3: System Validation Questionnaire.....	58
Appendix 4: Code for Alexa voice controller.....	59
Appendix 5: Code for Sending Data to ThinkSpeak.....	62
Appendix 6: Code for Final Prototype	66
Appendix 7: Project Final Prototype	71
Appendix 8: Research Outputs	72
Appendix 9: Poster Presentation	73

LIST OF ABBREVIATIONS AND SYMBOLS

Abbreviations	Description
DC	Direct Current
EAC	East Africa Country
GND	Ground
GPIO	General-Purpose Input/Output
GSM	Global System for Mobile communications
I2C	Inter-Integrated Circuit
IDE	Integrated Development Environment
IoT	Internet of Things
LCD	Liquid Crystal Display
NM-AIST	Nelson Mandela African Institution of Science and Technology
PCB	Printed Circuit Board
RABEC	Raha Beverage Company
SCL	Serial Clock
MCU	Micro-Controller Unit
SDA	Serial Data Pin
ID	Identification
VCC	Voltage Common Collector
API	Application Programming Interface
XP	Extreme Programming

CHAPTER ONE

INTRODUCTION

1.1 Background of the Problem

Inadequate communication during the transfer of liquid from one tank to another can lead to certain errors when using manual techniques of liquid level monitoring within storage tanks. Some of the most significant challenges include overflowing of liquid, which can result in certain accidents, and altered wine test results in the beverage industry due to improper liquids measurements during the dilution process.

Overflowing of liquid can create a danger and the loss of product that tank contains despite that it can cause accidents. Tankers, totes, receptacles, and containers are used for more than just storing liquids. They should also be kept track of their proper stock levels and act as temporary liquid depositories unless they are transferred to another stage, particularly in industries that need to store fluids gas and oil, water, chemicals, and drinks (Cooperation, 2000). In the beverage industry, massive tanks are erected to store juice and wine until they are pumped for further fermentation or distributed to the packaging step (Cañete *et al.*, 2018). Those tanks, which are connected by a pipeline network, allow liquid goods to be moved between stages of the production line and liquid to be transferred at the appropriate time (Abbas *et al.*, 2016). The number of fluids stored in those tanks must be constantly monitored. Overfilling the fuel tank causes negative effect to the car and to the environments, if the tank of the car overfills, the gas liquid can enter to evaporative system which was designed for vapor only (Jamison, 2019). This damages the vapor system and affect the car's performance and causing it to run poorly. Hence the fuel can fall to the ground and cause harmful effects to the environment and people's health (LLC, 2019) . Also, gasoline contribute to bad ozone day by air quality index.

According to Baldeon *et al.* (2021), many homes, schools, and industries have water reservoirs on their rooftops or elsewhere to save water for future use. But they lack regular monitoring of water levels within tanks and real-time visualization, which can lead to overflowing and waste of water when filling the reservoir. In 2001 improper manual setting of the liquids transfer system caused a Wrexam, UK tank overflow and resulted in 14 tonnes of toxic phenol released into a bund area (Chang & Lin, 2006). Although industry processes are running slowly, there is a need to be forced to switch off the pump when the tanks run dry this result in to idling of

workers and when the tank overflow can cause accidents within the company. This lead to lose revenue and wasted expenses, hence the company need a proper way of monitoring the tanks. Poor monitoring of tanks causes accidents due to the operator error who may fail to provide information at time to prevent accidents early, by this an operator may receive warning to not repeat the same mistake in the future if this happen again the operator can be fired (Leveson *et al.*, 2016).

Typical industrial setup where a tank filled with coolant facilitate its discharge on the heated part of a machined component. The liquid level monitoring of tank can be used to ensure that the tank does not run out of the liquid (Madhumitha *et al.*, 2020). Operators at all-times should live data about the level of liquid and hence prevent the tank from being emptied. This prevents the softening of the components caused due to heat generated during machining and help in the smooth surface finish without any indentations.

Traditional manual inspections and measuring sticks are a low-cost technique of level monitoring, but they are time-consuming and prone to inaccuracies. Floats and submersible pressure transducers are examples of automated technologies that reduce the chance of errors and simplify operations for better results (Twickenham, 2021).

Raha Beverages Company Limited (RABEC) is one of local company located in Arusha-Tanzania which is a home-grown venture dating to early 1990 as a backyard producer of wine made from banana fruits. At the same time, the original idea was to produce the wine for home consumption. It gained popularity, developing from a homemade wine to a widely accepted variety of banana alcoholic beverages made in a more organized and nationally acceptable (Ngollo, 2021).

This company is negatively affected by manual monitoring of tanks where juice tanks are manually controlled by an operator during transferring juice from the boiler to the dilution chamber. Juice is pumped from the kitchen boiler to the dilution tank located far meters away. The person who is at the fermentation location should keep an eye on the tank to see if the juice is full or exceeds a threshold limit, and then shout to the folks at the boiler to turn off the motor. When a human is not there, juice continues to flood until the motor is turned off. Several systems were developed but they are still expensive and not interactive. Smart tanks juice level monitoring system implementation has a potential significance in fluid industry applications.

1.2 Statement of the Problem

Juice tanks are commonly used to keep juice at home and in industries. Juice tanks that are used at home are tiny and may store juice from 1 liter to 10 liters with no need to monitor the level of juice within it. The tanks that are used in the beverage industries are excessively lengthy and store a large amount of juice, ranging from 200 liters to more than 50 000 liters. It should be kept an eye on in order to avoid the juice overflowing.

However, poor juice tanks level monitoring is one of the major issues in the beverage industries. Poor management of these tanks may result into overflowing and the loss of numerous items contained in the tanks (LLC, 2021). Manual methods of monitoring storage tanks result in errors during the monitoring process, making it difficult for plant managers and operators to accurately estimate fluid quantities (Twickenham, 2021).

At Raha Beverages Company Limited, the process of transferring boiled juice from boiler to other tanks for further processing such dilution and fermentation, has resulted into several problems. Currently, the company uses mouth shouting to notify employees who are working at the juice plant to turn off the pump or move quicker when pumping juice from the boiler to the fermentation tank. If an employee is not available to turn off the pump during juice pumping process, then there may occur the following problems such as overflowing of juice to floor, final product may have different taste apart from the intended one, accidents such as collision may occur when people are hurrying up to turn off the juice pump, and figure out how much water should be used to dilute juice based on amount of juice that has been transferred to the tanks and noisy happens.

1.3 Rationale of the Study

Juice tanks level monitoring is a serious problem in the beverage industries, particularly small businesses in Tanzania. This causes negative impacts on the growth of local industries, which could be strengthened for future large industries and provide employment opportunities to many people in various ways. The existing solution has been implemented to high-priced advanced industries.

The developed system can be implemented in industries, fuel and diesel tanks and residential water tanks to trigger the level of the tank whenever fluid goes below and switch off pumping system automatically to prevent overflowing of fluid in tank (Shetty,2020) when water is

transferred to the tank. Fuel level detection is important to prevent oil theft that can happen in the fuel oil tanks or in the parking insecurity place and for continuously monitoring the level of fuel in the reservoir or fuel usage (Barde *et al.*, 2017). Water river or lake detection for early warning to the surrounding population and controlling the streams along the river based on the data (Ahmed & Jian, 2013) and other liquid detection for preventing the overflow. Beverage's industries will benefit through the use of this system once it's implemented to detect the level of juice and continuous monitoring of juice tanks to overcome the overflow, which leads to decrease company's production

1.4 Objectives

1.4.1 Main Objective

The main objective of this project was to develop smart tanks juice level monitoring system for beverage industries.

1.4.2 Specific Objectives

The specific objectives of the study were:

- (i) To identify system requirements for developing smart tanks juice level monitoring system.
- (ii) To develop smart tanks juice level monitoring system.
- (iii) To validate the developed system.

1.5 Research Questions

The study attempted to answer the following research questions:

- (i) What are the system requirements for developing smart tanks juice level monitoring system?
- (ii) How does the development of smart system for monitoring the level of the juice within the tanks take place?
- (iii) How does the validation of the developed system take place?

1.6 Significance of the Study

Monitoring of juice level tanks and automatic switching of pump will eliminate unnecessary accidents, maintain wine taste and prevent an overflowing of fluid within the tank. Measurement due to the level of the juice within tanks will be accessible by an operator through online and is automatic where the pump can be switched off automatically when juice level reached to threshold. The results of this project have more importance to the beverage industries.

1.7 Delineation of the Study

This project focuses on monitoring of juice level within the tanks at Raha Beverage Company Limited in Arusha, Tanzania. In this project smart tanks juice level monitoring system has interconnected sensors and actuators that communicate together through a microcontroller and does automation.

CHAPTER TWO

LITERATURE REVIEW

2.1 Liquid Level Monitoring System

In today's automotive, oil, water, gas, pressure, and beverages industries, level monitoring is a technique of measuring foundation movement in a structure to accurate levels. For example, while pumping oil into a tank, a liquid level monitoring system is required to prevent the oil from overflowing, which can be measured using a pressure sensor (Le, 2011). It is also helpful manufacturing industries in knowing the level and the quantity of liquid inside the tank. Monitoring liquid level results to the same quality and same liquids level in all the tanks and bottles respectively (Madhumitha *et al.*, 2020).

Liquid level within the tank/reservoir in real time can be implemented in multiple domains particularly to measure the level of liquid in the container. These solutions allow to view fluid level information, temperature, and relative humidity on both mobile phones, LCD and desktop computers (Madhumitha *et al.*, 2020). Level monitoring systems were developed to manage liquids within the reservoir. These systems use wireless ultrasonic sensor which sense the data from the reservoir and send information to the cloud to be visualize through web and mobile app (Same, 2020). The solution costs ranges between \$ 1000 and \$ 2000 (Same,2020) which is a bit expensive. Level monitoring systems have been contributing a lot within small scale and/or large scale industry (Madhumitha *et al.*, 2020).

2.2 Related Works

2.2.1 Application of Liquid Level Monitoring Systems

Liquid level monitoring systems have been developed and applied to different fluids. Most developed systems were developed for monitoring water within the tank, reservoir, river and lakes by using different technologies (Morris, 2005). Fuel and oil tank level monitoring systems were also developed. The purpose of the developed level monitoring systems were to overcome overflowing of liquid within the container caused by manual operations and eliminate accidents due to overflowing of fluids (Cooperation, 2000). However, this system doesn't not send the data to the cloud to be visualize remotely.

Applications of level monitoring systems are as shown in Fig. 1. According to BizIntellia, Water and Powered (2018) industries that rely on tanks and receptacles, such as water, oil and gas, chemical, and beverages, can employ level monitoring systems solutions to improve their processes and achieve operational excellence. Within a plant level monitoring system can be utilized as part of an automation infrastructure to automate activities, enhance output rate, and forecast potential faults.



Figure 1: Intellia IoT application of level monitoring system (Same, 2020)

2.2.2 Fuel/Oil Tanks Level Monitoring Systems

Level monitoring solutions can be used for monitoring mobile fuel tanks, gas station and diesel tanks which guide distributors and supervisors to know the real-time fuel stock level in the tanks. The level monitoring solution is flexible enough to accommodate any fleet size (Popescu *et al.*, 2020).

According to Komal *et al.* (2018), theoretical results reveal that 90% of individuals struggle with manually managing and monitoring fuel usage within tanks. For consumers to ensure that the number of liters received in their fuel tanks if it matches the quantity recorded on the issued receipt because gasoline transfer is done manually. The automatic fuel management system has been created to track the amount of fuel in the tank, interact with the Global System for Mobile Communications (GSM) network, and relay the level to the tank owner to ensure that what was ordered and what was received are the same. This system uses probe sensor that can rust and negatively affect people’s health once it is used to measure juice level.

Due to an increase in fuel consumption caused by an increase in the number of vehicles that consume fuel, the problem of fuel theft at petrol pumps has risen as a result of poor estimation

of the level within the tank. Rosaline *et al.* (2019) proposed a system to monitor the level of fuel within the tank by using a fuel level sensor, which collects the level of fuel within the tank and sends it to an Arduino mega. It is simple to know the current price of fuel and the volume of fuel to be put within the tank to avoid bunkers using IoT and a webpage established (Rosaline *et al.*, 2019). This system uses probe that can't be immersed into liquid that intended to be consumed by people because the probe can rust furthermore it uses Arduino Uno which is expensive and require external shield to be connected to the internet.

An automatic gaging and remote monitoring system was developed to solve the problem caused by manually monitoring the generators, specifically jumping from manual to technology over the evolution of the twenty-first century. This system is based on real-time monitoring to observe generator state, average of spent fuel, and the level of fuel in the main tank. The ultrasonic sensor detects the height of the liquid within the main tank and provides the information to the microcontroller (Arduino), which saves the information and displays the value on the smartphone (Al-Chalabi & Al-Dhahiri, 2021). However, these systems are intended for user of fuel rather than beverages, and they employ a pricey microcontroller that is not self-contained and requires an internet shield to communicate with the sensors and database.

2.3.2 Water Level Monitoring Systems

Water level monitoring system provides the real-time insights into available water inside tanks, with a sensor installed on the water tank. IoT solutions ensure that the system won't face any issue such as water getting spilled out from overhead water tanks and alert when a tank is about to get empty or full (Popescu *et al.*, 2020). These solutions also allow users to change the threshold limits.

Yazhini (2017) conducted comprehensive research on to design and control a smart water tank by using various IoT techniques and technologies through integration of different hardware and software. In this research, the proposed system straightforward ways through which water levels can be monitored and controlled in various contexts. However, the study focused on checking water quality before sending it to the environment for use by daily human activities such as irrigation, domestic use and did not consider the application of any technology.

According to Ahmed Sha *et al.* (2018), water level tank is also monitored through tank by measuring important parameters using sensors like potential of Hydrogen (pH), Electrical

Conductivity (EC) to measure level, waterproof DS18B20 temperature sensor. Its primary purpose is to continuously measure the quality of water because it has been discovered that there is a growth of microorganisms inside the tank that increase over and over that cause the pollution of water. The collision of pipe and using old tube can contribute to polluting water that causes the disease to health of people. Hence, water was constantly monitored by its quality and level through smart tanks by maintaining standard water for domestic use. However, this system uses a probe to measure the level of liquid which is not good to immerse it into water as it may rust and affect people's health who consume the water.

Costa and Emanuel (2020) explained how Internet of Things based smart water tank monitoring was developed as a combination of different equipment to monitor water in the tank. The system sends a notification to the operator to turn on the water pump through the mobile app if there is no threshold level of water in the tank or if the tank is full. The notification was sent to the operator to turn off the water pump but did not consider automatic monitoring. IoT technology that can help to monitor water levels in tanks does visualization using several devices such as smartphones, computers, or laptops thus there is no water depletion, which results in water damage. Thus, IoT technology helps humans reduce work.

An intelligent IoT based water level monitoring system was developed to use sensor based water level detection, which checks the water quality by considering parameters such as the water level, turbidity, gas and temperature. Danole *et al.* (2020) explained how real time data measured by the sensors, monitored by an agent, and notify real-time quality are sent through Twitter. However, the purpose of this solution was to ensure the quality of water within the reservoir.

Supriya (2020) developed an IoT based real time water level monitoring using Texas instruments CC3200. This system automatically controls and monitors water level within the tanks by using geotagging techniques. It easily detected the location of water overflow. In case, the system fails to actuate by automatic switch off the pump it alters to the operator by using Short Message Service (SMS) to physically switch off the pump. However, the proposed system uses insulated conducting wires which acts as sensing probes which is having high probabilities of rusting within the liquid. This solution can cause the negative impact to the people's health and the system only give information to the user; thus, the user cannot communicate with the pump.

2.3.3 Smart Irrigation

With Intellia IoT solution, it is possible to never run out of water for irrigation purposes (LLC, 2019). The real-time insights into water stock ensure that motor never runs without water. If the water level goes below the defined limits, the concerned person is alerted, and the motor switches off automatically. However, there is no way to control the pump by the operator.

Tank level monitoring was also used in smart irrigation to monitor the water tank used for irrigation of crops. The developed system houses different components for measuring parameters within the soil and ultrasonic sensor to measure the water level within the tank and send the data to microcontroller (Arduino Uno) that notify if the water within the tank is enough or not. To know quantity of water within tank is important in automatic irrigation which automatically switches off or on the pump when it reaches to a threshold level (Kunal *et al.*, 2019). However, this system is expensive as it uses Arduino which is expensive and the system is not interactive.

Water level monitoring tank stores water to irrigate farmers' crops to prevent shortage of water within the reservoir. Farmers was able to monitor their reservoir at real time and system alters to farmers when water level is low, this mean that a farmer doesn't always be on the farm to check the reservoir level. This system uses ultrasonic sensor and Arduino to communicate each other (Suresh *et al.*, 2019). However, it uses expensive microcontroller which need other shield for it to be connected to the internet and does not perform automatic pumping.

2.3.4 Beverage Industry and Juice Tanks Level Monitoring System

In beverage industries, juice and other beverage products need to be monitored and automating production by providing an easy distribution to make supply chain more effective (Barrows & Robinson, 2018).

Level monitoring system has been used in Breweries' industries. Majority of beer tanks are equipped with devices for measuring beer level within the tank, but those devices can come into contact with beer and require special attention when cleaning the tanks. Developed system uses an ultrasound system, sensor, or probe attached to the tank's exterior in a noninvasive manner (Practice, 2018). However, this system lacks an easy mean to obtain the sensed data, as well as an autonomous pumping mechanism.

Furthermore, level monitoring system has been used in wine industries. This type of wine tanks level monitoring system was created to measure various parameters within the fermentation tank, such as temperature, pH, and wine level, all of which have an impact on the quality of the wine (Masetti *et al.*, 2018). Wine level was detected using an ultrasonic sensor by measuring the distance between the wine level buoy and the top of the tank, the data shared via Arduino board then uploaded to the cloud to be visualized. This system uses Arduino uno which is expensive and need external attached equipment to communicate with the cloud.

Manual controlling of wine ullage can lead to oxidation at each time tanks are opened and lead to ineffectiveness (Cañete *et al.*, 2018; Pambudi & Hujja, 2021). This solution uses ultrasonic sensor placed inside the cask or tank and keep measuring the ullage wine within the tank. It measures whether level of wine increases or not and send the data to Arduino uno which sends it to the cloud to be analyzed and visualized (Cañete *et al.*, 2018; Pambudi & Hujja, 2021). However, this system does not perform automatic pumping and it is expensive.

In a practical application, a prediction equation was used to predict juice level within the tank, and multiple models were used to forecast which is the best. The truck's juice level in the tank was maintained by its level with high and low points (Sugar *et al.*, 2003). However, the application does prediction of the model instead of being applied to the environment. A researcher come up with the system that monitors juice level within the vessel. This system uses ultrasonic sensor to sense the level of juice within the vessel, ultrasonic sensor is installed to the top of the vessel where it transmits ultrasound to sense the level of the juice within the vessel (Engineering, 2015).

Pandey (2017) developed a system for automatic vending machine for the purpose of reducing manual selling juice. The machine considers different parameters such as measuring level of the juice in the reservoir and notify to the vendor when the level of juice goes down or reaches to the threshold level. However, this system is integrated with two microcontrollers which made it complex and expensive and it does not implement automatic pumping control and a proper way of visualizing sensed data.

Moreover, cargomaster system developed by Marine (2019) was for marine tanks to monitor the level of juice and other liquids within the tank and emit an alarm when the liquid level changes. This was done to avoid a large loss of juice while transporting it. This method makes use of a level radar sensor, which is a probe that can rust and harm customers' health.

Level monitoring solution developed by Biz4Intellia LLC (2021) allows the observer to monitor the level of juice in multiple 30-45 feet large tanks/tankers in real-time and receive notifications when the level of juice reaches a threshold level. The system also measured the temperature of juice stored within tank. It uses a wireless ultrasonic sensor to measure the amount of juice in the tank, eliminating the need to manually climb the tank to check the level. The system costs between \$ 1000 to \$ 2000 which made it expensive that can't be affordable by small scale industries. United Watch Trading (UWT) group developed a continuously measurement of juice level within its container. It uses radar probe sensor to sense the level of juice. This system has drawback where it uses a probe in the tanks which require regular cleaning that can destroy the system building through regular attach, reattach of a device and consumer time (Solution, 2021) .

A research done by Osore and Eae (2019) explains how the quality of sugar cane juice depends on considering different parameters such as brix, temperature, automation techniques and imbibition of water used to dilute the concentrated juice during transferring water to dilution chamber. The proper and automatic measurement of juice and water levels is very important to maintain the quality of juice. To achieve this, it requires automatic levels measuring.

Existing tanks level monitoring systems, whether they measure the level of water, gasoline, beer, wine, or juice within the container, can be adopted to measure the level of juice if they cost less and are efficient for the user, based on the above linked works. However, the existing systems that measure levels of liquid within the tank/reservoir are based on generating alarm through buzzer, and using a Liquid Crystal Display (LCD) to continuously display the level of liquid as well as alter to operator. None of these solutions are user-friendly, interactive, or communicative. They provide notifications to the user but do not allow operator to give command to the system to control the pump to be on or off without doing it manually.

The developed system "Smart Tanks Juice Level Monitoring System" allows operator to view, communicate and interact with the system physically or remotely. The level of juice in the tank is shown on an LCD display, and when the juice reaches the desired level, the buzzer generates sound, after that data are transferred to the cloud and accessed by Alexa voice control. By using a voice controller, the operator may communicate with the device. For example, when the juice level reaches a given level, the operator can ask Alexa echo dot speaker to turn off the pump. This is a fun and easy way to keep track of the juice level in the tank.

CHAPTER THREE

MATERIALS AND METHODS

3.1 Area of the Study

This study was conducted at the Raha Beverages Company Limited located in Arusha, Tanzania as shown in Fig. 2. It is producing wine where most of their consumers are local residents and the majority of the activities performed within this industry are done manually. The company intends to improve from manual way to automatic way of tanks level monitoring during juice transfer process from the boiling tank to the fermented tank.

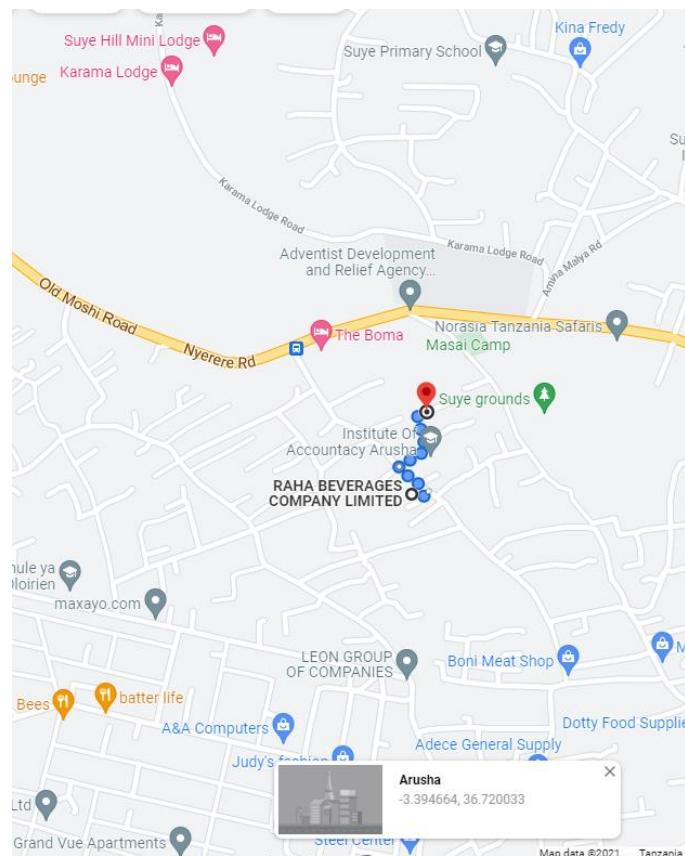

Figure 2: Map location of Raha beverages company limited (Google, 2021)

The overflowing of banana juice occurs when operators are pumping juice from the boiler to the fermentation tank at RABEC. The fermentation room was 200 meters away from the boiling room, and there are pipes connected to a pump that create a channel of juice pumped from the boiling tank to the dilution tank, and the water of diluting juice is pumped from the kitchen to the dilution chamber. Overflowing of juice, accidents, and inaccurate measurement between

juice and water can occur in this scenario, which is caused by over pumping or pumping below the threshold level.

The method RABEC used to prevent overflowing of juice, was to keep an eye on the tank where the juice was transferred to and notify pumping team on the boiling room to turn off the pump with a loud voice. They even tried to use ‘vuvuzela’ known as a plastic noise maker. However, workers could not distinguish vuvuzela noise with other noises produced by the machine or from outside the plant. Furthermore, due to the long distance between the two communicating tanks, overflowing of juice still occurs, resulting in accidents within the plant. Figure 3 shows one of the challenges caused by poor monitoring of juice tank at RABEC.



Figure 3: Juice overflow in fermentation tank

3.2 Research Method

This research employed mixed research method which allows data investigation and interpretation of the collected data by using interviews, observations, document analysis and questionnaires.

The interviews were conducted with the operator and workers in the boiling room, as well as personnel in the fermentation room in order to learn about the current method for transporting juice from one location to another, as well as the unit of juice and water required to dilute juice. The interview guide is shown as Appendix 1.

3.3 Target Population and Sample Size

The target population was Raha Beverage Company Limited workers. In this population, the sample size was selected by using convenience sampling technique. The identified sample size comprised of 5 workers where 3 workers (company's operational manager, mechanic, operator's unit controller) were from over all operational management department and 2 were engineers from boiling department.

3.4 Sampling Techniques

In literature, there are non-probability and probability sampling techniques. Probability sampling is a sampling technique, in which the participants of the population get an equal chance to be selected as a representative sample. Probability sampling techniques are simple random sampling, stratified sampling, cluster sampling and systematic sampling. In non-probability sampling technique, it is not known that which participant from the population will be selected as a sample. Non-probability sampling techniques are convenience sampling, quota sampling, judgment or purposive sampling, and snowball sampling.

In this project, the participants of interview and questionnaire administration were selected using convenience sampling technique. This sampling technique was adopted because the selected workers were easy contacted and reached as well as are experts in a particular work that made them easy to respond to questions.

3.5 Data Collection Methods

Data was collected from Raha Beverage Company Limited over all operation manager, technicians and operator who control that segment of making juice and juice transfer. The data collected are classified into two categories named as secondary data and primary data.

3.5.1 Secondary Data Collection

Secondary data were gathered from existing documents related to this study, such as journal articles, reports, books, websites, and databases. These data had already been prepared and compiled for analysis, were studied to gain a better understanding of smart tanks juice level monitoring systems and to seek additional guidance. The document analysis also helped to identify the gap from different existing systems.

3.5.2 Primary Data Collection

Primary data were collected using interviews, observations, and questionnaires:

- (i) **Interviews:** The purpose of the first interview was to gather data in order to identify potential issues and problems that the Raha Beverages Company Limited is facing. This interview was held with the Raha Beverages Company's operational manager and Engineer during the tour made in the company. The interview guide is shown in Appendix 1. A second interview was conducted with the operator's unit controller to learn more about the chosen problem, to evaluate the existing method of juice transfer and to know ways of communication during the manual transfer of juice from one operation to another. The questions were asked at the point view of the respondents for multiple research method. Figure 4 shows the interview process that was performed in the fermentation room to clear explain and show how the process is done.
- (ii) **Questionnaire:** questionnaire sheet was given to operators face to face to respond to the questions in order to determine the current situation of juice pumping from one tank to another and current way of knowing the level of juice with the tank. The questionnaire is shown in Appendix 2.



Figure 4: Interview with Operational Manager

- (iii) **Observations:** Structured observation method was used to observe the existing scenario of juice transfer from the boiler to fermentation tank and measuring amount of juice with their respective water transferred in tank. The distance from kitchen to the fermentation place was measured to know how long it is and see if people can communicate in both places easily or if people can run to switch off the pump without causing any problem, after that data were recorded. Distance was measured using a tape measure (Fig. 5).



Figure 5: Tape measure

The distance between both rooms is 200 meters which takes 2 minutes to cover it and reach in the kitchen to switch off the pump. The dilution tank is shown in Fig. 6. The depth of the dilution tank was measured as shown in Fig. 7 to know at which level the pump should be switched off and make sure that the level of juice should be equal.



Figure 6: Dilution tank



Figure 7: Depth tank measurement process

Table 1 shows the measurement of dilution tank depth and its corresponding liters and which level is considered as threshold level to prevent overflowing of juice.

Table 1: Dilution tank length and corresponding liters

Liquid level	Length of dilution tank	Liters of diluted juice	Result
Threshold level	1m 80cm	15 000 liters	Normal
Below level	Less than 1m 80cm	Less than 15 000 liters	Low
Above level	Great than 1m 80cm	Great than 15 000 liters	Overflowing

According to information provided by an Operator, there is a problem of altered test of wine that occurs while diluting juice. In Raha Beverages Company Limited any amount of juice pumped should be diluted with water to reach a total volume of 15 000 liters.

3.5.3 Level Distance Calculation

The primary goal was to know the distance between juice level and ultrasonic sensor and its corresponding depth. Ultrasonic sensor measures the distance between 2cm to 400cm and it

uses two transducers to measure its distance and object. The trig transducer emits acoustic sound waves which hit the juice surface within the tank and reflect towards the echo transducer. The level distance was calculated by considering the speed of sound in air and time taken by sound wave to the level of juice and the return to transducer after hitting juice level. This distance was converted into percentage to know the percentage level of juice within the tank. The distance was measured depending on duration and speed of sound where speed of sound in air is 0.034 m/s so that the distance = (duration*0.034) /2. The distance was converted into percentage to display the percentage level of juice within the tank which correspond to the liters of each level.

3.6 System Development Approach

3.6.1 Agile Software Development Methodology

The system developed followed an agile software development methodology particularly Extreme Programming (XP) agile method. Agile methodology minimizes risks such as changing requirements when adding new functionality in all agile methods. It also allows continuous collaboration between developers, customers and stakeholders.

Extreme Programming (XP) (Fig. 8) was adopted in this project because during development, a developer focused on coding and eliminate unproductive activities by creating simple code that can be improved at any time. The collaboration between developer and client was maintained in order to ensure that a company receives the expected working system.

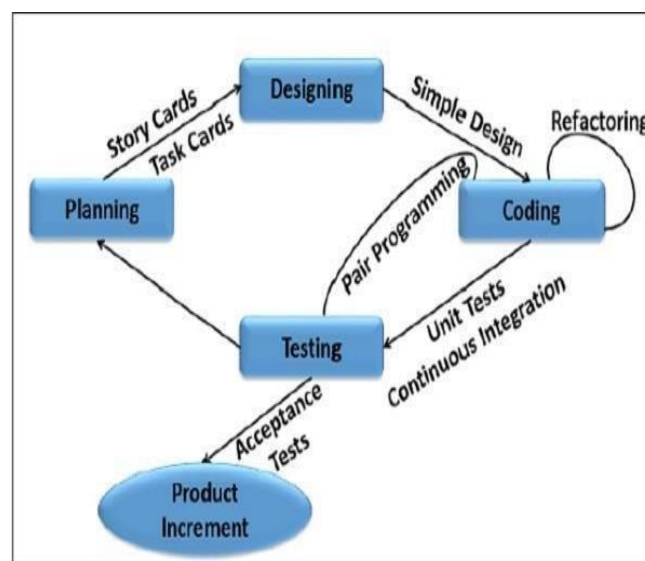

Figure 8: eXtreme Programming agile method

3.6.2 System Analysis

According to the interview performed, smart tanks juice level monitoring is relevant if it is automatic, real time monitoring the level of juice within the tank, prevent overflowing and eliminate mouth shouting which was used to notify the operator to switch off the pump. The followings are hardware and software requirements for prototyping.

(i) Hardware Requirements

This section describes the equipment used to design and develop the system.

(a) Tanks

Tanks are big containers used to store liquids like water, juice, wine and oil typically made of polythene plastic or steel tank, Figure 9 represents steel tank and plastic tank respectively. Raha Beverages Company Limited uses a different size of tank to store concentrated juice, diluted juice ready to be fermented and produce wine. One of the juice tanks can store 2000 liters of concentrate juice, tank for dilution can store mixture of juice and water about 15 000 liters of liquids, and fermentation tanks where each tank can store 5000 liters of diluted juice. In this prototype we used a small tank that store 15 liters.



Figure 9: Steel tank and plastic tank

(b) DC Pump

Figure 10 is micro submersible Direct Current (DC) pump 12Volts, easily integrated into a liquid system project. Brushless DC motors are widely used in industries application,

automotive application, robotic application and medical application because of their high efficient, low power consumption, low noise and their brushless (Thomas, 2020) . The DC pump works using the water suction method, which drains the water through its inlet and released it through the outlet. This prototype uses a brushless DC pump to pump the juice from the juice sump tank to the dilution or to fermentation tank.



Figure 10: Micro submersible DC pump 12Volts

(c) Pipe

Figure 11 represents pipe. Pipe or tube, frequently made of plastic or metal, carries pressurized and treated fresh liquid to a building (as part of a municipal water system) and inside the building. A pipe was used as juice channel to move pumped juice from one tank to another.



Figure 11: Pipe

(d) Level Sensor

The ultrasonic sensor was created to detect an object at any distance. It has a non-contact measurement range of 2 cm to 400 cm and is made up of ultrasonic transmitters, receivers, and a control circuit. Figure 12 is ultrasonic sensor which uses an IO trigger for at least a 10 milliseconds high level signal, detects whether there is a pulse signal back, and thus it goes high and records the distance where $\text{distance} = (\text{high level time} * \text{velocity of sound (340 M/S)})/2$ (Indoware, 2013). Probe level sensor is used to measure the liquid level within a tank that can be immersed inside the container and come into contact with the liquid. However, it is not suitable to be immersed inside the liquid that is intended to be consumed by people because it may rust depend on the material which is made of and causes some negative effects on the people's health, that is the reason why an ultrasonic sensor was used in this project.

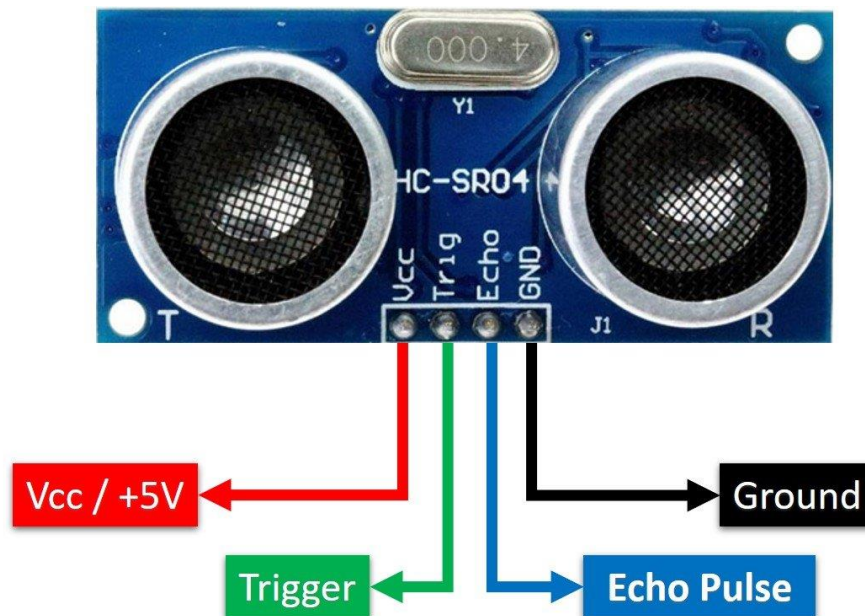

Figure 12: HC-SR04 ultrasonic sensor

(e) Node MCU

Node Micro-Controller Unit (MCU) is an open-source Lua-based firmware and development board designed specifically for Internet of Things (IoT) applications. It includes firmware that operates on 'Espressif Systems' ESP8266 Wi-Fi SoC, as well as hardware based on the ESP-12 module. Figure 13 represents General-Purpose Input/Output (GPIO) pins and their respective pins notation while Fig. 14 represents external notation of pins represented by Digital(D). The ESP 8266 module is the best choice to deal with IoT application than Arduino

which was the best but does not have a built in Wireless Fidelity (Wi-Fi) capability which requires external Wi-Fi protocol to make it capable with internet channel (Al Dahoud & Fezari, 2018). ESP 8266 module has a built in Wi-Fi capability and it costs low.

The ESP8266 is compatible with Arduino Integrated Development Environment (IDE), in this project ESP 8266 was used as a microcontroller where the sensor and actuators were communicated each other.

Node MCU has the following possible powering:

- It operates on the 3.3 volts input with 2.5 volts to 3.6 volts.
- It operates on the VIN input pin with a voltage between 7 volts and 12 volts.
- Vu pin as Universal Serial Bus (USB) cable with 5 volts. A diode prevents current from the 5 volts input to the USB connection flows.

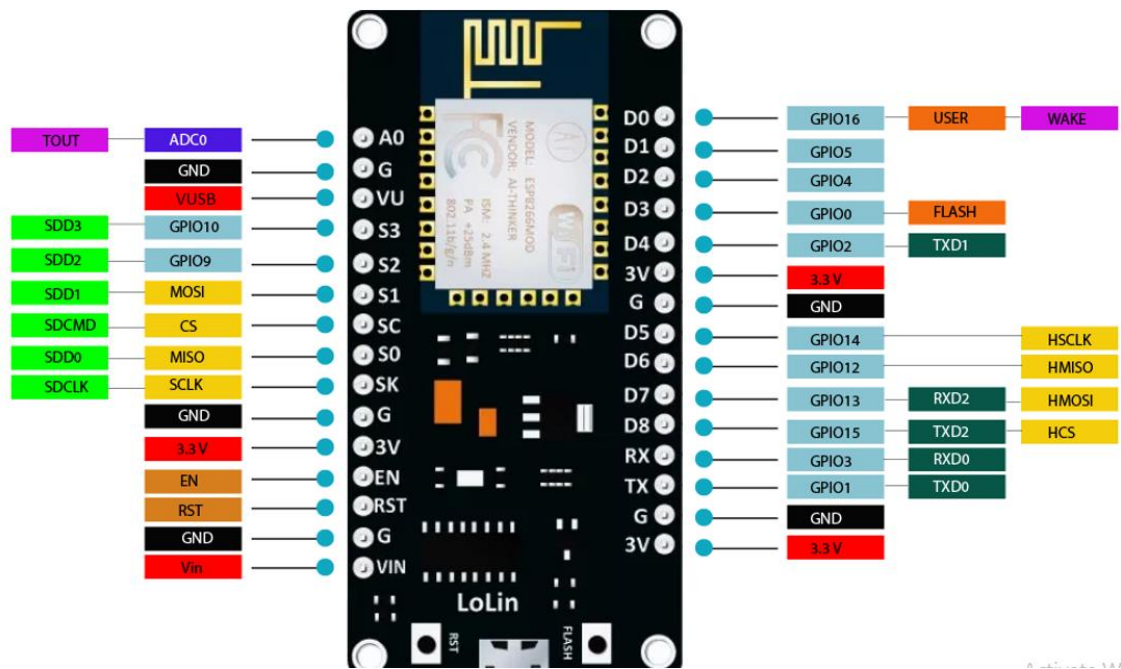

Figure 13: General Purpose Input Output pins of ESP8266

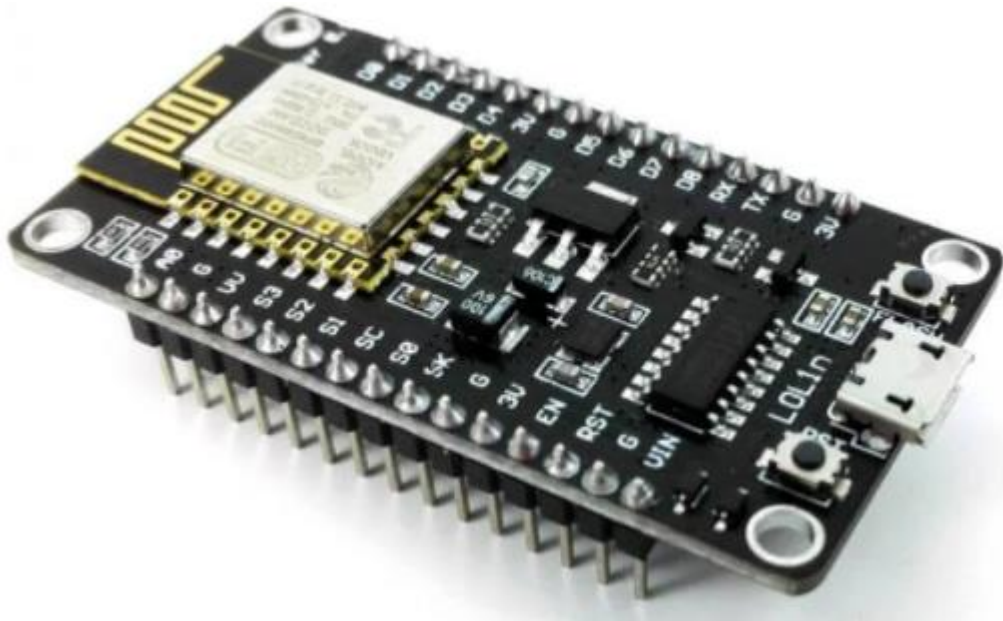

Figure 14: Node MCU ESP 8266

(f) Buzzer

Buzzer is one of the most popular audio communications is through buzzer. It is an integrated structure of electronic transducers, DC power supply, widely used in computers, printers, copiers, alarms, electronic toys, automotive electronic equipment, telephones, timers and other electronic products for sound devices. Active buzzer 5 volts rated power can be directly connected to a continuous sound (Devices, 2019). Figure 15 represents a buzzer that was used to generate sound to the operator when the level of juice reach to a threshold level.



Figure 15: Piezoelectric buzzer

(g) Relay

The relay module in Fig. 16 is an electrically operated switch that can turn on or off a circuit with significantly higher voltage and/or current than a microcontroller can handle. There is no link between the microcontroller's low voltage circuit and the high-power circuit, each circuit is protected by the relay from the others. In this project relay was used as a switch to turn on and off the pump.



Figure 16: Relay 5 volts module

(h) 16x2 LCD I2C module

Figure 17 shows 16x2 Liquid Crystal Display (LCD) with Inter-Integrated Circuit (I2C) module. It is a new version of 16x2 LCD with no I2C module are both able to display 16x2 characters on 2 lines. Moreover, 16x2 lcd I2C module has more advantage where the connection of pins become easier compared to 16x2 LCD module which requires to connect almost all pins to the corresponding of microcontroller. 16x2 LCD I2C module is using an I2C communication interface. It only needs 4 pins for the LCD display: Voltage Common Collector (VCC), Ground (GND), Serial Data Pin (SDA), Serial Clock (SCL). I2C module need only 2 digital pins to the microcontroller which saves at least 4 digital/analog pins on microcontroller that can be used in case there is no I2C and it saves the number of wires. In this project LCD Inter-Integrated Circuit (I 2C) was used to display the status of juice level within the tank.

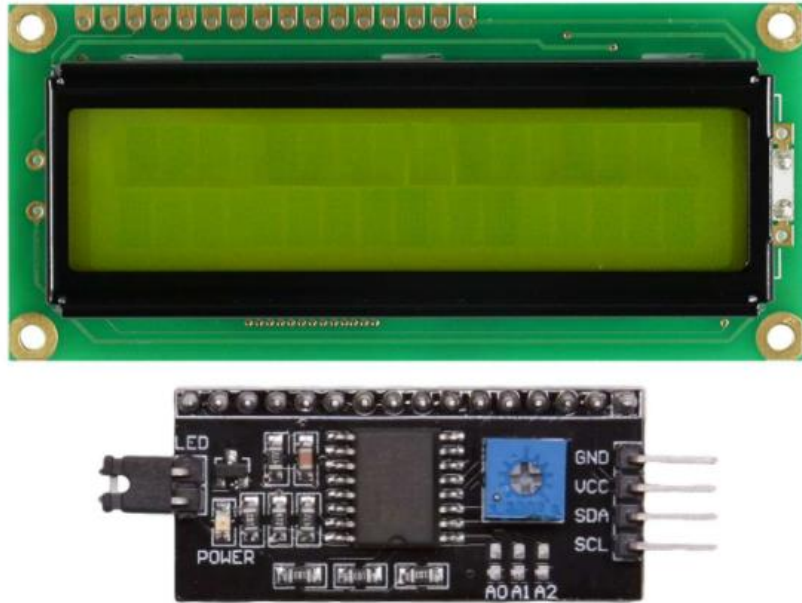

Figure 17: 16x2 LCD I2C module

(i) Amazon Alexa Echo Dot Speaker

Amazon Alexa echo dot speaker is a voice controller created by Amazon for its echo dot, which is intelligent and capable of displaying music, answering questions, setting time and data, and other functions. It shares many of the same functions as Apple's Siri and Google's Assistant, but Amazon Alexa can be used in a smart home system not only to operate home appliances but also to monitor equipment from the comfort of house through IoT platform (Somesh *et al.*, 2020). Amazon Alexa echo dot speaker in Fig. 18 was used in this project. The operator was able to communicate with Alexa echo dot by using voice and give commands of switching on and off the pump instead of running and switch off or on the pump manually at any level.



Figure 18: Amazon Alexa echo dot speaker

(ii) Software Requirements

(a) Programming Language

C is a general-purpose, high-level language. It is used in many scientific programming situations; it forms (or is the basis for) the core of the modern languages Java and C++. It allows access to the bare bones of computer. Oram (2014) shows features of the C language for instance low-level memory access, a simple set of keywords, and a clean style which make C language suitable for system programming like an operating system or compiler development. In this system, C language was used.

(b) Arduino IDE

Figure 19 represents the logo of Arduino Integrated Development Environment or Arduino Software (IDE) is intended primarily for software development which contains a text editor for writing code, a message area, a text console, a toolbar with buttons for common functions and a series of menus. It connects to the Arduino and Genuino hardware to upload programs and communicate with them. This IDE is compatible with ESP 8266 module so ESP 8266 can be programmable through Arduino IDE interface (Grokhotkov, 2017).



Figure 19: Arduino IDE

(c) Alexa App

Alexa app is a companion of Amazon echo dot, tap and show for setup, remote control, and enhanced features. Amazon Echo is hands-free and voice-controlled, do not charging, and is mostly used at home to control home appliance connect with Alexa echo dot. Alexa is always ready to provide news updates, answer questions, create lists, and much more. The developed system was integrated with the Alexa app which its logo is presented in Fig. 20.



Figure 20: Alexa app

(d) ThinkSpeak Platform

Figure 21 represents ThingSpeak view. An Internet of Things (IoT) analytics platform allows collecting and storing sensor data in the cloud and developing IoT applications. The ThingSpeak service also enables to perform online analysis and act on data. Sensor data can be

sent to ThingSpeak from any hardware that can communicate using a Representational State Transfer Application Programming Interface (REST API) (Halvorsen, 2017). In the developed system, sensed data were analyzed and visualized through ThinkSpeak IoT analytics platform.



Figure 21: ThingSpeak IoT cloud

3.7 System Design

This section represents the system design such as system design view, block diagram, circuit diagram, use case diagram and flowchart diagram.

3.7.1 System Design View

Figure 22 shows the system design view which indicate how the components are interconnected together to provide a complete functioning system.

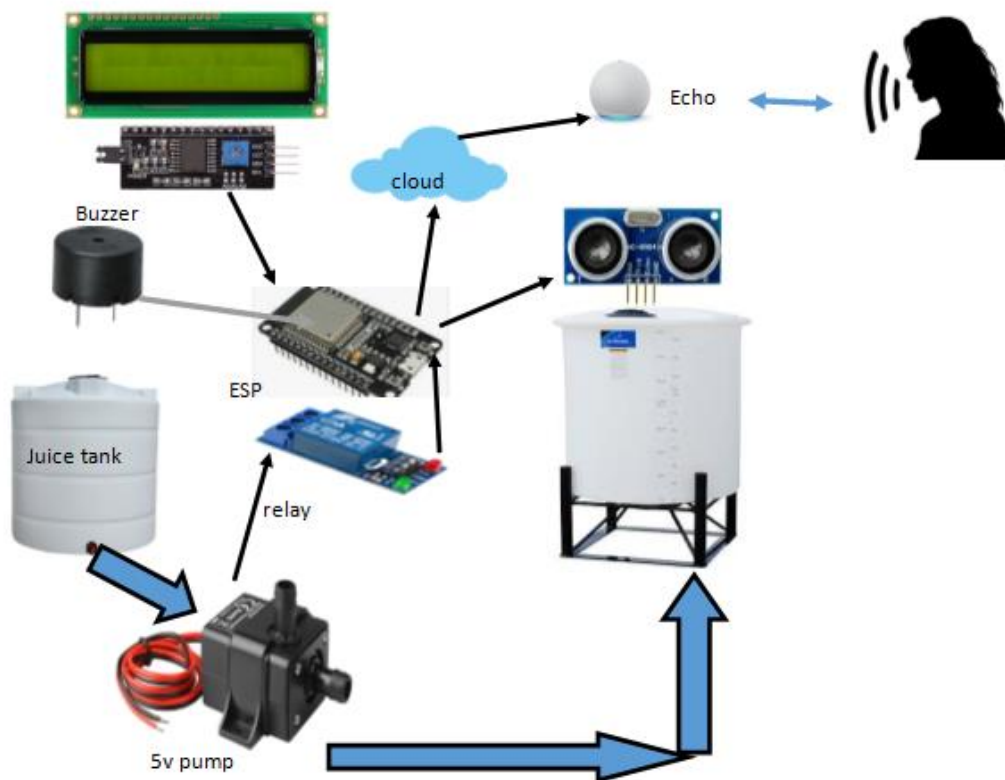

Figure 22: System design

The developed system is having 3 main parts that are sensing unit, processing unit and actuating unit.

(i) Sensing Unit

The ultrasonic HC-SR04 sensor detects the distance between the sensor and an object within its range. An ultrasonic sensor was utilized in the developed system to detect changes in the level of surface juice within the tank and to measure the distance between them. The sensor has a range of 2 cm to 4 m and runs at a frequency of 40 Hz, 5volts and 15 mA which are the working voltage and current respectively. The ultrasonic sensor sensed level of juice within the tank and sent the data to the processing unit to be processed.

(ii) Processing Unit

The node Mcu Esp 8266 open-source microcontroller served as the unit's sensing and actuating, communication between the two units in the processing unit. The node MCU is built on the ESP8266 Wi-Fi SoC, which does not require an external WiFi shield like Arduino uno. It also

features hardware based on the ESP-12 module. The sensing unit sends detected data to this processing unit for storage, processing, and analysis. After that, the data is transferred to the cloud, or the actuators receive direct orders on what to do, such as display the value of the sensed level, generate a buzzer.

(iii) Actuating Unit

This unit includes mechanisms for reacting to the surroundings in response to commands, such as a buzzer, an LCD display, and an Alexa voice controller. When the juice in the tanks reaches the threshold level, a buzzer was employed to alert the operator. It functions in the voltage range of 4 volts to 8 volts and has a resonance frequency of 2300 Hz. The level percentage of level tanks was displayed on a LCD display, which operates at a voltage of 4.7-5.3 volts with a current usage of 1 Ma, and displays it each time there is a change in level within the tank. A switch relay was used to turn on and off the pump. When the juice level reached a threshold level, the relay automatically turned off the pump to prevent it from overflowing. Relay runs within 12.6 volts - 27 volts. Alexa voice echo dot was used to communicate with operator.

3.7.2 Block Diagram

Figure 23 illustrates block diagram of a developed system.

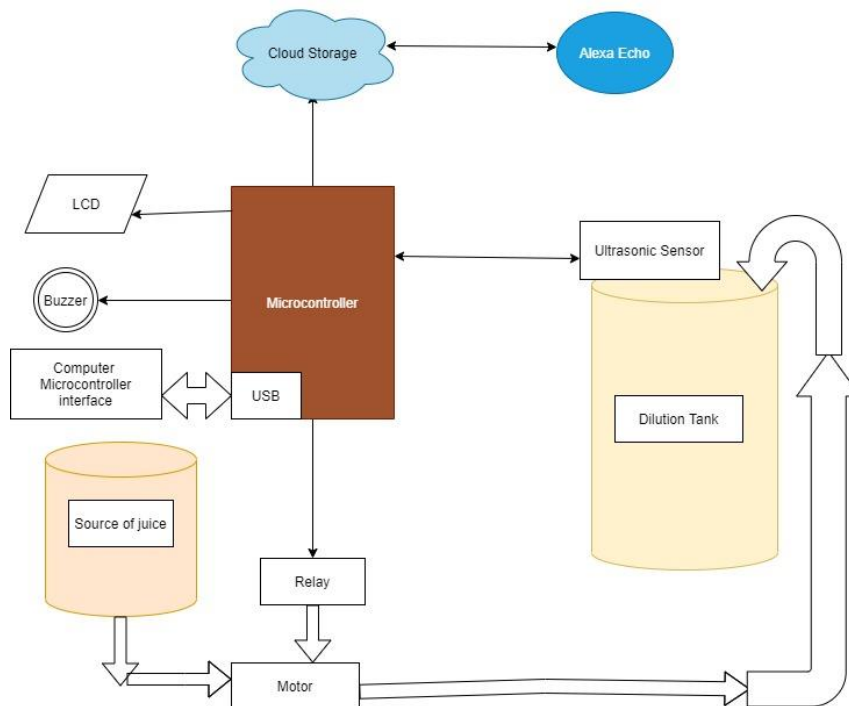

Figure 23: Block diagram of the developed system

3.7.3 Circuit Diagram

Figure 24 shows the circuit diagram of the developed system. The circuit diagram is a designed representation of how the system are electrically connected. The circuit diagram was designed by using Proteus design suite software. The Proteus design Suite is a proprietary software tool suite used mainly for electronic design automation. The ESP8266 12-E chip comes with 17 GPIO pins all pins are digital and some of these pins can act as input others as output pins or one can act as both input or output depending on the configuration. The ultrasonic sensor 5 volts, trig pin, echo pin ad ground pin is connected to VU, D3, D4 and ground pin of the board respectively, trig pin acts as output while the echo pin is set as an input pin. Buzzer is connected to D8 and ground and set as output pin as well. Relay switch data pin is connecting to D7 and is set as output pin. Relay is connected to the pump to control it either high or low. 16x2 LCD i2c module only 4 pins are connected to the ESP, SDA, SCL and ground pins are connected to D1, D2 and ground of the board respectively.

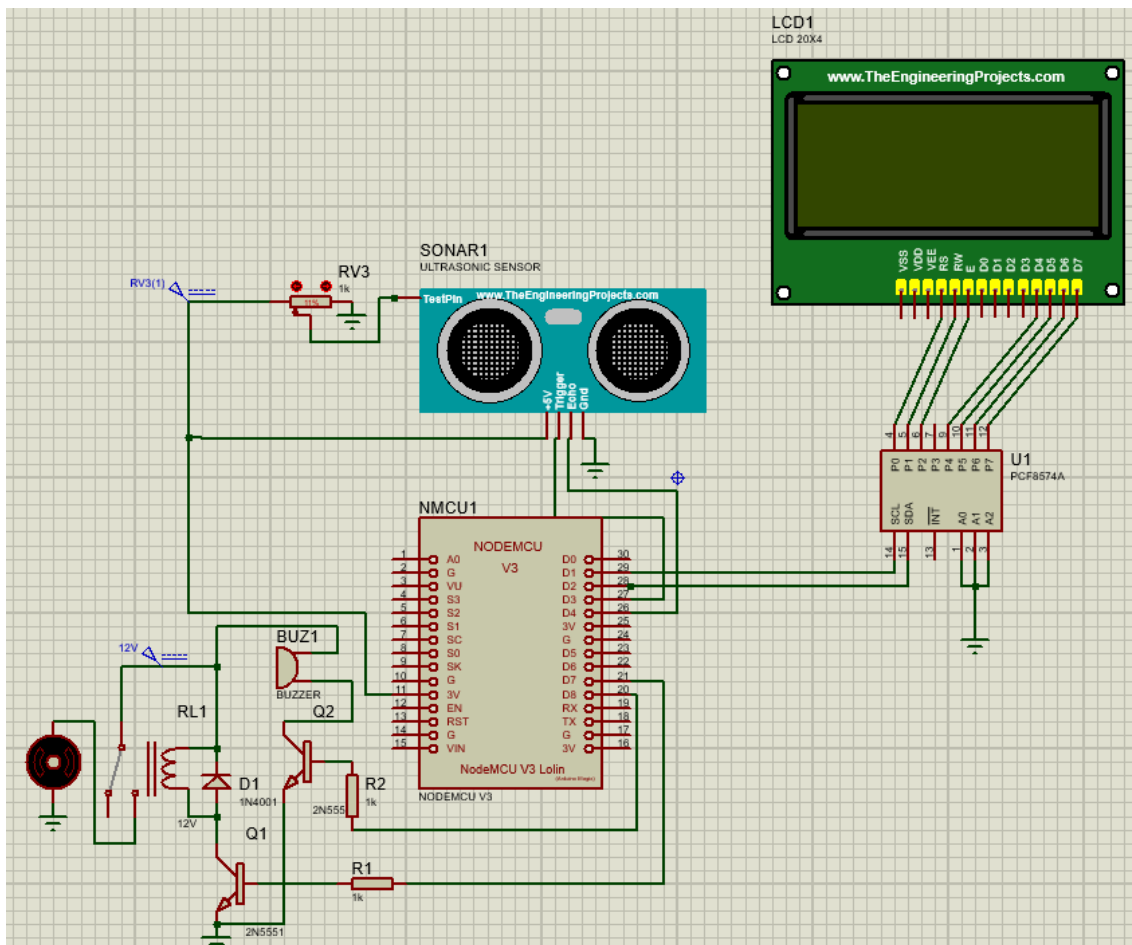

Figure 24: Circuit diagram designed in Proteus design suite

3.7.4 Use Case Diagram

Use case diagram is a graphical representation of how a user (Actors) might interact with a system. A use case diagram depicts the system's numerous activities and to possible users are assigned to those activities (Aleryani *et al.*, 2016). Figure 25 shows the use case diagram of the developed system which explains how the users work with the system and the role of each user.

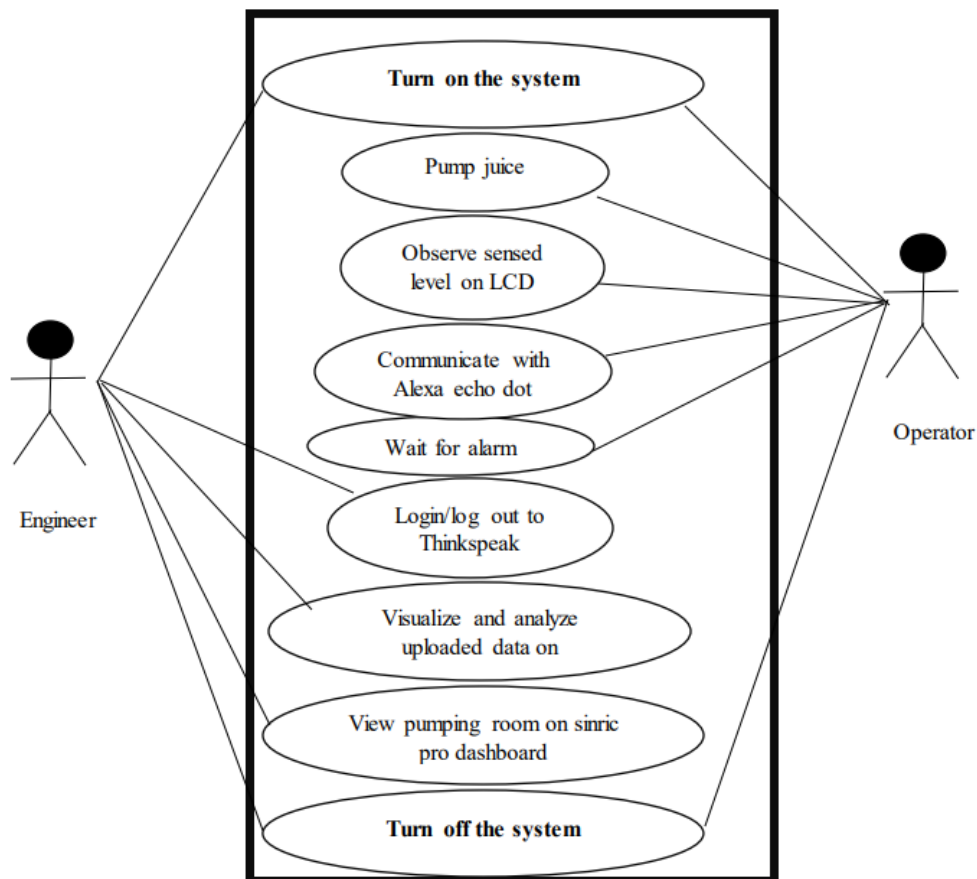

Figure 25: Use case diagram

3.7.5 Flowchart Diagram

The developed system's flowchart diagram (Fig. 26) explains the operations and activities that must be completed in each phase through sequential phases and links between activities. After the system was turned on, the sensors and actuators began to communicate with one another. The ultrasonic sensor continuously senses the juice level within the tank and sends data to the microcontroller for analysis and signal to the actuators to act. Once there is a rise in juice, the LCD keeps displaying the percentage of level. If the level reached 100%, the relay switch stopped the pump and a buzzer notified the operator that the pump is full. Furthermore, the

sensed data was sent to the cloud for further analysis and the system worked with Alexa echo dot to be able to receive the command from human voice and do what was suggested.

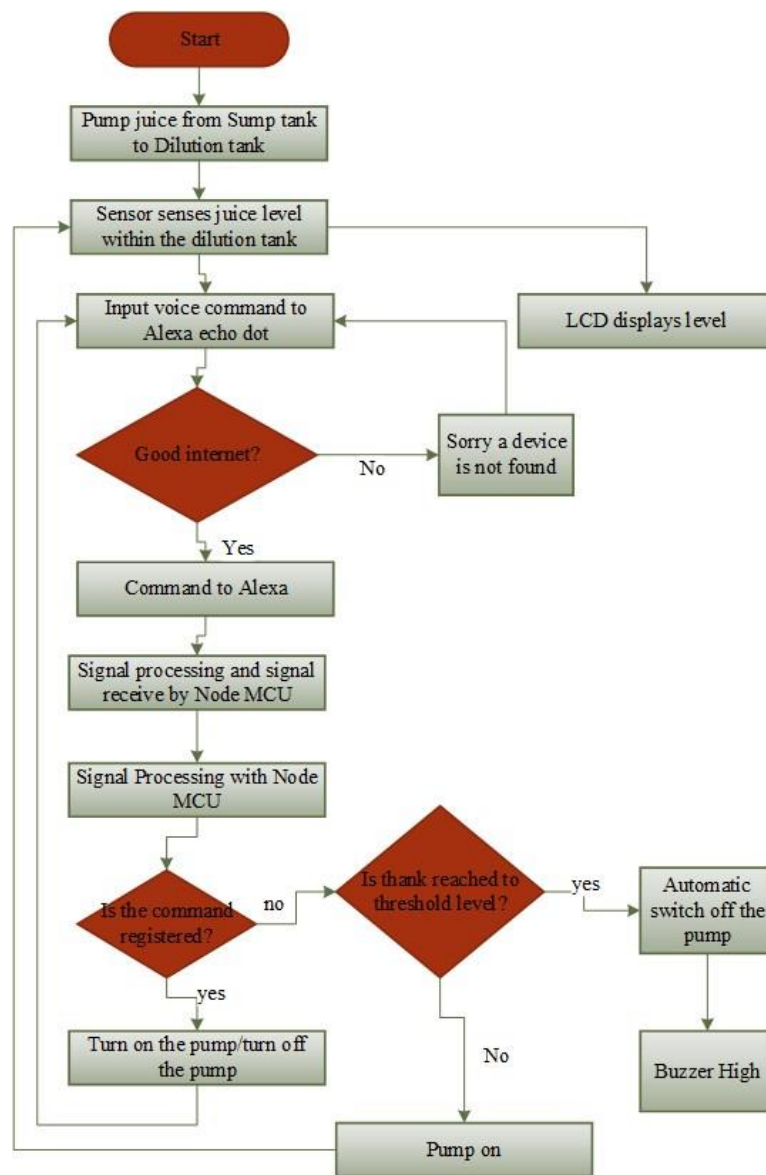

Figure 26: System flowchart

3.7.6 System Development

The system developed followed XP Agile methodology phase as follow:

(i) Planning

In this phase the duration was determined, analysis of requirements provided by the customer and the functionality the customer would like to see in the developed system.

(ii) Designing

The system was designed within manageable phases to make the system easy to understand after that small phase was combined. Design was made to different diagram such as system design, block diagram, circuit diagram and flowchart diagram. The results of designed system are shown in chapter four.

(iii) Coding

In this phase the coding was divided into manageable activities such as coding each component connected to microcontroller like ultrasonic sensor, relay, Liquid Crystal Display (LCD), buzzer and Alexa echo dot after that the code was integrated and work together.

(iv) Testing

Testing is a process of applying the developed system and code to the environment. According to Anand and Uddin (2019) a developer should never assume that there are no errors in developed system until tested and approved it, during testing the system was tested as unit, integrated, system and user acceptance testing.

(a) Unit Testing

Unit testing is process of testing each unit to check the functionality and remove the errors where noticed the purpose of unit testing is to sustain the project growth otherwise as time goes without testing a developer can reach to the point where he/she cannot proceed (Khorikov, 2020). In order to make sure that the unit test suites the quality some point was observed, for instance the unit tested was integrated to the developed system and check if the system provides minimum of test maintenance and maximum value.

The system was split and tested by each module whether it works effectively and meet user requirements, the errors were early identified and fixed before modules integration.

(b) Integration testing

The developed system was tested as a group, such as sensing and actuating units, until the combination of all groups was integrated as one and tested again as the overall interaction of all groups (Parmar, 2014). The goal of integration testing was to identify and correct errors that

occur when two units are combined, such as interface misuse and misunderstanding. The Bottom-up Integration technique was used in this integration testing (I&T).

(c) System Testing

Stakeholders to determine whether the developed system meets both functional requirements and non-functional requirements performed the entire system testing. Therefore, system testing was used to ensure that the developed system meets the user requirements (Gill, 2018).

(d) User Acceptance Testing

User acceptance testing concerns about validate, system testing was executed to the user environment to observe if the system meet the company requirements (House, 2017). A set of items was created and filled by operator and engineer to check that the developed system the requirements.

3.7.7 System Validation

The prototype was presented and tested to the company in order to confirm that the developed system fits the company's needs. It was tested in-house by pumping juice from one container to another, with one of the containers containing a level sensor to keep track of the change in juice level within the tank pumped from the other side. By delivering sensed data to the microcontroller, the ultrasonic sensor communicates with it. The data were continuously received by the microcontroller and sent to the cloud in real time. The Alexa app was wirelessly connected to the Alexa echo controller, which has access to the IoT Cloud, where the data was transferred. A set of requirements were provided to the operators and tick accordingly. The results were shown in Chapter 4.

3.7.8 System Implementation

After validating the system each party was up, running and able to keep an eye on the juice level within tank and overcome all challenges therefore the system was accepted. The developed solution met the company's requirements. The company will be involved in the system's implementation for future use.

CHAPTER FOUR

RESULTS AND DISCUSSION

4.1 Identified System Requirements

4.1.1 Functional Requirements

Functional requirements specify what the system does, how it should react to a specific input, and how it should operate in a specific environment. Smart tanks juice level monitoring system functional requirements are as shown in Table 2.

Table 2: Functional requirements of the developed system

S/N	Requirements	Descriptions
1	Monitor juice level within the tank.	The system should be able to monitor juice level within the tank by using ultrasonic sensor.
2	Display percentage of juice level within the tank on Liquid Crystal Display (LCD).	The Liquid Crystal Display (LCD) should continuously display juice level percentage within the tank.
3	Generate noise when juice reached to threshold level.	The system should generate noise when the juice level reached to threshold level or when juice level within the tank is low.
4	Visualize data through cloud.	The system should send data to the cloud to be visualized and daily analysis.
5	Communicate through Alexa echo dot.	The system should be switched off and on by voice.

4.1.2 Non-Functional Requirements

Non-functional requirements shown in Table 3 describes the quality of the system performance, usability of the system and effectiveness of entire developed system.

Table 3: Non function requirements of the developed system

No	Requirements	Descriptions
1	Power consumption	Low power consumption by switch off the system when the plant is not functioning.
2	Efficiency	The system will perform its tasks effectively.
3	Performance	The system will perform tasks without delay.
4	Security	Security of the system should be ensured by securing the system to the safe place.
5	Real time	The system should respond on time.
6	Flexibility	The system should be easy to use by an operator.

4.1.3 Observation and Level Measurement Results

The Table 4 shows the levels of container from 0% to 100% and their corresponding distance and liters based on ultrasonic sensor measurements.

Table 4: Length of container and its corresponding liters and percentage

Length	Number of liters	percentage
28 cm	0	0%
14 cm	7.5 liters	50%
7 cm	11 liters	75%
2 cm	14 liters	100%

Figure 27 shows how the level of a container was measured from where ultrasonic sensor is placed inside the container to the bottom of the container. The ultrasonic sensor measures the distance in between 2 cm to 400 cm. In this project prototype the ultrasonic sensor measured from 2 cm to 28 cm to prevent overflowing of juice and it was placed at the top of the container and continuously measuring the juice level within the tank, juice flowed from the tank 1 through pipe to the tank 2. Once the level of juice changed, it displayed percentage value on LCD. When juice reached to threshold level the relay automatically switched off the pump and buzzer generate a noise to notify that the tank is full. The sensed juice level percentage was updated to the cloud.



Figure 27: Length of the container for prototype

4.2 System Development Results

4.2.1 Result on Software Configuration

The sinric pro was used in this project to connect and control a relay device using an Amazon Alexa echo dot. Sinric pro is a new version of sinric. Sinric Pro is a library for connecting to IoT development, Arduino development boards with Alexa, and asking Alexa to discover devices (Thammineni, 2019). It is accessible on the Arduino Integrated Development Environment (IDE) and is compatible with ESP8266 to connect to third-party apps or Amazon Alexa and Google Home. The Application Programming Interface (API) was used to access account information, identify devices, update devices, and receive device logs.

Figure 28 and Fig. 29 show how the pump was configured to the sinric pro and connected with Alexa echo dot, if the pump is not connected physically. Sinric pro was shown as offline device else it was online.

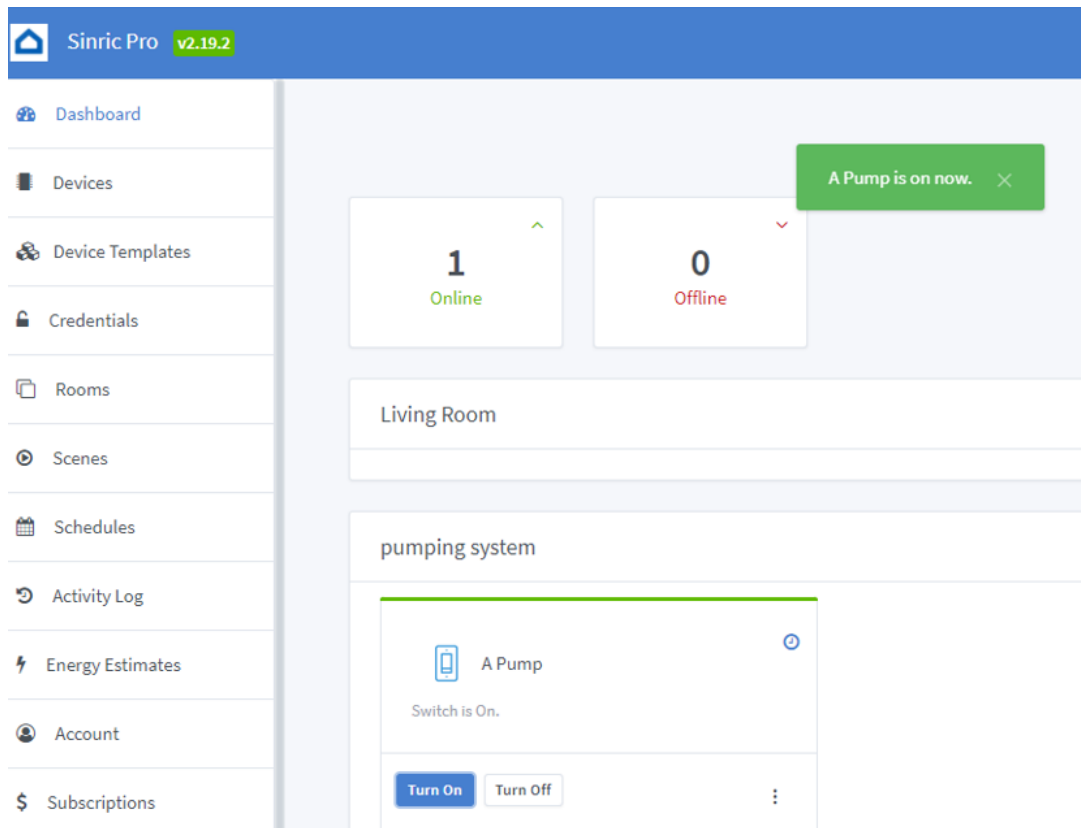

Figure 28: Pumping system in Sinric Pro

Each device has identification (ID) to be copied and pasted into the code to connect to physical pump for the system to recognize a device to work with once it is called.

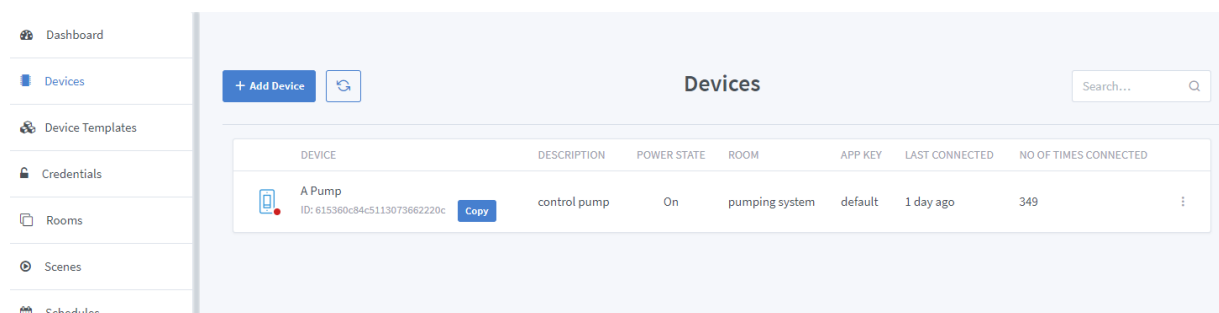

Figure 29: Device ID

After downloading Alexa app from app store there was a configuration of it and search for sinric pro and download. The pump system was connected to Alexa app as a plug that will be turned on and off. Login within sinric pro was done using the same account created before. The system was able to communicate each other and able to visualize room pumping system through phone. Figure 30 and Fig. 31 show how the sinric pro was discovered by Alexa app.

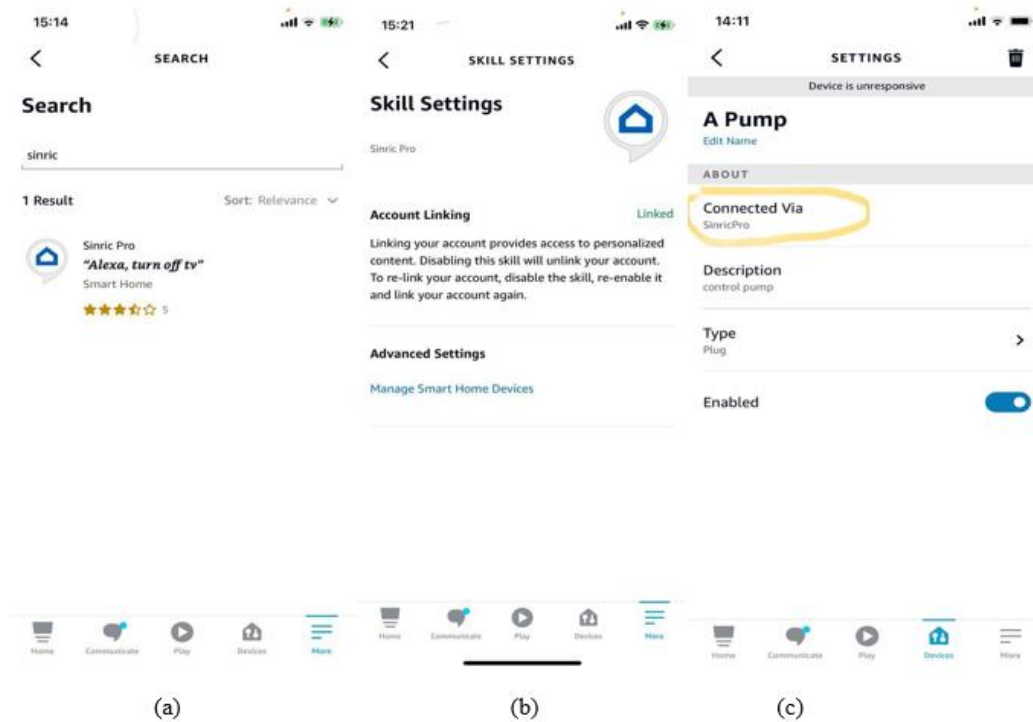

Figure 30: Search for Sinric Pro, Sinric Pro linked together, pump connected via Sinric Pro

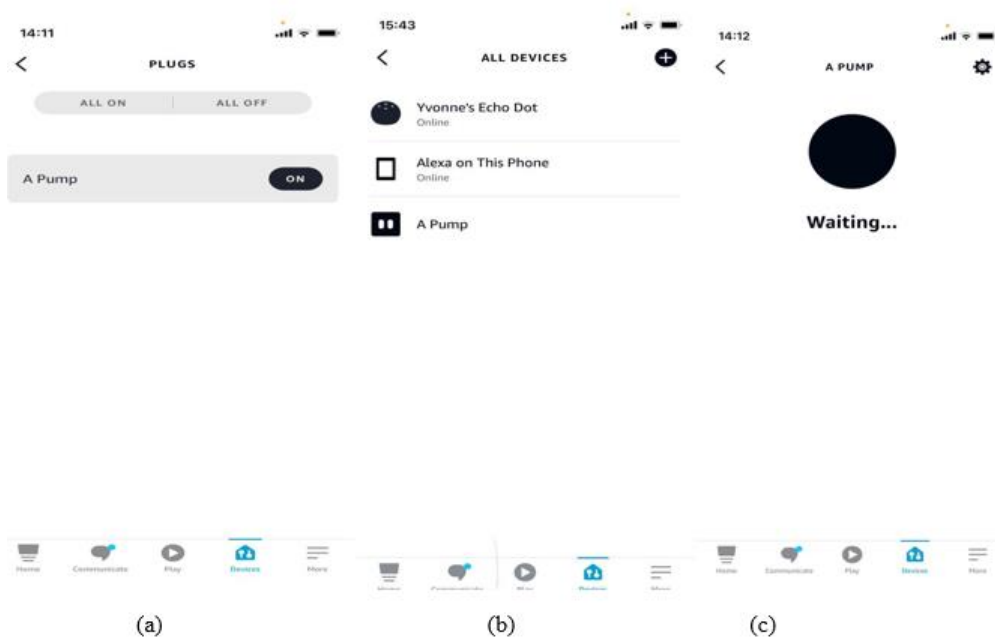

Figure 31: Configuration of pump, all devices discovered, connecting a pump

After configuration there was a coding part that appeared on Appendix 4 are the code of Alexa echo dot controlling a pump.

4.3 Unit Testing Results

This section explains the results of each unit and the code of integrated units which sends data to the ThinkSpeak are shown on Appendix 5.

4.3.1 Liquid Crystal Display I2C Testing Result

Liquid Crystal Display I2C was able to display the change of level within the container and display it in percentage at each rise of the juice. Figure 32 shows the random percentage displayed on LCD I2C after juice is raised and sensed by the ultrasonic sensor.



Figure 32: LCD displays percentage level of juice

4.3.2 Ultrasonic Sensor Testing Result

The ultrasonic sensor was sensing any level increased of juice within the tank and sent the percentage level to the ThinkSpeak at each change as it is shown in Fig. 33.

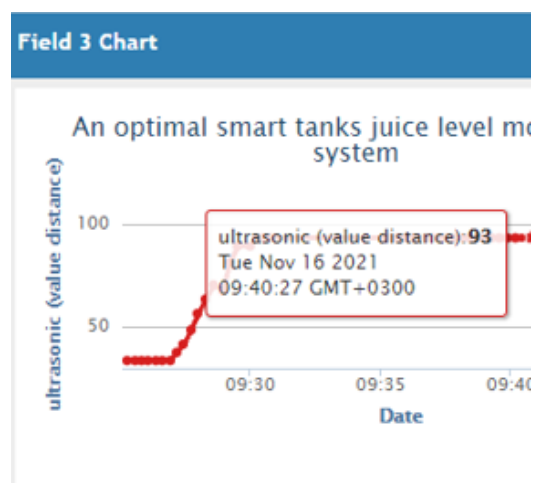

Figure 33: Visualizing ultrasonic sensed values

4.3.3 Buzzer Testing Result and Visualization

Figure 34 shows how buzzer data were sent to cloud. Buzzer was able to generate noise when the juice reached to threshold level. Threshold level which was 100% and at each time buzzer goes high it send data to ThinkSpeak. At each big dot means that buzzer is high.

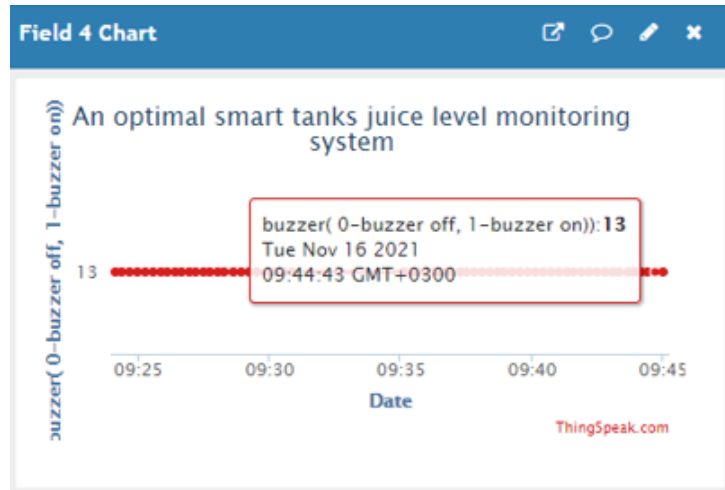

Figure 34: Visualizing buzzer

4.3.4 Alexa Echo Testing Result

Alexa echo dot was able to listen the voice command as shown in Fig. 35 and respond to it. At each blue light inside echo dot means that Alexa is listening to the operator and ready to execute what operator asked for incase it is available.

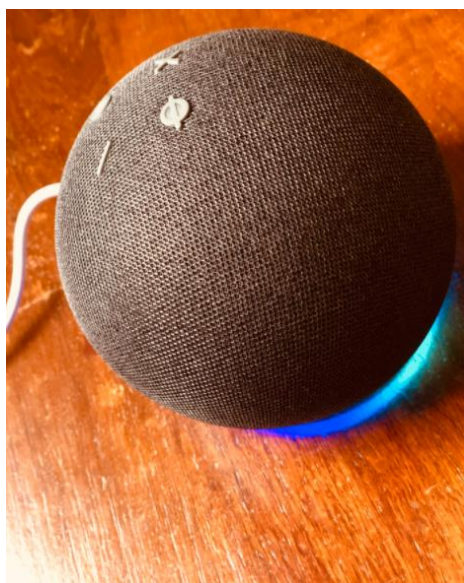

Figure 35: Communicating with Alexa echo dot speaker

4.4 Integration Testing Results

Units were integrated together and communicate each other; Appendix 6 are codes of the entire prototype. The data was sent to the cloud and the operator gives commands to the configured Alexa echo dot on what should happen to the pump either on or off. The system was able to sense juice level within the container, at each raise of level and display level on LCD, once an operator needs to switch off the pump before juice reaches to threshold level. The operator spoke to Alexa echo dot by saying “Alexa switches off a pump” a pump was automatically switched off and operator also was able to ask Alexa to switch on/off the pump by saying “Alexa switches on/off a Pump” a pump automatically switched on/off. Furthermore, the pump was automatically switched off, once juice reached to threshold level of 100 percent.

4.5 System Testing Results

The whole system was tested to review its functionality. Functional requirements were verified by checking how each unit components respond according to the company requirements. The Table 5 and Table 6 illustrate the requirements output results obtained from the system testing.

Table 5: Functional requirements testing results

S/N	System Functional Requirements	Output Results
1	Monitor juice level within the tank.	Pass
2	Display percentage of juice level within the tank on LCD.	Pass
3	Generate noise when juice reached to threshold level.	Pass
4	Visualize data through cloud.	Pass
5	Communicate through Alexa echo dot.	Pass

Table 6: Nonfunctional requirements testing results

S/N	System Non- Functional Requirements	Output Results
1	Power consumption	Pass
2	Efficiency	Pass
3	Performance	Pass
4	Security	Pass
5	Real time	Pass
6	Flexibility	Pass

Figure 36 shows how the components were communicating together before covering and move it to Printed Circuit Board (PCB) and was tested by pumping water.

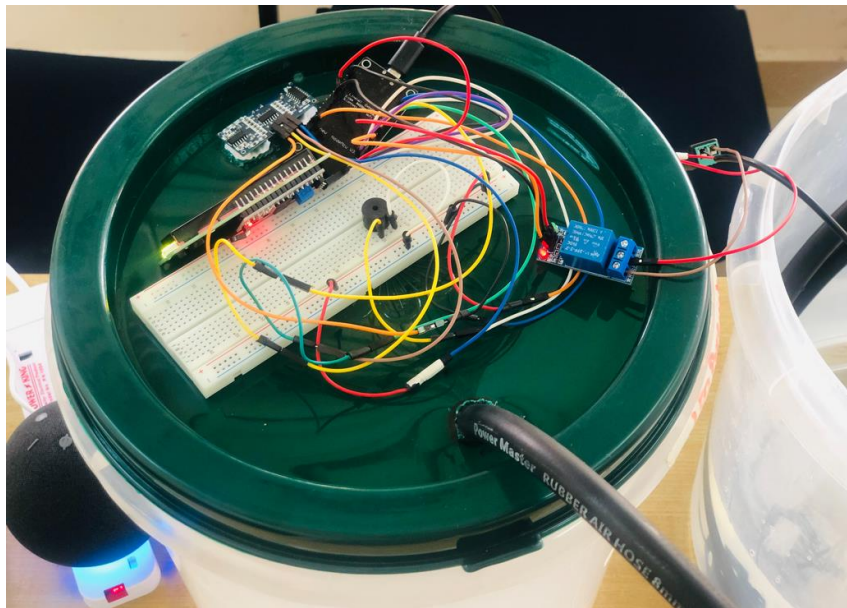

Figure 36: Developed system prototype

Table 7 shows how the state of the juice was displayed on LCD and at which level buzzer generated noise.

Table 7: Level state within tank

S/N	Percentage of level	State (juice within the tank)	Buzzer	Pump
1	0 %	Empty Tank	LOW	HIGH
2	50%	Half of Tank	LOW	HIGH
4	100%	Full	HIGH	LOW

4.6 System Validation Results

4.6.1 Developed System Validation to Users

The questionnaire was developed using Likert scale with five points (as shown in Appendix 2) to validate the developed system. The system was validated to end users from the RABEC using the developed questionnaire. The developed system was presented to 2 Engineers and 3 operators and scale the functionality of the system and if it was responded effectively. The system validation included hardware functionality, software functionality and the combination of all components that were communicating together to provide a working system. Figure 37

and Appendix 7 depict how Juice was pumped from one container to another and the Fig. 38 shows the feedback from the users. The users were either selected strongly agree, agree, neutral, disagree, or strongly disagree the feedback results shows that mean is 3.6,0.9,0.5,0 and 0 respectively. The results show that users strong agreed (with mean of 3.6) that the developed system met requirements.

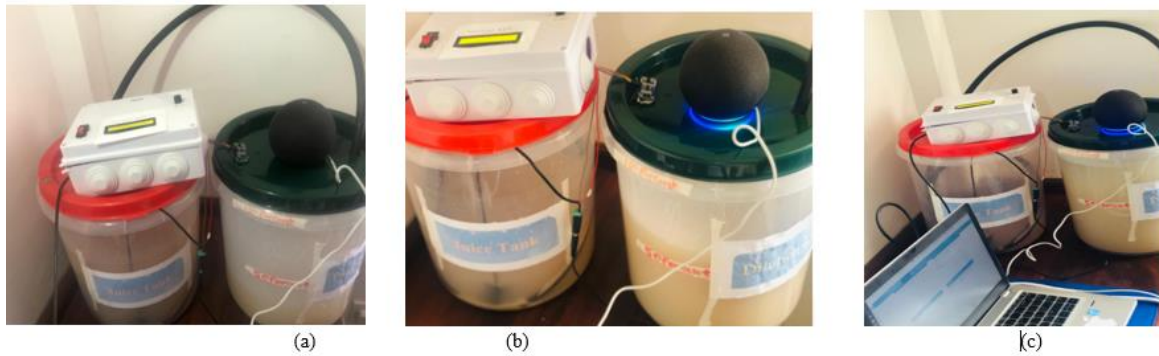

Figure 37: Final developed system prototype

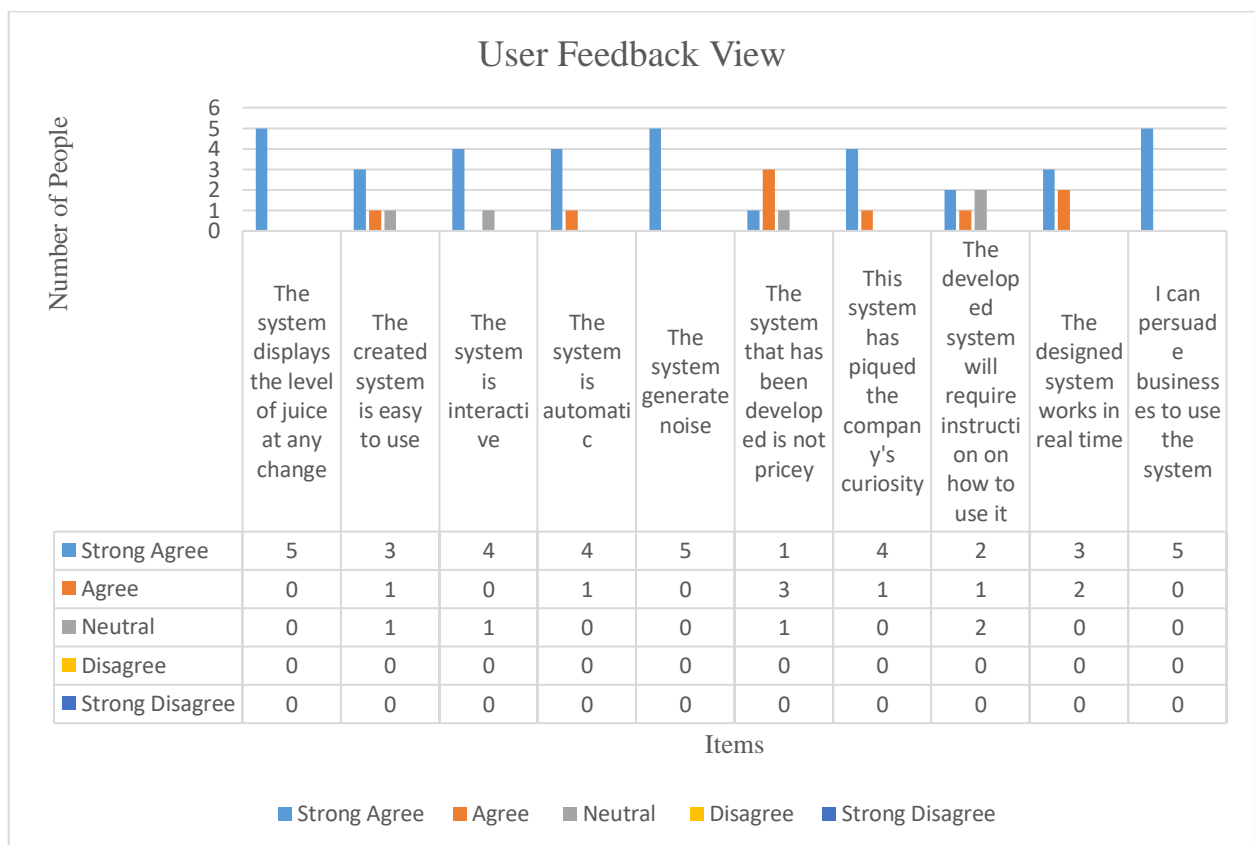

Figure 38: User feedback view

4.6.2 System Requirements Validation

Table 8 describes how the functional requirements were achieved.

Table 8: Requirement's verification

S/N	Requirements	System Verification
1	Monitor juice within the tank	Ultrasonic sensor was able to sense the raise of juice within the tank and communicate with a display.
2	Display the juice level within the tank on LCD	The system was able to display percentage level of juice sensed by ultrasonic sensor such as 10 percent to 100%
3	Generate noise	The system was able to generate noise when juice reached to threshold level.
4	Automatically switch off the pump	The system was able to switch off the pump through a relay module automatically when juice reached to threshold level.
5	Randomly switch off the pump	Anytime operator was able to switch off and on the pump through voice.

4.7 Discussion

The experiments conducted during developing a prototype show that the components can be communicate each other as shown on Fig. 36. Figure 28-31 show how the online pump was able to communicate with external pump and provides a real time control of pump during pumping process on the system as well as mobile app. Figure 32 shows how each change of level in tank sensed by ultrasonic sensor automatically displayed on Liquid Crystal Display (LCD). Figures 33 and 34 show how the data were automatically sent to the cloud for storage and remote visualization for each change in level within the tank. Alexa echo dot blinked at each time operator called Alexa which is shown on Fig. 35. Figure 38 shows how the users strongly appreciate the developed system.

The developed system is cost-effectively, interactive, does automatic pumping and a pump can be controlled by voice command within a long distance. All of these features make it unique once compared to existing systems. Chapter two shows the comparison of the previous developed systems, each existing system can perform only one feature but missed others. For instance (LLC, 2021) developed a system to monitor juice level within the tank which was interactive and provided data in real time. However, it is expensive, with the cost in between \$ 2000 to \$ 1000 while this developed system is in between \$ 600 to \$ 400.

CHAPTER FIVE

CONCLUSION AND RECOMMENDATIONS

5.1 Conclusion

Industry automation makes activities simple and reduce human involvement in processes. It also reduces human interference in industrial processes, raise awareness, and eliminate human error-related mishaps. The goal of this project was to improve the existing method of juice level monitoring in tanks and juice transfer from one process to another by switching from a manual to an automatic method. Manually monitoring juice within tanks can lead to accidents and human eye errors, resulting in spilling juice and a loss of corporate resources.

These problems can be overcome by implementing automated procedures in the beverage industry to automate the boiling part. During the pumping of juice, the developed system suggested that the juice level within the tank should be presented within 2 seconds. The outcomes of the built system show that the disadvantages of manual juice monitoring can be mitigated by using smart tanks juice level monitoring system that is automatic, interactive, and friendly, as well as operated by voice using Alexa echo dot.

After observing existing method of juice tanks level monitoring system and conducting interview on existing way of monitoring juice level in tanks and also review related works. The system requirements were gathered and it was presented in chapter three. The research question number (a) was answered by developing smart tanks juice level monitoring system that follows XP methodology of agile development approach which was presented in chapter three. Before developing the system, different design was made for instance system design. Research question number (b) was answered by obtaining user's feedback results that were present in chapter four and in Fig. 38.

The developed system finding is that it does automation in real time which prevents overflow of juice that normally caused by any human error during pumping process and respond in real time.

5.1.1 Limitation of the Study

Due to the limited resources and time the developed system has not covered all problems in boiling section. Other solutions will be implemented by the next intern. This developed system

only monitored juice level within the tanks and automatically switched off the pump once juice reached to threshold level and operator was able to control a pump by switching it off or on through Alexa echo dot.

5.2 Recommendations

5.2.1 Implications to Policymakers

The policymakers should encourage the beverage industries to implement the developed system to facilitate the control of juice tanks in real time. The policy makers can also come up with the strategies to automate at most processes in the beverages industries at affordable price which will simplify works, save time and resources of the beverage industries.

5.2.2 Implications to Practitioners

Practitioners can implement the developed system in their industries not only in beverage industries but also in other companies that need to monitor their tanks in proper way and in real time at low price. This project was aimed to minimize the human errors, which leads to accidents within the company in boiling section only, and the company still need some improvement in other to automate other sections.

5.2.3 Scientific Contribution

Technology used in the developed system makes it to be at affordable price which eliminate the barriers caused by the expensive systems that were designed and used in developed industries only.

5.2.4 Future Research

The developed system needs to be implemented from prototyping to real environment. Alexa echo dot can control a variety of devices in the industry, such as lights to save energy, in the future work more devices should be added in the system and be controlled by voice commands which will avoid different touching device that may cause diseases.

REFERENCES

- Abbas, S. K., Samad, S. T. A., & Khalifa, K. K. D. (2016). LPG Storage Tank and Pipe Line Report. *May*. <https://doi.org/10.13140/RG.2.1.4160.6000>
- Ahmed, M. E. A., & Jian, M. Z. (2013). Automatic Water Level Control System. *International Journal of Science and Research*, 4(12), 1505–1509.
- Al-Chalabi, S. M. M., & Al-Dhahiri, K. A. (2021). System Design for Measuring and Monitoring Fuel Consumption Remotely Using Embedded System. *Journal of Physics: Conference Series*, 1804(1), 012113.
- Al Dahoud, A., & Fezari, M. (2018). NodeMCU V3 for Fast IoT Application Development Lung Sounds analysis View project. *ResearchGate*, October, 1–14.
- Aleryani, A., Diagram, C., & Aleryani, A. Y. (2016). Comparative Study between Data Flow Diagram and Use Case Diagram Comparative Study between Data Flow Diagram and Use. *International Journal of Scientific and Research Publications*, 6(3), 124-126.
- Ali, B. A., Mihalca, V. O., & Cătălin, Ț. R. (2018). Automatic fuel tank monitoring, tracking & theft detection system. *MATEC Web of Conferences*, 184(02011), 1-4. EDP Sciences.
- Anand, A., & Uddin, A. (2019). Importance of Software Testing in the Process of Software Development Cloud Computing and Security View project Importance of Software Testing in the Process of Software Development. *International Journal for Scientific Research & Development*, 6(February), 2321–0613.
- Baldeon-Perez, C., Meneses-Claudio, B., & Delgado, A. (2021). Water Level Monitoring and Control System in Elevated Tanks to Prevent Water Leaks. *International Journal of Advanced Computer Science and Applications*, 12(2), 437–442.
- Barde, S., Pakhale, A., Kalbande, S., & Joshi, V. (2017). Fuel Level Monitoring System using GSM. *International Journal of Science Technology and Engineering*, 3(07), 83–86.
- Barrows, C., & Robinson, M. (2018). Food and Beverage. *Club Management*.
- Cañete, E., Chen, J., Martín, C., & Rubio, B. (2018). Smart winery: A real-time monitoring system for structural health and ullage in fino style wine casks. *Sensors*, 18(3), 1–15.

- Chang, J. I., & Lin, C. (2006). A study of storage tank accidents. *19*, 51–59.
- Chung, L., Nixon, B. A., Yu, E., & Mylopoulos, J. (2012). Non-functional requirements in software engineering. *Springer Science & Business Media*, *5*, 476.
- Jamison, C. (2019). A Study of Tank Overfill Incidents. *Purdue University*, 9–25.
- Cooperation, D. (1369). Tank overflow monitor. *Larsen Drive-OAK Ridge*, 37830. www.deltamcorp.com
- Costa, J. E. D., & Emanuel, A. W. R. (2020). IOT design monitoring water tank study case: Instituto profissional de canossa (IPDC). *AIP Conference Proceedings*, *2296* (1), 020028.
- Danole, S. A., Kulkarni, S., & Karav, S. (2020). Smart Tank Water Monitoring System using IOT. *International Journal of Scientific & Engineering Research*, *11*(6), 84–89.
- Devices, C. (2019). Buzzer Basics - Technologies , Tones. www.cuidevices.com
- Engineering, O. (2015). The Role of Flow and Level Transmitters and Pressure Transducers in the Monitoring of Juice Level in a Vessel.
- Gill, N. S. (2018). System Testing. <https://www.xenonstack.com/insights/what-is-system-testing>
- Grokhotkov, I. (2017). ESP8266 Arduino Core Documentation Release 2.4.0. 49–60.
- Halvorsen, H. P. (2017). Hans-Petter Halvorsen ThingSpeak. <http://halvorsen.blog>
- House, D. (2017). Introduction to User Acceptance Testing.
- Imran, B., Shakir, A. S. K. S., Pavethra, M., & Siva, S. K. (2018). Smart Tank Water Monitoring System using IOT Cloud Server at Home/Office. *International Journal of Engineering Science and Computing*, *8*(4), 16748–16751.
- Indoware. (2013). Ultrasonic Ranging Module HC - SR04. *Datasheet*, 1–4. <http://www.micropik.com/PDF/HCSR04.pdf>
- Khorikov, V. (2020). Unit Testing Principles, Practices, and Patterns. Simon and Schuster.
- Kunal, K., Azhar Hussain, M., Srinivasan, N., & Albert Mayan, J. (2019). Smart Irrigation and

- Tank Monitoring System. *IOP Conference Series: Materials Science and Engineering*, 590(1), 012035. <https://doi.org/10.1088/1757-899X/590/1/012035>
- Le, A. (2011). Liquid-Level Monitoring Using a Pressure Sensor. *Engineer N.Semiconductor*, 115.
- Leveson, N., Stringfellow, M., & Thomas, J. (2009). A Systems approach to accident analysis. *IT Technical Report*.
- LLC, B. (2021). Beverage Level Monitoring. <https://www.biz4intellia.com/beverages-level-monitoring-solution/>
- LLC, B. (2019). IoT Company “Biz4Intellia” Unveiled its Level Monitoring and Energy Monitoring Solutions.
- LLC, B. (2021). Real-Time Juice Level Monitoring Powered by Intellia IoT Business Solution. USA.
- Madhumitha, S. J., Supriya, S., Charanya, R., & Sudha, S. (2020). Survey on Automated Fluid Level Sensing and Controlling System Using IoT. *International Conference on Emerging Trends in Information Technology and Engineering*, 1–5. <https://doi.org/10.1109/ic-ETITE47903.2020.477>
- Marine, K. (2019). Intelligent Solutions For Automotive.
- Masetti, G., Marazzi, F., Di Cecilia, L., & Rovati, L. (2018). IOT-Based Measurement System for Wine Industry. *2018 Workshop on Metrology for Industry 4.0 and IoT, MetroInd 4.0 and IoT - Proceedings*, 163–168. <https://doi.org/10.1109/METROI4.2018.8428308>
- Melrose, L. J. (2003). Practical management of juice flow and levels using model predictive control. *Proceeding South Africa Sugarcane Technology Assotiation*, 77.
- Morris, J. (2005). Liquid level monitoring system. *I*(19).
- Ngollo. (2021). *Development of a mobile application system for Raha beverages company limited management communication at different levels*.
- Oram, E., & Naik, B. (2014). Lecture Note on Programming in C; Course Code: MCA 101. http://www.vssut.ac.in/lecture_notes/lecture1424354156.pdf

- Osore, E. A., & Eae, O. (2019). Characterization of Levels of Automation on the Quality of Sugar Cane Juice Extraction: Case of Kenya. *Journal of Automation and Control*, 7(1), 15–24. <https://doi.org/10.12691/automation-7-1-3>
- Pambudi, S. A. L., & Hujja, R. M. (2021). Ullage level monitoring model using sensors inside and outside the system in the fino-style winemaking aging process. *IOP Conference Series: Earth and Environmental Science*, 686(1), 012051. <https://doi.org/10.1088/1755-1315/686/1/012051>
- Parmar, K. (2014). Integration Testing Techniques. *SAP AG*, 1–15.
- Popescu, D., Borzan, A. I., & Băldean, D. L. (2020). Development of an Automated System for Fuel Tank Level Checking and Machinery Location Management to Optimize Remote Accessibility and Mobile Tracking. *Proceedings*, 63(1), 17.
- Richter, W. (2018). Non-invasive level measurement in bright beer tanks. *Brauwelt International*, 36(4), 264-266.
- Rosaline, S., Sheela, J. J. J., Hasmitha, M., & Rajitha, C. (2019). An Effective IoT based Fuel and Cost Monitoring System. *International Journal of Recent Technology and Engineering*, 8(3), 4080–4083. <https://doi.org/10.35940/ijrte.C5431.098319>
- Same, T. (2020). Recently Deployed Slurry Reservoir Level Monitoring Solution using IoT Intellia IoT Business Solutions. 1–5.
- Shetty, A. D. (2020). Automatic Water Level Indicator and Controller Using Arduino. *International Research Journal of Engineering and Technology*, May, 5342–5346. www.irjet.net
- Solution, U. (2021). Radar measurement for fruit juice production. Germany.
- Somesh, S., Senthilnathan, N., Sabarimuthu, M., Kumar, A. S., Rishikeshanan, R., & Bala, V. (2020). Real time Implementation of Home appliance control using ALEXA. *IOP Conference Series: Materials Science and Engineering*, 937(1), 012008. <https://doi.org/10.1088/1757-899X/937/1/012008>
- Sugar, I., Services, T., Drive, M., & Edgecombe, M. (2003). Merlose practical management of juice, 423–451.

- Suresh, N., Hashiyana, V., Kulula, V. P., & Thotappa, S. (2019). Smart Water Level Monitoring System for Farmers. I, *The IoT and the Next Revolutions Automating the World*, 213-228. <https://doi.org/10.4018/978-1-5225-9246-4.ch014>
- Thammineni, J. (2019). ISSN NO : 0377-9254 Voice based smart home automation using internet of things (IoT). *Journal of Engineering Sciences*, 10(9), 543–546.
- Thomas, A. (2020). Solar powered BLDC motor drive for agricultural application. *Journal of Electrical Engineering*, 1(1), 11–15.
- Twickenham. (2021). The underlying importance of smart tank level monitoring. <https://www.tankstoragemag.com/>.
- Water, T., & Powered, M. (2018). Real - Time Water level Monitoring Powered by Intellia IoT *Business Solutions Implemented in USA and Australia*. 1–5.
- Yazhini, N., & Maruthi, R. (2017). Survey on IoT Based Water Monitoring and Controlling System. *International Journal of Innovative Research in Science, Engineering and Technology*, 6(11), 466–474.

APPENDICES

Appendix 1: Interview Guide

SMART TANKS JUICE LEVEL MONITORING SYSTEM: A CASE STUDY OF RAHA BEVERAGES COMPANY LIMITED ARUSHA, TANZANIA

Section A: Opening Questions

1. Would you mind if we can conduct this interview in your office or you have an idea of another place which is more comfortable?
2. Can I know little about yourself and what is the name of your department?
3. How long have you been working in this company?4. Do you have any question for me before we continue with our interview?

Section B: Introductory Questions

4. How is your experience of working in this department??
5. What are the processes of transferring juice from boiling tanks to the fermentation tanks?
6. What kind of tanks do you use to store juice (for concentrated juice, dilute juice and juice ready for fermenting) and why?

Section C: Key Questions

7. How do you know that the level of juice reached to threshold level and it is time to switch off the pump?
8. How do you communicate on switching off/or the pump?
9. What are the consequences caused by this way of juice transfer?
10. How do you try to overcome these challenges?
11. Does the wine taste the same every day? If it's not what do you think are the causes?

Section D: Concluding Questions

12. Do you think Smart Tanks Juice Level Monitoring System can be used in your company?
13. What would be the benefits of using Smart Tanks Juice Level Monitoring System in your company?
14. Are there any important items that we missed in our discussion today?

Appendix 2: Questionnaire

Fill the following form by check (√) and rate yourself honestly based on real situation, given the existing system scenario using the following scales:

5- Always 4-Often 3-Sometimes 2-Rarely 1-Never

N°	Existing System	5	4	3	2	1
1.	Juice overflow during pumping					
2.	Accident happens when people are going to switch off the pump					
3.	The wine (final product) tastes the same after production					
4.	The communication the company is using during pumping juice from one room to another is efficient					
5.	Existing way of communication during pumping is enough					
6	There was a confusion between the noise of other machines and notification of switching off the pump					
7	To climb the tank is the way used to watch the level of juice within the tank					
8	During pumping juice requires special attention					
9	The company proposed another alternative way of communication during pumping instead of shouting					
10	More than 2 people involve in pumping process					

Appendix 3: System Validation Questionnaire

Features	Strong	Agree	Neutral	Disagree
	Agree			
	Respondents			
By increasing juice level monitoring within the tank, the produced system matched the company's needs				
The created system is easy to use				
The system that has been created is interactive From manual tank monitoring to smart juice level monitoring, the developed system evolved				
The created system will transition from manual juice transfer to automatic juice transfer				
The system that has been developed is not pricey				
This system has piqued the company's curiosity				
The developed system will require instruction on how to use it				
The designed method prevents hazard by working in real time				
I can persuade businesses to use the system				

Appendix 4: Code for Alexa voice controller

```
#ifndef ENABLE_DEBUG
    #define DEBUG_ESP_PORT Serial
    #define NODEBUG_WEBSOCKETS
    #define NDEBUB
#endif
#include <Arduino.h>
#include <ESP8266WiFi.h>
#include "SinricPro.h"
#include "SinricProSwitch.h"
#define WIFI_SSID    "ciscosb"
#define WIFI_PASS    ""
#define APP_KEY      "545e154a-6001-4ba4-a0db-4407d7c08daa"
#define APP_SECRET   "29076667-f117-4ce1-98fb-5f07b1b03e03-2828ac65-0541-4b77-
a484-a559cd41040c" // Should look like "5f36xxxx-x3x7-4x3x-xexe-e86724a9xxxx-
4c4axxxx-3x3x-x5xe-x9x3-333d65xxxxxx"
#define SWITCH_ID    "615360c84c5113073662220c" // Should look like
"5dc1564130xxxxxxxxxxxxxxxx"
#define BAUD_RATE    9600 // Change baudrate to your need
struct RelayInfo {
    String deviceId;
    String name;
    int pin;
};
// Pin where the relay is connected (D4 = GPIO 2 on ESP8266)
std::vector<RelayInfo> relays = {
    {"615360c84c5113073662220c", "Relay 1", D4}};
bool onPowerState(const String &deviceId, bool &state) {
    for (auto &relay : relays) { // for each relay configuration
        if (deviceId == relay.deviceId) { // check if deviceId
matches
            Serial.printf("Device %s turned %s\r\n", relay.name.c_str(), state ? "on" : "off"); // print
relay name and state to serial
```

```

    digitalWrite(relay.pin, state); // set state to digital pin /
gpio
    return true; // return with success true
    }}
return false; // if no relay configuration was found, return false
}
void setupRelayPins() {
    for (auto &relay: relays) { // for each relay configuration
        pinMode(relay.pin, OUTPUT); // set pinMode to OUTPUT
    }
}
void setupWiFi() {
    Serial.printf("\r\n[Wifi]: Connecting");
    WiFi.begin(WIFI_SSID, WIFI_PASS);
    while (WiFi.status() != WL_CONNECTED) {
        Serial.printf(".");
        delay (250);
    }
    Serial.printf("connected! \r\n[WiFi]: IP-Address is %s\r\n", WiFi.localIP().toString().c_str());
}
void setupSinricPro() {
    for (auto &relay : relays) { // for each relay configuration
        SinricProSwitch &mySwitch = SinricPro[relay.deviceId
        mySwitch.onPowerState(onPowerState); // attach onPowerState callback to the
new device
    }
    SinricPro.onConnected([]() { Serial.printf("Connected to SinricPro\r\n"); });
    SinricPro.onDisconnected([]() { Serial.printf("Disconnected from SinricPro\r\n"); });
    SinricPro.begin(APP_KEY, APP_SECRET);
}
void setup() {
    Serial.begin(BAUD_RATE);
    setupRelayPins();
    setupWiFi();
    setupSinricPro();
}

```

```
}  
void loop() {  
  SimricPro.handle();  
}
```

Appendix 5: Code for Sending Data to ThinkSpeak

```
#include<Wire.h>
#include <ESP8266WiFi.h>
#include<SPI.h>
#include<LiquidCrystal_I2C.h>
const int trigPin = 12;
const int echoPin = 14;
int const Buzzer = 13;
int const Motor = 2;
long duration;
float distance=0;
float percentage;
String apiKey="ZT4GT3YHOZ7K4DTQ";
const char *ssid ="ciscosb";
const char *pass ="";
const char *server = "api.thingspeak.com";
LiquidCrystal_I2C lcd(0x27,16,2);
WiFiClient client;
void setup()
{
  Serial.begin(9600);
  lcd.begin(); // Initializes the interface to the LCD screen
  Wire.begin(D2, D1);
  WiFi.begin(ssid,pass);
  while (WiFi.status() !=WL_CONNECTED)
  {
    delay(500);
    Serial.print("connecting");
  }
  Serial.println("");
  Serial.println("WiFi connected");
  delay(4000);
  lcd.backlight();
}
```

```

pinMode(trigPin, OUTPUT);
pinMode(echoPin, INPUT);
pinMode(Motor,OUTPUT);
pinMode(Buzzer,OUTPUT);
lcd.print("Juice level: ");
lcd.setCursor(0,1);
lcd.print("indicator");
delay(2000);
}
void loop()
{
  lcd.clear();
  digitalWrite(trigPin, LOW);
  delayMicroseconds(2);
  digitalWrite(trigPin, HIGH);
  delayMicroseconds(10);
  digitalWrite(trigPin, LOW);
  // Measure the response from the HC-SR04 Echo Pin
  duration = pulseIn(echoPin, HIGH);
  // Determine distance from duration
  distance = (duration*0.034) /2;
  percentage = map(distance, 28, 2, 0, 100); // Changes the distance to percentage
  lcd.clear();
  //lcd.setCursor(0,0);
  lcd.print("Level is: ");
  lcd.print(percentage);
  lcd.print("%");
  delay(2000);
  if (percentage>=100)
  {
    digitalWrite(Buzzer,HIGH);
    digitalWrite(Motor,HIGH);
    lcd.clear();
    lcd.setCursor(0,1);
  }
}

```



```

    lcd.print(" Full");
    delay(1000);
    digitalWrite(Buzzer,LOW);
    delay(2000);
}
else if (percentage ==50)
{
    digitalWrite(Motor,LOW);
    lcd.setCursor(0,1);
    lcd.print(" Half of Tank");
    digitalWrite(Buzzer,LOW);
    delay(2000);
}
else if (percentage <50 && percentage> 10)
{
    digitalWrite(Motor,LOW);
    lcd.setCursor(0,1);
    lcd.print(" below 50% ");
    digitalWrite(Buzzer,HIGH);
    delay(2000);
}
else
{
    digitalWrite(Motor,HIGH);
    lcd.setCursor(0,1);
    lcd.print(" Empty tank");
    digitalWrite(Buzzer,LOW);
    delay(2000);
}
if (client.connect(server,80)//api.thinkspeak.com
{
String postStr = apiKey;
postStr += "&field1=";
postStr +=String();

```

```
postStr += "&field2=";
postStr +=String(Motor);
postStr += "&field3=";
postStr +=String(percentage);
postStr += "&field4=";
postStr +=String(Buzzer);
postStr += "\r\n\r\n\r\n\r\n";
client.print("POST /update HTTP/1.1\n");
client.print("Host:api.thingspeak.com\n");
client.print("connection:close\n");
client.print("X-THINGSPEAKAPIKEY: " + apiKey + "\n");
client.print("content-Type: application/x-www-form-urlencoded\n");
client.print("Content-Length:");
client.print(postStr.length());
client.print("\n\n");
client.print(postStr);
}
client.stop();
}
```

Appendix 6: Code for Final Prototype

```
#include <SinricPro.h>
#ifdef ENABLE_DEBUG
    #define DEBUG_ESP_PORT Serial
    #define NODEBUG_WEBSOCKETS
    #define NDEBUG
#endif
#include <Arduino.h>
#include <Wire.h>
#include <SPI.h>
#include <LiquidCrystal_I2C.h>
#ifdef ESP8266
    #include <ESP8266WiFi.h>
#endif
#include "SinricPro.h"
#include "SinricProSwitch.h"
#define WIFI_SSID    "ciscob"
#define WIFI_PASS    ""
#define APP_KEY      "545e154a-6001-4ba4-a0db-4407d7c08daa"    // Should look like
"de0bxxxx-1x3x-4x3x-ax2x-5dabxxxxxxxx"
#define APP_SECRET   "29076667-f117-4ce1-98fb-5f07b1b03e03-2828ac65-0541-4b77-
a484-a559cd41040c"    // Should look like "5f36xxxx-x3x7-4x3x-xexe-e86724a9xxxx-
4c4axxxx-3x3x-x5xe-x9x3-333d65xxxxxx"
#define SWITCH_ID    "615360c84c5113073662220c"    // Should look like
"5dc1564130xxxxxxxxxxxxxxxx"
#define BAUD_RATE    9600    // Change baudrate
#define RELAY_PIN    const char *server = "api.thingspeak.com";
String apiKey="ZT4GT3YHOZ7K4DTQ";
bool onPowerState(const String &deviceId, bool &state) {
    digitalWrite(RELAY_PIN, state);    // set pin state
    return true; // request handled properly
}
void setupSinricPro()
```

```

{
  pinMode(RELAY_PIN, OUTPUT); // set relay-pin to output mode

  WiFi.begin(WIFI_SSID, WIFI_PASS); // start wifi

  SinricProSwitch& mySwitch = SinricPro[SWITCH_ID]; // create new switch device
  mySwitch.onPowerState(onPowerState); // apply onPowerState callback
  SinricPro.begin(APP_KEY, APP_SECRET); // start SinricPro
}

const int trigPin = 12;
const int echoPin = 14;
int const Buzzer = 13;
int const Motor = 2;
long duration;
float distance=0;
float percentage;
LiquidCrystal_I2C lcd(0x27,16,2);
WiFiClient client;
void handleUltrasonicsensor()
{
  lcd.clear();
  digitalWrite(trigPin, LOW);
  delayMicroseconds(2);
  digitalWrite(trigPin, HIGH);
  delayMicroseconds(10);
  digitalWrite(trigPin, LOW);
  duration = pulseIn(echoPin, HIGH);
  distance = (duration*0.034) /2;
  percentage = map(distance, 29, 2, 0, 100); // Changes the distance to percentage
  lcd.clear();
  lcd.setCursor(0,0);
  Serial.print("Level is: ");
  Serial.println(percentage);
  lcd.print("Level is: ");
}

```

```

lcd.print(percentage);
lcd.print("% ");
if (percentage>=100)
{
    digitalWrite(Buzzer,HIGH);
    delay(10);
    digitalWrite(RELAY_PIN,HIGH);
    lcd.clear();
    lcd.print("full");
    lcd.setCursor(0,1);
    delay(100);
    digitalWrite(Buzzer,LOW);
    Serial.print("Level is: full");
    SinricProSwitch& mySwitch = SinricPro[SWITCH_ID];
    mySwitch.onPowerState(onPowerState);
}
else if(percentage <100 && percentage>50)
{
    //digitalWrite(RELAY_PIN,LOW);
    lcd.setCursor(0,1);
    lcd.print(" above 50% ");
    digitalWrite(Buzzer,LOW);
}
else if(percentage==50)
{
    //digitalWrite(RELAY_PIN,LOW);
    lcd.setCursor(0,1);
    lcd.print(" half of tank");
    digitalWrite(Buzzer, LOW);
}
else if(percentage <50 && percentage> 10)
{
    //digitalWrite(RELAY_PIN,LOW);
    lcd.setCursor(0,1);

```

```

        lcd.print(" below 50% ");
        digitalWrite(Buzzer,LOW);
    }
    else
    {
        digitalWrite(RELAY_PIN,LOW);
        lcd.setCursor(0,1);
        lcd.print(" Empty tank");
        digitalWrite(Buzzer,LOW);
        delay(100);
    }
}

if (client.connect(server,80)//api.thingspeak.com
{
String postStr = apiKey;
postStr += "&field1=";
postStr +=String();
postStr += "&field2=";
postStr +=String(Motor);
postStr += "&field3=";
postStr +=String(percentage);
postStr += "&field4=";
postStr +=String(Buzzer);
postStr += "\r\n\r\n\r\n\r\n\r\n";
client.print("POST /update HTTP/1.1\n");
client.print("Host:api.thingspeak.com\n");
client.print("connection:close\n");
client.print("X-THINGSPEAKAPIKEY: " + apiKey + "\n");
client.print("content-Type: application/x-www-form-urlencoded\n");
client.print("content-Length:");
client.print(postStr.length());
client.print("\n\n");
client.print(postStr);
}
client.stop();

```

```

}
void setup()
{
  {
    pinMode(RELAY_PIN, OUTPUT);          // set relay-pin to output mode
    WiFi.begin(WIFI_SSID, WIFI_PASS);    // start wifi
    SinricProSwitch& mySwitch = SinricPro[SWITCH_ID]; // create new switch device
    mySwitch.onPowerState(onPowerState); // apply onPowerState callback
    SinricPro.begin(APP_KEY, APP_SECRET); // start SinricPro
  }
  Serial.begin(9600);
  lcd.begin(); // Initializes the interface to the LCD screen
  Wire.begin(D2, D1);
  lcd.backlight();
  pinMode(trigPin, OUTPUT);
  pinMode(echoPin, INPUT);
  pinMode(Buzzer,OUTPUT);
  pinMode(RELAY_PIN, OUTPUT);
  lcd.print("Juice level: ");
  lcd.setCursor(0,1);
  lcd.print("indicator");
}
void loop() {
  handleUltrasonicsensor();// handle Ultrasonic sensor commands
  SinricPro.handle(); // handle SinricPro commands
}

```

Appendix 7: Project Final Prototype



Figure 39: Final Prototype

Appendix 8: Research Outputs

PUBLICATION

Home / Archive / 2022-06 (Vol.11 No.03) / 10.5573/IEIESPC.2022.11.3.222

[XML](#) [PDF](#) [INFO](#) [REF](#)

IEIESPC(IEIE Transactions on Smart Processing and Computing)
IEIESPC Vol. 11, No. 03, p.222-230
ISSN (online) : 2287-5255
Received : 24 November 2021 Revised : 09 January 2022 Accepted : 02 March 2022
DOI : <https://doi.org/10.5573/IEIESPC.2022.11.3.222>

* Regular Paper

An Optimal Smart Tank Juice-level Monitoring System for Beverage Industries: A Case Study of Raha Beverages Company Limited, Arusha, Tanzania

IradukundaYvonne^{1*} MkobaElizabeth¹ MirauSilas¹

1. (School of Computational and Communication Science and Engineering, The Nelson Mandela African Institution of Science and Technology, Arusha, Tanzania {Iradukunday, elizabeth.mkoba, silas.mirau}@nm-aist.ac.tz)

* Corresponding Author: Yvonne Iradukunda, iradukunday@nm-aist.ac.tz

Copyright © The Institute of Electronics and Information Engineers(IEIE)
License : This is an Open-Access article distributed under the terms of the Creative Commons Attribution Non-Commercial License (<http://creativecommons.org/licenses/by-nc/3.0/>) which permits unrestricted non-commercial use, distribution, and reproduction in any medium, provided the original work is properly cited. (www.theieie.org).

[IEIESPC - IEIE Transactions on Smart Processing & Computing \(auric.kr\)](http://auric.kr)

Appendix 9: Poster Presentation



SMART TANKS JUICE LEVEL MONITORING SYSTEM: A CASE STUDY OF RAHA BEVERAGES COMPANY LIMITED IN ARUSHA, TANZANIA

Yvonne Iradukunda(Student), Dr Elizabeth Mkoba, Dr Silas Mirau (Supervisors)

iradukundav@nm-aist.ac.tz, silas.mirau@nm-aist.ac.tz, elizabeth.mkoba@nm-aist.ac.tz

Abstract

Poor monitoring of tanks is among of the challenges that the local beverage industries are facing during liquid pumping from one tank to fermentation tank. This issue leads to spilling fluids, tampered wine tests, and industrial accidents. Tanzania is an East Africa Country(EAC) which has developing beverages industries that are facing with these problems. the purpose of this project is to develop a system that will be able to monitor juice level within the tanks and regulate the pump using voice commands through Alexa Echo Dot. This technology eliminates the need to climb tanks to check their levels, which can lead to accidents, and ensures that the liquids levels of the tank are properly measured as well as prevent overflowing. Existing way, however, are manual methodologies, on the other hand, are not interactive and are costly. The designed technology also caters to the physically impaired, allowing them to engage in tank monitoring without difficulties. The system was created for Raha Beverage Company Limited(RABEC) located in Arusha, Tanzania, and it was successful in preventing the issues described

Objectives

The Main Objective is to design smart tanks juice level monitoring system

Specific Objectives

- 1.To identify system requirements for developing smart tanks juice level monitoring system
- 2.To design and develop smart tanks juice level monitoring system
- 3.To validate and implement the developed system

Literature Review

Existing way of juice monitoring in beverages industries is by manual and the existing systems have been implemented abroad

Level monitoring solution developed by Biz4Intellia LLC (2021) allows the observer to monitor the level of juice in multiple 30 - 45 feet large tanks/tankers in real-time and receive notifications when the level of juice reaches a threshold level. The system also measured the temperature of juice stored within tank, it uses a wireless ultrasonic sensor to measure the amount of juice in the tank, this eliminating the need to manually climb the tank to check the level. The system costs 1000\$-2000\$ which made it expensive that can't be affordable by small scale industries.

The Fig.1 shows overflowing as one of the challenge that occurs once juice level is not well monitored within the tank and once the raise of juice is improper tracked during juice transfer from one tank to another. The proposed system is a solution to that challenge.



figure 1: Overflowing of juice

System hardware requirements

Node MCU
container
pipe
Level Sensor
Buzzer
Relay
16x2 LCD I2C module
DC Pump
Echo Speaker

Diagram Block

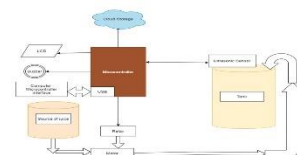

Figure 2: block diagram

System design Prototype



Figure 3: Prototype

Ultrasonic sensor sensed level of liquid within the tank and led display the percentage level at each raise of juice, once juice hit a threshold level the pump automatically switched off. Furthermore the pump was switched off or on by an operator through alexa echo dot by voice commands.

The juice was pumped from one tank to another and the system was installed on the tank and keep monitoring the level of juice within the tank as shown in Fig. 4



Figure 4: Final prototype

Conclusion

Industry automation makes activities simple and reduce human involvement in processes. Reduce human interference in industrial processes, raise awareness, and eliminate human error-related mishaps.

These problems can be overcome by implementing automated procedures in the beverage industry to automate the boiling part. During the pumping of juice, the designed system suggests that the juice level within the tank should be presented within 2 seconds. The outcomes of the built system show that the disadvantages of manual juice monitoring can be mitigated by using an optimal smart tanks juice level monitoring system that is automatic, interactive, and friendly, as well as operated by voice using Alexa Amazon Echo

references

- LLC, B. (n.d.). *Beverage Level Monitoring*. 7380 W Sand Lake Rd #500, Orlando, FL 32819, USA. <https://www.biz4intellia.com/beverages-level-monitoring-solution/>
- LLC, B. (2019). *IoT Company "Biz4Intellia" Unveiled its Level Monitoring and Energy Monitoring Solutions*.
- LLC, B. (2021). *Real-Time Juice Level Monitoring Powered by Intellia IoT Business Solution*. USA.

Control your industry appliances through Alexa echo dot