

BIOANALYTICAL APPLICATIONS OF IMMOBILIZED
" ANTIBODIES AND ENZYMES

by

Tina L. Hendrickson
B.S., University of South Dakota, 1987

Submitted to the Department of Chemistry and
the Faculty of the Graduate School of the
University of Kansas in partial fulfillment
of the requirements for the degree of
Doctor of Philosophy

MAY 16 1993

ABSTRACT

Novel methods for the preparation monoclonal antibodies to highly structurally conserved biologically active peptides have been developed. The two methods involve the use of a non-immunogenic protein carrier and targeting the antigen to T- and B-cells. Leucine-enkephalin was coupled to the Purified Protein Derivative of tuberculin (PPD). PPD stimulates an immune response against the enkephalins, while producing virtually no response against itself. It was demonstrated that when mice were immunized with the leucine-enkephalin-PPD conjugate, only 4% of the colonies recognized PPD. It was shown that the use of Hamster x Mouse CD3 (anti-T-cell) and Goat x Mouse Ig (anti-B-cell) resulted in a greater number of mice with specific serum titers, also immunization schedules were reduced to only four months, compared to over one year for conventional immunizations.

A significant disadvantage in the existing methods of analysis of the enkephalins is the tedious, time consuming, low recovery sample pretreatment step. Two leucine-enkephalin specific antibodies, 33FC6 and LE4H8 were selected for use in the immunoaffinity chromatography clean-up of the enkephalins in plasma because of their moderate binding affinity ($\sim 2 \times 10^7 \text{ M}^{-1}$) and different epitopes. The epitopes were defined by

screening against several analogs which demonstrated that the two antibodies bind to the C- and N-terminal regions, respectively. Plasma was loaded onto the immunoaffinity column and eluted with low pH buffer. The eluate was derivatized with naphthalene-2,3-dicarboxaldehyde in the presence of cyanide ion and the enkephalins were separated using reverse phase liquid chromatography. The limit of detection was 30 pmole. The recovery of the enkephalins from plasma was 90%. The immunoaffinity column was used for approximately 70 samples without any deterioration in performance.

An improved method for the analysis of lipoproteins includes the separation via size exclusion chromatography and an immobilized enzyme column. Cholesterol esterase and cholesterol oxidase convert cholesterol to H_2O_2 which is measured amperometrically. The method gave reproducible results, but because of poor peak resolution, quantitation of the cholesterol was difficult. The cholesterol values found by this method were not within the target range set by the Center for Disease Control.

ACKNOWLEDGEMENTS

It is impossible to accomplish any goal in life, alone. A great many people have given me the much appreciated support that was needed in completing this dissertation.

I would like to thank George Wilson for his supervision and ever constant belief in my ability as a scientist. He taught me the very important lesson of independent thinking. Let us not forget the ever popular *Wilson Law* and I quote "assume the [purchase order, equipment, etc.] is screwed up, unless you know for certain otherwise."

I had the great pleasure of spending my first year at KU in Ralph Adams' lab. Although I was interested in neurochemistry, I had aspirations of studying organic chemistry. One of my former instructors had warned me that after working with Adams, I would have to study analytical chemistry. He was right. Thank you "Chief and the troops" for making me see the light.

The members of the Wilson group are not only colleagues, but great friends. A big thank you to the immunology group, Binodh, Chandrani, and Kamal. You were always ready to lend me a hand in what seemed like endless immunizations, ELISAs, and chromatograms. I will always remember the afternoons of scientific

conversations and of course, more importantly, the conversations about "life".

I am grateful for the opportunity to intern at Hybritech, Inc. I would like to thank Drs. B. McCormack and B. Wolfert, R. Liu, B. Carlisle, J. Frazer, and J. Whaley for their assistance in the production of monoclonal antibody LE4H8.

I would like to thank the National Institutes of Health, the Center for Bioanalytical Research, and the Procter and Gamble Company for their financial support.

I hope this dissertation proves to my family that my 20 years of schooling has taught my more than how to make a good strawberry daiquiri. It has been a good many years since you sent me off to school for the first, second, and third time. Thank you for your love and support.

And finally, to my wonderful husband, Howard, who never guessed our honeymoon would turn into my dissertation. Thank you so much for all the smiles, meals, words of encouragement, and love that you have given me over the past few months. I couldn't have done it without you.

TABLE OF CONTENTS

CHAPTER ONE - GENERATION OF MONOCLONAL ANTIBODIES AGAINST LEUCINE ENKEPHALIN	1
INTRODUCTION	2
Brief History of the Opioid Peptides	2
Enhanced Methods in the Production of Peptide Antibodies	8
Immunization	8
Cell Fusion	13
ENHANCED IMMUNIZATION METHODS	18
Experimental	18
Preparation of Buffers	18
Preparation of Immunogens	18
Immunogen 1	18
Immunogen 2	18
Immunogen 3	20
Immunization	20
Preparation of BSA-Enkephalin Conjugate	20
Cell Fusion	23
Fusion 1	23
Fusions 2 and 3	23
ELISA for Enkephalin Specific	
Antibody	24
ELISA 1	24
ELISA 2	24

Purification of Antibodies	25
Results and Discussion	26
PPD as a Protein Carrier	26
Anti T- and B-cell Antibodies as Protein Carriers	26
Serological response	26
Fusions	31
AVIDIN-BIOTIN BRIDGED FUSION	33
Experimental	33
Immunization	33
Standard Fusion	33
Bridged Fusion	33
Biotinylation of Myeloma Cells .	33
Preparation of Spleen Cells for Bridged Fusion	35
Fusion	35
ELISA for Avidin Specific Antibody . .	35
Results and Discussion	37
ANTIBODY BRIDGED FUSION	45
Experimental	45
Preparation of Immunogen	45
P3X63Ag8.653 Antibodies	45
Immunizations	45
Cell Fusion for P3X63Ag8.653 Antibodies	48

ELISA for P3X63Ag8.653 Specific Antibodies	48
Purification of Antibodies	48
Determination of Apparent Affinity Constant	49
Conjugation of KLH to P31E6	50
Standard Fusion for KLH Antibodies . .	51
Bridged Cell Fusion for KLH Antibodies	51
Preparation of Myeloma Cells . .	51
Fusion	51
Elisa for KLH Specific Antibodies . .	52
Results and Discussion	52
P3X63Ag8.653 Antibodies	52
KLH Antibodies	54
FUTURE DIRECTIONS	60
Enhanced Immunization Methods	60
Bridged Fusions	61
 CHAPTER TWO - IMMUNOAFFINITY CHROMATOGRAPHY OF LEUCINE ENKEPHALIN	 64
INTRODUCTION	65
EXPERIMENTAL	75
Characterization of Antibodies	75
Sub-isotyping	75
Cross Reactivity	75
Competition ELISA	75

Determination of Apparent Affinity Constant	75
Preparation of the Immunoaffinity Column	76
Clean-up Procedures	76
Solid Phase Extraction	76
Immunoaffinity Chromatography	77
Derivatization Procedure	79
Liquid Chromatography	81
RESULTS AND DISCUSSION	82
Characterization of Antibodies	82
Determination of Apparent Affinity Constant	91
Clean-up Procedures	95
Solid Phase Extraction	96
Immunoaffinity Chromatography	100
FUTURE DIRECTIONS	111
CHAPTER THREE - DETERMINATION OF CHOLESTEROL AND ITS DISTRIBUTION IN HUMAN PLASMA	112
INTRODUCTION	113
EXPERIMENTAL	125
Standard Solutions	126
Immobilized Enzyme Reactor	126
Reactor 1	126
Reactor 2	127
Size Exclusion Chromatography	127

RESULTS AND DISCUSSION	130
Optimum Conditions for Lipoprotein Separation and Enzymatic Reaction	130
Comparison of Enzyme Reactors	132
Quantitation and Validation of Lipoprotein Cholesterol	133
FUTURE DIRECTIONS	141
REFERENCES	142

CHAPTER ONE
GENERATION OF MONOCLONAL ANTIBODIES AGAINST
LEUCINE ENKEPHALIN

INTRODUCTION

Brief Review of the Opioid Peptides.

Leucine- and methionine-enkephalin (leu-enk and met-enk respectively) belong to the family of neuroactive peptides known as the opioid peptides. There are numerous peptides in this family, but the best known are the enkephalins and β -endorphin. The name enkephalin comes from Greek meaning, "in the head". Endorphin is a combination of the words endogenous and morphine. Sequences of a few of the opioid peptides and the precursor proteins from which they are derived are shown in Table 1.1. It can be seen that the opioids possess many common amino acids. The sequence of the enkephalins is conserved throughout both vertebrate and invertebrate species.

The opioid peptides exhibit similar effects on the body as the plant-derived opioids. Although it had been known for a long time that plant derived opioids (such as opium, morphine, or heroin) produced euphoric and analgesic effects, it wasn't until 1971 that the receptors were discovered (Goldstein, et al., 1971). It seemed unlikely that these receptors were developed to interact with such exogenous opioids. Two groups reported discovery of an endogenous ligand, enkephalin, for these receptors (Hughes, 1975; Terenius and

Table 1.1
Sequences of Several Opioid Peptides

Precursor	Peptide	Sequence
Pro enkephalin	Met- enkephalin	<u>Tyr-Gly-Gly-Phe-Met</u>
	Leu- enkephalin	<u>Tyr-Gly-Gly-Phe-Leu</u>
POMC*	α - Endorphin	<u>Tyr-Gly-Gly-Phe-Met</u> -Thr-Ser-Glu-Lys-Ser- Gln-Thr-Pro-Leu-Val-Thr
	β - Endorphin	<u>Tyr-Gly-Gly-Phe-Met</u> -Thr-Ser-Glu-Lys-Ser- Gln-Thr-Pro-Leu-Val-Thr-Leu-Phe-Lys-Asn- Ala-Ile-Ile-Lys-Asn-Ala-Tyr-Lys-Lys-Gly-Gln
	γ - Endorphin	<u>Tyr-Gly-Gly-Phe-Met</u> -Thr-Ser-Glu-Lys-Ser- Gln-Thr-Pro-Leu-Val-Thr-Leu-
Pro dynorphin	Dynorphin A (1-17)	<u>Tyr-Gly-Gly-Phe-Leu</u> -Arg-Lys-Ileu-Arg-Pro- Lys-Leu-Lys-Trp-Asp-Asn-Glu
	Dynorphin B	<u>Tyr-Gly-Gly-Phe-Leu</u> -Arg-Arg-Gly-Phe-Lys- Val-Val-Thr
	Dynorphin (1-8)	<u>Tyr-Gly-Gly-Phe-Leu</u> -Arg-Arg-Ileu

*POMC = Proopiomelanocortin

Wahlstrom, 1975). Later the purification and sequence of the enkephalins were described (Hughes J, *et al.*, 1975a; Hughes, *et al.*, 1975b).

The amount of research conducted in the area of opioid peptides over the last twenty years has been tremendous. The results of this research have been fascinating as well as mysterious. The opioid peptides have numerous functions, many of which are not well established. Each year the literature describes new possible roles of the opioids in various disease states. Not only are the actions of the opioids complex, the terminology as well, has been a source of confusion. Words such as opiate, endorphin, and opioid have been used by many research groups to describe the same or even different members in this class of compounds. This text will use "opioid" to describe natural as well as synthetic drugs or peptides. There has been extensive literature on the opioids since their discovery. The following is a brief overview of the some of the ideas that are presented. The reader is referred to the review articles for more detailed information (Olson, *et al.*, 1979 - 1991).

The years 1975 through 1978 produced many papers on the discovery, characterization, distribution, and effects of the opioids (Olson, *et al.*, 1978). The

receptors were shown to be located in pathways associated with pain transmission in vertebrates. At that time it had not been shown that these receptors also existed in invertebrates. The opioids were found in the brain, pituitary gland, cerebrospinal fluid, and in blood. The concentration of met-enk, in the body, is higher than that of leu-enk because their precursor, proenkephalin, contains four copies of met-enk and only one of leu-enk (Cox, 1982). Effects of the opioids on analgesia, tolerance/dependence, learning and memory, and neurotransmission/neuromodulation have been studied. While much research was conducted in the early 1980's, little conclusive evidence was obtained. It was discovered that the opioids could not be used as analgesics because the body develops tolerance and dependence to the endogenous substances just as it does to morphine.

By the end of 1981 much of the research on the precursors, sequence, degradation, and analog development was completed. This work produced important conclusions about the active site of the opioid peptides. The tyrosine residue is necessary for opioid activity. The N-terminal residues of β -endorphin (met-enk) are necessary for analgesic activity, whereas the C-terminal residues confer potency. The enkephalins have weak

analgesic activity compared to β -endorphin. The reasons for this could be either higher susceptibility to enzymatic degradation or the opioid receptors have lower affinity for the enkephalins. The larger size of β -endorphin must protect it against enzymatic degradation, as well as, provide a second binding site to the receptor (Deakin, et al., 1980). If a residue outside the met-enk sequence of β -endorphin is deleted, immunoreactivity is decreased while opioid activity is retained. The opposite is true if a residue within the met-enk sequence is deleted.

The research after 1981 focused on the behavioral and physiological effects of the opioids (Olson, et al., 1982 - 1991). The publications of the last decade deal with clinical studies that are beyond the scope of this text. Research in this area is difficult because the opioids have multiple actions in different organs.

Along with the discovery of the opioid peptides, came the need for analytical methodology to detect picomole to femtomole quantities of peptide. Most proteins and peptides could be isolated only in the millimole to micromole range. Routine amino acid analysis had to be adapted to these low levels of peptides (Stein and Udenfriend, 1984). The level of

sensitivity needed in the analysis of the opioid peptides had never been achieved before.

The situation with the opioid peptides is further complicated by the fact that certain amino acid sequences are conserved throughout this peptide family and the high number of peptides in this family that are biologically active. The method of detection must be not only be sensitive, but must be able to distinguish between similar structures and sequences. The method must have molecular specificity.

Monoclonal antibodies have aided in the detection, localization, and purification of peptides. Monoclonal antibodies (moAbs), used in the correct format, possess the molecular specificity that is required for the analysis of peptides. The production of moAbs against peptides is a difficult task. Improved methods for the production of moAbs against leu-enk will be discussed in Chapter One. The use of moAbs for the determination of leu-enk will be discussed in Chapter Two. Leu-enk presents the typical challenges associated with the generation of moAbs to biologically active peptides and to their use in the analysis of those peptides. Leu-enk will be used as a model and the knowledge gained from the opioid peptides can be applied to other peptides.

Enhanced Methods in the Production of Peptide Antibodies.

Immunization. Stewart Sell (1987) defines an antigen as "A substance that induces an immune response. A *complete* antigen both induces an immune response and reacts with the products of the response. An *incomplete* antigen (hapten) cannot induce an immune response by itself but can react with the products of an immune response. Incomplete antigens induce an immune response when complexed to a complete antigen (carrier)." He also defines an immunogen as "A complete antigen; an antigen that can both induce an immune response and react with the antibodies of T cell elicited."

It is difficult to generate antibodies against peptides, because peptides are not immunogens, they are incomplete antigens or haptens. Leu-enk, presents a greater challenge in antibody production for the following reasons. The sequence of the opioid peptides is highly conserved. The amino acid sequences of the larger peptides in the opioid peptide family vary only slightly between species. Moreover, the sequence of the enkephalins is identical in all vertebrate and invertebrate species. The immune system does not mount a response against molecules that are viewed as "self". Because it is biologically active, leu-enk is likely to have multiple interactions in the body in addition to or

instead of interacting with the immune system. One such interaction is the uptake of leu-enk by the many opioid receptors distributed throughout the body. The enkephalins are very susceptible to enzymatic degradation. Leu-enk could be processed by proteases and therefore would be unable to circulate to the immune system. Leu-enk must be rendered immunogenic and be efficiently delivered to the immune system before successful antibody production can occur.

Antibody production is the result of the interaction of two cells in the immune system. These are B-cells (also known as spleen cells or antibody producing cells) and T-cells (also known as helper cells). T-cells release cytokines which stimulate the B-cells to proliferate, mature, and produce antibodies. An immunogen has a symmetrical interaction with both B- and T-cells, therefore antibody production is induced. A hapten has an asymmetrical interaction with the immune system. A hapten can react with B-cells, but is not recognized by T-cells. Therefore, a hapten cannot induce antibody production by itself. An endogenous or "self" peptide, such as leu-enk, is not recognized by either B- or T-cells. A peptide (hapten) must be chemically linked to a carrier to generate an immunogen.

The necessity of a carrier in the production of

peptide antibodies can be demonstrated using this classical textbook example of the dinitrophenyl (DNP) hapten (Unanue and Benacerraf, 1984). A rabbit immunized with unconjugated DNP does not produce antibodies to DNP. If the same rabbit is immunized with DNP conjugated to ovalbumin, then the rabbit produces antibodies which recognize the DNP-ovalbumin conjugate, unconjugated DNP, and ovalbumin. Ovalbumin, used as a carrier protein, provides a T-cell recognition site and DNP provides a B-cell recognition site. Therefore, the DNP-ovalbumin conjugate has the symmetrical interaction with the immune system that is necessary for antibody production.

The selection of carrier and linking agent are crucial. Examples of carrier proteins are bovine serum albumin, keyhole limpet hemocyanin, poly-L-lysine, and bovine globulin. The choice of carrier is usually a personal preference of the individual. These carrier proteins are adequate for many applications, but may not be suited for peptide antibody production. It must be recognized that a vast array of antibodies is produced when a peptide-carrier conjugate is introduced into an animal. There will be many antibodies that bind to the carrier (which many times is much more immunogenic than the peptide) and to the linking group, while relatively few antibodies will actually bind to the peptide.

Examples of linking agents are carbodiimide, glutaraldehyde, N-succinimidyl 3-(2-pyridyldithio)propionate (SPDP), succinimidyl 4-(N-maleimidomethyl)cyclohexane-1-carboxylate (SMCC), and m-maleimidobenzoyl-N-hydroxy-sulfosuccinimide ester (MBS). The choice of linking agent is usually made on the basis of which functional groups are available on the peptide and carrier. The linker must be sufficiently long to provide space between the peptide and carrier so that antibody binding is not sterically hindered. The conformation of the peptide must not be altered by conjugation to the carrier.

The protein component of tuberculin (purified protein derivative or PPD) is an interesting example of what could be called a T-cell hapten (Lachmann, *et al.*, 1986). That is, PPD is recognized by and stimulates T-cells, but it does not elicit antibody production. PPD is prepared from the culture supernatants of *Mycobacterium tuberculosis*. It is not a pure protein, but the molecular weight of its main component is 10,000. It will be demonstrated that it is advantageous to use PPD as the protein carrier, because it can be coupled to leu-enk to prepare peptide antibodies while generating virtually no antibody response against itself.

It has been shown that the immunogenicity of antigens is enhanced by the use of antibodies that target immune cells as carrier proteins (Kawamura and Berzofsky, 1986; Carayanniotis and Barber, 1987; Carayanniotis, et al., 1988). Carayanniotis and coworkers (1987, 1988) coupled peptides of herpes simplex virus to an anti-I-A^k antibody. This antibody binds to the class II major histocompatibility complex (MHC), which is expressed on the surface of antigen presenting cells. Antigen presenting cells (class II MHC) are macrophages, B-cells, dendritic cells and Langerhans cells. The hypothesis is the anti-I-A^k antibody serves to focus antigen on the antigen presenting cell, hence enabling efficient initiation of an immune response. Kawamura and Berzofsky (1986) used a slightly different approach by coupling ferritin to Gt x Mo immunoglobulin. The Gt x Mo immunoglobulin binds, with a high affinity, to the antibodies that B-cells express on their surface. The antigen is taken up by the B-cell, processed, and presented to the T-cells.

The feasibility of using T- and B-cell antibodies as carriers for leu-enk was examined here. Hamster x CD3 antibody (named 2C11) was used to target leu-enk to T cells. The CD3 protein, along with the T-cell receptor, recognize antigen and transduce activating

signals to the cytoplasm of the T-cell. It is assumed that the 2C11 antibody will bind to the CD3 protein thereby stimulating T-cell functional responses. The immunogenicity of leu-enk using the 2C11 antibody carrier is compared to Gt x Mo immunoglobulin as a carrier. The results given here illustrate the use of 2C11 antibody which generates an enhanced immune response to leu-enk.

Cell Fusion. A major limitation in antibody production is the non-specific nature of the cell fusion which generates hybridoma cells. A hybridoma is the product of the fusion between a spleen cell and a myeloma cell. It is actually an immortalized spleen cell. The efficiency of a fusion is defined as:

$$\frac{\textit{growing colonies}}{\textit{total wells}} \times 100$$

Fusion specificity is defined as:

$$\frac{\textit{specific colonies}}{\textit{total colonies}} \times 100$$

Both the specificity of a fusion and the number of high affinity antibodies produced can be improved using bridging techniques (Bankert, *et al.*, 1980; Conrad and Lo, 1990; Lo, *et al.*, 1984; Reason, *et al.*, 1987; Tomita and Tsong, 1990; Wojchowski and Sytkowski, 1986; Blancher, *et al.*, 1991). The "bridge" that has been most commonly used is the one shown in Figure 1.1. This bridge takes advantage of the high affinity binding between avidin and biotin. The spleen cells are allowed to react with antigen that has been coupled to avidin. That half of the bridge is then mixed with the biotinylated myeloma cells. This bridge should increase the specificity of cell fusion because, only antigen-specific spleen cells will bear immunoglobulin which binds that antigen on their surface. Once this bridge is formed, these two cells should be in close enough proximity to allow efficient fusion of their cell membranes.

More than half of the work done using bridged fusions is combined with electrofusion. Electrofusion uses intense, short-duration electric pulses to fuse the cells. While it has been claimed the electrofusion can be 10 to 100 times more efficient (and therefore more specific) than a PEG mediated fusion (Conrad and Lo, 1990), this claim cannot be repeated in this lab.

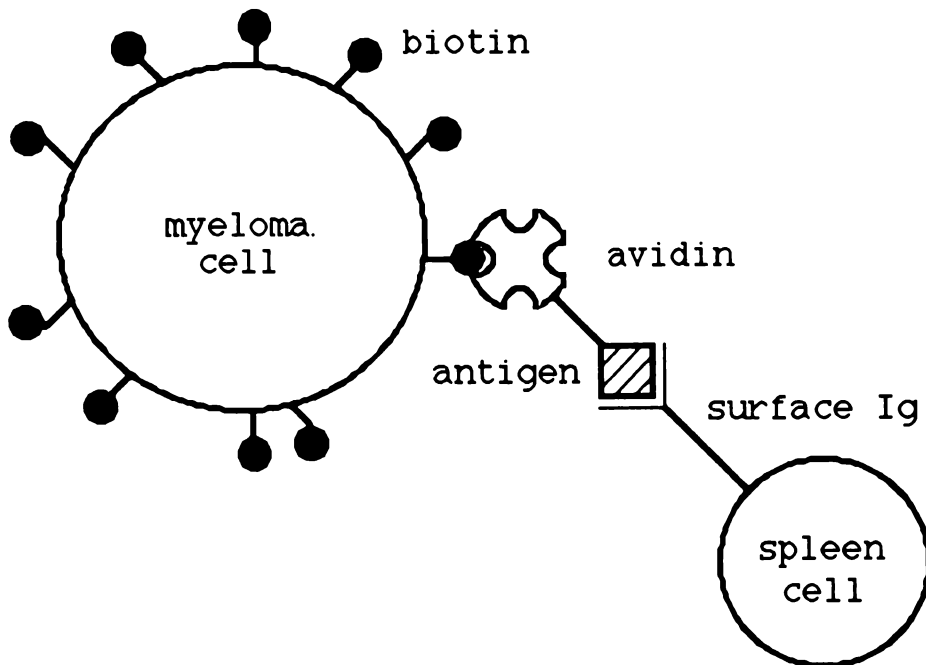

Figure 1.1 Avidin mediated bridging of a B-cell to a biotinylated myeloma cell.

In fact, we have repeatedly found that the cells were destroyed during the fusion process. There are other disadvantages to electrofusion. The equipment is expensive and large biological hoods are needed to contain it. As has been demonstrated, experimental conditions found to work with one particular cell do not work for another. Conditions for each and every cell type must be optimized individually. Reason, *et al.*, (1987) used PEG as the fusing agent. They state that while the number of specific hybridomas does not substantially increase, the hybridomas produced from a bridged fusion secrete higher affinity antibodies.

Two bridging systems have been examined. The first system is the avidin-biotin bridge already described. Here, avidin is used as the antigen as well as the bridging element. This eliminates the complications involved when coupling avidin to an antigen (McCormack, 1991). The second system is a novel one that uses an antibody bridge. This bridging configuration is shown in Figure 1.2. PEG mediated bridged fusions were carried out to determine if, indeed, higher fusion specificities and/or higher affinity antibodies were produced.

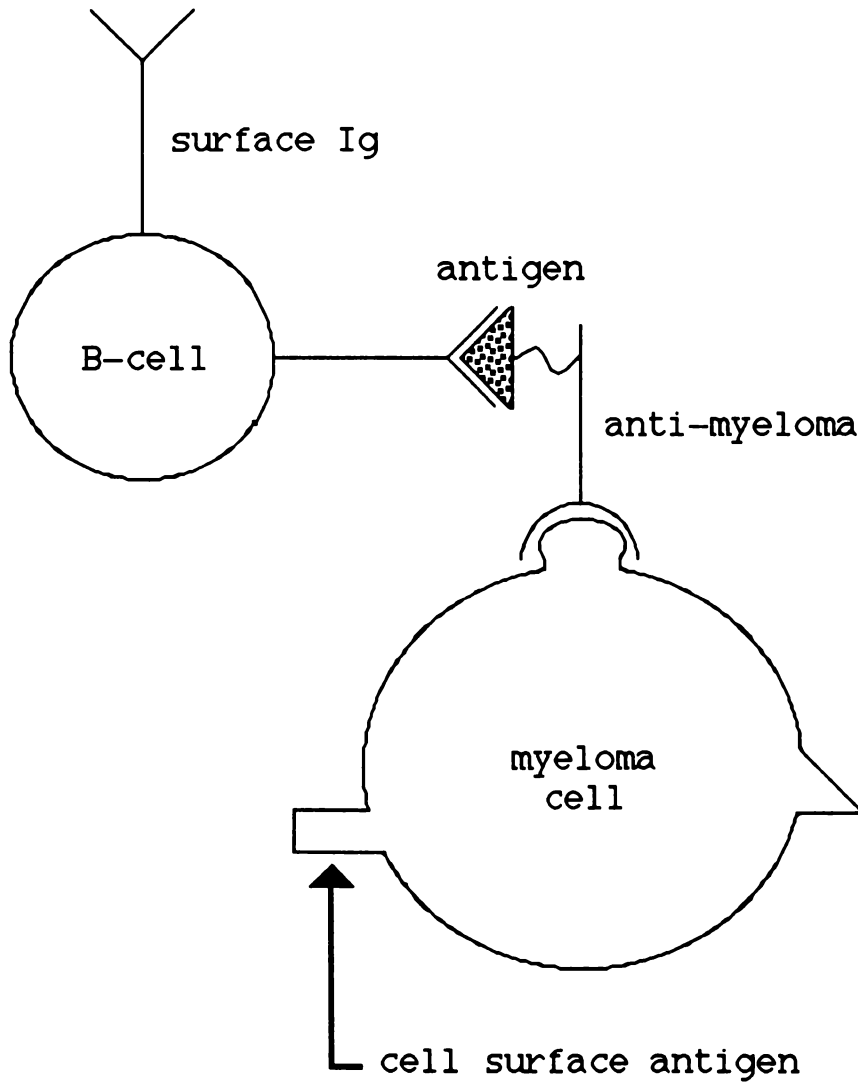

Figure 1.2 Antibody mediated bridging of a B-cell to a myeloma cell.

ENHANCED IMMUNIZATION METHODS

Experimental

Preparation of Buffers.

The preparation of buffer solutions is outlined in Table 1.2.

Preparation of Immunogens.

Immunogen 1. Leu-enk (Sigma, St. Louis, MO) was conjugated to Purified Protein Derivative of Tuberculin (PPD, provided by Lederle Laboratories, Pearl River, NY) using a modification of the glutaraldehyde method of Childers, *et al.*, (1977). Ten milligrams of leu-enk and 5 mg of PPD were dissolved in 1.8 mL of 0.2 M sodium acetate, pH = 5.0. Two hundred microliters of 25% glutaraldehyde (GA, Aldrich, Milwaukee, WI) was added dropwise and the mixture was stirred at room temperature for 4 hours. The mixture was then centrifuged and the precipitate was resuspended in PBS. The excess glutaraldehyde and leu-enk were removed by dialysis in PBS.

Immunogen 2. Leu-enk was conjugated to 2C11 (Hamster x Mo CD3, Boehringer Mannheim, Indianapolis, IN) using the enhanced carbodiimide coupling method of Staros, *et al.*, (1986). Leu-enk was dissolved in 10 mM PB at a concentration of 3 mM. 1-ethyl-3-(3-

Table 1.2
Buffer Solutions*

Buffer	Description
0.1 M PB	phosphate buffer pH = 7.4 0.08 M Na ₂ HPO ₄ , 0.02 M KH ₂ PO ₄ (Fisher, St. Louis, MO)
PBS	phosphate buffered saline pH = 7.4 0.008 M Na ₂ HPO ₄ , 0.002 M KH ₂ PO ₄ , 0.15 M NaCl (Fisher)
BB1	ELISA blocking buffer 1 PBS containing 0.05% Tween 20 (Sigma) and 0.2% Bovine Serum Albumin (BSA, Sigma)
BB2	ELISA blocking buffer 2 PBS containing 1% gelatin (Fisher)
BB3	ELISA blocking buffer 3 PBS containing 0.5% Tween 20 and 3% BSA
0.1 M CB	carbonate buffer pH = 9.4 0.07 M NaHCO ₃ , 0.03 M Na CO ₃ (Fisher)
0.05 M CB	0.05 M carbonate buffer pH = 10.0 0.02 M NaHCO ₃ , 0.03 M Na CO ₃
WB	ELISA wash buffer PBS containing 0.05% Tween 20
TXM	10 mM Tris-HCl buffer pH = 7.4 containing 1 mM MgCl ₂ , 20 mM ZnCl ₂ , and 0.1% Triton X-100
0.01 M TB	10 mM Tris-HCl buffer pH = 8.0

*All buffers are made with Nanopure water (Barnstead Nanopure II, Sybron/Barnstead, Boston, MA).

dimethylaminopropyl)carbodiimide (EDAC, final concentration = 0.1 M, Sigma) and N-Hydroxysulfosuccinimide (NHS, final concentration = 5 mM, Pierce, Rockford, IL) are added dropwise, in that order, with stirring. 2C11 (final concentration = 5 mg/mL) was added and the reaction was tumbled end-over-end at room temperature for 20 hours. The excess EDAC, NHS, and leu-enk were removed by dialysis in PBS.

Immunogen 3. Leu-enk was conjugated to Gt x Mo immunoglobulin (Gt x Mo Igs, produced in this lab) using the enhanced carbodiimide method as described in the procedure for immunogen 2.

Immunization.

Immunization schedules are summarized in Tables 1.3 and 1.4. Freund's adjuvant, when used, was mixed at a 3:1 (adjuvant:immunogen) volume ratio for Immunogen 1 and a 1:1 ratio for Immunogens 2 and 3.

Preparation of BSA-Enkephalin Conjugate.

A conjugate of BSA and enkephalin was prepared according to Staros (1986).

Table 1.3
 Immunization schedule for Immunogen 1
 mice = (Balb/c x C57BL/6)F₁

week	amount (µg), medium, route
0	30 BCG ¹ , saline, IM ²
2,4,6,8,10,12	30, saline, IV ³
14	10, CFA ⁴ , IP ⁵
16	10, saline, IV
18	10, IFA ⁶ , IP
20,22,26	10, saline, IV
36	30, IFA, IP
38	40, saline, IV
38 + 3 days	fusion

¹BCG = Bacillus Calmette-Guerin

²IM = intramuscular

³IV = intravenous

⁴CFA = Complete Freund's Adjuvant (Gibco, Grand Island, NY)

⁵IP = intraperitoneal

⁶IFA = Incomplete Freund's Adjuvant (Gibco)

Table 1.4¹
 Immunization schedule for Immunogen 2 and Immunogen 3
 mice = Balb/c and A/J

week	amount (μ g), medium, route
0	50, CFA ² , IP ³
2	25, IFA ⁴ , IP
4, 6, 8, 10, 12, 14,	25, saline, IP
16	25, saline, IV ⁵
16 + 3 days	fusion

¹Immunizations were carried out at Hybritech, Inc.
 San Diego, CA

²CFA = Complete Freund's Adjuvant

³IP = intraperitoneal

⁴IFA = Incomplete Freund's Adjuvant

⁵IV = intravenous

Cell Fusion.

Fusion 1. The spleen cells of mice immunized with Immunogen 1 were fused with the myeloma cell line P3X63Ag8.653 (American Type Culture Collection, Rockville, MD) according to Galfre and Milstein (1975). The supernatants were screened for specific antibody production after 10 to 20 days. Selected cultures were cloned by limited dilution. Those clones were expanded and antibodies were produced in ascites fluid of athymic nude mice (nu/nu).

The myeloma cell line donor in this fusion is Balb/c and the spleen cell donor is (Balb/c x C57BL/6)F₁. If the myeloma donor and spleen donor are not of the same strain, then athymic nude or the first generation cross animals must be used for ascites production. This is to prevent the animal from producing antibodies against the hybridoma cells and lowering the yield of ascites.

Fusions 2 and 3. The spleen cells of mice immunized with Immunogen 2 or 3 were fused according to Hybritech, Inc. Standard Operating Procedure. The supernatants were screened for specific antibody production after 10 to 20 days. The positive, uncloned colonies were expanded and antibodies were produced in ascites fluid of athymic nude mice.

ELISA for Enkephalin Specific Antibody.

ELISA 1. The plate was coated with 100 μL of BSA-enkephalin conjugate, PPD-enkephalin conjugate, BSA alone, or PPD alone (10 $\mu\text{g}/\text{mL}$, in 0.1 M CB) for 1 hr at 37°C or overnight at 4°C. The plate was washed 4 times with WB and patted dry. The plate was blocked for 1.5 hr, at 37°C, with 200 μL BB2 or BB3. The plate was washed 4 times with WB and patted dry. Serum or supernatant (100 μL) was added and incubated for 1 hr at 37°C. The plate was washed 4 times with WB and patted dry. Peroxidase labelled goat anti-mouse immunoglobulins (100 μL , 1:10,000 dilution of supplied material, Jackson Laboratories, West Grove, PA) was added and incubated at 37°C for 1 hr. The plate was washed with distilled water 4 times and patted dry. One hundred microliters of substrate was added and after 20 minutes the reaction was quenched. The absorbance was read at 450 nm.

ELISA 2. This procedure is a modification of Jitsukawa, *et al.*, (1989). The plate was coated with 50 μL of a mixture of BSA (8 $\mu\text{g}/\text{mL}$, in 0.05 M CB) and leu-enk (16 $\mu\text{g}/\text{mL}$, in 0.05 M CB) at 37°C, uncovered, overnight or until all of the liquid had evaporated. The plate was washed with WB four times and patted dry. The plate was blocked for 1.5 hr, at 37°C, with 200 μL BB2 or BB3. The plate was washed 4 times with WB and patted

dry. Serum or supernatant (50 μ L) was added and incubated for 1 hr at 37°C. The plate was washed 4 times with WB and patted dry. Peroxidase labelled goat anti-mouse immunoglobulins (75 μ L) was added and incubated at 37°C for 1 hr. The plate was washed with distilled water 4 times and patted dry. One hundred microliters of substrate was added and after 20 minutes the reaction was quenched. The absorbance was read at 450 nm.

Purification of Antibodies.

The procedure of Goding (1983) was followed. First, the antibodies were precipitated from the ascites fluid using saturated ammonium sulfate. The antibodies were dialyzed against 0.01 M TB and were further purified using anion-exchange chromatography on DEAE-Sephacel, using a 0 - 300 mM NaCl gradient. Finally, the antibodies were concentrated and dialyzed against 0.1 M PB.

Results and Discussion

PPD as a Protein Carrier.

PPD has proven to be an effective carrier. Fusion 1 produced 52 colonies that were specific for the PPD-enkephalin conjugate, 9 colonies (17% of total specific colonies) cross reacted with PPD and the PPD-enkephalin conjugate, and only 2 colonies (4% of total specific colonies) that were specific for PPD. The very low antibody response to PPD is especially advantageous in screening where the presence of anti-carrier antibody is a hindrance. A positive cell line may be discarded because it exists in the same well as cells that secrete anti-carrier antibodies. After further screening, cloning and expansion, two clones that secreted IgG antibodies were chosen for further experiments. These clones are enk33FC6 and enk312EG12.

Anti T- and B-cell Antibodies as Protein Carriers.

Serological response. Nine of the 20 mice immunized responded to leu-enk with serum titers of at least 1/1000 when screened using ELISA procedure 2. A serum titer, in mice, of 1/1000 is adequate for cell fusion. The combinations of carrier antibody and strain of mouse resulting in serum titers of at least 1/1000 are shown in Table 1.5. Figure 1.3 shows the results of a typical

serum titration using ELISA procedure 2 against BSA + leu-enk and BSA alone. Figure 1.4 shows the results of a competition ELISA using procedure 2. The plate was coated with BSA + leu-enk or BSA-enkephalin conjugate. Various amounts of free leu-enk were added to the serum during incubation. It can be seen that while the response of the serum to BSA + leu-enk can be effectively competed away with free leu-enk, a significant response remains when the BSA-enkephalin conjugate is on the plate. This remaining response is due to antibodies which bind to the region where leu-enk is bound to BSA. Immunization with a carrier-peptide conjugate always results in a vast array of antibodies that not only recognize the peptide, but the carrier and the linking agent. The region where the carrier and peptide are linked is often immunogenic. The results in Figure 1.4 emphasize the necessity of screening the serum in the absence of the linking agent used in immunogen formation.

The use of a 2C11 antibody carrier resulted in a 70% increase in immunogenicity of leu-enk over Gt x Mo immunoglobulin as a carrier. This enhanced immunogenicity cannot be explained by increased antigen presentation, because unlike B-cells and macrophages, T-cells are not capable of antigen presentation. It has been shown that antibodies against CD3 can often

Table 1.5
Strain of Mouse and Carrier Antibody Combinations
Showing Serum Titers of $>1/1000$

Mouse	Strain	Carrier Antibody
1	Balb/c	2C11
2	Balb/c	Gt x Mo Igs
3	Balb/c	Gt x Mo Igs
4	A/J	2C11
5	A/J	2C11
6	A/J	2C11
7	A/J	2C11
8	A/J	2C11
9	A/J	Gt x Mo Igs

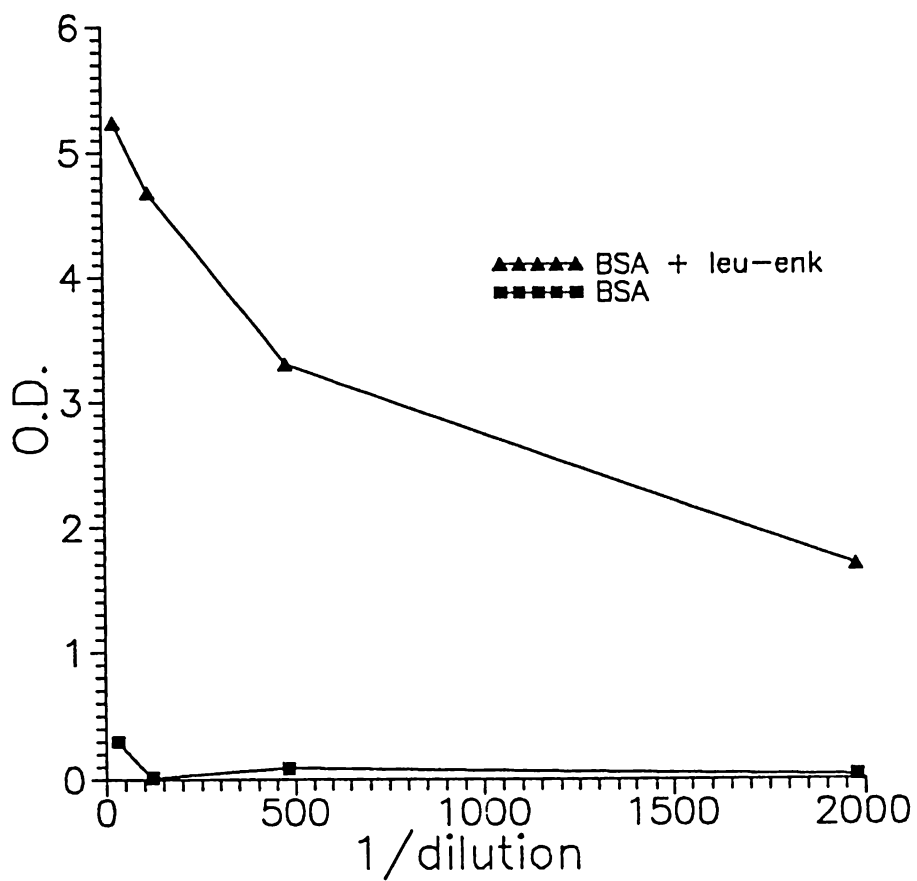

Figure 1.3 Titer of serum against BSA + leu-enk and BSA.

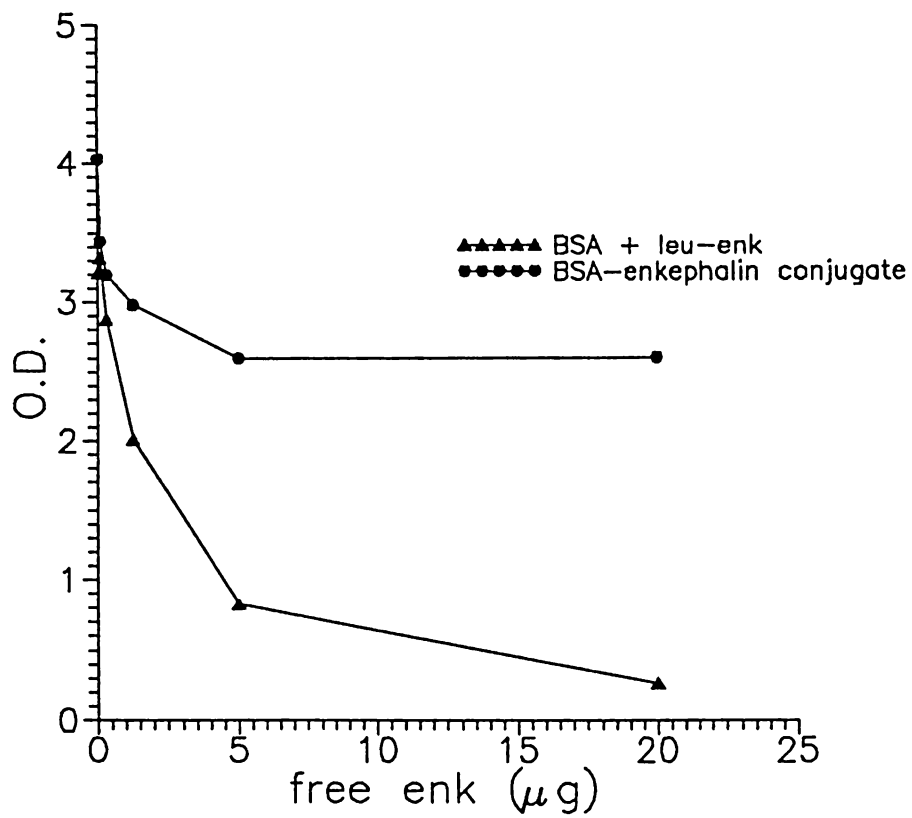

Figure 1.4 Competition of serum with BSA + leu-enk or BSA-enkephalin conjugate.

stimulate T-cell responses which are identical to antigen induced responses, but are not antigen specific (Abbas, *et al.*, 1991). The enhanced immunogenicity must be due to increased and increased number of stimulated T-cells and therefore increased T-cell help.

Based on the findings of Kawamura and Berzofsky (1986), it is surprising that the Gt x Mo immunoglobulin carrier does not enhance the immunogenicity of leu-enk any more than it does. The Gt x Mo immunoglobulin binds with a high affinity ($K_{app} = 10^{10} M^{-1}$) so it is reasonable that it binds to the B-cells, is taken up and presented to the T-cells. The amount of T-cell help is much less when using Gt x Mo immunoglobulin as the carrier. It does not bind to and stimulate T-cells as the 2C11 antibody does. This comparison of T- and B-cell antibodies as carrier proteins indicates that an enhanced immune response is largely due to an increased number of active T-cells.

Fusions. Five fusions were carried out. These fusions produced 10 IgM and 2 IgG populations (uncloned). The IgG populations are LE4H8 and LE2A10. The low number of leu-enk specific cell populations certainly does not reflect the high IgG serum titers. It must be remembered that the presence of antibodies in the serum does not

necessarily lead to a high number of antigen specific cell populations.

The frequency of specific spleen cells in any animal for any given antigen is typically far less than 1% (Kuus-Reichel, et al., 1991; Nolan, et al., 1978; Duran and Metcalf, 1987). After immunization, this frequency remains low. For example, the number of dinitrophenol specific antibodies rises from 1 in 5×10^3 to 1 in 1.3×10^3 . The number of *Salmonella Typhimurium* specific antibodies rises from 1 in 1×10^5 in an unimmune animal to 1 in 6.1×10^3 (Duran and Metcalf, 1987). It can be seen the frequency in an immune animal is only 0.02% for these antigens. The situation for leu-enk is not expected to be any better because it is a self antigen. So if the average number of cells in a spleen is 1×10^8 , then only approximately 2×10^4 of those cells produce specific antibodies. The high number of antibodies in the serum of an immunized animal is being produced by relatively few spleen cells. This further reinforces the need for improved fusion methods.

AVIDIN-BIOTIN BRIDGED FUSION

Experimental

Immunization.

The immunization schedule is shown in Table 1.5. Freund's adjuvant, when used, was mixed at a 1:1 (adjuvant:immunogen) volume ratio with avidin.

Standard Fusion.

The spleens of two mice immunized with avidin were pooled and split into two pellets. Pellet 1 was fused with the myeloma cell line SP2/0 according to Ausubel, *et al.*, (1989). The supernatants were screened for specific antibody production after 14 to 28 days. Pellet 2 was reserved for the bridged fusion.

Bridged Fusion.

Biotinylation of Myeloma Cells. SP2/0 (American Type Culture Collection) mouse myeloma cells were collected and washed twice with serum-free media (SFM). The myeloma cells were resuspended in 1×10^{-4} M NHS-biotin (Pierce, Rockford, IL) at 1×10^7 cells/mL. The myeloma cells were left undisturbed for 1 hour at 4°C. Thereafter, the myeloma cells were washed twice with SFM and left on ice until needed for fusion.

Table 1.5
 Immunization Schedule for Avidin
 mice = Balb/c

week	amount (μ g), route, medium
0	100, IP ¹ , CFA ²
2	50, IP, IFA ³
4	100, IP, PBS
6	100, IP, PBS
6 + 3 days	fusion

¹IP = intraperitoneal

²CFA = Complete Freund's Adjuvant

³IFA = Incomplete Freund's Adjuvant

FITC-avidin and fluorescence microscopy were used to verify a high degree of biotinylation. The myeloma cells remained viable 24 hours after biotinylation.

Preparation of Spleen Cells for Bridged Fusion.

Spleens from immunized mice were aseptically removed and splenocytes were obtained using a stainless steel wire screen. The red blood cells were lysed using 0.87% NH_4Cl . The splenocytes (5×10^7 cells/mL) were washed twice and resuspended in SFM. Avidin (100 μg , Sigma) was added to the splenocytes and then the splenocytes were left undisturbed at 4°C for 2 hours. After the incubation, the splenocytes were washed twice with SFM.

Fusion. The splenocytes were mixed with the myeloma cells at a 5:1 ratio and spun down at $200 \times g$ for 5 minutes. The cells were left undisturbed at room temperature for one hour. The cells were fused according to Ausubel, *et al.*, (1989). The supernatants were screened for specific antibody production after 14 to 28 days.

ELISA for Avidin Specific Antibody.

The plate was coated with 100 μL of avidin (10 $\mu\text{g}/\text{mL}$, in 0.1 M CB) for 1 hr at 37°C or overnight at 4°C . The plate was washed 4 times with distilled water

and patted dry. The plate was blocked for 1.5 hr, at 37°C, with 200 µL BB2. The plate was washed 4 times with distilled water and patted dry. Serum or supernatant (100 µL) was added and incubated for 1 hr at 37°C. The plate was washed 4 times with distilled water and patted dry. Peroxidase labelled goat anti-mouse immunoglobulin (100 µL) was added and incubated at 37°C for 1 hr. The plate was washed with distilled water 4 times and patted dry. One hundred microliters of substrate was added and after 20 minutes the reaction was quenched. The absorbance was read at 450 nm.

Results and Discussion

Four avidin-biotin bridged fusions were performed and the results are shown in Tables 1.6 - 1.9. The four fusions are labelled A to D. The fusions are identical, but performed on four consecutive days. The control fusion plates are numbered 1.1 to 1.5, while the avidin-biotin bridged fusion plates are numbered 2.1 to 2.5. The efficiency of all four fusions is not high, but general trends can be seen. The efficiency of the bridged fusion is 10 to 30% lower than the control fusion. The specificity of fusion is the same or approximately 10% lower in the bridged fusion. This would indicate that avidin-biotin bridging is not effective in increasing the specificity of PEG mediated fusions. There is no means of separation of bridged cells from unbridged cells. PEG does not differentiate between cells that are in close proximity because they are bridged, or because the cells happen to be close together. The lower efficiency is most likely due to loss of cell viability during the extra incubation steps.

The positive supernatants were serially diluted in avidin coated wells of an ELISA plate to investigate the claim of higher affinity antibodies (Reason, *et al.*, 1987). The actual antibody affinities cannot be evaluated without knowing the antibody concentration, but

Table 1.6
Results of Avidin-Biotin Bridged Fusion A

plate	number of colonies	% efficiency	number of specific colonies	% specificity
1.1	47	49	16	34
1.2	25	26	5	20
1.3	38	40	3	8
1.4	47	49	15	32
1.5	47	49	8	17
average	41	43	9	22
2.1	16	17	4	25
2.2	17	18	2	12
2.3	10	10	0	0
2.4	4	4	0	0
2.5	6	6	1	17
average	11	11	1	11

Table 1.7
Results of Avidin-Biotin Bridged Fusion B

plate	number of colonies	% efficiency	number of specific colonies	% specificity
1.1	16	17	4	25
1.2	24	25	4	17
1.3	---	---	---	---
1.4	12	12	4	33
1.5	28	29	1	4
average	20	21	3	20
2.1	12	12	2	17
2.2	13	14	3	23
2.3	8	8	3	25
2.4	11	11	2	18
2.5	4	8	2	25
average	10	11	2	22

*plate 1.3 was contaminated

Table 1.8
Results of Avidin-Biotin Bridged Fusion C

plate	number of colonies	% efficiency	number of specific colonies	% specificity
1.1	42	44	10	24
1.2	60	62	19	32
1.3	63	66	23	36
1.4	48	50	15	31
1.5	8	8	3	38
average	44	46	14	32
2.1	15	16	5	33
2.2	37	41	8	22
2.3	29	30	8	28
2.4	24	25	9	38
2.5	19	20	5	26
average	25	26	7	29

Table 1.9
Results of Avidin-Biotin Bridged Fusion D

plate	number of colonies	% efficiency	number of specific colonies	% specificity
1.1	16	17	5	31
1.2	9	9	5	56
1.3	13	14	7	54
1.4	15	16	11	73
1.5	9	9	7	78
average	12	13	7	58
2.1	2	2	2	100
2.2	1	1	0	0
2.3	1	1	1	100
2.4	2	2	0	0
2.5	1	1	0	0
average	1	1	0.6	40

relative affinities of the antibodies can be compared. It must be assumed that the range of concentration of antibodies present in supernatant is 1 to 10 $\mu\text{g}/\text{mL}$. If the relative antibody concentrations in the supernatants of Fusion C (Fusion C is used as a representative fusion) is plotted against the response, the result is shown in Figure 1.6. An antibody is assumed to have high affinity if its response remains high (relative to the maximum response) throughout dilutions. Approximately 34% of the antibodies from the bridged fusions were high affinity antibodies, while only 20% of the antibodies from the control fusion were high affinity. This increased number of high affinity antibodies occurs because the spleen cells which bear high affinity antibodies on their cell surface have a greater tendency to bind avidin and therefore link to the myeloma cells. This evidence supports Lo *et al.*, (1984) and Wojchowski and Sytkowski (1986) who have reached the same conclusion.

The results here support the findings from bridged electrofusion (Bankert, *et al.*, 1980; Conrad and Lo, 1990; Lo, *et al.*, 1984; Tomita and Tsong, 1990; Wojchowski and Sytkowski, 1986; Blancher, *et al.*, 1991) and are in agreement with the PEG-mediated bridged fusion results of Reason, *et al* (1987). The results clearly demonstrate that the usefulness of antigen bridging is

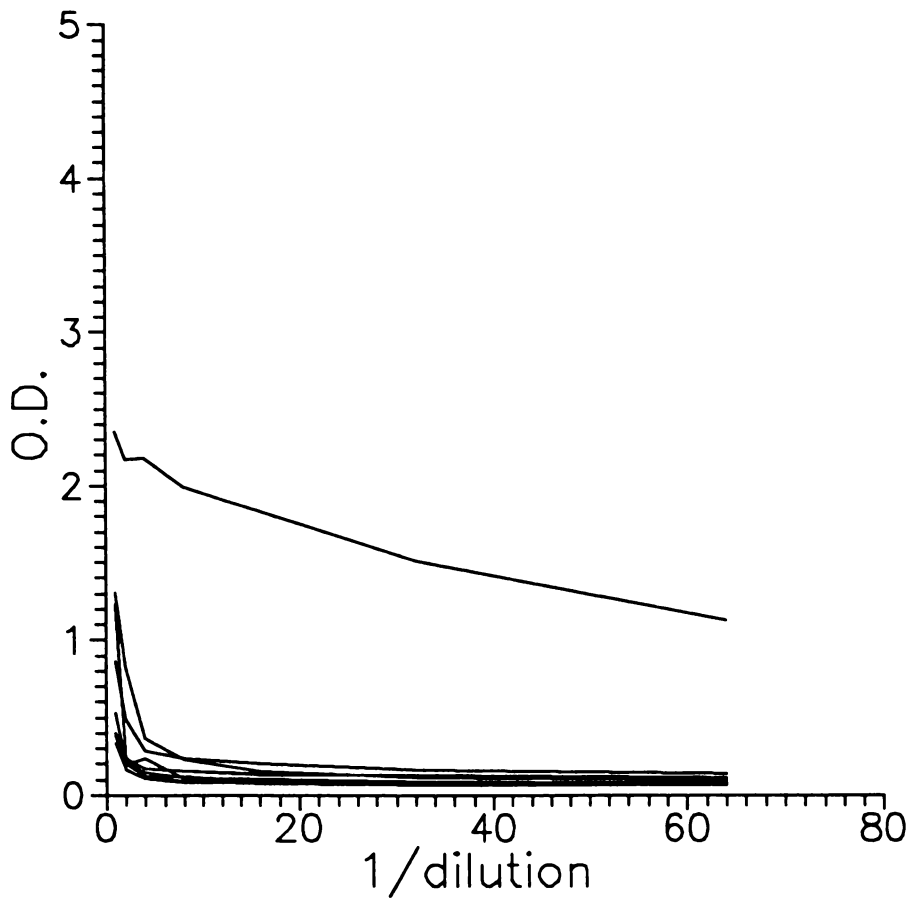

Figure 1.6 Two fold serial dilutions of supernatants of Fusion C on avidin coated ELISA plate.

not limited to electrofusion applications. It must be stated that although antigen bridging does improve the number of high affinity antibodies from a PEG-mediated fusion, the fusion specificity is unchanged. The extra incubation steps and lower fusion efficiency are limitations of the PEG-mediated bridged fusion. If high affinity antibodies are not required or desirable, then the PEG-mediated avidin-biotin bridged fusion is not recommended.

ANTIBODY BRIDGED FUSION

Experimental

Preparation of Immunogen.

P3X63Ag8.653 Antibodies. The myeloma cells were prepared for immunization according to Patrella, *et al.*, (1989). The myeloma cells were spun down and resuspended in cold PBS (1×10^7 cells/mL). The myeloma cells were vortexed for 30 seconds and then frozen in liquid nitrogen and thawed at 37°C , twice. The myeloma cells were washed twice with cold PBS. The supernatant was removed from the pelleted myeloma cells and then resuspended in cold TXM buffer ($200 \mu\text{L}/1 \times 10^7$ cells). The myeloma cells were then sonicated for 30 seconds and spun down at 10,000 rpm in a microcentrifuge. The myeloma cells were resuspended in PBS ($200 \mu\text{L}/10^7$ cells).

Immunizations.

The immunization schedules for P3X63Ag8.653 cells and Keyhole Limpet Hemocyanin (KLH, Sigma) are shown in Tables 1.10 and 1.11. Freund's adjuvant is mixed at a 1:1 ratio, when used.

Table 1.10
Immunization Schedule for P3X63Ag8.653 cells
mice = Balb/c

week	amount(cells), route, medium
0	1 x 10 ⁷ , IP ¹ , CFA ²
2	1 x 10 ⁷ , IP, IFA ³
4	1 x 10 ⁷ , IP, PBS
4 + 3 days	fusion

¹IP = intraperitoneal

²CFA = Complete Freund's Adjuvant

³IFA = Incomplete Freund's Adjuvant

Table 1.11
 Immunization Schedule for Keyhole Limpet Hemocyanin
 mice = Balb/c

week	amount (μ g), route, medium
0	100, IP ¹ , CFA ²
2	100, IP, IFA ³
4	100, IP, PBS
5	100, IP, PBS
9	100, IP, PBS
13	100, IP, PBS
13 + 3 days	fusion

¹IP = intraperitoneal

²CFA = Complete Freund's Adjuvant

³IFA = Incomplete Freund's Adjuvant

Cell Fusion for P3X63Ag8.653 Antibodies.

The spleen cells of mice immunized with P3X63Ag8.653 cells were fused with the myeloma cell line SP2/0 according to Ausubel, *et al.*, (1989). The supernatants were screened for specific antibody production after 10 to 20 days. Selected cultures were cloned by limited dilution. Those clones were expanded and antibodies were produced in ascites fluid of Balb/c mice.

ELISA for P3X63Ag8.653 Specific Antibodies.

This ELISA is a modification of Arunachalam, *et al.*, (1990). The plate was coated with 50 μ L of P3X63Ag8.653 myeloma cells (5×10^6 cells/mL, in PBS) at 37°C, uncovered overnight, or until all of the liquid had evaporated. The cells were rehydrated with 100 μ L of PBS for 15 minutes at room temperature. The PBS was removed and the plate patted dry. The plate was blocked for 1.5 hr, at room temperature, with 200 μ L BB2. The plate was washed 4 times with WB and patted dry. Serum or supernatant (50 μ L) was added and incubated for 1 hr at room temperature. The plate was washed 4 times with WB and patted dry. Peroxidase labelled goat anti-mouse immunoglobulins (50 μ L) was added and incubated at room temperature for 1 hr. The plate was washed 4 times with distilled water and patted dry. Fifty microliters of

substrate was added and after 20 minutes the reaction was quenched. The absorbance was read at 450 nm.

Purification of Antibodies.

The procedure of Goding (1983) was followed. First, the antibodies were precipitated from the ascites fluid using saturated ammonium sulfate. The antibodies dialyzed against 0.01 M TB and were further purified using anion-exchange chromatography on DEAE-Sephacel, using a 0 - 300 mM NaCl gradient. Finally, the antibodies were concentrated and dialyzed against 0.1 M PB.

Determination of Apparent Affinity Constant.

The apparent affinity constant (K_{app}) was determined using the ELISA procedure given above. The plate was coated with 5×10^6 P3X63Ag8.653 cells/mL, rehydrated, and blocked as usual, after which serial dilutions of antibody were incubated. The Gt x Mo Ig HRP and substrate were added as above. The response is plotted as a function of antibody concentration (M). The apparent affinity constant can be obtained from the OD_{50} according to the equations on the following page.

$$K = \frac{[AbAg]}{[Ab] [Ag]}$$

at OD₅₀

$$[AbAg] = [Ag]$$

so,

$$K_{app} = \frac{1}{[Ab]}$$

Conjugation of KLH to P31E6.

One milligram of KLH and 1.6 mg P31E6 were dissolved in 1.25 mL PBS. EDC (38 mg in 750 μL, final concentration = 0.1 M) was added dropwise and the mixture was stirred overnight at room temperature. The excess EDC was removed by dialysis in PBS. The ability of KLH conjugated P31E6 to bind P3X63Ag8.653 cells was verified by ELISA. Antibody bridge formation was confirmed by a serum titer against KLH conjugated P31E6 bound to P3X63Ag8.653 cells on an ELISA plate.

Standard Fusion for KLH Antibodies.

The spleens of two mice immunized with KLH were pooled and split into two pellets. Pellet 1 was fused with the myeloma cell line P3X63Ag8.653 according to Ausubel *et al.*, (1989). The supernatants were screened for specific antibody production after 14 to 28 days. Pellet 2 was reserved for the bridged fusion.

Bridged Cell Fusion for KLH Antibodies.

Preparation of Myeloma Cells. P3X63Ag8.653 mouse myeloma cells were collected and washed twice with serum-free media (SFM). The myeloma cells were resuspended in 1×10^{-11} M P31E6 coupled to KLH at 1×10^7 cells/mL. This amount of P31E6 corresponds to 100 antibodies binding to each myeloma cell. The myeloma cells were left undisturbed for 1 hour at 4°C. Thereafter, the myeloma cells were washed twice with SFM and left on ice until needed for fusion.

Fusion. The splenocytes were mixed with the myeloma cells at a 5:1 ratio and spun down at 200 x g for 5 minutes. The cells were left undisturbed at 37°C for one hour. The cells were fused according to Ausubel, *et al.*, (1989). The supernatants were screened for specific antibody production after 14 to 28 days.

Elisa for KLH Specific Antibodies.

The plate was coated with 100 μL of KLH (10 $\mu\text{g}/\text{mL}$, in 0.1 M CB) for 1 hr at 37°C or overnight at 4°C. The plate was washed 4 times with distilled water and patted dry. The plate was blocked for 1.5 hr, at 37°C, with 200 μL BB2. The plate was washed 4 times with distilled water and patted dry. Serum or supernatant (100 μL) was added and incubated for 1 hr at 37°C. The plate was washed 4 times with distilled water and patted dry. Peroxidase labelled goat anti-mouse immunoglobulin (100 μL) was added and incubated at 37°C for 1 hr. The plate was washed with distilled water 4 times and patted dry. One hundred microliters of substrate was added and after 20 minutes the reaction was quenched. The absorbance was read at 450 nm.

Results and Discussion**P3X63Ag8.653 Antibodies.**

Two clones, P31B5 and P31E6, were selected for further studies. Both of the clones were IgG. P31E6 was chosen for expansion. The apparent affinity constant of P31E6 was $2 \times 10^9 \text{ M}^{-1}$. The titration curve is shown in Figure 1.7.

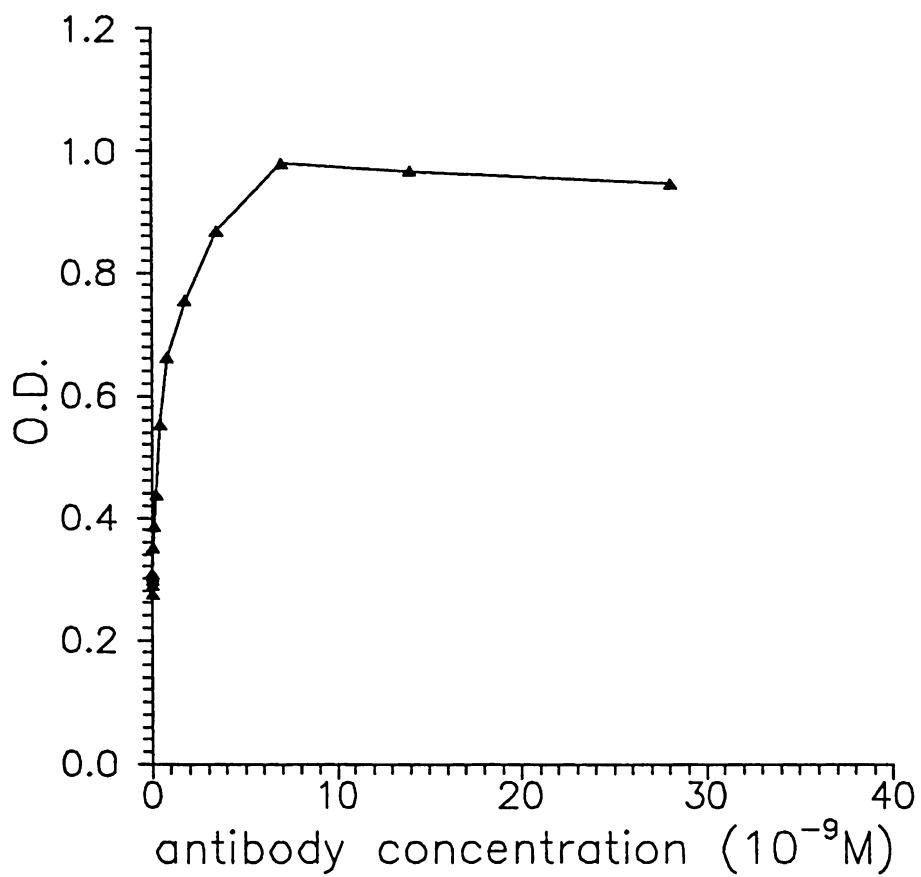

Figure 1.7 Titration curve of P31E6.

KLH Antibodies.

Four antibody bridged fusions were carried out and the results are shown in Tables 1.12 - 1.15. The four fusions are identical, were performed on four consecutive days and are labelled A to D. The control fusion plates are numbered 1.1 to 1.5, while the antibody bridged fusion plates are number 2.1 to 2.5. It can be seen that the fusion efficiency is very low. It is almost impossible to draw any conclusions from these results. The specificity of both bridged and unbridged fusions is approximately equal. About 10% of the specific antibodies possessed high affinity in both cases, also. These results do not indicate that antibody bridging increases the specificity or the number of high affinity antibodies of a PEG-mediated fusion.

The reasons for the lack of enhancement cannot be determined at this time. This was the first in a series of experiments designed to characterize the bridging system. It is imperative that the binding of P31E6 to P3X63Ag8.653 cells be characterized. First, the number of antigenic sites must be found. Although it is not necessary to know the binding site of P31E6, it is essential to determine if the antibody remains on the cell surface or is taken up by the cell.

Table 1.12
Results of Antibody Bridged Fusion A

plate	number of colonies	% efficiency	number of specific colonies	% specificity
1.1	5	5	3	60
1.2	1	1	0	0
1.3	5	5	4	80
1.4	0	0	0	0
1.5		5	5	100
average	3	3	2	48
2.1	9	9	3	30
2.2	10	10	5	50
2.3	6	6	1	17
2.4	4	4	1	25
2.5	23	24	15	65
average	10	11	5	37

Table 1.13
Results of Antibody Bridged Fusion B

plate	number of colonies	% efficiency	number of specific colones	% specificity
1.1	4	4	0	0
1.2	1	1	1	100
1.3	4	4	1	25
1.4	0	0	0	0
1.5	2	2	1	50
average	2	2	0.6	35
2.1	2	2	1	50
2.2	0	0	0	0
2.3	0	0	0	0
2.4	1	1	0	0
2.5	0	0	0	0
average	0.6	0.6	0.2	10

Table 1.14
Results of Antibody Bridged Fusion C

plate	number of colonies	% efficiency	number of specific colonies	% specificity
1.1	0	0	0	0
1.2	1	1	0	0
1.3	1	1	0	0
1.4	1	1	1	100
1.5	0	0	0	0
average	0.6	0.6	0.2	10
2.1	2	2	1	50
2.2	1	1	0	0
2.3	4	4	2	50
2.4	2	2	0	0
2.5	2	2	0	0
average	2	2	0.6	20

Table 1.16
Results of Antibody Bridged Fusion D

plate	number of colonies	% efficiency	number of specific colonies	% specificity
1.1	5	5	1	20
1.2	1	1	0	0
1.3	4	4	2	50
1.4	1	1	0	0
1.5	2	2	2	100
average	3	3	1	34
2.1	5	5	1	20
2.2	2	2	2	100
2.3	1	1	1	100
2.4	0	0	0	0
2.5	1	1	0	0
average	2	2	0.8	44

Variables, such as the ratio of antibodies per P3X63Ag8.653 cells, incubation time, and incubation temperature, must be optimized before efficient bridge formation can occur. The most important variable to optimize is the ratio of antibody molecules per P3X63Ag8.653 cell. The number of antibody molecules must be in excess to insure that every myeloma cell has antibody bound to it, but if the number is too high then multiple cell fusions are likely. Knowing the number of antigenic sites per cell would assist in determination of the optimum ratio. It was hoped that the ratio of 100 antibody molecules per each P3X63Ag8.653 cell would provide optimum conditions. Since the efficiency of both the control and bridged fusions is poor, is impossible to determine if this ratio was too high or too low. Further experiments must be carried out to select the optimum ratio.

FUTURE DIRECTIONS

Enhanced Immunization Methods.

The results here demonstrate that PPD enhances the immune response to a biologically active peptide, such as leu-enk. Further experiments need to be done in order to determine if PPD enhances the immune response to other classes of antigens. Mice must be immunized with conjugates using PPD and other proteins as carriers so the immunogenicity can be compared directly. Experiments of this type are continuing in this lab.

A comparison of anti-mouse immunoglobulins and anti-CD3 antibodies was conducted using leu-enk as the antigen. It was found that the CD3 antibody was the most effective in enhancing immunogenicity. Again, it would be interesting to use other antigens to determine if these early indications hold true. The immunogenicity of anti-CD3 and anti-I^k as carriers should also be compared. It is my prediction that the anti-CD3 antibody will prove to be the most effective carrier. The I^k protein is present on the antigen presenting cell and an antibody binding to that protein may inhibit presentation of the antigen. In order for anti-I^k to be an effective carrier, B- or T-cells must be able to bind the antigen, anti-I^k, and I^k simultaneously. If the presence of

anti-I^k hinders antigen presentation, immunogenicity is not enhanced.

Future experiments also include those that would prove the possibility that anti-CD3 is an "universal carrier protein". If the proposed mechanism of action is true, then the immunogenicity of an antigen should increase even if that antigen and anti-CD3 were not conjugated. An animal could simply be immunized with a mixture of anti-CD3 and antigen. The binding of anti-CD3 would bring up T-cell help for the B-cells that recognize the antigen. The antigen need not be coupled to the antibody to receive the T-cell help. The T-cell help is non-specific. Any B-cell that had come in contact with antigen would be stimulated and that antigen does not need to be coupled to an antibody to be recognized by a B-cell.

Bridged Fusions.

The results of the avidin-biotin bridging system indicate that while antigen bridging greatly increases the specificity of electrofusions, it has no effect in PEG mediated fusions, although the number of high affinity antibodies was significantly increased. The findings here support those found in the literature.

Future experiments would utilize the avidin-biotin bridge in cell fusions involving peptides, such as leu-enk.

The results of the antibody bridged fusions are inconclusive. Further experiments must be done to fully characterize the bridging configuration. First, the number of antigenic sites per P3X63Ag8.653 cell must be calculated. It must be determined whether the antibody is taken up by the cell upon binding. The optimum ratio of antibodies to P3X63Ag8.653 cell must be evaluated. And lastly, the optimum incubation times must be found.

It may be necessary to use electrofusion to examine the antibody bridging system. Although the use of electrofusion has not proven effective in this lab, it has certain advantages in bridged fusions. Bridging techniques are highly suited for electrofusion because, in effect, the bridged cells are separated from the bulk of cells. Specificities of electrofusion are often close to 100%. The bridged cells are not separated from unbridged in a PEG mediated fusion. The fusion of cells using PEG is random. The unbridged, as well as bridged, cells are in close enough contact for membrane fusion.

B-cells have been separated on the basis of differences in size and density by using unit gravity sedimentation (Kuus-Reichel, *et al.*, 1991). The method was used to isolate hybridoma forming cells, thereby

enriching that cell population. The same method can be applied to separate bridged cells from unbridged cells prior to fusion. Further experiments in PEG-mediated bridged fusions should be attempted using cell separations to determine if bridged cells are selectively enriched.

It must be remembered that the outcome of a cell fusion cannot be predicted. It may not be possible to generalize the conditions that produce high numbers of specific, high affinity antibodies. The conditions that lead to a successful fusion with one set of cells, or in one lab, or even on one given day, may not lead to other successful fusions. Each individual fusion must be optimized and it still must be remembered that hybridoma technology remains an art as well as a science.

CHAPTER TWO

IMMUNOAFFINITY CHROMATOGRAPHY OF LEUCINE ENKEPHALIN

INTRODUCTION

The detection method for opioid peptides must be not only be sensitive, but must be able to distinguish between similar structures and sequences. In other words, the method must have molecular specificity. Popular methods of isolation and detection are liquid chromatography (LC), mass spectrometry (MS), and radioimmunoassay (RIA). The focus of this text is immunochemical techniques, but a brief discussion of the other detection methods follows.

Liquid chromatography offers high versatility and is commonly used for the separation of opioid peptides. There are numerous conditions (although reverse phase is usually used) for separation and methods of detection. Separation of the opioids can be achieved by isocratic, gradient, or multi-dimensional systems. Optimal separation may not be achieved unless gradient or multi-dimensional conditions are used, although it has been shown that certain isocratic conditions do work (Feldman, *et al.*, 1978). A review of the various chromatographic conditions used in opioid peptide analysis is given by Dave (1991).

Once separated, the opioids can be detected without derivatization by measurement of absorbance at 214, 254, or 280 nm, but the limit of detection is approximately

one nanomole (McKnight, et al., 1988). Electrochemical detection can lower the limit of detection of the enkephalins about an order of magnitude (White, 1983; Mousa and Couri, 1983). The tyrosine residue can be oxidized at +1.25 V vs Ag-Ag/Cl. The detection limit can be decreased many orders of magnitude by using fluorescent derivatization (Jones and Gilligan, 1983; Kai, et al., 1988; Mifune, et al., 1989). The use of mass spectrometric detection adds the dimension of molecular specificity. Desiderio and coworkers (Desiderio, 1992; Dass, et al., 1991) have detected 25 to 150 pmol/mg of met-enk and β -endorphin. Liquid chromatography, with the appropriate detection method, can be both sensitive and specific, but one must be cautious when identification is made on the basis of retention behavior alone.

The radioimmunoassay has probably been the most widely used technique for the detection of the opioids, (Bayon, et al., 1983; Hendren 1986; Loeber and Verhoef, 1981; Hong, et al., 1983) as well as other peptides and proteins. Radioimmunoassay techniques are highly sensitive. β -endorphin and the enkephalins have been detected in the low femtomole/gram tissue range (Guillemin, et al., 1977; Yang, et al., 1977; Rossier, et al., 1977; Miller, et al., 1977). Although

radioimmunoassays are sensitive and easy to perform, the major drawback of this detection method is the high degree of cross-reactivity that is demonstrated by opioid peptide antibodies. This cross-reactivity leads to erroneous high concentrations or false positives. It has been shown that not only do antibodies to enkephalin cross react with other opioid peptides, these antibodies bind to non-opioid peptides. Descholdt-Lanckman and coworkers (1984) demonstrated cross-reactivity of a met-enk antibody to cholecystokinin.

It is because of this cross-reactivity that the selection of an appropriate antibody is the first and most important step in RIA. It is imperative that the antibody be characterized and its binding specificity determined. This is particularly important in the detection of the opioids, because they share amino acid sequences. The first antibodies produced against the opioids were polyclonal (Childers, *et al.*, 1977; Cupo, *et al.*, 1986; Gros, *et al.*, 1978; Miller, *et al.*, 1978; Simantov, *et al.*, 1977;). These antibodies did indeed show extensive cross-reactivity within the opioid family.

It was hoped that monoclonal antibodies would alleviate the cross-reactivity problem. Various antigens and immunization protocols were used in order to produce monoclonal antibodies (Pontarotti, *et al.*, 1983; Herion

and De Coen, 1986; Herz, *et al.*, 1982; Meo, *et al.*, 1983; Jones, *et al.*, 1983; Cuello, *et al.*, 1984; Gramsch, *et al.*, 1983; Descholdt-Lanckman and Pontarotti, 1984). The monoclonal antibodies also exhibit cross-reactivity, but this cross-reactivity is more defined. One can choose an antibody which exhibits the cross-reactivity which is desired. For example, Herion and De Coen (1986) report a leu-enk antibody that exhibits only 1.4% and 0.0045% cross-reactivity to met-enk and β -endorphin, respectively. Cuello, *et al.*, (1984) produced monoclonal antibodies that bind to leu- or met-enk equally well, but do not bind to β -endorphin at all. Meo, *et al.* (1983) produced a β -endorphin antibody that also binds to both leu- and met-enk. The monoclonal antibody cross-reactivity data indicate that these antibodies tend to bind to smaller peptides than the one immunized with, but not to larger ones. So, β -endorphin antibodies also bind to the enkephalins, but not to B-lipotropin (precursor to β -endorphin). Likewise, enkephalin antibodies usually do not bind to β -endorphin.

The characterization of an antibody includes determination of the affinity constant. A radio-immunoassay is most effective when a high affinity ($> 10^8 \text{ M}^{-1}$) antibody is used. Herion and De Coen (1986) report an affinity constant of $8.0 \times 10^8 \text{ M}^{-1}$ and Jones,

et al. (1983) only report a low affinity. Low affinity antibodies lead to long incubation times which is another drawback of the radioimmunoassay.

It is obvious that, if used alone, none of these methods of separation or detection meet the criteria of molecular specificity. A combination of methods would better meet that goal. Such combinations have been used (Desiderio, *et al.*, 1986; Desiderio 1984; Hong, *et al.*, 1983; Loeber and Verhoef, 1981).

Separation and detection are not the only steps involved in an analysis system. Perhaps the most important step in an analysis is pretreatment of the sample. A highly selective sample pretreatment method is crucial in the accurate determination of opioid peptides because of the trace levels at which the opioids are present and the variability that arises due to inefficient removal of enzymes. The presence of enzymes can either lead to reduced concentrations by degradation of the peptide(s) of interest or to increased concentrations by degradation of precursor peptides.

The existing sample pretreatment methods for the opioid peptides are long, tedious, and have poor recovery. The method of sacrificing the animal affects the recovery when tissue samples are to be processed. Microwave irradiation is thought to be effective in

eliminating enzymatic degradation (Blank, 1992; Yang, *et al.*, 1977; Meek, *et al.*, 1978; Loeber and Verhoef, 1981). The tissue samples must be homogenized in acidic media to insure high yields (Rossier, *et al.*, 1977; Yang, *et al.*, 1977; Guillemin, *et al.*, 1977; Fleming and Reynolds, 1988). The remainder of the clean-up procedure is the same for tissue as well as plasma, urine, or cerebral spinal fluid samples. The proteins are precipitated by acidification. The supernatant is neutralized and further purified by liquid-liquid extraction (Venn, *et al.*, 1985; Meek and Bohan, 1978; Rossier, *et al.*, 1977) or by multi-step solid phase extraction (Mifune, *et al.*, 1989; Kai, *et al.*, 1988; Desiderio, *et al.*, 1984). The opioid peptide rich fraction is lyophilized or dried in a vacuum oven and the residue is reconstituted in the appropriate buffer or mobile phase.

An alternative sample pretreatment method is immunoaffinity chromatography. Immunoaffinity chromatography (IAC) is a method that takes advantage of the specificity and affinity of the interaction between an antigen and its antibody to purify the antigen. Immunoaffinity chromatography is performed in two steps. First the antigen to be purified is passed through the immunoaffinity column and is preferentially bound, while

the interferences are washed from the column, then the interaction between the antibody and antigen is disrupted and the antigen is eluted from the column.

The strength and selectivity of antibody-antigen interactions promotes a high degree of purification. In immunoaffinity chromatography, the affinity constants for the antibody-antigen interaction are usually between 10^4 and 10^8 M^{-1} (Johnstone and Thorpe, 1987) and are ideally between 5×10^7 and $5 \times 10^8 \text{ M}^{-1}$ (Jack, 1992) or 2×10^7 and $4 \times 10^8 \text{ M}^{-1}$ (Springer, 1987). Antigen yield typically ranges from 40 to 70% (Springer, 1987) and can be as high as 90% (Johnstone and Thorpe, 1987). Purification factors range from 1,000 to 10,000 fold (Springer, 1987). Immunoaffinity chromatography allows for simple and fast pretreatment of biological matrices, such as plasma and serum, urine, or tissue and plant homogenates.

Immunoaffinity chromatography can be used alone or immunoaffinity precolumns can easily be coupled to an existing liquid chromatography separation system. The critical step in both an off- and on-line system is the desorption step. The desorption of antigen must be quantitative and be eluted in a small volume. The elution volume is especially important in an on-line system, because large volumes will lead to band

broadening. Both aqueous and organic media can be used to desorb the antigen from the immunoaffinity column. Nonselective desorption methods include low pH (Janis, *et al.*, 1989; Van de Water, *et al.*, 1989; Sundberg, *et al.*, 1986; Rybacek *et al.*, 1987), high ionic strength (Van de Water, *et al.*, 1989), and organic media (Murai, *et al.*, 1992; Farjam, *et al.*, 1991b; Johansson, 1986; Nilsson, 1983; Davis, *et al.*, 1985). Immunoselective desorption has also been successfully used (Farjam, *et al.*, 1991a; Haasnoot, *et al.*, 1989; Fusch and Gertman 1974; Farjam, *et al.*, 1991c). Immunoselective desorption is limited to a single antibody, whereas nonselective methods are applicable to a wide range of different antibody-antigen systems.

As with radioimmunoassay, the choice of antibody is of utmost importance. Either polyclonal or monoclonal antibodies can be used in IAC, but for a number of reasons monoclonal antibodies are preferred. Monoclonal antibodies are specific for a single epitope, whereas polyclonal antibodies bind to a variety of epitopes on the same antigen. The cross-reactivity, if any exists, is more defined in a monoclonal system. The most important reason to choose monoclonal antibodies is each has a unique affinity constant, but polyclonal antibodies display a wide range of affinities. Although this wide

range of affinity and specificity guarantees antigen binding, difficulties arise in desorption of the antigen. It may be necessary to use desorption conditions that irreversibly denature the antibody. A monoclonal antibody can be chosen with the desired selectivity and affinity to allow efficient antigen binding and antigen desorption under relatively mild conditions.

Unlike radioimmunoassays, a certain amount of cross-reactivity may be desirable in immunoaffinity chromatography. In fact, in the case of the opioid peptides it is highly desirable. It would be advantageous to be able to isolate as many of the opioid peptides as possible from the sample matrix. The peptides, that have been isolated as a class using immunoaffinity chromatography, can then be further separated using liquid chromatography or mass spectrometry. Specific peptides and metabolites from the opioid family can be selectively isolated from interferences and other opioid peptides in the sample matrix by the proper choice of monoclonal antibody.

Johnstone and Thorpe summarize the advantages of immunoaffinity chromatography as follows:

1. Simplicity - no sophisticated and expensive chromatographic or electrophoretic apparatus are required.

2. Speed - the fractionation is usually rapid, saving time and preserving labile molecules.
3. Yield - can be better than 90% under the right conditions.
4. High purification, by functional selection - can often obtain better than 90% purity from starting material comprising only 1-5% of the required molecule in one step.
5. Applicable even to minor components - the procedure also concentrates the molecule being purified. (Johnstone and Thorpe, 1987)

The goal of this research is to construct an immunoaffinity column to purify leu- and met-enk from plasma. Immunoaffinity pretreatment is compared to the existing solid phase extraction method. The pretreated samples are converted to their 1-cyanobenz[*f*]isoindole (CBI) derivatives with naphthalene-2,3-dicarboxaldehyde in the presence of cyanide ion (NDA-CN) and then analyzed using liquid chromatography. It is demonstrated that immunoaffinity pretreatment has the advantages listed above when applied to the clean-up of enkephalins in a biological matrix.

EXPERIMENTAL

Characterization of Antibodies.

Antibodies LE4H8 and 33FC6 were selected for further characterization and immobilization.

Sub-isotyping. The sub-isotype of the two antibodies was determined using a sub-isotyping kit from Hyclone (Logan, UT). The manufacturer's instructions were followed.

Cross Reactivity. The cross reactivity of the two antibodies was also determined using ELISA procedure 2 already outlined in Chapter 1. Enkephalin analogs were substituted for leu-enk and coadsorbed with BSA.

Competition ELISA. ELISA procedure 2, outlined in Chapter 1, was followed. 33FC6 or LE4H8 (40 μ L) plus serial dilutions of either leu-enk or met-enk (10 μ L) were added to the plate in place of serum or supernatant.

Determination of Apparent Affinity Constant.

The apparent affinity constant was determined using the ELISA procedures 1 and 2 outlined in Chapter 1. The affinity constant can be obtained from the OD_{50} according to the equations presented in Chapter 1.

Preparation of the Immunoaffinity Column.

The antibodies were coupled to Reactigel (Pierce) according to the manufacturer's directions. Two milligrams of 33FC6, LE4H8, or both were coupled to 1 mL of gel. The gel was tumbled end-over-end at 4° for 24 hours. The gel was filtered through a fritted glass disk funnel and remaining active sites were deactivated with 2.0 M Tris-buffer pH = 8.0. The amount of unreacted antibody was determined using the BCA protein assay (Pierce). The non-specific or weakly bound antibody was removed by washing with 0.1 M PB pH = 2.2, and 0.1 M PB pH = 7.4. The gel was packed into a stainless steel column with a volume of 680 μ L (Upchurch Scientific, Inc., Oak Harbor, WA). Bovine serum albumin (5 mg/mL) was injected and eluted multiple times to block non-specific adsorption sites on the gel. The immunosorbent was stored at 4°C in 0.1 M PB pH = 7.4 containing 0.1% NaN_3 . The immunoaffinity column was stored at 4°C when not in use.

Clean-up Procedures.

Solid Phase Extraction. The samples were processed according to Kai, et al., (1988) with the following modifications. There is no homogenization step. The plasma (950 μ L) was spiked with equal amounts of leu- and

met-enk (32.0 nmol, 1.3 nmol, 51.2 pmol, and 0 mol each, in 50 μ L nanopure water) before deproteinization. The final residue is reconstituted in 560 μ L 0.1 M PB, pH = 6.8 and was derivatized with NDA-CN. The derivatized enkephalins were then analyzed by liquid chromatography.

Immunoaffinity Chromatography. Immunoaffinity chromatography was carried out using the flow injection system shown in Figure 2.1. The chromatographic equipment was obtained from Shimadzu Instruments (Baltimore, MD). The system consisted of two Model LC-6A pumps, a Model FCV-2AH high pressure valve, a Model SIL-6A autoinjector, and a Model SPD-2AM UV detector. The data were recorded using the Model C-R4A Chromatopac data system. The system was controlled by a Model SCL-6A controller.

The plasma (160 μ L) was spiked with equal amounts of leu- and met-enk (12.8 nmol, 2.6 nmol, 510.0 pmol, 100.0 pmol, and 0 mol each, in 40 μ L nanopure water). The plasma (50 μ L) was then injected into a flowing stream (0.1 M PB, pH = 7.4) that passed through the immunoaffinity column. The column was washed for 10 minutes with 0.1 M PB, pH = 7.4. Enkephalin was eluted by passing 0.1 M PB, pH = 2.2, through the column for 5 minutes. The column was reequilibrated with

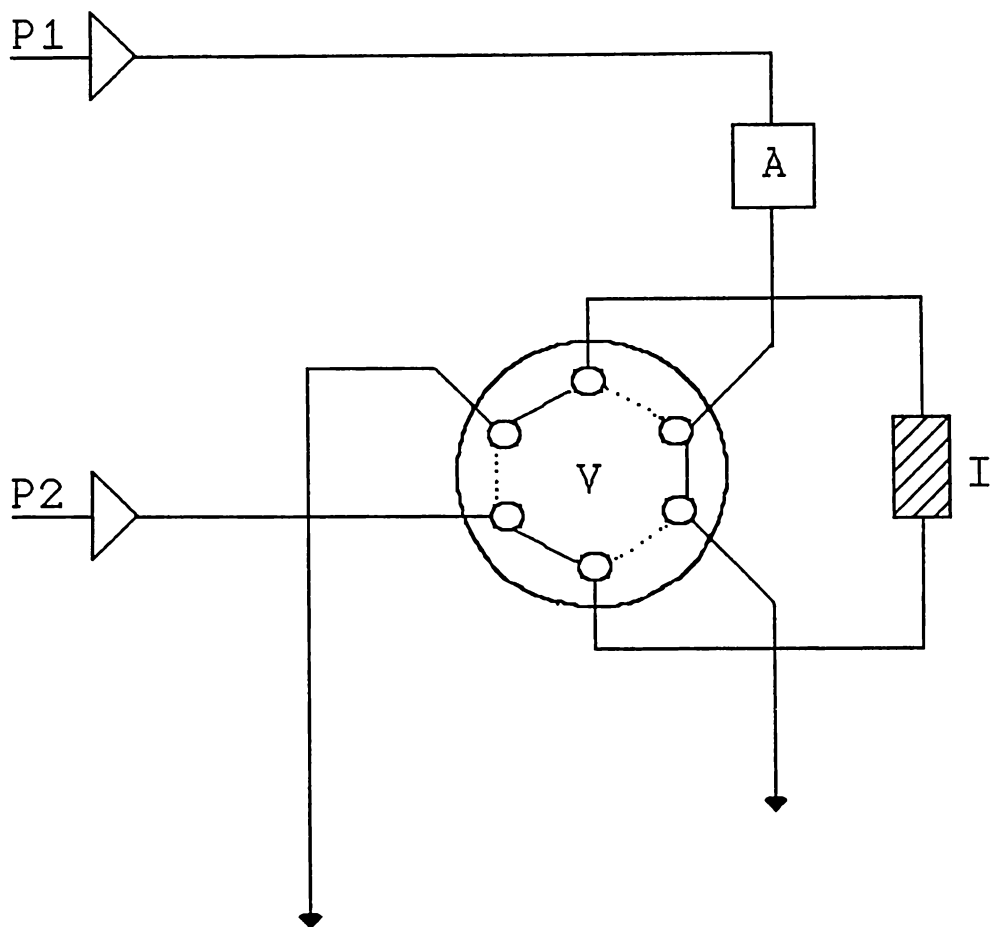

Figure 2.1 Flow injection system used for immunoaffinity chromatography. P1 = pump 1, 0.1 M PB, pH = 7.4, 0.2 mL/min; P2 = pump 2, 0.1 M PB, pH = 2.2, 0.2 mL/min; A = autoinjector; V = valve; I = immunoaffinity column.

0.1 M PB, pH = 7.4 and was ready for another sample. The bound fraction (elution volume = 280 μ L) was collected into 280 μ L of 0.2 M PB, pH = 8.0 (final pH approximately = 6.8) and 50 μ L of 200 mM ascorbic acid. The peptides were then derivatized with NDA-CN. The standards were also derivatized in this 1:1 mixture of 0.1 M PB, pH = 2.2 and 0.2 M PB, pH = 8.0. The derivatized enkephalins were then analyzed by liquid chromatography.

Derivatization Procedure.

Leu-enk and met-enk (standards were dissolved in nanopure water) were converted to their 1-cyanobenz[*f*]is-
oindole (CBI) derivatives according to the procedure of Mifune, *et al.* (1989) with the following modifications. The amount of taurine (200 mM) added to quench the reaction was 20 not 50 μ L. The reaction is shown in Figure 2.2. Leu-enk or met-enk (20 μ L) was added to a mixture of 1:1 0.1 M PB pH = 8.0 and 0.1 M PB pH = 2.2, ascorbic acid (200 mM, 50 μ L, Fisher), sodium cyanide (10 mM, 100 μ L, Fisher), and naphthalene-2,3-dicarboxaldehyde (NDA, 5 mM, 200 μ L, Oread Laboratories, Lawrence, KS). The mixture was shaken for 30 seconds and the reaction was allowed to proceed on ice for 20 minutes. Taurine (200 mM, 20 μ L, Aldrich,

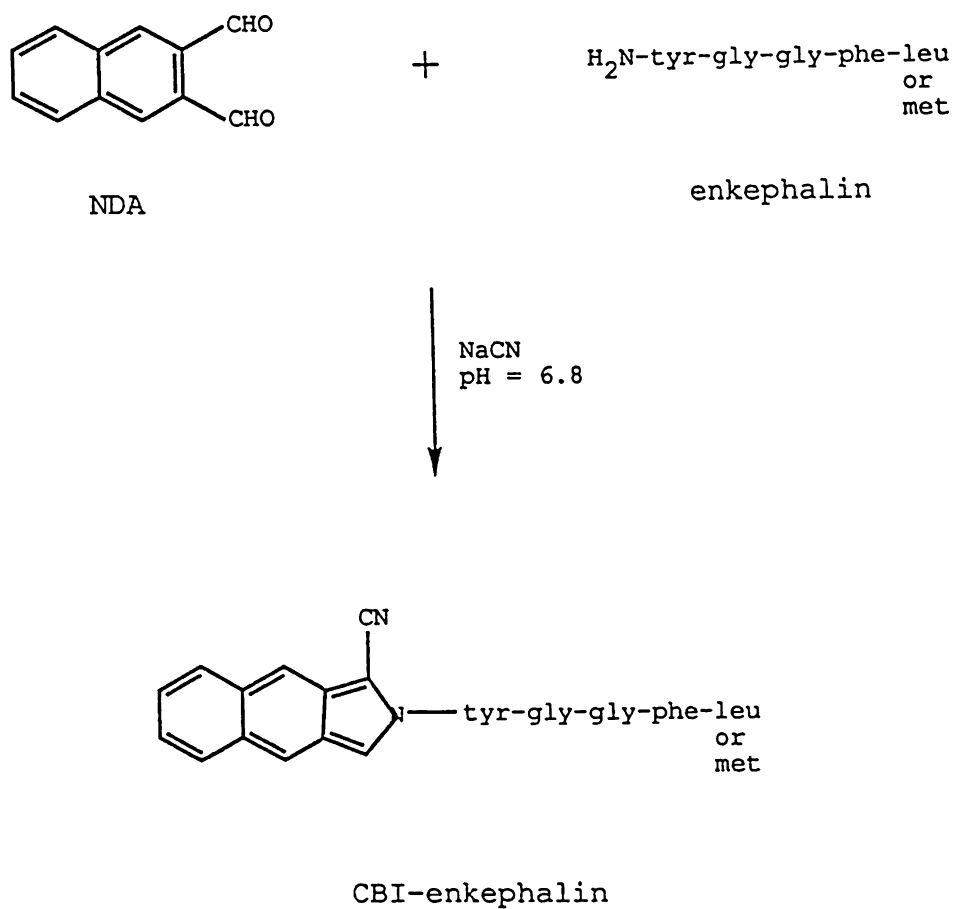

Figure 2.2 The reaction of leu- or met-enk with naphthalene-2,3-dicarboxaldehyde (NDA) in the presence of cyanide ion to produce the CBI derivative of the enkephalin.

Milwaukee, WI) was added to quench the reaction and the mixture was placed on ice for 10 more minutes. The derivatized peptides are stable for 6 hours if kept on ice and protected from light (Mifune, *et al.*, (1989).

Liquid Chromatography.

The chromatographic equipment was obtained from Shimadzu Instruments (Baltimore, MD). The system consisted of a Model LC-6A pump, a Model SIL-6A autoinjector, and a Model RF-535 fluorometric detector (xenon lamp, $\lambda_{em} = 420$ nm, $\lambda_{ex} = 490$ nm). The data were recorded using the Model C-R4A Chromatopac data system. The system was controlled by a Model SCL-6A controller. The Nucleosil C18 liquid chromatography column (5 μ M, 150 mm x 4.6 mm I.D.) was obtained from Alltech, Inc. (Deerfield, IL). The mobile phase used was 40% acetonitrile in 26 mM TFA (pH = 3.5), flow rate = 1.0 mL/min.

RESULTS AND DISCUSSION

Characterization of Antibodies.

The sub-isotype of 33FC6 is IgG₁. LE4H8 was purified from an uncloned cell line. If BSA + leu-enk is coated on the plate and the remainder of the sub-isotype ELISA is carried out as usual the sub-isotype of the leu-enk binding fraction can be determined. The specific antibody sub-isotype is IgG_{2a}.

The cross reactivities of 33FC6 and LE4H8 are shown in Table 2.1. The response to leu-enk is assigned 100%. It must be emphasized that antioxidants were not added to the peptide solutions. The oxidation of met-enk on the plate is partially responsible for the lower binding. Antioxidants are added to the peptide solutions when the immunoaffinity column is characterized.

The epitope of each antibody can be found using the information on cross reactivity and conformational studies of the enkephalins. There have been numerous conformational studies done on the enkephalins and numerous conformations have been reported. The conformations outlined here exist in the solution phase. It must be remembered that the solution phase conformation is probably different from the conformation taken at the receptor. The antibodies bind enkephalin in solution, so those conformations were studied.

Table 2.1
Cross Reactivities of 33FC6 and LE4H8

peptide	% binding	
	LE4H8	33FC6
leu-enk	100	100
met-enk	32	59
3,5-dibromo-tyr-gly-gly-phe-leu	18	95
tyr-D-ala-gly-gly-phe-leu	42	85
gly-gly-phe-leu	18	33
tyr-gly-gly-phe-leu-arg	245	9
tyr-gly-gly-phe-leu-NH ₂	135	7
tyr-D-ala-gly-phe-D-leu	13	6
β-endorphin ¹	+ ²	- ³

¹β-endorphin was adsorbed on the plate at 5 μg/mL in the absence of BSA. The percent binding cannot be compared to the other peptides.

²Indicates binding.

³Indicates no binding.

Both leu- and met-enk have been shown to prefer two conformations, aside from linear. These are β -bend (Vesterman, *et al.*, 1989; Renugopalakrishnan, *et al.*, 1986; Renugopalakrishnan, *et al.*, 1985; Levine, *et al.*, 1979; Stimson, *et al.*, 1979; Khaled, *et al.*, 1977; Jaureguiberry, *et al.*, 1976; Jones, *et al.*, 1976.) and a dimer β -sheet (Renugopalakrishnan, *et al.*, 1986; Renugopalakrishnan, *et al.*, 1985; Khaled, *et al.*, 1977) and linear. These conformations can also coexist in solution (Surewicz, *et al.*, 1988; Renugopalakrishnan, *et al.*, 1986; Spirtes, *et al.*, 1978; Khaled, *et al.*, 1977). The β -bend can occur at either the Gly²-Gly³ or Gly³-Phe⁴ position. The existence of both folded and extended conformations of the enkephalins was found using X-ray crystallographic techniques, also (Camerman and Camerman 1986). It has been shown that the β -bend of the Tyr-Gly-Gly-Phe sequence of the enkephalins is maintained in β -endorphin (Cabassi and Lucia, 1982).

It is evident from Table 2.1 that 33FC6 binds to the carboxyl terminal of leu-enk. At first glance, the binding results indicate that 33FC6 binds to a linear conformation of leu-enk. The binding of 33FC6 is drastically reduced when changes are made on the carboxyl terminal. If 33FC6 does bind to a conformation of leu-enk, then the deletion of the tyr residue on the opposite

end of the molecule should not alter the binding characteristics. It can be seen in Table 2.1 that the binding to gly-gly-phe-leu is substantially lowered. 33FC6 must bind leu-enk in a folded conformation where the tyr residue is brought closer to the carboxyl terminal of the molecule. The proposed conformations of leu-enk, gly-gly-phe-leu and epitope of 33FC6 are shown in Figure 2.1. The β -bend conformation of leu-enk is stabilized by 2 hydrogen bonds, while that of gly-gly-leu has only one hydrogen bond. While the tyr residue is not essential for 33FC6 to bind, its absence destabilizes the β -bend leading to lower binding.

According to Table 2.1, LE4H8 binds to the amino terminal of leu-enk. Again, the results indicate that when the amino terminal is altered, binding is decreased. It is surprising that when an arg residue or NH_2 group is added to the carboxyl terminal, the binding of LE4H8 is enhanced. These two peptides are more hydrophilic than leu-enk, so the increased binding cannot be attributed to a higher amount adsorbed on the plate. This increased binding is due to the stabilization of a β -bend conformation. The proposed conformation of leu-enk, tyr-gly-gly-phe-leu-arg, and epitope of LE4H8 are shown in Figure 2.2. It can be seen that the β -bend in leu-enk is stabilized by two hydrogen bonds, but the arg-addition

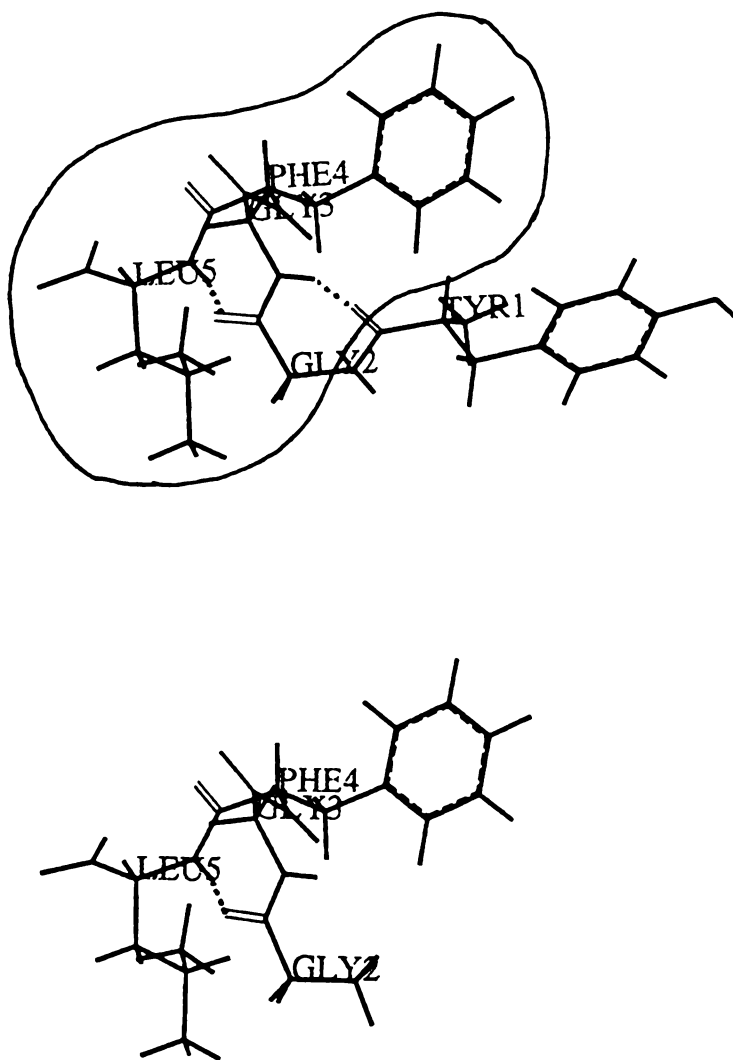

Figure 2.1 The proposed conformation of leu-enk and gly-gly-phe-leu. Hydrogen bonds are represented by dotted lines. The epitope of 33FC6 is indicated by the solid line. This figure was generated in the Molecular Modeling Laboratory at Kansas University with the aid of Christopher Gunn.

peptide is stabilized by four hydrogen bonds. Although it is not shown, the NH₂-addition peptide is also stabilized by three hydrogen bonds. The enhanced binding is explained by the further stabilization of the β -bend. The additional arg or NH₂ is "tucked up" on the back side of the peptide where it does not sterically hinder binding.

Neither 33FC6 nor LE4H8 binds to the peptide where L-gly² and L-leu are substituted by D-ala² and D-leu, respectively, while both antibodies bind when only the L-gly² is changed. This is further evidence for the β -bend conformation. It has been shown that the D-ala² peptide has two γ bends in its backbone, but its conformation is only slightly changed from leu-enk (Dhingra and Saran, 1989; Toshimasa, *et al.*, 1988). When D-leu is substituted for L-leu, the bulky side chain is no longer in the binding site of the antibody.

The results of the competition ELISAs are shown in Figures 2.3, 2.4. Figure 2.3 shows the response of LE4H8 to BSA + leu-enk on the plate. LE4H8 has a 10-fold lower affinity for met-enk in solution than leu-enk. LE4H8 does not bind to BSA + met-enk on the plate, so no plot is shown. Figure 2.4 shows the response of 33FC6 to BSA + leu-enk and BSA + met-enk on the plate. 33FC6 has a 2-fold lower affinity for met-enk in solution than

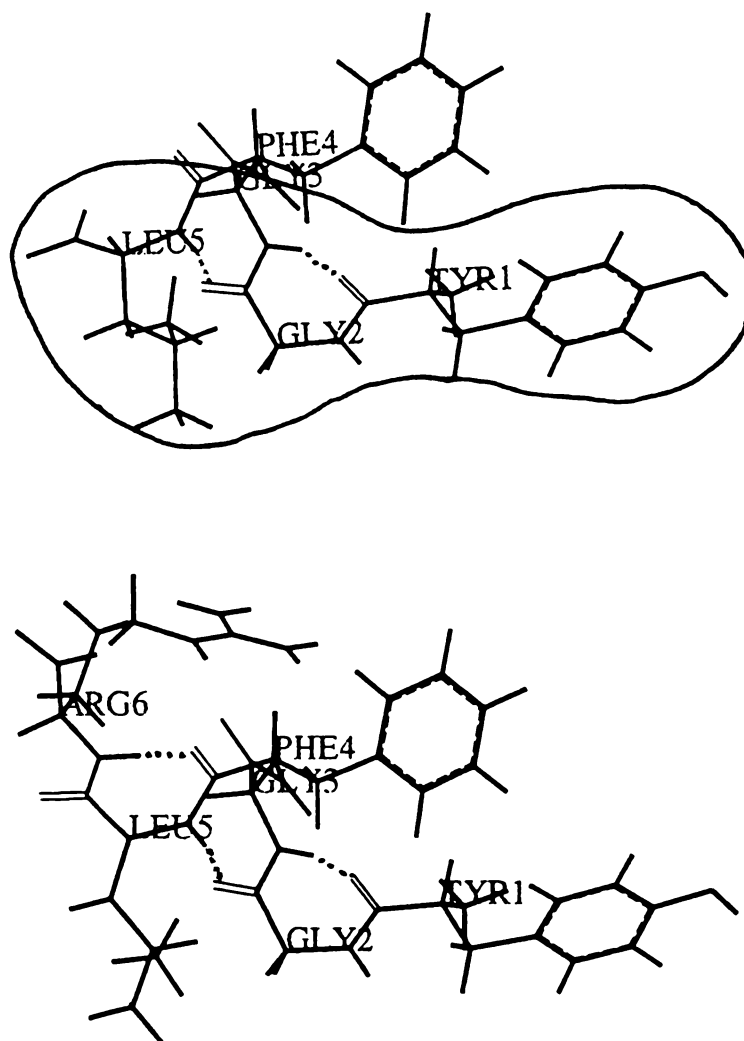

Figure 2.2 The proposed conformation of leu-enk and the arg addition peptide. Hydrogen bonds are represented by dotted lines. The epitope of LE4H8 is indicated by the solid line. This figure was generated in the Molecular Modeling Laboratory at Kansas University with the aid of Christopher Gunn.

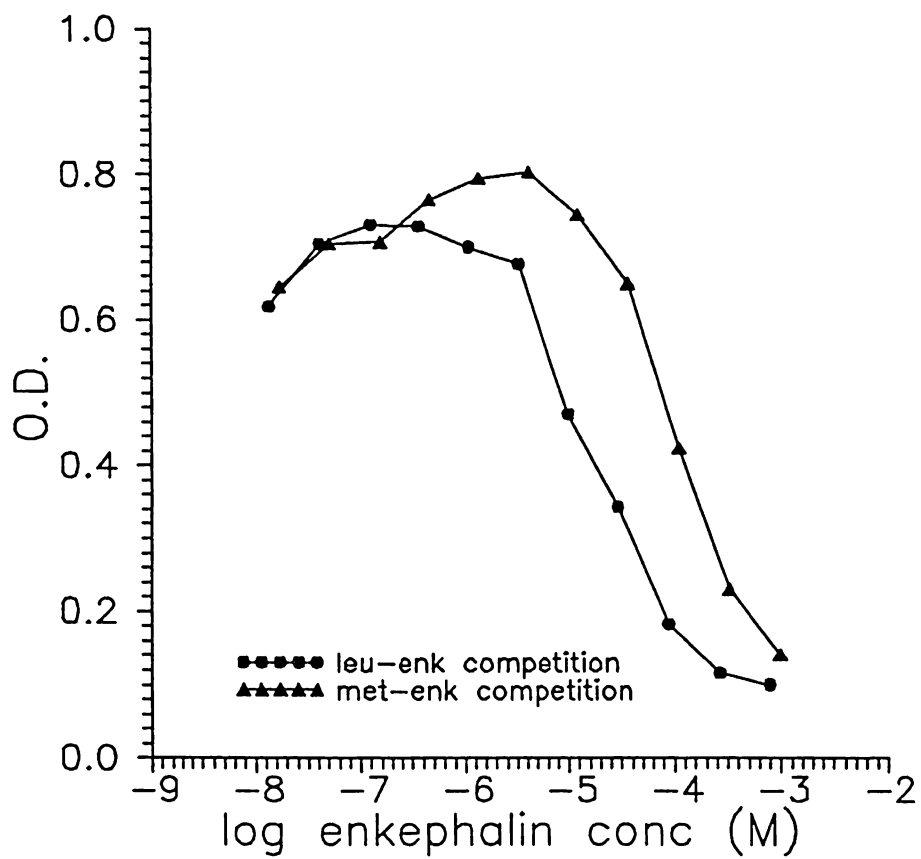

Figure 2.3 Competition of LE4H8 with leu- or met-enk. The plate is coated with BSA + leu-enk.

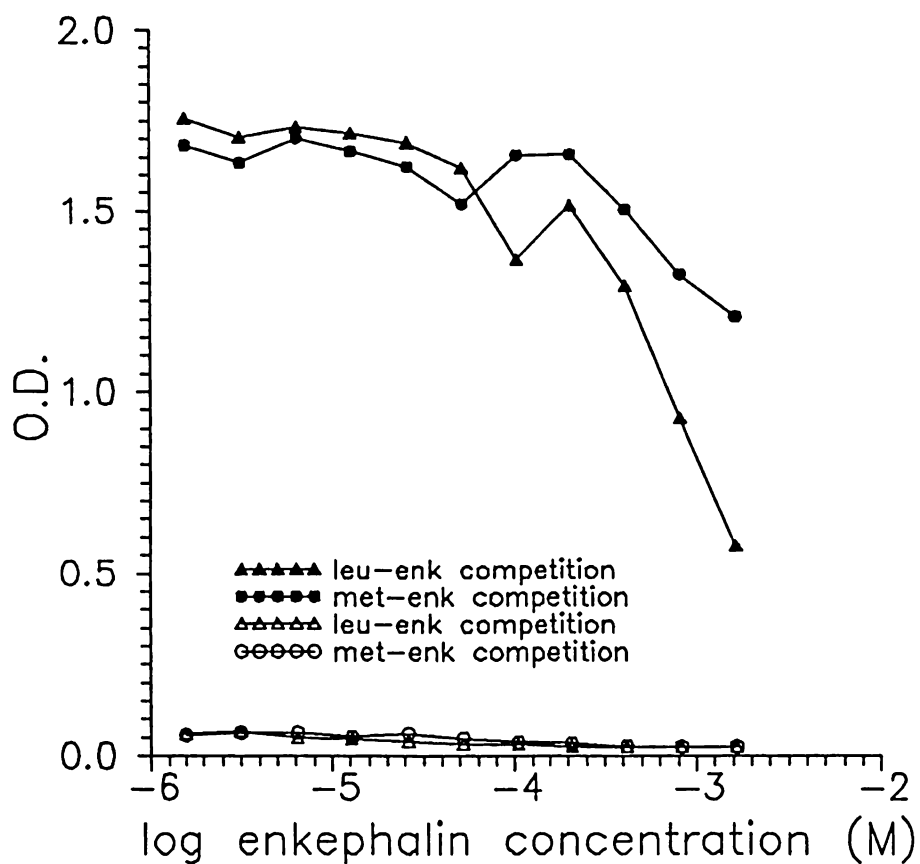

Figure 2.4 Competition of 33FC6 with leu- or met-enk. Open symbols represent met-enk coated plate and closed symbols represent leu-enk coated plate.

leu-enk. 33FC6 binds weakly to BSA + met-enk on the plate, only slightly better than LE4H8.

Determination of Apparent Affinity Constant.

The titration curves of 33FC6 and LE4H8 are shown in Figures 2.5, 2.6, and 2.7. The apparent affinity constant can be determined from OD_{50} , as shown in Chapter One. The apparent affinity constants of 33FC6 and LE4H8 for BSA + leu-enk $1.7 \times 10^7 M^{-1}$ and $2.0 \times 10^7 M^{-1}$, respectively. The apparent affinity constants make these antibodies reasonably suited for immunoaffinity chromatography. The range of antibody affinities that is applicable for immunoaffinity chromatography is 10^4 to $10^8 M^{-1}$ (Phillips, 1989). The apparent affinity constants of 33FC6 and LE4H8 for the BSA-enkephalin conjugate are $3.6 \times 10^8 M^{-1}$ and $9.1 \times 10^8 M^{-1}$, respectively. The affinity of both antibodies for the BSA-enkephalin conjugate are an order of magnitude higher than for BSA + leu-enk. There are many possible reasons for the higher affinity of the antibodies for the BSA-enkephalin conjugate. First it is possible that there is a higher concentration of leu-enk on the plate when adsorbed as the conjugate. No studies were done to determine the amounts of leu-enk that were adsorbed on the ELISA plate. Second, the conjugate may

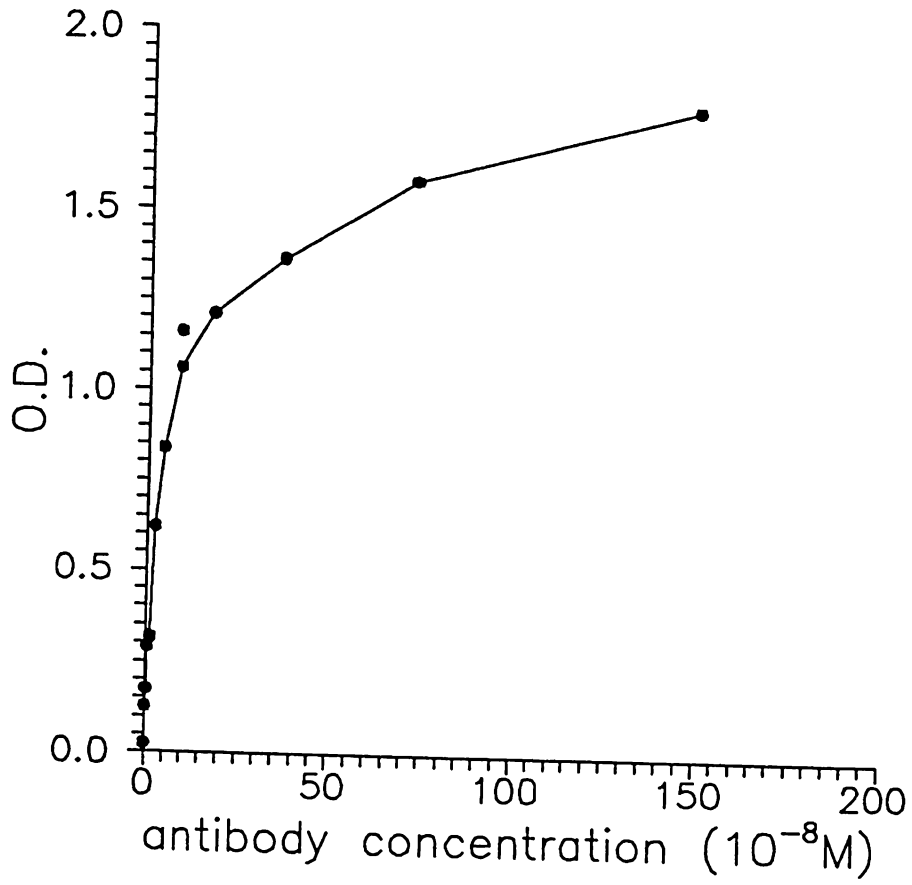

Figure 2.5 Titration curve of 33FC6. The plate is coated with BSA + leu-enk.

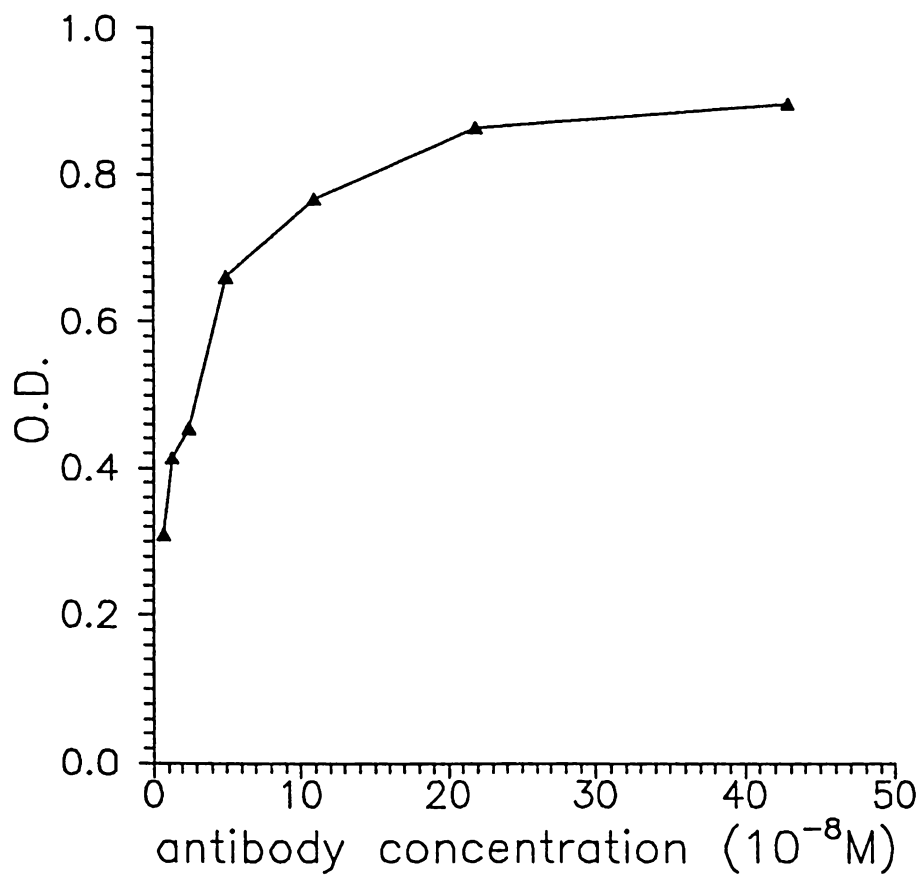

Figure 2.6 Titration curve of LE4H8. The plate is coated with BSA + leu-enk.

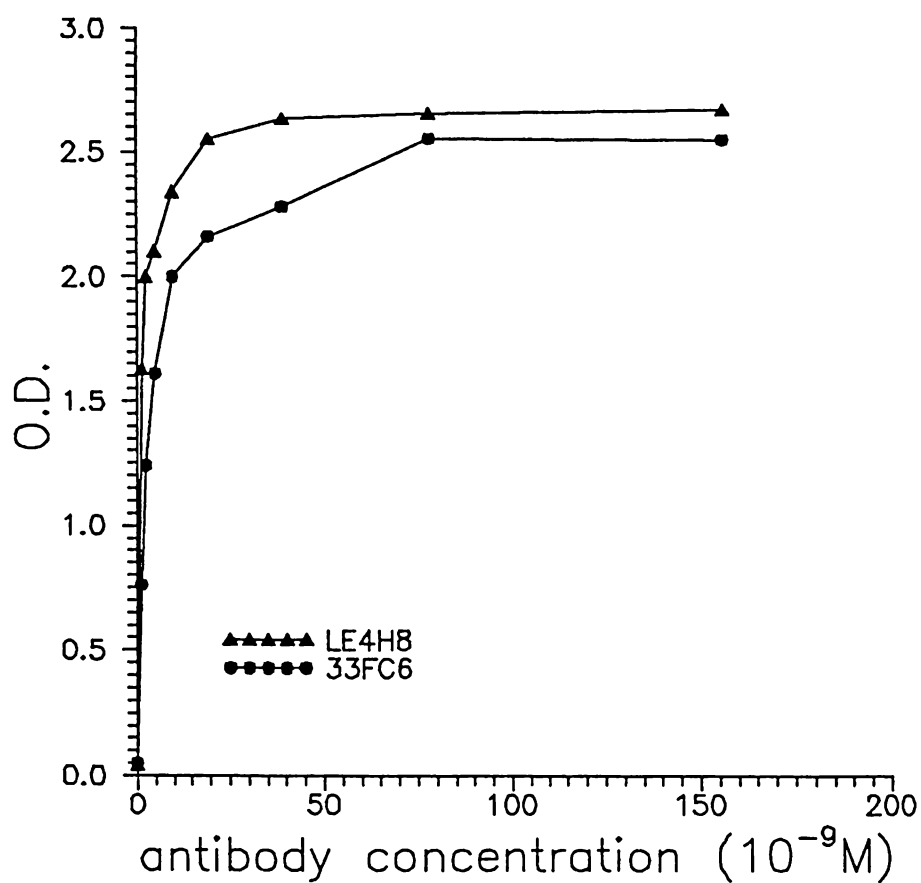

Figure 2.7 Titration curves of 33FC6 and LE4H8. The plate is coated with BSA-enkephalin conjugate.

present leu-enk in a favored conformation. Third, the antibodies may bind to amino acids on both leu-enk and BSA. Lastly, perhaps when BSA and leu-enk are coadsorbed, the BSA covers leu-enk or hinders antibody binding.

Clean-up Procedures.

The chromatography used to separate leu- and met-enk is not fully optimized. It is single column, isocratic elution, with fluorescent detection. In essence, it is "the worst case scenario" of separations. The over-all detection limit is defined by the chromatography. Picomole quantities of enkephalin can be detected using a single column and isocratic elution. Kai, *et al.*, (1988) reports a limit of detection of 5.6 pmole/gram tissue using a single reverse phase column and fluorescent detection and De Montigny (1987) reports a detection limit of 62.5 pmole/mL plasma. The limit of detection can be improved orders of magnitude by employing multi-dimensional chromatography. Mifune, *et al.*, (1989) reports a limit of detection of 100 fmole/gram tissue using multi-dimensional chromatography and fluorescent detection. Dave (1989) reports a limit of detection of 36 fmole/gram tissue using multi-dimensional chromatography and laser induced fluorescent detection.

Although the lowest limit of detection cannot be achieved using the chromatographic system outlined here, it is still possible to demonstrate the advantages of immunoaffinity pretreatment.

Solid Phase Extraction. The extraction method was described by Kai, et al., (1988) and Mifune, et al., (1989). Both reported recoveries of approximately 80%. The recovery results of solid phase extraction pretreatment of enkephalin spiked plasma is shown in Figure 2.8. The recoveries achieved here were below 50%. No attempts were made to optimize the recovery. Although careful flow rate control (using syringe pumps) would increase the recovery, this was not done because solid phase extraction is not the emphasis of this work. Solid phase extraction was carried out for comparison purposes only. Met-enk is not shown in Figure 2.8 because it could not be quantified due to an interference peak caused by an NDA/CN side reaction. The interference was not reproducible, so it could not be subtracted.

A typical chromatogram after pretreatment using solid phase extraction is shown in Figure 2.9. It can be seen that many other species are still present even after pretreatment. The limit of detection was 51 pmole/mL of leu-enk in plasma. The limit of detection is comparable

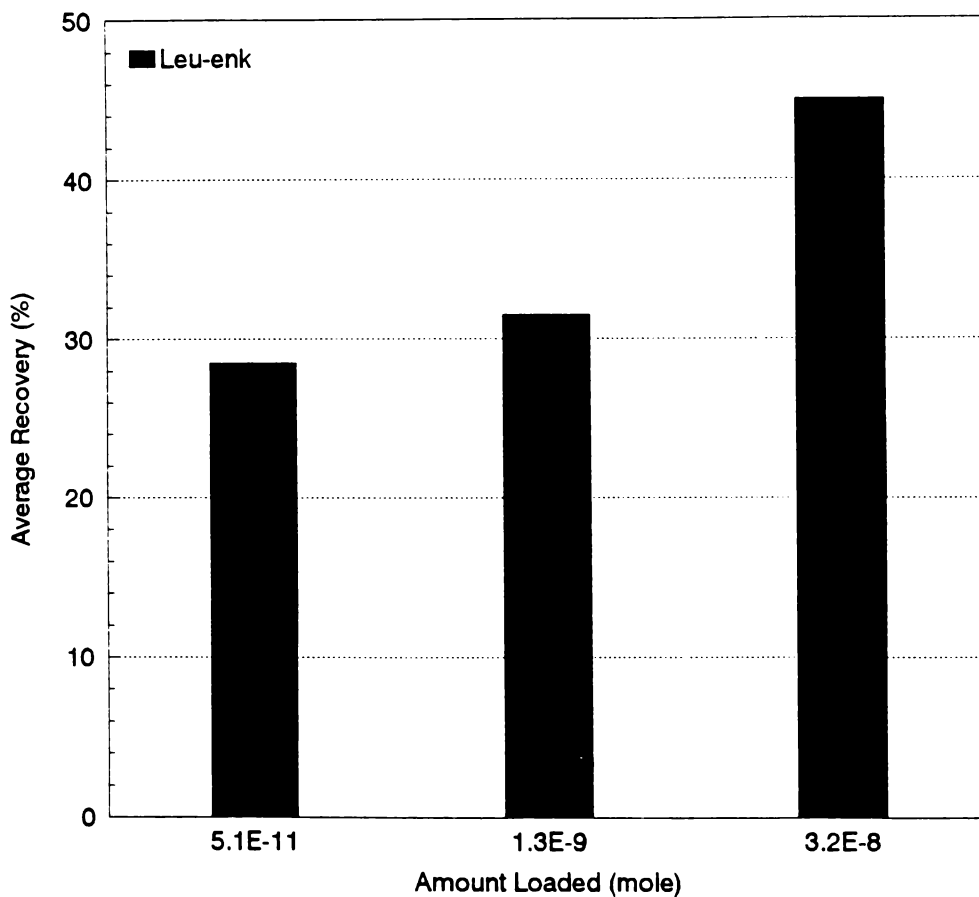

Figure 2.8 Recovery of three different amounts of leu- and met-enk loaded onto a solid phase extraction cartridge. The samples were derivatized with NDA-CN and analyzed using liquid chromatography as outlined in the experimental section.

to those found previously using a single column and fluorescent detection (Kai, *et al.*, 1988; De Montigny, 1987).

Immunoaffinity Chromatography. Both antibodies, 33FC6 and LE4H8, bound to Reactigel with approximately 100% efficiency. The capacity of each immunoaffinity column was determined by multiple injections of small volumes of leu- and met-enk (3.2×10^{-9} M, in 0.1 M PB pH = 7.4) under flowing conditions. The capacity of the columns was studied after the columns had been cycled about five times. There is always an initial decrease in capacity of immunoaffinity columns during the first few runs. This is due to the leaching of weakly bound antibody or irreversible denaturation (Farjam, *et al.*, 1991a). The true capacity cannot be found until this decrease reaches a plateau. The capacities of the 33FC6, LE4H8, and coimmobilized antibody columns were 3.1×10^{-9} , 4.3×10^{-9} , and 3.2×10^{-9} mole enkephalin, respectively. The capacity is sufficient for the amounts of enkephalins found in most biological samples. The amount of active antibody in each column is equal, within experimental error. The percentage of active antibody (ratio of active antibody to total antibody bound) is 38, 46, and 38% for 33FC6, LE4H8, and coimmobilized, respectively. These percentages are typical for immobilization through

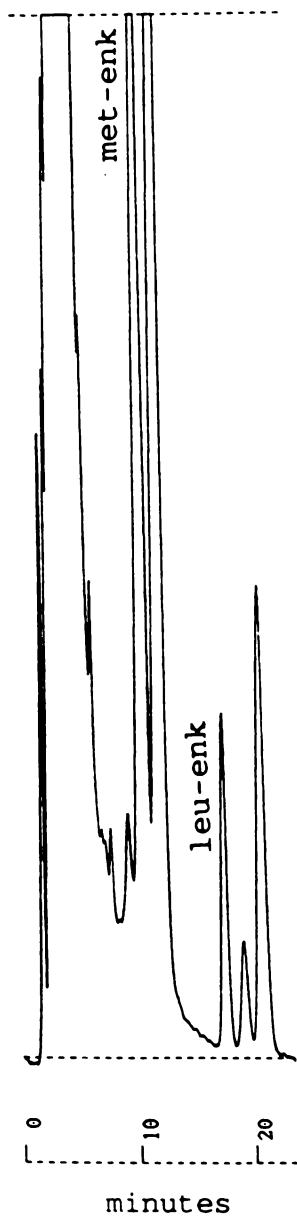

Figure 2.9 Chromatogram of plasma spiked with 1.28×10^{-9} mole of leu- and met-enk. The sample pretreatment was solid phase extraction.

the amine groups. The percent of active antibody can be increased by directed immobilization through the carbohydrate or thiol moieties. The amount of active antibody can also be increased by simply using a column with a larger bed volume.

A typical immunoaffinity elution profile is shown in Figure 2.10. The pretreatment of sample is completed in less than 20 minutes. The recovery from the 33FC6 and LE4H8 immunoaffinity columns are shown in Table 2.2. The overall recovery is less than 25%. This is below the recovery value typically found. The problem is either that the binding or desorption step is not efficient. When 1.3×10^{-10} mole of enkephalin is loaded onto the immunoaffinity column in buffer, the recovery is 100%. This implies that the low recovery is not due to inefficient desorption. No improvement in recovery was seen when enkephalin spiked plasma was diluted 1/10, in 0.1 M PB pH = 7.4, and the injection volume increased to 500 μ L. This proves that lowering the viscosity of the sample does not improve binding efficiency. The low recovery is either because the affinity of the antibodies is too low or the enkephalins are being bound or degraded in plasma.

Coimmobilization of 33FC6 and LE4H8 did show some improvement in the recovery. The results are shown in

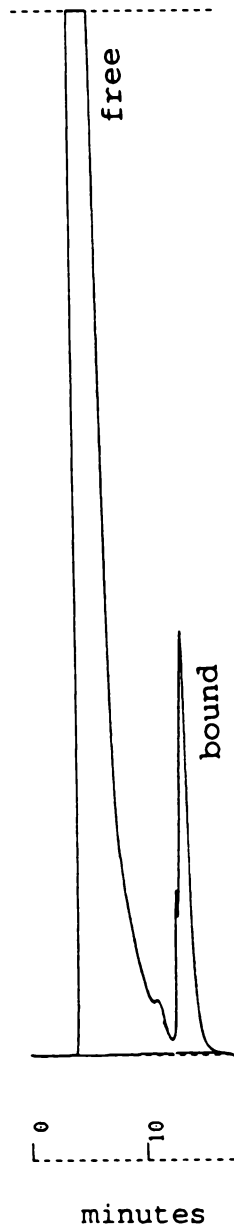

Figure 2.10 Typical immunoaffinity elution profile of plasma spiked with leu- and met-enk.

Table 2.2

Recovery of Enkephalin Using Either the 33FC6 or LE4H8
Immunoaffinity Column

antibody immobilized	moles enkephalin loaded	leu-enk recovery %	met-enk recovery %
33FC6	6.5×10^{-11}	10 ± 4	17 ± 11
	1.3×10^{-10}	13 ± 2	21 ± 10
	6.4×10^{-10}	12 ± 2	22 ± 3
	3.2×10^{-9}	17 ± 2	24 ± 2
LE4H8	2.6×10^{-11}	---*	52 ± 10
	1.3×10^{-10}	44 ± 11	26 ± 2
	6.4×10^{-10}	26 ± 2	28 ± 2
	3.2×10^{-9}	20 ± 1	26 ± 2

*Could not be reproducibly determined.

Table 2.3. It can be seen that the recovery approaches 50%. The elution volume is increased to 560 μL when 33FC6 and LE4H8 are coimmobilized. Half of this volume (280 μL) is used for derivatization and chromatographic analysis. The elution volume is greater because the two monoclonal antibodies act as a polyclonal population with different affinity constants. Polyclonal antibodies are essentially a population of different monoclonal antibodies and can also be used in immunoaffinity chromatography. The advantage of using monoclonal antibodies is that the specificity and affinity are much more defined.

The recovery of enkephalin was still below typical values reported using immunoaffinity chromatography. The enkephalins are highly susceptible to enzymatic degradation. There is controversy about the half-life of enkephalins in plasma, but the values range from a few seconds up to 8 minutes (Roda, *et al.*, 1986). Addition of enzyme inhibitors, such as aprotinin, and acidification of the plasma has been shown to completely inhibit enzymatic degradation (Mifune, 1987; Clement-Jones, *et al.*, 1980). Acidification of the plasma is not possible when using immunoaffinity chromatography, so aprotinin (10,000 KIU/10 mL plasma, Sigma) was added to the plasma. The addition of aprotinin alone, does not

Table 2.3

Recovery of Enkephalin Using the Coimmobilized
33FC6 and LE4H8 Immunoaffinity Column

moles enkephalin loaded	leu-enk recovery %	met-enk recovery %
2.6×10^{-11}	96 ± 17	---*
1.3×10^{-10}	51 ± 4	56 ± 15
6.4×10^{-10}	39 ± 7	64 ± 14
3.2×10^{-9}	42 ± 4	38 ± 3

*Could not be determined due to interference peak caused by an NDA/CN side reaction.

fully inhibit enzyme degradation. Clement-Jones, *et al.*, (1980) report that approximately 75% of the enkephalin remains after aprotinin is added to plasma.

The recovery of leu- and met-enk using coimmobilized 33FC6 and LE4H8 and aprotinin is shown in Table 2.4. It can be seen that the addition of aprotinin substantially improves the recovery. The recovery of leu-enk is approximately 90% and that is comparable to the recovery found using solid phase extraction sample clean-up. There is a sharp decrease in recovery when the total amount of enkephalin loaded onto the column is 3.0×10^{-10} mole or more. The capacity of the column appears to be somewhat lower than determined, but is still adequate for the levels of enkephalin found in plasma and most tissue samples.

Compared to solid phase extraction, the use of immunoaffinity chromatography reduces the time and number of steps in the clean-up procedure. The enkephalins are isolated in less than 20 minutes. Immunoaffinity chromatography is easily automated, so the manual labor is virtually eliminated. The enkephalins are isolated and concentrated all in one step. The volume of sample loaded onto the immunoaffinity column is only limited by the capacity of the column. In the case of enkephalins, 10 to 100 mL of plasma can be injected onto the column

Table 2.4

Recovery of Enkephalin Using the Coimmobilized
33FC6 and LE4H8 Immunoaffinity Column
Aprotinin is Added to Plasma

moles enkephalin loaded	leu-enk recovery %	met-enk recovery %
3.0×10^{-11}	98 ± 2	---*
6.0×10^{-11}	90 ± 4	---
1.2×10^{-10}	83 ± 5	103 ± 5
3.0×10^{-10}	67 ± 5	70 ± 6
6.4×10^{-10}	54 ± 3	53 ± 3
3.2×10^{-9}	50 ± 2	43 ± 4

*Could not be determined due to interference peak caused by an NDA/CN side reaction.

without overloading. The pre-concentration then, is quite impressive. The LE4H8, 33FC6, and coimmobilized antibody immunoaffinity columns were recycled approximately 50, 90, and 70 samples, respectively, without any change in recovery. It is true that monoclonal antibodies can be expensive, but immobilized antibodies are cost effective when compared to the high price of single use solid phase extraction cartridges.

The most significant advantage of immunoaffinity chromatography can be seen in Figures 2.10 and 2.11. The high degree of purification that immunoaffinity chromatography provides is obvious. The chromatograms are virtually free of any interfering peaks. This cannot be said for the solid phase extraction method carried out here or others previously (Mifune, *et al.*, 1989; Kai, *et al.*, 1988). The void peak (CBI-*taurine*) is considerably larger in the immunoaffinity chromatography samples. The blank and *enkephalin* spiked plasma samples were analyzed in the absence of *taurine*. There are no interfering peaks hidden under the CBI-*taurine* peak. The *taurine* must be added due to the instability of NDA in the presence of cyanide. The limit of detection is 30 pmole of *leu-enk* injected onto the immunoaffinity column. This is comparable to those reported previously (Mifune, *et al.*, 1989; Kai, *et al.*, 1988).

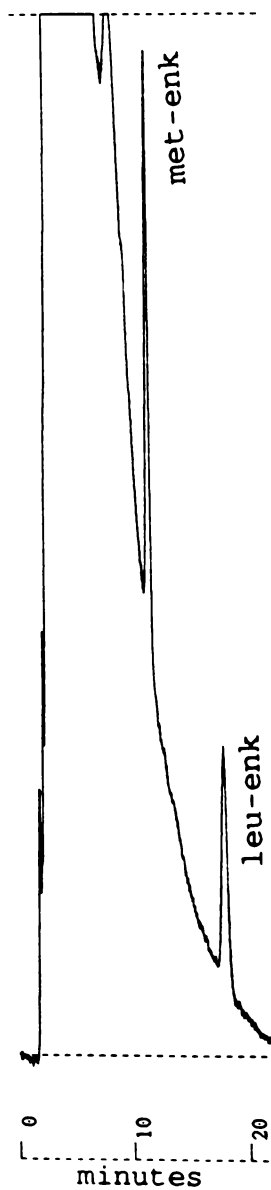

Figure 2.10 Chromatogram of plasma spiked with 3.0×10^{-10} mole of leu- and met-enk. The sample pretreatment was immunoaffinity chromatography using coimmobilized 33FC6 and LE4H8.

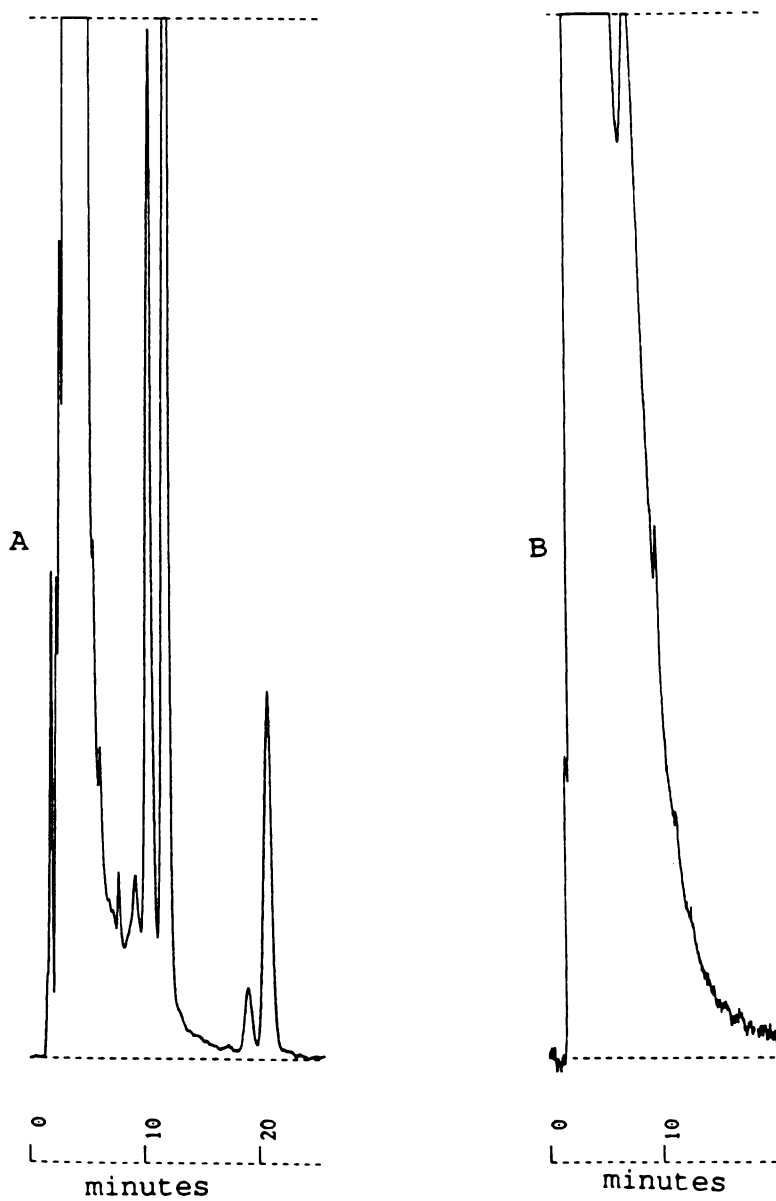

Figure 2.11 Chromatograms of a plasma blank. The sample pretreatment was A) solid phase extraction and B) immunoaffinity chromatography.

The results here demonstrate that immunoaffinity chromatography provides a fast, simple, and efficient means of sample pretreatment. The recovery and limit of detection are comparable to solid phase extraction and it much faster and easier. The amount of purification that immunoaffinity chromatography provides far exceeds that of solid phase extraction. It has been proven that immunoaffinity chromatography does display the advantages outlined at the beginning of this chapter.

FUTURE DIRECTIONS

The results here prove that both leu- and met-enk can be isolated using immunoaffinity chromatography. In order to lower the limit of detection and improve met-enk quantitation, multi-dimensional chromatography must be used. The final goal of this work is to isolate as many peptides (and peptide metabolites) in the opioid family as possible. The two antibodies, 33FC6 and LE4H8, must be used in combination to accomplish this. Only by using the combination will the various peptides and metabolites be captured, because the antibodies recognize opposite ends of the enkephalin sequence. The peptides shown in Table 2.1 (excluding β -endorphin) can be studied in the same manner that leu- and met-enk were. The final step in this research would be to couple the immunoaffinity column on-line with multi-dimensional liquid chromatography. The analysis of the entire family of opioid must wait upon further developments in detection methods.

CHAPTER THREE
DETERMINATION OF CHOLESTEROL AND ITS DISTRIBUTION
IN HUMAN PLASMA

INTRODUCTION

The accurate and reproducible determination of cholesterol is of great importance in identifying those individuals who are at risk of heart disease. Cholesterol does not circulate freely in the body, but is transported in lipoprotein particles. The three major classes of lipoproteins are present in plasma in the fasting state are very low density lipoprotein (VLDL), low density lipoprotein (LDL), and high density lipoprotein (HDL). HDL can be further divided into two subclasses, HDL₂ and HDL₃. Other lipoproteins, such as chylomicrons exist only for a short time after a meal and intermediate density lipoprotein is in low concentration. The structure of a typical lipoprotein is shown in Figure 3.1. Lipoproteins are spherical, noncovalent complexes which contain specific proteins, cholesterol esters (2/3 of total cholesterol), cholesterol, triglycerides, and phospholipids. Some properties of the different lipoprotein classes are shown in Table 3.1. Lipoproteins account for 8 to 10% of total serum proteins. The lipoproteins have a density of less than 1.21 g/mL, compared to greater than 1.3 g/mL for other serum proteins. In the assessment of risk, it is not only necessary to determine the total cholesterol, but how it is distributed among the circulating lipoproteins.

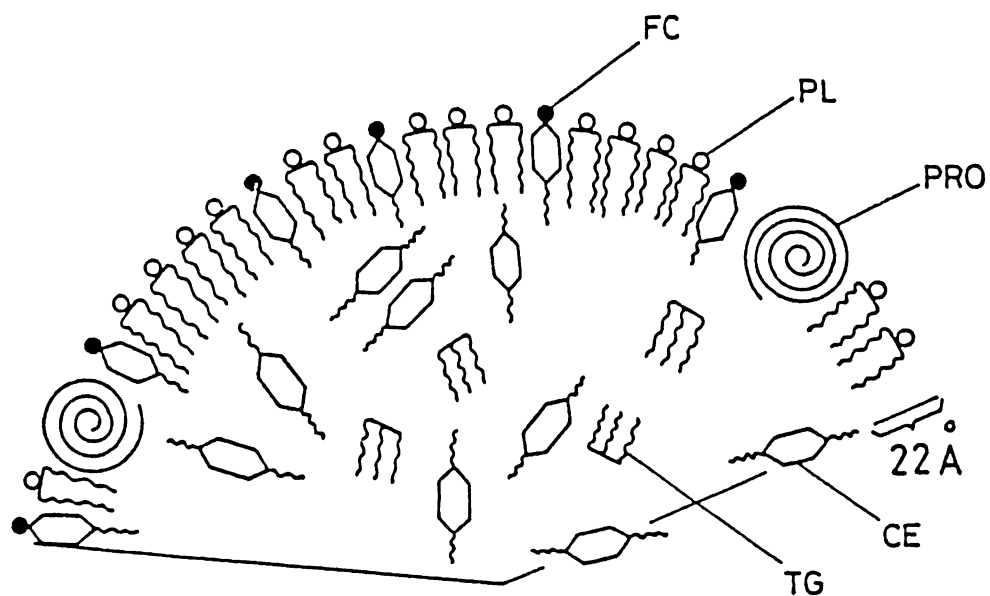

Figure 3.1 Segment of a typical lipoprotein.
FC = free cholesterol; PL = phospholipid;
PRO = protein; CE = cholesterol ester;
TG = triglyceride. Reprinted with permission from
Fundamentals of Clinical Chemistry, 2nd edn; Tietz NW,
Ed.; W.B. Saunders Co., Philadelphia, 1976.

Table 3.1
Properties of Human Lipoproteins

	mol. wt. ($\times 10^6$ D)	diameter (\AA)	density (g/mL)
VLDL	6.0	250 - 750	0.95 - 1.006
LDL	1.8	200 - 250	1.019 - 1.063
HDL ₂	0.4	70 - 120	1.063 - 1.125
HDL ₃	0.2	50 - 100	1.125 - 1.210

The current Definitive Method for serum cholesterol is an isotope-dilution gas chromatography/mass spectrometry method (Cohan, *et al.*, 1980). This method was developed and is maintained by the National Institute of Standards and Technology. The current Reference Method is the Abell-Levy-Brodie-Kendall (Abell, *et al.*, 1958) procedure as established and maintained by the Centers for Disease Control (CDC). Clinical methods for cholesterol analysis must be calibrated by the Reference Method, which is validated relative to the Definitive Method.

The method of Abell, *et al.*, (1958) is still used in reference laboratories, but although it is highly accurate, it is quite laborious. Because of this, enzymatic methods of cholesterol determination were introduced about 15 years ago. The enzymatic methods use cholesterol esterase (CE), cholesterol oxidase (CO), and peroxidase (PO) in the reaction sequence shown here.

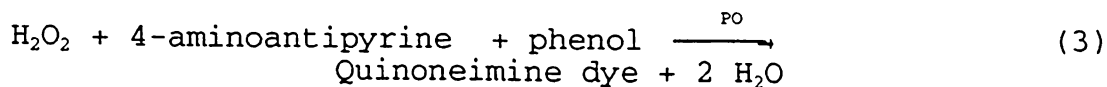
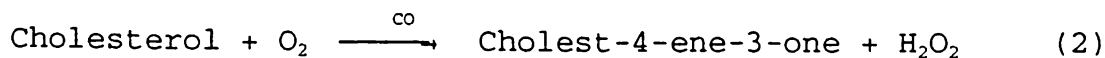
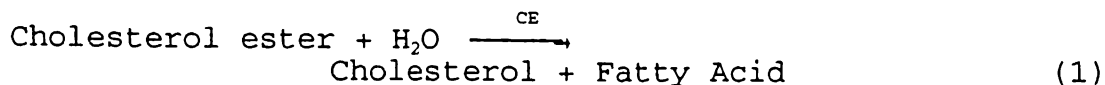

The measurement of total cholesterol is quite simple. An aliquot (5 to 10 μL) of plasma or serum is incubated with the enzymatic solution for about 10 minutes and the mixture is analyzed photometrically. The lipoprotein cholesterol is related to total cholesterol as follows:

$$\text{Total cholesterol} = \text{VLDL cholesterol} + \text{LDL cholesterol} + \text{HDL cholesterol.} \quad (4)$$

The first step in the measurement of lipoprotein cholesterol is the isolation of the lipoprotein of interest. VLDL is separated by ultracentrifugation of the plasma or serum (no density adjustment needed) at $105,000 \times g$ for 18 hours at 10°C (Bachorik, 1989). The VLDL accumulates as a floating layer, while LDL and HDL sediment. VLDL is not usually measured directly because it is difficult to recover quantitatively. Instead VLDL cholesterol is calculated according to the following:

$$\text{VLDL cholesterol} = \text{total cholesterol} - \text{infranatant cholesterol.} \quad (5)$$

LDL cholesterol is commonly quantified using two methods. In the first method, total cholesterol, HDL cholesterol, and triglycerides are measured, while LDL cholesterol is calculated using the Friedewald equation (Friedewald, *et al.*, 1972):

$$\text{LDL cholesterol} = \text{total cholesterol} - \text{HDL cholesterol} - \text{triglyceride}/5. \quad (6)$$

The triglyceride level is determined enzymatically. The Friedewald equation holds only if the triglyceride level is less than 400 mg/dL. If the triglyceride level is too high, then preparative ultracentrifugation is used. The conditions are the same as for VLDL separation. The LDL cholesterol can be calculated as follows:

$$\text{LDL cholesterol} = \text{infranatant cholesterol} - \text{HDL cholesterol}. \quad (7)$$

HDL cholesterol is measured directly after it has been separated from the other lipoproteins. Generally the other lipoproteins are removed by precipitation. Precipitation methods can be used for the isolation of both HDL and LDL, although the isolation of HDL is more common. Agents, such as heparin sulfate-MnCl₂, dextran sulfate, and polyvinyl sulfate selectively precipitate

LDL from serum or plasma. HDL can be quantified directly from the supernatant while LDL and VLDL are indirectly measured from the difference between total and supernatant cholesterol, according to the equations shown above (Steele, *et al.*, 1976; Bachorik and Kwiterovich 1991; Bachorik, 1989; Warnick, *et al.*, 1982; Rifai, *et al.*, 1992; Bachorik and Albers, 1986). LDL can be directly measured with immunoprecipitation using an anti-HDL antibody (Kerscher, *et al.*, 1985). The precipitation methods are simple and rapid, but the precipitating agents interfere with cholesterol analysis and complete precipitation is dependent on triglyceride levels (Bachorik, 1989).

All of the classes and subclasses, not only LDL, of lipoproteins can be isolated using ultracentrifugation. There are numerous ultracentrifugation methods. They are analytical, sequential flotation, density gradient, and zonal ultracentrifugation (Schumaker and Puppione, 1986; Kellery and Kruski, 1986; Chung, *et al.*, 1986; Patsch and Patsch, 1986; Kahlon, *et al.*, 1986). Analytical ultracentrifugation allows not only separation of lipoproteins, but also of lipoprotein mass. Analytical ultracentrifugation requires specialized equipment and much technical skill, so it is not appropriate for most clinical labs. The other ultracentrifugation methods are

used in clinical labs when a lipoprotein density profile is desired. The disadvantages of required technical expertise, expensive equipment, and long spin times are common to all methods.

All of the methods for quantitation of lipoprotein cholesterol, with the exception of analytical ultracentrifugation, involve multiple steps. Each have separate isolation and detection steps. Size exclusion chromatography (SEC) allows for simple and rapid separation of lipoproteins. SEC is also very versatile, it can be coupled on-line to many detection systems. Proteins, cholesterol, triglycerides, and phospholipids can all be quantified on-line among the lipoproteins after SEC. Hara and coworkers (Hara and Okazaki, 1986; Okazaki, *et al.*, 1981; Okazaki, *et al.*, 1980; Okazaki, Ohno, and Hara, 1981; Ohno, *et al.*, 1981) were the first to introduce the use high performance size exclusion chromatography for separation of lipoproteins. They showed that serum lipoproteins could be effectively separated in as little as 50 minutes using only 20 μL of serum. The separations were carried out on TSK GEL, type PW or TSK GEL, type SW columns. Size exclusion chromatographic separation of lipoproteins has been found to be reliable by others. The separations have been carried out on the TSK GEL columns almost exclusively

(Kieft, *et al.*, 1991; Carroll and Rudel, 1983; Williams and Kushwaha, 1988; Busbee, *et al.*, 1981; Williams, *et al.*, 1984; Vercaemst, *et al.*, 1983).

The lipoproteins can be monitored at 280 nm following separation by SEC (Okazaki, *et al.*, 1980; Ohno, *et al.*, 1981; Carroll and Rudel, 1983; Williams and Kushwaha, 1988; Williams, *et al.*, 1984; Vercaemst, *et al.*, 1983). Detection at 280 nm allows for determination of the total protein content of each lipoprotein, as well as identification of characteristics of normal vs. pathologic elution profiles. Also, the effects of pH, ionic strength, and salt content of the buffer, on lipoproteins elution, can be easily followed. This method can only be used for the separation of the lipoproteins if the total lipoprotein fraction has been previously isolated plasma or serum using ultracentrifugation. Intact plasma or serum cannot be applied due to the large absorption band of albumin and Ig fractions. Absorbance at 280 nm is not specific for lipoproteins. In addition, there is still the need for an addition off-line step for cholesterol determination.

In an attempt to selectively monitor the lipoproteins, Busbee, *et al.*, (1981) prestained the lipoproteins with diformazan dye. The lipoprotein elution profile can then be monitored at 580 nm. Because

adsorption of the diformazan dye may decrease the lifetime of the column, a post column staining method was needed.

The post column staining procedure developed is actually the enzymatic determination of cholesterol. The reactions are those already given in Equation 1-3. Hara and coworkers were the first to use high performance size exclusion chromatography with enzymatic post column detection (Hara, *et al.*, 1980; Okazaki, *et al.*, 1981; Okazaki, Ohno, and Hara, 1981; Hara and Okazaki, 1986). Later, Kieft, *et al.*, (1991) combined enzymatic post column detection with gel chromatography. The enzymes are supplied as a "single reagent", in the form of a kit (Determiner TC "555", Kyowa Hakko Co., Tokyo). The product of the reaction is measured at 550 nm. The use of the commercial enzymatic reaction kit allows for simple and rapid determination of lipoprotein cholesterol. The cholesterol values correlate well to those target values set by the CDC. The use of post column enzymatic detection has many significant advantages over previous methods of detection. The only disadvantage that still exists is the need for the addition of costly enzyme reagents into the flow stream.

Immobilized enzyme reactors (IMERs), using cholesterol oxidase and cholesterol esterase, have been

used for the determination of total cholesterol in flow injection analysis (Carpenter and Purdy, 1990; Moody, *et al.*, 1988; Juang, *et al.*, 1977; Fernandez-Romero, *et al.*, 1987; Yao, *et al.*, 1985; Tabata, *et al.*, 1981). Many possible detection methods can be combined with IMERs. Various substrates can be used in Equation 3 that produce colored or fluorescent products (Fernandez-Romero, *et al.*, 1987; Tabata, *et al.*, 1981), but again these methods need reagents added to the system. Yao, *et al.*, (1985) added an immobilized peroxidase reactor and soluble ferricyanide to the CO and CE reactors. The end product hexacyanoferrate (III) was measured amperometrically at -50 mV vs. Ag/AgCl. Although the low applied potential of the electrode eliminates many electroactive interferences, ferricyanide must be added in the flow stream. Also, there are very few electroactive species present in plasma or serum. The simplest detection method is direct oxidation of the hydrogen peroxide produced (Huang, *et al.*, 1977; Moody, *et al.*, 1988; Carpenter and Purdy, 1990). The detection of hydrogen peroxide can be done without any reagents being added to the system. The cholesterol values produced using IMERs with amperometric detection of hydrogen peroxide correlate well with the target values

set by the CDC (Huang, et al, 1977; Carpenter and Purdy, 1990).

The objective of this work is to determine lipoprotein cholesterol using high performance size exclusion chromatography, immobilized cholesterol oxidase and cholesterol esterase reactors, and the amperometric determination of hydrogen peroxide. This technique combines the advantages of each component. That is, the simple and rapid separation of lipoproteins, the small sample volume needed, specific cholesterol determination, and no need of additional reagents.

EXPERIMENTAL

Standard Solutions.

Cholesterol (500 mg, United States Biochemical Corporation, Cleveland, OH) was added to 10 mL Triton X-100 and the solution was stirred at 60°C until the cholesterol dissolved. Nanopure water (60 mL) was added to the solution and stirring and heating were continued for 30 minutes. The solution was cooled and made up to 100 mL using nanopure water. The cholesterol stock solution was stored at 4°C and used until it became cloudy.

Serum and lipoprotein cholesterol control materials were obtained from Solomon Park Research Laboratories (Kirkland, WA). The serum had target values that were set by the CDC reference method. Lipoprotein standards were prepared from fresh plasma (Community Blood Bank, Kansas City, KS) according to Chung, *et al.*, (1986). Briefly, the density of the plasma was adjusted to 1.21 g/mL with the addition of solid KBr. The plasma (3 mL) was then placed in a centrifuge tube and overlaid with 7 mL sodium chloride solution ($d = 1.006$ g/mL). The plasma was spun in a Beckman ultracentrifuge using a 70.1 Ti rotor (65,000 rpm) for 244 minutes at 4°C. The lipoprotein fractions were visualized by adding sudan black (1 to 6 drops) to the plasma before ultracen-

trifugation. Sudan black (0.1 g, Sigma) is added to 100 mL ethylene glycol and the solution stirred at 65°C for 2 minutes. The solution is filtered and stored in an amber bottle at room temperature.

Immobilized Enzyme Reactor.

Reactor 1. Cholesterol oxidase (Boehringer Mannheim, Indianapolis, IN) and cholesterol esterase (Calbiochem, La Jolla, CA) were immobilized according to Carpenter and Purdy (1990). APS Hypersil (5 μ , 300 mg, Keystone Scientific, State College, PA) was sonicated in 9 mL of ethanol for 5 minutes then 1.5 mL glutaraldehyde (25%, Aldrich) was added and the solution was tumbled end-over-end at room temperature for one hour. The silica was washed extensively with ethanol, decreasing amounts of ethanol in water mixtures, water, and finally phosphate buffer (0.1 M, pH = 7.4). Cholesterol oxidase or cholesterol esterase (100 units each), in 9 mL phosphate buffer (0.1 M, pH = 7.4), was added to the silica and tumbled end-over-end at 4°C for 30 hours. The amount of unbound enzyme was determined using the BCA protein assay (Pierce). The immobilized enzymes were mixed in equal volumes and slurry packed in a stainless steel column with a volume of 340 μ L (Upchurch Scientific, Inc.).

Reactor 2. Cholesterol oxidase and cholesterol esterase (100 units each) were coimmobilized on 1 mL of Reactigel (Pierce) according to the manufacturer's directions. The gel was tumbled end-over-end at 4°C for 24 hours. The gel was filtered through a fritted glass disk funnel and remaining active sites were deactivated with 2.0 M Tris-buffer pH = 8.0. The amount of unbound enzyme was determined using the BCA protein assay (Pierce). The gel was packed into a stainless steel column with a volume of 680 μ L (Upchurch Scientific, Inc.).

Size Exclusion Chromatography.

The chromatographic equipment was obtained from Shimadzu Instruments. The system consisted of two Model LC-6A pumps, a Model SIL-6A autoinjector, a Model CTO-6A column oven, and a BAS LC-4A amperometric detector coupled to a dual electrode flow cell housed in a CC-4 cabinet (Bioanalytical Systems, West Lafayette, IN). Detection occurred at a cellulose acetate coated platinum electrode (+0.7 V vs. Ag/AgCl). The data was recorded using the Model C-R4A Chromatopac data system. The system was controlled by a Model SCL-6A controller. A TSKgel G5000PW column (7.5 mm ID x 60 cm) with a TSK guard column (7.5 mm ID x 7.5 cm, both from Toyo

Soda, Tokyo, Japan) were used for the separation of lipoproteins.

The chromatographic system coupled with the enzyme reactor is shown in Figure 3.2. Serum samples (60 μ L) were loaded directly onto the size exclusion column with no pretreatment. The effluent from the size exclusion column was combined with the buffer containing Triton X-100 through a dead volume T-connector. Triton X-100 is necessary for disruption of the lipoproteins and release of cholesterol. The combined streams were mixed in a reactor coil and passed through the enzyme reactor, which are both housed in a 37°C column oven.

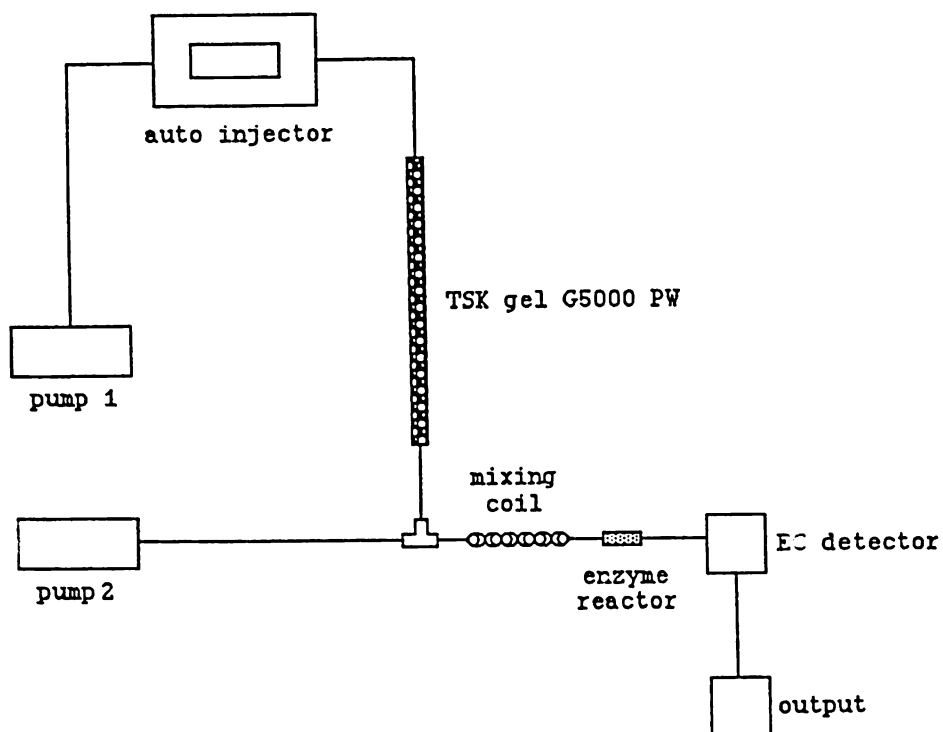

Figure 3.2 Schematic diagram of the size exclusion chromatography and immobilized enzyme reactor system.

RESULTS AND DISCUSSION

Optimum Conditions for Lipoprotein Separation and Enzymatic Reaction.

The optimum conditions were determined by evaluating various flow rates through the size exclusion column and differing amount of Triton X-100 in the back flow stream. F_s will represent the flow through the size exclusion column while F_e will represent the flow from the second pump. The lipoproteins were isolated using the ultracentrifugation procedure of Chung, et al., (1986). Table 3.2 shows the relationship between flow rate (F_s), percentage of Triton X-100, and peak area of LDL. F_s is varied while the Triton X-100 concentration is kept constant. It can be seen that increasing either the flow rate through the size exclusion column or the amount of Triton X-100 results in a decreased peak area for LDL. The trend continues as the Triton X-100 concentration is increased to 2 and 4%. The same trend is seen for HDL and whole serum. At 4% Triton X-100, the HDL peak is too small to be seen. In addition, the peak shapes become distorted and the baseline becomes very noisy at the higher concentrations of Triton X-100. Also, the lifetime of the enzyme reactor and reference electrode are shortened substantially when 2 or 4% Triton X-100 is present in the mobile phase. F_e was kept constant at

Table 3.2

Effect of Flow Rate and Amount of Triton X-100
on the Peak Area of LDL

% Triton X-100 (0.2 mL/min)	F _s (mL/min)	Peak Area Arbitrary Units
0.1	0.4	2221709
	0.5	2238068
	0.6	1050483
	0.7	850736
0.5	0.4	794161
	0.5	514662
	0.6	---
	0.7	---
1.0	0.4	462500
	0.5	254265
	0.6	191475
	0.7	---

*Peak areas could not be evaluated due to either a noisy baseline or small peak area.

0.2 mL/min because of the back pressure. TSK gel columns can only withstand 20 kg/cm² of back pressure. If F_e was higher than 0.2 mL/min, the back pressure generated was far above this limit. The conditions that lead to maximum peak area were $F_s = 0.4$ mL/min and $F_e = 0.2$ mL/min (0.1% Triton X-100).

Comparison of Enzyme Reactors.

The performance of the silica gel and Reactigel based enzyme reactors was identical. The linear range and lipoprotein cholesterol profiles were comparable for each. The silica gel based reactor was stable for approximately one month of continuous use, while the Reactigel based reactor was stable for only two weeks. Both enzyme reactors lost much activity if stored overnight in buffer containing Triton X-100. The loss of activity is due to both the loss of enzyme activity and to the compression and subsequent breakdown of the silica gel or Reactigel stationary phase. Although it showed lower stability, the Reactigel enzyme reactor was chosen because it generated less back pressure.

Quantitation and Validation of Lipoprotein Cholesterol.

Figures 3.3, 3.4, and 3.5 show the relationship between amount of cholesterol loaded and peak area. A linear relationship was obtained from 40 to 140 μg total cholesterol loaded. Because the VLDL peak was too small to be quantified, total cholesterol is actually the sum of HDL and LDL cholesterol. The linear range for HDL and LDL cholesterol were much shorter at 10 to 40 μg and 30 to 90 μg , respectively.

The linear ranges reported here are quite narrow, but are comparable to those reported by others who have combined SEC with enzymatic reactions for quantitation of cholesterol. Okazaki, *et al.*, (1981) report a linear range of only 5 to 54 μg cholesterol. Kieft, *et al.*, (1991) reports a wider linear range of 4 to 200 μg cholesterol. The reason for the limited linear range is not given and is not considered a disadvantage because the range is applicable for clinical samples.

The reason for the narrow linear range reported here are shown in Figures 3.6 and 3.7. Figure 3.6 shows the typical lipoprotein profile generated. It is apparent that the HDL and LDL peaks are now well resolved. It is shown in Figure 3.7 that at both low and high cholesterol concentrations, the resolution becomes much worse. At the highest cholesterol concentration, HDL becomes

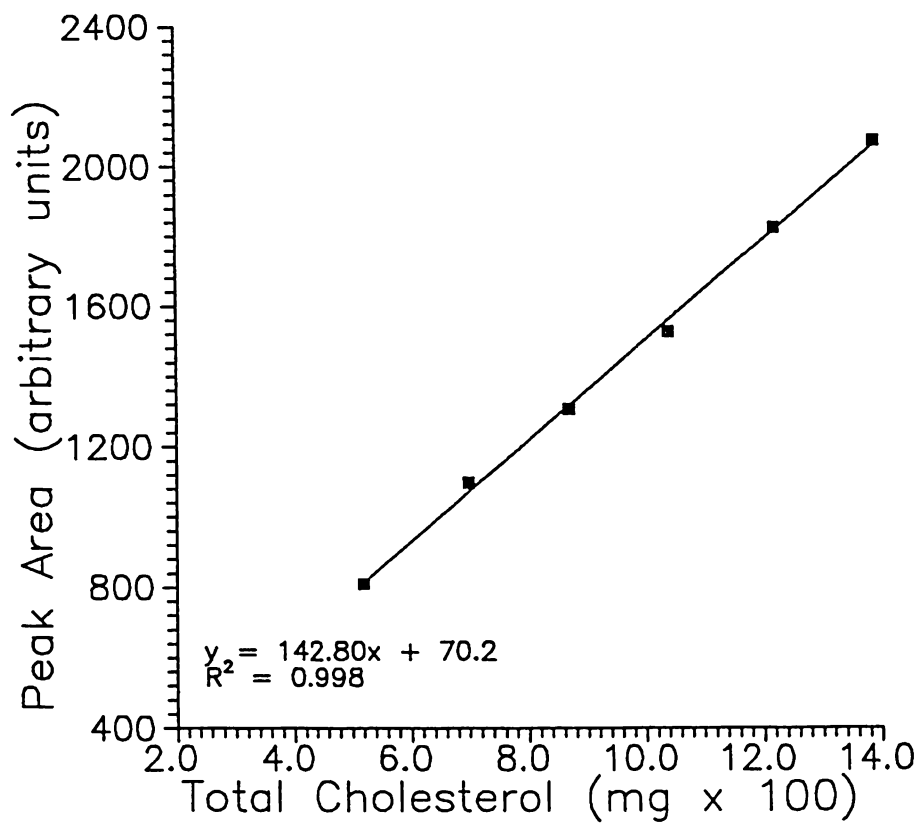

Figure 3.3 Relationship between amount of total cholesterol in the applied serum and peak area.

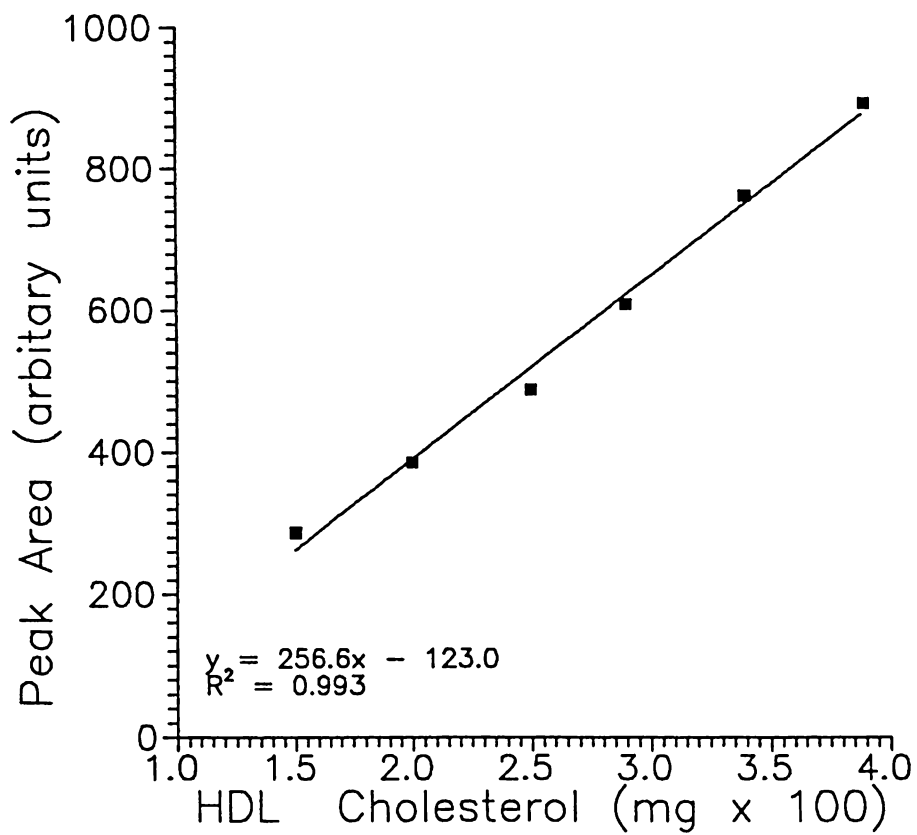

Figure 3.4 Relationship between amount of HDL cholesterol in the applied serum and peak area.

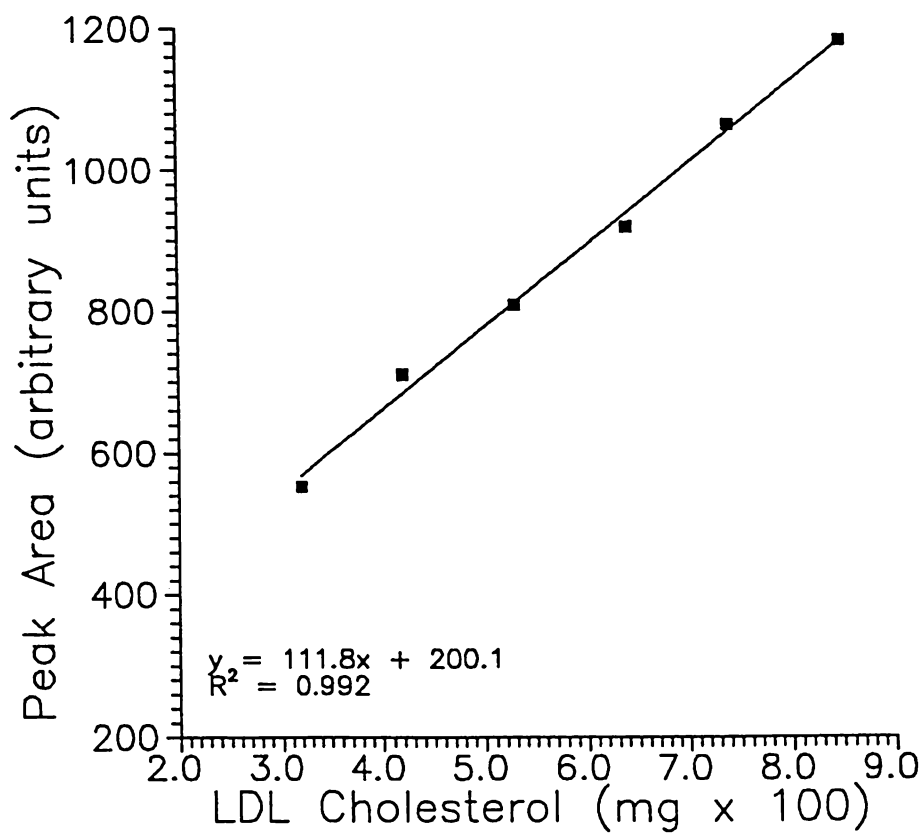

Figure 3.5 Relationship between amount of LDL cholesterol in the applied serum and peak area.

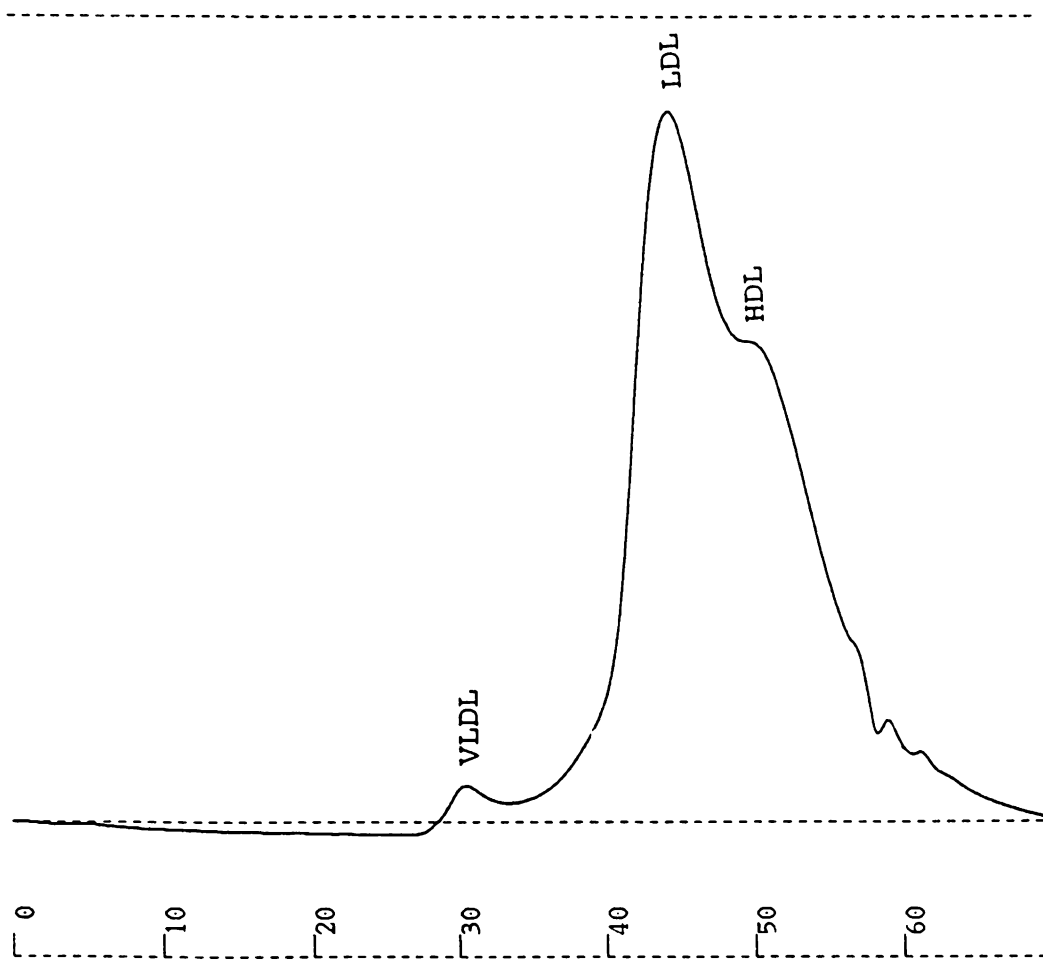

Figure 3.6 A typical lipoprotein cholesterol distribution profile. Loaded volume is 60 μ L.

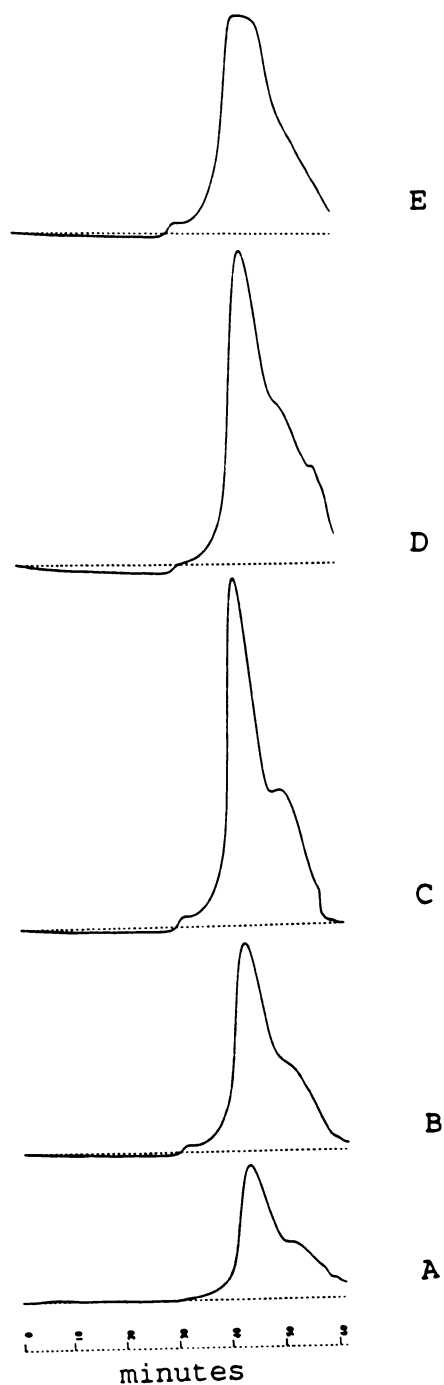

Figure 3.7 Comparison of lipoprotein cholesterol distribution profiles for various volumes of serum loaded onto the size exclusion column. A = 20 μL , B = 50 μL , C = 75 μL , D = 100 μL , and E = 150 μL .

indistinguishable from LDL. It is obvious why HDL and LDL cannot be quantified outside the narrow range of cholesterol concentrations.

The poor resolution makes lipoprotein cholesterol quantitation difficult. A comparison of the target cholesterol values (set by the CDC reference method) and the values obtained from SEC coupled to an immobilized enzyme reactor (SEC/IMER) is shown in Table 3.3. The values obtained from SEC/IMER have a positive bias. This is due to difficulty in evaluating the areas of the unresolved HDL and LDL peaks. There is no response when the enzyme reactor is removed from the system.

With improvements in separation, the SEC/IMER could be a useful alternative method for lipoprotein cholesterol analysis. It has the following advantages:

1. small amounts of intact serum (20 μ L) can be analyzed,
2. complete lipoprotein cholesterol profiles can be obtained in as little as 60 minutes,
3. the method is reproducible,
4. the addition of expensive reagents into the system is not needed,
5. other analytes, such as triglycerides, can be monitored simultaneously by simply adding other immobilized enzyme reactors.

Table 3.3
 Comparison of Target Cholesterol Values with
 SEC Coupled to an Immobilized Enzyme Reactor (IMER).

	Pool 1 (mg/dL)	Pool 2 (mg/dL)	Pool 3 (mg/dL)
TOTAL			
Target	51.0	173.0	230.0
Range	49.5 - 52.5	167.8 - 178.2	223.1 - 236.9
SEC/IMER	34.0 ± 2.0	187.2 ± 4.0	239.4 ± 5.4
HDL			
Target	16.0	47.0	46.0
Range	14.4 - 17.6	42.3 - 51.7	41.4 - 50.6
SEC/IMER	19.0 ± 0.6	54.8 ± 1.8	56.0 ± 1.2
LDL			
Target ¹	29.5	107.0	106.5
Range ²	---	---	---
SEC/IMER	6.7 ± 3.0	54.8 ± 1.8	170.1 ± 6.2

¹LDL target values were not given. The values here are calculated using the Friedewald equation.

²Range was not given.

FUTURE DIRECTIONS

A combination of columns would improve the poor resolution and therefore improve cholesterol quantitation. Although the G5000 PW column gives adequate resolution of the lipoproteins when monitored at 280 nm, the disruption of the lipoproteins and enzymatic reaction leads to band broadening and poor resolution. Hara and coworkers found that the combination of G5000PW + G3000SW + G3000 SW columns gave optimum separation (Ohno, *et al.*, 1981; Okazaki, *et al.*, 1981; Hara, *et al.*, 1980, Okazaki, *et al.*, 1980; Okazaki, Ohno, and Hara, 1981; Hara and Okazaki, 1986). Since the beginning of this work a TSKgel G4000SW column became commercially available. Carrol and Rudel (1983) have used a combination of G5000PW + G4000SW + G3000SW columns to achieve optimum peak separation. These columns are quite expensive, so as an alternative Kieft, *et al.*, (1991) used a single Superose 6HR 10/30 high performance gel chromatography column to achieve high resolution and accurate cholesterol values.

The stability of the enzyme reactor can be improved by using glass beads as the stationary phase. Glass beads combine the increased stability of the silica gel and the low back pressure of Reactigel. The enzymes can be easily coupled to glass beads using glutaraldehyde.

REFERENCES

- Abbas AK, Lightman AH, Poher JS (1991) *Cellular and Molecular Immunology*, WB Saunders: Philadelphia, PA.
- Abell LL, Levy BB, Brodie BB, Kendall FE (1958) In *Standard Methods of Clinical Chemistry*; Seligson D, Ed; Academic Press, New York; pp 26-33.
- Arunachalam B, Talwar GP, Raghupathy R (1990) *J. Immunol. Meth.* **135**:181-189.
- Atassi MZ, Young CR (1985) *Critical Reviews in Immunology* **5**(4):387-409.
- Bachorik PS (1989) *Clinics in Lab. Med.* **9**(1):61-72.
- Bachorik PS Dwiterovich PO (1991) *Techniques in Diagnostic Human Biochemical Genetics: A Laboratory Manual*; Wiley-Liss: New York, 425-459.
- Bankert RB, Des Soye D, Powers L (1980) *Transplant. Proc.* **12**(3):443-446.
- Bayon A, Shoemaker WJ, McGinty JF, Bloom F (1983) *Inter. Rev. Neurobiol.* **24**:51-92.
- Blancher A, Calvas P, Conte P, Teissie J (1991) *Bioelectrochem. Bioenerget.* **25**(2):295-306.
- Blank L (1992) University of Oklahoma, personal communication.
- Bleich HE, Cutnell JD, Day AR, Freer RJ, Glasel JA, McKelvy JF (1976) *Proc. Nat. Acad. Sci. USA* **262**:2589-2593.
- Busbee DL, Payne DM, Jasheway DW, Carlisle S, Lacko AG (1981) *Clin. Chem.* **27**(12):2052-2058.
- Cabassi R, Zetta L (1982) *Int. J. Pept. Protein Res.* **20**(2):154-158.
- Carayanniotis G, Barber BH (1987) *Nature* **327**:59-61.
- Carayanniotis G, Vizi E, Parker JMR, Hodges RS, Barber BH (1988) *Molecul. Immunol.* **25**(9):907-911.
- Carpenter A, Purdy WC (1990) *Anal. Lett.* **23**(3):425-435.

- Carroll RM, Rudel LL (1983) *J. Lipid Res.* **24**:200-207.
- Childers SR, Simantov R, Snyder SH (1977) *Eur. J. Pharmacol.* **46**:289-293.
- Chung BH, Segrest JP, Ray MJ, Brunzell JD, Hokanson JE, Krauss RM, Beaudrie K, Cone JT (1986) *Meth. Enzymol.* **128**:181-209.
- Clement-Jones V, Lowry PJ, Rees LH, Besser GM (1980) *J. Endocr.* **86**:231-243.
- Cohan A, Hertz HS, Mandel J, Paule RC, Schaffer R, Sniegowski LT, Sun T, Welch MJ, White E (1980) *Clin. Chem.* **26**(7):854-860.
- Conrad MK, Lo MMS (1990) *Methods in Enzymology* **184**:641-653.
- Cox BH (1982) *Lif. Sci.* **31**:1645-1658.
- Cuello AC, Milstein C, Couture R, Wright B, Priestley JV, Jarvis J (1984) *J. Histochem. Cytochem.* **32**(9):947-957.
- Cupo A, Vion-Dury J, Jarry T (1986) *Neuropeptides* **8**:207-219.
- Dave KJ (1991) Ph.D. Dissertation, University of Kansas.
- Davis GC, Hein MB, Chapman DA, Neely BC, Sharp CR, Durley RC, Biest DK, Heyde BR, Carnes MG (1985) *Plant Growth Substances*, Springer, Berlin, 44-51.
- De Ceballos ML, Taylor MD, Jenner P (1991) *Neuropeptides* **20**:201-209.
- De Montigny P (1986) Ph.D. Dissertation, University of Kansas.
- De Coen JL, Herion P (1986) *Molecul. Immunol.* **23**(2):209-215.
- Deakin JFW, Dostrovsky JO, Smyth DG (1980) *Biochem. J.* **189**:501-506.
- Deschodt-Lanckman M, Pontarotti P (1984) *Can. J. Biochem. Cell Biol.* **62**:1097-1099.

- Desiderio DM, Kai M, Tanzer FS, Trimble J, Wakelyn C
(1984) *J. Chromotogr.* **342**:245-260.
- Desiderio DM, Takeshita H, Onishi H, Fridland G, Tanzer
FS, Wakelyn D, Dass C (1986) *The Analysis of
Endogenous Opioid Peptides with HPLC, Radioreceptor
Assay, Radioimmunoassay, and Mass Spectrometry.* In:
Rapaka RS, Hawks RL (eds) U.S. NIDA Research
Monograph Series 70, 304-318.
- Desiderio DM (1984) *Analysis of Neuropeptides by Liquid
Chromatography and Mass Spectrometry*; Elsevier: New
York.
- Dhingra MM, Saran A (1989) *Biopolymers* **28**(7):1271-1285.
- Duran LW, Metcalf ES (1987) *J. Exp. Med.* **165**:340-358.
- Farjam A, van de Merbel NC, Lingeman H, Frei RW, Brinkman
UATH (1991b) *Int. J. Environ, Anal. Chem.*
45(2):73-87.
- Farjam A, Brugman AE, Lingeman H, Brinkman UAT (1991a)
Analyst **116**:891-896.
- Fernandez-Romero JM, de Castro L, Valcarcel M (1987)
Clin. Chem. Acta. **167**:97-104.
- Fleming LH, Reynolds NC (1988) *J. Chromotogr.* **431**:65-76.
- Friedewald WT, Levy RI, Fredrickson DS (1972) *Clin. Chem.*
18(6):499-502.
- Fuller SA, Takahashi M, Hurrell JGR (1988) In *Current
Protocols in Molecular Biology*, Ausubel FM, Brent R,
Kingston RE, Moore DD, Seidman JG, Smith JA, Sturhl
K (eds) Wiley and Sons: New York; Vol. 2, Chapter
11 pp. 7.1-7.4.
- Galfré G, Milstein C (1981) *Meth. Enzymol.* **73**:3-47.
- Goding JW; *Monoclonal Antibodies: Principles and
Practice*; Academic Press: New York, 1983; pp.
100-115.
- Goldstein A, Lowney LI, Pal BK (1971) *Proc. Natl. Acad.
Sci. (USA)* **68**(8):1741-1747.

- Gramsch C, Meo T, Riethmüller G, Herz A (1983) *J. Neurochem.* **40**(5):1220-1226.
- Gros C, Pradelles P, Rouget C, Bepoldin O, Dray F, Fournie-Zaluski MC, Roques BP, Pollard H, Llorens-Cortes C, Schwartz JC (1978) *J. Neurochem.* **31**:20-39.
- Guillemin R, Ling N, Vargo, T (1977) *Biochem. Biophys. Res. Comm.* **77**(1):361-366.
- Haasnoot W, Schilt R, Hamers ARM, Huf FA, Farjam A, Frei RW, Brinkman UATH (1988) *J. Chromatogr.* **489**:157-171.
- Hara I, Okazaki M, Ohno Y (1980) *J. Biochem.* **87**:1863-1865.
- Hara I, Okazaki M (1986) *Meth. Enzymol.* **129**:57-79.
- Harris B (1991) University of Kansas Medical Center, personal communication.
- Heath AW, Playfair JHL (1990) *Immunol.* **71**:454-456.
- Hendren RW (1986) Current Status of RIA Methods for the Analysis of Enkephalins and Endorphins. In: Rapaka RS, Hawks RL (eds) *U.S. NIDA Research Monograph Series 70*:255-303.
- Herz A, Gramsch C, Höllt V, Meo T, Riethmüller G (1982) *Lif. Sci.* **31**:1721-1724.
- Huang H, Kuan SS, Guilbault GG (1977) *Clin. Chem.* **23**(4):671-676.
- Hughes J, Smith TW, Kosterlitz HW, Fothergill LA, Morgan BA, Morris HR (1975) *Nature* **258**:577-579.
- Hughes J, Smith T, Morgan B, Fothergill L (1975) *Lif. Sci.* **16**:1753-1758.
- Hughes J (1975) *Brain Res.* **88**:295-308.
- Jack GW (1992) *Meth. Molecul. Biol.* **11**:125-133.
- Janis LJ, Reigner FE (1988) *J. Chromatogr.* **444**:1-11.
- Janis LJ, Grott A, Regnier FE, Smith-Gill SJ (1989) *J. Chromatogr.* **476**:235-244.

- Jitsukawa T, Nakajima S, Saugwara I, Watanabe H (1989) *J. Immunol. Meth.* **116**:251-257.
- Johansson B (1986) *J. Chromatogr.* **381**:107-113.
- Johnstone A, Thorpe R (1987) *Immunochemistry in Practice*, Blackwell Scientific, Boston; p. 207.
- Jones CR, Gibbons WA, Garsky V (1976) *Nature* **262**:778-782.
- Jones CA, Lane DP, Hughes J (1983) *Biochem. Biophys. Res. Comm.* **113**(3):757-764.
- Jones SL, Pearson JE (1990) *J. Immunol. Meth.* **129**:227-231.
- Kahlon TS, Glines SL, Lindgren FT (1986) *Meth. Enzymol.* **129**:26-44.
- Kai M, Ishida J, Ohdura Y (1988) *J. Chromatogr.* **430**:271-278.
- Kawamura J, Berzofsky JA (1986) *J. Immunol.* **136**(1):58-65.
- Kelley JL, Kruski AW (1986) *Meth. Enzymol.* **128**:170-180.
- Kerscher L, Schiefer S, Draeger B, Maier J, Ziegenhorn J (1985) *Clin. Biochem.* **18**:118-125.
- Khaled MA, Long MM, Thompson WD, Bradley RJ, Brown GB, Urry DW (1977) *Biochem. Biophys. Res. Commun.* **76**(2):224-231.
- Kieft KA, Bocan TMA, Krause BR (1991) *J. Lipid Res.* **32**:859-866.
- Kuus-Reichel K, Beebe A, Knott K (1991) *Hybridoma* **10**(4):529-538.
- Lachmann RJ, Strangeways L, Vyankarnam A, Evan G (1986)
In: Porter R, Whelan J (eds) *Synthetic Peptides as Antigens*, Wiley, New York (Ciba Foundation Symposium 119) pp. 25-57.
- Levine BA, Rabenstein DL, Smyth D, Williams RJP (1979) *Biochim. Biophys. Acta* **579**(2):279-280.
- Lo MMS, Tsong TY, Conrad MK, Strittmatter SM, Hester LD, Snyder SH (1984) *Nature* **310**:792-794.

- Loeber JG, Verhoef J (1981) *Meth. Enzymol.* **73**:261-275.
- McCormack B (1991) Hybritech, Inc., personal communication.
- McKnight AT, Corbett AD, Paterson SJ, Robson LE, Kosterlitz HW (1988) *Monographs on Endocrinology* **30**:66-94.
- Meek JL, Bohan TP (1978) *Adv. Biochem. Psychopharmacol.* **18**:141-147.
- Meo T, Gramsch C, Inan R, Holtt V, Weber E, Herz A, Riethmuller G (1983) *Proc.Natl. Acad. Sci.(USA)* **80**:4084-4088.
- Mifune M, Krehbiel DK, Stobaugh JF, Riley CM (1989) *J. Chromatogr.* **496**:55-70.
- Miller RJ, Chang KJ, Cooper B, Cuatrecasas P (1978) *J. Biol. Chem.* **253**(2):531-538.
- Moody GJ, Sanghera GS, Thomas JDR (1988) *Analyst* **113**:1419-1422.
- Moret E, Gerothanassis IP, Hunston RN, Lauterwein J (1990) *FEBS Lett.* **262**(2):173-175.
- Mousa S, Couri D (1983) *J. Chromatogr.* **267**:191-198.
- Mudgett-Hunter M (1992) Monoclonal Antibodies. In: Fozzard HA, Haber E, Jennings RB, Katz AM, Morgan HE (eds) *The Heart and Cardiovascular System*, 2nd edn. Raven Press Ltd., New York, pp 505-522.
- Murai Y, Ohno M, Konishi M, Kominami G (1992) *J. Chromatogr.* **597**:201-205.
- Naber D, Pickar D (1983) *Psychiatric Clinics of North America* **6**(3):443-456.
- Neil GA, Urnovitz HB (1988) *Tr. Biotechnol.* **6**(9):209-213.
- Nilsson B (1983) *J. Chromatogr.* **276**:413-417.
- Nolan H, Klinman S, Klinman NR (1978) *Adv. Immunol.* **26**:255-337.

- Ohno Y, Okazaki M, Hara I (1981) *J. Biochem.*
89:1675-1680.
- Okazaki M, Ohno Y, Hara I (1981) *J. Biochem.* **89**:879-887.
- Okazaki M, Shiraishi K, Ohno Y, Hara I (1981)
J. Chromatogr. **223**:285-293.
- Okazaki M, Ohno Y, Hara I (1980) *J. Chromatogr.*
221:257-264.
- Olson GA, Olson RD, Kastin AJ, (1985) *Peptides* **6**:769-791.
- Olson GA, Olson RD, Kastin AJ, (1984) *Peptides* **5**:975-992.
- Olson GA, Olson RD, Kastin AJ, (1983) *Peptides* **4**:563-576.
- Olson GA, Olson RD, Kastin AJ, (1990) *Peptides*
11:1277-1304.
- Olson GA, Olson RD, Kastin AJ, (1986) *Peptides* **7**:907-933.
- Olson GA, Olson RD, Kastin AJ, Coy DH (1981) *Peptides*
2:349-369.
- Olson GA, Olson RD, Kastin AJ, Coy DH (1980) *Peptides*
1:365-379.
- Olson GA, Olson RD, Kastin AJ, (1989) *Peptides*
10:1253-1280.
- Olson GA, Olson RD, Kastin AJ, (1991) *Peptides*
12:1407-1432.
- Olson GA, Olson RD, Kastin AJ, (1989) *Peptides* **10**:205-236
- Olson GA, Olson RD, Kastin AJ, Coy DH (1979) *Neurosci.*
Behav. Rev. **3**(4):285-299.
- Olson GA, Olson RD, Kastin AJ, (1987) *Peptides*
8:1135-1164.
- Olson GA, Olson RD, Kastin AJ, Coy DH (1982) *Peptides*
3:1039-1072.
- Patrella E, Kues-Riechel T, Lien C, Wilson B (1989)
Presented at *The Seventh International Congress on*
Immunology, Berlin, Germany.

- Patsch JR, Patsch W (1986) *Meth. Enzymol.* **129**:3-25.
- Pepper DS (1992) *Meth. Molecul. Biol.* **11**:135-171.
- Phillips TM (1989) *Recept. Biochem. Methodol.* **14**:129-154.
- Pontarotti PA, DeKaouel ClB, Verrier M, Cupo AA (1983) *J. Neuroimmunol.* **4**:47-59.
- Reason D, Carminati J, Kimura J, Henry C (1987) *J. Immunol. Meth.* **99**:253-257.
- Reh R (1988) *J. Chromatogr.* **433**:119-130.
- Renugopalakrishnan V, Rapaka RS, Collette TW, Carreira LA, Bhatnager RS (1985) *Biochim. Biophys. Acta* **126**(3):1029-1035.
- Rifai N, Warnick GR, McNamara JR, Belcher JD, Grinstead GF, Frantz ID (1992) *Clin. Chem.* **38**(1):150-160.
- Roda GR, Roscetti G, Possenti R, Venturelli F, Vita F (1986) In: *Enkephalins and Endorphins Stress and the Immune System*; Plotnikoff NP, Faith RE, Murgio AJ, Good RA, Eds; Plenum Press: New York, pp. 17-33.
- Rossier J, Bayon A, Vargo TM, Ling N, Guillemin R, Bloom F (1977) *Lif. Sci.* **21**:847-852.
- Rybacek L, D'Andrea M, Tarnowski J (1987) *J. Chromatogr.* **397**:355-364.
- Schumaker VN, Puppione DL (1986) *Meth. Enzymol.* **128**:155-169.
- Sell S (1987) *Basic Immunology Immune Mechanisms in Health and Disease*; Elsevier: New York.
- Simantov R, Kuhar MJ, Uhl GR, Snyder SH (1977) *Proc. Natl. Acad. Sci. (USA)* **74**(5):2167-2171.
- Simon EJ (1991) *Med. Res. Rev.* **11**(4):357-374.
- Spirtes MA, Schwartz RW, Mattice WL, Coy DH (1978) *Biochem. Biophys. Res. Commun.* **81**(2):602-609.

- Springer TA (1987) In *Current Protocols in Molecular Biology*, Ausubel FM, Brent R, Kingston RE, Moore DD, Seidman JG, Smith JA, Sturhl K (eds) Wiley and Sons: New York; Chapter 10 pp. 11.1-11.7
- Staros JV, Wright RW, Swingle DM (1986) *Anal. Biochem.* **156**:220-222.
- Steele BW, Koehler DF, Azar MM, Blaszkowski TP, Kuba K, Dempsey ME (1976) *Clin. Chem.* **22**(1):98-101.
- Stein S, Udenfriend S (1984) *Anal. Biochem.* **136**:7-23.
- Stimson ER, Neinwald YC, Scheraga HA (1979) *Biochemistry* **18**(9):1661-1671.
- Sundberg B, Sandberg G, Crozier A (1986) *Phytochemistry* **25**:295-298.
- Surewicz WK, Mantsch HH (1988) *Biochim. Biophys. Acta* **150**(1):245-251.
- Tabata M, Endo J, Murachi T (1981) *J. Appl. Biochem.* **3**:84-92.
- Terenius L, Wahlström A (1975) *Acta Physiol. Scand.* **94**:74-81.
- Tomita M, Tsong TY (1990) *Biochim. Biophys. Acta* **1055**:199-206.
- Toshimasa I, Shigetaka Y, Mitsunobu D, Masatoshi I, Kunihiro K (1988) *Biochem. J.* **255**:621-628.
- Unanue ER, Benacerraf B (1984) *Textbook of Immunology*, 2nd edn.; Williams and Wilkins: Baltimore, MD.
- van Nispen J, Pinder R (1975) *An. Rep. Med. Chem.* **21**:51-62.
- Van de Water C, Tebbal D, Haagsma J (1989) *J. Chromatogr.* **478**:205-215.
- Venn RF (1987) *J. Chromatogr.* **423**:93-104.
- Venn RF, Capper SJ, Morley JS, Miles JB (1985) In *Bioactive Analytes, Including CNS Drugs, Peptides, and Enantiomers*, Reid E, Scales B, Wilson ID (eds); Plenum: New York, 55-63.

- Vercaemst R, Rosseneu M, Van Biervliet JP (1983) *J. Chromatogr.* **276**:174-181.
- Vesterman BG, Saulitis J, Betins J, Piepins E, Nikiforovich GV (1989) *Biochim. Biophys. Acta* **998**(2):204-209.
- Warnick GR, Benderson J, Albers JJ (1982) *Clin. Chem.* **28**(6):1379-1388.
- White MW (1983) *J. Chromatogr.* **262**:420-425.
- Williams MC, Kelley JL, Kushwaha RS (1984) *J. Chromatogr.* **308**:101-109.
- Williams MC, Kushwaha RS (1988) *J. Chromatogr.* **433**:257-263.
- Wisdom GB (1992) *Biochem. Soc. Trans.* **20**(1):226-229.
- Wojchowski DM, Sytkowski AJ (1986) *J. Immunol. Meth.* **90**:173-177.
- Yang HY, Hong JS, Costa E (1977) *Neuropharmacol.* **16**:303-307.
- Yao T, Sato M, Kobayashi Y, Wasa T (1985) *Anal. Biochem.* **149**:387-391.