



**Manchester
Metropolitan
University**

Enahoro, Sunday, Ekpo, Sunday ORCID logoORCID: <https://orcid.org/0000-0001-9219-3759>, Uko, Mfonobong, Ansari,, Umm-E-Haya, Altaf, Arslan and Zafar, Muazzam (2021) Adaptive Beamforming for mmWave 5G MIMO Antennas. In: 2021 IEEE 21st Annual Wireless and Microwave Technology Conference, 28 April 2021 - 29 April 2021, Sand Key, Florida, USA.

Downloaded from: <https://e-space.mmu.ac.uk/630104/>

Version: Accepted Version

Publisher: IEEE

DOI: <https://doi.org/10.1109/WAMICON47156.2021.9443616>

Please cite the published version

<https://e-space.mmu.ac.uk>

Adaptive Beamforming for mmWave 5G MIMO Antenna

Sunday Enahoro
Faculty of Science and Engineering
Manchester Metropolitan University
Manchester UK
sunday.enahoro@stu.mmu.ac.uk

Dr Sunday C. Ekpo
Faculty of Science and Engineering
Manchester Metropolitan University
Manchester UK
s.ekpo@mmu.ac.uk

Mfonobong Charles Uko
Faculty of Science and Engineering
Manchester Metropolitan University
Manchester UK
mfonobong.uko@stu.mmu.ac.uk

Arslan Altaf
Faculty of Science and Engineering
Manchester Metropolitan University
Manchester UK
arslan.altaf@mmu.ac.uk

Umm-E-Haya Ansari
Faculty of Science and Engineering
Manchester Metropolitan University
Manchester UK
umm-e-haya.ansari@stu.mmu.ac.uk

Muazzam Zafar
Faculty of Science and Engineering
Manchester Metropolitan University
Manchester UK
muazzamzafar123@gmail.com

Abstract- The direction of arrival (DOA) estimation and beamforming are effective methods for spatial diversity realization. Various algorithm already exists for implementing these methods. This paper explore the performance of least mean square algorithm (LMS) beamforming algorithm. This adaptive beamforming algorithm investigates receiver signal processing method that continuously monitor, calculate and update the weights in a continuously changing electromagnetic environment. Several optimization algorithms are studied, and a comparison of the least mean-squared algorithm and the minimum variance distortionless response is investigated with varying parameters (i.e. number of antenna element, element spacing etc.) using analytical method and Matlab simulation. It would be demonstrated through simulation that LMS algorithm increases signal quality by elimination interfering signals and noise by nulling them, while sending maximum signal (beams) to the desired direction.

Keywords— 5G, adaptive beamforming, massive MIMO, DOA, MVDR, null, LMS.

I. INTRODUCTION

The physical size limitations of a mobile handset restricts the characteristics and performance of the antenna in terms of trade-offs such as radiation performance, bandwidths, ergodic channel capacity, input impedance etc. Another critical challenge is designing antennas for mobile devices operating in different modes GSM (850,900, 1800, 1900 MHz), UMTS, LTE (2300, 2500 MHz) and now the proposed 5G operating frequency (3400-3800 MHz and the mmWave operating region i.e. 24-28 GHz).

Technologies that will assist in enhancing a significant improvement in throughput and quality of communication systems are undergoing various research stages. Some of

these researches are focused on MIMO, mmWave and beamforming systems which are expected to play a significant role in 5G applications.

Massive MIMO (an extension of MIMO) technology is expected to provide better spectrum and energy efficiency as well as throughput for the communication system by grouping together large amount of antenna element in array at both the transmitter and receiver which is a precondition for beamforming application and direction of arrival (DOA) [8]. Beamforming and DOA combination enables efficient and robust direction of useful signal to UE at maximum power. Direction of arrival (DOA) is a technique used in pinpointing the location of a signal in relation to the source. Another technique used to steer the useful signal to the direction of interest while directing null signals to the interferer is known as beamforming, while adaptive beamforming involves the use of various algorithms in digital signal processing to continuously update weights to optimize the system.

A particular interest of 5G is high throughput, high spectral and energy efficiency. Hence the need for this paper which looks at technique to apply adaptive beamforming with mmWave and massive MIMO to boost throughput and signal quality by eliminating interfering signal (i.e. other parallel UEs) and noise associated with communication system to increase the SINR.

II Massive Multiple Input Multiple Output (Massive MIMO)

MIMO antenna system at the transceiver has dominated the wireless communication sector because of its exceptional performance characteristics i.e. multiuser capabilities, higher throughput, its diversity etc.

When several antennas are used in both the receiving and transmitting end of a communication system at the same, this process is known to as multiple input multiple output (MIMO) antenna System. It offers a significant advantage over a single antenna system.

The diagram above shows a basic structure of a MIMO system. MIMO characteristics can be subdivided into three main categories i.e. diversity, precoding and spatial multiplexing. Massive MIMO antenna arrays are required for 5G mmWave designs. Since antenna array dimensions for

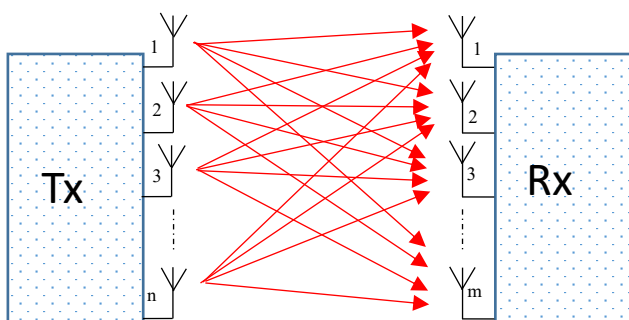

Fig. 1: Basic structure of a MIMO system

mmWave frequencies are much smaller as compared to microwave frequencies, mmWave arrays can accommodate up to 100x more elements as compared to microwave arrays.

III. Beamforming Array signal Model

The information generated from and accumulated from an antenna can be referred to as beam. It can be highly directive or omni-directional (all directions). Most of the useful signal is carried by the main lobe (useful signal) while the side-lobes are interfering signals. Multiple radiating elements are used to direct or point radiation to a particular or a more directed direction. This is known as Beamforming or spatial filtering.

This is achieved by combining or placing the elements next to each other and feeding them with the same input signal. The number of input signal constitutes the number of antennas.

For example, when two input signals (two antennas) are used, strong beam (mainlobe) will be formed in a particular (pointing in the desired) direction, while leakages called sidelobes will be created in other directions (pointing in other directions). The more radiating elements (and input signals – antennas) we have, the more directive the signals would be with less sidelobes.

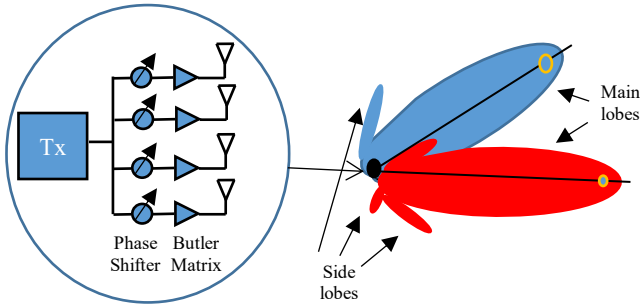

Fig. 2: Beamforming using four transmit antennas

IV. Adaptive Beamforming Theory and Design Consideration

An adaptive array differs from a conventional (non-adaptive) array in that the complex weights on the antenna elements and the array factors of the array are obtained from complex weights that did not depend on the signal environment.

In adaptive beamforming, complex weights are computed adaptive algorithm by a digital signal processor using an adaptive technology that generate an array factor for an optimal signal-to-interference and noise ratio (SINR). This results in a pattern where the target signal which is the maximum of the pattern is directed towards the targeted user while nulling the interferers.

By using adaptive beamforming, the array pattern is dynamically optimized according to changing electromagnetic environment thereby significantly increasing network capacity, coverage area and signal quality of a wireless system. Signals are adaptively processed in order to exploit the radio channel spatial domain.

Consider a uniform linear array (ULA) composing of M -elements, the number of narrowband plane waves represented by L , centred at centre frequency f_0 which impinges on the ULA from directions $(\theta_1, \theta_2, \dots, \theta_l)$

At the m th element, the signal received using complex signal representation can be written as [5]:

$$x_m(t) = \sum_{i=1}^L s_i(t)e^{-j(i-1)k_i} + n_m(t) \quad (1)$$

Where $s_i(t)$ and $n_m(t)$ are the signal of the i th source and uncorrelated spatially white noise signal received at the m th element respectively. Also $k_i = \frac{2\pi d}{\lambda} \sin(\theta_i)$

The output array can be written in matrix form using vector notation as:

$$X(t) = A(\theta)S(t) + N(t) \quad (2)$$

Where

$$X(t) = [x_1(t) \ x_2(t) \ x_3(t) \ \dots \ x_M(t)]^T \quad (3)$$

$$S(t) = [s_1(t) \ s_2(t) \ s_3(t) \ \dots \ s_M(t)]^T \quad (4)$$

$$N(t) = [n_1(t) \ n_2(t) \ n_3(t) \ \dots \ n_M(t)]^T \quad (5)$$

$$A(\theta_i) = [1 \ e^{jk_i} \ e^{-j2k_i} \ \dots \ e^{j(M-1)k_i}]^T \quad (6)$$

Where Eq (6) is the M th element ULA array steering vector for the θ_i direction of arrival and ‘T’ (superscript) indicates matrix transpose.

In addition to signal received in direct path, many multipath signals are also received in an array system with different DOAs, hence the signal vector can be rewritten as

$$a(\theta_1)s_1(t) + \sum_{l=2}^L \alpha_l(\theta_l)s_l(t) = a_1(\theta_1)s_1(t) \quad (7)$$

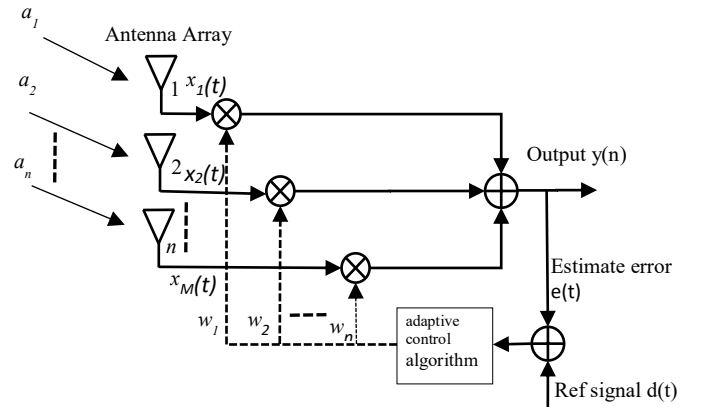

Fig. 3: Adaptive array block diagram

Where a_i is the spatial signature, α_i is the magnitude and phase difference between the i th component and the direct path.

Complex weights are applied in adaptive array to the element output to adjust the phase and amplitude of the signal received from each antenna to optimize received signal, represented by the M -directional vector:

The array vector weights for optimization are given by:

$$W^H = [w_1 \ w_2 \ \dots \ \dots \ w_M] \quad (8)$$

The array response is steered by forming a linear combination of the element output and can be written as:

$$y(t) = \sum_{i=1}^M w_i^* x_i(t) = W^H X(t) \quad (9)$$

Given samples $y(1), y(2), \dots, y(N)$, the mean output power is thus given by:

$$p(w) = \frac{1}{N} \sum_t^N |y(t)|^2 = \frac{1}{N} \sum_{t=1}^N w^H x(t) x^H(t) w \quad (10)$$

Where H is the complex conjugate transpose of a vector of a matrix, * denotes the conjugate.

One optimum performance criterion involves minimizing the array output noise variance so that the desired signals are passed with specific gain while minimizing the contributions due to noise and interference, while assuming that the unwanted and desired signals have zero mean. In order words:

$$\min W^H R W \text{ subject to } W^H A_d = r \quad (11)$$

A_d is the steering matrix pointing to the desired signals and r is the Vx_i constraint vector, where V is the number of desired signals. When the elements of “ r ” are all 1 s, the criterion is known as Minimum Variance Distortionless Response (MVDR) also called Capon’s algorithm [6] which is a convectional beamforming method.

Another optimum performance method is the least mean square (LMS) algorithm which was developed by Widrow et al. This algorithm use a gradient based approach, an approach that assume an established quadratic performance surface [10]. The algorithm is based on the optimization technique that continuously computes and update the vector weight.

The error indicated in fig. 3 is:

$$e(t) = d(t) - W^H X(t) \quad (12)$$

Squaring both sides gives:

$$|e(t)|^2 = |d(t) - W^H X(t)|^2 \quad (13)$$

If we momentarily suppress the time dependent variable, then we obtain the cost function as:

$$J(w) = D - 2W^H r + W^H R_{xx} W \quad (14)$$

Where r and R_{xx} are the signal correlation vector and array correlation matrix of the array antenna respectively i.e.

$$r(t) \approx d(t)x(t) \quad (15)$$

$$R_{xx}(t) \approx x(t) x^H(t) \quad (16)$$

$$D = E[|d|^2]. \quad (17)$$

The minimum of the cost function (Eq. 14) can be located by using the gradient method. Thus,

$$\nabla_w (J(w)) = 2R_{xx}W - 2r \quad (18)$$

From Eq. (18), the minimum occurs when the gradient is zero. Thus,

$$\nabla_w (J(w)) = 2R_{xx}W - 2r = 2(R_{xx}W - r) = 0$$

Therefore,

$$R_{xx}W_{opt} = r$$

From which

$$W_{opt} = R_{xx}^{-1} r \quad (19)$$

Cost function gradient can be approximated by the method of steepest descent. The direction of steepest descent and the gradient vector are in opposite direction.

The steepest descent iterative approximation is given by:

$$w(t+1) = w(t) - \frac{1}{2}(\mu \nabla_w (J(w(t)))) \quad (20)$$

Where μ represent the steepest parameter (step size) and ∇_w = the gradient of the performance surface. To get the LMS solutions, we substitute the instantaneous correlation approximations

$$\begin{aligned} w(t+1) &= w(t) - \mu [R_{xx} w - r] \\ &= w(t) - \mu e(t)x(t) \end{aligned} \quad (21)$$

Where, $e(t) = d(t) - w^H(t)x(t)$ = error signal.

The convergence of the LMS algorithm is directly proportional to the step-size parameter μ . If the step size is too big, the LMS algorithm will overshoot the optimum weight of interest, if the step size is too small, then it will lead to overdamped case and the adaptive array cannot acquire the signal of interest fast enough to track the changing signal. So, it is imperative that the step size μ should meet the following condition:

$$0 \leq \mu \leq \frac{1}{2\lambda_{max}} \quad (22)$$

Where λ_{max} is the eigenvalue of the array correlation matrix R_{xx} .

Since the correlation matrix is positive definite, all eigenvalues are positive. If there is only one signal of interest and all the interfering signals are noise, we can approximate the condition in Eq. (22) as:

$$0 \leq \mu \leq \frac{1}{2Tr[R_{xx}]} \quad (23)$$

V. Antenna Design and Simulation

In this section, the performance of adaptive beam-former is implemented using both least mean square (LMS) and minimum variance distortionless response (MVDR) algorithm to determine the optimum array weights and to point a null of the array response in the direction of an interfering source. Here it is initially assumed that all signals arriving at the antenna element are monochromatic. Also assumed is that the total number of signals arriving is less than the antenna

elements. The initial conditions were chosen as per 5G requirements of 28 GHz. An 8-element uniform linear array (ULA) with half wavelength ($\lambda/2$) element spacing, carrier frequency of 28 GHz. The desired signal will be assumed to be incident on the ULA from an azimuth angle of $\Theta_s=15^\circ$ and an interfering signal arriving at $\Theta_i=-60^\circ$ respectively.

The channel is simulated in the presence of complex white Gaussian noise, and assuming a noise power of 0.5watts (corresponds to 3dB SNR) at each antenna element.

The LMS and MVDR algorithm were used to place nulls in the antenna pattern and implemented using Matlab simulation software.

VI. Results and Conclusion

Figures 5 and 10 shows the magnitude of the weight vs iteration number. It also shows that as the number of antenna element increases, the weights converge as the number of iteration increases using the LMS algorithm.

How the array output acquires and track the desire signals is shown in figures 6 and 9. The two plots shows that the LMS algorithm array output was able to acquire and track the signal after about 60 iterations, but was not possible with MVDR algorithm.

Figure 4 shows using LMS algorithm, the resulting mean-square error (MSE) that converges to zero after about 60 iterations.

Figures 7 and 8 shows the final weighted array that has a peak at the desired of 0° and a null at the interfering direction 60° . The figure shows that LMS AND MVDR beamforming algorithm have recovered the target signal while nulling both the interfering signal and noise

Figure shows the desired signal arrives at the angle 0° and the interfering signal at 60° . The least mean-square algorithm is used to reach the optimum weights as the following results demonstrated.

The algorithm also have to go through many iterations before acceptable convergence is achieved, but it is difficult to track the desired signal if the signal changes rapidly. It is observed

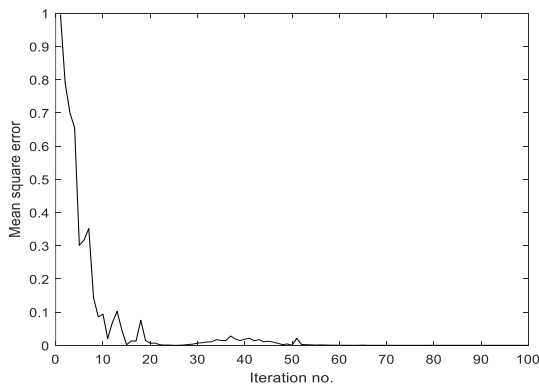

Figure 4: Mean square error (LMS algorithm)

from figure 4 that LMS algorithm converges and reaches optimum weights after about 60 iterations.

Figures 6 and 9 shows comparison of LMS algorithm and MVDR algorithm, simulation result shows that LMS algorithm is more able to closely track array signal as compared to MVDR algorithm.

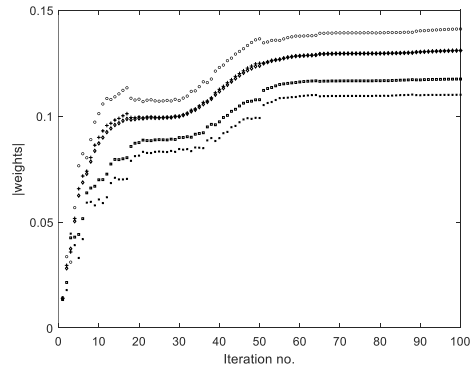

Figure 5: Magnitude of array weights (LMS, N=8)

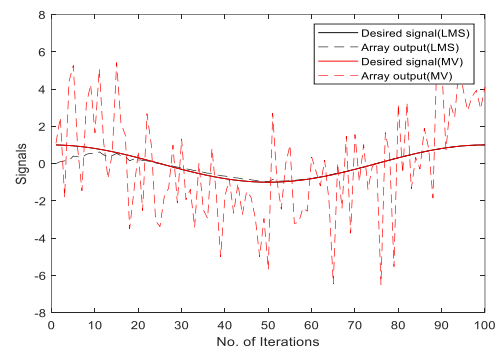

Figure 6: Acquisition and tracking of desired signals (N=8)

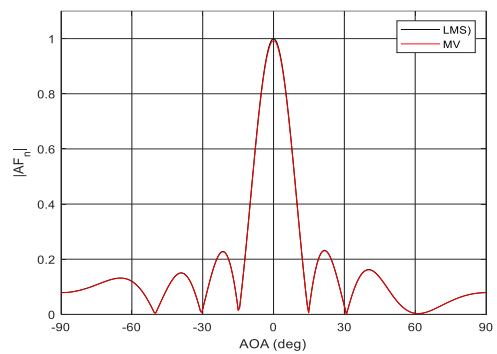

Figure 7: Weighted LMS and MVDR array pattern (N=8)

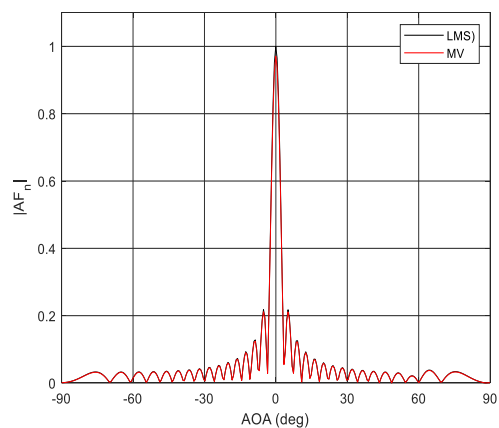

Figure 8: Weighted LMS and MVDR array pattern (N=8)

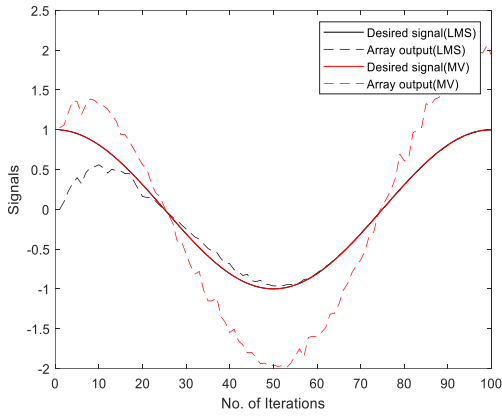

Fig 9: Acquisition and tracking of desired signals (N=32)

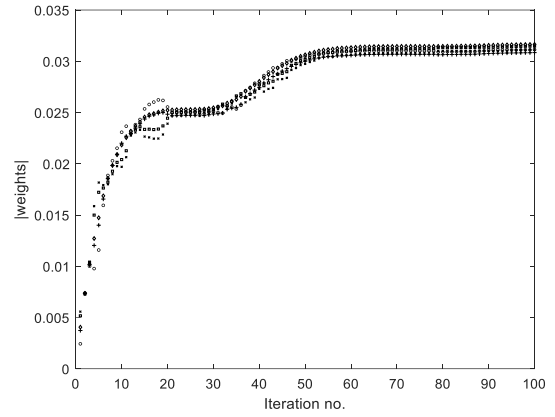

Figure 10: Magnitude of array weights (LMS, N=32)

VII. REFERENCES

- [1] C. Balanis, *Modern Antenna Handbook*. Canada: Wiley, 2008.
- [2] B. Lee and Y. Kim, "Zero-forcing and codebook based beamforming scheme for practical usage of multiuser MIMO-OFDM with uplink channel sounding", *International Journal of Communication Systems*, vol. 30, no. 1, p. e2918, 2014. Available: 10.1002/dac.2918. I. S. Jacobs and C. P. Bean, "Fine particles, thin films and exchange anisotropy," in *Magnetism*, vol. III, G. T. Rado and H. Suhl, Eds. New York: Academic, 1963, pp. 271–350.
- [3] K. Kibaroglu, M. Sayginer, T. Phelps and G. Rebeiz, "A 64-Element 28-GHz Phased-Array Transceiver With 52-dBm EIRP and 8–12-Gb/s 5G Link at 300 Meters Without Any Calibration", *IEEE Transactions on Microwave Theory and Techniques*, vol. 66, no. 12, pp. 5796–5811, 2018. Available: 10.1109/tmtt.2018.2854174. R. Nicole, "Title of paper with only first word capitalized," *J. Name Stand. Abbrev.*, in press.
- [4] K. Kibaroglu, M. Sayginer and G. Rebeiz, "An Ultra Low-Cost 32-Element 28 GHz Phased-Array Transceiver", in *IEEE Radio Frequency Integrated Circuits Symposium*, 2017. M. Young, *The Technical Writer's Handbook*. Mill Valley, CA: University Science, 1989.
- [5] M. Kamaraju, K. Ramakrishna and K. Ramanjaneyulu, "A Novel Adaptive Beam forming RLMS Algorithm for Smart Antenna System", *International Journal of Computer Applications*, vol. 86, no. 5, pp. 27–32, 2014. Available: 10.5120/14983-3189.
- [6] N. Blaunstein and C. Christodoulou, *Radio Propagation and Adaptive Antennas for Wireless Communication Links*. Hoboken: John Wiley & Sons, Incorporated, 2014.
- [7] "BEAMFORMING in LTE | TELETOPIX.ORG", *Teletopix.org*, 2020. [Online]. Available: <http://teletopix.org/4g-lte/beamforming-in-lte/>. [Accessed: 30-Jan-2020].
- [8] "Conventional and Adaptive Beamformers- MATLAB & Simulink-MathWorks United Kingdom", *Uk.mathworks.com*. [Online]. Available: <https://uk.mathworks.com/help/phased/examples/conventional-and-adaptive-beamformers.html#BeamformerExample-2>. [Accessed: 02-Feb-2020].
- [9] W. Roh et al., "Millimeter-wave beamforming as an enabling technology for 5G cellular communications: theoretical feasibility and prototype results", *IEEE Communications Magazine*, vol. 52, no. 2, pp. 106–113, 2014. Available: 10.1109/mcom.2014.6736750 [Accessed 28 January 2020].
- [10] F.B. Gross, *Smart Antenna with Matlab*, 2nd Ed. McGraw Hill Education, 2015.