



Department of Statistical Sciences
University of Padua
Italy

UNIVERSITÀ
DEGLI STUDI
DI PADOVA
DIPARTIMENTO
DI SCIENZE
STATISTICHE

Cross-temporal forecast reconciliation: Optimal combination method and heuristic alternatives

Tommaso Di Fonzo

Department of Statistical Sciences
University of Padua
Italy

Daniele Girolimetto

Department of Statistical Sciences
University of Padua
Italy

Abstract: Forecast reconciliation is a post-forecasting process aimed to improve the quality of the base forecasts for a system of hierarchical/grouped time series (Hyndman et al., 2011). Contemporaneous (cross-sectional) and temporal hierarchies have been considered in the literature, but - except for Kourentzes and Athanasopoulos (2019) - generally these two features have not fully considered together. Adopting a notation able to simultaneously deal with both forecast reconciliation dimensions, the paper shows two new results: (i) an iterative cross-temporal forecast reconciliation procedure which extends, and overcomes some weaknesses of, the two-step procedure by Kourentzes and Athanasopoulos (2019), and (ii) the closed-form expression of the optimal (in least squares sense) point forecasts which fulfill both contemporaneous and temporal constraints. The feasibility of the proposed procedures, along with first evaluations of their performance as compared to the most performing 'single dimension' (either cross-sectional or temporal) forecast reconciliation procedures, is studied through a forecasting experiment on the 95 quarterly time series of the Australian GDP from Income and Expenditure sides considered by Athanasopoulos et al. (2019).

Keywords: Cross-temporal forecast reconciliation, Optimal combination, Heuristics, Hierarchical and Grouped Time Series, Quarterly Australian GDP, Income and Expenditure sides.

JEL classification codes: C22, C61, C82.

Contents

1	Introduction	1
2	Optimal point forecast reconciliation: projection approach	4
3	Hierarchical and Grouped Time Series	6
3.1	Alternative approximations of the covariance matrix for cross-sectional point forecast reconciliation	10
3.2	Matrix representation of the cross-sectional constraints	11
4	Temporal hierarchies	13
4.1	Alternative approximations of the covariance matrix for point forecast reconciliation through temporal hierarchies	16
5	The cross-temporal forecast reconciliation framework	18
5.1	Cross-temporal aggregation constraints	18
5.2	Cross-temporal point forecast reconciliation: introduction	22
5.3	Bottom-up cross-temporal forecast reconciliation	23
6	Cross-temporal optimal forecast combination	25
6.1	Simple alternative approximations of the covariance matrix for cross-temporal point forecast reconciliation	26
7	An heuristic cross-temporal reconciliation procedure	31
7.1	Some remarks	33
7.2	An iterative heuristic cross-temporal reconciliation procedure	35
8	Cross-temporal reconciliation of the Australian GDP forecasts	38
8.1	Performance measures for multiple comparisons	40
8.2	The considered forecast reconciliation procedures	42
8.3	Main results	43
9	Conclusions	50
	References	51
	Appendix	56

Department of Statistical Sciences
Via Cesare Battisti, 241
35121 Padova
Italy

tel: +39 049 8274168
fax: +39 049 8274170
<http://www.stat.unipd.it>

Corresponding author:
Tommaso Di Fonzo
tel: +39 049 827 4158
difonzo@stat.unipd.it
<http://www.stat.unipd.it/~difonzo>

Cross-temporal forecast reconciliation: Optimal combination method and heuristic alternatives

Tommaso Di Fonzo

Department of Statistical Sciences
University of Padua
Italy

Daniele Girolimetto

Department of Statistical Sciences
University of Padua
Italy

Abstract: Forecast reconciliation is a post-forecasting process aimed to improve the quality of the base forecasts for a system of hierarchical/grouped time series (Hyndman et al., 2011). Contemporaneous (cross-sectional) and temporal hierarchies have been considered in the literature, but - except for Kourentzes and Athanasopoulos (2019) - generally these two features have not fully considered together. Adopting a notation able to simultaneously deal with both forecast reconciliation dimensions, the paper shows two new results: (i) an iterative cross-temporal forecast reconciliation procedure which extends, and overcomes some weaknesses of, the two-step procedure by Kourentzes and Athanasopoulos (2019), and (ii) the closed-form expression of the optimal (in least squares sense) point forecasts which fulfill both contemporaneous and temporal constraints. The feasibility of the proposed procedures, along with first evaluations of their performance as compared to the most performing ‘single dimension’ (either cross-sectional or temporal) forecast reconciliation procedures, is studied through a forecasting experiment on the 95 quarterly time series of the Australian GDP from Income and Expenditure sides considered by Athanasopoulos et al. (2019).

Keywords: Cross-temporal forecast reconciliation, Optimal combination, Heuristics, Hierarchical and Grouped Time Series, Quarterly Australian GDP, Income and Expenditure sides.

JEL classification codes: C22, C61, C82.

1 Introduction

In several operational fields, decisions to be successful require the support of accurate, detailed but also coherent forecasts. Forecasts are coherent when the predicted values at the disaggregate and aggregate scales are equal when brought to the same level. For example, temporally coherent monthly predictions sum up to annual ones and similarly geographically coherent regional predictions add up to country level ones. Such a coherence is an important qualifier for forecasts, so as to support

aligned decision making across different planning units and horizons, while avoiding that different decision making units plan on different views of the future. For example, Kourentzes and Athanasopoulos (2019) generate forecasts for Australian domestic tourism that are coherent across multiple geographical divisions (regions, zones, states, and whole country), but are also coherent across time (at monthly, bi-monthly, quarterly, 4-monthly, 6-monthly, and annual levels), i.e. for different planning horizons.

As a matter of fact, in the growing literature on hierarchical forecasts reconciliation the cross-sectional (contemporaneous) and temporal coherency dimensions are mostly considered in separate ways: either ‘time-by-time’ cross-sectional forecast reconciliation for a n -dimensional time series (Hyndman et al., 2011, 2020), or temporal coherency for the forecasts of a single variable for different time frequencies (Athanasopoulos et al., 2017, Hyndman and Kourentzes, 2018). The issue of getting coherent forecasts along both cross-sectional and temporal dimensions (i.e., cross-temporal coherency) has been dealt with by Yagli et al. (2019) and Spiliotis et al. (2020). However, as far as we know, the procedure proposed by Kourentzes and Athanasopoulos (2019) is the only one able to simultaneously fulfill both cross-sectional and temporal coherency in the finally reconciled point forecasts at any considered aggregation dimension.

Whereas the most recent forecast reconciliation procedures for each single coherence dimension are based on some optimality criterion (Van Erven and Cugliari, 2015, Wickramasuriya et al., 2019), the cross-temporal reconciliation procedure by Kourentzes and Athanasopoulos (2019) can be considered as an heuristic with a simple and effective structure, i.e. an approach that employs a practical method that is not guaranteed to be optimal, but which is nevertheless sufficient for reaching an immediate goal, which in our case is the coherency along all the considered dimensions of the reconciled forecasts.

This fact is probably due to the consideration that in a cross-temporal forecast reconciliation framework the complexity and the dimensions of the problem grow very quickly along with the requested computational time and memory (Kourentzes and Athanasopoulos, 2019, Nystrup et al., 2020). This is certainly true, but nevertheless an appropriate, thorough use of some well known linear algebra tools, and the expanding computation facilities, in terms of both calculation power and memory, makes it affordable the task of looking for the optimal solution (in least squares sense) expanding the field of application of the ‘forecast reconciliation methodology’ to simultaneously encompass both contemporaneous (cross-sectional) and temporal coherency dimensions.

Bottom-up and top-down approaches to forecast reconciliation are well known to both practitioners and researchers. In short, according to the bottom-up approach, the forecasts at the most disaggregated level are summed up to obtain the aggregates of interest. On the contrary, in the top-down approach the most aggregated series is forecasted first, and then is disaggregated to provide lower level predictions (Fliedner, 2001, Athanasopoulos et al., 2009, and the references therein). A combination of these two approaches, known as middle-out (Athanasopoulos et al., 2009), selects an intermediate level of (dis)aggregation, and moves downward in a top-down fashion, and onwards according to bottom-up.

However, in the last decade there have been several contributions exploiting a regression based optimal combination approach (Hyndman et al., 2011), which has proven convincing from a mathematical-statistical point of view, enough flexible to be adapted to both cross-sectional and temporal frameworks (Wickramasuryia et al., 2019, and Athanasopoulos et al., 2017, respectively), and very effective in improving the base forecasts from many different application fields (economics, demography, energy, tourism, etc.).

In this paper we consider an optimal combination approach, which takes the base (incoherent and however obtained) forecasts of all nodes in the hierarchy, and reconcile them. We show that all the summation constraints induced by the cross-temporal hierarchy underlying the time series, may be used to reconcile the base forecasts through a simple projection in a well chosen linear space. At this end, we extend the optimal (in least squares sense) solutions separately proposed for each coherency dimension, developing the optimal point forecasting procedure which - while exploiting both cross-sectional and temporal hierarchies - simultaneously fulfills both contemporaneous and temporal constraints. We refer this as optimal combination cross-temporal forecast reconciliation. In addition, grounding on the existing literature on this topic (Wickramasuriya et al., 2019, Athanasopoulos et al., 2017, and Nystrup et al., 2020), we discuss some simple approximations of the covariance matrix to be used in the statistical point forecast reconciliation, with focus on those making use of the in-sample residuals (when available) of the models used to get the base forecasts. The strictly, and very important related issue of probabilistic forecast reconciliation (Gamakumara et al., 2018, Athanasopoulos et al., 2019, Hong et al., 2019, Jeon et al., 2019, Roach, 2019, Ben Taieb et al., 2020, Yang, 2020) is not considered in this paper, and will be dealt with in the next future.

The paper is organized as follows. We start by presenting the general framework of point forecast reconciliation according to a projection approach (Panagiotelis et al., 2020), avoiding reference to cross-sectional or time indices (section 2). Hierarchical and grouped systems of multivariate time series are introduced in section 3. The temporal hierarchies which characterize a single time series are discussed in section 4. The cross-sectional and temporal coherency dimensions are dealt with simultaneously in section 5, and the optimal (in least squares sense) solution to the cross-temporal forecast reconciliation problem is then developed in section 6. The heuristics proposed by Kourentzes and Athanasopoulos (2019) is described in section 7, where some variants of that procedure are discussed, and a very simple (and possibly more effective) iterative cross-temporal reconciliation procedure is proposed. The feasibility of all the proposed procedures, along with the evaluation of their performance as compared to the most performing ‘single dimension’ (either cross-sectional or temporal) forecast reconciliation procedures, is studied in section 8 through a forecasting experiment on the 95 quarterly time series of the Australian GDP from Income and Expenditure sides considered by Athanasopoulos et al. (2019) and Bisaglia et al. (2020). Section 9 presents conclusions and lists some topics in this field worth to be considered for future research. Finally, the Appendix contains complementary materials, on both methodological and practical issues, not considered into the paper for length reasons. In addition, it contains supplementary tables and graphs related to the empirical application.

Symbols and notation used in the paper

Symbols	Description
n_b, n_a, n	Number of bottom, upper, and total time series ($n = n_a + n_b$)
m	Highest available sampling frequency per seasonal cycle (max. order of temporal aggregation)
$h \geq 1$	Forecast horizon for the lowest frequency time series
T	Number of high-frequency observations used in the forecasting models
N	Number of observations at the lowest frequency: $N = \frac{T}{m}$
\mathcal{K}	Set of factors of m in descending order: $\mathcal{K} = \{k_p, k_{p-1}, \dots, k_2, k_1\}$, $k_p = m, k_1 = 1$
k^*	$\sum_{j=1}^{p-1} k_j$
M_k	$\frac{m}{k}, k \in \mathcal{K}$
$\mathbf{b}_t \in \mathbb{R}^{n_b}$	vector containing the bottom time series (bts) at time t
$\mathbf{a}_t \in \mathbb{R}^{n_a}$	vector containing the upper time series (uts) at time t
$\mathbf{y}_t \in \mathbb{R}^n$	vector containing the time series $\mathbf{y}_t = [\mathbf{a}'_t \ \mathbf{b}'_t]'$ at time t
$\mathbf{Y}, \hat{\mathbf{Y}}, \tilde{\mathbf{Y}} \in \mathbb{R}^{n \times h(k^*+m)}$	Matrices of target, base and cross-temporally reconciled forecasts
$\mathbf{Y}^{[k]}, k \in \mathcal{K}$	$(n \times hM_k)$ matrix containing the target forecasts of the level k temporally aggregated series. Component of matrix $\mathbf{Y} = [\mathbf{Y}^{[m]} \ \mathbf{Y}^{[k_{p-1}]} \ \dots \ \mathbf{Y}^{[k_2]} \ \mathbf{Y}^{[1]}]$
$\hat{\mathbf{Y}}^{[k]}, k \in \mathcal{K}$	$(n \times hM_k)$ matrix containing the base forecasts of the level k temporally aggregated series. Component of matrix $\hat{\mathbf{Y}} = [\hat{\mathbf{Y}}^{[m]}, \hat{\mathbf{Y}}^{[k_{p-1}]}, \dots, \hat{\mathbf{Y}}^{[k_2]}, \hat{\mathbf{Y}}^{[1]}]$
$\tilde{\mathbf{Y}}^{[k]}, k \in \mathcal{K}$	$(n \times hM_k)$ matrix containing the cross-temporally reconciled forecasts of the level k temporally aggregated series. Component of matrix $\tilde{\mathbf{Y}} = [\tilde{\mathbf{Y}}^{[m]}, \tilde{\mathbf{Y}}^{[k_{p-1}]}, \dots, \tilde{\mathbf{Y}}^{[k_2]}, \tilde{\mathbf{Y}}^{[1]}]$
$\mathbf{A}^{[k]}, \mathbf{B}^{[k]}, k \in \mathcal{K}$	$(n_a \times hM_k)$ and $(n_b \times hM_k)$ components of matrix $\mathbf{Y}^{[k]} = \begin{bmatrix} \mathbf{A}^{[k]} \\ \mathbf{B}^{[k]} \end{bmatrix}$
$\mathbf{B}^* \in \mathbb{R}^{n_b \times hk^*}$	$[\mathbf{B}^{[m]} \ \mathbf{B}^{[k_{p-1}]} \ \dots \ \mathbf{B}^{[k_2]}]$
$\mathbf{y}, \hat{\mathbf{y}}, \tilde{\mathbf{y}} \in \mathbb{R}^{nh(k^*+m)}$	$\mathbf{y} = \text{vec}(\mathbf{Y}')$, $\hat{\mathbf{y}} = \text{vec}(\hat{\mathbf{Y}}')$, $\tilde{\mathbf{y}} = \text{vec}(\tilde{\mathbf{Y}}')$
$\tilde{\mathbf{y}} \in \mathbb{R}^{nh(k^*+m)}$	Alternative vectorization of matrix \mathbf{Y} , used in the cross-temporal structural representation: $\tilde{\mathbf{y}} = \begin{bmatrix} \text{vec}(\mathbf{A}') \\ \text{vec}(\mathbf{B}^*) \\ \text{vec}(\mathbf{B}^{[1]'}) \end{bmatrix}$
$\mathbf{C} \in \mathbb{R}^{n_a \times n_b}$	Cross-sectional (contemporaneous) aggregation matrix
$\mathbf{S} \in \mathbb{R}^{n \times n_b}$	Cross-sectional (contemporaneous) summing matrix
$\mathbf{U}' \in \mathbb{R}^{n_a \times n}$	Zero constraints cross-sectional kernel matrix: $\mathbf{U}'\mathbf{Y} = \mathbf{0}_{[n_a \times (k^*+m)]}$
$\mathbf{K}_h \in \mathbb{R}^{hk^* \times hm}$	Temporal aggregation matrix
$\mathbf{R}_h \in \mathbb{R}^{h(k^*+m) \times hm}$	Temporal summing matrix
$\mathbf{Z}'_h \in \mathbb{R}^{hk^* \times h(k^*+m)}$	Zero constraints temporal kernel matrix: $\mathbf{Z}'_h\mathbf{Y}' = \mathbf{0}_{[hk^* \times n]}$
$\mathbf{H}' \in \mathbb{R}^{hn_a^* \times nh(k^*+m)}$	Zero constraints full row-rank cross-temporal kernel matrix: $\mathbf{H}'\mathbf{y} = \mathbf{0}$
$\check{\mathbf{C}} \in \mathbb{R}^{n_a^* \times n_b m}$	Cross-temporal aggregation matrix (structural representation) for $h = 1$
$\check{\mathbf{S}} \in \mathbb{R}^{n(k^*+m) \times n_b m}$	Cross-temporal summing matrix (structural representation) for $h = 1$
$\check{\mathbf{H}}' \in \mathbb{R}^{hn_a^* \times nh(k^*+m)}$	Zero constraints full row-rank cross-temporal kernel matrix valid for $\tilde{\mathbf{y}}$: $\check{\mathbf{H}}'\tilde{\mathbf{y}} = \mathbf{0}$

2 Optimal point forecast reconciliation: projection approach

Forecast reconciliation is a post-forecasting process aimed to improve the quality of the *base* forecasts for a system of hierarchical/grouped, and more generally linearly constrained, time series (Hyndman et al., 2011, Panagiotelis et al., 2020) by exploiting the constraints that the series in the system must fulfill, whereas in general the

base forecasts don't.

Let \mathbf{y} be a $(s \times 1)$ vector of target point forecasts which are wished to satisfy the system of linearly independent constraints

$$\mathbf{H}'\mathbf{y} = \mathbf{0}_{(r \times 1)}, \quad (1)$$

where \mathbf{H}' is a $(r \times s)$ matrix, with $\text{rank}(\mathbf{H}') = r < s$, and $\mathbf{0}_{(r \times 1)}$ is a $(r \times 1)$ null vector. Let $\hat{\mathbf{y}}$ be a $(s \times 1)$ vector of unbiased point forecasts, not fulfilling the linear constraints (1) (i.e., $\mathbf{H}'\hat{\mathbf{y}} \neq \mathbf{0}$).

Drawing upon Stone et al. (1942), Byron (1978), Weale (1988), Solomou and Weale (1993), and Dagum and Cholette (2006), among others, we consider a regression-based reconciliation method assuming that $\hat{\mathbf{y}}$ is related to \mathbf{y} by

$$\hat{\mathbf{y}} = \mathbf{y} + \varepsilon, \quad (2)$$

where ε is a $(s \times 1)$ vector of zero mean disturbances, with known p.d. covariance matrix \mathbf{W} . The reconciled forecasts $\tilde{\mathbf{y}}$ are found by minimizing the generalized least squares (GLS) objective function $(\hat{\mathbf{y}} - \mathbf{y})' \mathbf{W}^{-1} (\hat{\mathbf{y}} - \mathbf{y})$ constrained by (1):

$$\tilde{\mathbf{y}} = \arg \min_{\mathbf{y}} (\mathbf{y} - \hat{\mathbf{y}})' \mathbf{W}^{-1} (\mathbf{y} - \hat{\mathbf{y}}), \quad \text{s.t. } \mathbf{H}'\mathbf{y} = \mathbf{0}.$$

The solution is given by (see Appendix A.1):

$$\tilde{\mathbf{y}} = \hat{\mathbf{y}} - \mathbf{W}\mathbf{H}(\mathbf{H}'\mathbf{W}\mathbf{H})^{-1}\mathbf{H}'\hat{\mathbf{y}} = \mathbf{M}\hat{\mathbf{y}}, \quad (3)$$

where $\mathbf{M} = \mathbf{I}_s - \mathbf{W}\mathbf{H}(\mathbf{H}'\mathbf{W}\mathbf{H})^{-1}\mathbf{H}'$ is a $(s \times s)$ projection matrix¹. Denoting with $\mathbf{d}_{\hat{\mathbf{y}}} = \mathbf{0} - \mathbf{H}'\hat{\mathbf{y}}$ the $(r \times 1)$ vector containing the base forecasts' 'coherency' errors, we can re-state expression (3) as

$$\tilde{\mathbf{y}} = \hat{\mathbf{y}} + \mathbf{W}\mathbf{H}(\mathbf{H}'\mathbf{W}\mathbf{H})^{-1}\mathbf{d}_{\hat{\mathbf{y}}},$$

which makes it clear that the reconciliation formula (3) simply 'adjusts' the original forecasts vector $\hat{\mathbf{y}}$ with a linear combination – according to the smoothing matrix $\mathbf{W}\mathbf{H}(\mathbf{H}'\mathbf{W}\mathbf{H})^{-1}$ – of the coherency errors in the base forecasts. In addition, if the error term of model (2) is gaussian, the reconciliation error $\tilde{\varepsilon} = \tilde{\mathbf{y}} - \mathbf{y}$ is a zero-mean gaussian vector with covariance matrix

$$E(\tilde{\mathbf{y}} - \mathbf{y})(\tilde{\mathbf{y}} - \mathbf{y})' = \mathbf{W} - \mathbf{W}\mathbf{H}(\mathbf{H}'\mathbf{W}\mathbf{H})^{-1}\mathbf{H}' = \mathbf{M}\mathbf{W}.$$

Hyndman et al. (2011, see also Wickramasurya et al., 2019) propose an alternative formulation as for the reconciled estimates, equivalent to expression (3) and obtained by GLS estimation of the model

$$\hat{\mathbf{y}} = \mathbf{S}\beta + \varepsilon, \quad (4)$$

where \mathbf{S} is a 'structural summation matrix' describing the aggregation relationships operating on \mathbf{y} , and β is a subset of \mathbf{y} containing the target forecasts of the bottom

¹A geometric interpretation of the entire hierarchical forecasting problem is given by Panagiotelis et al. (2020).

level series, such that $\mathbf{y} = \mathbf{S}\beta$ (see section 3). Since the hypotheses on ε remain unchanged, it can be shown (see Appendix A.1) that

$$\tilde{\beta} = (\mathbf{S}'\mathbf{W}^{-1}\mathbf{S})^{-1}\mathbf{S}'\mathbf{W}^{-1}\hat{\mathbf{y}}$$

is the best linear unbiased estimate of β , and that the whole reconciled forecasts vector is given by

$$\tilde{\mathbf{y}} = \mathbf{S}\tilde{\beta} = \mathbf{S}\mathbf{G}\hat{\mathbf{y}},$$

where $\mathbf{G} = (\mathbf{S}'\mathbf{W}^{-1}\mathbf{S})^{-1}\mathbf{S}'\mathbf{W}^{-1}$.

As witnessed by the huge literature on adjusting preliminary data (as the base forecasts can be considered) in order to fulfill some externally imposed constraints, the distinctive feature of the generalized least-squares reconciliation approach is that it can take into account the ‘quality’, however measured, of the preliminary estimates, through an appropriate choice of the covariance matrix \mathbf{W} . However, for a long time these procedures have depended on the assumption that this matrix (or any other indicators of the estimates’ accuracy) of the figures to be reconciled was known. In many practical situation \mathbf{W} is assumed to be diagonal, and the data are adjusted in the light of their relative variances so as to satisfy the linear restrictions. But another - perhaps more delicate - challenge raises when either any reliability measure is available or it can be hardly deduced by the data. The solutions proposed in literature for this case are basically of two types, both of which are consistent with the least-squares approach shown so far:

1. mathematical/mechanical solutions: the base forecasts are balanced by minimizing a penalty criterion which ‘induces’ a covariance matrix (which is simply a statistical artifact);
2. data-based solutions: the variability of the base forecasts to be reconciled is estimated through the models and the data used to produce the forecasts.

As for point forecast reconciliation, in the following we will consider both approaches, with an explicit preference towards approximations of \mathbf{W} based on the in-sample residuals (when available), which appear both more convincing from a statistical point of view, and generally well-performing in practical applications. However, this topic deserves further attention (see, for example, Kourentzes, 2017, 2018), and will be considered for future research.

3 Hierarchical and Grouped Time Series

Extending the definition of hierarchical time series given by Panagiotelis et al. (2020), a linearly constrained time series \mathbf{y}_t is a n -dimensional time series such that all observed values $\mathbf{y}_1 \dots \mathbf{y}_T$ and all future values $\mathbf{y}_{T+1}, \mathbf{y}_{T+2} \dots$ lie in the coherent linear subspace \mathcal{S} , that is: $\mathbf{y}_t \in \mathcal{S}, \forall t$. In many situations, the time series are linked through summation constraints, which induce a hierarchy. Figure 1 gives an example of a hierarchical system with eight variables and three levels: the top-variable at level 1, two variables (A and B) at level 2, and five variables at level 3 (AA, AB, BA, BB, BC). The temporal observations of these variables form a

hierarchical time series, consisting of 5 bottom time series (bts) and 3 aggregated upper time series (uts).

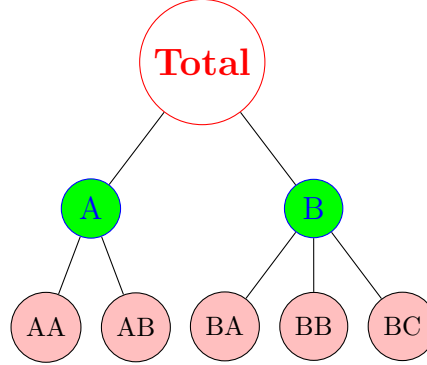

Figure 1: A simple two-level hierarchical structure

Assuming that the relationship mapping the lower-level series in the hierarchy of Figure 1 into the higher ones always be a simple summation², the bottom-level series can be thought as building blocks that cannot be obtained as sum of other series in the hierarchy, while all the series at upper levels can be expressed by appropriately summing part or all of them. For all time periods $t = 1, \dots, T$, the link between the top level series y_t and the bottom level series is given by:

$$y_t = y_{AA,t} + y_{AB,t} + y_{BA,t} + y_{BB,t} + y_{BC,t}. \quad (5)$$

At the same time, the nodes at the intermediate level of the hierarchy satisfy the aggregation constraints:

$$\begin{aligned} y_{A,t} &= y_{AA,t} + y_{AB,t} \\ y_{B,t} &= y_{BA,t} + y_{BB,t} + y_{BC,t} \end{aligned} \quad (6)$$

In summary, there are as many summation constraints as many nodes with leaves (3, i.e. Total, A, B). Consider now the matrices \mathbf{C} , \mathbf{S} , and \mathbf{U}' , of dimension (3×5) , (8×5) , and (3×8) , respectively:

$$\mathbf{C} = \begin{bmatrix} 1 & 1 & 1 & 1 & 1 \\ 1 & 1 & 0 & 0 & 0 \\ 0 & 0 & 1 & 1 & 1 \end{bmatrix}, \quad \mathbf{S} = \begin{bmatrix} 1 & 1 & 1 & 1 & 1 \\ 1 & 1 & 0 & 0 & 0 \\ 0 & 0 & 1 & 1 & 1 \\ 1 & 0 & 0 & 0 & 0 \\ 0 & 1 & 0 & 0 & 0 \\ 0 & 0 & 1 & 0 & 0 \\ 0 & 0 & 0 & 1 & 0 \\ 0 & 0 & 0 & 0 & 1 \end{bmatrix} = \begin{bmatrix} \mathbf{C} \\ \mathbf{I}_5 \end{bmatrix}, \quad \mathbf{U}' = [\mathbf{I}_3 \quad -\mathbf{C}],$$

²For space reasons, in this paper only simple summation for both contemporaneous and temporal aggregation relationships is considered. Remaining in a linear framework, the extension to general linear constraints (i.e., weighted summation), able to cover other important data features, is rather straightforward (Shang, 2017, 2019, Shang and Hyndman, 2017, Li and Hyndman, 2019, Panagiotelis et al., 2020).

where matrix \mathbf{U}' encodes each summation relationship in a row, with 1 at the associated node, and -1 at its leaves.

Expressions (5) and (6) can be written in a more compact way if we define the vectors of *bottom level* (\mathbf{b}_t) and *upper level* (\mathbf{a}_t) time series at time t as, respectively,

$$\mathbf{b}_t = \begin{bmatrix} y_{AA,t} \\ y_{AB,t} \\ y_{BA,t} \\ y_{BA,t} \\ y_{BA,t} \end{bmatrix}, \quad \mathbf{a}_t = \begin{bmatrix} y_t \\ y_{A,t} \\ y_{B,t} \end{bmatrix}.$$

Denoting by \mathbf{y}_t the (8×1) vector $\mathbf{y}_t = [\mathbf{a}_t' \ \mathbf{b}_t']'$, the relationships linking bottom and upper time series can be equivalently expressed as:

$$\mathbf{a}_t = \mathbf{C}\mathbf{b}_t, \quad \mathbf{y}_t = \mathbf{S}\mathbf{b}_t, \quad \mathbf{U}'\mathbf{y}_t = \mathbf{0}_{(3 \times 1)}, \quad t = 1, \dots, T. \quad (7)$$

Thus, for any time index t , \mathbf{y}_t is in the kernel of \mathbf{U}' , also known as null-space of the linear transformation induced by matrix \mathbf{U}' , which is given by the set of vectors $\mathbf{v} \in \mathbb{R}^7$, such that $\mathbf{U}'\mathbf{v} = \mathbf{0}_3$ (Harville, 2008, p. 591). We call *structural representation* of series \mathbf{y}_t the formulation

$$\mathbf{y}_t = \mathbf{S}\mathbf{b}_t, \quad t = 1, \dots, T,$$

and *zero constraints kernel representation* of series \mathbf{y}_t the equivalent expression

$$\mathbf{U}'\mathbf{y}_t = \mathbf{0}, \quad t = \dots, T.$$

A linearly constrained time series formed by two or more hierarchical time series sharing the same top level series, and the same bottom level series, is called grouped time series (Hyndman et al., 2011, Hyndman and Athanasopoulos, 2018). Provided matrix \mathbf{C} is appropriately designed, the definitions of matrices \mathbf{S} and \mathbf{U}' , depending solely on matrix \mathbf{C} , remain unchanged.

It should be noted that we can face linearly constrained time series for which the structural representation $\mathbf{y}_t = \mathbf{S}\mathbf{b}_t$ does not give a straightforward view of the links between bottom and upper level time series. Figure 2 shows two very simple hierarchies, where the variables of each hierarchy contribute (from different sides) to the same top level variable X , and the bottom level series of the hierarchy on the left side ($A1, A2, B$) are independent from those on the right side (C, D).

The aggregation relationships between the upper variables X and A , and the bottom ones $A1, A2, B, C$, and D are given by:

$$\begin{aligned} X &= A1 + A2 + B \\ X &= C + D \\ A &= A1 + A2 \end{aligned} \quad (8)$$

Expression (8) cannot be represented as a mapping from the bottom variables into (themselves, and) the upper variables. Nevertheless, it is possible to set up the

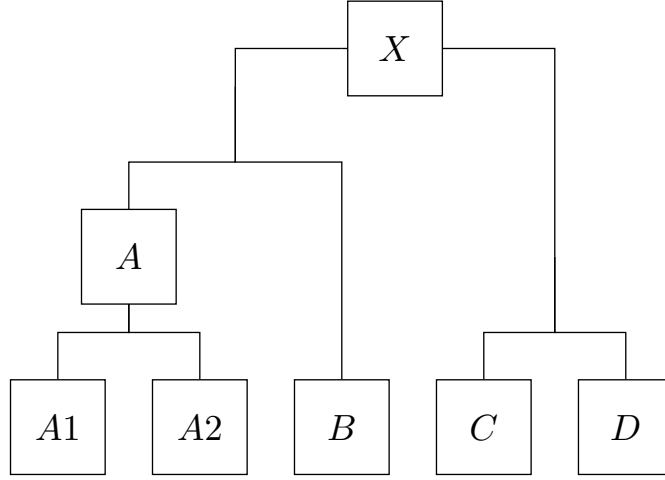
Figure 2: Two hierarchies sharing the same top-level series X

constraints valid for all the component series in $\mathbf{y} = [X \ A \ A1 \ A2 \ B \ C \ D]'$ through the matrix

$$\check{\mathbf{U}}' = \begin{bmatrix} 1 & 0 & -1 & -1 & -1 & 0 & 0 \\ 1 & 0 & 0 & 0 & 0 & -1 & -1 \\ 0 & 1 & -1 & -1 & 0 & 0 & 0 \end{bmatrix},$$

such that $\check{\mathbf{U}}'\mathbf{y} = \mathbf{0}_{(3 \times 1)}$. After simple operations on expression (8), it is found:

$$\begin{aligned} X &= C + D \\ A &= -B + C + D \\ A1 &= -A2 - B + C + D \end{aligned}, \quad (9)$$

so we can write $\mathbf{U}'\mathbf{y} = \mathbf{0}_{(3 \times 1)}$, with

$$\mathbf{U}' = \begin{bmatrix} 1 & 0 & 0 & 0 & 0 & -1 & -1 \\ 0 & 1 & 0 & 0 & 1 & -1 & -1 \\ 0 & 0 & 1 & 1 & 1 & -1 & -1 \end{bmatrix} = [\mathbf{I}_3 \quad -\mathbf{C}].$$

While there is no practical problem in working with such constraints, it is clear that they do not conform to the visual pattern of the linearly constrained time series in Figure 2, where $A1$ appears as a ‘bottom variable’, whereas in (9) it is expressed as linear combination of series $A2$, B , C , and D .

In addition, notice that the left side hierarchy of Figure 2 is ‘unbalanced’, in the sense that unlike node A , node B has no children, and thus is located at the bottom level of the hierarchy, though it could be considered at the same level as node A . Situations like that, often met in practice when dealing with hierarchical/grouped time series, require an appropriate formulation of the cross-sectional aggregation matrix \mathbf{C} , in order to avoid nodes’ duplication (see Appendix A.2).

3.1 Alternative approximations of the covariance matrix for cross-sectional point forecast reconciliation

Suppose we have the $(n \times 1)$ vector $\hat{\mathbf{y}}_h$ of unbiased base forecasts for the n variables of the linearly constrained series \mathbf{y}_t for the forecast horizon h . If the base forecasts have been independently computed, generally they do not fulfill the cross-sectional aggregation constraints, i.e. $\mathbf{U}'\hat{\mathbf{y}}_h \neq \mathbf{0}_{n \times 1}$. By adapting the general point forecast reconciliation formula (3), the vector of reconciled forecasts is given by:

$$\tilde{\mathbf{y}}_h = \hat{\mathbf{y}}_h - \mathbf{W}_{\text{cs}} \mathbf{U} (\mathbf{U}' \mathbf{W}_{\text{cs}} \mathbf{U})^{-1} \mathbf{U}' \hat{\mathbf{y}}_h, \quad (10)$$

where \mathbf{W}_{cs} is a $(n \times n)$ p.d. matrix, assumed known, and suffix ‘cs’ stands for ‘cross-sectional’. Alternative choices for \mathbf{W}_{cs} proposed in literature are the following:

- identity (cs-ols): $\mathbf{W}_{\text{cs}} = \mathbf{I}_n$ (Hyndman et al. 2011),
- structural (cs-struc): $\mathbf{W}_{\text{cs}} = \text{diag}(\mathbf{S}\mathbf{1}_{n_b})$ (Athanasopoulos et al., 2017),
- series variance (cs-wls): $\mathbf{W}_{\text{cs}} = \widehat{\mathbf{W}}_{\text{cs-var}} = \mathbf{I}_n \odot \widehat{\mathbf{W}}_1$ (Hyndman et al., 2016),
- MinT-shr (cs-shr): $\mathbf{W}_{\text{cs}} = \widehat{\mathbf{W}}_{\text{cs-shr}} = \hat{\lambda} \widehat{\mathbf{W}}_{\text{cs-var}} + (1 - \hat{\lambda}) \widehat{\mathbf{W}}_1$ (Wickramasuriya et al., 2019),
- MinT-sam (cs-sam): $\mathbf{W}_{\text{cs}} = \widehat{\mathbf{W}}_1$ (Wickramasuriya et al., 2019),

where the symbol \odot denotes the Hadamard product, $\hat{\lambda}$ is an estimated shrinkage coefficient (Shäfer and Strimmer, 2005), $\widehat{\mathbf{W}}_1$ is the sample covariance matrix of the one-step ahead in-sample forecast errors³:

$$\widehat{\mathbf{W}}_1 = \frac{1}{T} \sum_{t=1}^T \hat{\mathbf{e}}_t \hat{\mathbf{e}}_t', \quad (11)$$

and $\hat{\mathbf{e}}_t = \mathbf{y}_t - \hat{\mathbf{y}}_t$, $t = 1, \dots, T$, are $(n \times 1)$ vectors of in-sample forecast errors.

The first three matrices are diagonal, and in the first case the projection is orthogonal, whereas the latter two ones (cs-shr and cs-sam) have been proposed within the minimum-trace point forecast reconciliation approach by Wickramasuriya et al. (2019). It should be noted that the quality of the estimate $\widehat{\mathbf{W}}_1$ crucially depends on the dimension of T . In particular, when $T < n$, matrix $\widehat{\mathbf{W}}_1$ is singular, which prevents the matrix inversion in expression (10). The shrunk version $\widehat{\mathbf{W}}_{\text{cs-shr}}$ is a feasible alternative, well performing in many practical situations (Wickramasuriya et al., 2019).

³Expression (11) assumes that $T^{-1} \sum_{t=1}^T \hat{\mathbf{e}}_{t,i} = 0$, $i = 1, \dots, n$. When this does not hold, $\widehat{\mathbf{W}}_1$ is the sample Mean Square Error (MSE) matrix.

3.2 Matrix representation of the cross-sectional constraints

Let us denote with

$$\mathbf{b}_t = [b_{1t} \dots b_{jt} \dots b_{n_b t}]', \quad t = 1, \dots, T, \quad (12)$$

the T vectors, each of dimension $(n_b \times 1)$, containing the *high-frequency bottom-time series* (hf-bts), that is the bottom series of the hierarchy/group observed at the highest available temporal frequency. As we shall see in section 5, in cross-temporal hierarchies of time series the hf-bts should be considered as the ‘very’ bottom series of the system, since they cannot be formed as either contemporaneous or temporal sum of other variables. Likewise, let us denote with

$$\mathbf{a}_t = [a_{1t} \dots a_{it} \dots a_{n_a t}]', \quad t = 1, \dots, T, \quad (13)$$

the T vectors, each of dimension $(n_a \times 1)$, containing the *high-frequency upper-time series* (hf-uts), which are the cross-sectionally aggregated series of the hierarchy/group, observed at the highest temporal frequency.

At each time $t = 1, \dots, T$, the cross-sectional (contemporaneous) aggregation constraints that map the hf-bts into the hf-uts can be written as:

$$\mathbf{a}_t = \mathbf{C}\mathbf{b}_t, \quad t = 1, \dots, T, \quad (14)$$

where \mathbf{C} is a $(n_a \times n_b)$ *contemporaneous aggregation matrix*. The structural representation of the linearly constrained time series \mathbf{y}_t is in turn given by (Hyndman et al., 2011):

$$\begin{bmatrix} \mathbf{a}_t \\ \mathbf{b}_t \end{bmatrix} = \begin{bmatrix} \mathbf{C} \\ \mathbf{I}_{n_b} \end{bmatrix} \mathbf{b}_t \Rightarrow \mathbf{y}_t = \mathbf{S}\mathbf{b}_t, \quad t = 1, \dots, T,$$

where $\mathbf{S} = \begin{bmatrix} \mathbf{C} \\ \mathbf{I}_{n_b} \end{bmatrix}$ is a $(n \times n_b)$ *contemporaneous summing matrix*, with $n = n_a + n_b$. The constraints valid for \mathbf{y}_t can be expressed in kernel form through the $(n_a \times n)$ *zero constraints matrix*

$$\mathbf{U}' = [\mathbf{I}_{n_a} \quad -\mathbf{C}],$$

that is:

$$\mathbf{U}'\mathbf{y}_t = \mathbf{0}_{(n_a \times 1)}, \quad t = 1, \dots, T.$$

Now, denote \mathbf{B} the $(n_b \times T)$ matrix containing the T observations of the n_b -variate hf-bts of the system:

$$\mathbf{B} = \begin{bmatrix} b_{11} & \dots & b_{1t} & \dots & b_{1T} \\ \vdots & \ddots & \vdots & \ddots & \vdots \\ b_{i1} & \dots & b_{it} & \dots & b_{iT} \\ \vdots & \ddots & \vdots & \ddots & \vdots \\ b_{n_b 1} & \dots & b_{n_b t} & \dots & b_{n_b T} \end{bmatrix} = [\mathbf{b}_1 \quad \dots \quad \mathbf{b}_t \quad \dots \quad \mathbf{b}_T] = \begin{bmatrix} \mathbf{b}_1^{*'} \\ \vdots \\ \mathbf{b}_i^{*'} \\ \vdots \\ \mathbf{b}_{n_b}^{*'} \end{bmatrix},$$

where \mathbf{b}_t has been defined by (12), and

$$\mathbf{b}_i^* = [b_{i1} \dots b_{it} \dots b_{iT}]', \quad i = 1, \dots, n_b,$$

is the $(T \times 1)$ vector containing all the observations of the i -th univariate hf-bts, where the asterisk in \mathbf{b}_i^* is used to distinguish this vector, which combines b_{it} across all times for one series, from \mathbf{b}_t , which combines b_{it} across all series for one time.

We consider the $(n_a \times T)$ matrix \mathbf{A} for the hf-uts as well:

$$\mathbf{A} = \begin{bmatrix} a_{11} & \dots & a_{1t} & \dots & a_{1T} \\ \vdots & \ddots & \vdots & \ddots & \vdots \\ a_{j1} & \dots & a_{jt} & \dots & a_{jT} \\ \vdots & \ddots & \vdots & \ddots & \vdots \\ a_{n_a 1} & \dots & a_{n_a t} & \dots & a_{n_a T} \end{bmatrix} = [\mathbf{a}_1 \quad \dots \quad \mathbf{a}_t \quad \dots \quad \mathbf{a}_T] = \begin{bmatrix} \mathbf{a}_1^{*'} \\ \vdots \\ \mathbf{a}_j^{*'} \\ \vdots \\ \mathbf{a}_{n_a}^{*'} \end{bmatrix},$$

where \mathbf{a}_t was defined by (13), and

$$\mathbf{a}_j^* = [a_{j1} \dots a_{jt} \dots a_{jT}]', \quad j = 1, \dots, n_a,$$

is the $(T \times 1)$ vector containing all the observations of the j -th univariate component hf-uts.

The cross-sectional (contemporaneous) aggregation relationships (14) linking bottom and upper time series of \mathbf{y}_t can thus be expressed in compact form, by simultaneously encompassing all T time periods, for both types of data organization. In fact, extending expression (14) to the whole observation period, it is

$$\mathbf{A} = \mathbf{C}\mathbf{B}, \quad (15)$$

which is equivalent to

$$\mathbf{U}'\mathbf{Y} = \mathbf{0}_{(n_a \times T)}, \quad (16)$$

where

$$\mathbf{Y} = \begin{bmatrix} \mathbf{A} \\ \mathbf{B} \end{bmatrix}$$

is the $(n \times T)$ matrix containing the observations of all n series. It is worth noting that the cross-sectional constraints (15) and (16) hold at any time observation index of any temporal frequency. This has to be considered when dealing with cross-temporal hierarchies (see section 5).

Now, let us consider two vectorized forms of matrices \mathbf{B} and \mathbf{A} , namely:

$$\mathbf{b} = \text{vec}(\mathbf{B}), \quad \mathbf{a} = \text{vec}(\mathbf{A}),$$

$$\mathbf{b}^* = \text{vec}(\mathbf{B}'), \quad \mathbf{a}^* = \text{vec}(\mathbf{A}').$$

Both \mathbf{b} and \mathbf{b}^* have the same dimension $(Tn_b \times 1)$, and this holds for \mathbf{a} and \mathbf{a}^* as well, which have dimension $(Tn_a \times 1)$. However, in the former case (\mathbf{b} and \mathbf{a}) the data is organized ‘by-time-first-and-then-by-variable’:

$$\mathbf{b} = [\mathbf{b}'_1 \dots \mathbf{b}'_t \dots \mathbf{b}'_T]', \quad \mathbf{a} = [\mathbf{a}'_1 \dots \mathbf{a}'_t \dots \mathbf{a}'_T]'$$

whereas in the latter (\mathbf{b}^* and \mathbf{a}^*) the data is organized ‘by-variable-first-and-then-by-time’:

$$\mathbf{b}^* = [\mathbf{b}^{*'}_1 \dots \mathbf{b}^{*'}_j \dots \mathbf{b}^{*'}_{n_b}]', \quad \mathbf{a}^* = [\mathbf{a}^{*'}_1 \dots \mathbf{a}^{*'}_j \dots \mathbf{a}^{*'}_{n_a}]'$$

Switching between the two data representations is very simple, since vector \mathbf{b} (\mathbf{a}) can be obtained by simple transformation of vector \mathbf{b}^* (\mathbf{a}^*) through an appropriate permutation matrix, and *vice-versa* (see Appendix A.3.1).

Depending on the preferred data organization type, the cross-sectional constraints (15) can be equivalently expressed in vectorized form as (Harville, 2008, pp. 345):

$$\begin{aligned} \mathbf{a} &= \text{vec}(\mathbf{A}) = (\mathbf{I}_T \otimes \mathbf{C}) \text{vec}(\mathbf{B}) = (\mathbf{I}_T \otimes \mathbf{C}) \mathbf{b}, \\ \mathbf{a}^* &= \text{vec}(\mathbf{A}') = (\mathbf{C} \otimes \mathbf{I}_T) \text{vec}(\mathbf{B}') = (\mathbf{C} \otimes \mathbf{I}_T) \mathbf{b}^*, \end{aligned} \quad (17)$$

where the symbol \otimes denotes the Kronecker product. Expressions (17) can be also formulated using matrix \mathbf{U}' , as in (16), i.e.

$$(\mathbf{I}_T \otimes \mathbf{U}') \begin{bmatrix} \mathbf{a} \\ \mathbf{b} \end{bmatrix} = \mathbf{0}_{(Tn_a \times 1)}, \quad (\mathbf{U}' \otimes \mathbf{I}_T) \begin{bmatrix} \mathbf{a}^* \\ \mathbf{b}^* \end{bmatrix} = \mathbf{0}_{(Tn_a \times 1)}. \quad (18)$$

In order to avoid mistakes, one should note that, while

$$\mathbf{y}^* = \text{vec}(\mathbf{Y}') = \begin{bmatrix} \text{vec}(\mathbf{A}') \\ \text{vec}(\mathbf{B}') \end{bmatrix} = \begin{bmatrix} \mathbf{a}^* \\ \mathbf{b}^* \end{bmatrix}, \quad (19)$$

it is in turn:

$$\mathbf{y} = \text{vec}(\mathbf{Y}) \neq \begin{bmatrix} \text{vec}(\mathbf{A}) \\ \text{vec}(\mathbf{B}) \end{bmatrix} = \begin{bmatrix} \mathbf{a} \\ \mathbf{b} \end{bmatrix}.$$

Therefore, in the following when a matrix vectorization is needed, we will generally prefer using vectorized version of matrices \mathbf{Y}' , \mathbf{A}' , and \mathbf{B}' , as in (19). In addition, to ease the notation, from now on the asterisk will be omitted, which means that, unlike we previously did, we denote with \mathbf{y} , \mathbf{a} , and \mathbf{b} the following vectors:

$$\mathbf{y} = \text{vec}(\mathbf{Y}'), \quad \mathbf{a} = \text{vec}(\mathbf{A}'), \quad \mathbf{b} = \text{vec}(\mathbf{B}').$$

4 Temporal hierarchies

Following Athanasopoulos et al. (2017), we consider a time series $\{x_t\}_{t=1}^T$ observed at the highest available sampling frequency per seasonal cycle, say m (e.g., month per year, $m = 12$, quarter per year, $m = 4$, hour per day, $m = 24$). Given a factor k of m ,⁴ we can construct a temporally aggregated version of the time series x_t , through the non-overlapping sums of its k successive values, which has seasonal period equal to $M_k = m/k$. To avoid ragged-edge data, we assume that the total number of observations of x_t involved in the non-overlapping aggregation is a multiple of m , i.e. $T = N \cdot m$, where N is the length of the most temporally aggregated version of the series, i.e. the series observed at the lowest available frequency.

We denote with $\mathcal{K} = \{k_m, k_{p-1}, \dots, k_2, k_1\}$ the set of the p factors of m , in descending order, where $k_p = m$ and $k_1 = 1$. The temporally aggregated series of

⁴If k is not a factor of m , then the seasonality of the aggregate series is non-integer, and so forecasts of the aggregate are more difficult to compute.

order k can be written as

$$x_l^{[k]} = \sum_{t=(l-1)k+1}^{lk} x_t, \quad l = 1, \dots, \frac{T}{k}, \quad k \in \mathcal{K}. \quad (20)$$

Expression (20) accounts also for the trivial temporal aggregation transforming x_t in itself (i.e., $x_t \equiv x_l^{[1]}$, $l = t$).

Since the observation index l in (20) varies with each aggregation level k , in order to express a common index for all levels, we define τ as the observation index of the most aggregated series, such that $l = \tau$ at that level, i.e.

$$x_\tau^{[m]}, \quad \tau = 1, \dots, N.$$

As for the other temporally aggregated series defined in expression (20), we stack the observations for each aggregation level below m in the $(M_k \times 1)$ column vectors

$$\mathbf{x}_\tau^{[k]} = \left[x_{M_k(\tau-1)+1}^{[k]} \ x_{M_k(\tau-1)+2}^{[k]} \ \dots \ x_{M_k\tau}^{[k]} \right]', \quad \tau = 1, \dots, N, \quad k \in \{k_{p-1}, \dots, k_2, 1\}. \quad (21)$$

We may collect $x_\tau^{[m]}$ and the $p-1$ vectors defined by expression (21) in a single column vector, by keeping distinct the temporally aggregated data from the high-frequency one:

$$\mathbf{x}_\tau = \left[x_\tau^{[m]} \ \mathbf{x}_\tau^{[k_{p-1}]} \ \dots \ \mathbf{x}_\tau^{[k_2]} \ \mathbf{x}_\tau^{[1]} \right]' = \left[\mathbf{t}_{x_\tau} \ \mathbf{x}_\tau^{[1]} \right]', \quad \tau = 1, \dots, N,$$

where $\mathbf{t}_{x_\tau} = \left[x_\tau^{[m]} \ \mathbf{x}_\tau^{[k_{p-1}]} \ \dots \ \mathbf{x}_\tau^{[k_2]} \right]'$ is a $(k^* \times 1)$ vector, with $k^* = \sum_{j=1}^{p-1} k_j$, con-

taining all the temporally aggregated series at the observation index τ , $\mathbf{x}_\tau^{[1]}$ is the $(m \times 1)$ vector of observations of the time series at the highest available frequency within the complete τ -th cycle, and thus each \mathbf{x}_τ has dimension $[(k^* + m) \times 1]$.

The relationships linking the original high-frequency series x_t and its temporal aggregates can be graphically represented as a hierarchical/grouped series. For example, for quarterly data $k \in \{4, 2, 1\}$, then every four quarterly observations are aggregated up to annual and semi-annual counterparts. According to the notation so far, for a single year the quarterly hierarchical structure can be defined as in Figure 3, where $x^{[4]}$, $x^{[2]}$ and $x^{[1]}$ denote annual, half-annual, and quarterly values, respectively. The relationships linking the nodes in the hierarchy can be expressed as we did in (7) for the cross-sectional (contemporaneous) hierarchy case:

$$\mathbf{t}_{x_\tau} = \mathbf{K}_1 \mathbf{x}_\tau^{[1]}, \quad \mathbf{x}_\tau = \mathbf{R}_1 \mathbf{x}_\tau^{[1]}, \quad \mathbf{Z}'_1 \mathbf{x}_\tau = \mathbf{0}_{(k^* \times 1)}, \quad \tau = 1, \dots, N, \quad (22)$$

where \mathbf{K}_1 is the $(k^* \times m)$ temporal aggregation matrix converting the high-frequency observations into lower-frequency (temporally aggregated) ones,

$$\mathbf{R}_1 = \begin{bmatrix} \mathbf{K}_1 \\ \mathbf{I}_m \end{bmatrix}$$

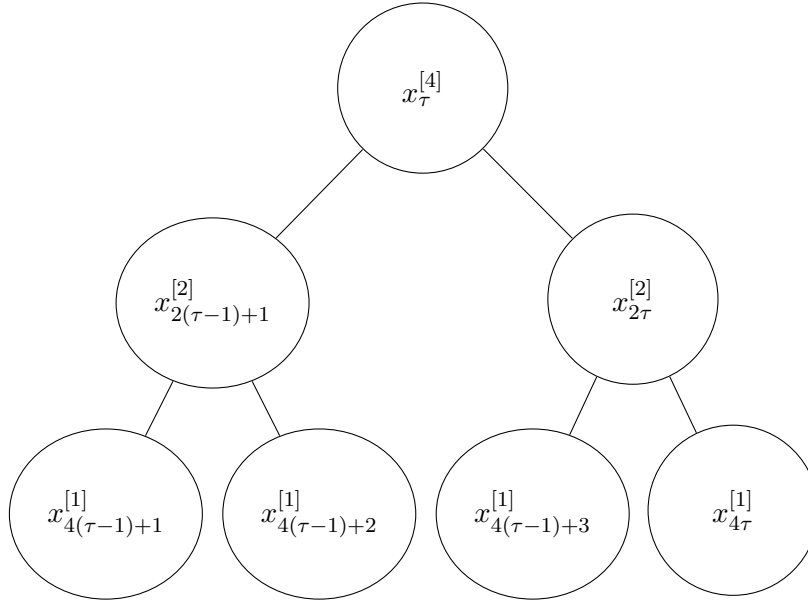

Figure 3: Temporal hierarchy for quarterly series using the common index τ for all levels of aggregation.

is the $[(k^* + m) \times m]$ *temporal summing* matrix, and $\mathbf{Z}'_1 = [\mathbf{I}_{k^*} - \mathbf{K}_1]$ is the zero constraints kernel matrix valid for \mathbf{x}_τ . For example, with quarterly data it is $m = 4$, $k^* = 3$, and

$$\mathbf{K}_1 = \begin{bmatrix} 1 & 1 & 1 & 1 \\ 1 & 1 & 0 & 0 \\ 0 & 0 & 1 & 1 \end{bmatrix}, \quad \mathbf{R}_1 = \begin{bmatrix} 1 & 1 & 1 & 1 \\ 1 & 1 & 0 & 0 \\ 0 & 0 & 1 & 1 \\ 1 & 0 & 0 & 0 \\ 0 & 1 & 0 & 0 \\ 0 & 0 & 1 & 0 \\ 0 & 0 & 0 & 1 \end{bmatrix}, \quad \mathbf{Z}'_1 = [\mathbf{I}_3 - \mathbf{K}_1].$$

The temporal aggregation relationships can be extended to the whole time span covered by series x_t . Denoting by $\mathbf{x} = (\mathbf{x}'_1 \dots \mathbf{x}'_\tau \dots \mathbf{x}'_N)'$ the $[N(k^* + m) \times 1]$ vector containing all the data of series X at any observed temporal frequency, the complete set of temporal aggregation constraints valid for this vector is given by

$$\mathbf{Z}'_N \mathbf{x} = \mathbf{0}_{(Nk^* \times 1)}, \quad (23)$$

where $\mathbf{Z}'_N = [\mathbf{I}_{Nk^*} - \mathbf{K}_N]$, and

$$\mathbf{K}_N = \begin{bmatrix} \mathbf{I}_N \otimes \mathbf{1}'_4 \\ \mathbf{I}_{2N} \otimes \mathbf{1}'_2 \end{bmatrix}.$$

It is not always possible to represent the temporal aggregates of one series in a single tree⁵ such as Fig. 3. In Appendix A.4 the representations valid for monthly and hourly hierarchies are shown.

⁵For any given positive $m > 1$, there is a single unique temporal hierarchy only if $m = q^\alpha$,

4.1 Alternative approximations of the covariance matrix for point forecast reconciliation through temporal hierarchies

Suppose we have the $[(k^* + m) \times 1]$ vector $\hat{\mathbf{x}}_h$ of unbiased base forecasts for the p temporal aggregates of a single time series Y within a complete time cycle, i.e. at the forecast horizon $h = 1$ for the lowest (most aggregated) time frequency. If the base forecasts have been independently computed, generally they do not fulfill the temporal aggregation constraints, i.e. $\mathbf{Z}'_1 \hat{\mathbf{x}}_h \neq \mathbf{0}_{k^* \times 1}$. By adapting the general point forecast reconciliation formula (3), and not considering suffix h to simplify the notation, the vector of temporally reconciled forecasts is given by:

$$\tilde{\mathbf{x}} = \hat{\mathbf{x}} - \mathbf{\Omega} \mathbf{Z}_1 (\mathbf{Z}'_1 \mathbf{\Omega} \mathbf{Z}_1)^{-1} \mathbf{Z}'_1 \hat{\mathbf{x}}, \quad (24)$$

where $\mathbf{\Omega}$ is a $[(k^* + m) \times (k^* + m)]$ p.d. matrix, assumed known.

In order to consider possible residual-based estimates of matrix $\mathbf{\Omega}$, denote

$$\hat{\mathbf{e}}_\tau^{[k]} = \mathbf{x}_\tau^{[k]} - \hat{\mathbf{x}}_\tau^{[k]}, \quad \tau = 1, \dots, N, \quad k \in \mathcal{K}, \quad (25)$$

the $(M_k \times 1)$ vectors of the in-sample residuals at time index τ for the models used to generate the base forecasts of the temporally aggregated series of order k . These vectors can be organized in matrix form as

$$\hat{\mathbf{E}}_x^{[k]} = \begin{bmatrix} (\hat{\mathbf{e}}_1^{[k]})' \\ \vdots \\ (\hat{\mathbf{e}}_\tau^{[k]})' \\ \vdots \\ (\hat{\mathbf{e}}_N^{[k]})' \end{bmatrix}, \quad k \in \mathcal{K}, \quad (26)$$

where each matrix $\hat{\mathbf{E}}_x^{[k]}$ has dimension $(N \times M_k)$, and then grouped in the $[N \times (k^* + m)]$ matrix of in-sample residuals

$$\hat{\mathbf{E}}_x = \left[\hat{\mathbf{E}}_x^{[m]} \quad \hat{\mathbf{E}}_x^{[k_{p-1}]} \quad \dots \quad \hat{\mathbf{E}}_x^{[k_2]} \quad \hat{\mathbf{E}}_x^{[1]} \right].$$

Each column of this matrix contains the in-sample residuals pertaining to a specific node of the temporal hierarchy, thus the sample cross-covariance matrix of the $k^* + m$ nodes of the temporal hierarchy is given by⁶:

$$\hat{\mathbf{\Omega}} = \frac{1}{N} (\hat{\mathbf{E}}_x)' \hat{\mathbf{E}}_x. \quad (27)$$

where α is a positive integer and q is a prime number (Yang et al., 2017). A corollary is that a single unique hierarchy is only possible when there are no coprime pairs in the set $\{k_{p-1}, \dots, k_3, k_2\}$ (Athanasopoulos et al., 2017).

⁶Expression (27) assumes that $N^{-1} \sum_{\tau=1}^N \hat{\mathbf{e}}_{\tau,l} = 0$, $l = 1, \dots, k^* + m$. When this does not hold, $\hat{\mathbf{\Omega}}$ is the sample Mean Square Error (MSE) matrix.

This matrix is well defined if $N > (k^* + m)$, otherwise there might be singularity issues which would prevent its use in expression (24) in place of matrix $\mathbf{\Omega}$.

Athanasopoulos et al. (2017) and Hyndman and Kourentzes (2018) consider the following alternative choices for $\mathbf{\Omega}$ (the suffix ‘t’ stands for ‘temporal’, to keep the ‘t’-procedures distinct from the ‘cs’-ones shown in section 3.1):

- identity (t-ols): $\mathbf{\Omega} = \mathbf{I}_{k^*+m}$,
- structural (t-struct): $\mathbf{\Omega} = \widehat{\mathbf{\Omega}}_{\text{t-struct}} = \text{diag}(\mathbf{R}_1 \mathbf{1}_m)$
- hierarchy variance scaling (t-wlsh): $\mathbf{\Omega} = \widehat{\mathbf{\Omega}}_{\text{t-wlsh}} = \mathbf{I}_{k^*+m} \odot \widehat{\mathbf{\Omega}}$
- series variance scaling (t-wlsv): $\mathbf{\Omega} = \widehat{\mathbf{\Omega}}_{\text{t-wlsv}}$
- MinT-shr (t-shr): $\mathbf{\Omega} = \widehat{\mathbf{\Omega}}_{\text{t-shr}} = \hat{\lambda} \widehat{\mathbf{\Omega}}_{\text{t-wlsh}} + (1 - \hat{\lambda}) \widehat{\mathbf{\Omega}}$
- MinT-sam (t-sam): $\mathbf{\Omega} = \widehat{\mathbf{\Omega}}$

The series variance scaling matrix $\widehat{\mathbf{\Omega}}_{\text{t-wlsv}}$ is a diagonal matrix “which contains estimates of the in-sample one-step-ahead error variances across each level” (Athanasopoulos et al. (2017, p. 64), that requires a reduced number (p instead of $k^* + m$) of variances to be estimated as compared to the hierarchy variance scaling matrix $\widehat{\mathbf{\Omega}}_{\text{t-wlsh}}$, with increased sample size available for the estimation.

“As the purpose of temporal aggregation is to exploit important information about time series at different frequencies”, Nystrup et al. (2020) propose other formulations in order to include potential information in the autocorrelation structure. The matrices considered in this paper⁷ are:

- auto-covariance scaling (t-acov): $\mathbf{\Omega} = \widehat{\mathbf{\Omega}}_{\text{t-acov}}$
- structural Markov (t-strar1): $\mathbf{\Omega} = \widehat{\mathbf{\Omega}}_{\text{t-strar1}}$
- series Markov (t-sar1): $\mathbf{\Omega} = \widehat{\mathbf{\Omega}}_{\text{t-sar1}}$
- hierarchy Markov (t-har1): $\mathbf{\Omega} = \widehat{\mathbf{\Omega}}_{\text{t-har1}}$

The auto-covariance scaling makes use of the estimates of the full autocovariance matrices within each aggregation level, while ignoring correlations between aggregation levels:

$$\widehat{\mathbf{\Omega}}_{\text{t-acov}} = \begin{bmatrix} \widehat{\mathbf{\Omega}}^{[m]} & \mathbf{0} & \cdots & \mathbf{0} & \mathbf{0} \\ \mathbf{0} & \widehat{\mathbf{\Omega}}^{[k_{p-1}]} & \cdots & \mathbf{0} & \mathbf{0} \\ \vdots & \vdots & \ddots & \vdots & \vdots \\ \mathbf{0} & \mathbf{0} & \cdots & \widehat{\mathbf{\Omega}}^{[k_2]} & \mathbf{0} \\ \mathbf{0} & \mathbf{0} & \cdots & \mathbf{0} & \widehat{\mathbf{\Omega}}^{[1]} \end{bmatrix},$$

⁷For the time being, we do not consider all the newly proposed covariance matrices. The interested reader may refer to Nystrup et al. (2020).

where the $(M_k \times M_k)$ matrices $\widehat{\boldsymbol{\Omega}}^{[k]}$ are given by⁸:

$$\widehat{\boldsymbol{\Omega}}^{[k]} = \frac{1}{N} \sum_{\tau=1}^N \widehat{\mathbf{e}}_{\tau}^{[k]} (\widehat{\mathbf{e}}_{\tau}^{[k]})' = \frac{1}{N} \left(\widehat{\mathbf{E}}^{[k]} \right)' \widehat{\mathbf{E}}^{[k]}, \quad k \in \mathcal{K}, \quad (28)$$

where vector $\widehat{\mathbf{e}}_{\tau}^{[k]}$ and matrix $\widehat{\mathbf{E}}_x^{[k]}$ are given by (25) and (26), respectively. A necessary condition in order to matrix $\widehat{\boldsymbol{\Omega}}_{\text{t-acov}}$ be invertible, is $N > m$, which is less demanding than what is needed for the non-singularity of matrix $\widehat{\boldsymbol{\Omega}}$.

Because it is sometimes difficult to estimate the covariance matrix within each aggregation level without assuming that it has some special form, Nystrup et al. (2020) propose “an estimator that blends autocorrelation and variance information, but only requires estimation of the first order autocorrelation coefficient at each aggregation level”. They consider the Toeplitz matrix for the estimated first-order autocorrelation coefficients of the in-sample residuals for the $p-1$ levels $k = k_1, \dots, k_{p-1}$, of the series’ temporal hierarchy. Denoting these autocorrelation coefficients with $\rho_{[k]}$, it is:

$$\boldsymbol{\Gamma}^{[m]} = 1, \quad \boldsymbol{\Gamma}^{[k]} = \begin{bmatrix} 1 & \rho_{[k]} & \cdots & \rho_{[k]}^{M_k-1} \\ \rho_{[k]} & 1 & \cdots & \rho_{[k]}^{M_k-2} \\ \vdots & \vdots & \ddots & \vdots \\ \rho_{[k]}^{M_k-1} & \rho_{[k]}^{M_k-2} & \cdots & 1 \end{bmatrix}, \quad k = k_1, \dots, k_{p-1},$$

where each matrix $\boldsymbol{\Gamma}^{[k]}$, $k \in \mathcal{K}$, has dimension $(M_k \times M_k)$. The p matrices are used to build the $[(k^* + m) \times (k^* + m)]$ matrix:

$$\boldsymbol{\Gamma} = \begin{bmatrix} 1 & \mathbf{0}' & \cdots & \mathbf{0}' \\ \mathbf{0} & \boldsymbol{\Gamma}^{[k_{p-1}]} & \cdots & \mathbf{0} \\ \vdots & \vdots & \ddots & \vdots \\ \mathbf{0} & \mathbf{0} & \cdots & \boldsymbol{\Gamma}^{[1]} \end{bmatrix},$$

which can be used in three alternative estimates of matrix $\boldsymbol{\Omega}$:

$$\begin{aligned} \widehat{\boldsymbol{\Omega}}_{\text{t-strar1}} &= \widehat{\boldsymbol{\Omega}}_{\text{t-struct}}^{\frac{1}{2}} \boldsymbol{\Gamma} \widehat{\boldsymbol{\Omega}}_{\text{t-struct}}^{\frac{1}{2}} \\ \widehat{\boldsymbol{\Omega}}_{\text{t-sar1}} &= \widehat{\boldsymbol{\Omega}}_{\text{t-wlsv}}^{\frac{1}{2}} \boldsymbol{\Gamma} \widehat{\boldsymbol{\Omega}}_{\text{t-wlsv}}^{\frac{1}{2}} \\ \widehat{\boldsymbol{\Omega}}_{\text{t-har1}} &= \widehat{\boldsymbol{\Omega}}_{\text{t-wlsh}}^{\frac{1}{2}} \boldsymbol{\Gamma} \widehat{\boldsymbol{\Omega}}_{\text{t-wlsh}}^{\frac{1}{2}} \end{aligned}$$

5 The cross-temporal forecast reconciliation framework

5.1 Cross-temporal aggregation constraints

The cross sectional aggregation relationships (18), linking n series at a single time period, and the temporal aggregation relationships (22), valid for an individual

⁸Matrix $\widehat{\boldsymbol{\Omega}}^{[m]}$ reduces to a scalar variance.

variable, can be simultaneously considered, by extending (i) the cross-sectional constraints to all observation frequencies, and (ii) the temporal aggregation relationships to all variables.

Considering contemporaneous and temporal dimensions in the same framework requires to extend and adapt the notations used so far. At this end, define the p matrices $\mathbf{Y}^{[k]}$, each of dimension $(n \times NM_k)$, as

$$\mathbf{Y}^{[k]} = \begin{bmatrix} \mathbf{A}^{[k]} \\ \mathbf{B}^{[k]} \end{bmatrix}, \quad k \in \mathcal{K},$$

where

$$\mathbf{B}^{[k]} = \begin{bmatrix} \mathbf{b}_1^{[k]'} \\ \vdots \\ \mathbf{b}_i^{[k]'} \\ \vdots \\ \mathbf{b}_{n_b}^{[k]'} \end{bmatrix}, \quad \mathbf{A}^{[k]} = \begin{bmatrix} \mathbf{a}_1^{[k]'} \\ \vdots \\ \mathbf{a}_j^{[k]'} \\ \vdots \\ \mathbf{a}_{n_a}^{[k]'} \end{bmatrix}, \quad k \in \mathcal{K},$$

are the matrices containing the k -order temporal aggregates of the bts ($\mathbf{B}^{[k]}$) and uts ($\mathbf{A}^{[k]}$), of dimension $(n_b \times NM_k)$ and $(n_a \times NM_k)$, respectively.

In order to be consistent with the notation so far, $\mathbf{Y}^{[1]}$, $\mathbf{B}^{[1]}$, and $\mathbf{A}^{[1]}$ denote the matrices containing data at the highest available sampling frequency, while \mathbf{Y} , \mathbf{B} , and \mathbf{A} are used now to denote the matrices containing the data at any considered temporal frequency, that is:

$$\mathbf{Y} = \begin{bmatrix} \mathbf{A} \\ \mathbf{B} \end{bmatrix} = \begin{bmatrix} \mathbf{A}^{[m]} & \mathbf{A}^{[k_{p-1}]} & \dots & \mathbf{A}^{[k_2]} & \mathbf{A}^{[1]} \\ \mathbf{B}^{[m]} & \mathbf{B}^{[k_{p-1}]} & \dots & \mathbf{B}^{[k_2]} & \mathbf{B}^{[1]} \end{bmatrix},$$

where \mathbf{Y} , \mathbf{A} , and \mathbf{B} have n , n_a and n_b rows, respectively, and the same number of columns, $[N(k^* + m)]$.

Cross-sectional aggregation constraints

The cross-sectional aggregation relationships operating along all the time observation indices can be worked out by extending the latter equation in expression (18):

$$\mathbf{U}'\mathbf{Y}^{[k]} = \mathbf{0}_{(n_a \times NM_k)}, \quad k \in \mathcal{K},$$

which can be expressed in compact form as

$$\mathbf{U}'\mathbf{Y} = \mathbf{0}_{[n_a \times N(k^* + m)]}. \quad (29)$$

If we define \mathbf{y} as the $(nN(k^* + m) \times 1)$ vector containing all the observations of all series at any temporal aggregation level, organized ‘by-variable-first-then-by-descending-aggregation-order’, that is $\mathbf{y} = \text{vec}(\mathbf{Y}')$, the cross-sectional (contemporaneous) constraints (29) can be equivalently expressed as:

$$(\mathbf{U}' \otimes \mathbf{I}_{N(k^* + m)})\mathbf{y} = \mathbf{0}_{[n_a N(k^* + m) \times 1]}. \quad (30)$$

Temporal aggregation constraints

The temporal aggregation relationships (22), valid for a single series, can be extended to each component of the n -variate time series \mathbf{y}_t as follows:

$$\begin{bmatrix} \mathbf{A}^{[m]'} & \mathbf{B}^{[m]'} \\ \vdots & \vdots \\ \mathbf{A}^{[k_2]'} & \mathbf{B}^{[k_2]'} \end{bmatrix} = \mathbf{K}_N \begin{bmatrix} \mathbf{A}^{[1]'} & \mathbf{B}^{[1]'} \end{bmatrix}, \quad (31)$$

which can be equivalently written as $[\mathbf{I}_{Nk^*} \quad -\mathbf{K}_N] \mathbf{Y}' = \mathbf{0}_{(Nk^* \times n)}$, that is:

$$\mathbf{Z}'_N \mathbf{Y}' = \mathbf{0}_{(Nk^* \times n)}. \quad (32)$$

The temporal aggregation constraints (32) can thus be re-stated as:

$$(\mathbf{I}_n \otimes \mathbf{Z}'_N) \mathbf{y} = \mathbf{0}_{(nNk^* \times 1)}, \quad (33)$$

which, for $n = 1$, is equivalent to expression (23).

In summary, by considering expressions (30) and (33) together, the cross-temporal constraints working on the complete set of observations can be expressed as:

$$\check{\mathbf{H}}' \mathbf{y} = \mathbf{0}_{(n^* \times 1)}, \quad (34)$$

where $n^* = n_a N(k^* + m) + nNk^*$, and

$$\check{\mathbf{H}}' = \begin{bmatrix} \mathbf{U}' \otimes \mathbf{I}_{N(k^*+m)} \\ \mathbf{I}_n \otimes \mathbf{Z}'_N \end{bmatrix}$$

is a $[n^* \times nN(k^* + m)]$ cross-temporal zero-constraints kernel matrix.

Due to the simultaneous consideration of temporal and cross-sectional relationships linking the various time series of the system, some rows of $\check{\mathbf{H}}'$ are redundant, and can be eliminated if one wishes a full row-rank zero-constraints kernel matrix. This issue is not new, since it has been encountered in the past when contemporaneous and temporal aggregation constraints are simultaneously considered for the reconciliation of a system of time series (Di Fonzo, 1990, Di Fonzo and Marini, 2011).

In detail, matrix $\check{\mathbf{H}}'$ consists in:

- $Nn_a k^*$ rows defining the cross-sectional (contemporaneous) aggregation constraints operating on the lf-uts;
- $Nn_a m$ rows defining the cross-sectional (contemporaneous) aggregation constraints operating on the hf-bts;
- $Nn_a (k^* + m)$ rows defining the temporal aggregation constraints operating on both hf- and lf-uts;
- $Nn_b (k^* + m)$ rows defining the temporal aggregation constraints operating on both hf- and lf-bts.

Since the first set of Nn_ak^* constraints is linearly dependent from the other rows of matrix $\check{\mathbf{H}}'$, a full row-rank cross-temporal zero constraints kernel matrix \mathbf{H}' can be obtained by:

1. considering the $[(Nn(k^* + m) \times (Nn(k^* + m))]$ commutation matrix (Magnus and Neudecker, 2019, p. 54; see Appendix A.3.1) \mathbf{P} such that $\mathbf{P} [\text{vec}(\mathbf{Y})] = \text{vec}(\mathbf{Y}')$;
2. defining a matrix \mathbf{U}^* as:

$$\mathbf{U}^* = [\mathbf{0}_{(Nn_am \times Nnk^*)} \quad \mathbf{I}_{Nm} \otimes \mathbf{U}'] \mathbf{P}';$$

3. considering the $[N(n_am + nk^*) \times Nn(k^* + m)]$ matrix:

$$\mathbf{H}' = \begin{bmatrix} \mathbf{U}^* \\ \mathbf{I}_n \otimes \mathbf{Z}'_N \end{bmatrix}, \quad (35)$$

which has full row-rank equal to $N(n_am + nk^*) = n^* - Nn_ak^*$, and allows to re-state the complete cross-temporal constraints (34) as:

$$\mathbf{H}'\mathbf{y} = \mathbf{0}. \quad (36)$$

Cross-temporal structural representation

The cross-temporal structural representation can be seen as a generalization from a single time index t to a single cycle index τ (i.e., the low-frequency time index) of the cross-sectional structural representation (see section 3), extended to cover $n(k^* + m)$ nodes instead of n .

Denote with \mathbf{Y}_τ the $[(n \times (k^* + m))]$ data matrix available at cycle τ :

$$\mathbf{Y}_\tau = \begin{bmatrix} \mathbf{A}_\tau \\ \mathbf{B}_\tau \end{bmatrix} = \begin{bmatrix} \mathbf{A}_\tau^{[m]} & \mathbf{A}_\tau^{[k_{p-1}]} & \dots & \mathbf{A}_\tau^{[k_2]} & \mathbf{A}_\tau^{[1]} \\ \mathbf{B}_\tau^{[m]} & \mathbf{B}_\tau^{[k_{p-1}]} & \dots & \mathbf{B}_\tau^{[k_2]} & \mathbf{B}_\tau^{[1]} \end{bmatrix}, \quad \tau = 1, \dots, N,$$

and let $\check{\mathbf{S}}$ the $(n^* \times n_b m)$ be the cross-temporal summation matrix

$$\check{\mathbf{S}} = \begin{bmatrix} \check{\mathbf{C}} \\ \mathbf{I}_{n_b m} \end{bmatrix},$$

where $\check{\mathbf{C}}$ denotes a $(n_a^* \times n_b m)$ cross-temporal aggregation matrix mapping the hf-bts into the uts and lf-bts ones ($n_a^* = n_a(k^* + m) + n_b k^*$). Denote with

$$\mathbf{a}_\tau^* = \begin{bmatrix} \text{vec}(\mathbf{A}'_\tau) \\ \text{vec}(\mathbf{B}'_\tau) \end{bmatrix}, \quad \tau = 1, \dots, N,$$

the $(n_a^* \times 1)$ vector of ‘cross-temporal upper series’, containing the uts and lf-bts data at the low-frequency time index τ , where $\mathbf{B}_\tau^* = [\mathbf{B}_\tau^{[m]} \quad \mathbf{B}_\tau^{[k_{p-1}]} \quad \dots \quad \mathbf{B}_\tau^{[k_2]}]$, $\tau = 1, \dots, N$, and with

$$\mathbf{b}_\tau^{[1]} = \text{vec}(\mathbf{B}_\tau^{[1]'}), \quad \tau = 1, \dots, N,$$

the $(n_b m \times 1)$ vector of ‘cross-temporal bottom series’, containing the hf-bts data. The structural representation of a cross-temporal system of n time series takes the form

$$\tilde{\mathbf{y}}_\tau = \check{\mathbf{S}}\mathbf{b}_\tau^{[1]}, \quad \tau = 1, \dots, N, \quad (37)$$

where $\tilde{\mathbf{y}}_\tau$ is a $[n(k^* + m) \times 1]$ vector where we place all the uts and the lf-bts at the top, and all the hf-bts at the bottom:

$$\tilde{\mathbf{y}}_\tau = \begin{bmatrix} \mathbf{a}_\tau^* \\ \mathbf{b}_\tau^{[1]} \end{bmatrix}, \quad \tau = 1, \dots, N. \quad (38)$$

5.2 Cross-temporal point forecast reconciliation: introduction

Let us assume to have unbiased base forecasts for all the individual time series of the multivariate hierarchical/grouped time series, and for all levels of the temporal hierarchies built from the highest available sampling frequency. In addition, assume that the forecast horizon for the most temporally aggregated time series be $h = 1$,⁹ and that the forecast horizons for the other temporally aggregated series cover the entire time cycle. This means that (i) the forecast horizon for the highest frequency time series is equal to m , and (ii) in general, the forecast horizon for a temporally aggregated time series of order k spans from 1 to M_k .

The base forecasts for each bottom time series of the system form the vectors

$$\hat{\mathbf{b}}_i^{[k]}, \quad i = 1, \dots, n_b, \quad k \in \mathcal{H},$$

where $\hat{\mathbf{b}}_i^{[1]} = \{\hat{b}_{il}^{[1]}\}_{l=1}^m$ is the $(m \times 1)$ vector containing the base forecasts for the i -th high-frequency bottom time series (hf-bts), which are the ‘very’ bottom time series in the cross-temporal framework, while the remaining $\hat{\mathbf{b}}_i^{[k]}$ ’s (for $k \neq 1$) contain the M_k forecasts for the lower-frequency ones (lf-bts).

The base forecasts for the upper time series can be defined likewise as

$$\hat{\mathbf{a}}_j^{[k]}, \quad j = 1, \dots, n_a, \quad k \in \mathcal{H},$$

where $\hat{\mathbf{a}}_j^{[1]} = \{\hat{a}_{jl}^{[1]}\}_{l=1}^m$ is the $(m \times 1)$ vector containing the base forecasts for the high-frequency j -th upper time series (hf-uts), and the $\hat{\mathbf{a}}_j^{[k]}$ ’s (for $k \neq 1$) are $(M_k \times 1)$ vectors of low-frequency upper time series (lf-uts) forecasts.

Let us collect these base forecasts in the $(n_b \times M_k)$ and $(n_a \times M_k)$, respectively, matrices

$$\hat{\mathbf{B}}^{[k]} = \begin{bmatrix} \hat{\mathbf{b}}_1^{[k]} \\ \vdots \\ \hat{\mathbf{b}}_i^{[k]} \\ \vdots \\ \hat{\mathbf{b}}_{n_b}^{[k]} \end{bmatrix}, \quad \hat{\mathbf{A}}^{[k]} = \begin{bmatrix} \hat{\mathbf{a}}_1^{[k]} \\ \vdots \\ \hat{\mathbf{a}}_j^{[k]} \\ \vdots \\ \hat{\mathbf{a}}_{n_a}^{[k]} \end{bmatrix}, \quad k \in \mathcal{H}. \quad (39)$$

⁹The general case $h \geq 1$ can be dealt with in a straightforward way.

The matrix containing the base bts forecasts is given by:

$$\widehat{\mathbf{B}} = \left[\widehat{\mathbf{B}}^{[m]} \widehat{\mathbf{B}}^{[k_{p-1}]} \dots \widehat{\mathbf{B}}^{[k_2]} \widehat{\mathbf{B}}^{[1]} \right],$$

where $\widehat{\mathbf{B}}$ has dimension $[n_b \times (k^* + m)]$. The base uts forecasts can be similarly arranged in the $[n_a \times (k^* + m)]$ matrix

$$\widehat{\mathbf{A}} = \left[\widehat{\mathbf{A}}^{[m]} \widehat{\mathbf{A}}^{[k_{p-1}]} \dots \widehat{\mathbf{A}}^{[k_2]} \widehat{\mathbf{A}}^{[1]} \right].$$

From expression (39) we can define the p matrices $\widehat{\mathbf{Y}}^{[k]}$, each of dimension $(n \times M_k)$, with $n = n_a + n_b$, containing the base forecasts for the temporal aggregation level k of both uts and bts:

$$\widehat{\mathbf{Y}}^{[k]} = \begin{bmatrix} \widehat{\mathbf{A}}^{[k]} \\ \widehat{\mathbf{B}}^{[k]} \end{bmatrix}, \quad k \in \mathcal{K}.$$

Finally, denoting with $\widehat{\mathbf{Y}}$ the $[n \times (k^* + m)]$ matrix containing the base forecasts of all series and for all temporal aggregation levels, it is:

$$\widehat{\mathbf{Y}} = \left[\widehat{\mathbf{Y}}^{[m]} \widehat{\mathbf{Y}}^{[k_{p-1}]} \dots \widehat{\mathbf{Y}}^{[k_2]} \widehat{\mathbf{Y}}^{[1]} \right] = \begin{bmatrix} \widehat{\mathbf{A}} \\ \widehat{\mathbf{B}} \end{bmatrix}.$$

In general, the base forecasts fulfill neither cross-sectional (contemporaneous) nor temporal aggregation constraints. That is, respectively:

$$\mathbf{U}'\widehat{\mathbf{Y}} \neq \mathbf{0}_{[n_a \times (k^* + m)]}, \quad \mathbf{Z}'_1\widehat{\mathbf{Y}}' \neq \mathbf{0}_{(k^* \times n)}.$$

The cross-temporal point forecast reconciliation problem can thus be stated as follows: we are looking for a reconciled point forecast matrix, say $\widetilde{\mathbf{Y}}$, which is ‘as-close-as-possible’ (according to a pre-specified metric) to the base forecast matrix $\widehat{\mathbf{Y}}$, and simultaneously in line with the cross-sectional and temporal aggregation constraints, that is:

$$\mathbf{U}'\widetilde{\mathbf{Y}} = \mathbf{0}_{n_a \times (k^* + m)}, \quad \mathbf{Z}'_1\widetilde{\mathbf{Y}}' = \mathbf{0}_{(k^* \times n)}. \quad (40)$$

As we have previously shown, the relationships (40) can be expressed in vectorized form as $\mathbf{H}'\tilde{\mathbf{y}} = \mathbf{0}$, where $\tilde{\mathbf{y}} = \text{vec}(\widetilde{\mathbf{Y}}')$ and, since $h = 1$, the full row-rank matrix \mathbf{H}' in (35) becomes

$$\mathbf{H}' = \begin{bmatrix} \mathbf{U}^* \\ \mathbf{I}_n \otimes \mathbf{Z}'_1 \end{bmatrix}. \quad (41)$$

5.3 Bottom-up cross-temporal forecast reconciliation

Cross temporal reconciled forecasts for all series at any temporal aggregation level can be easily computed by appropriate summation of the hf-bts base forecasts $\widehat{\mathbf{b}}_i^{[1]}$, $i = 1, \dots, n_b$, according to a bottom-up procedure like what is currently done in both the cross-sectional and temporal frameworks.

Denoting by $\ddot{\mathbf{Y}}$ the $[n \times (k^* + m)]$ matrix containing the bottom-up cross temporal reconciled forecasts, it is:

$$\ddot{\mathbf{Y}} = \begin{bmatrix} \ddot{\mathbf{A}} \\ \ddot{\mathbf{B}} \end{bmatrix} = \begin{bmatrix} \ddot{\mathbf{A}}^{[m]} & \ddot{\mathbf{A}}^{[k_{p-1}]} & \dots & \ddot{\mathbf{A}}^{[k_2]} & \ddot{\mathbf{A}}^{[1]} \\ \ddot{\mathbf{B}}^{[m]} & \ddot{\mathbf{B}}^{[k_{p-1}]} & \dots & \ddot{\mathbf{B}}^{[k_2]} & \ddot{\mathbf{B}}^{[1]} \end{bmatrix}.$$

Since the hf-bts reconciled forecasts are by definition equal to the hf-bts base forecasts, i.e. $\ddot{\mathbf{B}}^{[1]} = \widehat{\mathbf{B}}^{[1]}$, the bottom-up forecast reconciliation procedure consists of the following steps:

1. compute the hf-uts reconciled forecasts using the cross-sectional aggregation relationship (15):

$$\ddot{\mathbf{A}}^{[1]} = \mathbf{C}\widehat{\mathbf{B}}^{[1]};$$

2. compute the lf-bts reconciled forecasts according to the temporal aggregation relationship (31):

$$\begin{bmatrix} \left(\ddot{\mathbf{B}}^{[m]}\right)' \\ \vdots \\ \left(\ddot{\mathbf{B}}^{[k_2]}\right)' \end{bmatrix} = \mathbf{K}_1 \left(\widehat{\mathbf{B}}^{[1]}\right)' \Rightarrow \begin{bmatrix} \ddot{\mathbf{B}}^{[m]} & \ddot{\mathbf{B}}^{[k_{p-1}]} & \dots & \ddot{\mathbf{B}}^{[k_2]} \end{bmatrix} = \widehat{\mathbf{B}}^{[1]} \mathbf{K}'_1;$$

3. compute the lf-uts reconciled forecasts by cross-sectional aggregation of the lf-bts reconciled forecasts obtained in the previous step:

$$\ddot{\mathbf{A}}^{[k]} = \mathbf{C}\ddot{\mathbf{B}}^{[k]}, \quad k \in \mathcal{K} \Rightarrow \begin{bmatrix} \ddot{\mathbf{A}}^{[m]} & \ddot{\mathbf{A}}^{[k_{p-1}]} & \dots & \ddot{\mathbf{A}}^{[k_2]} \end{bmatrix} = \mathbf{C}\widehat{\mathbf{B}}^{[1]} \mathbf{K}'_1.$$

In summary, the matrix containing the bottom-up reconciled forecasts, solely depending on the hf-bts base forecasts, is given by:

$$\ddot{\mathbf{Y}} = \begin{bmatrix} \mathbf{C}\widehat{\mathbf{B}}^{[1]} \mathbf{K}'_1 & \mathbf{C}\widehat{\mathbf{B}}^{[1]} \\ \widehat{\mathbf{B}}^{[1]} \mathbf{K}'_1 & \widehat{\mathbf{B}}^{[1]} \end{bmatrix}. \quad (42)$$

An equivalent, succinct alternative to expression (42) consists in exploiting the cross-temporal structural representation (37):

$$\ddot{\mathbf{y}} = \check{\mathbf{S}}\widehat{\mathbf{b}}^{[1]}, \quad (43)$$

where $\widehat{\mathbf{b}}^{[1]} = \text{vec}\left(\widehat{\mathbf{B}}^{[1]}\right)'$, keeping in mind that the elements in $\check{\mathbf{y}}$ and in \mathbf{y} are differently organized, and in general it is $\check{\mathbf{y}} \neq \mathbf{y}$, with $\mathbf{y} = \text{vec}\left(\ddot{\mathbf{Y}}'\right)$. This last issue can be easily dealt with by considering the $(n^* \times n^*)$ permutation matrix such that $\mathbf{y} = \mathbf{Q}\check{\mathbf{y}}$ (see Appendix A.3.2): given the orthogonality of matrix \mathbf{Q} , expression (43) can be re-stated as $\check{\mathbf{y}} = \mathbf{Q}'\check{\mathbf{S}}\widehat{\mathbf{b}}^{[1]}$. However, the formulation of matrix $\check{\mathbf{S}}$, which requires to manage linear relationships across cross-sectional and temporal dimensions, may be tedious and prone to errors, mostly for large collections of time series. In such cases, it might be preferable using formulation (42), where $\widehat{\mathbf{B}}^{[1]}$, \mathbf{C} and \mathbf{K}_1 are involved in simple matrix products.

Appendix A.5 describes all these features with reference to a ‘toy example’ of a very simple two-level hierarchy with two quarterly bottom time series.

6 Cross-temporal optimal forecast combination

Let us consider the multivariate regression model

$$\widehat{\mathbf{Y}} = \mathbf{Y} + \mathbf{E}, \quad (44)$$

where the involved matrices have each dimension $[n \times (k^* + m)]$ and contain, respectively, the base ($\widehat{\mathbf{Y}}$) and the target forecasts (\mathbf{Y}), and the coherency errors (\mathbf{E}) for the n component variables of the linearly constrained time series of interest. For each variable, $k^* + m$ base forecasts are available, pertaining to all aggregation levels of the temporal hierarchy for a complete cycle of high-frequency observation, m .

Consider now two vectorized versions of model (44), by transforming the matrices either in original form:

$$\text{vec}(\widehat{\mathbf{Y}}) = \text{vec}(\mathbf{Y}) + \text{vec}(\mathbf{E}) \quad \Leftrightarrow \quad \widehat{\mathcal{Y}} = \mathcal{Y} + \varepsilon, \quad (45)$$

or in transposed form:

$$\text{vec}(\widehat{\mathbf{Y}}') = \text{vec}(\mathbf{Y}') + \text{vec}(\mathbf{E}') \quad \Leftrightarrow \quad \widehat{\mathbf{y}} = \mathbf{y} + \eta. \quad (46)$$

The target forecasts must fulfill the cross-sectional (contemporaneous) constraints

$$\mathbf{U}'\mathbf{Y} = \mathbf{0}_{[n_a \times (k^* + m)]}$$

and the temporal aggregation constraints

$$\mathbf{Z}'_1\mathbf{Y}' = \mathbf{0}_{(k^* \times n)},$$

that is, in vectorized form:

$$(\mathbf{I}_{k^* + m} \otimes \mathbf{U}')\mathcal{Y} = \mathbf{0}_{[n_a(k^* + m) \times 1]} \quad \Leftrightarrow \quad (\mathbf{U}' \otimes \mathbf{I}_{k^* + m})\mathbf{y} = \mathbf{0}_{[n_a(k^* + m) \times 1]} \quad (47)$$

$$(\mathbf{Z}'_1 \otimes \mathbf{I}_n)\mathcal{Y} = \mathbf{0}_{(k^* n \times 1)} \quad \Leftrightarrow \quad (\mathbf{I}_n \otimes \mathbf{Z}'_1)\mathbf{y} = \mathbf{0}_{(k^* n \times 1)} \quad (48)$$

Denote with \mathbf{P} the $[n(k^* + m) \times n(k^* + m)]$ commutation matrix such that

$$\mathbf{P}\text{vec}(\mathbf{Y}) = \text{vec}(\mathbf{Y}') \quad \Leftrightarrow \quad \mathbf{P}\mathcal{Y} = \mathbf{y}$$

$$\mathbf{P}\text{vec}(\widehat{\mathbf{Y}}) = \text{vec}(\widehat{\mathbf{Y}}') \quad \Leftrightarrow \quad \mathbf{P}\widehat{\mathcal{Y}} = \widehat{\mathbf{y}}$$

$$\mathbf{P}\text{vec}(\mathbf{E}) = \text{vec}(\mathbf{E}') \quad \Leftrightarrow \quad \mathbf{P}\varepsilon = \eta$$

As a consequence, using the full row-rank matrix \mathbf{H}' defined by expression (41), the constraints (47) and (48) can be re-stated as:

$$\mathbf{H}'\mathbf{y} = \mathbf{0} \quad \Leftrightarrow \quad \mathbf{H}'\mathbf{P}\mathcal{Y} = \mathbf{0}.$$

Let $\mathbf{W} = E[\varepsilon\varepsilon']$ be the covariance matrix of vector ε , and $\mathbf{\Omega} = E[\eta\eta']$ the covariance matrix of vector η . Clearly, \mathbf{W} and $\mathbf{\Omega}$ are different parameterizations of the same

statistical object, i.e. the covariance matrix of the random disturbances in the multivariate regression model (44), for which the following relationships hold:

$$\mathbf{\Omega} = \mathbf{P}\mathbf{W}\mathbf{P}', \quad \mathbf{W} = \mathbf{P}'\mathbf{\Omega}\mathbf{P}.$$

In order to apply the general point forecast reconciliation formula (3) to a cross-temporal forecast reconciliation problem, we may consider either the expression

$$\tilde{\mathbf{y}} = \hat{\mathbf{y}} - \mathbf{\Omega}\mathbf{H}(\mathbf{H}'\mathbf{\Omega}\mathbf{H})^{-1}\mathbf{H}'\hat{\mathbf{y}},$$

where $\hat{\mathbf{y}} = \text{vec}(\widehat{\mathbf{Y}}')$ is the row vectorization of the base forecasts matrix $\widehat{\mathbf{Y}}$, or equivalently re-state the expression above as:

$$\widetilde{\mathcal{Y}} = \widehat{\mathcal{Y}} - \mathbf{W}\mathbf{P}'\mathbf{H}(\mathbf{H}'\mathbf{P}\mathbf{W}\mathbf{P}'\mathbf{H})^{-1}\mathbf{H}'\mathbf{P}\widehat{\mathcal{Y}},$$

by considering the column vectorization as in (45).

6.1 Simple alternative approximations of the covariance matrix for cross-temporal point forecast reconciliation

Consider the column vectorized form of the multivariate regression (45), whose random disturbances can be written as:

$$\boldsymbol{\varepsilon} = \begin{bmatrix} \varepsilon_1^{[m]} \\ \varepsilon_1^{[k_{p-1}]} \\ \vdots \\ \varepsilon_{\frac{m}{k_{p-1}}}^{[k_{p-1}]} \\ \vdots \\ \varepsilon_1^{[1]} \\ \vdots \\ \varepsilon_m^{[1]} \end{bmatrix},$$

where each $(n \times 1)$ vector $\varepsilon_l^{[k]}$, $k \in \mathcal{K}$, $l = 1, \dots, M_k$, contains contemporaneous random disturbances, i.e. at the same observation index of any temporal aggregation order.

A simple, though rather unrealistic, generalization to the cross-temporal framework of the cross-sectional approach (see section 3.1) consists in assuming that only the disturbances at the same time index of the same temporal aggregation level are correlated, whereas no temporal dependence (either within the same series at different times, or between the n series) is admitted:

$$E \left[\varepsilon_r^{[k_i]} \left(\varepsilon_s^{[k_j]} \right)' \right] = \begin{cases} \mathbf{W}_l^{[k]} & \text{if } k_i = k_j = k, r = s = l \quad k \in \mathcal{K}, \\ \mathbf{0} & \text{otherwise} \end{cases}, \quad l = 1, \dots, M_k.$$

In this case, the covariance matrix \mathbf{W} has the following block-diagonal structure:

$$\mathbf{W} = \begin{bmatrix} \mathbf{W}_1^{[m]} & \mathbf{0} & \cdots & \mathbf{0} & \cdots & \mathbf{0} & \cdots & \mathbf{0} \\ \mathbf{0} & \mathbf{W}_1^{[k_{p-1}]} & \cdots & \mathbf{0} & \cdots & \mathbf{0} & \cdots & \mathbf{0} \\ \vdots & \vdots & \ddots & \vdots & \ddots & \vdots & \ddots & \vdots \\ \mathbf{0} & \mathbf{0} & \cdots & \mathbf{W}_{\frac{m}{k_{p-1}}}^{[k_{p-1}]} & \cdots & \mathbf{0} & \cdots & \mathbf{0} \\ \vdots & \vdots & \ddots & \vdots & \ddots & \vdots & \ddots & \vdots \\ \mathbf{0} & \cdots & \cdots & \mathbf{0} & \cdots & \mathbf{W}_1^{[1]} & \cdots & \mathbf{0} \\ \vdots & \vdots & \ddots & \vdots & \ddots & \vdots & \ddots & \vdots \\ \mathbf{0} & \cdots & \cdots & \mathbf{0} & \cdots & \mathbf{0} & \cdots & \mathbf{W}_m^{[1]} \end{bmatrix}. \quad (49)$$

Furthermore, if it is assumed that within each temporal aggregation level the random disturbances follow a multivariate white noise, which means that the contemporaneous covariance matrices are constant in time (i.e., $\mathbf{W}_l^{[k]} = \mathbf{W}^{[k]}$, $k \in \mathcal{K}$, $l = 1, \dots, M_k$), the previous expression simplifies as follows:

$$\mathbf{W} = \begin{bmatrix} \mathbf{W}^{[m]} & \mathbf{0} & \cdots & \mathbf{0} \\ \mathbf{0} & \left(\mathbf{I}_{\frac{m}{k_{p-1}}} \otimes \mathbf{W}^{[k_{p-1}]} \right) & \cdots & \mathbf{0} \\ \vdots & \vdots & \ddots & \vdots \\ \mathbf{0} & \mathbf{0} & \cdots & \left(\mathbf{I}_m \otimes \mathbf{W}^{[1]} \right) \end{bmatrix}. \quad (50)$$

From a practical point of view, each $(n \times n)$ matrix $\mathbf{W}^{[k]}$, $k \in \mathcal{K}$, may be approximated like in the cross-sectional forecast reconciliation case, possibly using the in-sample residuals (see section 3.1). Expressions (49) and (50) can thus be seen as two simple extensions to the cross-temporal case of the approach developed in the cross-sectional framework, where no temporal dependence is accounted for both within and between the n series.

We may similarly propose a simplified pattern of the disturbances covariance matrix of the multivariate regression model (44), by considering the row vectorization form (46). In this case, the random disturbances vector η can be written as

$$\eta = [\eta'_1 \ \cdots \ \eta'_i \ \cdots \ \eta'_n]'$$

where each $[(k^* + m) \times 1]$ vector η_i , $i = 1, \dots, n$, contains the random disturbances at different observation indices of the various temporal aggregation levels for the same series i . If we assume that the n series are uncorrelated at any observation index for any temporal aggregation level (i.e. neither contemporaneous nor temporal correlation is admitted between the series, which is rather unrealistic), denoting with $\mathbf{\Omega}_{ii} = E(\eta_i \eta'_i)$, $i = 1, \dots, n$, the $[(k^* + m) \times (k^* + m)]$ covariance matrix of the coherency errors of the temporal hierarchies of series i , the complete matrix $\mathbf{\Omega}$ can be written as follows:

$$\mathbf{\Omega} = \begin{bmatrix} \mathbf{\Omega}_{11} & \mathbf{0} & \cdots & \mathbf{0} \\ \mathbf{0} & \mathbf{\Omega}_{22} & \cdots & \mathbf{0} \\ \vdots & \vdots & \ddots & \vdots \\ \mathbf{0} & \mathbf{0} & \cdots & \mathbf{\Omega}_{nn} \end{bmatrix}, \quad (51)$$

where each matrix $\mathbf{\Omega}_{ii}$, $i = 1, \dots, n$, may be approximated as in the temporal forecast reconciliation case, possibly using the in-sample residuals (see section 4.1). Thus expression (51) can be seen as a very simple (maybe too simple!) extension to the cross-temporal case of the approach developed in the temporal hierarchies framework, where no correlation is admitted between the random errors of the n series.

Clearly, the two covariance patterns (50) and (51) (i) are placed at opposite ends of possible ways of dealing with cross-temporal variables, and (ii) should be considered as first practical devices to make the optimal combination forecast approach feasible for the cross-temporal framework as well. This subject is undoubtedly of far greater importance between the open issues still remaining in this field, and we plan to go deep on this subject in the next future.

Residual-based estimates of the covariance matrix \mathbf{W} (and of its re-parameterized counterpart $\mathbf{\Omega}$) make use of the in-sample residuals of the models used to forecast the n time series considered at any temporal aggregation level. Denote by

$$\widehat{\mathbf{E}}_l^{[k]}, \quad k \in \mathcal{K}, \quad l = 1, \dots, M_k,$$

the $(n \times N)$ matrix containing the in-sample residuals for a single node of the cross-temporal hierarchy (i.e., the i -th row contains the residuals for the N sub-periods l of the model used to forecast the temporal aggregate of order k of series i). For each temporal aggregation level $k \in \mathcal{K}$, the M_k matrices $\widehat{\mathbf{E}}_l^{[k]}$ can be grouped into the $(n \times NM_k)$ matrix

$$\widehat{\mathbf{E}}^{[k]} = \left[\widehat{\mathbf{E}}_1^{[k]} \quad \dots \quad \widehat{\mathbf{E}}_l^{[k]} \quad \dots \quad \widehat{\mathbf{E}}_{M_k}^{[k]} \right], \quad k \in \mathcal{K}.$$

The $(n(k^* + m) \times N)$ matrix containing all the residuals at any time observation index and any temporal aggregation level, can in turn be written as:

$$\widehat{\mathbf{E}} = \begin{bmatrix} \widehat{\mathbf{E}}_1^{[m]} \\ \widehat{\mathbf{E}}_1^{[k_{p-1}]} \\ \vdots \\ \widehat{\mathbf{E}}_{\frac{m}{k_{p-1}}}^{[k_{p-1}]} \\ \vdots \\ \widehat{\mathbf{E}}_1^{[1]} \\ \vdots \\ \widehat{\mathbf{E}}_m^{[1]} \end{bmatrix} = \left[\widehat{\mathbf{e}}_1 \quad \dots \quad \widehat{\mathbf{e}}_\tau \quad \dots \quad \widehat{\mathbf{e}}_N \right],$$

where each $[n(k^* + m) \times 1]$ vector $\widehat{\mathbf{e}}_\tau$, $\tau = 1, \dots, N$, is given by:

$$\widehat{\mathbf{e}}_\tau = \left[\underbrace{\widehat{e}_{1,\tau}^{[m]} \quad \dots \quad (\widehat{\mathbf{e}}_{1,\tau}^{[1]})'}_{k^*+m} \quad \dots \quad \underbrace{\widehat{e}_{n,\tau}^{[m]} \quad \dots \quad (\widehat{\mathbf{e}}_{n,\tau}^{[1]})'}_{k^*+m} \right]'$$

The sample residual covariance matrix¹⁰ can be calculated according to both parameterization as:

$$\widehat{\mathbf{\Omega}}_{\text{sam}} = \frac{1}{N} \sum_{\tau=1}^N \hat{\mathbf{e}}_{\tau} (\hat{\mathbf{e}}_{\tau})' = \frac{1}{N} \widehat{\mathbf{E}} \widehat{\mathbf{E}}',$$

$$\widehat{\mathbf{W}}_{\text{sam}} = \mathbf{P}' \widehat{\mathbf{\Omega}}_{\text{sam}} \mathbf{P}.$$

However, in many practical situations matrix $\widehat{\mathbf{E}}$ has a number of rows - which is equal to the number of nodes in the cross-temporal hierarchy - much larger than the number of columns, which is equal to $N = \frac{T}{m}$. Thus matrices $\widehat{\mathbf{\Omega}}_{\text{sam}}$ and $\widehat{\mathbf{W}}_{\text{sam}}$ might not have good properties (in particular, they are not p.d. if $N \leq n(k^* + m)$), and simplified approximations must be looked for.

Two feasible alternatives are given by either the diagonalization or the shrinkage of matrix $\widehat{\mathbf{W}}_{\text{sam}}$, that is, respectively:

$$\widehat{\mathbf{W}}_{\text{wlsh}} = \mathbf{I}_{n(k^*+m)} \odot \widehat{\mathbf{W}}_{\text{sam}},$$

$$\widehat{\mathbf{W}}_{\text{shr}} = \hat{\lambda} \widehat{\mathbf{W}}_{\text{wlsh}} + (1 - \hat{\lambda}) \widehat{\mathbf{W}}_{\text{sam}},$$

where $\widehat{\mathbf{W}}_{\text{wlsh}}$ is a diagonal matrix containing the estimates of the ‘hierarchy variances’ for each node of the cross-temporal hierarchy, $\widehat{\mathbf{W}}_{\text{shr}}$ is the matrix obtained by shrinkage of $\widehat{\mathbf{W}}_{\text{sam}}$ with target $\widehat{\mathbf{W}}_{\text{wlsh}}$, and $\hat{\lambda}$ is an estimate of the coefficient of shrinkage intensity λ , $0 \leq \lambda \leq 1$. Both $\widehat{\mathbf{W}}_{\text{sam}}$ and $\widehat{\mathbf{W}}_{\text{shr}}$ refer to all the $n(k^* + m)$ hierarchy nodes simultaneously taken, but unlike the former matrix, the latter should not suffer for possible singularity problems.

The $(n \times n)$ matrices $\mathbf{W}_l^{[k]}$, $k \in \mathcal{K}$, $l = 1, \dots, M_k$, forming the blocks on the diagonal of matrix (49), can be estimated both in full and shrunk version using the in-sample residuals $\widehat{\mathbf{E}}_l^{[k]}$:

$$\widehat{\mathbf{W}}_{l,\text{sam}}^{[k]} = \frac{1}{N} \widehat{\mathbf{E}}_l^{[k]} (\widehat{\mathbf{E}}_l^{[k]})', \quad k \in \mathcal{K}, \quad l = 1, \dots, M_k, \quad (52)$$

$$\widehat{\mathbf{W}}_{l,\text{shr}}^{[k]} = \hat{\lambda}_{k,l} \left(\mathbf{I}_n \odot \widehat{\mathbf{W}}_{l,\text{sam}}^{[k]} \right) + (1 - \hat{\lambda}_{k,l}) \widehat{\mathbf{W}}_{l,\text{sam}}^{[k]}, \quad k \in \mathcal{K}, \quad l = 1, \dots, M_k.$$

Similarly, full and shrunk estimates of matrices $\mathbf{W}^{[k]}$, $k \in \mathcal{K}$, forming the blocks on the diagonal of matrix (50), may be computed as:

$$\widehat{\mathbf{W}}_{\text{sam}}^{[k]} = \frac{1}{NM_k} \widehat{\mathbf{E}}^{[k]} (\widehat{\mathbf{E}}^{[k]})', \quad k \in \mathcal{K}, \quad (53)$$

$$\widehat{\mathbf{W}}_{\text{shr}}^{[k]} = \hat{\lambda}_k \left(\mathbf{I}_n \odot \widehat{\mathbf{W}}_{\text{sam}}^{[k]} \right) + (1 - \hat{\lambda}_k) \widehat{\mathbf{W}}_{\text{sam}}^{[k]}, \quad k \in \mathcal{K}. \quad (54)$$

While expression (52) always requires $N > n$ in order to have good properties, formula (53) makes it clear that - except $\widehat{\mathbf{W}}_{\text{sam}}^{[m]}$, which is calculated with the same N residuals for each series as $\widehat{\mathbf{W}}_{1,\text{sam}}^{[k]}$ - the estimates are based on more data, and

¹⁰Indeed, $\widehat{\mathbf{\Omega}}_{\text{sam}}$ and $\widehat{\mathbf{W}}_{\text{sam}}$ are mean square error (MSE) matrices.

the necessary condition to have a p.d. matrix is $NM_k > n$. However, in order to have all the p matrices $\widehat{\mathbf{W}}_{\text{sam}}^{[k]}$ well defined, the more restrictive condition $N > n$ should be met. Matrices (52) - (54) can be used to approximate \mathbf{W} as follows:

$$\widehat{\mathbf{W}}_{\text{hsam}}^{BD} = \begin{bmatrix} \widehat{\mathbf{W}}_{1,\text{sam}}^{[m]} & \mathbf{0} & \cdots & \mathbf{0} & \cdots & \mathbf{0} & \cdots & \mathbf{0} \\ \mathbf{0} & \widehat{\mathbf{W}}_{1,\text{sam}}^{[k_{p-1}]} & \cdots & \mathbf{0} & \cdots & \mathbf{0} & \cdots & \mathbf{0} \\ \vdots & \vdots & \ddots & \vdots & \ddots & \vdots & \ddots & \vdots \\ \mathbf{0} & \mathbf{0} & \cdots & \widehat{\mathbf{W}}_{\frac{m}{k_{p-1}},\text{sam}}^{[k_{p-1}]} & \cdots & \mathbf{0} & \cdots & \mathbf{0} \\ \vdots & \vdots & \ddots & \vdots & \ddots & \vdots & \ddots & \vdots \\ \mathbf{0} & \cdots & \cdots & \mathbf{0} & \cdots & \widehat{\mathbf{W}}_{1,\text{sam}}^{[1]} & \cdots & \mathbf{0} \\ \vdots & \vdots & \ddots & \vdots & \ddots & \vdots & \ddots & \vdots \\ \mathbf{0} & \cdots & \cdots & \mathbf{0} & \cdots & \mathbf{0} & \cdots & \widehat{\mathbf{W}}_{m,\text{sam}}^{[1]} \end{bmatrix}$$

$$\widehat{\mathbf{W}}_{\text{hshr}}^{BD} = \begin{bmatrix} \widehat{\mathbf{W}}_{1,\text{shr}}^{[m]} & \mathbf{0} & \cdots & \mathbf{0} & \cdots & \mathbf{0} & \cdots & \mathbf{0} \\ \mathbf{0} & \widehat{\mathbf{W}}_{1,\text{shr}}^{[k_{p-1}]} & \cdots & \mathbf{0} & \cdots & \mathbf{0} & \cdots & \mathbf{0} \\ \vdots & \vdots & \ddots & \vdots & \ddots & \vdots & \ddots & \vdots \\ \mathbf{0} & \mathbf{0} & \cdots & \widehat{\mathbf{W}}_{\frac{m}{k_{p-1}},\text{shr}}^{[k_{p-1}]} & \cdots & \mathbf{0} & \cdots & \mathbf{0} \\ \vdots & \vdots & \ddots & \vdots & \ddots & \vdots & \ddots & \vdots \\ \mathbf{0} & \cdots & \cdots & \mathbf{0} & \cdots & \widehat{\mathbf{W}}_{1,\text{shr}}^{[1]} & \cdots & \mathbf{0} \\ \vdots & \vdots & \ddots & \vdots & \ddots & \vdots & \ddots & \vdots \\ \mathbf{0} & \cdots & \cdots & \mathbf{0} & \cdots & \mathbf{0} & \cdots & \widehat{\mathbf{W}}_{m,\text{shr}}^{[1]} \end{bmatrix}$$

$$\widehat{\mathbf{W}}_{\text{sam}}^{BD} = \begin{bmatrix} \widehat{\mathbf{W}}_{\text{sam}}^{[m]} & \mathbf{0} & \cdots & \mathbf{0} \\ \mathbf{0} & \mathbf{I}_{\frac{m}{k_{p-1}}} \otimes \widehat{\mathbf{W}}_{\text{sam}}^{[k_{p-1}]} & \cdots & \mathbf{0} \\ \vdots & \vdots & \ddots & \vdots \\ \mathbf{0} & \mathbf{0} & \cdots & \mathbf{I}_m \otimes \widehat{\mathbf{W}}_{\text{sam}}^{[1]} \end{bmatrix}$$

$$\widehat{\mathbf{W}}_{\text{shr}}^{BD} = \begin{bmatrix} \widehat{\mathbf{W}}_{\text{shr}}^{[m]} & \mathbf{0} & \cdots & \mathbf{0} \\ \mathbf{0} & \mathbf{I}_{\frac{m}{k_{p-1}}} \otimes \widehat{\mathbf{W}}_{\text{shr}}^{[k_{p-1}]} & \cdots & \mathbf{0} \\ \vdots & \vdots & \ddots & \vdots \\ \mathbf{0} & \mathbf{0} & \cdots & \mathbf{I}_m \otimes \widehat{\mathbf{W}}_{\text{shr}}^{[1]} \end{bmatrix}$$

Most of the alternative choices for \mathbf{W} (or $\mathbf{\Omega}$) shown so far are simple extensions to the cross-temporal framework of the approximations for \mathbf{W} (or $\mathbf{\Omega}$) considered either in cross-sectional or in temporal forecast reconciliation. For the time being, we are considering the following approximations ('oct' stands for 'optimal cross-temporal'):

- identity (oct-ols): $\mathbf{W} = \mathbf{\Omega} = \mathbf{I}_{n(k^*+m)}$

- structural (oct-struct): $\mathbf{W} = \widehat{\mathbf{W}}_{\text{struct}} = \text{diag}(\widehat{\mathbf{S}}\mathbf{1}_{n_b m})$
- hierarchy variance scaling (oct-wlsh): $\mathbf{W} = \widehat{\mathbf{W}}_{\text{wlsh}}$
- series variance scaling (oct-wlsv): $\mathbf{W} = \widehat{\mathbf{W}}_{\text{wlsv}} = \mathbf{P}'\widehat{\mathbf{\Omega}}_{\text{wlsv}}\mathbf{P}$, where $\widehat{\mathbf{\Omega}}_{\text{wlsv}}$ is a straightforward extension of $\widehat{\mathbf{\Omega}}_{\text{t-wlsv}}$ (see section 4.1)
- block-diagonal shrunk cross-covariance scaling (oct-bdshr): $\mathbf{W} = \widehat{\mathbf{W}}_{\text{shr}}^{BD}$
- block-diagonal cross-covariance scaling (oct-bdsam): $\mathbf{W} = \widehat{\mathbf{W}}_{\text{sam}}^{BD}$
- auto-covariance scaling (acov): $\mathbf{W} = \widehat{\mathbf{W}}_{\text{acov}} = \mathbf{P}'\widehat{\mathbf{\Omega}}_{\text{acov}}\mathbf{P}$, where $\widehat{\mathbf{\Omega}}_{\text{acov}}$ is a straightforward extension of $\widehat{\mathbf{\Omega}}_{\text{t-acov}}$ (see section 4.1)
- MinT-shr (oct-shr): $\mathbf{W} = \widehat{\mathbf{W}}_{\text{shr}}$
- MinT-sam (oct-sam): $\mathbf{W} = \widehat{\mathbf{W}}_{\text{sam}}$

7 An heuristic cross-temporal reconciliation procedure

Kourentzes and Athanasopoulos (2019), henceforth KA, have proposed a cross-temporal reconciliation procedure that can be viewed as an ensemble forecasting procedure which exploits the simple averaging of different forecasts. The procedure consists in the following steps (it is assumed $h = 1$):

Step 1

For each individual variable, compute the temporally reconciled forecasts and collect them in the $[n \times (k^* + m)]$ matrix $\check{\mathbf{Y}}$:

$$\widehat{\mathbf{Y}} \rightarrow \check{\mathbf{Y}}.$$

This result can be obtained by applying the point forecast reconciliation formula (24) to each column of matrix $\widehat{\mathbf{Y}}'$, which can be written as:

$$\widehat{\mathbf{Y}}' = \begin{bmatrix} \hat{\mathbf{t}}_{a_1} & \cdots & \hat{\mathbf{t}}_{a_{n_a}} & \hat{\mathbf{t}}_{b_1} & \cdots & \hat{\mathbf{t}}_{b_{n_b}} \\ \hat{\mathbf{a}}_1^{[1]} & \cdots & \hat{\mathbf{a}}_{n_a}^{[1]} & \hat{\mathbf{b}}_1^{[1]} & \cdots & \hat{\mathbf{b}}_{n_b}^{[1]} \end{bmatrix}.$$

The n_a vectors of temporally reconciled forecasts of the uts can be obtained as:

$$\begin{bmatrix} \check{\mathbf{t}}_{a_j} \\ \check{\mathbf{a}}_j^{[1]} \end{bmatrix} = \mathbf{M}_{a_j} \begin{bmatrix} \hat{\mathbf{t}}_{a_j} \\ \hat{\mathbf{a}}_j^{[1]} \end{bmatrix}, \quad \mathbf{M}_{a_j} = \mathbf{I}_{k^*+m} - \mathbf{\Omega}_{a_j} \mathbf{Z}_1 (\mathbf{Z}_1' \mathbf{\Omega}_{a_j} \mathbf{Z}_1)^{-1} \mathbf{Z}_1', \quad j = 1, \dots, n_a.$$

Likeways, the n_b vectors of temporally reconciled forecasts of the bts are given by:

$$\begin{bmatrix} \check{\mathbf{t}}_{b_i} \\ \check{\mathbf{b}}_i^{[1]} \end{bmatrix} = \mathbf{M}_{b_i} \begin{bmatrix} \hat{\mathbf{t}}_{b_i} \\ \hat{\mathbf{b}}_i^{[1]} \end{bmatrix}, \quad \mathbf{M}_{b_i} = \mathbf{I}_{k^*+m} - \mathbf{\Omega}_{b_i} \mathbf{Z}_1 (\mathbf{Z}_1' \mathbf{\Omega}_{b_i} \mathbf{Z}_1)^{-1} \mathbf{Z}_1', \quad i = 1, \dots, n_b,$$

where the $n_a + n_b$ matrices \mathbf{M}_{a_j} and \mathbf{M}_{b_i} have dimension $[(k^* + m) \times (k^* + m)]$, and $\mathbf{\Omega}_{a_j}$, $j = 1, \dots, n_a$, and $\mathbf{\Omega}_{b_i}$, $i = 1, \dots, n_b$, are known p.d. $[(k^* + m) \times (k^* + m)]$ matrices.

The mapping performing the transformation of the base forecasts into the temporally reconciled ones can be expressed in compact form as:

$$\text{vec}(\tilde{\mathbf{Y}}') = \begin{bmatrix} \mathbf{M}_{a_1} & \cdots & \mathbf{0} & \mathbf{0} & \cdots & \mathbf{0} \\ \vdots & \ddots & \vdots & \vdots & \ddots & \vdots \\ \mathbf{0} & \cdots & \mathbf{M}_{a_{n_a}} & \mathbf{0} & \cdots & \mathbf{0} \\ \mathbf{0} & \cdots & \mathbf{0} & \mathbf{M}_{b_1} & \cdots & \mathbf{0} \\ \vdots & \ddots & \vdots & \vdots & \ddots & \vdots \\ \mathbf{0} & \cdots & \mathbf{0} & \mathbf{0} & \cdots & \mathbf{M}_{b_{n_b}} \end{bmatrix} \text{vec}(\hat{\mathbf{Y}}'),$$

and then matrix $\tilde{\mathbf{Y}}'$ can be re-stated as:

$$\tilde{\mathbf{Y}}' = \begin{bmatrix} \check{\mathbf{t}}_{a_1} & \cdots & \check{\mathbf{t}}_{a_{n_a}} & \check{\mathbf{t}}_{b_1} & \cdots & \check{\mathbf{t}}_{b_{n_b}} \\ \check{\mathbf{a}}_1^{[1]} & \cdots & \check{\mathbf{a}}_{n_a}^{[1]} & \check{\mathbf{b}}_1^{[1]} & \cdots & \check{\mathbf{b}}_{n_b}^{[1]} \end{bmatrix} = \begin{bmatrix} (\check{\mathbf{A}}^{[m]})' & (\check{\mathbf{B}}^{[m]})' \\ \vdots & \vdots \\ (\check{\mathbf{A}}^{[k_2]})' & (\check{\mathbf{B}}^{[k_2]})' \\ (\check{\mathbf{A}}^{[1]})' & (\check{\mathbf{B}}^{[1]})' \end{bmatrix}.$$

These reconciled forecasts are in line with the temporal aggregation constraints, i.e. $\mathbf{Z}'_1 \tilde{\mathbf{Y}}' = \mathbf{0}_{(k^* \times n)}$, but in general they are not in line with the cross-sectional (contemporaneous) constraints, that is: $\mathbf{U}' \tilde{\mathbf{Y}} \neq \mathbf{0}_{n_a \times (k^* + m)}$.

Step 2

Transform $\tilde{\mathbf{Y}}$ by computing time-by-time cross-sectional reconciled forecasts for all the temporal aggregation levels, and collect them in the $[n \times (k^* + m)]$ matrix $\check{\mathbf{Y}}$:

$$\tilde{\mathbf{Y}} \rightarrow \check{\mathbf{Y}}.$$

Matrix $\check{\mathbf{Y}}$ can be written as

$$\check{\mathbf{Y}} = \left[\check{\mathbf{Y}}^{[m]} \check{\mathbf{Y}}^{[k_{p-1}]} \dots \check{\mathbf{Y}}^{[k_2]} \check{\mathbf{Y}}^{[1]} \right],$$

where $\check{\mathbf{Y}}^{[k]}$, $k \in \mathcal{H}$, has dimension $(n \times M_k)$. Thus, the cross-sectionally reconciled forecasts can be computed by transforming each $\check{\mathbf{Y}}^{[k]}$ as:

$$\check{\mathbf{Y}}^{[k]} = \mathbf{M}^{[k]} \tilde{\mathbf{Y}}^{[k]}, \quad k \in \mathcal{H},$$

where $\mathbf{M}^{[k]}$ denotes the $(n \times n)$ projection matrix used to reconcile forecasts of k -level temporally aggregated time series:

$$\mathbf{M}^{[k]} = \mathbf{I}_n - \mathbf{W}^{[k]} \mathbf{U} \left(\mathbf{U}' \mathbf{W}^{[k]} \mathbf{U} \right)^{-1} \mathbf{U}', \quad k \in \mathcal{H},$$

and $\mathbf{W}^{[k]}$ is a $(n \times n)$ known p.d. matrix. Since it is $\mathbf{U}'\mathbf{M}^{[k]} = \mathbf{0}_{(n_a \times n)}$, $k \in \mathcal{K}$, the reconciled forecasts are cross-sectionally coherent, i.e. $\mathbf{U}'\check{\mathbf{Y}} = \mathbf{0}_{[n_a \times (k^* + m)]}$, but not temporally: $\mathbf{Z}'_1 \check{\mathbf{Y}}' \neq \mathbf{0}_{(k^* \times n)}$.

Step 3

Transform again the step 1 forecasts $\check{\mathbf{Y}}$, by computing time-by-time cross-sectional reconciled forecasts for all the temporal aggregation levels using the $(n \times n)$ matrix $\overline{\mathbf{M}}$, given by the average of the matrices $\mathbf{M}^{[k]}$ obtained at step 2:

$$\check{\mathbf{Y}} \rightarrow \check{\mathbf{Y}}^{KA}.$$

Matrix $\overline{\mathbf{M}}$ can be expressed as:

$$\overline{\mathbf{M}} = \frac{1}{p} \sum_{k \in \mathcal{K}} \mathbf{M}^{[k]},$$

and the final cross-temporal reconciled forecasts are given by:

$$\check{\mathbf{Y}}^{KA} = \overline{\mathbf{M}}\check{\mathbf{Y}}. \quad (55)$$

Since $\mathbf{U}'\overline{\mathbf{M}} = \frac{1}{p} \sum_{k \in \mathcal{K}} \mathbf{U}'\mathbf{M}^{[k]} = \mathbf{0}_{(n_a \times n)}$, and $\mathbf{Z}'_1 \check{\mathbf{Y}}' = \mathbf{0}_{(k^* \times n)}$, the reconciled forecasts (55) fulfill both cross-sectional and temporal aggregation constraints:

$$\begin{aligned} \mathbf{U}'\check{\mathbf{Y}}^{KA} &= \mathbf{U}'\overline{\mathbf{M}}\check{\mathbf{Y}} = \mathbf{0}_{[n_a \times (k^* + m)]}, \\ \mathbf{Z}'_1 (\check{\mathbf{Y}}^{KA})' &= \mathbf{Z}'_1 \check{\mathbf{Y}}' \overline{\mathbf{M}}' = \mathbf{0}_{(k^* \times n)}. \end{aligned}$$

7.1 Some remarks

To perform step 1, KA consider two alternatives as for the $[(k^* + m) \times (k^* + m)]$ matrices $\mathbf{\Omega}_{a_j}$ and $\mathbf{\Omega}_{b_i}$ needed for computing the transformation matrices \mathbf{M}_{a_j} and \mathbf{M}_{b_i} , respectively. The former is t-struct, while the latter is t-wlsv (see section 4.1). As for step 2, KA use either cs-wls or cs-shr (see section 3.1).

Remark 1

These two steps can be seen as the successive applications of two distinct multivariate reconciliation procedure, each characterized by different covariance matrix and constraints. For, in the first step it is solved a quadratic linear problem, where only temporal aggregation constraints are considered:

$$\check{\mathbf{y}} = \arg \min_{\mathbf{y}} (\mathbf{y} - \hat{\mathbf{y}})' \mathbf{\Omega}^{-1} (\mathbf{y} - \hat{\mathbf{y}}), \quad \text{s.t. } (\mathbf{I}_n \otimes \mathbf{Z}'_1) \mathbf{y} = \mathbf{0},$$

where $\mathbf{\Omega}$ is the block-diagonal matrix in (51). The solution is given by:

$$\check{\mathbf{y}} = \hat{\mathbf{y}} - \mathbf{\Omega} (\mathbf{I}_n \otimes \mathbf{Z}_1) [(\mathbf{I}_n \otimes \mathbf{Z}'_1) \mathbf{\Omega} (\mathbf{I}_n \otimes \mathbf{Z}_1)]^{-1} (\mathbf{I}_n \otimes \mathbf{Z}'_1) \hat{\mathbf{y}} = \mathbf{M}\hat{\mathbf{y}},$$

where

$$\mathbf{M} = \mathbf{I} - \boldsymbol{\Omega} (\mathbf{I}_n \otimes \mathbf{Z}_1) [(\mathbf{I}_n \otimes \mathbf{Z}'_1) \boldsymbol{\Omega} (\mathbf{I}_n \otimes \mathbf{Z}_1)]^{-1} (\mathbf{I}_n \otimes \mathbf{Z}'_1)$$

is the $[n(k^* + m) \times n(k^* + m)]$ projection matrix

$$\mathbf{M} = \begin{bmatrix} \mathbf{M}_1 & \mathbf{0} & \cdots & \mathbf{0} \\ \mathbf{0} & \mathbf{M}_2 & \cdots & \mathbf{0} \\ \vdots & \vdots & \ddots & \vdots \\ \mathbf{0} & \mathbf{0} & \cdots & \mathbf{M}_n \end{bmatrix},$$

with

$$\mathbf{M}_i = \mathbf{I}_{k^*+m} - \boldsymbol{\Omega}_{ii} \mathbf{Z}_1 (\mathbf{Z}'_1 \boldsymbol{\Omega}_{ii} \mathbf{Z}_1)^{-1} \mathbf{Z}'_1, \quad i = 1, \dots, n.$$

The second step consists in another quadratic minimization problem, where only cross-sectional (contemporaneous) constraints are considered:

$$\tilde{\mathcal{Y}} = \arg \min_{\mathcal{Y}} (\mathcal{Y} - \tilde{\mathcal{Y}})' \mathbf{W}^{-1} (\mathcal{Y} - \tilde{\mathcal{Y}}), \quad \text{s.t. } (\mathbf{I}_{k^*+m} \otimes \mathbf{U}') \mathcal{Y} = \mathbf{0},$$

where \mathbf{W} is the block-diagonal matrix in (50), and whose solution is given by:

$$\tilde{\mathcal{Y}} = \tilde{\mathcal{Y}} - \mathbf{W} (\mathbf{I}_{k^*+m} \otimes \mathbf{U}) [(\mathbf{I}_{k^*+m} \otimes \mathbf{U}') \mathbf{W} (\mathbf{I}_{k^*+m} \otimes \mathbf{U})]^{-1} (\mathbf{I}_{k^*+m} \otimes \mathbf{U}') \tilde{\mathcal{Y}} = \mathcal{M} \tilde{\mathcal{Y}} \quad (56)$$

where

$$\mathcal{M} = \mathbf{I} - \mathbf{W} (\mathbf{I}_{k^*+m} \otimes \mathbf{U}) [(\mathbf{I}_{k^*+m} \otimes \mathbf{U}') \mathbf{W} (\mathbf{I}_{k^*+m} \otimes \mathbf{U})]^{-1} (\mathbf{I}_{k^*+m} \otimes \mathbf{U}')$$

is the $[n(k^* + m) \times n(k^* + m)]$ projection matrix

$$\begin{aligned} \mathcal{M} &= \begin{bmatrix} \mathbf{M}^{[m]} & \mathbf{0} & \cdots & \mathbf{0} & \cdots & \mathbf{0} & \cdots & \mathbf{0} \\ \mathbf{0} & \mathbf{M}^{[k_{p-1}]} & \cdots & \mathbf{0} & \cdots & \mathbf{0} & \cdots & \mathbf{0} \\ \vdots & \vdots & \ddots & \vdots & \ddots & \vdots & \ddots & \vdots \\ \mathbf{0} & \mathbf{0} & \cdots & \mathbf{M}^{[k_{p-1}]} & \cdots & \mathbf{0} & \cdots & \mathbf{0} \\ \vdots & \vdots & \ddots & \vdots & \ddots & \vdots & \ddots & \vdots \\ \mathbf{0} & \cdots & \cdots & \mathbf{0} & \cdots & \mathbf{M}^{[1]} & \cdots & \mathbf{0} \\ \vdots & \vdots & \ddots & \vdots & \ddots & \vdots & \ddots & \vdots \\ \mathbf{0} & \cdots & \cdots & \mathbf{0} & \cdots & \mathbf{0} & \cdots & \mathbf{M}^{[1]} \end{bmatrix} \\ &= \begin{bmatrix} \mathbf{M}^{[m]} & \mathbf{0} & \cdots & \mathbf{0} \\ \mathbf{0} & \left(\mathbf{I}_{\frac{m}{k_{p-1}}} \otimes \mathbf{M}^{[k_{p-1}]} \right) & \cdots & \mathbf{0} \\ \vdots & \vdots & \ddots & \vdots \\ \mathbf{0} & \mathbf{0} & \cdots & \left(\mathbf{I}_m \otimes \mathbf{M}^{[1]} \right) \end{bmatrix} \end{aligned}$$

with

$$\mathbf{M}^{[k]} = \mathbf{I}_n - \mathbf{W}^{[k]} \mathbf{U} \left(\mathbf{U}' \mathbf{W}^{[k]} \mathbf{U} \right)^{-1} \mathbf{U}', \quad k \in \mathcal{H}.$$

It is worth noting that the reconciled forecasts (56) can be expressed according to the alternative vectorization, as:

$$\check{\mathbf{y}} = \mathbf{P}'\check{\mathcal{Y}}.$$

Remark 2

The cross-sectional reconciliation performed at step 2 of the KA procedure involves the transformations of $k^* + m$ vector of forecasts. More precisely, each transformation matrix $\mathbf{M}^{[k]}$, $k \in \mathcal{K}$, is applied to M_k different ($n \times 1$) vectors. Thus, a sensible alternative to the KA proposal might be considering the weighted average of the transformation matrices:

$$\bar{\mathbf{M}}^* = \frac{1}{k^* + m} \sum_{k \in \mathcal{K}} M_k \mathbf{M}^{[k]}.$$

Remark 3

In general the final result of the reconciliation procedure would change if the user invert the order of application of the two reconciliation steps. In Appendix A.6 the ‘cross-sectional-first-then-temporal’ reconciliation procedure is shown, along with the relevant $\bar{\mathbf{M}}$ matrix, which in this case is obtained through an average of the projection matrices used for the reconciliation of the n series according to temporal hierarchies. Since the differences between the reconciled point forecasts according to these two approaches could be not negligible (see section 7.2), in our view this is a weakness of the procedure, and calls for a decision rule about the final reconciled forecasts to retain. A practical way of doing could be choosing the reconciled forecasts which are the ‘closest’ (according to a given metric) to the base forecasts between the two alternatives.

Remark 4

The calculation of the average matrix $\bar{\mathbf{M}}$ in the final step of the procedure, needed to recover the cross-temporal coherency across the point forecasts, requires the availability of the projection matrices used in the second step. This poses no problem when closed form reconciliation formulae can be used. Unfortunately, this is not the case when the user is interested in considering more general linear constraints (e.g., non-negativity of the final reconciled estimates), that should be treated with appropriate numerical procedures (Kourentzes and Athanasopoulos, 2020a, Wickramasuriya et al., 2020)¹¹.

In the next subsection we extend the heuristic KA procedure in such a way that these issues can be overcome in a simple and effective manner.

7.2 An iterative heuristic cross-temporal reconciliation procedure

Taking inspiration from the heuristic KA reconciliation procedure, we consider an iterative procedure which produces cross-temporally reconciled forecasts by alter-

¹¹This issue is currently under study, in order to develop a procedure which, by exploiting some distinctive features of a hierarchical/grouped time series, be able to produce non-negative reconciled forecasts with a reduced computational effort.

nating forecast reconciliation along one single dimension (either cross-sectional or temporal) at each iteration step.

Each iteration consists in the first two steps of the heuristic KA procedure, so the forecasts are reconciled by alternating cross-sectional (contemporaneous) reconciliation, and reconciliation through temporal hierarchies in a cyclic fashion.

Starting from the base forecasts $\widehat{\mathbf{Y}}$, denote with d_{cs} and d_{te} , respectively, the cross-sectional and temporal gross discrepancies, given by:

$$d_{cs} = \left\| \mathbf{U}' \widehat{\mathbf{Y}} \right\|_1 \quad d_{te} = \left\| \mathbf{Z}'_1 \widehat{\mathbf{Y}}' \right\|_1$$

where $\|\mathbf{X}\|_1 = \sum_{i,j} |x_{i,j}|$. Since the base forecasts are not in line with either type of constraints, in general both d_{cs} and d_{te} are greater than zero.

The iterative procedure can be described as follows:

1. Start the iterations by calculating the temporally reconciled forecasts $\widetilde{\mathbf{Y}}^{(1)}$, such that $\mathbf{Z}'_1 \left(\widetilde{\mathbf{Y}}^{(1)} \right)' = \mathbf{0}$, and $d_{cs}^{(1)} = \left\| \mathbf{U}' \widetilde{\mathbf{Y}}^{(1)} \right\|_1 \geq 0$.
2. The point forecasts in matrix $\widetilde{\mathbf{Y}}^{(1)}$ are then cross-sectionally reconciled, obtaining $\widetilde{\mathbf{Y}}^{(2)}$, which is such that $\mathbf{U}' \widetilde{\mathbf{Y}}^{(2)} = \mathbf{0}$, and $d_{te}^{(1)} = \left\| \mathbf{Z}'_1 \left(\widetilde{\mathbf{Y}}^{(2)} \right)' \right\|_1 \geq 0$.
3. The updates in steps 1. and 2. are performed at each iteration j , $j = 1, 2, \dots$, until a convergence criterion is met, that is $d_{te}^{(j)} < \delta$, where δ is a positive tolerance value (e.g., $\delta = 10^{-6}$), and matrix $\widetilde{\mathbf{Y}}^{(2j)}$ contains the final cross-temporal reconciled forecasts.

The above procedure can be seen as an extension of the well known iterative proportional fitting procedure (Deming and Stephan, 1940, Johnston and Pattie, 1993), also known as RAS method (Miller and Blair, 2009), to adjust the internal cell values of a two-dimensional matrix iteratively until they sum to some predetermined row and column totals. In that case the adjustment follows a proportional adjustment scheme, whereas in the cross-temporal reconciliation framework each adjustment step is made according to the penalty function associated to the single-dimension reconciliation procedure adopted.

Indeed, the choice of the dimension along with the first reconciliation step in each iteration is performed is up to the user, and there is no particular reason why one should perform the temporal reconciliation first, and the cross-sectional reconciliation then. Figure 4 shows the percentage discrepancies in the Australian GDP at current prices one-step-ahead forecasts for any temporal aggregation level (quarterly, semi-annual, annual, see section 8), when the cross-temporal reconciliation is performed according to either the KA approach, or to the analogous procedure where the cross-sectional constraints are considered first, and then the temporal dimension is accounted for. Percentage differences in the reconciled forecasts for this single, very important variable, are visually evident, though bounded within (-0.3% - +0.4%).

Figure 5 completes the results shown so far, by considering the forecasts of the strictly positive 79 (out of 95) variables from both Income and Expenditure sides,



Figure 4: Quarterly, semi-annual and annual Australian GDP one-step-ahead reconciled forecasts according to the Kourentzes and Athanasopoulos (2019) cross-temporal reconciliation approach (t-wlsv for the temporal step, cs-shr for the cross-sectional step) by alternating the constraint dimensions to be fulfilled: percentage differences between the reconciled forecasts obtained through (i) temporal-then-cross-sectional reconciliation, and (ii) cross-sectional-then-temporal reconciliation. The differences between the two reconciled forecasts are divided by their arithmetic mean.

cross-temporally reconciled according to the KA procedure and its iterative variant. The boxplots show the distributions of the percentage discrepancies between the reconciled forecasts obtained using temporal reconciliation first, and cross-sectional reconciliation then, *vis-à-vis* the results obtained by inverting the order of application of the two reconciliation procedures. It clearly appears that the iterative variant of the original KA proposal produces less pronounced discrepancies¹².

It must also be said that the convergence speed of the iterative procedure does not seem to be affected by the choice of the first dimension to be fulfilled when the iteration starts. Figure 6 shows an example of the convergence speed of the iterative procedure either starting with the cross-sectional (left) or temporal (right) reconciliation procedure for the Australian GDP forecasts. In both cases, the convergence is achieved very quickly: fixing $\delta = 10^{-6}$, 15 (14) iterates are needed when starting from the temporal (cross-sectional) dimension. Furthermore, from the fourth iteration onwards the constraints are practically fulfilled in both cases. Nevertheless, since the final reconciled values depend on this choice, it would be useful having an ex-ante ‘choice rule’ between the two alternatives. We are currently working

¹²Temporal reconciliation has been done using t-wlsv, while cross-sectional reconciliation was performed using cs-shr. However, this result does not seem to depend on the reconciliation procedures considered: t-struc+cs-wls, t-struc+cs-shr, and t-wlsv+cs-wls give very similar results, here not presented for space reasons, but available on request from the authors.

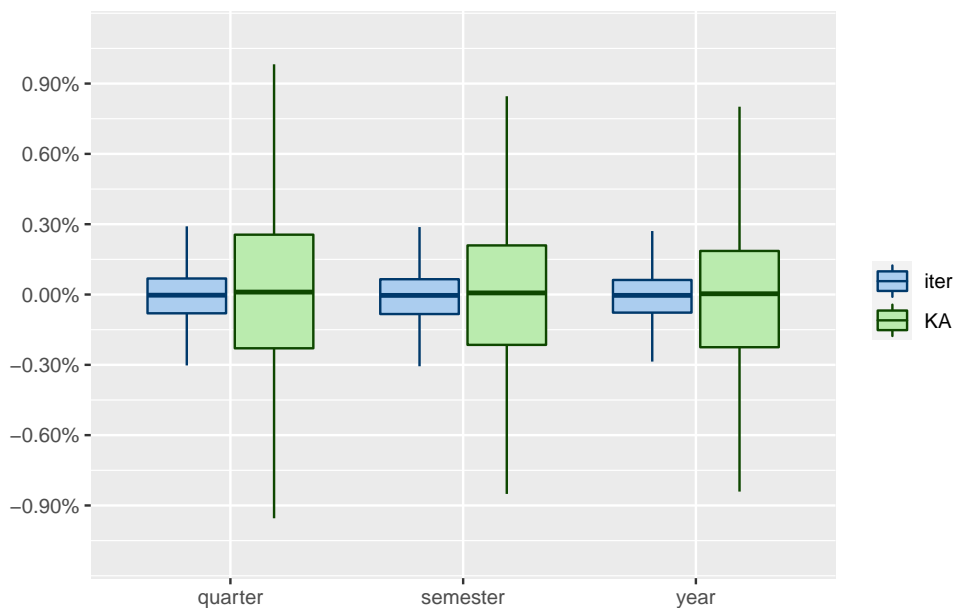

Figure 5: Quarterly, semi-annual and annual one-step-ahead reconciled forecasts of 79 out of 95 times series of the Australian GDP from Income and Expenditure sides using both the original KA cross-temporal reconciliation procedure (t-wlsv for the temporal step, and cs-shr for the cross-sectional one), and its iterative variant: boxplots of the percentage differences between the reconciled forecasts obtained through (i) temporal-then-cross-sectional reconciliation, and (ii) cross-sectional-then-temporal reconciliation. The differences between each pair of reconciled forecasts are divided by their arithmetic mean.

on this issue, however in the rest of the paper, when considering heuristic cross-temporal forecast reconciliation procedures, for ease of presentation we maintain the original choice made by KA, performing temporal forecast reconciliation first, and cross-sectional reconciliation then.

8 Cross-temporal reconciliation of the Australian GDP forecasts from Income and Expenditure sides

In a recent paper, Athanasopoulos et al. (2019, p. 690) propose “the application of state-of-the-art forecast reconciliation methods to macroeconomic forecasting” in order to perform aligned decision making and to improve forecast accuracy. In their empirical study they consider the cross-sectional forecast reconciliation for 95 Australian Quarterly National Accounts time series, describing the Gross Domestic Product (*GDP*) at current prices from Income and Expenditure sides, interpreted as two distinct hierarchical structures. In the former case (Income), *GDP* is on the top of 15 lower level aggregates (figure 7), while in the latter (Expenditure), *GDP* is the top level aggregate of a hierarchy of 79 time series (see figures 21.5-21.7 in Athanasopoulos et al., 2019, pp. 703-705).

By managing the complete set of 95 time series following the approach described in section 3, Bisaglia et al. (2020) have extended the results of Athanasopoulos

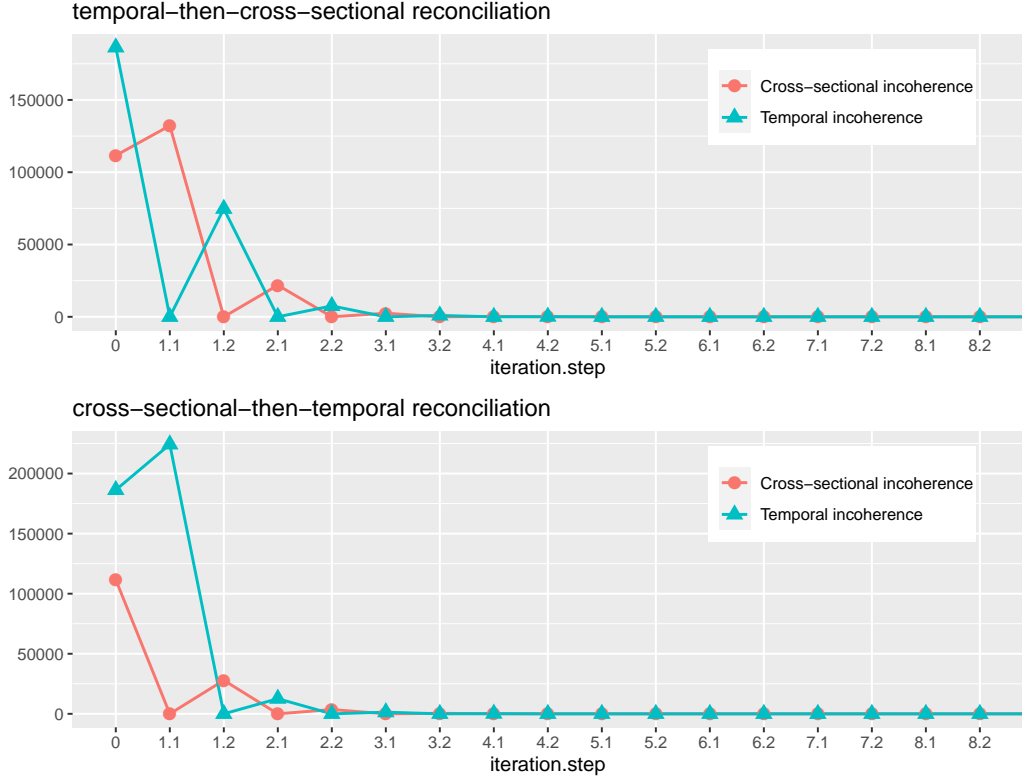

Figure 6: Cross-sectional and temporal gross incoherence at each iteration step of the iterative cross-temporal forecast reconciliation procedure (t-wlsv + cs-shr) for the Australian GDP time series, at the first forecast origin 1994:Q3.

et al. (2019), showing that fully reconciled forecasts of *GDP*, coherent with all the reconciled forecasts from both Expenditure and Income sides, can be obtained through the projection approach described in section 2. According to the notation adopted so far, the (33×95) kernel matrix accounting for the cross-sectional zero constraints is given by (Bisaglia et al., 2020):

$$\mathbf{U}' = \begin{bmatrix} 1 & \mathbf{0}'_5 & -\mathbf{1}'_{10} & \mathbf{0}'_{26} & \mathbf{0}'_{53} \\ 1 & \mathbf{0}'_5 & \mathbf{0}'_{10} & \mathbf{0}'_{26} & -\mathbf{1}'_{53} \\ \mathbf{0}_5 & \mathbf{I}_5 & -\mathbf{C}^I & \mathbf{0}_{5 \times 26} & \mathbf{0}_{5 \times 53} \\ \mathbf{0}_{26} & \mathbf{0}_{26 \times 5} & \mathbf{0}_{26 \times 10} & \mathbf{I}_{26} & -\mathbf{C}^E \end{bmatrix}.$$

In what follows, cross-temporal forecast reconciliation is applied within the same forecasting experiment designed by Athanasopoulos et al. (2019), extended in order to consider semi-annual and annual forecasts as well: for the available time series span (1984:Q4 - 2018:Q1), quarterly base forecasts from 1 up to 4 quarters ahead have been obtained for the $n = 95$ separate time series through simple univariate ARIMA models selected using the `auto.arima` function of the R-package `forecast` (Hyndman et al., 2020). The forecasting experiment uses a recursive training sample with expanding window length, where the first training sample is set from 1984:Q4 to 1994:Q3 and the last ends on 2017:Q1, for a total of 91 forecast origins¹³. Likewise,

¹³The R scripts, the data and the results of the paper by Athanasopoulos et al. (2019) are available

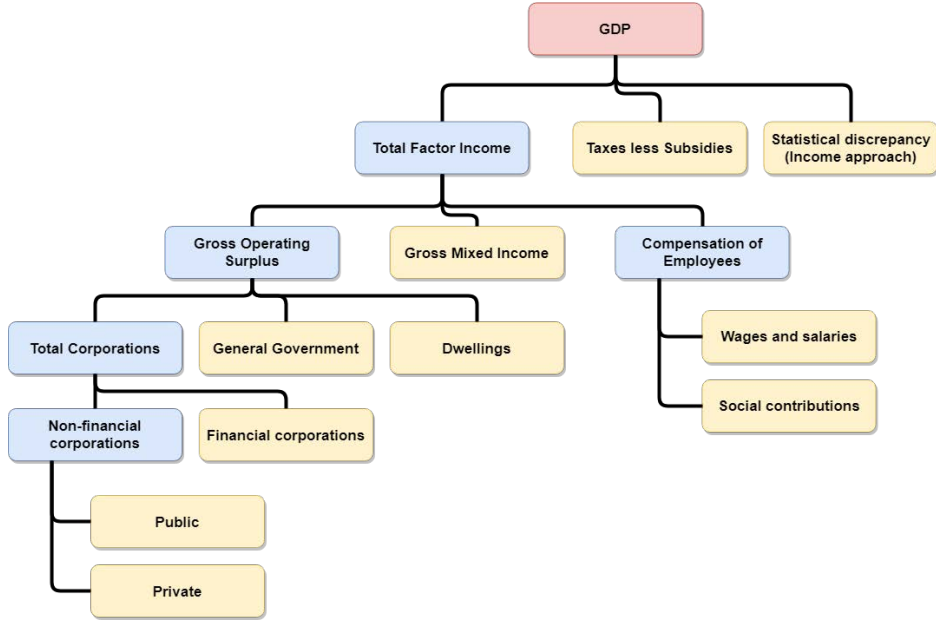

Figure 7: Hierarchical structure of the income approach for Australian GDP. The pink cell contains the most aggregate series. The blue cells contain intermediate-level series and the yellow cells correspond to the most disaggregate bottom-level series. Source: Athanasopoulos et al., 2019, p. 702.

in the same automatic fashion we have computed (i) one and two-step ahead forecasts for the time series obtained by temporal aggregation of two successive quarters, and (ii) one-step-ahead forecasts for the time series obtained by temporal aggregation of four successive quarters.

8.1 Performance measures for multiple comparisons

We evaluate the performance of multiple (say, $J > 1$) forecast reconciliation procedures through forecast accuracy indices calculated on the forecast error¹⁴

$$\hat{e}_{i,j,t}^{[k],h} = y_{i,t+h}^{[k]} - \hat{y}_{i,j,t}^{[k],h}, \quad i = 1, \dots, 95, \quad t = 1, \dots, 91, \quad k \in \mathcal{K}, \\ j = 0, \dots, J, \quad h = 1, \dots, h_k,$$

where y and \hat{y} are the observed and forecasted values, respectively, i denotes the series ($i = 1, \dots, 32$, for the uts, $i = 33, \dots, 95$, for the bts), $j = 0$ denotes the base forecasts, t is the forecast origin ($t = 1$ corresponds to 1994:Q3), $\mathcal{K} = \{4, 2, 1\}$,

in the github repository located at <https://github.com/PuwasalaG/Hierarchical-Book-Chapter>. We did not change this first, crucial step in the forecast reconciliation workflow, since the focus is on the potential of cross-temporal forecast reconciliation. However, Athanasopoulos et al. (2019) point out that this fast and flexible approach performs well in forecasting Australian GDP aggregates, even compared to other more complex methods.

¹⁴Sagaert et al. (2019) warn practitioners that this could be ‘a myopic choice as (the accuracy metrics) consider solely the first moment of the error distribution and ignore higher moments, which can have significant implications for decision making’. This important issue will be dealt with in the next future.

and $h_4 = 1$, $h_2 = 2$, $h_1 = 4$, are the forecast horizons for annual, semi-annual, and quarterly time series, respectively.

The accuracy is evaluated using the Average Relative Mean Square Error (AvgRelMSE, Davydenko and Fildes, 2013; Kourentzes and Athanasopoulos, 2019, 2020b), obtained by transforming the MSE index, given by the average across all 91 forecasts origins of the squared forecast errors:

$$\text{MSE}_{i,j}^{[k],h} = \frac{1}{91} \sum_{t=1}^{91} \left(\hat{e}_{i,j,t}^{[k],h} \right)^2, \quad \begin{array}{l} i = 1, \dots, 95, \quad k \in \mathcal{K}, \\ j = 0, \dots, J, \quad h = 1, \dots, h_k. \end{array} \quad (57)$$

The AvgRelMSE is the geometric mean across all 95 series of the MSE ratio¹⁵ of a forecast over a benchmark given by the base, incoherent ARIMA forecasts, across all evaluation samples, for a given horizon h :

$$\text{AvgRelMSE}_j^{[k],h} = \left(\prod_{i=1}^{95} \text{rMSE}_{i,j}^{[k],h} \right)^{\frac{1}{95}}, \quad \begin{array}{l} j = 0, \dots, J, \quad k \in \mathcal{K}, \\ h = 1, \dots, h_k, \end{array} \quad (58)$$

where $\text{rMSE}_{i,j}^{[k],h}$ is the relative MSE:

$$\text{rMSE}_{i,j}^{[k],h} = \frac{\text{MSE}_{i,j}^{[k],h}}{\text{MSE}_{i,0}^{[k],h}}, \quad \begin{array}{l} i = 1, \dots, 95, \quad k \in \mathcal{K}, \\ j = 0, \dots, J, \quad h = 1, \dots, h_k. \end{array}$$

If a forecast outperforms the base forecasts, then the AvgRelMSE becomes smaller than one and vice-versa, and the percentage improvement in accuracy over the benchmark can be calculated as $\left(1 - \text{AvgRelMSE}_j^{[k],h} \right) \times 100$.

Expression (58), which refers to all 95 time series, can be re-stated for (i) groups of variables (e.g., bts and uts), (ii) multiple forecast horizons (e.g., $h = 1 - 4$ for quarterly forecasts, $k = 1$; $h = 1 - 2$ for semi-annual forecasts, $k = 2$), (iii) different temporal aggregation levels over the whole forecast horizon (e.g., accuracy indices for the whole temporal hierarchy of each series)¹⁶. In Appendix A.7 we show the expressions used to compute forecast accuracy indices in a rolling forecast experiment, like the one we are dealing with, for selected combinations of variables/time frequencies/forecast horizons.

¹⁵Davydenko and Fildes (2013) develop the Average Relative MAE (AvgRelMAE), based on the Mean Absolute Error of the forecasts, but suggest that this formulation ‘If required (...) can also be extended to other measures of dispersion or loss functions’, as the AvgRelMSE in (58) and the AvgRelRMSE, based on the Root Mean Square Error, in Sagaert et al. (2019).

¹⁶On this last point, Kourentzes and Athanasopoulos (2020b, pp. 17-18) raise an important issue by claiming that ‘in contrast to common practice, we believe that there is limited benefit in an empirical evaluation setting, to report average accuracy measures across all levels of the hierarchy (...). It is very improbable that this reflects a realistic situation. Hence, it is paramount that the modeller attempts to establish a strong connection between the objectives of the forecasts and the evaluation’. In the forecasting experiment of this paper, where only three temporal aggregation levels are in order, it could be sensible not to consider as strategic the semi-annual time frequency, which is instrumentally used to improve the accuracy of quarterly and annual forecasts, but is probably of reduced practical usefulness to analysts and decision makers.

In order to give a complete picture of the evaluation results, in the next subsection we show and discuss the MSE-based accuracy indices, at multiple timescales and forecast horizons, for a set of selected forecast reconciliation procedures. Appendix A.8 reports the indices based on MAE as well, and several tables and graphs of the accuracy indices (for both MSE and MAE) for all the forecast reconciliation procedures described in the previous sections, by keeping distinct one-dimension (either cross-sectional or temporal) forecast reconciliation procedures from heuristic and optimal combination procedures.

Furthermore, we use the non-parametric Friedman and post-hoc Nemenyi tests (see also Koning et al., 2005, and Hibon et al., 2012), as implemented in the R-package `tsutils` (Kourentzes, 2019), to establish if the differences in the forecasts produced by the considered procedures are significant. According to Kourentzes and Athanasopoulos (2019, p. 402) “the Friedman test first establishes whether at least one of the forecasts is significantly different from the rest. If this is the case, we use the Nemenyi test to identify groups of forecasts for which there is no evidence of statistically significant differences. The advantage of this testing approach is that it does not impose any distributional assumptions and does not require multiple pairwise testing between forecasts, which would distort the outcome of the tests”.

8.2 The considered forecast reconciliation procedures

The empirical application mainly aims to evaluate the performance of the most convincing new cross-temporal reconciliation procedures, which basically are those using residual-based approximations of the covariance matrix, as compared to the state-of-the-art point forecast reconciliation procedures. More precisely, we consider five selected procedures recently proposed in the hierarchical forecasting literature:

- `cs-shr` (Wickramasuryia, et al. 2019),
- `t-wlsv` (Kourentzes et al., 2017),
- `t-acov` (Nystrup et al., 2020),
- `t-sar1` (Nystrup et al., 2020),
- `kah-wlsv-shr` (Kourentzes and Athanasopoulos, 2019),

five (two-step and iterative) variants of the KA approach:

- `tcs-acov-shr`, i.e. two-step `t-acov` + `cs-shr`,
- `tcs-sar1-shr`, i.e. two-step `t-sar1` + `cs-shr`,
- `ite-wlsv-shr`, i.e. iterative `t-wlsv` + `cs-shr` (see section 7.2),
- `ite-acov-shr`, i.e. iterative `t-acov` + `cs-shr` (see section 7.2),
- `ite-sar1-shr`, i.e. iterative `t-sar1` + `cs-shr` (see section 7.2),

and finally, three optimal combination forecast procedures:

- oct-wlsv, i.e. $\mathbf{W} = \widehat{\mathbf{W}}_{\text{wlsv}}$ (see section 6.1),
- oct-bdshr, i.e. $\mathbf{W} = \widehat{\mathbf{W}}_{\text{shr}}^{BD}$ (see section 6.1),
- oct-acov, i.e. $\mathbf{W} = \widehat{\mathbf{W}}_{\text{acov}}$ (see section 6.1).

The first five procedures have proven well performing in the empirical applications where they have been used (Athanasopoulos et al., 2017, 2019, Wickramasuriya et al., 2019, Bisaglia et al., 2020, Nystrup et al., 2020, among others). Clearly, the uni-dimensional reconciliation procedures (cs-shr, t-wlsv, t-acov, and t-sar1) do not give fully coherent forecasts. Rather, as far as it is expected that they improve on the base forecasts, the best-practice one-dimension procedures should be viewed as stricter benchmarks for the cross-temporal forecast reconciliation procedures, which are requested to give accurate one-number-forecasts as well.

In summary, the forecasting experiment was designed to evaluate the capability of the cross-temporal forecast reconciliation procedures to improve the forecast accuracy as compared (i) to the base forecasts, and (ii) to the most performing one-dimension forecast reconciliation procedures. In addition, the experiment should help in assessing (iii) the performance of both KA-variants (two-step and iterative procedures) and optimal combination forecasts as compared to the original proposal by KA, and (iv) the feasibility and the accuracy of the optimal combination cross-temporal reconciliation procedures, which for the time being - even when they are computed using the in-sample residuals - are based on rather simple/unrealistic approximations of the covariance matrix (see section 6.1). As for this last point, we are interested in understading if there is any significant difference between the reconciled forecasts produced by the most performing heuristic and optimal combination forecast procedures.

8.3 Main results

Table 1 presents the AvgRelMSE's obtained for the forecasting techniques (base + 13 reconciliation procedures) listed in the previous sub-section. We provide results for all 95 component time series, and for the 32 upper-level and the 63 bottom-level time series separately. The results are shown by level of temporal aggregation and forecast horizon. At each column, the lowest error is highlighted in red boldface, while values greater than one, which mean that the reconciled forecasts are worse than the base ones, are highlighted in black boldface.

Most of the data in the table are represented in the top panel of Figure 8, containing the graphs of the AvgRelMSE's for the considered procedures, across all forecast horizons, by temporal aggregation level of the forecasted series. The ranks of these indices are reported in the bottom panel of the same figure, with colours in background chosen to highlight the procedures' performance, from best (green) to worst (red). In this figure the procedures have been put in the order given by the overall AvgRelMSE, which seems a good compromise to represent such a multiple comparison. Figure 9 shows the Multiple Comparison with the Best Nemenyi test, after that the Friedman test has shown that the forecasts given by the considered procedures are different both when all temporal aggregation levels

Table 1: AvgRelMSE at any temporal aggregation level and any forecast horizon.

Procedure	Quarterly					Semi-annual			Annual	All
	1	2	3	4	1-4	1	2	1-2	1	
<i>all 95 series</i>										
base	1	1	1	1	1	1	1	1	1	1
cs-shr	0.9583	0.9701	0.9757	0.9824	0.9716	0.9526	0.9781	0.9652	0.9657	0.9689
t-wlsv	1.0017	0.9994	0.9875	0.9853	0.9934	0.8444	0.9316	0.8869	0.7729	0.9279
t-acov	0.9780	0.9912	0.9986	0.9888	0.9891	0.8253	0.9353	0.8786	0.7694	0.9225
t-sar1	1.0018	0.9994	0.9875	0.9854	0.9935	0.8445	0.9317	0.8870	0.7729	0.9279
kah-wlsv-shr	0.9684	0.9697	0.9596	0.9603	0.9645	0.8175	0.9085	0.8618	0.7518	0.9013
tcs-acov-shr	0.9453	0.9583	0.9710	0.9626	0.9592	0.7977	0.9117	0.8528	0.7481	0.8952
tcs-sar1-shr	0.9684	0.9697	0.9597	0.9603	0.9645	0.8175	0.9086	0.8619	0.7518	0.9013
ite-wlsv-shr	0.9611	0.9680	0.9587	0.9604	0.9620	0.8148	0.9091	0.8606	0.7512	0.8995
ite-acov-shr	0.9398	0.9583	0.9709	0.9653	0.9585	0.7957	0.9127	0.8522	0.7476	0.8945
ite-sar1-shr	0.9613	0.9683	0.9588	0.9605	0.9622	0.8151	0.9092	0.8609	0.7514	0.8997
oct-wlsv	0.9692	0.9719	0.9622	0.9631	0.9666	0.8203	0.9125	0.8652	0.7562	0.9042
oct-bdshr	0.9838	0.9798	0.9618	0.9665	0.9730	0.8297	0.9144	0.8710	0.7573	0.9095
oct-acov	0.9553	0.9648	0.9767	0.9707	0.9668	0.8013	0.9185	0.8579	0.7531	0.9016
<i>32 upper series</i>										
base	1	1	1	1	1	1	1	1	1	1
cs-shr	0.9157	0.927	0.9300	0.9315	0.926	0.9174	0.9387	0.928	0.9232	0.9262
t-wlsv	1.0064	1.0091	0.9909	0.9920	0.9996	0.8556	0.9386	0.8961	0.7684	0.9331
t-acov	1.0018	1.0146	0.9922	0.9934	1.0004	0.8537	0.9382	0.8950	0.7683	0.9332
t-sar1	1.0066	1.0093	0.9908	0.9921	0.9997	0.8560	0.9386	0.8963	0.7684	0.9333
kah-wlsv-shr	0.9398	0.9467	0.9281	0.9302	0.9362	0.7996	0.8769	0.8373	0.7151	0.8726
tcs-acov-shr	0.9411	0.9435	0.9307	0.9331	0.9371	0.7956	0.8779	0.8357	0.7146	0.8725
tcs-sar1-shr	0.9399	0.9464	0.9280	0.9301	0.9361	0.7995	0.8767	0.8372	0.7149	0.8725
ite-wlsv-shr	0.9253	0.9420	0.9224	0.9274	0.9292	0.7932	0.8739	0.8326	0.7114	0.8668
ite-acov-shr	0.9283	0.9398	0.9259	0.9314	0.9313	0.7893	0.8754	0.8313	0.7111	0.8675
ite-sar1-shr	0.9256	0.9424	0.9223	0.9274	0.9294	0.7936	0.8738	0.8327	0.7114	0.8669
oct-wlsv	0.9411	0.9506	0.9316	0.9326	0.939	0.8032	0.8811	0.8412	0.7198	0.8760
oct-bdshr	0.9453	0.9559	0.9246	0.9340	0.9399	0.8091	0.8791	0.8433	0.7174	0.8767
oct-acov	0.9388	0.9498	0.9353	0.9371	0.9402	0.7984	0.8844	0.8403	0.7193	0.8763
<i>63 bottom series</i>										
base	1	1	1	1	1	1	1	1	1	1
cs-shr	0.9806	0.9928	0.9998	1.0094	0.9956	0.9709	0.9987	0.9847	0.9880	0.9914
t-wlsv	0.9992	0.9945	0.9858	0.9819	0.9903	0.8387	0.9281	0.8823	0.7752	0.9252
t-acov	0.9661	0.9796	1.0019	0.9864	0.9834	0.8112	0.9338	0.8704	0.7699	0.9171
t-sar1	0.9994	0.9944	0.9858	0.9820	0.9904	0.8388	0.9282	0.8824	0.7752	0.9253
kah-wlsv-shr	0.9832	0.9817	0.976	0.9759	0.9792	0.8267	0.9250	0.8745	0.7712	0.9163
tcs-acov-shr	0.9474	0.9659	0.9921	0.9780	0.9707	0.7988	0.9294	0.8616	0.7658	0.9069
tcs-sar1-shr	0.9832	0.9818	0.9762	0.9761	0.9793	0.8268	0.9253	0.8746	0.7713	0.9164
ite-wlsv-shr	0.9798	0.9814	0.9776	0.9776	0.9791	0.8259	0.9275	0.8753	0.7723	0.9166
ite-acov-shr	0.9457	0.9679	0.9945	0.9830	0.9726	0.7989	0.9323	0.8631	0.7669	0.9086
ite-sar1-shr	0.9800	0.9817	0.9779	0.9778	0.9793	0.8262	0.9278	0.8755	0.7725	0.9169
oct-wlsv	0.9837	0.9828	0.9782	0.9789	0.9809	0.8292	0.9288	0.8776	0.7754	0.9188
oct-bdshr	1.0040	0.9922	0.9813	0.9835	0.9902	0.8404	0.9329	0.8854	0.7784	0.9267
oct-acov	0.9639	0.9725	0.9984	0.9881	0.9806	0.8028	0.9363	0.8670	0.7709	0.9147

and forecast horizons (top panel), and when only one-step-ahead quarterly forecasts (bottom panel), are considered.

The main results found on this dataset can be summarized as follows:

- as compared to both base forecasts and one-dimension reconciliation procedures, using cross-temporal hierarchies provides a clear decrease in the AvgRelMSE for the uts (likely the most important variables for the decision maker, e.g. GDP) at any temporal aggregation level and any forecast horizon;
- this accuracy improvement is less marked, though yet visually evident, for the

bottom level series, as compared to the reconciled forecasts through temporal hierarchies alone, which however are cross-sectionally incoherent;

- each iterative procedure performs better than its two-step counterpart;
- within the cross-temporal procedures, the heuristic procedures provide better results than the optimal combination ones.

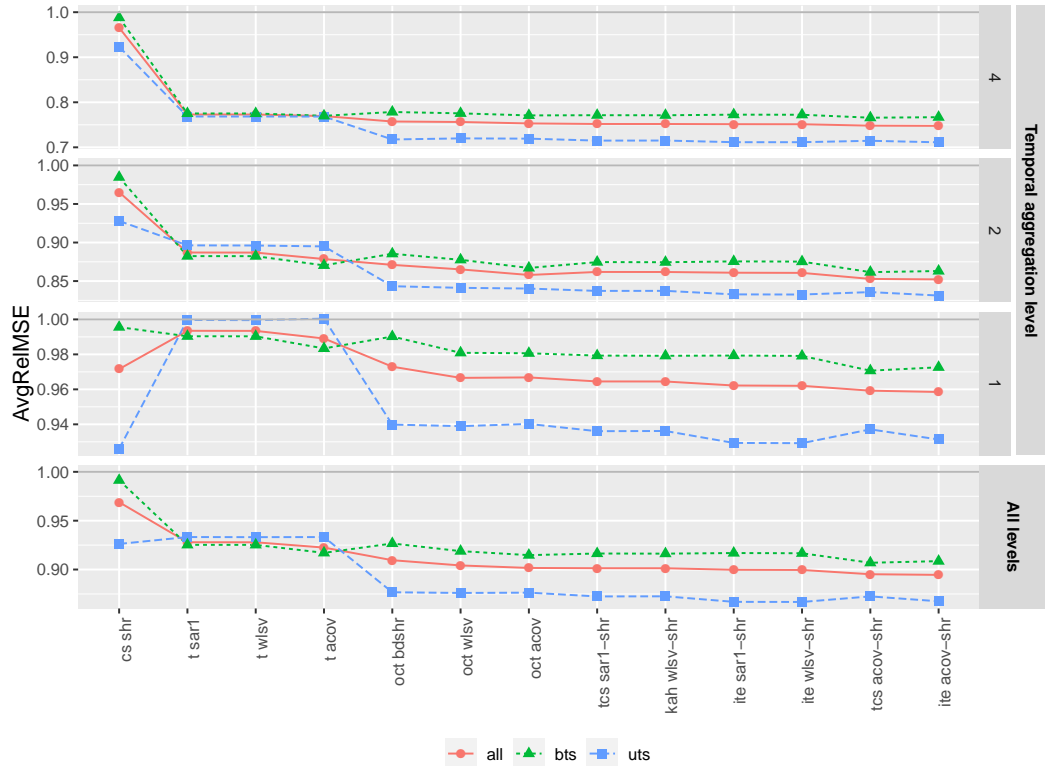

	all				bts				uts			
	all	1	2	4	all	1	2	4	all	1	2	4
ite acov-shr	1	1	1	1	2	2	2	2	3	4	1	1
tcs acov-shr	2	2	2	2	1	1	1	1	5	7	4	4
ite wlsv-shr	3	3	4	3	6	3	7	7	1	2	2	2
ite sar1-shr	4	4	5	4	7	6	8	8	2	3	3	3
kah wlsv-shr	5	5	6	5	4	4	5	5	6	6	6	6
tcs sar1-shr	6	6	7	6	5	5	6	6	4	5	5	5
oct acov	7	8	3	7	3	7	3	4	8	10	7	8
oct wlsv	8	7	8	8	9	8	9	11	7	8	8	9
oct bdshr	9	10	9	9	12	10	12	12	9	9	9	7
t acov	10	11	10	10	8	9	4	3	12	14	10	10
t wlsv	11	12	11	12	10	11	10	10	11	11	11	11
t sar1	12	13	12	11	11	12	11	9	13	12	12	12
cs shr	13	9	13	13	13	13	13	13	10	1	13	13
base	14	14	14	14	14	14	14	14	14	13	14	14

Figure 8: Top panel: Average Relative MSE across all series and forecast horizons, by frequency of observation. Bottom panel: Rankings by frequency of observation and forecast horizon.

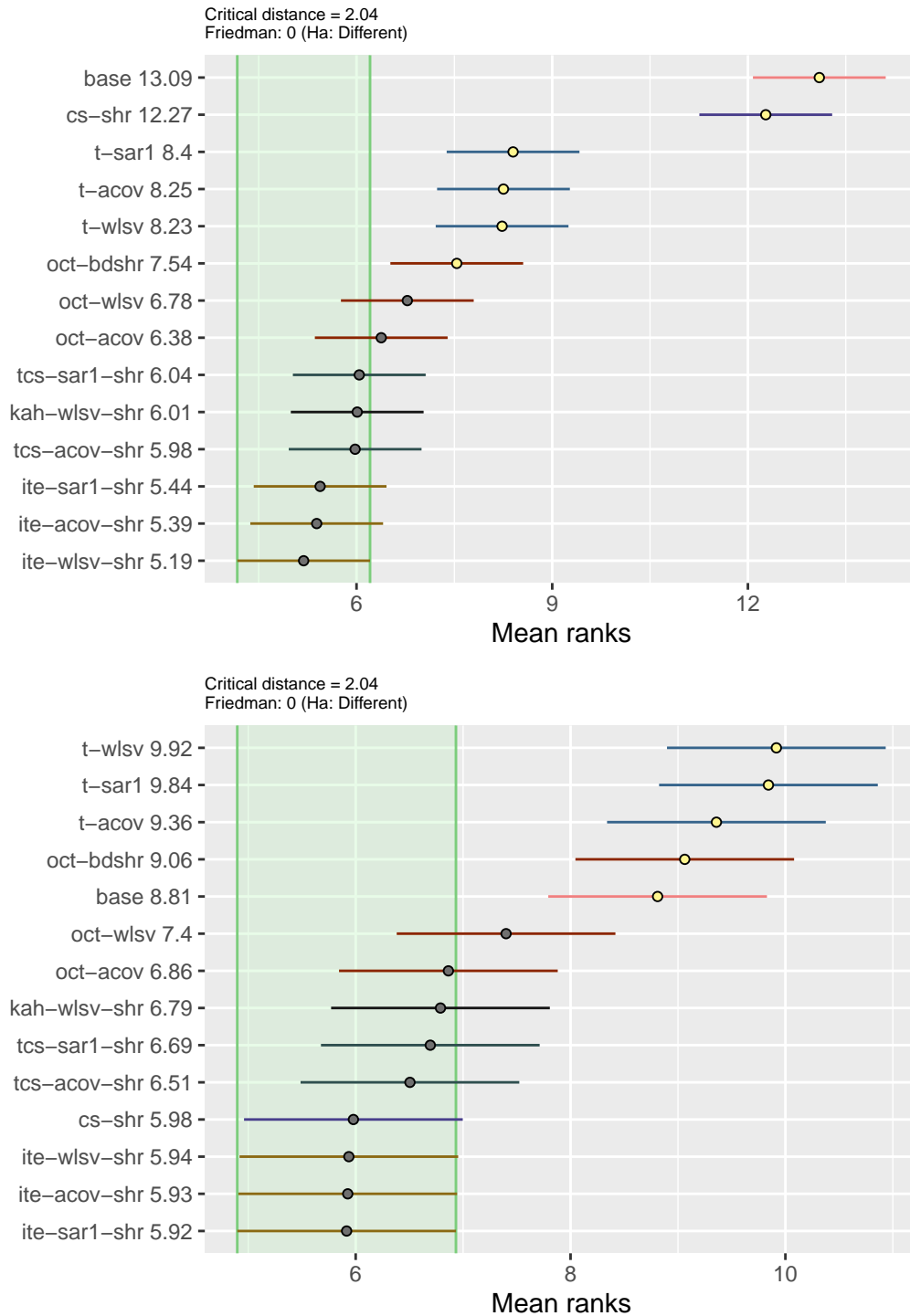

Figure 9: Nemenyi test results at 5% significance level for all 95 series. The reconciliation procedures are sorted vertically according to the MSE mean rank (i) across all time frequencies and forecast horizons (top), and (ii) for one-step-ahead quarterly forecasts (bottom).

Looking at the performances of each procedure, it's worth noting that *cs-shr* scores first as for the quarterly forecasts of the *uts*, and almost always improves on the base forecasts' accuracy, regardless of series' group, temporal aggregation level and forecast horizon¹⁷. In addition, from the bottom panel of Figure 9 we observe that, when considered only on quarterly basis, the one-step-ahead forecasts for all series provided by *cs-shr* are (temporally incoherent and) not significantly different from those provided by the best procedure (which in this case is *ite-acov-shr*). However, since the temporal dimension is not accounted for by this reconciliation procedure, the relative performance worsens (i.e., the cross-temporal procedures improve on the base forecasts more than *cs-shr*) as the temporal aggregation level increases.

Overall, *ite-acov-shr* always scores best for all series and all forecast horizons, and second-best for the *bts* series and all forecast horizons, while *tcs-acov-shr* scores second and first, in turn. However, *ite-acov-shr* shows good results for the *uts* forecasts as well. In this case, the best performances are given by *ite-sar1-shr* and *ite-wlsv-shr*. Figure 9 shows that the differences in the forecasts produced by all the considered heuristic procedures are not statistically significant at any temporal aggregation level and forecast horizon¹⁸. Furthermore, two optimal combination procedures (*oct-acov* and *oct-wlsv*) produce reconciled forecasts not significantly different from the best procedure according to the Nemenyi test (see Figure 9), while *oct-bdshr* is significantly (worse and) different from the best forecast reconciliation procedure.

Finally, in Table 2 the AvgRelMSE's for selected upper time series and reconciliation procedures are shown¹⁹. The series we analyze (see Figure 10) come from the first three levels of both the Income and Expenditure sides hierarchies:

- Gross Domestic Product
- Total Factor Income (Income side)
- Gross Operating Surplus (Income side)
- Compensation of Employees (Income side)
- Gross National Expenditure (Expenditure side)
- Domestic Final Demand (Expenditure side)
- Changes in Inventories (Expenditure sides)
- Final Consumption Expenditures (Expenditure side)
- Gross Fixed Capital Formation (Expenditure side)

¹⁷The only exception is an AvgRelMSE greater than 1 (1.0094) for the *bts* quarterly forecasts at horizon 4.

¹⁸Figure 9 reports only the test results across all temporal aggregation levels and forecast horizons (top), and for $k = 1$ and $h = 1$ (bottom). The graphs of the Nemenyi test for each temporal aggregation level and each forecast horizon are provided in Appendix A.8.

¹⁹The results for all 95 series, and AvgRelMAE as well, are available in Appendix A.8.

Table 2: AvgRelMSE at any temporal aggregation level and any forecast horizon for selected upper time series and reconciliation procedures.

Procedure	Quarterly					Semi-annual			Annual	All
	1	2	3	4	1-4	1	2	1-2	1	
<i>Gross Domestic Product</i>										
cs-shr	0.9740	0.9397	0.9028	0.8924	0.9267	0.8382	0.8713	0.8546	0.7116	0.8719
t-acov	1.0883	1.0356	1.0108	1.0000	1.0331	0.6539	0.8717	0.7549	0.6047	0.8750
kah-wlsv-shr	1.1249	0.9876	0.9068	0.8719	0.9681	0.6510	0.7698	0.7079	0.5485	0.8163
ite-acov-shr	1.0503	0.9808	0.9027	0.8853	0.9526	0.6281	0.7730	0.6968	0.5427	0.8039
oct-acov	1.0696	0.9689	0.8975	0.8926	0.9545	0.6245	0.7745	0.6954	0.5402	0.8039
<i>Total Factor Income</i>										
cs-shr	0.8316	0.9002	0.8769	0.8335	0.8600	0.8232	0.8760	0.8492	0.7162	0.8348
t-acov	1.0434	1.0927	0.9971	0.9818	1.0279	0.7174	0.9408	0.8215	0.6636	0.9057
kah-wlsv-shr	0.9598	0.9523	0.8696	0.7984	0.8925	0.6353	0.7870	0.7071	0.5680	0.7829
ite-acov-shr	0.8995	0.9428	0.8663	0.8134	0.8792	0.6141	0.7909	0.6969	0.5642	0.7722
oct-acov	0.8819	0.9335	0.8635	0.8131	0.8719	0.6078	0.7907	0.6932	0.5603	0.7666
<i>Gross Operating Surplus</i>										
cs-shr	0.9170	0.8834	0.9140	0.9008	0.9037	1.0425	1.0489	1.0457	0.9354	0.9468
t-acov	1.0180	0.9768	0.9760	0.9459	0.9789	0.8958	1.1015	0.9933	0.8807	0.9682
kah-wlsv-shr	0.9867	0.9139	0.8988	0.8717	0.9168	0.8572	1.0133	0.9320	0.8134	0.9055
ite-acov-shr	0.9673	0.8943	0.8985	0.8810	0.9097	0.8338	1.0147	0.9199	0.8083	0.8973
oct-acov	0.9524	0.9233	0.9181	0.8826	0.9187	0.8534	1.0301	0.9376	0.8262	0.9102
<i>Compensation of Employees</i>										
cs-shr	0.9416	0.9880	1.0172	1.0112	0.9891	1.0519	1.0820	1.0669	1.0488	1.0192
t-acov	1.0635	1.0506	1.0593	1.0365	1.0524	0.7474	0.8618	0.8026	0.5876	0.8962
kah-wlsv-shr	1.0893	1.0739	1.0886	1.0330	1.0709	0.7663	0.8726	0.8177	0.5932	0.9112
ite-acov-shr	1.0060	1.0417	1.0778	1.0668	1.0477	0.7326	0.8859	0.8056	0.5931	0.8961
oct-acov	1.0585	1.0662	1.0576	1.0251	1.0517	0.7560	0.8567	0.8048	0.5853	0.8960
<i>Gross National Expenditure</i>										
cs-shr	0.9243	0.9407	0.9212	0.8897	0.9188	0.9865	0.8728	0.9280	0.9302	0.9230
t-acov	1.0197	1.0367	1.0113	1.0060	1.0184	0.8447	0.9008	0.8723	0.6630	0.9164
kah-wlsv-shr	0.9966	0.9959	0.9265	0.9017	0.9542	0.8284	0.8113	0.8198	0.6156	0.8583
ite-acov-shr	0.9723	0.9925	0.9155	0.9094	0.9467	0.8244	0.8158	0.8201	0.6156	0.8545
oct-acov	1.0071	1.0002	0.9278	0.9031	0.9585	0.8193	0.8075	0.8133	0.6064	0.8567
<i>Domestic Final Demand</i>										
cs-shr	0.8713	0.9737	1.0182	0.9958	0.9631	0.9787	1.0192	0.9988	1.0038	0.9789
t-acov	0.9844	1.0002	1.0031	0.9851	0.9932	0.8656	0.9421	0.9030	0.6745	0.9146
kah-wlsv-shr	0.9112	1.0152	1.0136	1.0039	0.9850	0.8184	0.9562	0.8846	0.6747	0.9049
ite-acov-shr	0.8843	1.0014	1.0049	1.0161	0.9751	0.8119	0.9662	0.8857	0.6758	0.9003
oct-acov	0.9274	1.0114	1.0088	0.9956	0.9852	0.8142	0.9428	0.8761	0.6608	0.8999
<i>Changes in Inventories</i>										
cs-shr	1.0791	1.0228	1.0412	0.9250	1.0154	0.7215	0.8134	0.7661	0.8811	0.9181
t-acov	1.0382	1.0609	1.0032	0.9999	1.0253	0.6886	0.7098	0.6991	0.8996	0.9020
kah-wlsv-shr	1.0204	1.0339	1.0163	0.9467	1.0037	0.6644	0.6795	0.6719	0.8369	0.8720
ite-acov-shr	1.0317	1.0239	0.9908	0.9285	0.9929	0.6776	0.6676	0.6726	0.8407	0.8674
oct-acov	1.0074	1.0401	1.0087	0.9540	1.0021	0.6813	0.7051	0.6931	0.9084	0.8894
<i>Final Consumption Expenditures</i>										
cs-shr	0.8826	0.8184	0.8216	0.8223	0.8358	0.9482	0.9741	0.9611	0.9988	0.8923
t-acov	0.9956	1.0268	0.9982	1.0199	1.0100	0.8978	0.9456	0.9214	0.7540	0.9436
kah-wlsv-shr	0.9370	0.9094	0.9000	0.8956	0.9104	0.8077	0.8395	0.8234	0.6708	0.8469
ite-acov-shr	0.9263	0.8804	0.8963	0.8913	0.8984	0.7861	0.8331	0.8093	0.6593	0.8343
oct-acov	0.9691	0.9489	0.9310	0.9373	0.9464	0.8277	0.8673	0.8473	0.6888	0.8763
<i>Gross Fixed Capital Formation</i>										
cs-shr	0.9442	0.9828	1.0156	1.0096	0.9876	1.0225	1.0185	1.0205	0.9719	0.9946
t-acov	0.9875	1.0066	0.9967	0.9653	0.9889	0.8881	1.0002	0.9425	0.7258	0.9333
kah-wlsv-shr	0.9875	0.9790	0.9768	0.9663	0.9774	0.8480	0.9829	0.9130	0.7052	0.9149
ite-acov-shr	0.9524	0.9827	0.9651	0.9859	0.9714	0.8453	0.9973	0.9182	0.7097	0.9140
oct-acov	0.9498	0.9511	0.9539	0.9426	0.9448	0.8149	0.9476	0.8787	0.6726	0.8816



Figure 10: Quarterly GDP and selected time series from both Income and Expenditure sides: actual values and base forecasts during the testing period (1994:Q4 - 2018:Q1)

The ability of cs-shr to improve on short-term (1 or 2-quarter ahead) base forecasts clearly emerges, with the only exception of the forecasts of the Change in Inventories series, where most indices at quarterly level are greater than 1. However, this bad performance is shared by the other reconciliation procedures as well, and is likely due to the low quality of the base forecasts as compared to the other considered series (see Figure 10).

To conclude, the general improvement registered on average (last column of Table 2) by the cross-temporal reconciliation procedures may be considered a positive outcome, which combines an acceptable forecasting performance at quarterly level with a good performance at semi-annual and annual-levels, with the additional feature that the complete system of forecasts is internally and temporally coherent.

9 Conclusions

The hierarchical framework is currently considered as an effective way to improve the accuracy of forecasts in many different fields of application. In this paper we give some contributions and extensions to a topic which has been widely studied in the last decade, by connecting it to the widespread literature on least-squares adjustment of preliminary data (Stone et al., 1942, Byron, 1978), with focus on a projection approach which *de facto* encompasses and extends the modelling framework by Hyndman et al. (2011) (see Wickramasuriya et al., 2019, and Panagiotelis et al., 2020).

Cross-temporal point forecast reconciliation seems to be a promising theme, which is worth considering for future research. In particular, we are currently working to finalize an **R** package offering classical and new optimal and heuristic combination forecast reconciliation procedures (**forec** - forecast reconciliation). In addition, we plan to perform simulation experiments to better understand behaviour, potentiality, and possible drawbacks of the proposed procedures. Other topics in our research agenda are:

- looking for more realistic (and hopefully effective) approximations of the covariance matrices for cross-temporal reconciliation, (i) by deepening some ideas by Kourentzes (2017, 2018), and (ii) by extending/adapting some proposals by Nystrup et al. (2020) to the cross-temporal framework;
- extending the cross-temporal framework to the reconciliation of probabilistic forecasts (Gamakumara et al., 2018, Jeon et al., 2018, Ben Taieb et al., 2020), and for bayesian (Eckert et al., 2019) and fast (Ashouri et al., 2019) forecast reconciliation procedures;
- extending the cross-temporal optimal combination approach to the case of intermittent demand forecasts (Petropoulos and Kourentzes, 2015), with the related non-negativity issues (Kourentzes and Athanasopoulos, 2020a, Wickramasuriya et al., 2020), and possible consideration of ‘soft’ constraints (Danilov and Magnus, 2008).

References

- Ashouri, M., Hyndman, R.J., Shmueli, G. (2019), *Fast forecast reconciliation using linear models*, Department of Econometrics and Business Statistics, Monash University, Working Paper 29/19.
- Athanasopoulos, G., Ahmed, R.A., Hyndman, R.J. (2009), Hierarchical forecasts for Australian domestic tourism, *International Journal of Forecasting*, 25, 1, 146–166.
- Athanasopoulos, G., Gamakumara, P., Panagiotelis, A., Hyndman, R.J., Affan, M. (2019), Hierarchical Forecasting, in Fuleky, P. (ed.), *Macroeconomic Forecasting in the Era of Big Data*, pp. 703-733, Cham, Springer.
- Athanasopoulos, G., Hyndman, R.J., Kourentzes, N., Petropoulos, F. (2017), Forecasting with Temporal Hierarchies, *European Journal of Operational Research*, 262, 1, 60–74.
- Ben Taieb, S., Taylor, J.W., Hyndman, R.J. (2020), Hierarchical Probabilistic Forecasting of Electricity Demand with Smart Meter Data, *Journal of the American Statistical Association* (in press).
- Bertani, N., Satopää, V., Jensen, S. (2020), *Joint Bottom-Up Method for Hierarchical Time-Series: Application to Australian Tourism*. Available at SSRN: <https://ssrn.com/abstract=3542278>. Accessed on June 1, 2020.
- Bisaglia, L., Di Fonzo, T., Girolimetto, D. (2020), *Fully reconciled GDP forecasts from Income and Expenditure sides*, arXiv:2004.03864v2. Accessed on June 1, 2020.
- Byron, R.P. (1978), The estimation of large Social Account Matrices, *Journal of the Royal Statistical Society A*, 141, 3, 359–367.
- Dagum, E.B., Cholette, P.A. (2006), *Benchmarking, Temporal Distribution and Reconciliation Methods for Time Series*, New York, Springer.
- Danilov, D. and Magnus, J.R. (2008), On the estimation of a large sparse Bayesian system: The Snaer program, *Computational Statistics & Data Analysis*, 52, 9, 4203–4224.
- Davydenko, A., Fildes, R. (2013), Measuring forecasting accuracy: The case of judgmental adjustments to SKU-level demand forecasts, *International Journal of Forecasting*, 29, 3, 510–522.
- Deming, E., Stephan, F.F. (1940), On a least squares adjustment of a sampled frequency table when the expected marginal totals are known, *The Annals of Mathematical Statistics*, 11, 4, 427–444.
- Di Fonzo, T. (1990), The estimation of M disaggregate time series when contemporaneous and temporal aggregates are known, *The Review of Economics and Statistics*, 72, 1, 188-192.

- Di Fonzo, T., Marini, M. (2011), Simultaneous and two-step reconciliation of systems of time series: methodological and practical issues, *Journal of the Royal Statistical Society, Series C*, 60, 2, 143-164.
- Eckert, F. Hyndman, R.J., Panagiotelis, A. (2019), Forecasting Swiss Exports using Bayesian Forecast Reconciliation, *KOF Working Papers*, KOF Swiss Economic Institute, ETH Zurich, No. 457.
- Flidner, G. (2001), Hierarchical forecasting: issues and guidelines, *Industrial Management and Data Systems*, 101, 1, 5-12.
- Gamakumara, P., Panagiotelis, A., Athanasopoulos, G., Hyndman, R.J. (2018), *Probabilistic Forecasts in Hierarchical Time Series*, Department of Econometrics and Business Statistics, Monash University, Working Paper 11/18.
- Harville, D.A. (2008), *Matrix algebra from a statistician's perspective*, New York, Springer-Verlag.
- Hibon, M., Crone, S.F., Kourentzes, N. (2012), *Statistical significance of forecasting methods*, presentation at the 32nd Annual International Symposium on Forecasting, Boston, available at: <https://kourentzes.com/forecasting/wp-content/uploads/2014/04/ISF2012.Tests.Kourentzes.pdf>. Accessed on June 1, 2020.
- Hong, T. and Xie, J. and Black, J. (2019), Global energy forecasting competition 2017: Hierarchical probabilistic load forecasting, *International Journal of Forecasting*, 35, 4, 1389-1399.
- Hyndman, R.J., Ahmed, R.A., Athanasopoulos, G., Shang, H.L. (2011), Optimal combination forecasts for hierarchical time series, *Computational Statistics & Data Analysis*, 55, 9, 2579-2589.
- Hyndman, R.J., Athanasopoulos, G. (2018), *Forecasting: principles and practice*, 2nd edition, OTexts: Melbourne, Australia. OTexts.com/fpp2. Accessed on November 14, 2019.
- Hyndman, R.J., Athanasopoulos, G., Bergmeir, C., Caceres, G., Chhay, L., O'Hara-Wild, M., Petropoulos, F., Razbash, S., Wang, E., Yasmeeen, F. (2020), *Forecast: Forecasting functions for time series and linear models*, R package version 8.12 (March 31, 2020).
- Hyndman, R.J., Kourentzes, N. (2018), *Package 'thief'*, R package version 0.3 (January 24, 2018).
- Hyndman, R.J., Lee, A., Wang, E. (2016), Fast computation of reconciled forecasts for hierarchical and grouped time series, *Computational Statistics & Data Analysis*, 97, 16-32.
- Hyndman, R.J., Lee, A., Wang, E., Wickramasuriya, S.L. (2020), *Package 'hts'*, R package version 6.0.0 (April 3, 2020).
- Jeon, J., Panagiotelis, A., Petropoulos, F. (2019), Probabilistic forecast reconciliation with applications to wind power and electric load, *European Journal of Operational Research*, 279, 2, 364-379.

- Johnston, R.J., Pattie, C.J. (1993), Entropy-Maximizing and the Iterative Proportional Fitting Procedure, *The Professional Geographer*, 45, 3, 317–322.
- Koning, A.J., Franses, P.H., Hibon, M., Stekler, H.O. (2005), The M3 competition: Statistical tests of the results, *International Journal of Forecasting*, 21, 3, 397–409.
- Kourentzes, N. (2017), *Uncertainty in predictive modelling*, https://kourentzes.com/forecasting/wp-content/uploads/2017/09/OR59-Kourentzes_Uncertainty.pdf. Accessed on June 1, 2020.
- Kourentzes, N. (2018), *Model uncertainty in hierarchical forecasting*, <https://www.lancaster.ac.uk/media/lancaster-university/content-assets/documents/lums/research/OR60-Kourentzes.pdf>. Accessed on June 1, 2020.
- Kourentzes, N., Athanasopoulos, G. (2019), Cross-temporal coherent forecasts for Australian tourism, *Annals of Tourism Research*, 75, 393–409.
- Kourentzes, N., Athanasopoulos, G. (2020a), Elucidate structure in intermittent demand series, *European Journal of Operational Research* (in press).
- Kourentzes, N., Athanasopoulos, G. (2020b), *On the evaluation of hierarchical forecasts*, Department of Econometrics and Business Statistics, Monash University, Working Paper 02/20.
- Kourentzes, N., Svetunkov, O., Schaer, O. (2020), *Package ‘tsutils’. Time Series Exploration, Modelling and Forecasting*, R package version 0.9.2 (February 6, 2020).
- Li, H., Hyndman, R.J. (2019), *Assessing longevity inequality in the U.S.: What can be said about the future?* Available at <http://dx.doi.org/10.2139/ssrn.3550683>. Accessed on June 1, 2020.
- Lou, T.T., Shiu, S.-H. (2002), Inverses of 2×2 block matrices, *Computers and Mathematics with Applications*, 43(1-2), 119–129.
- Magnus, J.R., Neudecker, H. (2019), *Matrix Differential Calculus with Applications in Statistics and Econometrics*, third edition, New York, Wiley.
- Miller, R.E., Blair, P.D. (2009), *Input-output analysis: foundations and extensions*, 2nd edition, New York, Cambridge University Press.
- Nystrup, P., Lindstroem, E., Pinson, P., Madsen, H. (2020), Temporal hierarchies with autocorrelation for load forecasting, *European Journal of Operational Research*, 280, 1, 876–888.
- Panagiotelis, A., Gamakumara, P., Athanasopoulos, G., Hyndman, R.J. (2020), Forecast reconciliation: A geometric view with new insights on bias correction, *International Journal of Forecasting*, in press.
- Petropoulos, F., Kourentzes, N. (2015), Forecast combination for intermittent demand, *Journal of the Operational Research Society*, 66, 6, 914–924.

- Roach, C. (2019), Reconciled boosted models for GEFCom2017 hierarchical probabilistic load forecasting, *International Journal of Forecasting*, 35, 4, 1439–1450.
- Sagaert, Y.R., Kourentzes, N., De Vuyst, S., Aghezzaf, E.-H. (2019), Incorporating macroeconomic leading indicators in tactical capacity planning, *International Journal of Production Economics*, 209, 12–19.
- Schäfer, J.L., Strimmer, K. (2005), A Shrinkage Approach to Large-Scale Covariance Matrix Estimation and Implications for Functional Genomics, *Statistical Applications in Genetics and Molecular Biology*, 4, 1.
- Shang, H.L. (2017), Reconciling Forecasts of Infant Mortality Rates at National and Sub-National Levels: Grouped Time-Series Methods, *Population Research Policy Review*, 36, 55–84.
- Shang, H.L. (2019), *Dynamic principal component regression for forecasting functional time series in a group structure*, arXiv:1909.00456. Accessed on June 1, 2020.
- Shang, H.L., Hyndman, R.J. (2017), Grouped functional time series forecasting: an application to age-specific mortality rates, *Journal of Computational and Graphical Statistics*, 26, 2, 330–343.
- Solomou, S., Weale, M. (1993), Balanced estimates of national accounts when measurement errors are autocorrelated, *Journal of the Royal Statistical Society, A*, 156, 1, 89–105.
- Spiliotis, E., Petropoulos, F., Kourentzes, N., Assimakopoulos, V. (2020), Cross-temporal aggregation: Improving the forecast accuracy of hierarchical electricity consumption, *Applied Energy*, 261, 1.
- Stone, R., Champernowne, D.G., Meade, J.E. (1942), The precision of national income estimates, *The Review of Economic Studies*, 9, 2, 111–125.
- Van Erven, T., Cugliari, J. (2015), Game-theoretically Optimal Reconciliation of Contemporaneous Hierarchical Time Series Forecasts, in Antoniadis, A., Poggi, J.M., Brossat, X., *Modeling and Stochastic Learning for Forecasting in High Dimensions*, Berlin, Springer, 297–317.
- Weale, M. (1988), The reconciliation of values, volumes and prices in the National Accounts, *Journal of the Royal Statistical Society, A*, 151, 1, 211–221.
- Wickramasuriya, S.L., Athanasopoulos, G., Hyndman, R.J. (2019), Optimal forecast reconciliation for hierarchical and grouped time series through trace minimization, *Journal of the American Statistical Association*, 114, 526, 804–819.
- Wickramasuriya, S.L., Turlach, B.A., Hyndman, R.J. (2020), Optimal non-negative forecast reconciliation, *Statistics and Computing* (in press).
- Yagli, G.M., Yang, D., Srinivasan, D. (2019), Reconciling solar forecasts: Sequential reconciliation, *Solar Energy*, 179, 391–397.
- Yang, D. (2020), Reconciling solar forecasts: Probabilistic forecast reconciliation in a nonparametric framework, *Solar Energy*, in press.

- Yang, D., Quan, H., Disfani, V.R., Rodriguez-Gallego, C.D. (2017), Reconciling solar forecasts: Temporal hierarchy, *Solar Energy*, 158, 332–346.

Appendix

A.1 Alternative, equivalent formulations of the solution to the optimal point forecast reconciliation problem	57
A.2 Balanced and unbalanced hierarchies	58
A.3 Commutation matrix and the relationships linking vectors and matrices of bottom and upper time series	59
A.4 Monthly and hourly temporal hierarchies	62
A.5 Cross-temporal hierarchy: a toy example	64
A.6 An alternative heuristic cross-temporal reconciliation procedure	67
A.7 Average relative accuracy indices for selected groups of variables/time frequencies/forecast horizons, in a rolling forecast experiment	69
A.8 Forecast reconciliation experiment: supplementary tables and graphs	72

A.1 Alternative, equivalent formulations of the solution to the optimal point forecast reconciliation problem

Given the model

$$\hat{\mathbf{y}} = \mathbf{S}\beta + \varepsilon, \quad E(\varepsilon) = \mathbf{0}, \quad E(\varepsilon\varepsilon') = \mathbf{W},$$

the *GLS* estimator of vector β is given by

$$\tilde{\beta} = (\mathbf{S}'\mathbf{W}^{-1}\mathbf{S})^{-1} \mathbf{S}'\mathbf{W}^{-1}\hat{\mathbf{y}}$$

and then the vector containing all reconciled forecasts is given by

$$\tilde{\mathbf{y}} = \mathbf{S}\tilde{\beta} = \mathbf{S}(\mathbf{S}'\mathbf{W}^{-1}\mathbf{S})^{-1} \mathbf{S}'\mathbf{W}^{-1}\hat{\mathbf{y}} = \mathbf{S}\mathbf{G}\hat{\mathbf{y}}, \quad (\text{A.1})$$

where $\mathbf{G} = (\mathbf{S}'\mathbf{W}^{-1}\mathbf{S})^{-1} \mathbf{S}'\mathbf{W}^{-1}$.

Now we show that solution (A.1) is equivalent to the one we obtain considering the following model and its subsequent formulation in terms of constrained quadratic minimization:

$$\hat{\mathbf{y}} = \mathbf{y} + \varepsilon, \quad E(\varepsilon) = \mathbf{0}, \quad E(\varepsilon\varepsilon') = \mathbf{W}, \quad \text{s.t. } \mathbf{H}'\mathbf{y} = \mathbf{0},$$

where $\mathbf{H} = [\mathbf{I}_{n_a} \quad -\mathbf{C}]$ is a matrix of dimension $[n_a \times (n_a + n_b)]$.

In this case the following constrained minimization problem must be solved:

$$\min_{\mathbf{y}} (\mathbf{y} - \hat{\mathbf{y}})' \mathbf{W}^{-1} (\mathbf{y} - \hat{\mathbf{y}}), \quad \text{s.t. } \mathbf{H}'\mathbf{y} = \mathbf{0}$$

Let's consider the lagrangean function

$$\mathcal{L} = (\mathbf{y} - \hat{\mathbf{y}})' \mathbf{W}^{-1} (\mathbf{y} - \hat{\mathbf{y}}) + 2\lambda' \mathbf{H}'\mathbf{y} = \mathbf{y}'\mathbf{W}^{-1}\mathbf{y} - 2\hat{\mathbf{y}}'\mathbf{W}^{-1}\mathbf{y} + 2\lambda'\mathbf{H}'\mathbf{y},$$

where λ is a $(n_a \times 1)$ vector of Lagrange multipliers.

Differentiating \mathcal{L} wrt \mathbf{y} and λ and then equating to zero (first order conditions), we get the linear system

$$\begin{aligned} 2\mathbf{W}^{-1}\mathbf{y} + 2\mathbf{H}\lambda &= 2\mathbf{W}^{-1}\hat{\mathbf{y}} \\ \mathbf{H}'\mathbf{y} &= \mathbf{0} \end{aligned}$$

that is:

$$\begin{bmatrix} \mathbf{W}^{-1} & \mathbf{H} \\ \mathbf{H}' & \mathbf{0} \end{bmatrix} \begin{bmatrix} \mathbf{y} \\ \lambda \end{bmatrix} = \begin{bmatrix} \mathbf{W}^{-1}\hat{\mathbf{y}} \\ \mathbf{0} \end{bmatrix}.$$

According to the lemma of inversion of a block-partitioned matrix (Lou and Shiou, 2002), it is:

$$\begin{bmatrix} \mathbf{W}^{-1} & \mathbf{H} \\ \mathbf{H}' & \mathbf{0} \end{bmatrix}^{-1} = \begin{bmatrix} \mathbf{W} - \mathbf{W}\mathbf{H}(\mathbf{H}'\mathbf{W}\mathbf{H})^{-1}\mathbf{H}'\mathbf{W} & \mathbf{W}\mathbf{H}(\mathbf{H}'\mathbf{W}\mathbf{H})^{-1} \\ (\mathbf{H}'\mathbf{W}\mathbf{H})^{-1}\mathbf{H}'\mathbf{W} & -(\mathbf{H}'\mathbf{W}\mathbf{H})^{-1} \end{bmatrix},$$

and thus

$$\tilde{\mathbf{y}} = [\mathbf{I}_n - \mathbf{W}\mathbf{H}(\mathbf{H}'\mathbf{W}\mathbf{H})^{-1}\mathbf{H}'] \hat{\mathbf{y}}.$$

Now, let us consider matrix \mathbf{J} , defined as

$$\mathbf{J} = \begin{bmatrix} \mathbf{0}_{n_b \times n_a} & \mathbf{I}_{n_b} \end{bmatrix},$$

which has dimension $[n_b \times n]$, and is such that when applied to a $(n \times 1)$ vector, ‘extracts’ its last n_b elements. In other words, by denoting $\tilde{\boldsymbol{\beta}} = \mathbf{J}\hat{\boldsymbol{\beta}}$, it is:

$$\tilde{\boldsymbol{y}} = \mathbf{S}\tilde{\boldsymbol{\beta}} = \left[\mathbf{J} - \mathbf{J}\mathbf{W}\mathbf{H}(\mathbf{H}'\mathbf{W}\mathbf{H})^{-1}\mathbf{H}' \right] \hat{\boldsymbol{y}} = \mathbf{G}\hat{\boldsymbol{y}},$$

from which we can conclude that

$$\mathbf{G} = (\mathbf{S}'\mathbf{W}^{-1}\mathbf{S})^{-1}\mathbf{S}'\mathbf{W}^{-1} = \left[\mathbf{J} - \mathbf{J}\mathbf{W}\mathbf{H}(\mathbf{H}'\mathbf{W}\mathbf{H})^{-1}\mathbf{H}' \right].$$

In the former case, the expression requires the inversion of a $(n \times n)$ matrix, \mathbf{W} , and of a $(n_b \times n_b)$ matrix, $(\mathbf{S}'\mathbf{W}^{-1}\mathbf{S})$. In the latter case the matrix to be inverted, $(\mathbf{H}'\mathbf{W}\mathbf{H})$ has dimension $(n_a \times n_a)$.

A.2 Balanced and unbalanced hierarchies

A simple three-level hierarchy is shown in the right panel of figure A.1, where variable C at the second level of the hierarchy has no ‘children’, and thus is considered as a bottom variable too, at level three of the hierarchy.

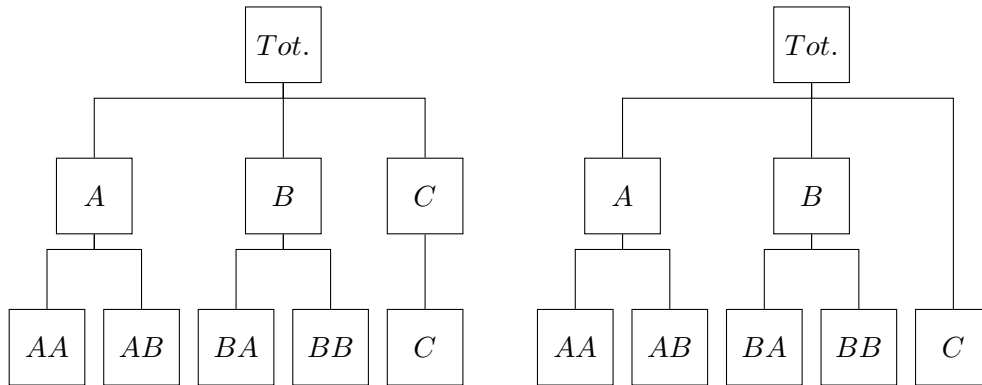

Figure A.1: A simple unbalanced hierarchy (right) and its balanced version (left)

The left panel shows the ‘balanced version’ of the same hierarchy, where variable C is (duplicated and) present at both levels two and three.

The aggregation relationships linking the component series can be expressed as follows:

$$\begin{aligned} y_{Tot} &= y_{AA} + y_{AB} + y_{BA} + y_{BB} + y_C \\ y_A &= y_{AA} + y_{AB} \\ y_B &= y_{BA} + y_{BB} \\ y_C &= y_C \end{aligned},$$

where the last equality has merely the function of making the hierarchy balanced. The corresponding contemporaneous aggregation matrix \mathbf{C} is given by:

$$\mathbf{C} = \begin{bmatrix} 1 & 1 & 1 & 1 & 1 \\ 1 & 1 & 0 & 0 & 0 \\ 0 & 0 & 1 & 1 & 0 \\ 0 & 0 & 0 & 0 & 1 \end{bmatrix}.$$

The redundant relationship ($y_C = y_C$) makes the last row of matrix \mathbf{C} equal to the last row of the contemporaneous summing matrix $\mathbf{S} = \begin{bmatrix} \mathbf{C} \\ \mathbf{I}_5 \end{bmatrix}$. This redundancy can be easily eliminated by considering the new contemporaneous aggregation matrix $\tilde{\mathbf{C}}$, which in the case of an unbalanced hierarchy has clearly one row less than in the balanced version:

$$\tilde{\mathbf{C}} = \begin{bmatrix} 1 & 1 & 1 & 1 & 1 \\ 1 & 1 & 0 & 0 & 0 \\ 0 & 0 & 1 & 1 & 0 \end{bmatrix}.$$

The new contemporaneous summing matrix is thus given by $\tilde{\mathbf{S}} = \begin{bmatrix} \tilde{\mathbf{C}} \\ \mathbf{I}_5 \end{bmatrix}$, which has dimension (8×5) instead of (9×5) as for matrix \mathbf{S} . In a complex hierarchy, mostly when contemporaneous and temporal hierarchies are simultaneously considered, this fact should be carefully considered in order to save memory space and computing time.

The R package `hts` (Hyndman et al., 2020) manages only balanced hierarchy, and thus builds matrix \mathbf{S} instead of $\tilde{\mathbf{S}}$. Due to this fact, large cross-sectional hierarchies might require computational efforts larger than necessary, and could face numerical problems when more sophisticated reconciliation strategies are applied. For example, the grouped time series of the Australian Tourism Demand analyzed by Wickramasuriya et al. (2019) (see also Ashouri et al., 2019; Bertani et al., 2020; Wickramasuriya et al., 2020), contains 30 duplicated time series, since it comes from two unbalanced hierarchies with only 525 ‘unique’ time series (304 bts and 221 uts), as compared to the 555 time series of the balanced version. A similar, though less pronounced case (105 ‘unique’ time series out of 111 for the balanced hierarchy) is present in the reduced version of this system analyzed by Kourentzes and Athanasopoulos (2019) and Panagiotelis et al. (2020).

A.3 Commutation matrix and the relationships linking vectors and matrices of bottom and upper time series

Given an $(r \times c)$ matrix \mathbf{X} , denote with $\mathbf{C}_{r,c}$ the $(rc \times rc)$ commutation matrix (Magnus and Neudecker, 2019) which maps $\text{vec}(\mathbf{X})$ into $\text{vec}(\mathbf{X}')$:

$$\mathbf{C}_{r,c} \text{vec}(\mathbf{X}) = \text{vec}(\mathbf{X}').$$

This matrix is a special type of permutation matrix, obtained by simple exchanges of rows of the identity matrix, and is therefore orthogonal, that is:

$$\mathbf{C}_{r,c}^{-1} = \mathbf{C}'_{r,c} = \mathbf{C}_{c,r}.$$

A.3.1 Cross-sectional case: the permutation matrices linking vectors \mathbf{b}^* to \mathbf{b} and \mathbf{a}^* to \mathbf{a}

Denoting $\mathbf{b} = \text{vec}(\mathbf{B})$, $\mathbf{b}^* = \text{vec}(\mathbf{B}')$, $\mathbf{a} = \text{vec}(\mathbf{A})$, $\mathbf{a}^* = \text{vec}(\mathbf{A}')$, the mappings of \mathbf{b} into \mathbf{b}^* and \mathbf{a} into \mathbf{a}^* , respectively, can be expressed as

$$\mathbf{P}_b \mathbf{b} = \mathbf{b}^*, \quad \mathbf{P}_a \mathbf{a} = \mathbf{a}^*,$$

where $\mathbf{P}_b = \mathbf{C}_{n_b T, n_b T}$ and $\mathbf{P}_a = \mathbf{C}_{n_a T, n_a T}$ are $(n_b T \times n_b T)$ and $(n_a T \times n_a T)$, respectively, commutation matrices. Since both \mathbf{P}_b and \mathbf{P}_a are orthogonal, it is:

$$\mathbf{b} = \mathbf{P}_b' \mathbf{b}^*, \quad \mathbf{a} = \mathbf{P}_a' \mathbf{a}^*.$$

The index k , $k = 1, \dots, n_b T$, of the generic element of vector \mathbf{b}^* can be expressed in terms of the row and column indices of the corresponding element of matrix \mathbf{B}' :

$$\text{vec}(\mathbf{B}') = \mathbf{b}^* = \{b_k^*\}, \quad b_k^* = b_{ti}, \quad \text{with } k = t + (i - 1)T.$$

As for the index l , $l = 1, \dots, n_a T$, of the generic element of vector \mathbf{a}^* , we have:

$$\text{vec}(\mathbf{A}') = \mathbf{a}^* = \{a_l^*\}, \quad a_l^* = a_{tj}, \quad \text{with } l = t + (j - 1)T.$$

A numerical example

Assuming that $n = 2$ variables and $T = 3$ time periods are considered, matrix $\mathbf{X} = \begin{bmatrix} 11 & 12 & 13 \\ 21 & 22 & 23 \end{bmatrix}$ can be vectorized either as

$$\text{vec}(\mathbf{X}) = \mathbf{x} = [11 \ 21 \ 12 \ 22 \ 13 \ 23]'$$

or

$$\text{vec}(\mathbf{X}') = \mathbf{x}^* = [11 \ 12 \ 13 \ 21 \ 22 \ 23]'$$

In this case, the permutation matrix \mathbf{P} mapping \mathbf{x}^* into \mathbf{x} , such that $\mathbf{x}^* = \mathbf{P}\mathbf{x}$ (and $\mathbf{x} = \mathbf{P}'\mathbf{x}^*$), is given by:

$$\mathbf{P} = \begin{bmatrix} 1 & 0 & 0 & 0 & 0 & 0 \\ 0 & 0 & 0 & 1 & 0 & 0 \\ 0 & 1 & 0 & 0 & 0 & 0 \\ 0 & 0 & 0 & 0 & 1 & 0 \\ 0 & 0 & 1 & 0 & 0 & 0 \\ 0 & 0 & 0 & 0 & 0 & 1 \end{bmatrix}.$$

The following **R** script performs the calculation of matrix \mathbf{P} :

```
n <- 2;
t <- 3;
I <- matrix(1:(n*t), n, t, byrow = T)
I <- as.vector(I) # vectorize the required indices
P <- diag(n*t); # Initialize an identity matrix
P <- P[I,] # Re-arrange the rows of the identity matrix
```

```

# A numerical example
X <- matrix(c(11,12,13,21,22,23), byrow=T, nrow=2) # (2 x 3) matrix
Xt <- t(X)
x <- as.vector(X)      # x = vec(X)
xstar <- as.vector(Xt) # xstar = vec(X')
xnew <- P%*%xstar      # vector xstar is mapped into vector xnew
norm(x - xnew)         # check: the norm of the difference should be zero
xstarnew <- t(P)*x;    # vector x is mapped into vector xstarnew
norm(xstar - xstarnew) # check: the norm of the difference should be zero

```

A.3.2 Cross-temporal case: the relationship between $\tilde{\mathbf{y}}$ and $\text{vec}(\mathbf{Y}')$

Assuming $h = 1$, denote with $\mathbf{Y} = \begin{bmatrix} \mathbf{A} \\ \mathbf{B} \end{bmatrix}$ the $[n \times (k^* + m)]$ matrix of the target forecasts at any temporal frequency. The $[n_b \times (k^* + m)]$ submatrix \mathbf{B} , which contains the target forecasts of the bottom time series, can be written as:

$$\mathbf{B} = \begin{bmatrix} \mathbf{B}^{[m]} & \mathbf{B}^{[k_p-1]} & \dots & \mathbf{B}^{[k_2]} & \mathbf{B}^{[1]} \end{bmatrix} = \begin{bmatrix} \mathbf{B}^* & \mathbf{B}^{[1]} \end{bmatrix},$$

where the $(n_b \times k^*)$ matrix $\mathbf{B}^* = \begin{bmatrix} \mathbf{B}^{[m]} & \mathbf{B}^{[k_p-1]} & \dots & \mathbf{B}^{[k_2]} \end{bmatrix}$, and matrix $\mathbf{B}^{[1]}$ contain the target forecasts for, respectively, the temporally aggregated time series (lf-bts) and the high-frequency ones (hf-bts). The following relationships hold:

$$\mathbf{C}_{n_b, (k^*+m)} [\text{vec}(\mathbf{B})] = \text{vec}(\mathbf{B}'),$$

$$\mathbf{C}_{n_b, k^*} [\text{vec}(\mathbf{B}^*)] = \text{vec}[(\mathbf{B}^*)'],$$

$$\mathbf{C}_{n_b, m} [\text{vec}(\mathbf{B}^{[1]})] = \text{vec}[(\mathbf{B}^{[1]})'].$$

Since $\text{vec}(\mathbf{B}) = \begin{bmatrix} \text{vec}(\mathbf{B}^*) \\ \text{vec}(\mathbf{B}^{[1]}) \end{bmatrix}$, we can write:

$$\mathbf{C}_{n_b, (k^*+m)} \text{vec}(\mathbf{B}) = \mathbf{C}_{n_b, (k^*+m)} \begin{bmatrix} \mathbf{C}_{k^*, n_b} & \mathbf{0}_{(n_b k^* \times n_b m)} \\ \mathbf{0}_{(n_b m \times n_b k^*)} & \mathbf{C}_{m, n_b} \end{bmatrix} \begin{bmatrix} \text{vec}[(\mathbf{B}^*)'] \\ \text{vec}[(\mathbf{B}^{[1]})'] \end{bmatrix},$$

that is:

$$\text{vec}(\mathbf{B}') = \tilde{\mathbf{Q}} \begin{bmatrix} \text{vec}[(\mathbf{B}^*)'] \\ \text{vec}[(\mathbf{B}^{[1]})'] \end{bmatrix},$$

where

$$\tilde{\mathbf{Q}} = \mathbf{C}_{n_b, (k^*+m)} \begin{bmatrix} \mathbf{C}_{k^*, n_b} & \mathbf{0}_{(n_b k^* \times n_b m)} \\ \mathbf{0}_{(n_b m \times n_b k^*)} & \mathbf{C}_{m, n_b} \end{bmatrix}. \quad (\text{A.2})$$

According to expression (38), the $[n(k^* + m) \times 1]$ vector $\check{\mathbf{y}}$ can be written as:

$$\check{\mathbf{y}} = \begin{bmatrix} \text{vec}(\mathbf{A}') \\ \text{vec}[(\mathbf{B}^*)'] \\ \text{vec}[(\mathbf{B}^{[1]})'] \end{bmatrix}.$$

Then, $\text{vec}(\mathbf{Y}')$ can be expressed in terms of $\check{\mathbf{y}}$ as:

$$\text{vec}(\mathbf{Y}') = \mathbf{Q}\check{\mathbf{y}},$$

where

$$\mathbf{Q} = \begin{bmatrix} \mathbf{I}_{n_a(k^*+m)} & \mathbf{0}_{[n_a(k^*+m) \times n_b m]} \\ \mathbf{0}_{[n_b m \times n_a(k^*+m)]} & \tilde{\mathbf{Q}} \end{bmatrix}.$$

A.4 Monthly and hourly temporal hierarchies

For monthly data, the aggregates of interest are for $k \in \{12, 6, 4, 3, 2, 1\}$. Hence the monthly observations are aggregated to annual, semi-annual, four-monthly, quarterly and bi-monthly observations. These can be represented in two separate hierarchies, as shown in Fig. A.2, which means that the temporal hierarchies form a grouped series, sharing the ‘top level’ (annual) aggregate, and the same twelve ‘bottom’ nodes, one for each month of the original temporally disaggregated time series.

However, the (16×12) temporal aggregation matrix \mathbf{K}_1 for this case is easily obtained:

$$\mathbf{K}_1 = \begin{bmatrix} 1 & 1 & 1 & 1 & 1 & 1 & 1 & 1 & 1 & 1 & 1 & 1 \\ 1 & 1 & 1 & 1 & 1 & 1 & 0 & 0 & 0 & 0 & 0 & 0 \\ 0 & 0 & 0 & 0 & 0 & 0 & 1 & 1 & 1 & 1 & 1 & 1 \\ 1 & 1 & 1 & 1 & 0 & 0 & 0 & 0 & 0 & 0 & 0 & 0 \\ 0 & 0 & 0 & 0 & 1 & 1 & 1 & 1 & 0 & 0 & 0 & 0 \\ 0 & 0 & 0 & 0 & 0 & 0 & 0 & 0 & 1 & 1 & 1 & 1 \\ 1 & 1 & 1 & 0 & 0 & 0 & 0 & 0 & 0 & 0 & 0 & 0 \\ 0 & 0 & 0 & 1 & 1 & 1 & 0 & 0 & 0 & 0 & 0 & 0 \\ 0 & 0 & 0 & 0 & 0 & 0 & 1 & 1 & 1 & 0 & 0 & 0 \\ 0 & 0 & 0 & 0 & 0 & 0 & 0 & 0 & 0 & 1 & 1 & 1 \\ 1 & 1 & 0 & 0 & 0 & 0 & 0 & 0 & 0 & 0 & 0 & 0 \\ 0 & 0 & 1 & 1 & 0 & 0 & 0 & 0 & 0 & 0 & 0 & 0 \\ 0 & 0 & 0 & 0 & 1 & 1 & 0 & 0 & 0 & 0 & 0 & 0 \\ 0 & 0 & 0 & 0 & 0 & 0 & 1 & 1 & 0 & 0 & 0 & 0 \\ 0 & 0 & 0 & 0 & 0 & 0 & 0 & 0 & 1 & 1 & 0 & 0 \\ 0 & 0 & 0 & 0 & 0 & 0 & 0 & 0 & 0 & 0 & 1 & 1 \end{bmatrix},$$

and thus $\mathbf{R}_1 = \begin{bmatrix} \mathbf{K}_1 \\ \mathbf{I}_{12} \end{bmatrix}$, $\mathbf{Z}'_1 = [\mathbf{I}_{16} \quad -\mathbf{K}_1]$, $\mathbf{x}_\tau = \mathbf{R}_1 \mathbf{x}_\tau^{[1]}$, and $\mathbf{Z}'_1 \mathbf{x}_\tau = \mathbf{0}$, $\tau = 1, \dots, N$,

where $\mathbf{x}_\tau = [x_\tau^{[12]}, \mathbf{x}_\tau^{[6]'}, \mathbf{x}_\tau^{[4]'}, \mathbf{x}_\tau^{[3]'}, \mathbf{x}_\tau^{[2]'}, \mathbf{x}_\tau^{[1]'}]'$ is the (28×1) vector containing all temporal aggregates of variable X at the observation index τ (i.e., within the complete τ -th cycle).

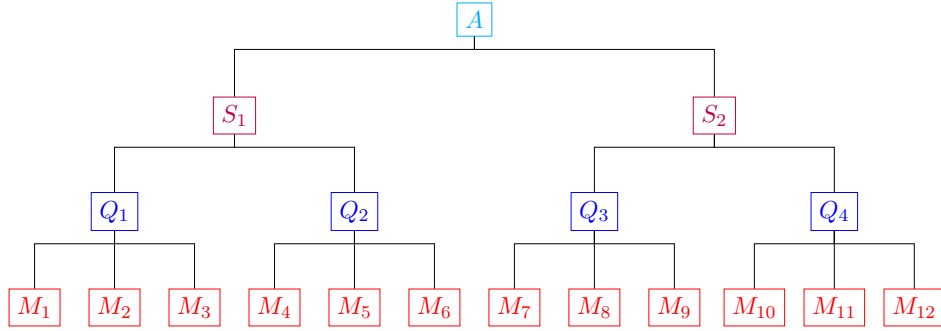

(a) Monthly - Quarterly - Semi-Annual - Annual frequencies

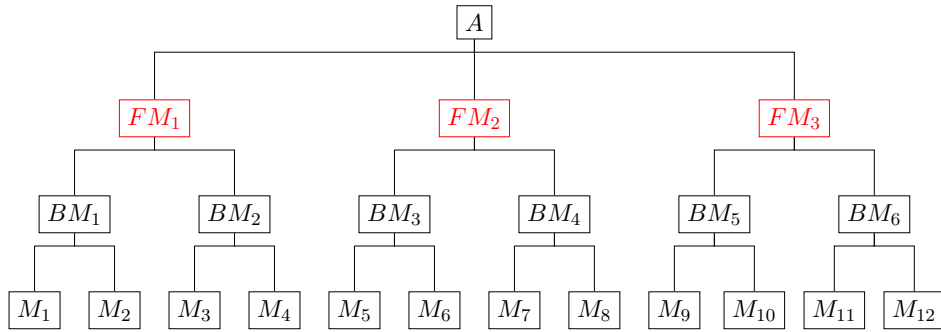

(b) Monthly - Bi-Monthly - Four-Monthly - Annual frequencies

Figure A.2: The two temporal hierarchies induced by a monthly time series.

Let's conclude with considering the case of an hourly time series with diurnal periodicity. In this case it is $m = 24$, $k^* = 36$, and \mathbf{K}_N is the $(36N \times 24N)$ matrix

$$\mathbf{K}_N = \begin{bmatrix} \mathbf{I}_N \otimes \mathbf{1}'_{24} \\ \mathbf{I}_{2N} \otimes \mathbf{1}'_{12} \\ \mathbf{I}_{3N} \otimes \mathbf{1}'_8 \\ \mathbf{I}_{4N} \otimes \mathbf{1}'_6 \\ \mathbf{I}_{6N} \otimes \mathbf{1}'_4 \\ \mathbf{I}_{8N} \otimes \mathbf{1}'_3 \\ \mathbf{I}_{12N} \otimes \mathbf{1}'_2 \end{bmatrix},$$

which converts single hour values into the sum of 2, 3, 4, 6, 8, 12, and 24 hours data, respectively, and $\mathbf{Z}'_N = [\mathbf{I}_{36N} \quad \mathbf{K}_N]$ is a full row-rank $(36N \times 60N)$ matrix.

A.5 Cross-temporal hierarchy: a toy example

Let us consider the relationships linking all the variables implied by a cross-temporal hierarchy for the very simple case of a total quarterly series observed for one year, X , obtained as the sum of two component variables, W and Z , respectively. The contemporaneous (cross-sectional) constraint, $X = W + Z$, must hold at any observation index of all temporal frequencies considered in the temporal hierarchy of Figure 3 (annual, semi-annual and quarterly), as shown in Figure A.3, which gives a graphical view of the way in which the two dimensions (cross-sectional and temporal) are combined within a complete time cycle (one year).

All the nodes in the cross-temporal hierarchy can be expressed in terms of the quarterly bottom time series $w_t^{[1]}$ and $z_t^{[1]}$, $t = 1, \dots, 4$, according to the structural representation:

$$\begin{array}{c}
 \left[\begin{array}{c}
 x_1^{[4]} \\
 x_1^{[2]} \\
 x_2^{[2]} \\
 x_1^{[1]} \\
 x_2^{[1]} \\
 x_3^{[1]} \\
 x_4^{[1]} \\
 w_1^{[4]} \\
 w_1^{[2]} \\
 w_2^{[2]} \\
 z_1^{[4]} \\
 z_1^{[2]} \\
 z_2^{[2]} \\
 w_1^{[1]} \\
 w_2^{[1]} \\
 w_3^{[1]} \\
 w_4^{[1]} \\
 z_1^{[1]} \\
 z_2^{[1]} \\
 z_3^{[1]} \\
 z_4^{[1]}
 \end{array} \right]
 =
 \begin{array}{c}
 \left[\begin{array}{cccccccc}
 1 & 1 & 1 & 1 & 1 & 1 & 1 & 1 \\
 1 & 1 & 0 & 0 & 1 & 1 & 0 & 0 \\
 0 & 0 & 1 & 1 & 0 & 0 & 1 & 1 \\
 1 & 0 & 0 & 0 & 1 & 0 & 0 & 0 \\
 0 & 1 & 0 & 0 & 0 & 1 & 0 & 0 \\
 0 & 0 & 1 & 0 & 0 & 0 & 1 & 0 \\
 0 & 0 & 0 & 1 & 0 & 0 & 0 & 1 \\
 1 & 1 & 1 & 1 & 0 & 0 & 0 & 0 \\
 1 & 1 & 0 & 0 & 0 & 0 & 0 & 0 \\
 0 & 0 & 1 & 1 & 0 & 0 & 0 & 0 \\
 0 & 0 & 0 & 0 & 1 & 1 & 1 & 1 \\
 0 & 0 & 0 & 0 & 1 & 1 & 0 & 0 \\
 0 & 0 & 0 & 0 & 0 & 0 & 1 & 1
 \end{array} \right]
 \left[\begin{array}{c}
 w_1^{[1]} \\
 w_2^{[1]} \\
 w_3^{[1]} \\
 w_4^{[1]} \\
 z_1^{[1]} \\
 z_2^{[1]} \\
 z_3^{[1]} \\
 z_4^{[1]}
 \end{array} \right],
 \end{array}$$

$\underbrace{\hspace{15em}}_{\mathbf{\check{S}}}$
 $\underbrace{\hspace{5em}}_{\mathbf{b}}$

where $\mathbf{a} = [x_1^{[4]} \ x_1^{[2]} \ x_2^{[2]} \ x_1^{[1]} \ x_2^{[1]} \ x_3^{[1]} \ x_4^{[1]}]'$, $\mathbf{b} = [w_1^{[1]} \ w_2^{[1]} \ w_3^{[1]} \ w_4^{[1]} \ z_1^{[1]} \ z_2^{[1]} \ z_3^{[1]} \ z_4^{[1]}]'$, $\check{\mathbf{y}} = \begin{bmatrix} \mathbf{a} \\ \mathbf{b} \end{bmatrix}$, $\check{\mathbf{S}} = \begin{bmatrix} \check{\mathbf{C}} \\ \mathbf{I}_8 \end{bmatrix}$, and $\check{\mathbf{C}}$ is the (13×8) matrix:

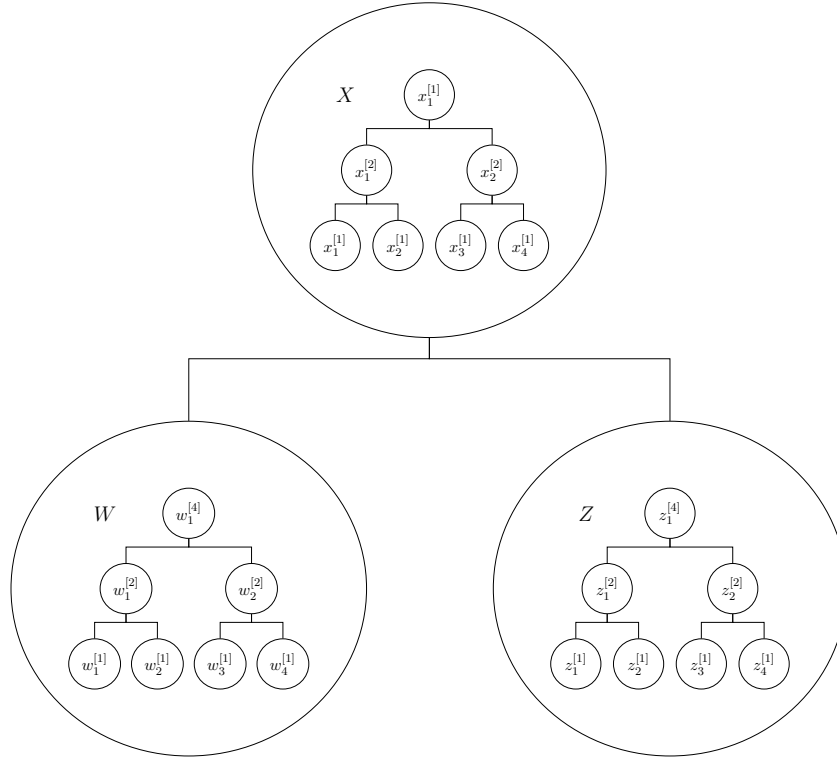

Figure A.3: A two level cross-temporal hierarchy with quarterly data

$$\check{\mathbf{C}} = \begin{bmatrix} 1 & 1 & 1 & 1 & 1 & 1 & 1 & 1 \\ 1 & 1 & 0 & 0 & 1 & 1 & 0 & 0 \\ 0 & 0 & 1 & 1 & 0 & 0 & 1 & 1 \\ 1 & 0 & 0 & 0 & 1 & 0 & 0 & 0 \\ 0 & 1 & 0 & 0 & 0 & 1 & 0 & 0 \\ 0 & 0 & 1 & 0 & 0 & 0 & 1 & 0 \\ 0 & 0 & 0 & 1 & 0 & 0 & 0 & 1 \\ 1 & 1 & 1 & 1 & 0 & 0 & 0 & 0 \\ 1 & 1 & 0 & 0 & 0 & 0 & 0 & 0 \\ 0 & 0 & 1 & 1 & 0 & 0 & 0 & 0 \\ 0 & 0 & 0 & 0 & 1 & 1 & 1 & 1 \\ 0 & 0 & 0 & 0 & 1 & 1 & 0 & 0 \\ 0 & 0 & 0 & 0 & 0 & 0 & 1 & 1 \end{bmatrix}.$$

The zero constraints valid for the nodes of the cross-temporal hierarchy can be represented through the (13×21) matrix $\check{\mathbf{H}}' = [\mathbf{I}_{13} \quad -\check{\mathbf{C}}]$, which has full row-rank, and is such that:

$$\check{\mathbf{H}}' \check{\mathbf{y}} = \mathbf{0}_{(13 \times 1)}. \quad (\text{A.3})$$

According to the notation used so far, it is $n_a = 1$, $n_b = 2$, $T = m = 4$, $N = 1$, $p = 3$, and $\mathcal{K} = \{4, 2, 1\}$. The contemporaneous aggregation matrix \mathbf{C} , mapping bts into uts, is simply a (1×2) row vector of ones: $\mathbf{C} = [1 \ 1]$, and thus \mathbf{U}' is the

linear dependent relationships from the cross-temporal constraint set might be not as simple as in this toy example. In general, the computation of \mathbf{H}' as in (35) seems rather quick and effective. In this toy example, the resulting \mathbf{H}' matrix according to that procedure is simply matrix $\check{\mathbf{H}}'$ without the first three rows, that is:

$$\mathbf{H}' = \begin{bmatrix} \mathbf{I}^* & -\mathbf{I}^* & -\mathbf{I}^* \\ \mathbf{Z}'_1 & \mathbf{0} & \mathbf{0} \\ \mathbf{0} & \mathbf{Z}'_1 & \mathbf{0} \\ \mathbf{0} & \mathbf{0} & \mathbf{Z}'_1 \end{bmatrix},$$

where \mathbf{I}^* is the (4×7) matrix

$$\mathbf{I}^* = \begin{bmatrix} 0 & 0 & 0 & 1 & 0 & 0 & 0 \\ 0 & 0 & 0 & 0 & 1 & 0 & 0 \\ 0 & 0 & 0 & 0 & 0 & 1 & 0 \\ 0 & 0 & 0 & 0 & 0 & 0 & 1 \end{bmatrix}.$$

A.6 An alternative heuristic cross-temporal reconciliation procedure

Let us consider a cross-temporal reconciliation procedure based on the reversal of the order in which the one-dimension forecast reconciliation procedures are applied by KA. The procedure consists in the following steps (it is assumed $h = 1$):

Step 1

Transform $\hat{\mathbf{Y}}$ by computing time-by-time cross-sectional reconciled forecasts $\check{\mathbf{Y}}$ for all the temporal aggregation levels:

$$\hat{\mathbf{Y}} \rightarrow \check{\mathbf{Y}}.$$

The $[n \times (k^* + m)]$ matrix $\hat{\mathbf{Y}}$ can be re-written also as:

$$\hat{\mathbf{Y}} = \left[\hat{\mathbf{Y}}^{[m]} \hat{\mathbf{Y}}^{[k_{p-1}]} \dots \hat{\mathbf{Y}}^{[k_2]} \hat{\mathbf{Y}}^{[1]} \right],$$

where $\hat{\mathbf{Y}}^{[k]}$, $k \in \mathcal{K}$, has dimension $(n \times M_k)$. Cross-sectionally reconciled forecasts can be computed by transforming each $\hat{\mathbf{Y}}^{[k]}$ as:

$$\check{\mathbf{Y}}^{[k]} = \mathbf{M}^{[k]} \hat{\mathbf{Y}}^{[k]}, \quad k \in \mathcal{K},$$

where $\mathbf{M}^{[k]}$ are p transformation matrices, each of dimension $(n \times n)$, given by:

$$\mathbf{M}^{[k]} = \mathbf{I}_n - \mathbf{W}^{[k]} \mathbf{U} \left(\mathbf{U}' \mathbf{W}^{[k]} \mathbf{U} \right)^{-1} \mathbf{U}', \quad k \in \mathcal{K},$$

and $\mathbf{W}^{[k]}$ is a $(n \times n)$ p.d. known matrix. Since it is $\mathbf{U}' \mathbf{M}^{[k]} = \mathbf{0}_{(n_a \times n)}$, $k \in \mathcal{K}$, the reconciled forecasts are cross-sectionally coherent, i.e. $\mathbf{U}' \check{\mathbf{Y}} = \mathbf{0}_{[n_a \times (k^* + m)]}$, but not temporally: $\mathbf{Z}'_1 \check{\mathbf{Y}}' \neq \mathbf{0}_{(k^* \times n)}$.

Step 2

For each individual variable, compute the temporally reconciled forecasts $\check{\check{\mathbf{Y}}}$:

$$\check{\check{\mathbf{Y}}} \rightarrow \check{\check{\mathbf{Y}}}.$$

This result can be obtained by applying the point forecast reconciliation formula according to temporally hierarchies (24) to each column of matrix $\check{\check{\mathbf{Y}}}'$. In fact, using the notation of section 4, it is

$$\check{\check{\mathbf{Y}}}' = \begin{bmatrix} \check{\check{\mathbf{t}}}_{a_1} & \cdots & \check{\check{\mathbf{t}}}_{a_{n_a}} & \check{\check{\mathbf{t}}}_{b_1} & \cdots & \check{\check{\mathbf{t}}}_{b_{n_b}} \\ \check{\check{\mathbf{a}}}_1^{[1]} & \cdots & \check{\check{\mathbf{a}}}_{n_a}^{[1]} & \check{\check{\mathbf{b}}}_1^{[1]} & \cdots & \check{\check{\mathbf{b}}}_{n_b}^{[1]} \end{bmatrix}.$$

The n_a vectors of temporally reconciled forecasts of the uts can be obtained as:

$$\begin{bmatrix} \check{\check{\mathbf{t}}}_{a_j} \\ \check{\check{\mathbf{a}}}_j^{[1]} \end{bmatrix} = \mathbf{M}_{a_j} \begin{bmatrix} \check{\check{\mathbf{t}}}_{a_j} \\ \check{\check{\mathbf{a}}}_j^{[1]} \end{bmatrix}, \quad \mathbf{M}_{a_j} = \mathbf{I}_{k^*+m} - \boldsymbol{\Omega}_{a_j} \mathbf{Z}_1 (\mathbf{Z}'_1 \boldsymbol{\Omega}_{a_j} \mathbf{Z}_1)^{-1} \mathbf{Z}'_1, \quad j = 1, \dots, n_a.$$

Likewise, the n_b vectors of temporally reconciled forecasts of the bts are given by:

$$\begin{bmatrix} \check{\check{\mathbf{t}}}_{b_i} \\ \check{\check{\mathbf{b}}}_i^{[1]} \end{bmatrix} = \mathbf{M}_{b_i} \begin{bmatrix} \check{\check{\mathbf{t}}}_{b_i} \\ \check{\check{\mathbf{b}}}_i^{[1]} \end{bmatrix}, \quad \mathbf{M}_{b_i} = \mathbf{I}_{k^*+m} - \boldsymbol{\Omega}_{b_i} \mathbf{Z}_1 (\mathbf{Z}'_1 \boldsymbol{\Omega}_{b_i} \mathbf{Z}_1)^{-1} \mathbf{Z}'_1, \quad i = 1, \dots, n_b,$$

where the $n_a + n_b$ matrices \mathbf{M}_{a_j} and \mathbf{M}_{b_i} have dimension $[(k^* + m) \times (k^* + m)]$, and each $\boldsymbol{\Omega}_{a_j}$, $j = 1, \dots, n_a$, and $\boldsymbol{\Omega}_{b_i}$, $i = 1, \dots, n_b$, respectively, is a known p.d. $[(k^* + m) \times (k^* + m)]$ matrix.

The mapping performing the transformation of the base forecasts into the temporally reconciled ones can be expressed in compact form as:

$$\text{vec}(\check{\check{\mathbf{Y}}}') = \begin{bmatrix} \mathbf{M}_{a_1} & \cdots & \mathbf{0} & \mathbf{0} & \cdots & \mathbf{0} \\ \vdots & \ddots & \vdots & \vdots & \ddots & \vdots \\ \mathbf{0} & \cdots & \mathbf{M}_{a_{n_a}} & \mathbf{0} & \cdots & \mathbf{0} \\ \mathbf{0} & \cdots & \mathbf{0} & \mathbf{M}_{b_1} & \cdots & \mathbf{0} \\ \vdots & \ddots & \vdots & \vdots & \ddots & \vdots \\ \mathbf{0} & \cdots & \mathbf{0} & \mathbf{0} & \cdots & \mathbf{M}_{b_{n_b}} \end{bmatrix} \text{vec}(\check{\check{\mathbf{Y}}}).$$

The temporally reconciled forecasts can be then collected in the matrix $\check{\check{\mathbf{Y}}}'$:

$$\check{\check{\mathbf{Y}}}' = \begin{bmatrix} \check{\check{\mathbf{t}}}_{a_1} & \cdots & \check{\check{\mathbf{t}}}_{a_{n_a}} & \check{\check{\mathbf{t}}}_{b_1} & \cdots & \check{\check{\mathbf{t}}}_{b_{n_b}} \\ \check{\check{\mathbf{a}}}_1^{[1]} & \cdots & \check{\check{\mathbf{a}}}_{n_a}^{[1]} & \check{\check{\mathbf{b}}}_1^{[1]} & \cdots & \check{\check{\mathbf{b}}}_{n_b}^{[1]} \end{bmatrix} = \begin{bmatrix} (\check{\check{\mathbf{A}}}^{[m]})' & (\check{\check{\mathbf{B}}}^{[m]})' \\ \vdots & \vdots \\ (\check{\check{\mathbf{A}}}^{[k_2]})' & (\check{\check{\mathbf{B}}}^{[k_2]})' \\ (\check{\check{\mathbf{A}}}^{[1]})' & (\check{\check{\mathbf{B}}}^{[1]})' \end{bmatrix},$$

which is in line with the temporal aggregation constraints, i.e. $\mathbf{Z}'_1 \check{\check{\mathbf{Y}}}' = \mathbf{0}_{(k^* \times n)}$, but in general it is not in line with the cross-sectional (contemporaneous) constraints: $\mathbf{U}' \check{\check{\mathbf{Y}}} \neq \mathbf{0}_{n_a \times (k^* + m)}$.

Step 3

Transform again the step 1 forecasts $\check{\mathbf{Y}}$, by computing temporally reconciled forecasts for all n variables using the $[(k^* + m) \times (k^* + m)]$ matrix $\overline{\mathbf{M}}^{\text{cst}}$, where ‘cst’ stands for ‘cross-sectional-then-temporal’, given by the average of the matrices \mathbf{M}_i obtained at step 2:

$$\check{\mathbf{Y}} \Rightarrow \check{\mathbf{Y}}^{\text{cst}}.$$

Matrix $\overline{\mathbf{M}}^{\text{cst}}$ can be expressed as:

$$\overline{\mathbf{M}}^{\text{cst}} = \frac{1}{n} \sum_{i=1}^n \mathbf{M}_i.$$

The final cross-temporal reconciled forecasts are given by:

$$\check{\mathbf{Y}}^{\text{cst}} = \left(\overline{\mathbf{M}}^{\text{cst}} \check{\mathbf{Y}}' \right)' = \check{\mathbf{Y}} (\overline{\mathbf{M}}^{\text{cst}})'. \quad (\text{A.4})$$

Since $\mathbf{U}' \check{\mathbf{Y}} = \mathbf{0}_{[n_a \times (k^* + m)]}$, and $\mathbf{Z}'_1 \overline{\mathbf{M}}^{\text{cst}} = n^{-1} \sum_{i=1}^n \mathbf{Z}'_1 \mathbf{M}_i = \mathbf{0}_{[k^* \times (k^* + m)]}$, the reconciled forecasts (A.4) fulfill both cross-sectional and temporal aggregation constraints:

$$\begin{aligned} \mathbf{U}' \check{\mathbf{Y}}^{\text{cst}} &= \mathbf{U}' \check{\mathbf{Y}} (\overline{\mathbf{M}}^{\text{cst}})' = \mathbf{0}_{[n_a \times (k^* + m)]}, \\ \mathbf{Z}'_1 \left(\check{\mathbf{Y}}^{\text{cst}} \right)' &= \mathbf{Z}'_1 \overline{\mathbf{M}}^{\text{cst}} \check{\mathbf{Y}}' = \mathbf{0}_{(k^* \times n)}. \end{aligned}$$

A.7 Average relative accuracy indices for selected groups of variables/time frequencies/forecast horizons, in a rolling forecast experiment

Let

$$\hat{e}_{i,j,t}^{[k],h} = y_{i,t+h}^{[k]} - \hat{y}_{i,j,t}^{[k],h}, \quad i = 1, \dots, n, \quad t = 1, \dots, q, \quad k \in \mathcal{K}, \\ j = 0, \dots, J, \quad h = 1, \dots, h_k,$$

be the forecast error, where y and \hat{y} are the actual and the forecasted values, respectively, suffix i denotes the variable of interest, j is the forecasting technique, where $j = 0$ is the benchmark forecasting procedure, t is the forecast origin, \mathcal{K} is the set of the time frequencies at which the series is observed, and h is the forecast horizon, whose lead time depends on the time frequency k .

Denote by $A_{i,j}^{[k],h}$ the forecasting accuracy of the technique j , computed across q forecast origins, for the h -step-ahead forecasts of the variable i at the temporal aggregation level k . For example, $A_{i,j}^{[k],h} = MSE_{i,j}^{[k],h}$, as defined in expression (57), otherwise we might have $A_{i,j}^{[k],h} = MAE_{i,j}^{[k],h}$ or $A_{i,j}^{[k],h} = RMSE_{i,j}^{[k],h}$, where

$$\begin{aligned} MAE_{i,j}^{[k],h} &= \frac{1}{q} \sum_{t=1}^q \left| \hat{e}_{i,j,t}^{[k],h} \right| \\ RMSE_{i,j}^{[k],h} &= \sqrt{\frac{1}{q} \sum_{t=1}^q \left(\hat{e}_{i,j,t}^{[k],h} \right)^2} \end{aligned}$$

In any case, we consider the relative version of the accuracy index $A_{i,j}^{[k],h}$, given by:

$$r_{i,j}^{[k],h} = \frac{A_{i,j}^{[k],h}}{A_{i,0}^{[k],h}}, \quad i = 1, \dots, n, \quad j = 0, \dots, J, \quad k \in \mathcal{K}, \quad h = 1, \dots, M_k,$$

and use it to compute the Average relative accuracy index of the forecasting procedure j , for given k and h , through the geometric mean:

$$\text{AvgRelA}_j^{[k],h} = \left(\prod_{i=1}^n r_{i,j}^{[k],h} \right)^{\frac{1}{n}}, \quad j = 0, \dots, J.$$

We may consider the following average relative accuracy indices for selected groups of variables/time frequencies and forecast horizons:

Average relative accuracy indices for a single variable at a given time frequency, for multiple forecast horizons

$$\text{AvgRelA}_{i,j}^{[k],h_1:h_2} = \left(\prod_{h=h_1}^{h_2} r_{i,j}^{[k],h} \right)^{\frac{1}{h_2-h_1+1}}, \quad i = 1, \dots, n, \quad j = 0, \dots, J, \quad k \in \mathcal{K}.$$

Average relative accuracy indices for a group of variables (either all, or selected groups, e.g. a: uts, b: bts) at a given time frequency, either for a single forecast horizon or across them

$$\text{AvgRelA}_j^{[k],h} = \left(\prod_{i=1}^n r_{i,j}^{[k],h} \right)^{\frac{1}{n}}, \quad j = 0, \dots, J, \quad k \in \mathcal{K}, \quad h = 1, \dots, M_k$$

$$\text{AvgRelA}_{a,j}^{[k],h} = \left(\prod_{i=1}^{n_a} r_{i,j}^{[k],h} \right)^{\frac{1}{n_a}}, \quad j = 0, \dots, J, \quad k \in \mathcal{K}$$

$$\text{AvgRelA}_{b,j}^{[k],h} = \left(\prod_{i=n_a+1}^n r_{i,j}^{[k],h} \right)^{\frac{1}{n_b}}, \quad j = 0, \dots, J, \quad k \in \mathcal{K}$$

$$\text{AvgRelA}_j^{[k]} = \left(\prod_{i=1}^n \prod_{h=1}^{M_k} r_{i,j}^{[k],h} \right)^{\frac{1}{nM_k}}, \quad j = 0, \dots, J, \quad k \in \mathcal{K}$$

$$\text{AvgRelA}_{a,j}^{[k]} = \left(\prod_{i=1}^{n_a} \prod_{h=1}^{M_k} r_{i,j}^{[k],h} \right)^{\frac{1}{n_a M_k}}, \quad j = 0, \dots, J, \quad k \in \mathcal{K}$$

$$\text{AvgRelA}_{b,j}^{[k]} = \left(\prod_{i=n_a+1}^n \prod_{h=1}^{M_k} r_{i,j}^{[k],h} \right)^{\frac{1}{n_b M_k}}, \quad j = 0, \dots, J, \quad k \in \mathcal{K}$$

Average relative accuracy indices for a single variable or for a group of variables (all, a: uts, b: bts), across all time frequencies and forecast horizons

$$\begin{aligned} \text{AvgRelMSE}_{i,j} &= \left(\prod_{k \in \mathcal{K}} \prod_{h=1}^{M_k} \text{RelMSE}_{i,j}^{[k],h} \right)^{\frac{1}{k^*+m}}, & i = 1, \dots, n \\ & & j = 0, \dots, J \\ \text{AvgRelMSE}_j &= \left(\prod_{i=1}^n \prod_{k \in \mathcal{K}} \prod_{h=1}^{M_k} \text{RelMSE}_{i,j}^{[k],h} \right)^{\frac{1}{n(k^*+m)}}, & j = 0, \dots, J \\ \text{AvgRelMSE}_{a,j} &= \left(\prod_{i=1}^{n_a} \prod_{k \in \mathcal{K}} \prod_{h=1}^{M_k} \text{RelMSE}_{i,j}^{[k],h} \right)^{\frac{1}{n_a(k^*+m)}}, & j = 0, \dots, J \\ \text{AvgRelMSE}_{b,j} &= \left(\prod_{i=n_a+1}^n \prod_{k \in \mathcal{K}} \prod_{h=1}^{M_k} \text{RelMSE}_{i,j}^{[k],h} \right)^{\frac{1}{n_b(k^*+m)}}, & j = 0, \dots, J \end{aligned}$$

A.8 Forecast reconciliation experiment: supplementary tables and graphs

A.8.1 Selected forecast reconciliation procedures: performance results using AvgRelMAE

Table A.1: AvgRelMAE at any temporal aggregation level and any forecast horizon.

Procedure	Quarterly				Semi-annual			Annual	All	
	1	2	3	4	1-4	1	2	1-2	1	
<i>all 95 series</i>										
base	1	1	1	1	1	1	1	1	1	1
cs-shr	0.9769	0.9842	0.9863	0.9893	0.9842	0.9733	0.9871	0.9802	0.9840	0.9830
t-wlsv	0.9997	0.9988	0.9967	0.9953	0.9976	0.9212	0.9617	0.9412	0.8714	0.9624
t-acov	0.9893	0.9951	1.002	0.9971	0.9959	0.9106	0.9632	0.9365	0.8697	0.9598
t-sar1	0.9997	0.999	0.9964	0.9953	0.9976	0.9213	0.9615	0.9412	0.8712	0.9624
kah-wlsv-shr	0.9796	0.9829	0.9797	0.9790	0.9803	0.9046	0.9459	0.9250	0.8572	0.9459
tcs-acov-shr	0.9698	0.9764	0.9852	0.9805	0.9780	0.8936	0.9476	0.9202	0.8555	0.9429
tcs-sar1-shr	0.9797	0.9830	0.9796	0.9790	0.9803	0.9048	0.9459	0.9251	0.8572	0.9459
ite-wlsv-shr	0.9750	0.9815	0.9783	0.9784	0.9783	0.9035	0.9459	0.9245	0.8562	0.9444
ite-acov-shr	0.9672	0.9770	0.9849	0.9812	0.9776	0.8936	0.9481	0.9205	0.8547	0.9426
ite-sar1-shr	0.9751	0.9819	0.9781	0.9784	0.9784	0.9038	0.9459	0.9246	0.8563	0.9445
oct-wlsv	0.9813	0.9858	0.9829	0.9830	0.9832	0.9078	0.9506	0.9289	0.8620	0.9494
oct-bdshr	0.9858	0.9880	0.9809	0.9833	0.9845	0.9112	0.9499	0.9304	0.8620	0.9505
oct-acov	0.9762	0.9831	0.9904	0.9879	0.9844	0.8965	0.9541	0.9248	0.8600	0.9485
<i>32 upper series</i>										
base	1	1	1	1	1	1	1	1	1	1
cs-shr	0.9484	0.9628	0.9595	0.9652	0.959	0.9521	0.9679	0.9600	0.9691	0.9607
t-wlsv	0.9947	1.0034	0.9994	1.0006	0.9995	0.9273	0.9628	0.9448	0.8689	0.9641
t-acov	0.9965	1.0061	1.0019	1.0011	1.0014	0.9270	0.9627	0.9447	0.8688	0.9651
t-sar1	0.9947	1.0034	0.9993	1.0005	0.9995	0.9275	0.9626	0.9449	0.8686	0.9640
kah-wlsv-shr	0.9538	0.9713	0.9646	0.9685	0.9645	0.8912	0.9265	0.9087	0.8319	0.9284
tcs-acov-shr	0.9595	0.9679	0.9655	0.9700	0.9657	0.8895	0.9269	0.9080	0.8314	0.9288
tcs-sar1-shr	0.9539	0.9711	0.9643	0.9684	0.9644	0.8913	0.9263	0.9086	0.8318	0.9283
ite-wlsv-shr	0.9466	0.9700	0.9614	0.9665	0.9611	0.8897	0.9247	0.9071	0.8299	0.9257
ite-acov-shr	0.9528	0.9674	0.9627	0.9684	0.9628	0.8879	0.9257	0.9066	0.8297	0.9265
ite-sar1-shr	0.9469	0.9704	0.9611	0.9665	0.9612	0.8901	0.9246	0.9072	0.8300	0.9258
oct-wlsv	0.9589	0.9773	0.9712	0.9752	0.9706	0.8969	0.9339	0.9152	0.8404	0.9350
oct-bdshr	0.9552	0.9790	0.9632	0.9719	0.9673	0.8983	0.9288	0.9134	0.8364	0.9320
oct-acov	0.9631	0.9756	0.9729	0.9764	0.9720	0.8933	0.9356	0.9142	0.8383	0.9351
<i>63 bottom series</i>										
base	1	1	1	1	1	1	1	1	1	1
cs-shr	0.9917	0.9953	1.0002	1.0018	0.9972	0.9842	0.997	0.9906	0.9917	0.9945
t-wlsv	1.0022	0.9965	0.9953	0.9926	0.9967	0.9181	0.9611	0.9393	0.8727	0.9615
t-acov	0.9856	0.9896	1.0021	0.9951	0.9931	0.9023	0.9635	0.9324	0.8702	0.9571
t-sar1	1.0023	0.9968	0.9950	0.9926	0.9967	0.9183	0.9609	0.9393	0.8726	0.9615
kah-wlsv-shr	0.9930	0.9888	0.9875	0.9844	0.9884	0.9115	0.9559	0.9334	0.8703	0.9549
tcs-acov-shr	0.9751	0.9807	0.9953	0.9859	0.9842	0.8957	0.9582	0.9265	0.8680	0.9502
tcs-sar1-shr	0.9930	0.9891	0.9875	0.9844	0.9885	0.9117	0.9559	0.9335	0.8704	0.9550
ite-wlsv-shr	0.9898	0.9874	0.9869	0.9844	0.9871	0.9106	0.9568	0.9334	0.8699	0.9541
ite-acov-shr	0.9746	0.9819	0.9963	0.9878	0.9851	0.8965	0.9597	0.9276	0.8677	0.9509
ite-sar1-shr	0.9897	0.9879	0.9869	0.9844	0.9872	0.9109	0.9569	0.9336	0.8700	0.9542
oct-wlsv	0.9929	0.9901	0.9888	0.9870	0.9897	0.9133	0.9591	0.9360	0.8732	0.9568
oct-bdshr	1.0018	0.9925	0.9900	0.9892	0.9933	0.9178	0.9609	0.9391	0.8753	0.9600
oct-acov	0.9830	0.9869	0.9994	0.9937	0.9907	0.8981	0.9636	0.9303	0.8712	0.9554

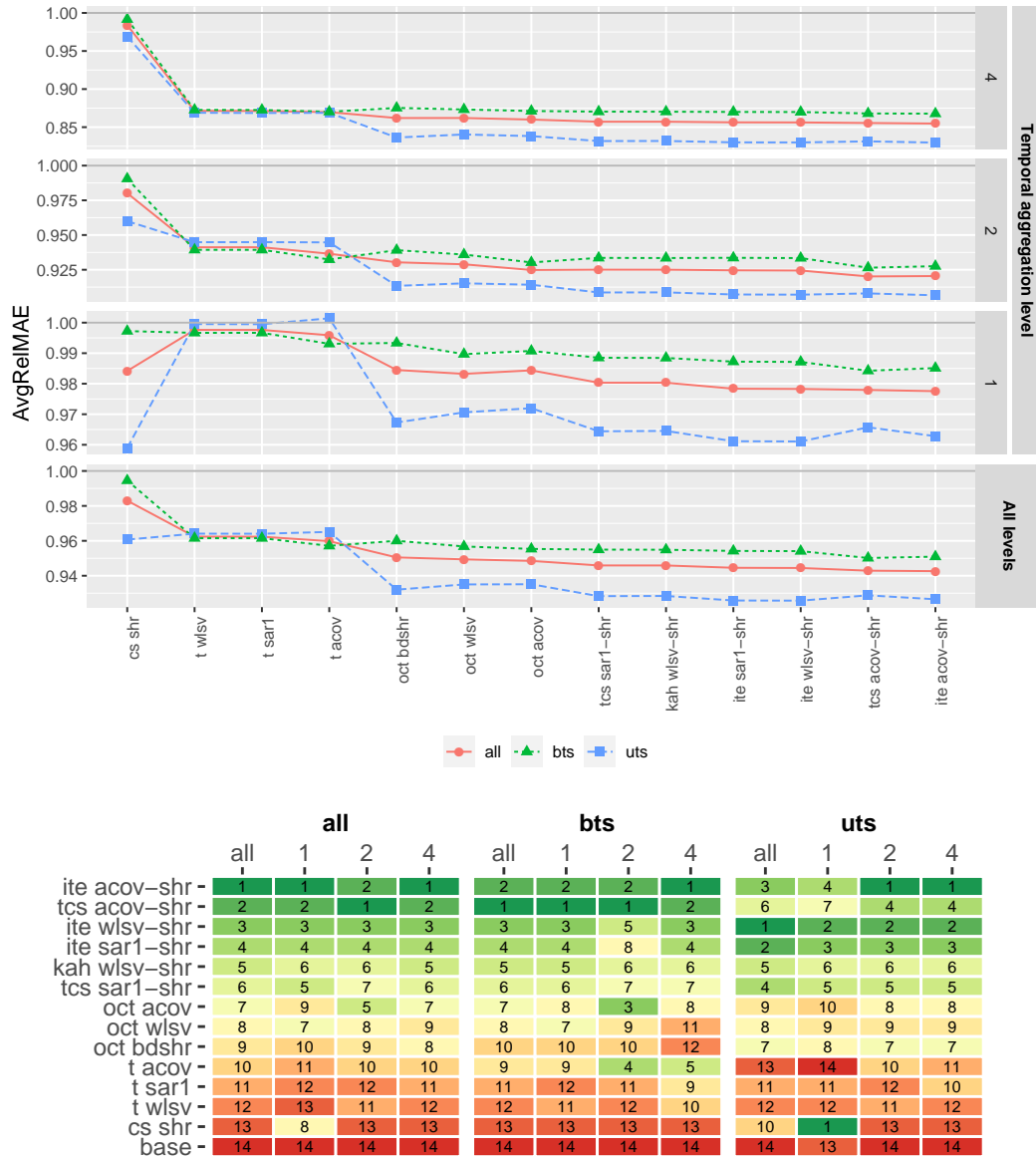

Figure A.4: Top panel: Average Relative MAE across all series and forecast horizons, by frequency of observation. Bottom panel: Rankings by frequency of observation and forecast horizon.

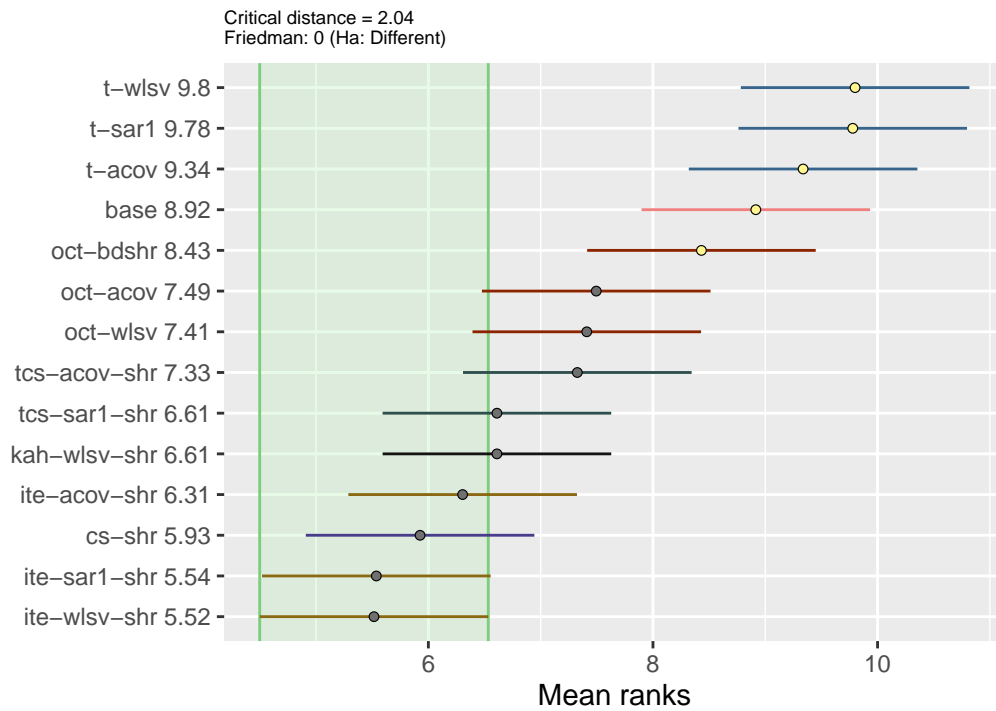
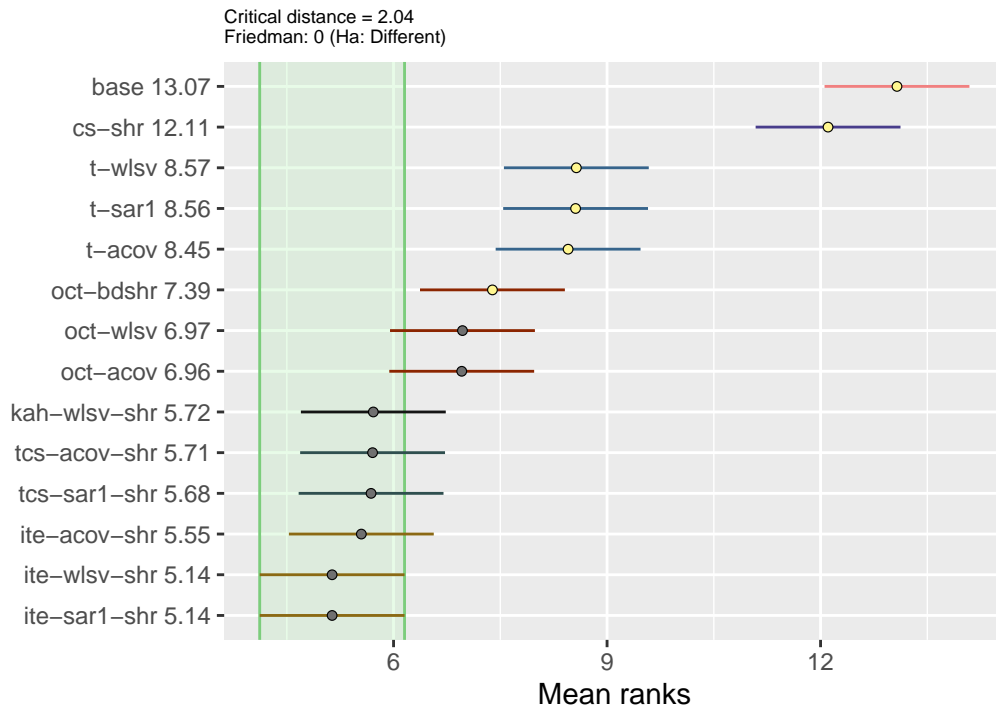

Figure A.5: Nemenyi test results at 5% significance level for all 95 series. The reconciliation procedures are sorted vertically according to the MAE mean rank (ii) across all time frequencies and forecast horizons (top), and (ii) for one-step-ahead quarterly forecasts (bottom).

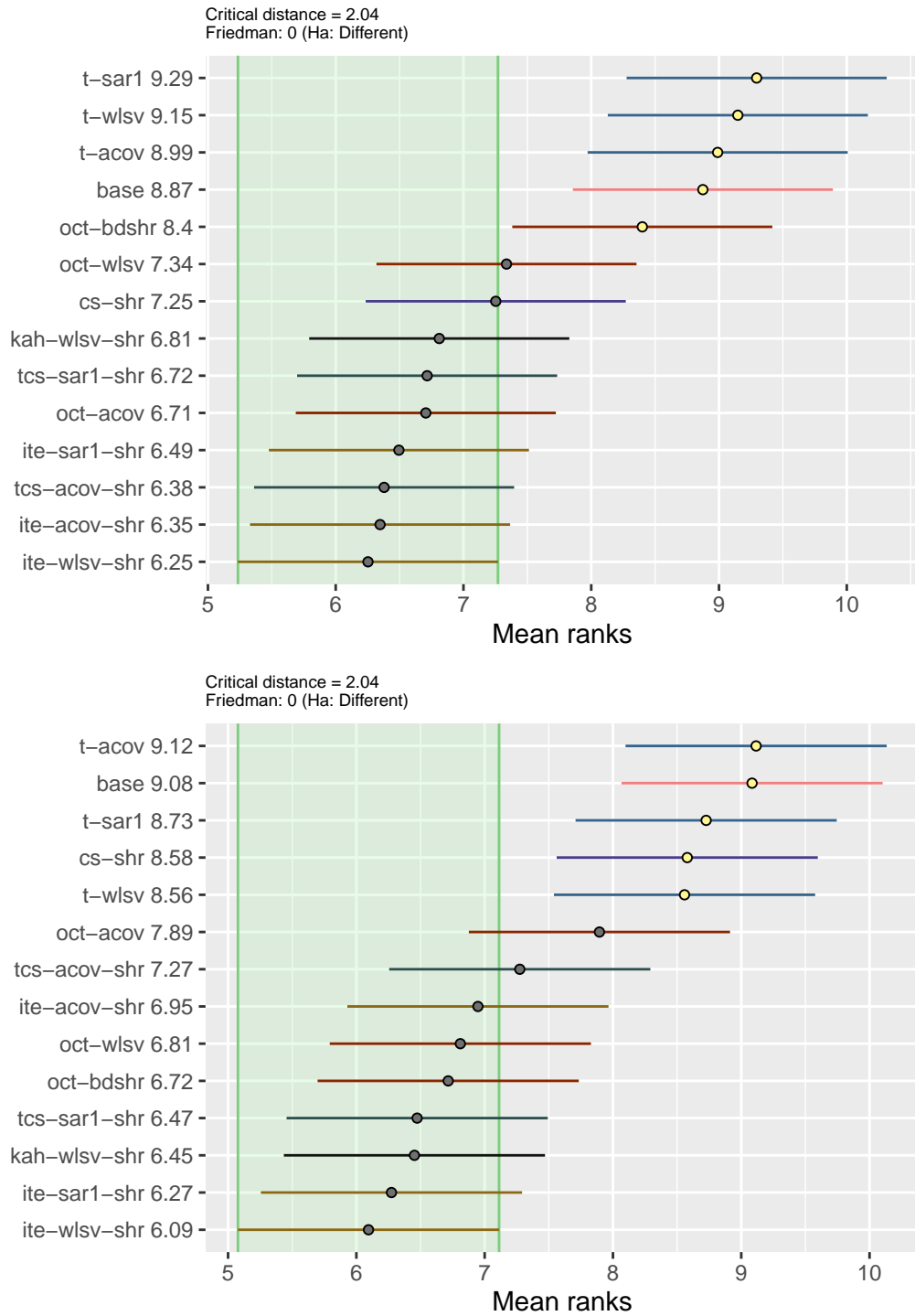

Figure A.6: Nemenyi test results at 5% significance level for all 95 series. The reconciliation procedures are sorted vertically according to the MSE mean rank for two-step-ahead (top) and three-step-ahead (bottom) quarterly forecasts.

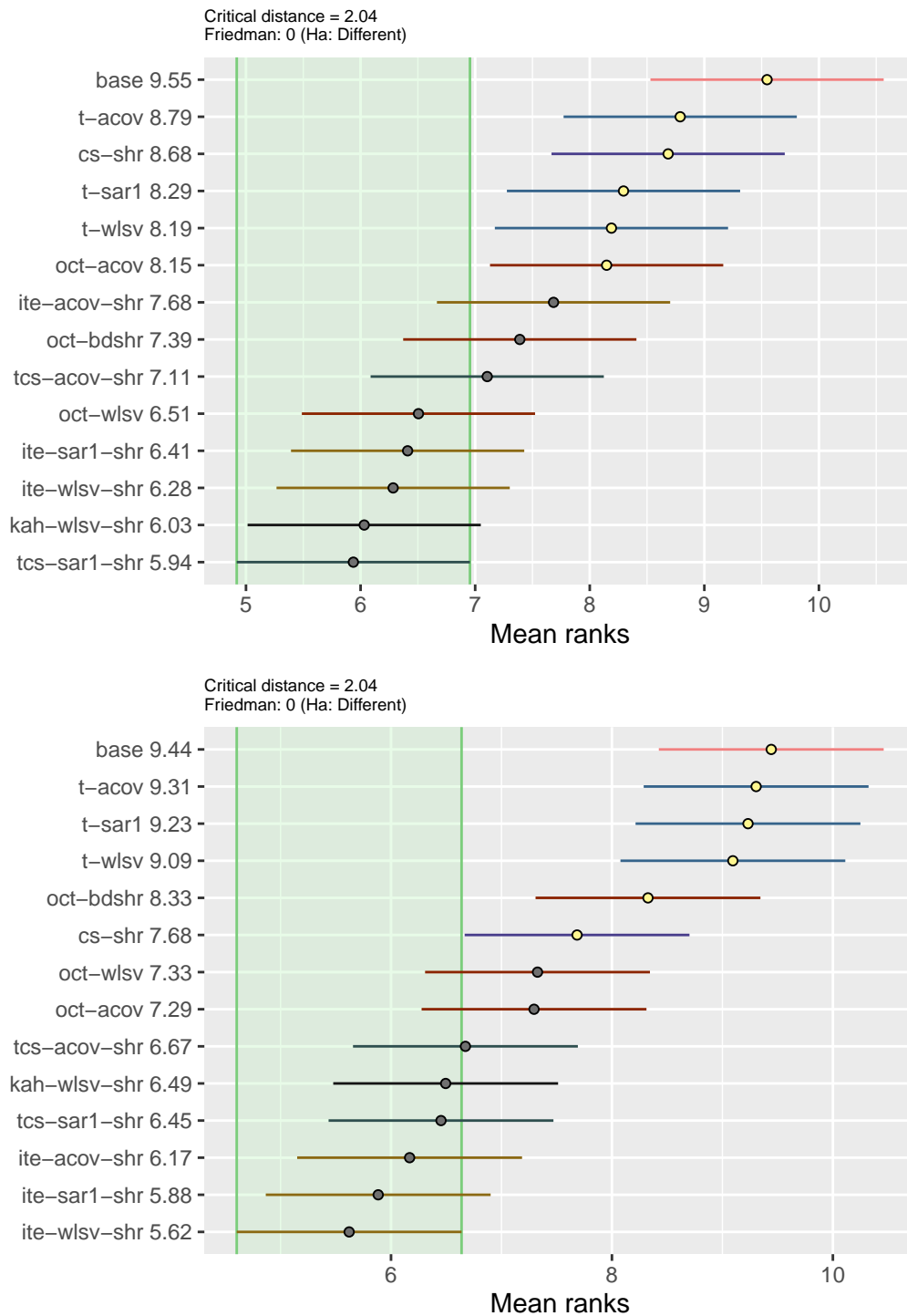

Figure A.7: Nemenyi test results at 5% significance level for all 95 series. The reconciliation procedures are sorted vertically according to the MSE mean rank for four-step-ahead (top) and one-to-four-step-ahead (bottom) quarterly forecasts.

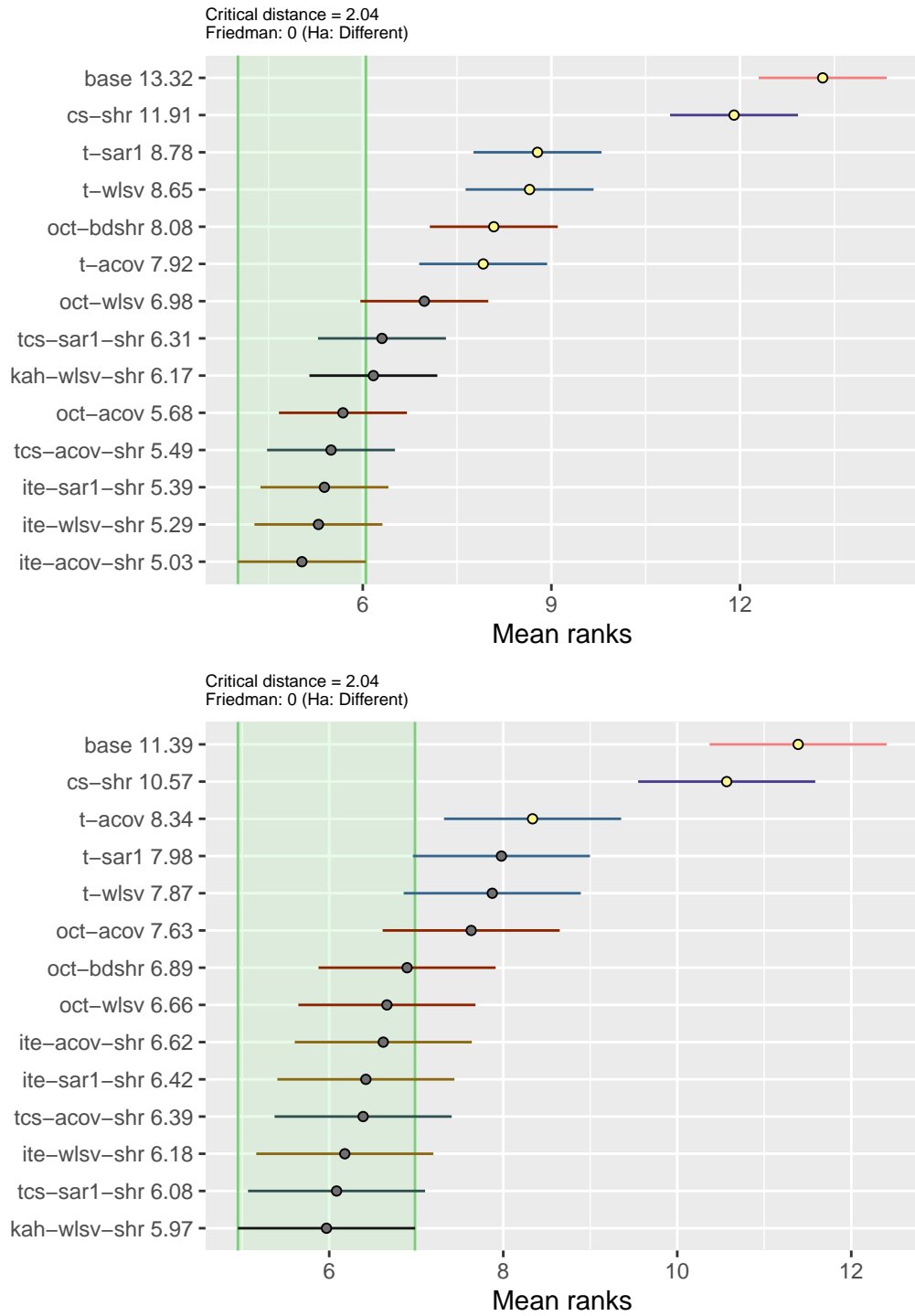

Figure A.8: Nemenyi test results at 5% significance level for all 95 series. The reconciliation procedures are sorted vertically according to the MSE mean rank for one-step-ahead (top) and two-step-ahead (bottom) six-months forecasts.

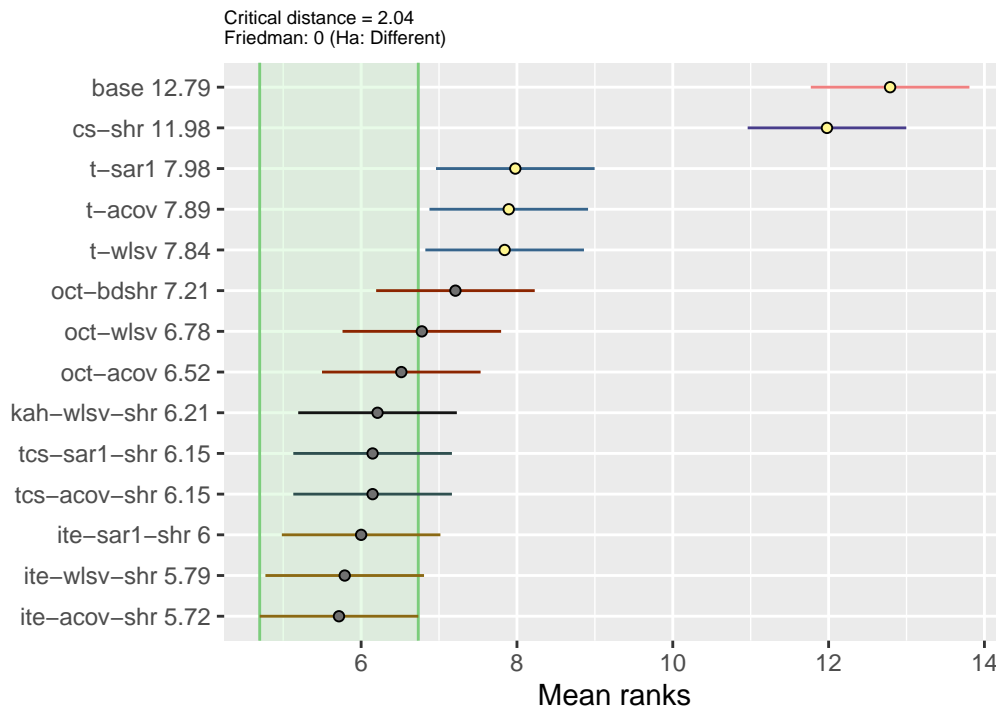
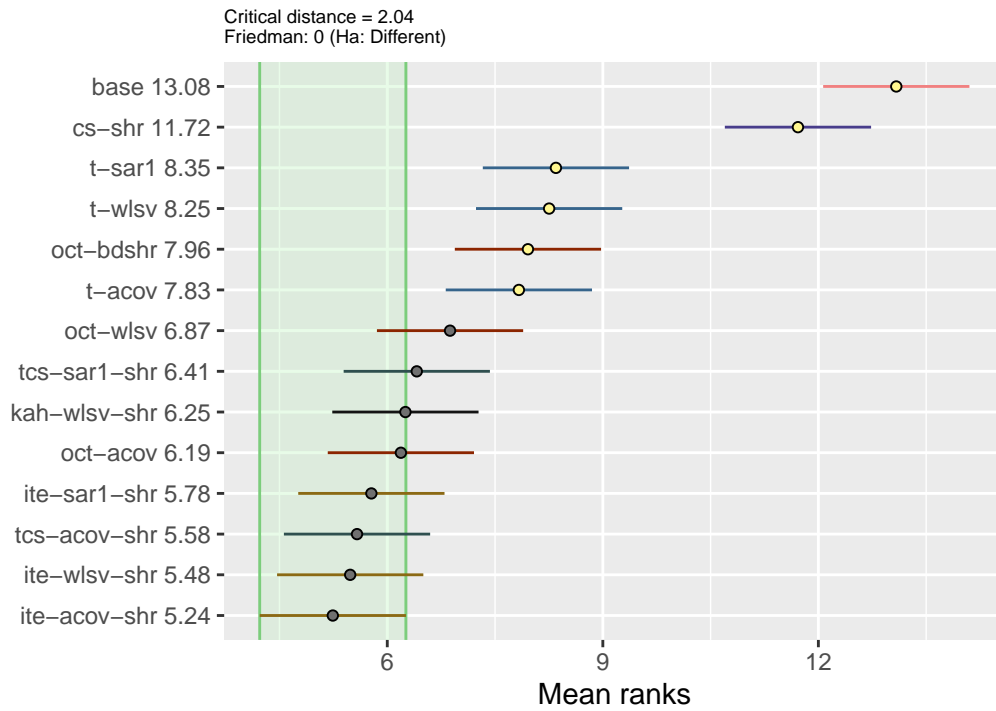

Figure A.9: Nemenyi test results at 5% significance level for all 95 series. The reconciliation procedures are sorted vertically according to the MSE mean rank for one-to-two-step-ahead (top) six-months forecasts and one-step-ahead twelve-months forecasts (bottom).

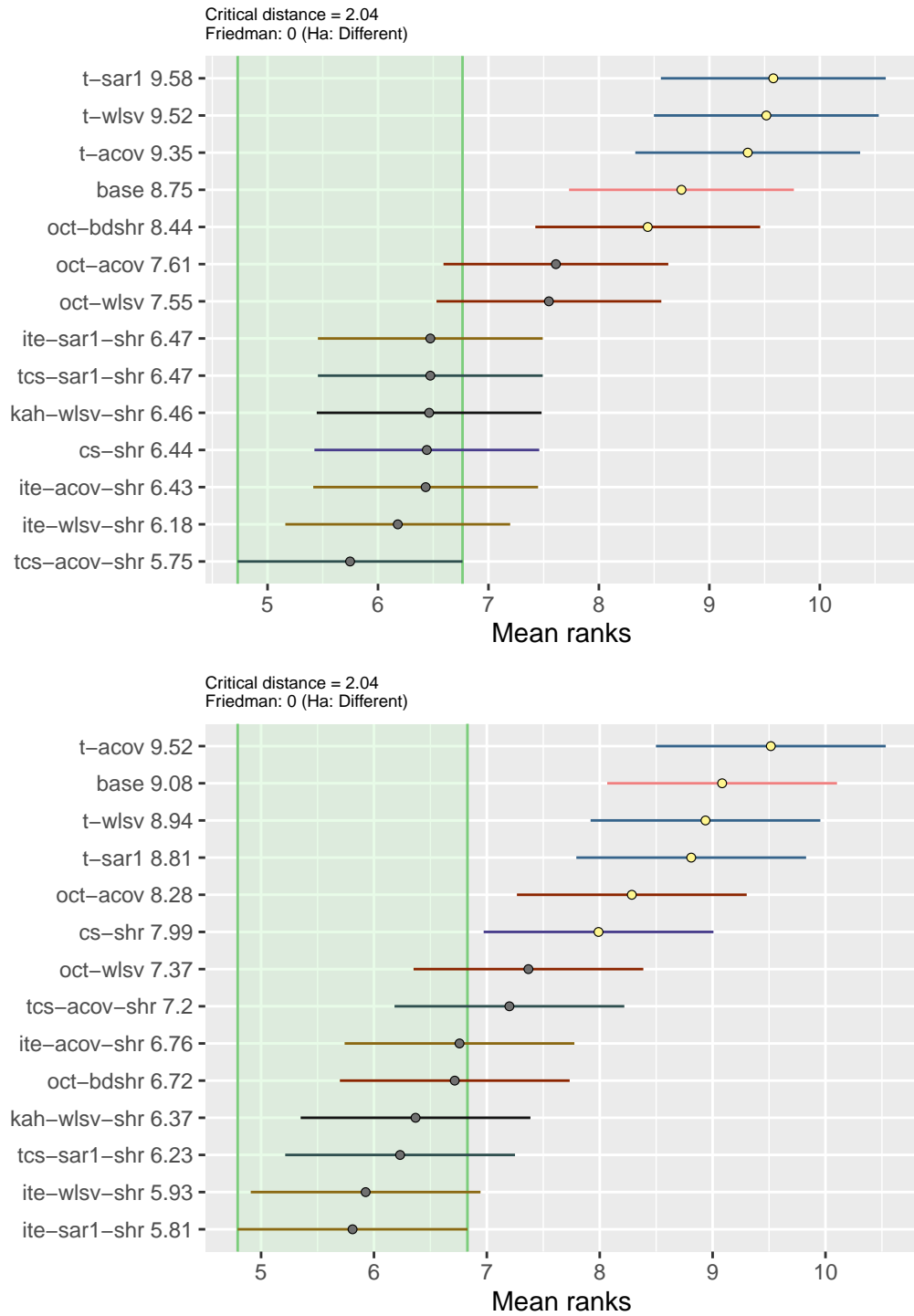

Figure A.10: Nemenyi test results at 5% significance level for all 95 series. The reconciliation procedures are sorted vertically according to the MAE mean rank for two-step-ahead (top) and three-step-ahead (bottom) quarterly forecasts.

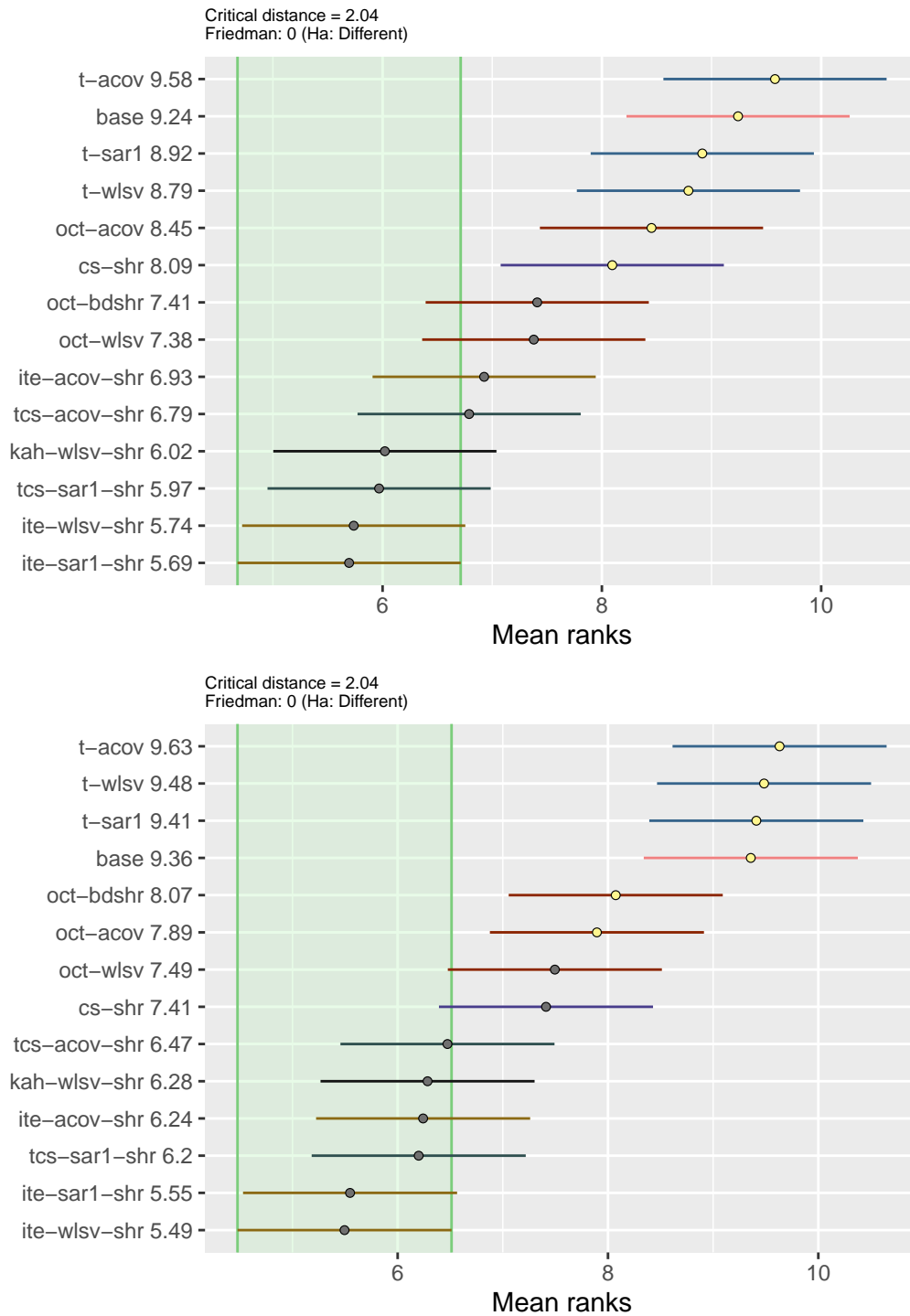

Figure A.11: Nemenyi test results at 5% significance level for all 95 series. The reconciliation procedures are sorted vertically according to the MAE mean rank for four-step-ahead (top) and one-to-four-step-ahead (bottom) quarterly forecasts.

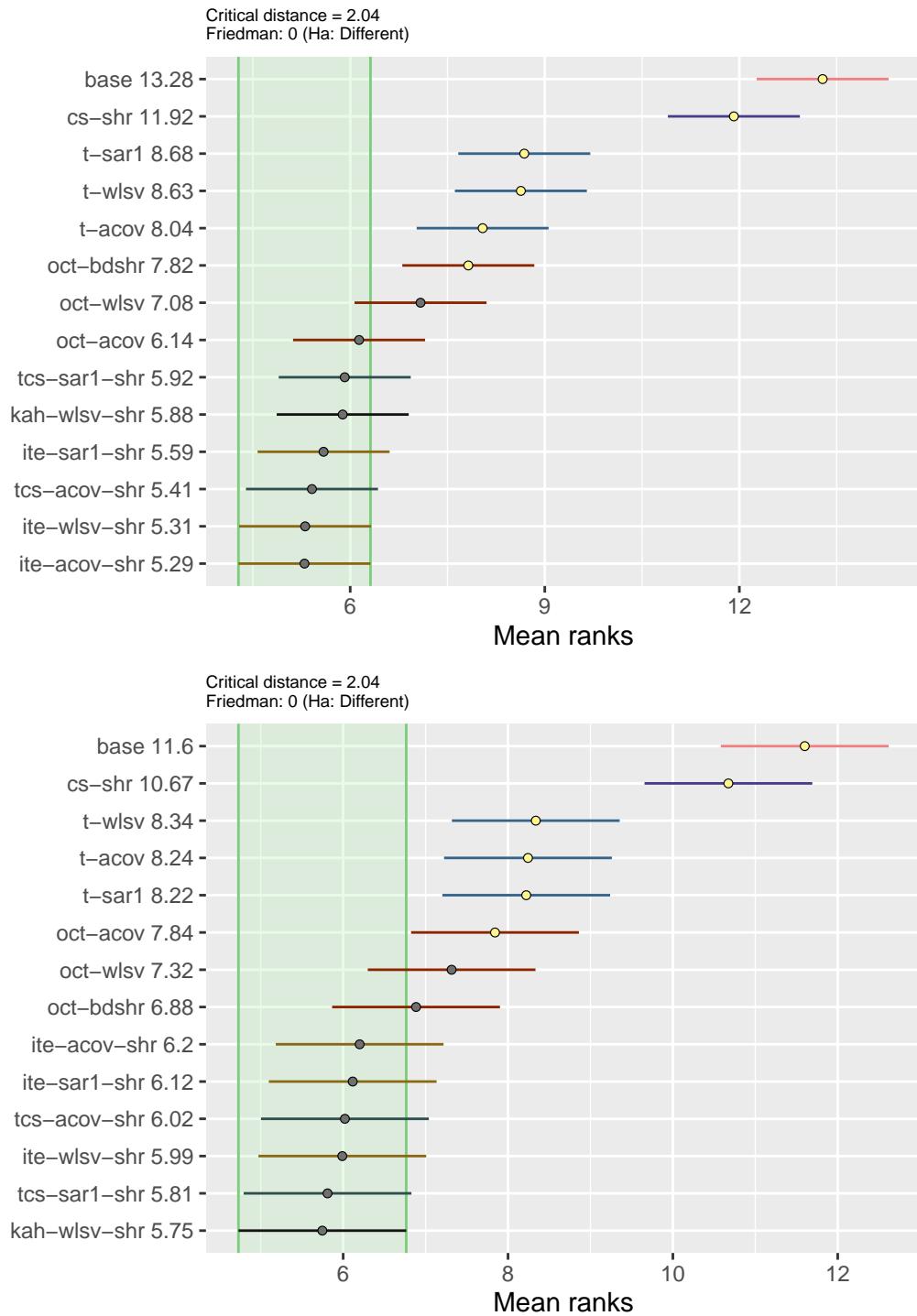

Figure A.12: Nemenyi test results at 5% significance level for all 95 series. The reconciliation procedures are sorted vertically according to the MAE mean rank for one-step-ahead (top) and two-step-ahead (bottom) six-months forecasts.

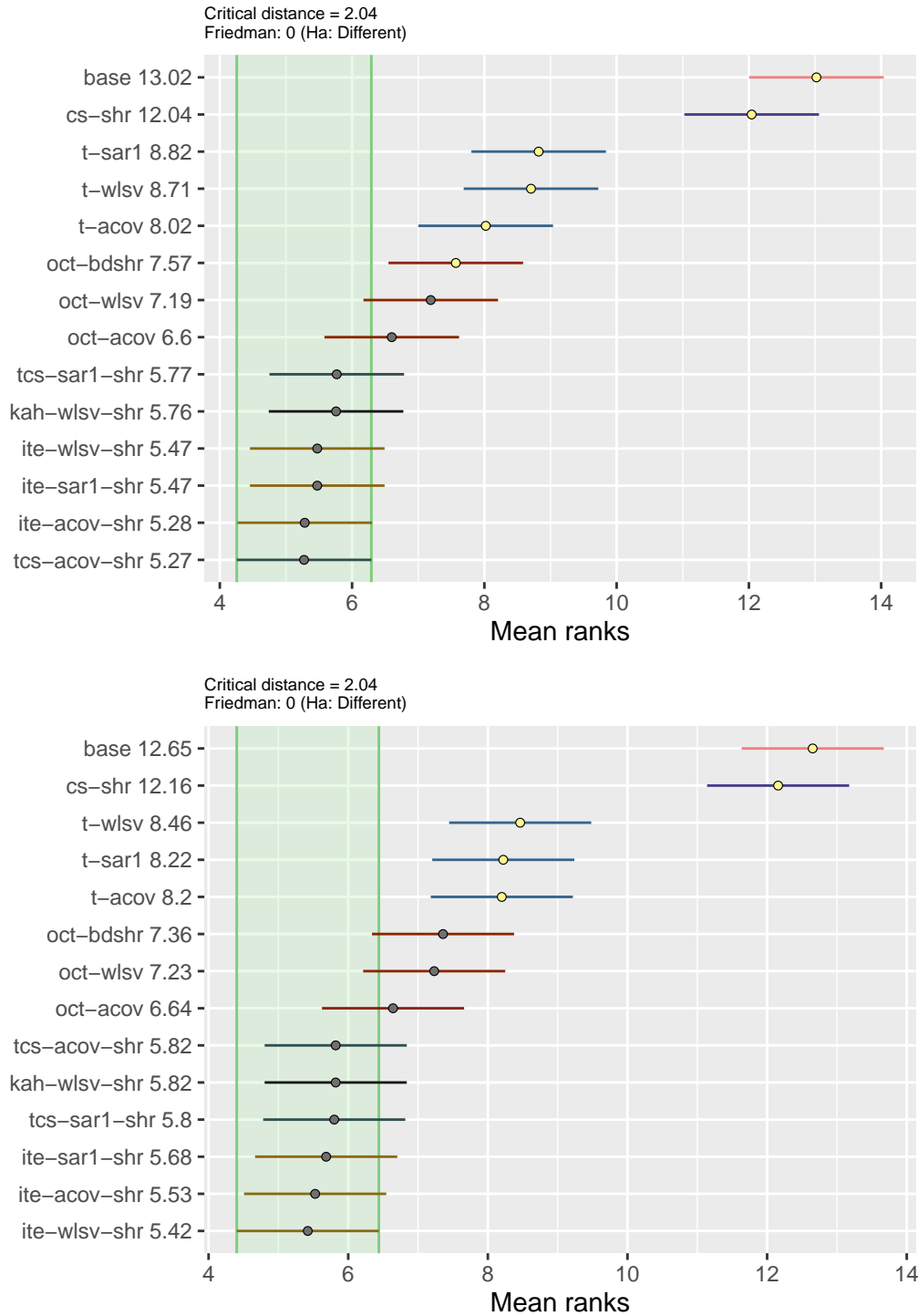

Figure A.13: Nemenyi test results at 5% significance level for all 95 series. The reconciliation procedures are sorted vertically according to the MAE mean rank for one-to-two-step-ahead (top) six-months forecasts and one-step-ahead twelve-months forecasts (bottom).

Table A.2: AvgRelMSE at any temporal aggregation level and any forecast horizon for all 95 time series and selected reconciliation procedures.

Series	Quarterly				Semi-annual			Annual	All	
	1	2	3	4	1-4	1	2	1-2		1
	<i>cs-shr</i>									
Gdp	0.9740	0.9397	0.9028	0.8924	0.9267	0.8382	0.8713	0.8546	0.7116	0.8719
Tfi	0.8316	0.9002	0.8769	0.8335	0.8600	0.8232	0.8760	0.8492	0.7162	0.8348
TfiGos	0.9170	0.8834	0.9140	0.9008	0.9037	1.0425	1.0489	1.0457	0.9354	0.9468
TfiCoe	0.9416	0.9880	1.0172	1.0112	0.9891	1.0519	1.0820	1.0669	1.0488	1.0192
TfiGosCop	0.8994	0.9722	1.0203	1.0302	0.9791	0.9818	1.0060	0.9938	1.0113	0.9879
TfiGosCopNfm	0.9562	0.9347	0.9420	0.9691	0.9504	0.9873	1.0029	0.9951	1.0170	0.9723
Gne	0.9243	0.9407	0.9212	0.8897	0.9188	0.9865	0.8728	0.9280	0.9302	0.9230
GneDfd	0.8713	0.9737	1.0182	0.9958	0.9631	0.9787	1.0192	0.9988	1.0038	0.9789
GneCii	1.0791	1.0228	1.0412	0.9250	1.0154	0.7215	0.8134	0.7661	0.8811	0.9181
GneDfdFce	0.8826	0.8184	0.8216	0.8223	0.8358	0.9482	0.9741	0.9611	0.9988	0.8923
GneDfdGfc	0.9442	0.9828	1.0156	1.0096	0.9876	1.0225	1.0185	1.0205	0.9719	0.9946
GneCiiPnf	0.9022	0.8656	0.9051	0.9528	0.9059	0.8407	0.8504	0.8455	0.8584	0.8814
GneDfdFceGvt	0.8352	0.8195	0.8463	0.9233	0.8552	0.8653	0.8642	0.8647	0.8716	0.8602
GneDfdFceHfc	0.9330	0.9655	0.9374	0.8885	0.9307	0.9677	0.9229	0.9451	0.8749	0.9266
GneDfdGfcPub	0.8485	0.9159	0.9178	0.9042	0.8961	0.8549	0.9234	0.8885	0.9637	0.9033
GneDfdGfcPvt	0.8293	0.8913	0.8665	0.9197	0.8761	0.9277	0.9635	0.9455	0.9939	0.9116
GneDfdFceGvtNat	0.9314	0.8758	0.9116	0.9399	0.9143	0.8944	0.9283	0.9112	0.9342	0.9163
GneDfdGfcPubGvt	0.8485	0.9301	0.8247	0.8911	0.8727	0.9150	0.8243	0.8685	0.8495	0.8681
GneDfdGfcPubPcp	1.0156	1.0273	0.9306	0.8908	0.9644	1.0143	0.9653	0.9895	0.7877	0.9438
GneDfdGfcPvtTdw	0.9404	0.9740	0.9568	0.9362	0.9517	0.8496	0.9688	0.9072	0.9665	0.9409
GneDfdGfcPvtPbi	0.8779	0.9021	0.9340	0.9710	0.9206	0.9080	1.0254	0.9649	0.8969	0.9296
GneDfdFceHfcAbt	1.1053	1.1137	1.1005	1.0772	1.0991	1.0458	1.0276	1.0366	0.8659	1.0447
GneDfdFceHfcMis	1.0375	1.0144	1.0850	1.1083	1.0607	0.9943	1.0618	1.0275	0.9926	1.0412
GneDfdFceHfcTpt	0.9166	0.9311	0.9593	0.9482	0.9387	0.8779	0.8693	0.8736	1.0199	0.9306
GneDfdFceHfcHcr	0.9639	0.9600	0.9805	0.9684	0.9682	0.9216	1.0225	0.9708	0.9956	0.9728
GneDfdFceHfcHlt	0.9584	0.9925	0.9567	0.9731	0.9701	0.9828	1.0071	0.9948	0.9833	0.9790
GneDfdFceHfcFhe	0.9458	0.9755	0.9515	0.9372	0.9524	0.9392	0.9103	0.9247	0.9233	0.9402
GneDfdFceHfcHwe	0.8682	0.8421	0.8023	0.8503	0.8404	0.7431	0.8147	0.7781	0.9994	0.8427
GneDfdGfcPubGvtNat	0.8614	0.8802	0.9402	0.9078	0.8969	1.0715	0.9802	1.0249	0.9607	0.9409
GneDfdGfcPvtPbiIpr	0.7457	0.7762	0.7669	0.7793	0.7669	0.8557	0.9102	0.8826	0.9911	0.8281
GneDfdGfcPvtPbiNdc	0.8342	0.8022	0.8466	0.8807	0.8404	0.7535	0.8158	0.7840	0.8256	0.8218
GneDfdGfcPvtPbiNdm	0.9785	0.9417	0.9523	0.9617	0.9585	0.8980	0.9013	0.8996	0.8933	0.9318
TfiGosCopNfmPub	1.0199	1.0458	1.0475	1.0741	1.0467	1.0165	0.9985	1.0074	1.0120	1.0303
TfiGosCopNfmPvt	0.9149	0.9766	0.9871	1.0472	0.9803	1.0269	1.0044	1.0156	0.9986	0.9929
TfiGosCopFim	1.0101	0.9985	0.9888	0.9845	0.9954	1.0028	1.0113	1.0071	1.0011	0.9996
TfiGosGvt	1.0396	1.0182	1.0046	1.0023	1.0161	0.9800	0.9729	0.9765	0.8773	0.9837
TfiGosDwl	0.9794	1.0005	0.9954	0.9927	0.9920	0.9875	0.9750	0.9813	0.8947	0.9744
TfiGmi	1.0569	1.0892	1.1426	1.1265	1.1033	1.0611	1.0894	1.0751	1.0325	1.0849
TfiCoeWns	0.9782	1.0048	1.0238	1.0464	1.0130	1.0497	1.0757	1.0626	1.0250	1.0287
TfiCoeEsc	0.9635	0.9746	0.9866	0.9909	0.9788	0.9925	1.0344	1.0133	1.0023	0.9919
Tsi	1.0094	1.0275	0.9765	0.9786	0.9978	0.9980	1.0066	1.0023	0.9908	0.9981
Sdi	0.9774	1.0322	1.0025	1.0600	1.0176	1.0374	1.0463	1.0419	1.0185	1.0246
GneDfdFceGvtNatNdf	0.9019	0.8936	0.9145	1.0108	0.9290	0.9290	0.9114	0.9202	0.8858	0.9202
GneDfdFceGvtNatDef	1.0172	1.0092	0.9755	0.9502	0.9877	0.9746	1.0200	0.9970	0.9937	0.9912
GneDfdFceGvtSnl	0.8689	0.8791	0.8737	0.8929	0.8786	0.8385	0.8418	0.8401	0.8738	0.8668
GneDfdGfcPubGvtNatNdf	1.0088	1.0748	1.0469	1.0725	1.0504	0.9931	1.0452	1.0188	1.0147	1.0362
GneDfdGfcPubGvtNatDef	0.9251	1.0844	1.1166	0.9711	1.0213	0.9261	0.9281	0.9271	1.0105	0.9919
GneDfdGfcPubGvtSnl	1.0144	1.0571	1.0871	1.1209	1.0692	0.9616	1.0536	1.0065	1.1600	1.0632
GneDfdGfcPubPcpCmw	1.0350	1.0360	1.0992	1.0905	1.0648	0.9930	0.9683	0.9806	0.9927	1.0296
GneDfdGfcPubPcpSnl	0.9308	0.9414	0.8722	0.8440	0.8962	0.8914	0.8616	0.8764	0.8955	0.8904
GneDfdGfcPvtTdwNnu	0.9714	0.9673	0.9850	0.9995	0.9807	0.9027	0.9781	0.9396	1.0376	0.9766
GneDfdGfcPvtTdwAna	0.9973	1.0733	1.0890	1.0954	1.0630	0.9352	0.9923	0.9633	0.9751	1.0209
GneDfdGfcPvtPbiIprRnd	1.0410	1.0137	1.0021	1.0082	1.0162	1.0362	0.9926	1.0142	0.9904	1.0119
GneDfdGfcPvtPbiIprMnp	1.0282	1.0304	1.0774	1.0953	1.0575	0.9267	1.0079	0.9664	1.0003	1.0225
GneDfdGfcPvtPbiIprCom	0.9789	0.9792	0.9906	0.9954	0.9860	0.9327	0.9847	0.9584	0.9131	0.9673
GneDfdGfcPvtPbiIprArt	1.0168	0.9899	0.9812	0.9770	0.9911	0.9827	0.9426	0.9624	0.9098	0.9709
GneDfdGfcPvtPbiNdcNbd	1.0444	1.0726	1.1079	1.0984	1.0805	1.0819	1.1597	1.1201	1.2492	1.1146
GneDfdGfcPvtPbiNdcNec	0.8576	0.8409	0.8613	0.8666	0.8566	0.8683	0.9379	0.9024	0.7908	0.8596
GneDfdGfcPvtPbiNdcSha	0.9030	0.9850	1.0448	1.1815	1.0236	0.9485	1.0223	0.9847	0.9950	1.0083
GneDfdGfcPvtPbiNdmNew	1.0204	0.9594	0.9690	0.9809	0.9822	0.8479	0.9178	0.8822	0.9295	0.9450
GneDfdGfcPvtPbiNdmSha	0.9575	0.9709	0.9964	0.9937	0.9795	0.9364	0.9699	0.9530	0.9527	0.9680
GneDfdGfcPvtPbiCbr	1.0485	1.0307	1.0059	0.9911	1.0188	0.9475	0.9735	0.9604	1.0226	1.0023
GneDfdGfcPvtOtc	0.9625	1.0052	0.9959	0.9987	0.9904	0.9382	0.9654	0.9517	0.9527	0.9738
GneDfdFceHfcAbtAlc	0.9614	0.9718	0.9494	0.9367	0.9547	0.9652	0.9597	0.9624	1.0157	0.9654

GneDfdFceHfcAbtCig	0.8864	0.9089	0.9201	0.9864	0.9247	0.9083	0.9672	0.9373	0.9889	0.9372
GneDfdFceHfcMisOgd	0.9932	0.9826	0.9538	0.9366	0.9663	1.0094	0.9896	0.9994	1.0034	0.9809
GneDfdFceHfcMisOsv	1.0009	0.9946	0.9920	0.9839	0.9929	0.9380	1.0020	0.9695	1.0061	0.9880
GneDfdFceHfcMisIfs	0.9113	0.9297	0.8367	0.8769	0.8879	0.8905	0.9017	0.8961	0.8831	0.8895
GneDfdFceHfcTptTsv	0.9585	0.9832	0.9686	0.9521	0.9655	1.0157	1.0761	1.0455	1.0196	0.9954
GneDfdFceHfcTptPvh	0.9766	0.9906	0.9845	1.0074	0.9897	0.9297	1.1746	1.0450	1.0152	1.0089
GneDfdFceHfcTptOvh	0.9588	0.9439	0.9461	0.9333	0.9455	1.0326	1.1102	1.0707	1.0268	0.9913
GneDfdFceHfcHcrAsv	1.0063	0.9681	0.9700	0.9930	0.9842	0.9942	0.9783	0.9862	0.9517	0.9801
GneDfdFceHfcHcrCsv	0.9911	1.0182	0.9957	0.9804	0.9962	0.9488	0.9600	0.9544	1.0401	0.9902
GneDfdFceHfcHltHsv	0.9338	0.9553	1.0182	1.0157	0.9801	0.9449	1.0121	0.9779	1.0487	0.9890
GneDfdFceHfcHltMed	0.9755	0.9461	0.9414	0.9314	0.9485	0.9614	0.9351	0.9481	0.8705	0.9368
GneDfdFceHfcFheFnt	0.9757	0.9771	1.0228	1.0246	0.9998	0.9338	1.0334	0.9823	1.0250	0.9983
GneDfdFceHfcFheTls	1.0127	1.0237	1.0182	1.0204	1.0187	1.0064	1.0279	1.0171	1.0150	1.0177
GneDfdFceHfcFheApp	1.0068	1.0628	1.0933	1.1253	1.0712	1.0588	1.0889	1.0737	1.0811	1.0733
GneDfdFceHfcHweRnt	1.0503	1.0086	0.9753	0.9865	1.0048	0.9564	0.9466	0.9514	0.8405	0.9643
GneDfdFceHfcHweWsc	0.9987	0.9743	0.9843	0.9373	0.9734	0.9896	0.9709	0.9802	0.9846	0.9769
GneDfdFceHfcHweEgf	0.9804	0.9604	1.0542	0.9820	0.9936	1.0035	0.9676	0.9854	1.0012	0.9923
GneDfdFceHfcFud	1.0237	1.0499	1.0661	1.0736	1.0532	1.0021	1.0415	1.0216	1.0127	1.0382
GneDfdFceHfcCnf	0.9780	1.0182	1.0440	1.0920	1.0322	0.9737	0.9937	0.9836	0.9415	1.0048
GneDfdFceHfcRnc	1.0043	1.0111	1.0043	0.9813	1.0002	0.9412	0.9951	0.9678	0.9970	0.9904
GneDfdFceHfcEdc	0.9643	0.9848	1.0157	1.0314	0.9987	1.0421	1.0207	1.0313	0.9721	1.0040
GneDfdFceHfcCom	1.0636	1.0687	1.0604	1.0527	1.0613	1.0210	1.0151	1.0181	1.0205	1.0429
GneCiiPnfMin	0.9405	0.9335	1.0162	1.0442	0.9824	0.9737	0.9801	0.9769	0.9975	0.9830
GneCiiPnfMan	1.0461	0.9593	1.0542	0.9686	1.0061	0.9138	0.9523	0.9329	1.0331	0.9884
GneCiiPnfWhl	0.9199	0.9863	0.9533	1.0492	0.9760	0.9142	0.9906	0.9517	0.9232	0.9613
GneCiiPnfRet	0.9933	0.9603	0.9555	1.0145	0.9806	0.9111	0.9663	0.9383	0.9230	0.9600
GneCiiPnfOnf	1.0092	1.0588	1.0119	0.9797	1.0145	0.9574	0.9446	0.9510	0.9423	0.9855
GneCiiPba	1.0316	1.0688	1.0553	1.1072	1.0654	1.2286	1.1593	1.1934	1.2484	1.1257
GneCiiPfm	0.9696	0.9319	0.9780	1.0003	0.9696	0.9931	1.0305	1.0116	1.0405	0.9914
Sde	0.9130	1.0615	1.0478	1.2256	1.0562	1.0290	1.1197	1.0734	1.0491	1.0601
ExpMinImp	0.9393	0.8813	0.9690	0.9741	0.9402	0.9531	1.0465	0.9987	1.1246	0.9813

t-cov

Gdp	1.0883	1.0356	1.0108	1.0000	1.0331	0.6539	0.8717	0.7549	0.6047	0.8750
Tfi	1.0434	1.0927	0.9971	0.9818	1.0279	0.7174	0.9408	0.8215	0.6636	0.9057
TfiGos	1.0180	0.9768	0.9760	0.9459	0.9789	0.8958	1.1015	0.9933	0.8807	0.9682
TfiCoe	1.0635	1.0506	1.0593	1.0365	1.0524	0.7474	0.8618	0.8026	0.5876	0.8962
TfiGosCop	1.0378	1.0000	0.9960	0.9865	1.0049	0.8140	0.9597	0.8839	0.8965	0.9530
TfiGosCopNfn	1.0499	0.9555	0.9591	0.9668	0.9821	0.8377	0.9968	0.9138	0.9346	0.9553
Gne	1.0197	1.0367	1.0113	1.0060	1.0184	0.8447	0.9008	0.8723	0.663	0.9164
GneDfd	0.9844	1.0002	1.0031	0.9851	0.9932	0.8656	0.9421	0.9030	0.6745	0.9146
GneCii	1.0382	1.0609	1.0032	0.9999	1.0253	0.6886	0.7098	0.6991	0.8996	0.9020
GneDfdFce	0.9956	1.0268	0.9982	1.0199	1.0100	0.8978	0.9456	0.9214	0.7540	0.9436
GneDfdGfc	0.9875	1.0066	0.9967	0.9653	0.9889	0.8881	1.0002	0.9425	0.7258	0.9333
GneCiiPnf	1.0114	0.9620	0.9996	1.0157	0.9970	0.8957	0.8850	0.8904	0.8775	0.9478
GneDfdFceGvt	0.9499	1.0178	1.0282	1.0061	1.0000	1.0279	0.9855	1.0065	0.8365	0.9766
GneDfdFceHfc	1.0526	1.0358	1.0393	1.0359	1.0409	0.7627	0.8180	0.7899	0.6042	0.8900
GneDfdGfcPub	1.0078	1.0358	0.9913	1.0219	1.0140	0.8665	0.9454	0.9051	0.9464	0.9720
GneDfdGfcPvt	0.9705	1.0131	0.9607	0.9764	0.9800	0.8832	1.0155	0.9471	0.7524	0.9345
GneDfdFceGvtNat	0.9844	0.9764	0.9518	1.0231	0.9836	0.9411	0.9616	0.9513	0.8894	0.9603
GneDfdGfcPubGvt	0.9673	1.0382	0.9615	0.9867	0.9880	0.9529	0.9684	0.9606	0.9090	0.9685
GneDfdGfcPubPep	0.9947	0.9799	0.9927	0.9701	0.9843	0.9801	1.0172	0.9985	0.8473	0.9674
GneDfdGfcPvtTdw	0.9560	1.0231	1.0117	0.9665	0.9889	0.7188	1.0576	0.8719	0.8164	0.9282
GneDfdGfcPvtPbi	0.9422	1.0148	0.9666	0.9791	0.9753	0.9489	1.0268	0.9871	0.6028	0.9137
GneDfdFceHfcAbt	1.0022	1.0410	0.9693	0.9819	0.9982	0.8696	0.9559	0.9117	0.8160	0.9451
GneDfdFceHfcMis	0.9414	0.9439	0.9639	0.9566	0.9514	0.8591	0.9058	0.8821	0.8453	0.9155
GneDfdFceHfcTpt	1.1538	1.1127	1.0889	1.1141	1.1171	0.6375	0.7133	0.6743	0.6718	0.8993
GneDfdFceHfcHcr	0.9815	0.9432	0.9465	0.9054	0.9438	0.9349	1.0194	0.9762	0.7304	0.9187
GneDfdFceHfcHlt	1.0026	1.0050	0.9752	0.9853	0.9919	0.9578	0.9716	0.9647	0.8579	0.9639
GneDfdFceHfcFhe	1.0178	1.0204	1.0583	1.0189	1.0287	0.8930	0.8827	0.8879	0.8427	0.9586
GneDfdFceHfcHwe	0.9810	1.0123	0.9876	1.0188	0.9998	0.7566	0.8855	0.8185	0.7001	0.8974
GneDfdGfcPubGvtNat	0.9666	0.9618	0.9437	0.9776	0.9623	1.0353	1.0110	1.0231	0.9088	0.9713
GneDfdGfcPvtPbiIpr	0.9296	1.0251	0.9736	0.9776	0.9759	0.8682	0.9559	0.9110	0.6231	0.8975
GneDfdGfcPvtPbiNdc	1.0089	1.0598	0.9970	1.0336	1.0245	0.9206	0.9468	0.9336	0.7006	0.9450
GneDfdGfcPvtPbiNdm	0.9422	1.0257	0.9510	0.9643	0.9703	0.9583	0.9934	0.9757	0.7851	0.9428
TfiGosCopNfnPub	1.0425	1.0218	1.0020	1.0324	1.0246	0.9427	0.9596	0.9511	0.7867	0.9659
TfiGosCopNfnPvt	0.9537	0.9788	0.9734	1.0187	0.9809	0.8281	0.9489	0.8864	0.8806	0.9383
TfiGosCopFin	0.9834	0.9890	0.9149	0.9177	0.9506	0.8531	1.0975	0.9676	0.8208	0.9356

TfiGosGvt	0.4874	0.7062	1.3241	1.0692	0.8355	0.244	0.7633	0.4316	0.2685	0.5883
TfiGosDwl	1.0092	0.9711	0.9639	1.0151	0.9896	0.8787	0.9649	0.9208	0.5876	0.8998
TfiGmi	1.0412	0.9778	0.9906	0.9929	1.0004	0.8936	0.9638	0.9280	0.8520	0.9569
TfiCoeWns	1.0779	1.0581	1.0743	1.0515	1.0654	0.7286	0.8438	0.7841	0.5622	0.8908
TfiCoeEsc	1.0415	1.0569	1.0257	1.0039	1.0318	0.7958	0.9304	0.8604	0.6295	0.9129
Tsi	0.9932	1.0096	1.0240	1.0014	1.0070	0.8515	0.8890	0.8700	0.7989	0.9344
Sdi	1.0270	1.0139	1.0706	1.0304	1.0353	0.9412	0.9247	0.9329	0.9245	0.9888
GneDfdFceGvtNatNdf	0.9154	0.9423	0.9137	0.9653	0.9339	0.9567	0.9529	0.9548	0.8692	0.9303
GneDfdFceGvtNatDef	1.0389	1.0349	0.9904	1.0028	1.0165	0.9605	1.0379	0.9985	0.8095	0.9790
GneDfdFceGvtSnl	0.9438	0.9842	0.9713	1.0017	0.9750	0.9753	0.9924	0.9838	0.7715	0.9454
GneDfdGfcPubGvtNatNdf	1.0410	1.0068	1.0061	1.0093	0.9933	0.9584	1.0275	0.9923	0.8943	0.9782
GneDfdGfcPubGvtNatDef	1.0314	1.1158	1.0319	0.8729	1.0090	0.8821	0.8533	0.8675	0.9159	0.9531
GneDfdGfcPubGvtSnl	1.0251	1.0126	0.9790	1.0698	1.0211	0.8180	0.8321	0.8250	0.9399	0.9494
GneDfdGfcPubPcpCmw	0.9298	1.0102	1.0371	1.0514	1.0060	1.0150	0.9429	0.9783	0.7066	0.9489
GneDfdGfcPubPcpSnl	1.0081	0.9931	1.0087	1.0092	1.0048	0.9227	0.9380	0.9303	0.9490	0.9749
GneDfdGfcPvtTdwNnu	0.9046	0.9569	1.0030	0.9827	0.9611	0.7050	1.0043	0.8414	0.8294	0.9060
GneDfdGfcPvtTdwAna	0.9843	1.0109	0.9807	0.9853	0.9902	0.8509	0.9812	0.9137	0.8709	0.9502
GneDfdGfcPvtPbiIprRnd	0.7073	0.8253	1.3471	1.0909	0.9624	0.3181	0.8063	0.5064	0.2933	0.6760
GneDfdGfcPvtPbiIprMnp	0.9554	0.9983	0.9907	0.9760	0.9800	0.8973	0.9476	0.9221	0.7118	0.9201
GneDfdGfcPvtPbiIprCom	0.6357	0.8213	1.2096	1.0202	0.8959	0.2781	0.7280	0.4500	0.3416	0.6412
GneDfdGfcPvtPbiIprArt	0.6910	0.7836	1.1864	1.0053	0.8964	0.3232	0.6995	0.4755	0.2986	0.6392
GneDfdGfcPvtPbiNdcNbd	0.9855	1.0170	1.0018	0.9717	0.9938	0.7785	0.9343	0.8528	0.7079	0.9063
GneDfdGfcPvtPbiNdcNec	1.0971	1.0102	0.9825	0.9679	1.0132	0.9550	1.0206	0.9872	0.5662	0.9255
GneDfdGfcPvtPbiNdcSha	1.0457	1.0051	1.0696	1.0124	1.0329	0.9186	0.9250	0.9218	0.9711	0.9911
GneDfdGfcPvtPbiNdmNew	0.9570	1.0298	0.9707	0.9780	0.9835	0.9024	0.9926	0.9464	0.7959	0.9438
GneDfdGfcPvtPbiNdmSha	1.0437	1.0508	1.0504	1.0498	1.0487	1.0250	0.9650	0.9945	0.8206	0.9974
GneDfdGfcPvtPbiChr	0.7960	0.8636	0.9434	0.8725	0.8673	0.5219	0.8547	0.6679	0.5959	0.7629
GneDfdGfcPvtOtc	0.9627	0.9930	0.9340	0.9533	0.9605	0.7681	1.0004	0.8766	0.7423	0.9019
GneDfdFceHfcAbtAlc	0.9900	0.9917	0.9602	0.9374	0.9696	0.9279	0.9956	0.9612	0.8519	0.9495
GneDfdFceHfcAbtCig	1.0116	1.0551	0.9750	0.9891	1.0073	0.8646	0.9455	0.9041	1.0213	0.9786
GneDfdFceHfcMisOgd	0.9259	0.9746	0.9213	0.8942	0.9285	0.8291	0.9768	0.9000	0.8362	0.9066
GneDfdFceHfcMisOsv	1.1103	1.0549	1.0473	1.0562	1.0669	0.8318	0.9096	0.8698	0.5861	0.9239
GneDfdFceHfcMisIfs	0.9822	0.9420	0.8998	0.8695	0.9224	0.9315	1.0134	0.9715	1.0126	0.9487
GneDfdFceHfcTptTsv	1.0897	1.0691	0.9921	1.0329	1.0453	0.8335	1.0183	0.9213	0.6491	0.9419
GneDfdFceHfcTptPvh	1.0468	1.0376	0.9908	0.9870	1.0152	0.8203	0.9516	0.8835	0.7898	0.9413
GneDfdFceHfcTptOvh	1.1163	1.0570	1.0129	1.0272	1.0526	0.7905	0.9479	0.8656	0.7336	0.9453
GneDfdFceHfcHcrAsv	1.0103	0.9544	0.9743	0.9939	0.9830	0.8901	0.9559	0.9224	0.8515	0.9457
GneDfdFceHfcHcrCsv	0.9536	0.9484	0.9459	0.9722	0.9550	0.9270	0.9916	0.9588	0.7984	0.9319
GneDfdFceHfcHltHsv	1.0322	0.9900	1.0044	0.9896	1.0039	0.9176	0.9640	0.9405	0.8349	0.9598
GneDfdFceHfcHltMed	0.9976	0.9995	0.9050	0.9541	0.9633	0.8910	1.0479	0.9663	0.9778	0.9662
GneDfdFceHfcFheFnt	1.0047	0.9998	1.0421	0.9720	1.0044	0.8929	0.8848	0.8888	0.8768	0.9513
GneDfdFceHfcFheTls	1.0325	1.0128	1.0344	1.0139	1.0234	0.8335	0.8957	0.8640	0.6574	0.9153
GneDfdFceHfcFheApp	1.0388	1.0319	1.0035	0.9839	1.0143	0.8606	0.9669	0.9122	0.8545	0.9602
GneDfdFceHfcHweRnt	1.0063	1.0079	1.0253	0.9862	1.0063	0.7058	0.7796	0.7418	0.3518	0.7937
GneDfdFceHfcHweWsc	0.9440	0.9331	0.9483	0.9748	0.9499	1.0327	1.0600	1.0463	0.7958	0.9521
GneDfdFceHfcHweEgf	0.9848	1.0469	1.0008	1.0597	1.0226	0.9043	0.9636	0.9335	0.8532	0.9709
GneDfdFceHfcFud	1.0381	0.9726	0.9393	0.9314	0.9694	0.7185	0.9565	0.8290	0.8166	0.9046
GneDfdFceHfcCnf	1.0143	0.9976	1.0031	0.9675	0.9955	0.9618	0.9568	0.9593	0.8478	0.9627
GneDfdFceHfcRnc	1.0338	0.9974	0.9740	0.9457	0.9872	0.9008	0.9849	0.9419	0.8525	0.9538
GneDfdFceHfcEdc	0.9950	0.9793	0.9625	1.0021	0.9846	0.9282	0.9884	0.9578	0.8492	0.9564
GneDfdFceHfcCom	1.0190	1.0567	0.9611	1.0370	1.0178	0.8069	0.8178	0.8123	0.7488	0.9134
GneCiiPnfMin	0.9753	0.9284	0.9598	0.9723	0.9588	0.9673	1.0214	0.9940	1.0562	0.9822
GneCiiPnfMan	0.9145	0.9535	0.9946	0.9483	0.9523	0.9395	0.8974	0.9182	0.9435	0.9412
GneCiiPnfWht	0.8916	0.9969	0.8985	1.0234	0.9508	0.8863	0.9461	0.9157	1.0117	0.9490
GneCiiPnfRet	0.9443	1.0114	0.9275	1.0118	0.9730	0.9429	0.9110	0.9269	1.0157	0.9655
GneCiiPnfOnf	1.0015	0.9978	0.9971	0.9990	0.9989	0.9319	0.8796	0.9054	1.0464	0.9777
GneCiiPnfPba	0.9725	0.8292	0.9508	0.8891	0.9086	0.8489	0.9688	0.9068	1.2867	0.9544
GneCiiPnfPfm	0.8621	0.8663	1.1989	1.0147	0.9763	0.8981	0.8647	0.8812	1.2032	0.9769
Sde	1.0104	1.0006	1.0103	0.9988	1.0050	0.8517	0.8966	0.8739	1.1513	0.9846
ExpMinImp	1.0340	0.9492	0.8963	0.8931	0.9415	0.8295	0.9644	0.8944	0.9541	0.9295
<i>kah-wlsv-shr</i>										
Gdp	1.1249	0.9876	0.9068	0.8719	0.9681	0.651	0.7698	0.7079	0.5485	0.8163
Tfi	0.9598	0.9523	0.8696	0.7984	0.8925	0.6353	0.7870	0.7071	0.5680	0.7829
TfiGos	0.9867	0.9139	0.8988	0.8717	0.9168	0.8572	1.0133	0.9320	0.8134	0.9055
TfiCoe	1.0893	1.0739	1.0886	1.0330	1.0709	0.7663	0.8726	0.8177	0.5932	0.9112
TfiGosCop	0.9628	1.0040	1.0012	0.9961	0.9909	0.8093	0.9700	0.8860	0.9061	0.9475
TfiGosCopNfn	1.0155	0.9532	0.9197	0.9371	0.9557	0.8268	0.9574	0.8897	0.8986	0.9282
Gne	0.9966	0.9959	0.9265	0.9017	0.9542	0.8284	0.8113	0.8198	0.6156	0.8583

GneDfd	0.9112	1.0152	1.0136	1.0039	0.9850	0.8184	0.9562	0.8846	0.6747	0.9049
GneCii	1.0204	1.0339	1.0163	0.9467	1.0037	0.6644	0.6795	0.6719	0.8369	0.8720
GneDfdFce	0.9370	0.9094	0.9000	0.8956	0.9104	0.8077	0.8395	0.8234	0.6708	0.8469
GneDfdGfc	0.9875	0.9790	0.9768	0.9663	0.9774	0.8480	0.9829	0.9130	0.7052	0.9149
GneCiiPnf	0.8501	0.8479	0.8625	0.9379	0.8738	0.7933	0.7834	0.7883	0.7799	0.8348
GneDfdFceGvt	0.8485	0.8657	0.8652	0.9246	0.8755	0.8663	0.8580	0.8621	0.7005	0.8443
GneDfdFceHfc	1.0250	1.0672	1.0255	0.9787	1.0236	0.7785	0.7895	0.7840	0.5944	0.8776
GneDfdGfcPub	0.8643	0.9285	0.9176	0.9409	0.9124	0.7842	0.8682	0.8251	0.8702	0.8806
GneDfdGfcPvt	0.8290	0.8952	0.8468	0.8916	0.8652	0.7773	0.9181	0.8448	0.6741	0.8292
GneDfdFceGvtNat	0.9086	0.9008	0.8933	0.9318	0.9085	0.8641	0.8978	0.8808	0.8124	0.8862
GneDfdGfcPubGvt	0.8599	0.9343	0.7932	0.8807	0.8655	0.8383	0.7961	0.8169	0.7544	0.8348
GneDfdGfcPubPcp	0.9938	0.9916	0.9119	0.9064	0.9500	0.9720	0.9471	0.9595	0.8065	0.9307
GneDfdGfcPvtTdw	0.9532	0.9844	0.9401	0.9095	0.9464	0.7186	0.9949	0.8455	0.7863	0.8925
GneDfdGfcPvtPbi	0.8625	0.9208	0.9430	0.9744	0.9242	0.8503	1.0061	0.9249	0.5682	0.8624
GneDfdFceHfcAbt	1.0867	1.0971	1.0349	1.0142	1.0576	0.9317	1.0186	0.9742	0.8757	1.0056
GneDfdFceHfcMis	0.9363	0.9543	1.0433	1.0801	1.0017	0.8615	1.0061	0.9310	0.9030	0.9666
GneDfdFceHfcTpt	1.1389	1.0709	1.0706	1.0513	1.0824	0.6258	0.6862	0.6553	0.6535	0.8726
GneDfdFceHfcHcr	0.9404	0.9255	0.9726	0.9357	0.9434	0.9331	1.0633	0.9961	0.7631	0.9296
GneDfdFceHfcHlt	0.9541	0.9869	0.9544	0.9794	0.9686	0.9389	0.9729	0.9557	0.8498	0.9470
GneDfdFceHfcPhe	0.9750	1.0099	0.9925	0.9514	0.9819	0.8601	0.8253	0.8425	0.7890	0.9110
GneDfdFceHfcHwe	0.8295	0.8210	0.7756	0.8306	0.8138	0.6030	0.6997	0.6495	0.5411	0.7198
GneDfdGfcPubGvtNat	0.9022	0.8630	0.9046	0.9082	0.8943	1.0159	0.9920	1.0039	0.8869	0.9232
GneDfdGfcPvtPbiIpr	0.7580	0.8055	0.7982	0.7986	0.7898	0.6854	0.7744	0.7286	0.489	0.7207
GneDfdGfcPvtPbiNdc	0.8078	0.7993	0.8344	0.8719	0.8279	0.7079	0.7977	0.7514	0.5697	0.7634
GneDfdGfcPvtPbiNdm	0.8987	0.9073	0.9094	0.9198	0.9088	0.8796	0.9345	0.9066	0.7301	0.8802
TfiGosCopNfnPub	1.0060	1.0175	1.0274	1.0445	1.0238	0.9281	0.9828	0.9550	0.7917	0.9674
TfiGosCopNfnPvt	0.9785	0.9978	0.9665	1.0179	0.9900	0.8523	0.9552	0.9023	0.8833	0.9485
TfiGosCopFin	0.9264	0.9412	0.8925	0.8960	0.9138	0.8303	1.0900	0.9513	0.8157	0.9095
TfiGosGvt	1.1884	1.0359	1.0207	0.9938	1.0571	0.4645	0.6590	0.5533	0.2945	0.7320
TfiGosDwl	0.9823	0.9730	0.9475	0.9691	0.9679	0.8750	0.9310	0.9026	0.5720	0.8801
TfiGmi	1.0383	1.0587	1.0928	1.0429	1.0580	0.9620	1.0476	1.0039	0.9309	1.0234
TfiCoeWns	1.1326	1.0899	1.0939	1.0650	1.0951	0.7574	0.8575	0.8059	0.5714	0.9142
TfiCoeEsc	1.0755	1.0422	1.0333	1.0126	1.0407	0.7990	0.9389	0.8661	0.6334	0.9199
Tsi	0.9740	1.0260	0.9856	0.9849	0.9924	0.8616	0.8601	0.8608	0.7764	0.9201
Sdi	0.9899	0.9956	1.0215	1.0257	1.0081	0.9388	0.9262	0.9324	0.9297	0.9745
GneDfdFceGvtNatNdf	0.8627	0.8833	0.8436	0.9268	0.8786	0.8964	0.9087	0.9025	0.8096	0.8751
GneDfdFceGvtNatDef	1.0128	1.0286	0.9698	0.9756	0.9964	0.9434	1.0131	0.9776	0.7918	0.9590
GneDfdFceGvtSnl	0.8297	0.8522	0.8584	0.8712	0.8528	0.8441	0.8636	0.8538	0.6632	0.8230
GneDfdGfcPubGvtNatNdf	0.9984	1.0601	1.0537	0.9853	1.0239	0.9624	1.0885	1.0235	0.9063	1.0061
GneDfdGfcPubGvtNatDef	0.9778	1.0456	1.0619	0.9103	0.9971	0.8483	0.9099	0.8785	0.9422	0.9539
GneDfdGfcPubGvtSnl	1.0391	1.0417	1.0757	1.1463	1.0748	0.8358	0.9376	0.8852	1.0145	1.0085
GneDfdGfcPubPcpCmw	0.9434	0.9811	1.0716	1.0479	1.0097	1.0529	0.9727	1.0120	0.7440	0.9672
GneDfdGfcPubPcpSnl	0.9395	0.9187	0.9069	0.8937	0.9146	0.8515	0.8228	0.8370	0.8352	0.8802
GneDfdGfcPvtTdwNnu	0.9612	0.9809	0.9787	0.9822	0.9757	0.7427	0.9949	0.8596	0.8502	0.9227
GneDfdGfcPvtTdwAna	0.9730	1.0340	1.0172	1.0286	1.0129	0.8620	1.0287	0.9416	0.9087	0.9767
GneDfdGfcPvtPbiIprRnd	1.1194	1.0564	1.0259	1.0202	1.0548	0.5016	0.6962	0.5910	0.3157	0.7524
GneDfdGfcPvtPbiIprMnp	0.9788	1.0103	1.0412	1.0450	1.0185	0.9161	1.0077	0.9608	0.7530	0.9593
GneDfdGfcPvtPbiIprCom	1.0296	0.9829	0.9779	0.9728	0.9905	0.4225	0.6540	0.5257	0.3746	0.7193
GneDfdGfcPvtPbiIprArt	1.0244	0.9931	0.9700	0.9428	0.9821	0.4625	0.6204	0.5356	0.3124	0.7012
GneDfdGfcPvtPbiNdcNbd	1.0989	1.1592	1.1435	1.0994	1.1249	0.8755	1.0669	0.9665	0.8077	1.0274
GneDfdGfcPvtPbiNdcNec	0.8632	0.8604	0.8526	0.8464	0.8556	0.7980	0.9080	0.8512	0.492	0.7894
GneDfdGfcPvtPbiNdcSha	0.9393	0.9627	1.0198	1.0385	0.9893	0.8678	0.9552	0.9105	0.9393	0.9589
GneDfdGfcPvtPbiNdmNew	0.9355	0.9320	0.9270	0.9451	0.9349	0.8382	0.9506	0.8926	0.7469	0.8935
GneDfdGfcPvtPbiNdmSha	0.9738	1.0117	1.0283	1.0081	1.0053	0.9461	0.9261	0.9360	0.7667	0.9476
GneDfdGfcPvtPbiCbr	0.9244	0.9264	0.9298	0.9169	0.9244	0.5896	0.8850	0.7224	0.6411	0.8176
GneDfdGfcPvtOtc	0.9763	0.9854	0.9268	0.9373	0.9561	0.7745	0.9964	0.8785	0.7430	0.9002
GneDfdFceHfcAbtAic	0.9680	0.9304	0.9003	0.8904	0.9218	0.8987	0.9342	0.9163	0.8099	0.9034
GneDfdFceHfcAbtCig	0.8942	0.9510	0.9008	0.9650	0.9272	0.7626	0.8869	0.8224	0.9193	0.8949
GneDfdFceHfcMisOgd	1.0316	0.9771	0.8980	0.8674	0.9413	0.8628	0.9555	0.9080	0.8347	0.9158
GneDfdFceHfcMisOsv	1.0683	1.0450	1.0414	1.0274	1.0454	0.8185	0.8957	0.8562	0.5773	0.9072
GneDfdFceHfcMisIfs	0.8070	0.8497	0.7680	0.8001	0.8057	0.8123	0.9076	0.8586	0.8851	0.8316
GneDfdFceHfcTptTsv	1.0496	1.0672	1.0126	1.0016	1.0324	0.8324	1.0180	0.9205	0.6518	0.9356
GneDfdFceHfcTptPvh	0.9780	0.9982	1.0136	1.0309	1.0050	0.7892	0.9984	0.8877	0.8114	0.9408
GneDfdFceHfcTptOvh	1.0781	1.0171	0.9848	0.9719	1.0122	0.7574	0.9082	0.8294	0.7045	0.9079
GneDfdFceHfcHcrAsv	1.0129	0.9481	0.9556	0.9626	0.9695	0.8891	0.9330	0.9108	0.8331	0.9319
GneDfdFceHfcHcrCstv	0.9482	0.9519	0.9571	0.9318	0.9472	0.9216	0.9765	0.9486	0.7862	0.9227
GneDfdFceHfcHltHsv	0.9672	0.9640	1.0386	1.0239	0.9979	0.8718	0.9848	0.9266	0.8337	0.9522
GneDfdFceHfcHltMed	0.9920	0.9395	0.8674	0.8693	0.9156	0.8571	0.9692	0.9114	0.8988	0.9120
GneDfdFceHfcPheFnt	0.9936	0.9878	1.0581	1.0217	1.0149	0.8918	0.9431	0.9171	0.9247	0.9729
GneDfdFceHfcPheTls	1.0526	1.0407	1.0544	1.0354	1.0457	0.8555	0.9198	0.8871	0.6782	0.9379
GneDfdFceHfcPheApp	1.0651	1.1067	1.0606	1.0882	1.0800	0.9213	1.0611	0.9887	0.9346	1.0316

GneDfdFceHfcHweRnt	1.1249	1.0070	0.9527	0.9535	1.0072	0.7317	0.7403	0.7360	0.3396	0.7884
GneDfdFceHfcHweWsc	0.9278	0.8946	0.8863	0.9039	0.9030	0.9905	1.0043	0.9973	0.7529	0.9052
GneDfdFceHfcHweEgf	0.9421	0.9792	0.9894	0.9650	0.9687	0.8533	0.9184	0.8853	0.8144	0.9210
GneDfdFceHfcFud	1.0435	1.0365	0.9907	0.9714	1.0101	0.7503	1.0102	0.8706	0.8632	0.9466
GneDfdFceHfcCnf	0.9746	1.0060	0.9876	0.9926	0.9901	0.9570	0.9684	0.9627	0.8526	0.9614
GneDfdFceHfcRnc	0.9749	0.9896	0.9583	0.9592	0.9704	0.8803	0.9830	0.9302	0.8437	0.9398
GneDfdFceHfcEdc	1.0082	0.9805	0.9827	1.0081	0.9948	0.9367	1.0012	0.9684	0.8615	0.9671
GneDfdFceHfcCom	1.0925	1.0582	1.0683	1.0551	1.0684	0.8563	0.8699	0.8631	0.7969	0.9640
GneCiiPnfMin	0.9377	0.8841	0.9428	0.9264	0.9224	0.9394	0.9824	0.9607	1.0198	0.9467
GneCiiPnfMan	0.9430	0.9251	0.9609	0.9602	0.9472	0.9170	0.8988	0.9079	0.9215	0.9321
GneCiiPnfWht	0.7980	0.9312	0.8766	0.9580	0.8888	0.8230	0.9124	0.8666	0.9199	0.8867
GneCiiPnfRet	0.9031	0.9505	0.8642	0.9907	0.9259	0.8784	0.8738	0.8761	0.9632	0.9166
GneCiiPnfOnf	1.0213	0.9987	0.9996	0.9824	1.0004	0.9445	0.8540	0.8981	1.0200	0.9728
GneCiiPba	0.9935	0.9250	0.9422	0.9341	0.9483	0.9923	1.0497	1.0206	1.7805	1.0596
GneCiiPfm	0.8704	0.8621	1.0791	1.0098	0.9509	0.8902	0.8407	0.8651	1.1774	0.9543
Sde	0.9570	1.0176	0.9798	1.0568	1.0021	0.8473	0.9905	0.9161	1.3012	1.0138
ExpMinImp	1.0178	0.8726	0.9322	0.9092	0.9315	0.7708	0.9876	0.8725	0.9505	0.9169
<i>ite-acov-shr</i>										
Gdp	1.0503	0.9808	0.9027	0.8853	0.9526	0.6281	0.7730	0.6968	0.5427	0.8039
Tfi	0.8995	0.9428	0.8663	0.8134	0.8792	0.6141	0.7909	0.6969	0.5642	0.7722
TfiGos	0.9673	0.8943	0.8985	0.8810	0.9097	0.8338	1.0147	0.9199	0.8083	0.8973
TfiCoe	1.0060	1.0417	1.0778	1.0668	1.0477	0.7326	0.8859	0.8056	0.5931	0.8961
TfiGosCop	0.9469	0.9853	1.0014	1.0065	0.9847	0.7892	0.9713	0.8755	0.9006	0.9401
TfiGosCopNfn	1.0063	0.9287	0.9271	0.9560	0.9540	0.8066	0.9684	0.8838	0.8988	0.9255
Gne	0.9723	0.9925	0.9155	0.9094	0.9467	0.8244	0.8158	0.8201	0.6156	0.8545
GneDfd	0.8843	1.0014	1.0049	1.0161	0.9751	0.8119	0.9662	0.8857	0.6758	0.9003
GneCii	1.0317	1.0239	0.9908	0.9285	0.9929	0.6776	0.6676	0.6726	0.8407	0.8674
GneDfdFce	0.9263	0.8804	0.8963	0.8913	0.8984	0.7861	0.8331	0.8093	0.6593	0.8343
GneDfdGfc	0.9524	0.9827	0.9651	0.9859	0.9714	0.8453	0.9973	0.9182	0.7097	0.9140
GneCiiPnf	0.8666	0.8509	0.8404	0.9291	0.8711	0.8035	0.7587	0.7808	0.7786	0.8308
GneDfdFceGvt	0.8454	0.8445	0.8649	0.9338	0.8714	0.8451	0.8558	0.8504	0.6878	0.8366
GneDfdFceHfc	1.0162	1.0394	1.0147	0.9684	1.0093	0.7623	0.7784	0.7703	0.5828	0.8638
GneDfdGfcPub	0.8709	0.9452	0.9147	0.8984	0.9069	0.7924	0.8516	0.8215	0.8647	0.8756
GneDfdGfcPvt	0.8405	0.9016	0.8503	0.9082	0.8746	0.7809	0.9325	0.8533	0.6798	0.8378
GneDfdFceGvtNat	0.9130	0.8756	0.8912	0.9447	0.9058	0.8549	0.8896	0.8720	0.8011	0.8804
GneDfdGfcPubGvt	0.8371	0.9725	0.7800	0.8719	0.8626	0.8439	0.7915	0.8173	0.7567	0.8337
GneDfdGfcPubPcp	1.0211	0.9864	0.9330	0.8628	0.9489	0.9778	0.9312	0.9542	0.8001	0.9275
GneDfdGfcPvtTdw	0.8821	0.9746	0.9697	0.9299	0.9383	0.6893	1.0221	0.8393	0.7878	0.8865
GneDfdGfcPvtPbi	0.8743	0.9179	0.9281	0.9910	0.9269	0.8449	1.0104	0.9239	0.5654	0.8629
GneDfdFceHfcAbt	1.0924	1.1226	1.0503	1.0058	1.0669	0.9450	1.0234	0.9834	0.8878	1.0153
GneDfdFceHfcMis	0.9939	0.9567	1.0443	1.0663	1.0144	0.8831	0.9964	0.9380	0.9047	0.9759
GneDfdFceHfcTpt	1.1068	1.0590	1.0422	1.0518	1.0647	0.6126	0.6776	0.6443	0.6419	0.8580
GneDfdFceHfcHcr	0.9414	0.9096	0.9626	0.9247	0.9344	0.9234	1.0441	0.9819	0.7512	0.9186
GneDfdFceHfcHlt	0.9491	0.9810	0.9434	0.9751	0.9620	0.9233	0.9625	0.9427	0.8377	0.9377
GneDfdFceHfcFhe	0.9650	0.9910	1.0171	0.9350	0.9765	0.8504	0.8164	0.8332	0.7804	0.9038
GneDfdFceHfcHwe	0.8474	0.8519	0.7860	0.8663	0.8373	0.6165	0.7217	0.6670	0.5547	0.7398
GneDfdGfcPubGvtNat	0.8976	0.8804	0.8753	0.8914	0.8861	1.0092	0.9717	0.9903	0.8826	0.9142
GneDfdGfcPvtPbiIpr	0.6879	0.7129	0.8399	0.7943	0.7563	0.6014	0.7899	0.6892	0.4661	0.6873
GneDfdGfcPvtPbiNdc	0.8620	0.8151	0.8412	0.8780	0.8487	0.7123	0.7993	0.7546	0.5685	0.7750
GneDfdGfcPvtPbiNdm	0.8808	0.9430	0.8947	0.9102	0.9069	0.8773	0.9175	0.8972	0.7217	0.8751
TfiGosCopNfnPub	1.0362	1.0450	1.0366	1.0539	1.0429	0.9479	0.9834	0.9654	0.7965	0.9816
TfiGosCopNfnPvt	0.9629	0.9729	0.9712	1.0374	0.9857	0.8290	0.9636	0.8937	0.8806	0.9432
TfiGosCopFin	0.9972	0.9786	0.8963	0.8999	0.9419	0.8536	1.0729	0.9570	0.8119	0.9263
TfiGosGvt	0.5358	0.7129	1.3109	1.0656	0.8547	0.2511	0.7581	0.4363	0.2687	0.5978
TfiGosDwl	1.0001	0.9626	0.9489	0.9914	0.9755	0.8734	0.9451	0.9086	0.5766	0.8867
TfiGmi	1.1342	1.0692	1.1044	1.0804	1.0967	0.9891	1.0765	1.0319	0.9637	1.0581
TfiCoeWns	1.0448	1.0563	1.0847	1.1042	1.0722	0.7223	0.8731	0.7941	0.5722	0.8996
TfiCoeEsc	0.9991	1.0325	1.0185	1.0098	1.0149	0.7818	0.9317	0.8535	0.6263	0.9015
Tsi	0.9819	1.0379	0.9905	0.9725	0.9954	0.8496	0.8509	0.8503	0.7685	0.9171
Sdi	0.9996	1.0017	1.0261	1.0335	1.0151	0.9619	0.9287	0.9452	0.9430	0.9842
GneDfdFceGvtNatNdf	0.8543	0.8603	0.8333	0.9455	0.8723	0.8836	0.9082	0.8958	0.8011	0.8683
GneDfdFceGvtNatDef	1.0334	1.0215	0.9856	0.9549	0.9984	0.9510	1.0063	0.9783	0.7901	0.9600
GneDfdFceGvtSnl	0.8522	0.8550	0.8711	0.8852	0.8658	0.8400	0.8751	0.8574	0.6613	0.8308
GneDfdGfcPubGvtNatNdf	1.0439	1.0364	1.0495	0.8870	1.0018	0.9719	1.0724	1.0209	0.9191	0.9949
GneDfdGfcPubGvtNatDef	0.9707	1.1055	1.0034	0.8721	0.9844	0.8412	0.8641	0.8525	0.9461	0.9394
GneDfdGfcPubGvtSnl	1.0106	1.0769	1.0823	1.1501	1.0788	0.8436	0.9434	0.8921	1.0235	1.0141
GneDfdGfcPubPcpCmw	0.9304	1.0180	1.0428	1.0574	1.0109	1.0800	0.9793	1.0284	0.7536	0.9741
GneDfdGfcPubPcpSnl	0.9669	0.9090	0.9206	0.8554	0.9121	0.8540	0.8050	0.8291	0.8238	0.8748
GneDfdGfcPvtTdwNnu	0.8792	0.9471	1.0114	0.9946	0.9567	0.6944	1.0151	0.8396	0.8379	0.9043
GneDfdGfcPvtTdwAna	0.9532	1.0602	1.0387	1.0497	1.0245	0.8679	1.0535	0.9562	0.9289	0.9906

GneDfdGfcPvtPbiIprRnd	0.7186	0.8211	1.3404	1.0933	0.9643	0.3203	0.8051	0.5078	0.2956	0.6781
GneDfdGfcPvtPbiIprMnp	0.9702	1.0647	1.0146	1.0348	1.0205	0.9229	0.9941	0.9579	0.7514	0.9593
GneDfdGfcPvtPbiIprCom	0.6086	0.8125	1.2119	1.0191	0.8840	0.2733	0.7282	0.4461	0.3397	0.6343
GneDfdGfcPvtPbiIprArt	0.7032	0.7705	1.1453	0.9671	0.8802	0.3217	0.6735	0.4655	0.2882	0.6255
GneDfdGfcPvtPbiNdcNbd	1.0485	1.1286	1.1367	1.0777	1.0973	0.8485	1.0544	0.9459	0.7934	1.0041
GneDfdGfcPvtPbiNdcNec	0.8956	0.8537	0.8668	0.8709	0.8716	0.8109	0.9229	0.8651	0.5003	0.8034
GneDfdGfcPvtPbiNdcSha	0.9375	1.0458	1.0399	1.1169	1.0330	0.8758	0.9709	0.9221	0.9583	0.9894
GneDfdGfcPvtPbiNdmNew	0.9321	0.9600	0.9147	0.9322	0.9346	0.8370	0.9358	0.8850	0.7396	0.8899
GneDfdGfcPvtPbiNdmSha	0.9776	1.0359	1.0257	1.0135	1.0129	0.9609	0.9321	0.9464	0.7747	0.9561
GneDfdGfcPvtPbiCbr	0.8155	0.8778	0.9476	0.8536	0.8723	0.5334	0.8462	0.6718	0.5956	0.7666
GneDfdGfcPvtOtc	0.9320	0.9956	0.9249	0.9536	0.9511	0.7648	1.0003	0.8746	0.7426	0.8964
GneDfdFceHfcAbtAlc	0.9518	0.9601	0.9464	0.8789	0.9337	0.9049	0.9437	0.9241	0.8143	0.9129
GneDfdFceHfcAbtCig	0.8882	0.9739	0.9065	0.9487	0.9287	0.7700	0.8872	0.8265	0.9257	0.8979
GneDfdFceHfcMisOgd	0.9093	0.9425	0.9006	0.8500	0.9000	0.8110	0.9443	0.8751	0.8133	0.8800
GneDfdFceHfcMisOsv	1.0824	1.0292	1.0411	1.0394	1.0478	0.8032	0.8981	0.8493	0.5731	0.9053
GneDfdFceHfcMisIfs	0.8486	0.8667	0.7748	0.8003	0.8218	0.8325	0.9093	0.8701	0.8959	0.8457
GneDfdFceHfcTptTsv	1.0575	1.0736	0.9851	1.0265	1.0351	0.8275	1.0137	0.9159	0.6489	0.9350
GneDfdFceHfcTptPvh	0.9901	0.9969	1.0096	1.0300	1.0065	0.7928	0.9964	0.8888	0.8123	0.9421
GneDfdFceHfcTptOvh	1.0795	1.0135	0.9723	0.9752	1.0092	0.7587	0.9018	0.8271	0.6974	0.9044
GneDfdFceHfcHerAsv	1.0257	0.9290	0.9375	0.9754	0.9661	0.8751	0.9301	0.9022	0.8266	0.9265
GneDfdFceHfcHerCsv	0.9417	0.9649	0.9547	0.9353	0.9491	0.9282	0.9710	0.9493	0.7866	0.9240
GneDfdFceHfcHltHsv	0.9682	0.9699	1.0277	1.0237	0.9970	0.8758	0.9804	0.9266	0.8336	0.9517
GneDfdFceHfcHltMed	1.0044	0.9508	0.8533	0.8809	0.9205	0.8571	0.9684	0.9111	0.8982	0.9146
GneDfdFceHfcFheFnt	0.9744	0.9737	1.0983	0.9984	1.0099	0.8827	0.9315	0.9068	0.9149	0.9656
GneDfdFceHfcFheTls	1.0373	1.0295	1.0517	1.0252	1.0358	0.8445	0.9115	0.8773	0.6713	0.9285
GneDfdFceHfcFheApp	1.0463	1.0927	1.0855	1.0780	1.0755	0.9031	1.0627	0.9797	0.9301	1.0257
GneDfdFceHfcHweRnt	1.0610	1.0044	0.9952	0.9794	1.0095	0.7141	0.7662	0.7397	0.3469	0.7930
GneDfdFceHfcHweWsc	0.9339	0.8884	0.9194	0.9284	0.9173	0.9945	1.0071	1.0008	0.7566	0.9149
GneDfdFceHfcHweEgf	0.9702	0.9870	1.0138	1.0018	0.9930	0.8588	0.9345	0.8959	0.8190	0.9381
GneDfdFceHfcFud	1.0486	1.0071	0.9851	0.9794	1.0047	0.7412	1.0080	0.8644	0.8570	0.9408
GneDfdFceHfcCnf	0.9923	0.9877	1.0112	1.0161	1.0017	0.9621	0.9931	0.9775	0.8706	0.9750
GneDfdFceHfcRnc	1.0117	0.9875	0.9854	0.9227	0.9762	0.8915	0.9786	0.9341	0.8486	0.9449
GneDfdFceHfcEdc	0.9959	0.9750	0.9771	1.0301	0.9943	0.9274	1.0082	0.9669	0.8607	0.9663
GneDfdFceHfcCom	1.0688	1.0976	0.9987	1.0621	1.0562	0.8396	0.8427	0.8411	0.7769	0.9472
GneCiiPnfMin	0.9251	0.8961	0.9455	0.9604	0.9315	0.9480	0.9762	0.9620	1.0225	0.9527
GneCiiPnfMan	0.9535	0.9425	0.9915	0.9782	0.9662	0.9407	0.8913	0.9157	0.9369	0.9473
GneCiiPnfWhf	0.8238	0.9497	0.8799	0.9912	0.9089	0.8272	0.9184	0.8716	0.9119	0.8985
GneCiiPnfRet	0.9062	0.9592	0.8869	0.9990	0.9368	0.8749	0.8831	0.8790	0.9750	0.9252
GneCiiPnfOnf	1.0128	1.0146	1.0061	0.9822	1.0038	0.9406	0.8489	0.8936	1.0147	0.9725
GneCiiPba	1.0176	0.8940	0.9289	0.9737	0.9524	0.9782	1.0607	1.0186	1.7323	1.0575
GneCiiPfm	0.8413	0.8623	1.2053	1.0031	0.9677	0.8758	0.8690	0.8724	1.2023	0.9691
Sde	0.9470	1.0034	0.9645	1.0752	0.9963	0.8439	0.9878	0.9130	1.3072	1.0102
ExpMinImp	0.9817	0.8665	0.9291	0.9253	0.9247	0.7558	0.9985	0.8687	0.9526	0.9122
<i>oct-acov</i>										
Gdp	1.0696	0.9689	0.8975	0.8926	0.9545	0.6245	0.7745	0.6954	0.5402	0.8039
Tfi	0.8819	0.9335	0.8635	0.8131	0.8719	0.6078	0.7907	0.6932	0.5603	0.7666
TfiGos	0.9524	0.9233	0.9181	0.8826	0.9187	0.8534	1.0301	0.9376	0.8262	0.9102
TfiCoe	1.0585	1.0662	1.0576	1.0251	1.0517	0.7560	0.8567	0.8048	0.5853	0.8960
TfiGosCop	0.9307	1.0153	1.0213	1.0053	0.9925	0.8061	0.9838	0.8905	0.9185	0.9516
TfiGosCopNfn	0.9853	0.9589	0.9416	0.9482	0.9584	0.8238	0.9746	0.8960	0.9125	0.9336
Gne	1.0071	1.0002	0.9278	0.9031	0.9585	0.8193	0.8075	0.8133	0.6064	0.8567
GneDfd	0.9274	1.0114	1.0088	0.9956	0.9852	0.8142	0.9428	0.8761	0.6608	0.8999
GneCii	1.0074	1.0401	1.0087	0.9540	1.0021	0.6813	0.7051	0.6931	0.9084	0.8894
GneDfdFce	0.9691	0.9489	0.9310	0.9373	0.9464	0.8277	0.8673	0.8473	0.6888	0.8763
GneDfdGfc	0.9498	0.9511	0.9539	0.9246	0.9448	0.8149	0.9476	0.8787	0.6726	0.8816
GneCiiPnf	0.8789	0.8723	0.8662	0.9412	0.8892	0.8262	0.8142	0.8202	0.8360	0.8613
GneDfdFceGvt	0.8871	0.9403	0.9355	0.9800	0.9352	0.9317	0.9127	0.9221	0.7534	0.9031
GneDfdFceHfc	1.0387	1.0608	1.0167	0.9972	1.0281	0.7718	0.7929	0.7822	0.5914	0.8786
GneDfdGfcPub	0.8458	0.9331	0.9421	0.9405	0.9144	0.7839	0.8882	0.8344	0.8822	0.8863
GneDfdGfcPvt	0.8664	0.8983	0.8528	0.8617	0.8696	0.7893	0.9025	0.8440	0.6605	0.8290
GneDfdFceGvtNat	0.9452	0.9430	0.9274	0.9687	0.9459	0.9020	0.9309	0.9163	0.8500	0.9232
GneDfdGfcPubGvt	0.8439	0.9215	0.7755	0.8614	0.8490	0.8218	0.7851	0.8032	0.7440	0.8200
GneDfdGfcPubPcp	1.0110	0.9826	0.9732	0.9349	0.9751	0.9913	0.9981	0.9947	0.8475	0.9612
GneDfdGfcPvtTdw	0.8914	0.9563	0.9584	0.9156	0.9300	0.6751	1.0044	0.8234	0.7694	0.8742
GneDfdGfcPvtPbi	0.9201	0.9276	0.9615	0.9768	0.9462	0.8738	1.0176	0.9430	0.5707	0.8794
GneDfdFceHfcAbt	1.1008	1.1005	0.9931	0.9876	1.0440	0.9352	0.9862	0.9603	0.8573	0.9911
GneDfdFceHfcMis	1.0120	0.9569	1.0391	1.0467	1.0131	0.8855	0.9787	0.9309	0.9012	0.9725
GneDfdFceHfcTpt	1.0922	1.0662	1.0367	1.0803	1.0686	0.6114	0.6853	0.6473	0.6464	0.8619
GneDfdFceHfcHer	0.9297	0.9056	0.9665	0.9845	0.9461	0.9144	1.0865	0.9967	0.7674	0.9320
GneDfdFceHfcHlt	0.9525	1.0220	0.9576	0.9626	0.9733	0.9658	0.9789	0.9723	0.8685	0.9573

GneDfdFceHfcFhe	0.9782	0.9749	0.9617	0.9142	0.9569	0.8415	0.7836	0.8121	0.7530	0.8823
GneDfdFceHfcHwe	0.7829	0.8061	0.8020	0.8759	0.8160	0.5803	0.7330	0.6522	0.5549	0.7244
GneDfdGfcPubGvtNat	0.8693	0.8991	0.8749	0.8987	0.8854	0.9940	0.9754	0.9846	0.8661	0.9098
GneDfdGfcPvtPbiIpr	0.7368	0.7365	0.8195	0.8122	0.7752	0.629	0.7903	0.7051	0.4687	0.7022
GneDfdGfcPvtPbiNdc	0.9218	0.8003	0.8633	0.8812	0.8655	0.7415	0.8047	0.7725	0.5741	0.7901
GneDfdGfcPvtPbiNdm	0.9173	0.9770	0.9587	0.9495	0.9504	0.9245	0.9733	0.9486	0.7686	0.9215
TfiGosCopNfnPub	1.0016	1.0412	1.0607	1.0340	1.0341	0.9171	0.9816	0.9488	0.7800	0.9692
TfiGosCopNfnPvt	0.9434	1.0018	0.9856	1.0337	0.9906	0.8472	0.9728	0.9078	0.8974	0.9527
TfiGosCopFin	0.9809	0.9822	0.9031	0.9084	0.9429	0.8502	1.0841	0.9600	0.8139	0.9280
TfiGosGvt	0.4877	0.7056	1.3238	1.0690	0.8354	0.244	0.7631	0.4315	0.2685	0.5881
TfiGosDwl	0.9918	0.9713	0.9552	1.0063	0.9809	0.8762	0.9549	0.9147	0.5828	0.8926
TfiGmi	1.1443	1.0645	1.1509	1.161	1.1295	0.9743	1.1162	1.0428	0.9672	1.0798
TfiCoeWns	1.0989	1.0804	1.0627	1.0580	1.0749	0.7456	0.8424	0.7926	0.5638	0.8985
TfiCoeEsc	1.0464	1.0622	1.0256	1.0076	1.0353	0.8006	0.9317	0.8637	0.6312	0.9159
Tsi	0.9800	1.0072	0.9806	0.9789	0.9866	0.8440	0.8613	0.8526	0.7756	0.9143
Sdi	1.0238	0.9810	1.0248	1.0520	1.0201	0.9248	0.9225	0.9237	0.9316	0.9788
GneDfdFceGvtNatNdf	0.8833	0.9167	0.8587	0.9349	0.8979	0.9222	0.9186	0.9204	0.8259	0.8935
GneDfdFceGvtNatDef	1.0215	1.0254	0.9876	0.9842	1.0045	0.9515	1.0331	0.9914	0.8047	0.9695
GneDfdFceGvtSnl	0.8582	0.9340	0.9254	0.9301	0.9114	0.9075	0.9289	0.9182	0.7139	0.8820
GneDfdGfcPubGvtNatNdf	1.0342	1.0294	1.0788	0.9181	1.0134	0.9583	1.0909	1.0225	0.9261	1.0030
GneDfdGfcPubGvtNatDef	0.9315	1.1008	0.9848	0.8561	0.9643	0.8219	0.8659	0.8436	0.9115	0.9207
GneDfdGfcPubGvtSnl	1.0277	1.0412	1.0708	1.1085	1.0616	0.8322	0.9173	0.8737	1.0070	0.9966
GneDfdGfcPubPcpCmw	0.9570	0.9945	1.0921	1.0609	1.0248	1.0341	0.9760	1.0046	0.7358	0.9719
GneDfdGfcPubPcpSnl	0.9580	0.9262	0.9891	0.9125	0.9460	0.8789	0.8760	0.8774	0.8836	0.9169
GneDfdGfcPvtTdwNnu	0.8836	0.9404	1.0184	0.9877	0.9562	0.6803	1.0139	0.8305	0.8283	0.8998
GneDfdGfcPvtTdwAna	0.9815	1.0145	1.0126	1.0608	1.0169	0.8532	1.0383	0.9412	0.9122	0.9794
GneDfdGfcPvtPbiIprRnd	1.1117	0.9269	1.3607	1.0916	1.1123	0.3338	0.8038	0.5180	0.2955	0.7399
GneDfdGfcPvtPbiIprMmp	1.0928	1.1272	1.0563	1.0712	1.0866	0.9976	1.0270	1.0122	0.7844	1.0164
GneDfdGfcPvtPbiIprCom	0.9976	0.8462	1.2141	1.0134	1.0095	0.2907	0.7248	0.4590	0.3428	0.6907
GneDfdGfcPvtPbiIprArt	0.7091	0.7849	1.1884	0.9932	0.9003	0.3258	0.6951	0.4759	0.2981	0.6408
GneDfdGfcPvtPbiNdcNbd	1.1235	1.1681	1.1751	1.1007	1.1414	0.8597	1.0663	0.9575	0.7994	1.0317
GneDfdGfcPvtPbiNdcNec	0.8851	0.9479	0.9126	0.8933	0.9094	0.8731	0.9312	0.9017	0.5098	0.8352
GneDfdGfcPvtPbiNdcSha	0.9358	0.9322	1.0481	1.2128	1.0262	0.8895	0.9950	0.9408	0.9783	0.9942
GneDfdGfcPvtPbiNdmNew	0.9673	0.9953	0.9699	0.9702	0.9756	0.8751	0.9868	0.9293	0.7816	0.9321
GneDfdGfcPvtPbiNdmSha	0.9915	1.0864	1.0226	1.0306	1.0322	1.0002	0.9334	0.9662	0.7902	0.9750
GneDfdGfcPvtPbiCbr	0.7887	0.8593	0.9426	0.8716	0.8638	0.5176	0.8534	0.6646	0.5937	0.7597
GneDfdGfcPvtOtc	0.9479	1.0171	0.9721	0.9913	0.9818	0.7797	1.0441	0.9023	0.7708	0.9258
GneDfdFceHfcAbtAlc	0.9641	0.9483	0.9207	0.9044	0.9341	0.8954	0.9511	0.9228	0.8187	0.9135
GneDfdFceHfcAbtCig	0.9157	0.9709	0.8606	0.9110	0.9138	0.7877	0.8525	0.8194	0.9068	0.8848
GneDfdFceHfcMisOgd	0.9909	0.9969	0.9202	0.8788	0.9454	0.8684	0.9701	0.9179	0.8513	0.9235
GneDfdFceHfcMisOsv	1.1270	1.0481	1.0705	1.0580	1.0755	0.8277	0.9191	0.8722	0.5894	0.9296
GneDfdFceHfcMisIfs	0.8477	0.8555	0.7626	0.7800	0.8104	0.8205	0.8852	0.8523	0.8802	0.8319
GneDfdFceHfcTptTsv	1.0504	1.0566	0.9890	1.0421	1.0342	0.8171	1.0261	0.9157	0.6493	0.9346
GneDfdFceHfcTptPvh	1.0020	0.9745	0.9790	1.0104	0.9914	0.7842	0.9665	0.8706	0.7938	0.9254
GneDfdFceHfcTptOvh	1.0781	1.0424	0.9802	1.0050	1.0257	0.7666	0.9178	0.8388	0.7049	0.9179
GneDfdFceHfcHcrAsv	1.0484	0.9574	0.9592	0.9901	0.9881	0.9043	0.9467	0.9252	0.8515	0.9493
GneDfdFceHfcHcrCsv	0.9037	0.9265	0.9297	0.9647	0.9309	0.8810	0.9771	0.9278	0.7726	0.9056
GneDfdFceHfcHltHsv	1.0243	0.9789	1.0253	1.0315	1.0148	0.9034	0.9959	0.9485	0.8553	0.9714
GneDfdFceHfcHltMed	0.9724	0.9402	0.8777	0.8787	0.9164	0.8524	0.9922	0.9197	0.9205	0.9179
GneDfdFceHfcFheFnt	0.9896	0.9737	1.0431	0.9987	1.0010	0.8857	0.9101	0.8978	0.9007	0.9558
GneDfdFceHfcFheTls	1.0329	1.0147	1.0473	1.0314	1.0315	0.8361	0.9116	0.8730	0.6675	0.9242
GneDfdFceHfcFheApp	1.0461	1.0383	1.0133	0.9939	1.0227	0.8656	0.9818	0.9219	0.8633	0.9691
GneDfdFceHfcHweRnt	0.9950	0.9935	1.0154	0.9780	0.9954	0.6946	0.7724	0.7325	0.3467	0.7843
GneDfdFceHfcHweWsc	0.8913	0.9115	0.9054	0.9429	0.9126	0.9941	1.0230	1.0085	0.7682	0.9162
GneDfdFceHfcHweEgf	0.8985	0.9390	1.0639	1.0187	0.9779	0.8090	0.9700	0.8858	0.8187	0.9268
GneDfdFceHfcFud	1.0374	0.9888	0.9358	0.9199	0.9694	0.729	0.9476	0.8311	0.8163	0.9052
GneDfdFceHfcCnf	1.0198	0.9951	1.0080	0.9905	1.0033	0.9679	0.9789	0.9734	0.8676	0.9742
GneDfdFceHfcRnc	1.0177	1.0375	1.0039	0.9791	1.0093	0.9191	1.0199	0.9682	0.8729	0.9769
GneDfdFceHfcEde	1.0203	0.9706	0.9665	1.0192	0.9938	0.9337	0.9954	0.9640	0.8580	0.9647
GneDfdFceHfcCom	1.0404	1.0744	0.9819	1.0429	1.0343	0.8142	0.8252	0.8197	0.7513	0.9246
GneCiiPnfMfm	0.9453	0.9163	0.9425	0.9457	0.9374	0.9560	0.9830	0.9694	1.0411	0.9607
GneCiiPnfMan	0.9869	0.9883	0.9556	0.9907	0.9803	0.9637	0.9360	0.9498	0.9819	0.9717
GneCiiPnfWht	0.8146	0.9418	0.8848	0.9635	0.8993	0.8516	0.8953	0.8732	0.9501	0.8988
GneCiiPnfRet	0.9023	0.9444	0.8563	1.0055	0.9255	0.8659	0.8979	0.8818	0.9643	0.9182
GneCiiPnfOnf	1.0042	1.0045	1.0013	1.0055	1.0038	0.9382	0.8856	0.9115	1.0522	0.9831
GneCiiPba	1.0124	0.9215	0.9421	0.9099	0.9456	1.0004	0.9931	0.9968	1.7281	1.0463
GneCiiPfm	0.8615	0.8361	1.1608	0.9709	0.9492	0.8832	0.8369	0.8597	1.1658	0.9502
Sde	0.9577	0.9302	0.9364	1.0400	0.9651	0.8141	0.9336	0.8718	1.2500	0.9728
ExpMinImp	0.9491	0.8524	0.9237	0.9221	0.9111	0.7363	0.9913	0.8543	0.9363	0.8980

Table A.3: AvgRelMAE at any temporal aggregation level and any forecast horizon for all 95 time series and selected reconciliation procedures.

Series	Quarterly					Semi-annual			Annual	All
	1	2	3	4	1-4	1	2	1-2	1	
	<i>cs-shr</i>									
Gdp	1.0083	0.9940	1.0029	0.9939	0.9997	0.9670	0.9911	0.9790	0.9444	0.9857
Tfi	0.9229	1.0063	0.9720	0.9519	0.9628	0.9513	0.9818	0.9664	0.9044	0.9553
TfiGos	0.9642	0.9437	0.9695	0.9398	0.9542	1.0514	1.0135	1.0323	0.9691	0.9781
TfiCoe	0.9369	0.9572	0.9447	0.9439	0.9456	1.0014	0.9931	0.9972	0.9514	0.9609
TfiGosCop	0.9392	0.9828	1.0053	0.9777	0.9760	1.0058	0.9988	1.0023	0.9806	0.9841
TfiGosCopNfn	0.9477	0.9443	0.9540	0.9449	0.9477	0.9816	0.9848	0.9832	0.9747	0.9616
Gne	0.9710	1.0084	0.9639	1.0092	0.9879	1.0541	0.9822	1.0175	1.1008	1.0118
GneDfd	0.9952	0.9952	1.0130	1.0508	1.0133	0.9813	1.0398	1.0101	1.0772	1.0213
GneCii	0.9950	1.0076	1.0274	0.9538	0.9956	0.8318	0.8827	0.8569	0.9364	0.9455
GneDfdFce	0.9609	0.9127	0.9132	0.8959	0.9204	0.9684	0.9762	0.9723	1.0374	0.9510
GneDfdGfc	0.9500	0.9628	0.9503	0.9749	0.9595	1.0215	1.0063	1.0139	0.9608	0.9749
GneCiiPnf	0.9298	0.9256	0.9465	1.0091	0.9522	0.9066	0.8831	0.8948	0.9162	0.9303
GneDfdFceGvt	0.9240	0.9025	0.9275	0.9491	0.9256	0.9207	0.9220	0.9213	0.9215	0.9238
GneDfdFceHfc	0.9512	1.0229	0.9821	0.9593	0.9785	0.9645	0.9477	0.9561	0.9282	0.9647
GneDfdGfcPub	0.9199	0.9369	0.9500	1.0026	0.9519	0.9291	0.9708	0.9497	0.9884	0.9564
GneDfdGfcPvt	0.9156	0.9419	0.8990	0.9520	0.9269	0.9275	0.9527	0.9400	0.9569	0.9349
GneDfdFceGvtNat	0.9529	0.9175	0.9336	0.9484	0.9380	0.9550	0.9574	0.9562	0.9711	0.9478
GneDfdGfcPubGvt	0.9324	0.9679	0.9358	0.9425	0.9446	0.9153	0.9022	0.9087	0.9461	0.9344
GneDfdGfcPubPcp	0.9256	0.9669	0.9420	0.9284	0.9406	0.9965	0.9807	0.9886	0.9168	0.9506
GneDfdGfcPvtTdw	0.9850	0.9806	0.9696	0.9598	0.9737	0.9131	1.0060	0.9584	0.9857	0.9710
GneDfdGfcPvtPbi	0.9456	0.9453	0.9345	0.9853	0.9525	0.9243	0.9848	0.9541	0.9414	0.9513
GneDfdFceHfcAbt	1.0419	1.0717	1.0265	1.0278	1.0418	0.9796	1.0246	1.0018	0.9494	1.0166
GneDfdFceHfcMis	1.0266	1.0216	1.0318	1.0408	1.0302	1.0034	1.0271	1.0152	1.0299	1.0258
GneDfdFceHfcTpt	0.9312	0.9336	0.9345	0.9201	0.9298	0.8731	0.9258	0.8991	0.9612	0.9253
GneDfdFceHfcHcr	0.9848	0.9764	0.9839	0.9814	0.9816	0.9473	1.0057	0.9761	0.9922	0.9815
GneDfdFceHfcHlt	0.9429	0.9786	0.9740	0.9906	0.9714	0.9917	0.9857	0.9887	0.9843	0.9781
GneDfdFceHfcFhe	0.9824	0.9937	0.9911	0.9759	0.9858	0.9612	0.9639	0.9626	0.9548	0.9746
GneDfdFceHfcHwe	0.8579	0.9115	0.9036	0.9510	0.9054	0.8419	0.9286	0.8842	1.0041	0.9127
GneDfdGfcPubGvtNat	0.9182	0.9676	0.9761	0.9696	0.9576	1.0266	0.9778	1.0019	0.9901	0.9747
GneDfdGfcPvtPbiPr	0.8379	0.9157	0.8817	0.8874	0.8802	0.9358	0.9391	0.9374	0.9955	0.9121
GneDfdGfcPvtPbiNdc	0.8882	0.8864	0.9092	0.9105	0.8985	0.8477	0.8878	0.8675	0.8782	0.8866
GneDfdGfcPvtPbiNdm	0.9946	0.9565	0.9787	0.9824	0.9779	0.9440	0.9780	0.9609	0.9947	0.9754
TfiGosCopNfnPub	1.0210	1.0367	1.0227	1.0408	1.0302	1.0112	0.9879	0.9995	0.9973	1.0166
TfiGosCopNfnPvt	0.9961	0.9738	0.9851	0.9951	0.9875	0.9981	0.9902	0.9941	0.9622	0.9857
TfiGosCopFin	1.0074	1.0106	1.0014	0.9950	1.0036	1.0341	1.0189	1.0265	1.0334	1.0143
TfiGosGvt	1.0219	1.0063	0.9965	0.9938	1.0045	1.0083	0.9931	1.0007	0.9478	0.9951
TfiGosDwl	0.9824	0.9928	1.0008	0.9878	0.9909	1.0000	0.9937	0.9968	0.9612	0.9883
TfiGmi	1.0579	1.0540	1.0929	1.0718	1.0690	1.0422	1.0459	1.0440	1.0485	1.0589
TfiCoeWns	0.9607	0.9761	0.9613	0.9663	0.9661	0.9885	0.9824	0.9855	0.9578	0.9704
TfiCoeEsc	0.9668	0.9596	0.9669	0.9749	0.9670	0.9921	1.0032	0.9977	0.9783	0.9773
Tsi	1.0039	1.0232	0.9997	0.9900	1.0041	1.0101	0.9976	1.0038	0.9793	1.0005
Sdi	1.0046	1.0254	0.9819	1.0187	1.0075	1.0243	1.0462	1.0352	1.0233	1.0176
GneDfdFceGvtNatNdf	0.9545	0.9463	0.9565	0.9726	0.9574	0.9527	0.9429	0.9478	0.9275	0.9503
GneDfdFceGvtNatDef	1.0024	1.0008	0.9834	0.9525	0.9846	0.9740	1.0089	0.9913	0.9891	0.9871
GneDfdFceGvtSnl	0.9552	0.9451	0.9197	0.9078	0.9318	0.8992	0.8586	0.8787	0.8599	0.9058
GneDfdGfcPubGvtNatNdf	0.9768	1.0145	0.9905	1.0000	0.9953	1.0011	1.0002	1.0006	0.9624	0.9921
GneDfdGfcPubGvtNatDef	0.9296	1.0107	1.0013	0.9465	0.9714	0.9664	0.9355	0.9508	0.9953	0.9688
GneDfdGfcPubGvtSnl	1.0292	1.0194	1.0242	1.0392	1.0280	0.9840	1.0509	1.0169	1.0651	1.0300
GneDfdGfcPubPcpCmw	0.9841	1.0255	1.0541	1.0493	1.0279	0.9873	0.9856	0.9865	1.0003	1.0119
GneDfdGfcPubPcpSnl	0.9130	0.9451	0.9185	0.9009	0.9192	0.9268	0.9239	0.9254	0.9294	0.9224
GneDfdGfcPvtTdwNnu	0.9738	0.9968	1.0008	1.0293	1.0000	0.9221	1.0043	0.9623	1.0286	0.9931
GneDfdGfcPvtTdwAna	0.9998	1.0145	1.0127	1.0077	1.0087	0.9472	0.9901	0.9684	0.9836	0.9934
GneDfdGfcPvtPbiPrRnd	1.0219	1.0004	1.0002	0.9988	1.0053	1.0169	0.9898	1.0033	0.9683	0.9993
GneDfdGfcPvtPbiPrMnp	1.0032	1.0032	1.0567	1.0391	1.0253	0.9672	0.9955	0.9812	0.9856	1.0068
GneDfdGfcPvtPbiPrCom	0.9767	0.9865	0.9878	0.9937	0.9862	0.9805	0.9841	0.9823	0.9498	0.9798
GneDfdGfcPvtPbiPrArt	0.9983	0.9924	0.9968	0.9902	0.9944	1.0019	0.9680	0.9848	0.9449	0.9845
GneDfdGfcPvtPbiNdcNbd	1.0211	1.0228	1.0503	1.0467	1.0351	1.0543	1.0788	1.0665	1.0968	1.0526
GneDfdGfcPvtPbiNdcNec	0.9535	0.9619	0.9639	0.9509	0.9575	1.0102	1.0009	1.0056	0.9061	0.9634
GneDfdGfcPvtPbiNdcSha	0.9841	1.0156	1.0941	1.1379	1.0562	0.9666	1.0353	1.0004	0.9778	1.0285
GneDfdGfcPvtPbiNdmSha	1.0326	0.9867	0.9937	1.0109	1.0058	0.9241	0.9813	0.9523	1.0137	0.9913
GneDfdGfcPvtPbiNdmSna	1.0055	1.0203	1.0461	1.0415	1.0282	0.9736	1.0274	1.0001	1.0069	1.0171
GneDfdGfcPvtPbiCbr	1.0263	1.0107	0.9982	0.9967	1.0079	0.9678	0.9823	0.9750	1.0262	1.0010
GneDfdGfcPvtOtc	0.9948	1.0129	1.0078	1.0115	1.0067	0.9702	0.9725	0.9714	0.9637	0.9903
GneDfdFceHfcAbtAlc	0.9617	0.9721	0.9850	0.9586	0.9693	0.9883	0.9719	0.9801	1.0000	0.9767

GneDfdFceHfcAbtCig	0.9480	0.9524	0.9609	0.9875	0.9621	0.9481	0.9702	0.9591	1.0085	0.9677
GneDfdFceHfcMisOgd	0.9874	0.9974	0.9657	0.9562	0.9765	0.9873	0.9655	0.9763	0.9889	0.9782
GneDfdFceHfcMisOsv	1.0072	0.9851	0.9911	0.9944	0.9944	0.9661	1.0123	0.9889	1.0146	0.9957
GneDfdFceHfcMisIfs	0.9320	0.9580	0.9120	0.9525	0.9384	0.9246	0.9243	0.9245	0.9291	0.9331
GneDfdFceHfcTptTsv	0.9825	0.9934	0.9894	0.9798	0.9862	1.0017	1.0187	1.0102	0.9813	0.9923
GneDfdFceHfcTptPvh	0.9944	0.9979	0.9811	1.0111	0.9961	0.9879	1.0586	1.0226	1.0050	1.0049
GneDfdFceHfcTptOvh	0.9909	0.9799	0.9655	0.9624	0.9746	1.0117	1.0374	1.0245	0.9976	0.9919
GneDfdFceHfcHcrAsv	1.0096	0.9904	0.9763	0.9856	0.9904	0.9845	0.9686	0.9765	0.9620	0.9823
GneDfdFceHfcHcrCsv	1.0014	1.0067	1.0024	0.9886	0.9998	0.9953	0.9616	0.9783	1.0115	0.9952
GneDfdFceHfcHltHsv	0.9614	0.9940	1.0250	0.9941	0.9934	0.9733	1.0330	1.0027	1.0301	1.0012
GneDfdFceHfcHltMed	1.0145	0.9713	0.9669	0.9575	0.9773	1.0132	0.9756	0.9942	0.9463	0.9776
GneDfdFceHfcFheFnt	1.0073	0.9839	1.0197	1.0192	1.0074	0.9667	1.0128	0.9895	1.0064	1.0021
GneDfdFceHfcFheTls	0.9949	1.0114	1.0065	1.0044	1.0043	1.0053	1.0041	1.0047	1.0107	1.0053
GneDfdFceHfcFheApp	1.0093	1.0340	1.0510	1.0461	1.0350	0.9899	1.0475	1.0183	1.0447	1.0316
GneDfdFceHfcHweRnt	1.0319	0.9694	0.9808	0.9815	0.9906	0.9701	0.9692	0.9696	0.9342	0.9764
GneDfdFceHfcHweWsc	1.0423	1.0116	1.0045	0.9710	1.0070	0.9701	0.9908	0.9804	0.9772	0.9951
GneDfdFceHfcHweEgf	0.9883	0.9773	1.0299	0.9899	0.9962	0.9671	0.9764	0.9717	0.9940	0.9888
GneDfdFceHfcFud	1.0149	1.0148	1.0275	1.0355	1.0231	0.9783	1.0331	1.0053	1.0087	1.0159
GneDfdFceHfcCnf	1.0074	1.0151	1.0336	1.0571	1.0281	0.9954	0.9910	0.9932	0.9679	1.0093
GneDfdFceHfcRnc	0.9870	1.0010	1.0048	0.9915	0.9961	0.9725	1.0188	0.9954	0.9955	0.9958
GneDfdFceHfcEdc	0.9796	1.0026	1.0092	1.0021	0.9983	1.0160	1.0083	1.0122	0.9559	0.9961
GneDfdFceHfcCom	1.0350	1.0364	1.0434	1.0500	1.0412	0.9948	1.0113	1.0030	1.0150	1.0264
GneCiiPnfMin	0.9887	0.9692	0.9822	1.0342	0.9933	0.9970	0.9945	0.9957	1.0434	1.0010
GneCiiPnfMan	0.9925	0.9595	1.0311	0.9793	0.9902	0.9528	0.9760	0.9643	1.0474	0.9907
GneCiiPnfWht	0.9781	0.9740	0.9763	1.0088	0.9842	0.9561	0.9730	0.9645	0.9706	0.9766
GneCiiPnfRet	0.9811	0.9785	0.9769	1.0164	0.9881	0.9602	1.0001	0.9799	0.9487	0.9800
GneCiiPnfOnf	1.0081	1.0256	1.0187	1.0077	1.0150	0.9912	0.9630	0.9770	0.9847	0.9997
GneCiiPba	1.0257	1.0655	1.1043	1.149	1.0852	1.1592	1.1990	1.1790	1.1116	1.1150
GneCiiPfm	0.9820	0.9804	0.9993	0.9917	0.9883	0.9737	1.0172	0.9952	1.0093	0.9933
Sde	0.9474	0.9853	0.9978	1.0756	1.0005	1.0181	1.0161	1.0171	1.1369	1.0237
ExpMinImp	0.9521	0.9408	0.9716	0.9735	0.9594	0.9274	0.9920	0.9592	1.0348	0.9698
<i>t-acov</i>										
Gdp	1.0382	1.0009	1.0367	1.0076	1.0207	0.8466	0.9004	0.8731	0.7892	0.9409
Tfi	1.0004	1.0513	1.0032	1.0016	1.0139	0.8512	0.9630	0.9054	0.8025	0.9494
TfiGos	1.0039	0.9841	0.9969	0.9825	0.9918	0.9893	1.0307	1.0098	0.9324	0.9882
TfiCoe	1.0144	1.0080	1.0326	1.0094	1.0161	0.9099	0.9287	0.9193	0.7519	0.9458
TfiGosCop	1.0018	0.9934	1.0143	1.0019	1.0028	0.9480	0.9936	0.9705	0.9358	0.9837
TfiGosCopNfn	1.0043	0.9863	0.9835	0.9762	0.9875	0.9537	0.9964	0.9748	0.9615	0.9801
Gne	0.9942	1.0222	1.0015	1.0135	1.0078	0.9503	0.9443	0.9473	0.8272	0.9626
GneDfd	0.9907	1.0147	1.0039	1.0232	1.0081	0.9317	0.9524	0.9420	0.8093	0.9582
GneCii	1.0333	1.0417	1.0087	0.9953	1.0196	0.8719	0.8783	0.8751	0.9200	0.9618
GneDfdFce	0.9883	1.0127	0.9998	1.0116	1.0031	0.9364	0.9751	0.9555	0.9009	0.9742
GneDfdGfc	0.9782	1.0042	0.9948	1.0015	0.9946	0.9808	0.9922	0.9865	0.8394	0.9685
GneCiiPnf	1.0108	0.9712	0.9986	1.0159	0.9990	0.9612	0.9245	0.9427	0.9184	0.9708
GneDfdFceGvt	0.9749	1.0143	1.0325	0.9967	1.0044	1.0025	0.9684	0.9853	0.9322	0.9883
GneDfdFceHfc	1.0092	1.0504	1.0210	1.0267	1.0267	0.8537	0.8908	0.8721	0.7826	0.9426
GneDfdGfcPub	0.9961	1.0151	0.9813	1.0156	1.0019	0.9384	0.9799	0.9589	0.9868	0.9873
GneDfdGfcPvt	0.9964	1.0079	0.9918	1.0006	0.9992	0.9485	0.9840	0.9661	0.8267	0.9632
GneDfdFceGvtNat	0.9883	0.9855	0.9732	1.0060	0.9882	0.9699	0.9592	0.9645	0.9518	0.9761
GneDfdGfcPubGvt	0.9878	1.0074	0.9790	0.9741	0.9870	0.9511	0.9683	0.9597	0.9826	0.9785
GneDfdGfcPubPep	0.9858	0.9982	0.9998	0.9708	0.9886	0.9895	1.0229	1.0061	0.9242	0.9840
GneDfdGfcPvtTdw	1.0027	1.0121	1.0166	0.9985	1.0074	0.8015	1.0280	0.9077	0.8288	0.9510
GneDfdGfcPvtPbi	0.9561	1.0215	1.0001	1.0009	0.9944	0.9784	0.9919	0.9851	0.7715	0.9564
GneDfdFceHfcAbt	0.9755	0.9905	0.9866	1.0140	0.9916	0.9211	0.9613	0.9410	0.8734	0.9593
GneDfdFceHfcMis	0.9546	0.9814	0.9777	0.9661	0.9699	0.8969	0.9179	0.9073	0.9158	0.9438
GneDfdFceHfcTpt	1.0572	1.0130	1.0243	1.0304	1.0311	0.782	0.9158	0.8462	0.8726	0.9515
GneDfdFceHfcHcr	0.9849	0.9695	0.9869	0.9610	0.9755	0.9574	1.0070	0.9819	0.8298	0.9550
GneDfdFceHfcHlt	0.9827	0.9940	0.9964	1.0029	0.9940	0.9916	0.9775	0.9845	0.9348	0.9826
GneDfdFceHfcFhe	1.0097	1.0144	1.0192	1.0172	1.0151	0.9437	0.9477	0.9457	0.8940	0.9769
GneDfdFceHfcHwe	1.0139	0.9989	0.9938	1.0233	1.0074	0.8367	0.9331	0.8836	0.7924	0.9377
GneDfdGfcPubGvtNat	1.0145	0.9914	1.0109	0.9945	1.0028	1.0016	0.9614	0.9813	0.9573	0.9900
GneDfdGfcPvtPbilpr	0.9693	1.0173	0.9940	1.0127	0.9981	0.8671	0.9429	0.9042	0.7450	0.9306
GneDfdGfcPvtPbiNdc	0.9962	1.0247	1.0182	1.0146	1.0134	0.9886	1.0019	0.9952	0.8385	0.9812
GneDfdGfcPvtPbiNdm	0.9826	1.0041	0.9879	0.9748	0.9873	0.9771	0.9927	0.9849	0.8626	0.9678
TfiGosCopNfnPub	1.0036	1.0235	0.9896	1.0015	1.0045	0.9673	0.9893	0.9782	0.9099	0.9829
TfiGosCopNfnPvt	0.9866	0.9950	0.9932	1.0050	0.9949	0.9443	0.9729	0.9585	0.9129	0.9724
TfiGosCopFin	1.0123	1.0029	0.9695	0.9843	0.9921	0.9068	1.0523	0.9768	0.8755	0.9702

TfiGosGvt	0.7047	0.8383	1.1628	1.0574	0.9232	0.5274	0.8760	0.6797	0.4881	0.7723
TfiGosDwl	1.0242	1.0012	0.9841	1.0124	1.0053	0.9317	0.9834	0.9572	0.7493	0.9506
TfiGmi	1.0362	0.9838	1.0045	0.9933	1.0043	0.9156	0.9609	0.9380	0.9220	0.9729
TfiCoeWns	1.0187	1.0129	1.0455	1.0207	1.0244	0.8766	0.9120	0.8941	0.7372	0.9401
TfiCoeEsc	1.0035	1.0112	1.0170	0.9927	1.0061	0.9310	0.9693	0.9499	0.8353	0.9637
Tsi	1.0031	1.0070	1.0135	1.0114	1.0088	0.8993	0.9551	0.9268	0.9153	0.9710
Sdi	1.0271	1.0203	1.0434	1.0213	1.0280	0.9388	0.9533	0.9460	0.9908	0.9986
GneDfdFceGvtNatNdf	0.9647	0.9748	0.9561	0.9899	0.9713	0.9388	0.9748	0.9566	0.9018	0.9569
GneDfdFceGvtNatDef	1.0271	1.0171	0.9849	0.9974	1.0065	0.9637	1.0210	0.9920	0.9382	0.9923
GneDfdFceGvtSnl	0.9808	0.9791	0.9866	0.9947	0.9853	0.9740	0.9829	0.9784	0.9292	0.9751
GneDfdGfcPubGvtNatNdf	1.0304	0.9883	0.9962	0.9670	0.9952	0.9926	1.0112	1.0019	0.9568	0.9915
GneDfdGfcPubGvtNatDef	1.0122	1.0398	1.0017	0.9340	0.9961	0.9310	0.9303	0.9306	0.9630	0.9723
GneDfdGfcPubGvtSnl	1.0166	0.9931	0.9550	1.0062	0.9924	0.9243	0.9557	0.9399	1.0085	0.9794
GneDfdGfcPubPepCmw	0.9544	0.9941	1.0154	1.0223	0.9962	0.9931	0.9882	0.9906	0.8508	0.9724
GneDfdGfcPubPepSnl	1.0033	1.0144	1.0143	1.0173	1.0123	0.9636	0.9834	0.9735	0.9465	0.9915
GneDfdGfcPvtTdwNnu	0.9721	0.9803	1.0127	1.0040	0.9921	0.7663	0.9619	0.8586	0.8232	0.9269
GneDfdGfcPvtTdwAna	1.0036	1.0301	0.9930	0.9896	1.0039	0.9228	0.9871	0.9544	0.8989	0.9740
GneDfdGfcPvtPbiIprRnd	0.8484	0.9225	1.1955	1.0725	1.0009	0.5919	0.9104	0.7341	0.5026	0.8302
GneDfdGfcPvtPbiIprMnp	1.0388	1.0300	1.0166	1.0206	1.0265	0.8876	0.9629	0.9245	0.8095	0.9630
GneDfdGfcPvtPbiIprCom	0.7995	0.9047	1.1277	1.0394	0.9596	0.5533	0.8411	0.6822	0.6019	0.8143
GneDfdGfcPvtPbiIprArt	0.8095	0.9152	1.1030	1.0285	0.9575	0.6165	0.8121	0.7076	0.5184	0.8045
GneDfdGfcPvtPbiNdcNbd	1.0084	0.9982	0.9867	0.9860	0.9948	0.9400	0.9601	0.9500	0.7782	0.9480
GneDfdGfcPvtPbiNdcNec	1.0340	1.0026	0.9971	0.9721	1.0012	1.0299	1.0007	1.0152	0.7591	0.9662
GneDfdGfcPvtPbiNdcSha	1.0328	1.0242	1.0466	1.0311	1.0336	0.9803	0.9440	0.9620	0.9757	1.0043
GneDfdGfcPvtPbiNdmNew	0.9996	1.0211	0.9975	0.9911	1.0023	0.9502	0.9689	0.9595	0.8825	0.9720
GneDfdGfcPvtPbiNdmSha	1.0381	1.0142	1.0322	1.0395	1.0310	1.0066	0.9734	0.9898	0.9106	1.0011
GneDfdGfcPvtPbiCbr	0.8780	0.9541	0.9540	0.9216	0.9264	0.7348	0.8803	0.8043	0.7498	0.8632
GneDfdGfcPvtOtc	0.9980	0.9829	0.9671	0.9836	0.9829	0.8562	0.9890	0.9202	0.8118	0.9385
GneDfdFceHfcAbtAlc	1.0061	0.9863	1.0004	0.9807	0.9933	0.9759	0.9765	0.9762	0.9260	0.9785
GneDfdFceHfcAbtCig	0.9920	0.9961	0.9854	0.9752	0.9872	0.9274	0.9682	0.9476	1.0337	0.9821
GneDfdFceHfcMisOgd	0.9603	0.9986	0.9393	0.9344	0.9578	0.9040	0.9826	0.9425	0.8324	0.9345
GneDfdFceHfcMisOsv	1.0564	1.0256	1.0228	1.0215	1.0315	0.9238	0.9810	0.9520	0.7637	0.9658
GneDfdFceHfcMisIfs	0.9776	0.9573	0.9469	0.9314	0.9531	0.9336	0.9863	0.9596	0.9707	0.9575
GneDfdFceHfcTptTsv	1.0212	1.0314	0.9889	0.9996	1.0102	0.9409	0.9854	0.9629	0.8678	0.9750
GneDfdFceHfcTptPvh	1.0079	0.9876	0.9770	0.9738	0.9865	0.9350	0.9694	0.9521	0.9270	0.9679
GneDfdFceHfcTptOvh	1.0135	1.0013	1.0013	1.0193	1.0088	0.9097	0.9781	0.9433	0.8552	0.9666
GneDfdFceHfcHcrAsv	1.0034	0.9648	0.9911	1.0003	0.9898	0.9400	1.0026	0.9708	0.9093	0.9725
GneDfdFceHfcHcrCvs	0.9951	0.9685	0.9806	0.9959	0.9850	0.9452	0.9886	0.9667	0.8646	0.9616
GneDfdFceHfcHltHsv	1.0181	1.0079	1.0130	0.9891	1.0070	0.9390	0.9826	0.9605	0.8682	0.9727
GneDfdFceHfcHltMed	1.0109	1.0024	0.9669	0.9768	0.9891	0.9705	1.0360	1.0027	0.9789	0.9915
GneDfdFceHfcFheFnt	1.0057	1.0075	1.0096	0.9817	1.0011	0.9563	0.9546	0.9554	0.9338	0.9780
GneDfdFceHfcFheTls	1.0414	1.0118	1.0280	1.0107	1.0229	0.8724	0.9214	0.8966	0.8138	0.9534
GneDfdFceHfcFheApp	1.0113	1.0084	0.9871	0.9892	0.9989	0.9463	1.0259	0.9853	0.9203	0.9834
GneDfdFceHfcHweRnt	1.0092	0.9905	0.9975	0.9796	0.9942	0.8243	0.8473	0.8357	0.5999	0.8802
GneDfdFceHfcHweWsc	0.9445	0.9764	0.9747	0.9820	0.9693	0.9624	1.0218	0.9916	0.8046	0.9500
GneDfdFceHfcHweEgf	1.0090	1.0196	1.0128	1.0258	1.0168	0.9430	0.9563	0.9496	0.8785	0.9765
GneDfdFceHfcFud	1.0423	0.9942	0.9770	0.9750	0.9967	0.8211	0.9824	0.8981	0.9321	0.9583
GneDfdFceHfcCnf	1.0082	1.0202	1.0155	0.9876	1.0078	0.9698	0.9779	0.9738	0.8998	0.9819
GneDfdFceHfcRnc	1.0064	1.0019	0.9954	0.9837	0.9968	0.9355	1.0012	0.9678	0.9305	0.9787
GneDfdFceHfcEdc	1.0065	0.9820	0.9840	0.9981	0.9926	0.9616	0.9929	0.9771	0.9217	0.9777
GneDfdFceHfcCom	1.0207	1.0284	0.9880	1.0142	1.0127	0.9163	0.9211	0.9187	0.8307	0.9574
GneCiiPnfMin	0.9698	0.9433	0.9757	0.9684	0.9642	0.9979	1.0084	1.0032	1.0669	0.9894
GneCiiPnfMan	0.9443	0.9879	0.9795	0.9547	0.9664	0.9504	0.9333	0.9418	1.0139	0.9659
GneCiiPnfWht	0.9650	1.0031	0.9691	1.0098	0.9865	0.9481	0.9750	0.9615	0.9895	0.9797
GneCiiPnfRet	0.9507	1.0012	0.9697	1.0074	0.9820	0.9816	0.9630	0.9722	0.9974	0.9814
GneCiiPnfOnf	0.9878	0.9978	0.9920	1.0117	0.9973	0.9595	0.9402	0.9498	1.0465	0.9903
GneCiiPba	0.9557	0.9145	0.9690	0.9701	0.9521	0.9696	1.0178	0.9934	1.2212	0.9986
GneCiiPfm	0.9707	0.9443	1.0172	1.0033	0.9835	0.9592	0.9056	0.9320	1.1074	0.9850
Sde	1.0085	0.9701	1.0198	1.0127	1.0026	0.9212	0.9457	0.9334	1.1245	0.9985
ExpMinImp	1.0344	0.9759	0.9523	0.9466	0.9767	0.8969	0.9728	0.9341	0.9008	0.9532

kah-wlsv-shr

Gdp	1.0494	1.0050	1.0262	1.0119	1.0230	0.8543	0.9134	0.8834	0.7892	0.9453
Tfi	0.9400	1.0209	0.9677	0.9527	0.9699	0.8314	0.9182	0.8737	0.7714	0.9111
TfiGos	0.9685	0.9659	0.9677	0.9348	0.9591	0.9693	0.9825	0.9758	0.8994	0.9551
TfiCoe	0.9856	0.9586	0.9890	0.9539	0.9716	0.8569	0.8893	0.8730	0.7155	0.9021
TfiGosCop	0.9426	0.9977	1.0043	0.9725	0.9790	0.9294	0.9729	0.9509	0.9317	0.9641
TfiGosCopNfn	0.9565	0.9481	0.9451	0.9383	0.9470	0.9169	0.9544	0.9355	0.9222	0.9401
Gne	0.9668	1.0589	0.9604	1.0215	1.0011	0.9473	0.9441	0.9457	0.8196	0.9572

GneDfd	1.0008	1.0197	1.0155	1.0708	1.0264	0.8925	0.9881	0.9391	0.8350	0.9716
GneCii	0.9889	1.0053	1.0034	0.9549	0.9879	0.8202	0.8146	0.8174	0.8531	0.9164
GneDfdFce	0.9782	0.9560	0.9549	0.9311	0.9549	0.9102	0.8950	0.9025	0.8345	0.9217
GneDfdGfc	0.9800	0.9599	0.9481	0.9660	0.9634	0.9344	0.9394	0.9369	0.7774	0.9269
GneCiiPnf	0.9085	0.9122	0.9439	0.9983	0.9400	0.9023	0.8496	0.8755	0.8323	0.9053
GneDfdFceGvt	0.9257	0.9368	0.9518	0.9602	0.9435	0.9134	0.9095	0.9114	0.8531	0.9209
GneDfdFceHfc	0.9753	1.0719	1.0115	0.9981	1.0135	0.8714	0.8591	0.8652	0.7629	0.9302
GneDfdGfcPub	0.9402	0.9617	0.9587	1.0199	0.9697	0.8874	0.9642	0.9250	0.9476	0.9536
GneDfdGfcPvt	0.9022	0.9339	0.9009	0.9283	0.9162	0.8610	0.8998	0.8802	0.7509	0.8804
GneDfdFceGvtNat	0.9358	0.9319	0.9289	0.9477	0.9361	0.9204	0.9200	0.9202	0.8858	0.9242
GneDfdGfcPubGvt	0.9382	0.9684	0.9194	0.9221	0.9368	0.8801	0.8917	0.8859	0.9098	0.9181
GneDfdGfcPubPcp	0.9211	0.9780	0.9475	0.9377	0.9459	0.9752	0.9729	0.9741	0.8965	0.9466
GneDfdGfcPvtTdw	1.0017	0.9872	0.9699	0.9593	0.9794	0.8184	0.9979	0.9037	0.8202	0.9332
GneDfdGfcPvtPbi	0.9186	0.9381	0.9471	0.9832	0.9465	0.9021	0.9583	0.9298	0.7137	0.9045
GneDfdFceHfcAbt	1.0274	1.0414	1.0015	1.0123	1.0206	0.9584	1.0108	0.9843	0.9285	0.9965
GneDfdFceHfcMis	0.9630	0.9924	1.0208	1.0302	1.0012	0.9110	0.9730	0.9415	0.9364	0.9744
GneDfdFceHfcTpt	0.9938	0.9709	0.9594	0.9615	0.9713	0.7421	0.8417	0.7903	0.7992	0.8906
GneDfdFceHfcHcr	0.9737	0.9626	0.9889	0.9755	0.9751	0.9593	1.0229	0.9906	0.8557	0.9614
GneDfdFceHfcHlt	0.9308	0.9732	0.9834	0.9973	0.9709	0.9766	0.9611	0.9688	0.9212	0.9630
GneDfdFceHfcFhe	0.9843	1.0135	1.0045	0.9888	0.9977	0.9201	0.9214	0.9208	0.8574	0.9542
GneDfdFceHfcHwe	0.8730	0.9100	0.9011	0.9545	0.9092	0.7513	0.8549	0.8014	0.716	0.8476
GneDfdGfcPubGvtNat	0.9712	0.9514	0.9906	0.9613	0.9685	0.9852	0.9648	0.9750	0.9454	0.9670
GneDfdGfcPvtPbiIpr	0.8684	0.9428	0.9109	0.9090	0.9074	0.8134	0.8564	0.8346	0.6892	0.8518
GneDfdGfcPvtPbiNdc	0.8789	0.8873	0.9066	0.9006	0.8933	0.8426	0.8826	0.8624	0.7220	0.8578
GneDfdGfcPvtPbiNdm	0.9623	0.9489	0.9599	0.9598	0.9577	0.9333	0.9727	0.9528	0.8412	0.9388
TfiGosCopNfmPub	1.0080	1.0197	1.0122	1.0079	1.0120	0.9690	0.9951	0.9820	0.9161	0.9891
TfiGosCopNfmPvt	1.0031	0.9878	0.9824	0.9933	0.9916	0.9394	0.9599	0.9496	0.9012	0.9661
TfiGosCopFin	0.9763	0.9855	0.9492	0.9693	0.9700	0.8983	1.0575	0.9746	0.8824	0.9583
TfiGosGvt	1.1027	1.0218	1.0220	1.0062	1.0375	0.7487	0.7972	0.7726	0.5026	0.8599
TfiGosDwl	1.0011	1.0093	0.9839	0.9873	0.9954	0.9406	0.9657	0.9531	0.7421	0.9427
TfiGmi	1.0601	1.0599	1.0668	1.0405	1.0568	0.9655	1.0251	0.9948	0.9826	1.0279
TfiCoeWns	1.0092	0.9698	1.0060	0.9714	0.9890	0.8410	0.8754	0.8580	0.7076	0.9053
TfiCoeEsc	1.0104	0.9888	1.0003	0.9802	0.9949	0.9219	0.9546	0.9381	0.8236	0.9523
Tsi	0.9785	1.0223	0.9870	0.9766	0.9909	0.9070	0.9235	0.9152	0.8861	0.9533
Sdi	1.0096	1.0057	1.0179	1.0008	1.0085	0.9660	0.9683	0.9672	1.0726	1.0053
GneDfdFceGvtNatNdf	0.9127	0.9511	0.9237	0.9385	0.9314	0.9121	0.9409	0.9264	0.8655	0.9203
GneDfdFceGvtNatDef	1.0035	1.0215	0.9695	0.9722	0.9914	0.9612	1.0016	0.9812	0.9201	0.9780
GneDfdFceGvtSnl	0.9273	0.9129	0.8933	0.8804	0.9033	0.8877	0.8564	0.8719	0.8187	0.8817
GneDfdGfcPubGvtNatNdf	0.9854	1.0115	1.0069	0.9908	0.9986	0.9861	1.0127	0.9993	0.9204	0.9872
GneDfdGfcPubGvtNatDef	0.9739	0.9938	1.0012	0.9160	0.9706	0.9161	0.9369	0.9264	0.9407	0.9535
GneDfdGfcPubGvtSnl	1.0368	0.9999	0.9772	1.0341	1.0117	0.9233	0.9962	0.9591	1.0312	0.9991
GneDfdGfcPubPcpCmw	0.9604	0.9916	1.0421	1.0238	1.0040	1.0193	1.0029	1.0111	0.8735	0.9862
GneDfdGfcPubPcpSnl	0.9325	0.9593	0.9409	0.9339	0.9416	0.9122	0.9104	0.9113	0.8712	0.9226
GneDfdGfcPvtTdwNnu	0.9841	1.0015	1.0017	1.0288	1.0039	0.7855	0.9766	0.8758	0.8465	0.9423
GneDfdGfcPvtTdwAna	0.9881	1.0156	0.9986	0.9940	0.9990	0.9086	0.9988	0.9526	0.8993	0.9708
GneDfdGfcPvtPbiIprRnd	1.0803	1.0529	1.0506	1.0196	1.0506	0.7729	0.8334	0.8026	0.5217	0.8802
GneDfdGfcPvtPbiIprMnp	1.0163	1.0314	1.0434	1.0260	1.0292	0.8984	0.9762	0.9365	0.8303	0.9715
GneDfdGfcPvtPbiIprCom	1.0253	0.9986	0.9977	0.9933	1.0036	0.6914	0.7781	0.7335	0.6116	0.8549
GneDfdGfcPvtPbiIprArt	1.0202	1.0114	1.0180	0.9959	1.0113	0.7365	0.7679	0.7521	0.5401	0.8496
GneDfdGfcPvtPbiNdcNbd	1.0482	1.0514	1.0588	1.0474	1.0514	0.9712	1.0269	0.9986	0.8274	1.0012
GneDfdGfcPvtPbiNdcNec	0.9799	0.9740	0.9759	0.9379	0.9668	1.0050	0.9722	0.9884	0.7353	0.9356
GneDfdGfcPvtPbiNdcSha	0.9617	1.0211	1.0397	1.0240	1.0112	0.9380	0.9881	0.9627	0.9596	0.9897
GneDfdGfcPvtPbiNdmNew	0.9898	0.9781	0.9793	0.9852	0.9831	0.9110	0.9733	0.9416	0.8693	0.9542
GneDfdGfcPvtPbiNdmSha	1.0187	1.0018	1.0411	1.0279	1.0223	0.9760	0.9852	0.9806	0.9049	0.9927
GneDfdGfcPvtPbiCbr	0.9335	0.9436	0.9462	0.9559	0.9448	0.7475	0.9136	0.8264	0.7813	0.8850
GneDfdGfcPvtOtc	0.9951	0.9961	0.9559	0.9738	0.9801	0.8715	0.9898	0.9288	0.8192	0.9407
GneDfdFceHfcAbtAlc	0.9897	0.9489	0.9599	0.9528	0.9627	0.9612	0.9448	0.9530	0.8989	0.9505
GneDfdFceHfcAbtCig	0.9429	0.9556	0.9289	0.9749	0.9504	0.8796	0.9430	0.9108	0.9657	0.9410
GneDfdFceHfcMisOgd	1.0065	0.9846	0.9235	0.9143	0.9564	0.9216	0.9469	0.9342	0.8239	0.9300
GneDfdFceHfcMisOsv	1.0397	1.0150	1.0108	1.0037	1.0172	0.9137	0.9676	0.9402	0.7545	0.9530
GneDfdFceHfcMisIfs	0.8833	0.9256	0.8614	0.8869	0.8890	0.8813	0.9258	0.9033	0.9094	0.8960
GneDfdFceHfcTptTsv	1.0142	1.0127	0.9950	0.9804	1.0005	0.9309	0.9841	0.9571	0.8554	0.9660
GneDfdFceHfcTptPvh	0.9702	0.9672	0.9864	0.9944	0.9795	0.9345	0.9894	0.9616	0.9401	0.9686
GneDfdFceHfcTptOvh	1.0195	0.9951	0.9837	0.9823	0.9950	0.8899	0.9495	0.9192	0.8370	0.9490
GneDfdFceHfcHcrAsv	1.0071	0.9600	0.9707	0.9722	0.9774	0.9335	0.9781	0.9556	0.8913	0.9584
GneDfdFceHfcHcrCsv	0.9897	0.9806	0.9848	0.9760	0.9828	0.9309	0.9694	0.9500	0.8544	0.9540
GneDfdFceHfcHltHsv	0.9948	0.9991	1.0321	1.0108	1.0091	0.9446	1.0264	0.9846	0.8981	0.9855
GneDfdFceHfcHltMed	1.0318	0.9705	0.9514	0.9486	0.9750	0.9626	1.0065	0.9843	0.9423	0.9729
GneDfdFceHfcFheFnt	0.9886	0.9958	1.0254	1.0301	1.0098	0.9480	0.9853	0.9665	0.9585	0.9898
GneDfdFceHfcFheTls	1.0470	1.0106	1.0352	1.0114	1.0259	0.8761	0.9254	0.9004	0.8160	0.9566
GneDfdFceHfcFheApp	1.0154	1.0423	1.0211	1.0208	1.0248	0.9700	1.0660	1.0169	0.9607	1.0132

GneDfdFceHfcHweRnt	1.0676	0.9723	0.9575	0.9531	0.9865	0.8284	0.8146	0.8215	0.5911	0.8702
GneDfdFceHfcHweWsc	0.9515	0.9515	0.9426	0.9567	0.9506	0.9474	1.0013	0.9740	0.7869	0.9317
GneDfdFceHfcHweEgf	1.0002	0.9899	1.0007	0.9671	0.9894	0.9237	0.9227	0.9232	0.8407	0.9477
GneDfdFceHfcFud	1.0401	1.0267	1.0087	0.9959	1.0177	0.8425	1.0180	0.9261	0.9670	0.9834
GneDfdFceHfcCnf	0.9997	1.0190	1.0145	1.0019	1.0087	0.9688	0.9817	0.9752	0.9043	0.9836
GneDfdFceHfcRnc	0.9581	1.0061	0.9939	0.9984	0.9889	0.9204	1.0134	0.9658	0.9291	0.9735
GneDfdFceHfcEdc	1.0022	0.9763	0.9895	0.9859	0.9884	0.9590	0.9871	0.9730	0.9174	0.9736
GneDfdFceHfcCom	1.0619	1.0446	1.0476	1.0363	1.0476	0.9469	0.9583	0.9526	0.8570	0.9907
GneCiiPnfMin	0.9713	0.9209	0.9634	0.9664	0.9553	0.9984	0.9945	0.9964	1.0842	0.9845
GneCiiPnfMan	0.9448	0.9498	0.9779	0.9752	0.9618	0.9436	0.9305	0.9370	1.0104	0.9614
GneCiiPnfWhit	0.9200	0.9490	0.9367	0.9567	0.9405	0.9083	0.9349	0.9215	0.9486	0.9362
GneCiiPnfRet	0.9229	0.9848	0.9343	1.0003	0.9600	0.9457	0.9501	0.9479	0.9688	0.9578
GneCiiPnfOnf	1.0061	1.0020	1.0167	1.0074	1.0080	0.9723	0.9351	0.9535	1.0285	0.9950
GneCiiPba	0.9995	0.9898	1.0171	1.0323	1.0096	1.0514	1.0816	1.0664	1.4211	1.0768
GneCiiPfm	0.9531	0.9136	1.0038	0.9958	0.9659	0.9350	0.9296	0.9323	1.0869	0.9724
Sde	0.9668	0.9584	0.9669	0.9944	0.9716	0.9450	0.9829	0.9638	1.3484	1.0158
ExpMinImp	0.9775	0.9254	0.9352	0.9435	0.9452	0.8551	0.9516	0.9021	0.8757	0.9226
<i>ite-acov-shr</i>										
Gdp	1.0242	1.0096	1.0246	1.0205	1.0197	0.8467	0.9144	0.8799	0.7876	0.9422
Tfi	0.9246	1.0256	0.9679	0.9582	0.9684	0.8293	0.9187	0.8728	0.7694	0.9097
TfiGos	0.9706	0.9517	0.9690	0.9344	0.9563	0.9619	0.9793	0.9706	0.8955	0.9514
TfiCoe	0.9446	0.9576	0.9862	0.9701	0.9645	0.8524	0.8912	0.8716	0.7153	0.8978
TfiGosCop	0.9469	0.9828	1.0046	0.9725	0.9765	0.9244	0.9685	0.9462	0.9277	0.9607
TfiGosCopNfm	0.9591	0.9327	0.9487	0.9426	0.9457	0.9145	0.9546	0.9343	0.9212	0.9389
Gne	0.9520	1.0677	0.9550	1.0282	0.9995	0.9492	0.9497	0.9495	0.8202	0.9575
GneDfd	0.9900	1.0156	1.0123	1.0760	1.0230	0.8929	0.9949	0.9425	0.8362	0.9709
GneCii	1.0023	1.0060	0.9977	0.9491	0.9885	0.8276	0.8095	0.8185	0.8521	0.9170
GneDfdFce	0.9770	0.9466	0.9495	0.9241	0.9491	0.9010	0.8929	0.8969	0.8297	0.9161
GneDfdGfc	0.9689	0.9668	0.9398	0.9775	0.9632	0.9322	0.9481	0.9401	0.7808	0.9283
GneCiiPnf	0.9167	0.9198	0.9364	0.9924	0.9409	0.9063	0.8387	0.8719	0.8304	0.9043
GneDfdFceGvt	0.9281	0.9170	0.9469	0.9524	0.9360	0.9060	0.9075	0.9068	0.8455	0.9142
GneDfdFceHfc	0.9852	1.0666	1.0068	0.9983	1.0137	0.8691	0.8526	0.8608	0.7567	0.9279
GneDfdGfcPub	0.9414	0.9586	0.9437	0.9898	0.9582	0.8952	0.9548	0.9245	0.9427	0.9462
GneDfdGfcPvt	0.9065	0.9437	0.9009	0.9405	0.9227	0.8661	0.9114	0.8884	0.7553	0.8870
GneDfdFceGvtNat	0.9414	0.9119	0.9275	0.9511	0.9328	0.9154	0.9158	0.9156	0.8841	0.9208
GneDfdGfcPubGvt	0.9317	0.9814	0.9038	0.9168	0.9330	0.8842	0.8853	0.8848	0.9115	0.9159
GneDfdGfcPubPcp	0.9375	0.9624	0.9529	0.9136	0.9414	0.9787	0.9597	0.9692	0.8910	0.9418
GneDfdGfcPvtTdw	0.9798	0.9799	0.9918	0.9744	0.9815	0.7928	1.0151	0.8971	0.8238	0.9329
GneDfdGfcPvtPbi	0.9296	0.9418	0.9358	0.9969	0.9507	0.9053	0.9597	0.9321	0.7097	0.9066
GneDfdFceHfcAbt	1.0253	1.0399	1.0195	1.0080	1.0231	0.9617	1.0089	0.9850	0.9383	0.9996
GneDfdFceHfcMis	0.9871	0.9936	1.0186	1.0303	1.0073	0.9284	0.9752	0.9515	0.9354	0.9806
GneDfdFceHfcTpt	1.0037	0.9659	0.9514	0.9576	0.9694	0.7380	0.8368	0.7859	0.7952	0.8875
GneDfdFceHfcHcr	0.9718	0.9453	0.9787	0.9696	0.9663	0.9552	1.0121	0.9832	0.8449	0.9526
GneDfdFceHfcHlt	0.9330	0.9825	0.9668	0.9959	0.9693	0.9618	0.9539	0.9578	0.9132	0.9578
GneDfdFceHfcFhe	0.9774	1.0013	1.0214	0.9729	0.9931	0.9128	0.9164	0.9146	0.8544	0.9494
GneDfdFceHfcHwe	0.8925	0.9181	0.9100	0.9739	0.9231	0.7555	0.8717	0.8115	0.7272	0.8600
GneDfdGfcPubGvtNat	0.9646	0.9527	0.9725	0.9479	0.9594	0.9852	0.9520	0.9684	0.9428	0.9595
GneDfdGfcPvtPbiPr	0.8456	0.8774	0.9194	0.9187	0.8897	0.7562	0.8680	0.8102	0.6709	0.8320
GneDfdGfcPvtPbiNdc	0.8994	0.8939	0.9101	0.9013	0.9012	0.8494	0.8848	0.8669	0.7204	0.8632
GneDfdGfcPvtPbiNdm	0.9563	0.9744	0.9580	0.9573	0.9615	0.9341	0.9696	0.9517	0.8371	0.9399
TfiGosCopNfmPub	1.0117	1.0401	1.0049	1.0139	1.0175	0.9784	0.9953	0.9868	0.9259	0.9952
TfiGosCopNfmPvt	1.0015	0.9692	0.9856	0.9940	0.9875	0.9279	0.9619	0.9448	0.8999	0.9623
TfiGosCopFin	1.0127	0.9927	0.9622	0.9788	0.9864	0.9061	1.0513	0.9760	0.8747	0.9667
TfiGosGvt	0.7560	0.8411	1.1557	1.0509	0.9374	0.5402	0.8679	0.6847	0.4851	0.7800
TfiGosDwl	1.0060	0.9937	0.9799	0.9925	0.9930	0.9333	0.9682	0.9506	0.7424	0.9408
TfiGmi	1.1130	1.0652	1.0772	1.0424	1.0741	0.9790	1.0320	1.0052	0.9930	1.0422
TfiCoeWns	0.9691	0.9719	1.0043	0.9892	0.9835	0.8379	0.8794	0.8584	0.7115	0.9033
TfiCoeEsc	0.9742	0.9705	0.9922	0.9775	0.9786	0.9096	0.9481	0.9287	0.8125	0.9388
Tsi	0.9933	1.0239	0.9830	0.9754	0.9937	0.9034	0.9224	0.9129	0.8902	0.9548
Sdi	1.0110	1.0063	1.0214	1.0000	1.0096	0.9751	0.9771	0.9761	1.0827	1.0099
GneDfdFceGvtNatNdf	0.9121	0.9305	0.9169	0.9406	0.9250	0.9047	0.9425	0.9234	0.8622	0.9153
GneDfdFceGvtNatDef	1.0121	1.0047	0.9760	0.9588	0.9877	0.9612	0.9962	0.9785	0.9190	0.9750
GneDfdFceGvtSnl	0.9439	0.9137	0.9028	0.8874	0.9117	0.8857	0.8588	0.8721	0.8185	0.8865
GneDfdGfcPubGvtNatNdf	1.0247	1.0026	0.9855	0.9418	0.9882	0.9913	1.0109	1.0010	0.9336	0.9838
GneDfdGfcPubGvtNatDef	0.9453	0.9917	0.9653	0.8845	0.9459	0.9088	0.9064	0.9076	0.9486	0.9352
GneDfdGfcPubGvtSnl	1.0272	1.0159	0.9812	1.0253	1.0122	0.9310	1.0025	0.9661	1.0340	1.0018
GneDfdGfcPubPcpCmw	0.9490	1.0122	1.0341	1.0252	1.0046	1.0320	1.0101	1.0210	0.8811	0.9905
GneDfdGfcPubPcpSnl	0.9500	0.9484	0.9414	0.9130	0.9381	0.9126	0.8962	0.9044	0.8638	0.9175
GneDfdGfcPvtTdwNnu	0.9530	0.9862	1.0209	1.0493	1.0017	0.7642	0.9948	0.8719	0.8476	0.9401
GneDfdGfcPvtTdwAna	0.9851	1.0302	1.0023	1.0004	1.0044	0.9129	1.0052	0.9580	0.9043	0.9761

GneDfdGfcPvtPbiIprRnd	0.8281	0.9210	1.1872	1.0664	0.9913	0.5936	0.9026	0.7320	0.5028	0.8250
GneDfdGfcPvtPbiIprMmp	1.0104	1.0405	1.0238	1.0392	1.0284	0.8877	0.9769	0.9312	0.8274	0.9691
GneDfdGfcPvtPbiIprCom	0.7822	0.9018	1.1189	1.0363	0.9510	0.5528	0.8376	0.6804	0.5956	0.8084
GneDfdGfcPvtPbiIprArt	0.8207	0.9123	1.0975	1.0104	0.9546	0.6157	0.8012	0.7024	0.5123	0.8001
GneDfdGfcPvtPbiNdcNbd	1.0234	1.0313	1.0481	1.0254	1.0320	0.9596	1.0079	0.9835	0.8134	0.9839
GneDfdGfcPvtPbiNdcNec	0.9861	0.9836	0.9868	0.9549	0.9778	1.0131	0.9744	0.9936	0.7389	0.9437
GneDfdGfcPvtPbiNdcSha	0.9848	1.0751	1.0850	1.0697	1.0529	0.9576	1.0008	0.9789	0.9723	1.0195
GneDfdGfcPvtPbiNdmNew	0.9953	0.9995	0.9837	0.9783	0.9892	0.9125	0.9716	0.9416	0.8667	0.9571
GneDfdGfcPvtPbiNdmSha	1.0195	1.0217	1.0401	1.0452	1.0315	0.9840	0.9950	0.9895	0.9106	1.0013
GneDfdGfcPvtPbiCbr	0.8936	0.9616	0.9512	0.9088	0.9284	0.7420	0.8748	0.8057	0.7479	0.8644
GneDfdGfcPvtOtc	0.9913	0.9886	0.9669	0.9878	0.9836	0.8668	1.0022	0.9320	0.8268	0.9448
GneDfdFceHfcAbtAlc	0.9703	0.9639	0.9835	0.9413	0.9646	0.9648	0.9536	0.9592	0.8975	0.9532
GneDfdFceHfcAbtCig	0.9411	0.9646	0.9441	0.9605	0.9525	0.8870	0.9398	0.9130	0.9710	0.9436
GneDfdFceHfcMisOgd	0.9506	0.9871	0.9125	0.9109	0.9398	0.9038	0.9425	0.9230	0.8150	0.9161
GneDfdFceHfcMisOsv	1.0460	0.9986	1.0111	1.0058	1.0152	0.9010	0.9652	0.9325	0.7501	0.9490
GneDfdFceHfcMisIfs	0.8983	0.9104	0.8671	0.8845	0.8900	0.8766	0.9283	0.9021	0.9105	0.8963
GneDfdFceHfcTptTsv	1.0140	1.0288	0.9873	0.9859	1.0038	0.9340	0.9869	0.9601	0.8585	0.9692
GneDfdFceHfcTptPvh	0.9733	0.9712	0.9828	0.9949	0.9805	0.9359	0.9895	0.9623	0.9429	0.9698
GneDfdFceHfcTptOvh	1.0166	1.0015	0.9802	0.9879	0.9965	0.8954	0.9492	0.9219	0.8357	0.9504
GneDfdFceHfcHcrAsv	1.0096	0.9487	0.9633	0.9851	0.9764	0.9318	0.9747	0.9530	0.8941	0.9575
GneDfdFceHfcHcrCsv	0.9914	0.9780	0.9856	0.9765	0.9829	0.9414	0.9598	0.9505	0.8475	0.9531
GneDfdFceHfcHltHsv	0.9922	1.0121	1.0287	1.0081	1.0102	0.9385	1.0207	0.9788	0.8947	0.9839
GneDfdFceHfcHltMed	1.0439	0.9822	0.9441	0.9457	0.9781	0.9557	1.0018	0.9785	0.9330	0.9717
GneDfdFceHfcFheFnt	0.9936	0.9959	1.0427	1.0014	1.0082	0.9435	0.9815	0.9623	0.9533	0.9869
GneDfdFceHfcFheTls	1.0353	1.0084	1.0252	1.0063	1.0187	0.8686	0.9224	0.8951	0.8110	0.9503
GneDfdFceHfcFheApp	1.0151	1.0406	1.0372	1.0270	1.0299	0.9612	1.0763	1.0171	0.9641	1.0166
GneDfdFceHfcHweRnt	1.0330	0.9732	0.9743	0.9696	0.9872	0.8193	0.8321	0.8257	0.5996	0.8736
GneDfdFceHfcHweWsc	0.9706	0.9539	0.9626	0.9656	0.9632	0.9606	1.0010	0.9806	0.7883	0.9408
GneDfdFceHfcHweEgf	1.0164	0.9868	1.0145	0.9834	1.0002	0.9268	0.9262	0.9265	0.8444	0.9552
GneDfdFceHfcFud	1.0478	1.0069	1.0062	1.0016	1.0155	0.8308	1.0162	0.9188	0.9569	0.9785
GneDfdFceHfcCnf	1.0058	1.0154	1.0241	1.0141	1.0149	0.9783	0.9938	0.9860	0.9118	0.9913
GneDfdFceHfcRnc	0.9824	1.0014	1.0120	0.9771	0.9931	0.9254	1.0085	0.9661	0.9333	0.9766
GneDfdFceHfcEdc	0.9985	0.9801	0.9907	0.9981	0.9918	0.9569	0.9917	0.9741	0.9244	0.9769
GneDfdFceHfcCom	1.0517	1.0564	1.0063	1.0393	1.0383	0.9338	0.9417	0.9378	0.8417	0.9787
GneCiiPnfMin	0.9649	0.9201	0.9686	0.9745	0.9568	1.0062	0.9843	0.9952	1.0820	0.9847
GneCiiPnfMan	0.9459	0.9647	0.9896	0.9799	0.9699	0.9533	0.9309	0.9421	1.0201	0.9688
GneCiiPnfWht	0.9311	0.9515	0.9424	0.9787	0.9508	0.9081	0.9430	0.9254	0.9421	0.9422
GneCiiPnfRet	0.9211	0.9806	0.9514	1.0023	0.9634	0.9420	0.9553	0.9486	0.9765	0.9610
GneCiiPnfOnf	0.9978	1.0094	1.0097	1.0115	1.0071	0.9671	0.9324	0.9496	1.0235	0.9926
GneCiiPba	0.9861	0.9649	1.0178	1.0694	1.0088	1.0508	1.0858	1.0681	1.3996	1.0745
GneCiiPfm	0.9658	0.9413	1.0154	0.9911	0.9780	0.9472	0.9209	0.9339	1.0909	0.9804
Sde	0.9582	0.9402	0.9629	1.0029	0.9658	0.9379	0.9783	0.9579	1.3315	1.0087
ExpMinImp	0.9767	0.9343	0.9321	0.9457	0.9470	0.8567	0.9550	0.9045	0.8722	0.9238
<i>oct-acov</i>										
Gdp	1.0454	0.9965	1.0261	1.0262	1.0234	0.8358	0.9208	0.8773	0.7866	0.9432
Tfi	0.9241	1.0132	0.9659	0.9651	0.9666	0.8100	0.9254	0.8657	0.7682	0.9064
TfiGos	0.9700	0.9693	0.9755	0.9505	0.9663	0.9806	0.9908	0.9857	0.9081	0.9632
TfiCoe	0.9962	0.9799	0.9912	0.9667	0.9834	0.8801	0.8988	0.8894	0.7247	0.9148
TfiGosCop	0.9454	0.9999	1.0079	0.9853	0.9843	0.9368	0.9760	0.9562	0.9319	0.9686
TfiGosCopNfm	0.9613	0.9523	0.9560	0.9391	0.9522	0.9276	0.9661	0.9466	0.9289	0.9472
Gne	0.9896	1.0818	0.9765	1.0391	1.0209	0.9560	0.9564	0.9562	0.827	0.9723
GneDfd	1.0261	1.0204	1.0259	1.0750	1.0366	0.8983	0.9938	0.9448	0.8350	0.9788
GneCii	1.0011	1.0245	1.0119	0.9737	1.0026	0.8363	0.8495	0.8428	0.8936	0.9385
GneDfdFce	1.0005	0.9825	0.9771	0.9504	0.9774	0.9184	0.9212	0.9198	0.8532	0.9421
GneDfdGfc	0.9645	0.9451	0.9387	0.9502	0.9496	0.9144	0.9309	0.9226	0.7667	0.9134
GneCiiPnf	0.9354	0.9440	0.9477	0.9964	0.9556	0.9185	0.8837	0.9009	0.8770	0.9282
GneDfdFceGvt	0.9620	0.9776	1.0046	1.0028	0.9866	0.9519	0.9432	0.9475	0.8887	0.9608
GneDfdFceHfc	0.9857	1.0674	1.0122	1.0181	1.0205	0.8706	0.8673	0.8689	0.7647	0.9353
GneDfdGfcPub	0.9356	0.9715	0.9660	1.0090	0.9702	0.8886	0.9730	0.9299	0.9607	0.9572
GneDfdGfcPvt	0.9373	0.9360	0.9105	0.9136	0.9243	0.8848	0.8987	0.8917	0.7487	0.8877
GneDfdFceGvtNat	0.9654	0.9414	0.9491	0.9741	0.9574	0.9333	0.9268	0.9300	0.9033	0.9417
GneDfdGfcPubGvt	0.9277	0.9700	0.9031	0.9090	0.9271	0.8785	0.8851	0.8818	0.9108	0.9116
GneDfdGfcPubPep	0.9322	0.9745	0.9778	0.9442	0.9570	0.9674	0.9952	0.9812	0.9124	0.9573
GneDfdGfcPvtTdw	0.9792	0.9630	0.9795	0.9589	0.9701	0.7812	1.0043	0.8857	0.8083	0.9209
GneDfdGfcPvtPbi	0.9484	0.9473	0.9631	0.9779	0.9591	0.9234	0.9683	0.9456	0.7205	0.9170
GneDfdFceHfcAbt	1.0346	1.0346	0.9975	1.0029	1.0173	0.9626	1.0008	0.9815	0.9209	0.9927
GneDfdFceHfcMis	0.9900	0.9949	1.0037	1.0294	1.0044	0.9198	0.9554	0.9374	0.9245	0.9732
GneDfdFceHfcTpt	1.0000	0.9795	0.9780	0.9903	0.9869	0.7431	0.8703	0.8042	0.8210	0.9067
GneDfdFceHfcHcr	0.9654	0.9378	0.9855	0.9923	0.9700	0.9443	1.0354	0.9888	0.8538	0.9578
GneDfdFceHfcHlt	0.9275	0.9881	0.9886	0.9952	0.9744	0.9773	0.9651	0.9712	0.9266	0.9666

GneDfdFceHfcFhe	0.9850	1.0022	0.9836	0.9649	0.9838	0.9251	0.8991	0.9120	0.8471	0.9424
GneDfdFceHfcHwe	0.8912	0.9129	0.9134	0.9780	0.9233	0.7517	0.8710	0.8092	0.7237	0.8587
GneDfdGfcPubGvtNat	0.9581	0.9644	0.9755	0.9467	0.9611	0.9693	0.9390	0.9541	0.9266	0.9541
GneDfdGfcPvtPbiIpr	0.8702	0.8720	0.9239	0.9372	0.9003	0.7509	0.8775	0.8118	0.6742	0.8387
GneDfdGfcPvtPbiNdc	0.9266	0.8953	0.9375	0.9078	0.9167	0.8570	0.8921	0.8744	0.7253	0.8746
GneDfdGfcPvtPbiNdm	0.9614	1.0097	0.9957	0.9993	0.9913	0.9775	1.0001	0.9887	0.8832	0.9744
TfiGosCopNfnPub	0.9640	1.0273	1.0036	0.9987	0.9982	0.9426	0.9759	0.9591	0.8974	0.9720
TfiGosCopNfnPvt	1.0012	0.9884	0.9941	1.0062	0.9975	0.9475	0.9736	0.9605	0.9127	0.9743
TfiGosCopFin	0.9899	0.9901	0.9572	0.9778	0.9787	0.8915	1.0480	0.9666	0.8685	0.9587
TfiGosGvt	0.7044	0.8379	1.1623	1.0571	0.9228	0.5273	0.8758	0.6796	0.4879	0.7720
TfiGosDwl	1.0140	1.0014	0.9799	1.0074	1.0006	0.9332	0.9773	0.9550	0.7473	0.9470
TfiGmi	1.1254	1.0513	1.0801	1.0948	1.0876	0.9791	1.0546	1.0162	0.9945	1.0531
TfiCoeWns	1.0178	0.9887	1.0015	0.9825	0.9975	0.8579	0.8821	0.8699	0.718	0.9153
TfiCoeEsc	1.0036	1.0101	1.0144	0.9899	1.0045	0.9320	0.9674	0.9495	0.8345	0.9626
Tsi	0.9821	1.0015	0.9829	0.9816	0.9870	0.8884	0.9217	0.9049	0.8862	0.9481
Sdi	1.0405	0.9944	1.0290	1.0080	1.0178	0.9492	0.9525	0.9508	1.0628	1.0044
GneDfdFceGvtNatNdf	0.9341	0.9588	0.9289	0.9537	0.9438	0.9193	0.9471	0.9331	0.8734	0.9304
GneDfdFceGvtNatDef	1.0125	1.0061	0.9825	0.9764	0.9943	0.9579	1.0138	0.9854	0.9267	0.9818
GneDfdFceGvtSnl	0.9482	0.9786	0.9383	0.9238	0.9470	0.9301	0.9072	0.9185	0.8634	0.9265
GneDfdGfcPubGvtNatNdf	1.0132	1.0002	1.0197	0.9609	0.9982	0.9862	1.0226	1.0043	0.9539	0.9935
GneDfdGfcPubGvtNatDef	0.9578	1.0096	0.9734	0.8759	0.9529	0.8944	0.9134	0.9039	0.9284	0.9351
GneDfdGfcPubGvtSnl	1.0333	1.0103	0.9714	1.0095	1.0059	0.9234	0.9968	0.9594	1.0251	0.9951
GneDfdGfcPubPcpCmw	0.9640	0.9926	1.0465	1.0424	1.0108	1.0022	1.0021	1.0021	0.8743	0.9876
GneDfdGfcPubPcpSnl	0.9517	0.9707	0.9811	0.9354	0.9596	0.9280	0.9376	0.9327	0.8916	0.9419
GneDfdGfcPvtTdwNnu	0.9504	0.9576	1.0210	1.0275	0.9885	0.7371	0.9851	0.8521	0.8284	0.9238
GneDfdGfcPvtTdwAna	1.0098	1.0253	0.9974	1.0061	1.0096	0.9171	0.9984	0.9569	0.9012	0.9782
GneDfdGfcPvtPbiIprRnd	1.0054	0.9995	1.2192	1.0741	1.0710	0.618	0.9157	0.7523	0.5112	0.8711
GneDfdGfcPvtPbiIprMnp	1.0384	1.0475	1.0466	1.0701	1.0506	0.9086	0.9882	0.9476	0.8380	0.9877
GneDfdGfcPvtPbiIprCom	0.9519	0.9128	1.1267	1.0336	1.0029	0.5665	0.8405	0.6900	0.5979	0.8371
GneDfdGfcPvtPbiIprArt	0.8251	0.9161	1.1070	1.0222	0.9617	0.6175	0.8097	0.7071	0.5179	0.8063
GneDfdGfcPvtPbiNdcNbd	1.0432	1.0620	1.0711	1.0576	1.0584	0.9743	1.0336	1.0035	0.826	1.0062
GneDfdGfcPvtPbiNdcNec	0.9837	1.0296	1.0241	0.9752	1.0029	1.0451	0.9893	1.0168	0.7536	0.9666
GneDfdGfcPvtPbiNdcSha	0.9998	1.0050	1.0918	1.1749	1.0655	0.9775	1.0259	1.0014	1.0044	1.0380
GneDfdGfcPvtPbiNdmNew	0.9894	1.0252	1.0091	1.0162	1.0099	0.9470	0.9970	0.9717	0.9063	0.9835
GneDfdGfcPvtPbiNdmSha	1.0212	1.0574	1.0137	1.0520	1.0359	1.0007	0.9742	0.9873	0.9023	1.0018
GneDfdGfcPvtPbiCbr	0.8738	0.9485	0.9550	0.9182	0.9233	0.7302	0.8794	0.8013	0.748	0.8604
GneDfdGfcPvtOtc	0.9914	1.0085	0.9928	1.0014	0.9985	0.8749	1.0122	0.9411	0.8323	0.9565
GneDfdFceHfcAbtAlc	0.9653	0.9614	0.9737	0.9655	0.9665	0.9597	0.9541	0.9569	0.9026	0.9544
GneDfdFceHfcAbtCig	0.9633	0.9598	0.9097	0.9332	0.9412	0.9029	0.9136	0.9082	0.9515	0.9331
GneDfdFceHfcMisOgd	1.0029	1.0128	0.9361	0.9283	0.9693	0.9345	0.9688	0.9515	0.8535	0.9468
GneDfdFceHfcMisOsv	1.0611	1.0073	1.0198	1.0086	1.0240	0.9041	0.9731	0.9380	0.7572	0.9565
GneDfdFceHfcMisIfs	0.8949	0.9183	0.8645	0.8716	0.8871	0.8790	0.9176	0.8981	0.9053	0.8928
GneDfdFceHfcTptTsv	1.0074	1.0218	0.9846	1.0010	1.0036	0.9308	0.9895	0.9598	0.8650	0.9701
GneDfdFceHfcTptPvh	0.9883	0.9779	0.9881	0.9901	0.9861	0.9350	0.9959	0.9650	0.9387	0.9732
GneDfdFceHfcTptOvh	1.0169	1.0142	0.9986	1.0114	1.0102	0.9021	0.9715	0.9362	0.8478	0.9641
GneDfdFceHfcHerAsv	1.0172	0.9578	0.9782	1.0020	0.9886	0.9388	0.9993	0.9686	0.9055	0.9706
GneDfdFceHfcHerCsv	0.9703	0.9594	0.9762	0.9891	0.9737	0.9151	0.9743	0.9442	0.8455	0.9459
GneDfdFceHfcHltHsv	1.0212	1.0221	1.0394	1.0166	1.0248	0.9542	1.0256	0.9892	0.9028	0.9963
GneDfdFceHfcHltMed	1.0267	0.9808	0.9551	0.9510	0.9780	0.9639	1.0150	0.9891	0.9602	0.9786
GneDfdFceHfcFheFnt	0.9928	0.9990	1.0230	1.0124	1.0067	0.9524	0.9775	0.9648	0.9557	0.9872
GneDfdFceHfcFheTls	1.0442	1.0158	1.0368	1.0197	1.0291	0.8749	0.9279	0.9010	0.8185	0.9588
GneDfdFceHfcFheApp	1.0123	1.0130	0.9845	0.9791	0.9971	0.9384	1.0226	0.9796	0.9177	0.9804
GneDfdFceHfcHweRnt	1.0223	0.9708	0.9665	0.9562	0.9786	0.8078	0.8234	0.8156	0.5895	0.8641
GneDfdFceHfcHweWsc	0.9284	0.9547	0.9543	0.9663	0.9508	0.9414	1.0037	0.9721	0.7886	0.9316
GneDfdFceHfcHweEgf	0.9852	0.9844	1.0519	0.9956	1.0039	0.8981	0.9550	0.9261	0.8429	0.9568
GneDfdFceHfcFud	1.0426	0.9942	0.9803	0.9757	0.9979	0.8274	0.9869	0.9036	0.9358	0.9611
GneDfdFceHfcCnf	1.0087	1.0102	1.0150	0.9852	1.0047	0.9720	0.9775	0.9748	0.8997	0.9805
GneDfdFceHfcRnc	1.0004	1.0210	1.0193	1.0057	1.0115	0.9434	1.0195	0.9807	0.9478	0.9933
GneDfdFceHfcEdc	1.0182	0.9791	0.9823	0.9953	0.9936	0.9655	0.9824	0.9739	0.9208	0.9772
GneDfdFceHfcCom	1.0353	1.0345	0.9993	1.0186	1.0218	0.9220	0.9292	0.9256	0.8269	0.9638
GneCiiPnfMin	0.9593	0.9402	0.9651	0.9540	0.9546	0.9967	0.9899	0.9933	1.0805	0.9827
GneCiiPnfMan	0.9479	0.9816	0.9546	0.9731	0.9642	0.9688	0.9405	0.9545	1.0339	0.9711
GneCiiPnfWht	0.9209	0.9553	0.9461	0.9610	0.9457	0.9198	0.9334	0.9266	0.9569	0.9418
GneCiiPnfRet	0.9290	0.9761	0.9429	1.0072	0.9633	0.9375	0.9668	0.9520	0.9717	0.9613
GneCiiPnfOnf	0.9938	1.0089	0.9933	1.0167	1.0031	0.9611	0.9411	0.9510	1.0511	0.9946
GneCiiPnfPba	0.9973	1.0081	0.9932	1.0268	1.0063	1.0640	1.0868	1.0753	1.4440	1.0798
GneCiiPnfPfm	0.9783	0.9406	1.0096	0.9930	0.9801	0.9488	0.9102	0.9293	1.0868	0.9796
Sde	0.9707	0.9030	0.9628	1.0160	0.9623	0.9072	0.9484	0.9276	1.2850	0.9924
ExpMinImp	0.9813	0.9301	0.9358	0.9389	0.9463	0.8468	0.9607	0.9020	0.8625	0.9211

Table A.4: Variables, series IDs and their descriptions for the Expenditure Approach

Variable	Series ID	Description
Gdp	A2302467A	GDP - Gross Domestic Product
Sde	A2302566J	Statistical Discrepancy(E)
Exp	A2302564C	Exports of goods and services
Imp	A2302565F	Imports of goods and services
Gne	A2302563A	Gross national exp.
GneDfdFceGvtNatDef	A2302523J	Gen. gov. - National; Final consumption exp. - Defence
GneDfdFceGvtNatNdf	A2302524K	Gen. gov. - National; Final consumption exp. - Non-defence
GneDfdFceGvtNat	A2302525L	Gen. gov. - National; Final consumption exp.
GneDfdFceGvtSnl	A2302526R	Gen. gov. - State and local; Final consumption exp,
GneDfdFceGvt	A2302527T	Gen. gov.; Final consumption exp.
GneDfdFce	A2302529W	All sectors; Final consumption exp.
GneDfdGfcPvtTdwNnu	A2302543T	Pvt.; Gross fixed capital formation (GFCF)
GneDfdGfcPvtTdwAna	A2302544V	Pvt.; GFCF - Dwellings - Alterations and additions
GneDfdGfcPvtTdw	A2302545W	Pvt.; GFCF - Dwellings - Total
GneDfdGfcPvtOtc	A2302546X	Pvt.; GFCF - Ownership transfer costs
GneDfdGfcPvtPbiNdcNbd	A2302533L	Pvt. GFCF - Non-dwelling construction - New building
GneDfdGfcPvtPbiNdcNec	A2302534R	Pvt.; GFCF - Non-dwelling construction - New engineering construction
GneDfdGfcPvtPbiNdcSha	A2302535T	Pvt.; GFCF - Non-dwelling construction - Net purchase of second hand assets
GneDfdGfcPvtPbiNdc	A2302536V	Pvt.; GFCF - Non-dwelling construction - Total
GneDfdGfcPvtPbiNdmNew	A2302530F	Pvt.; GFCF - Machinery and equipment - New
GneDfdGfcPvtPbiNdmSha	A2302531J	Pvt.; GFCF - Machinery and equipment - Net purchase of second hand assets
GneDfdGfcPvtPbiNdm	A2302532K	Pvt.; GFCF - Machinery and equipment - Total
GneDfdGfcPvtPbiCbr	A2716219R	Pvt.; GFCF - Cultivated biological resources
GneDfdGfcPvtPbiIprRnd	A2716221A	Pvt.; GFCF - Intellectual property products - Research and development
GneDfdGfcPvtPbiIprMnp	A2302539A	Pvt.; GFCF - Intellectual property products - Mineral and petroleum exploration
GneDfdGfcPvtPbiIprCom	A2302538X	Pvt.; GFCF - Intellectual property products - Computer software
GneDfdGfcPvtPbiIprArt	A2302540K	Pvt.; GFCF - Intellectual property products - Artistic originals
GneDfdGfcPvtPbiIpr	A2716220X	Pvt.; GFCF - Intellectual property products Total
GneDfdGfcPvtPbi	A2302542R	Pvt.; GFCF - Total private business investment
GneDfdGfcPvt	A2302547A	Pvt.; GFCF
GneDfdGfcPubPcpCmw	A2302548C	Plc. corporations - Commonwealth; GFCF
GneDfdGfcPubPcpSnl	A2302549F	Plc. corporations - State and local; GFCF
GneDfdGfcPubPcp	A2302550R	Plc. corporations; GFCF Total
GneDfdGfcPubGvtNatDef	A2302551T	Gen. gov. - National; GFCF - Defence
GneDfdGfcPubGvtNatNdf	A2302552V	Gen. gov. - National ; GFCF - Non-defence
GneDfdGfcPubGvtNat	A2302553W	Gen. gov. - National ; GFCF Total
GneDfdGfcPubGvtSnl	A2302554X	Gen. gov. - State and local; GFCF
GneDfdGfcPubGvt	A2302555A	Gen. gov.; GFCF
GneDfdGfcPub	A2302556C	Plc.; GFCF
GneDfdGfc	A2302557F	All sectors; GFCF

Source: Athanasopoulos et al. (2019).

Table A.5: Variables, series IDs and their descriptions for Household Final Consumption - Expenditure Approach

Variable	Series ID	Description
GneDfdHfc	A2302254W	Household Final Consumption Expenditure
GneDfdFceHfcFud	A2302237V	Food
GneDfdFceHfcAbt	A3605816F	Alcoholic beverages and tobacco
GneDfdFceHfcAbtCig	A2302238W	Cigarettes and tobacco
GneDfdFceHfcAbtAlc	A2302239X	Alcoholic beverages
GneDfdFceHfcCnf	A2302240J	Clothing and footwear
GneDfdFceHfcHwe	A3605680F	Housing, water, electricity, gas and other fuels
GneDfdFceHfcHweRnt	A3605681J	Actual and imputed rent for housing
GneDfdFceHfcHweWsc	A3605682K	Water and sewerage charges
GneDfdFceHfcHweEgf	A2302242L	Electricity, gas and other fuel
GneDfdFceHfcFhe	A2302243R	Furnishings and household equipment
GneDfdFceHfcFheFnt	A3605683L	Furniture, floor coverings and household goods
GneDfdFceHfcFheApp	A3605684R	Household appliances
GneDfdFceHfcFheTls	A3605685T	Household tools
GneDfdFceHfcHlt	A2302244T	Health
GneDfdFceHfcHltMed	A3605686V	Medicines, medical aids and therapeutic appliances
GneDfdFceHfcHltHsv	A3605687W	Total health services
GneDfdFceHfcTpt	A3605688X	Transport
GneDfdFceHfcTptPvh	A2302245V	Purchase of vehicles
GneDfdFceHfcTptOvh	A2302246W	Operation of vehicles
GneDfdFceHfcTptTsv	A2302247X	Transport services
GneDfdFceHfcCom	A2302248A	Communications
GneDfdFceHfcRnc	A2302249C	Recreation and culture
GneDfdFceHfcEdc	A2302250L	Education services
GneDfdFceHfcHcr	A2302251R	Hotels, cafes and restaurants
GneDfdFceHfcHcrCsv	A3605694V	Catering services
GneDfdFceHfcHcrAsv	A3605695W	Accommodation services
GneDfdFceHfcMis	A3605696X	Miscellaneous goods and services
GneDfdFceHfcMisOgd	A3605697A	Other goods
GneDfdFceHfcMisIfs	A2302252T	Insurance and other financial services
GneDfdFceHfcMisOsv	A3606485T	Other services

Source: Athanasopoulos et al. (2019).

Table A.6: Variables, series IDs and their descriptions for Changes in Inventories - Expenditure Approach

Variable	Series ID	Description
GneCii	A2302562X	Changes in Inventories
GneCiiPfm	A2302560V	Farm
GneCiiPba	A2302561W	Public authorities
GneCiiPnf	A2302559K	Private; Non-farm Total
GneCiiPnfMin	A83722619L	Private; Mining (B)
GneCiiPnfMan	A3348511X	Private; Manufacturing (C)
GneCiiPnfWht	A3348512A	Private; Wholesale trade (F)
GneCiiPnfRet	A3348513C	Private; Retail trade (G)
GneCiiPnfOnf	A2302273C	Private; Non-farm; Other non-farm industries

Source: Athanasopoulos et al. (2019).

Table A.7: Variables, series IDs and their descriptions for the Income approach

Variable	Series ID	Description
Sdi	A2302413V	Statistical discrepancy (I)
Tsi	A2302412T	Taxes less subsidies (I)
TfiCoeWns	A2302399K	Compensation of employees; Wages and salaries
TfiCoeEsc	A2302400J	Compensation of employees; Employers' social contributions
TfiCoe	A2302401K	Compensation of employees
TfiGosCopNfnPvt	A2323369L	Private non-financial corporations; Gross operating surplus
TfiGosCopNfnPub	A2302403R	Public non-financial corporations; Gross operating surplus
TfiGosCopNfn	A2302404T	Non-financial corporations; Gross operating surplus
TfiGosCopFin	A2302405V	Financial corporations; Gross operating surplus
TfiGosCop	A2302406W	Total corporations; Gross operating surplus
TfiGosGvt	A2298711F	General government; Gross operating surplus
TfiGosDwl	A2302408A	Dwellings owned by persons; Gross operating surplus
TfiGos	A2302409C	All sectors; Gross operating surplus
TfiGmi	A2302410L	Gross mixed income
Tfi	A2302411R	Total factor income

Source: Athanasopoulos et al. (2019).

A.8.2 Cross-sectional & temporal reconciliation procedures

Table A.8: AvgRelMSE at any temporal aggregation level and any forecast horizon.

Procedure	Quarterly					Semi-annual			Annual	All
	1	2	3	4	1-4	1	2	1-2	1	
<i>all 95 series</i>										
base	1	1	1	1	1	1	1	1	1	1
cs-ols	1.2189	1.1663	1.1631	1.1510	1.1745	1.1427	1.1428	1.1427	1.2238	1.1722
cs-struct	1.1911	1.1363	1.1248	1.1049	1.1388	1.1058	1.0733	1.0894	1.1046	1.1196
cs-wls	0.9619	0.9698	0.9730	0.9778	0.9706	0.9613	0.9741	0.9677	0.9724	0.9700
cs-shr	0.9583	0.9701	0.9757	0.9824	0.9716	0.9526	0.9781	0.9652	0.9657	0.9689
t-bu	1	1	1	1	1	0.8476	0.9475	0.8961	0.7885	0.9368
t-ols	1.3297	1.1369	1.0590	1.0225	1.1311	1.0380	0.9840	1.0106	0.8603	1.0533
t-struct	1.1581	1.0538	1.0105	0.9926	1.0519	0.9263	0.9450	0.9356	0.8042	0.9790
t-wlsh	0.9893	0.9994	1.0004	0.9891	0.9945	0.8364	0.9369	0.8853	0.7747	0.9283
t-wlsv	1.0017	0.9994	0.9875	0.9853	0.9934	0.8444	0.9316	0.8869	0.7729	0.9279
t-shr	1.0005	1.0067	1.0183	1.0065	1.0080	0.8378	0.9507	0.8924	0.7805	0.9386
t-acov	0.9780	0.9912	0.9986	0.9888	0.9891	0.8253	0.9353	0.8786	0.7694	0.9225
t-strar1	1.1578	1.0545	1.0112	0.9929	1.0522	0.9267	0.9454	0.9360	0.8045	0.9793
t-sar1	1.0018	0.9994	0.9875	0.9854	0.9935	0.8445	0.9317	0.8870	0.7729	0.9279
t-har1	0.9886	0.9995	1.0005	0.9894	0.9945	0.8366	0.9372	0.8855	0.7749	0.9284
<i>32 upper series</i>										
base	1	1	1	1	1	1	1	1	1	1
cs-ols	0.9713	0.9767	0.9798	0.9852	0.9782	0.9508	0.9854	0.9679	1.0166	0.9807
cs-struct	0.9720	0.9696	0.9655	0.9610	0.9670	0.9480	0.9486	0.9483	0.9602	0.9607
cs-wls	0.9271	0.9324	0.9349	0.9323	0.9317	0.9256	0.9310	0.9283	0.9255	0.9298
cs-shr	0.9157	0.9270	0.9300	0.9315	0.9260	0.9174	0.9387	0.9280	0.9232	0.9262
t-bu	1	1	1	1	1	0.8487	0.9486	0.8973	0.7714	0.9342
t-ols	1.2332	1.1338	1.0538	1.0386	1.1122	1.0203	0.9950	1.0076	0.8555	1.0415
t-struct	1.0944	1.0565	1.0106	1.0057	1.0412	0.9180	0.9555	0.9366	0.7986	0.9726
t-wlsh	1.0054	1.0128	0.9886	0.9938	1.0001	0.8558	0.9383	0.8961	0.7687	0.9334
t-wlsv	1.0064	1.0091	0.9909	0.9920	0.9996	0.8556	0.9386	0.8961	0.7684	0.9331
t-shr	1.0147	1.0165	1.0008	0.9982	1.0075	0.8577	0.9433	0.8995	0.7711	0.9388
t-acov	1.0018	1.0146	0.9922	0.9934	1.0004	0.8537	0.9382	0.895	0.7683	0.9332
t-strar1	1.0950	1.0556	1.0100	1.0059	1.0410	0.9177	0.9553	0.9363	0.7981	0.9723
t-sar1	1.0066	1.0093	0.9908	0.9921	0.9997	0.8560	0.9386	0.8963	0.7684	0.9333
t-har1	1.0056	1.0130	0.9884	0.9939	1.0002	0.8562	0.9383	0.8963	0.7688	0.9336
<i>63 bottom series</i>										
base	1	1	1	1	1	1	1	1	1	1
cs-ols	1.3679	1.2763	1.2690	1.2456	1.2889	1.2545	1.2321	1.2433	1.3448	1.2834
cs-struct	1.3207	1.2316	1.2155	1.1861	1.2375	1.1957	1.1427	1.1689	1.1861	1.2101
cs-wls	0.9801	0.9894	0.9929	1.0017	0.9910	0.9800	0.9968	0.9884	0.9971	0.9911
cs-shr	0.9806	0.9928	0.9998	1.0094	0.9956	0.9709	0.9987	0.9847	0.9880	0.9914
t-bu	1	1	1	1	1	0.8470	0.9469	0.8956	0.7973	0.9381
t-ols	1.3816	1.1384	1.0617	1.0145	1.1408	1.0471	0.9784	1.0122	0.8627	1.0594
t-struct	1.1919	1.0525	1.0105	0.9860	1.0573	0.9306	0.9397	0.9351	0.8071	0.9822
t-wlsh	0.9812	0.9926	1.0065	0.9867	0.9917	0.8267	0.9363	0.8798	0.7778	0.9257
t-wlsv	0.9992	0.9945	0.9858	0.9819	0.9903	0.8387	0.9281	0.8823	0.7752	0.9252
t-shr	0.9933	1.0018	1.0272	1.0107	1.0082	0.8278	0.9544	0.8889	0.7853	0.9384
t-acov	0.9661	0.9796	1.0019	0.9864	0.9834	0.8112	0.9338	0.8704	0.7699	0.9171
t-strar1	1.1910	1.0540	1.0118	0.9863	1.0579	0.9313	0.9404	0.9358	0.8078	0.9829
t-sar1	0.9994	0.9944	0.9858	0.9820	0.9904	0.8388	0.9282	0.8824	0.7752	0.9253
t-har1	0.9801	0.9927	1.0068	0.9871	0.9916	0.8268	0.9367	0.8801	0.7780	0.9257

Table A.9: AvgRelMAE at any temporal aggregation level and any forecast horizon.

Procedure	Quarterly					Semi-annual			Annual	All
	1	2	3	4	1-4	1	2	1-2	1	
<i>all 95 series</i>										
base	1	1	1	1	1	1	1	1	1	1
cs-ols	1.1168	1.0846	1.0806	1.0716	1.0883	1.0722	1.0621	1.0672	1.1032	1.0843
cs-struc	1.0997	1.0679	1.0600	1.0497	1.0692	1.0473	1.0306	1.0389	1.0536	1.0582
cs-wls	0.9793	0.9846	0.9866	0.9893	0.9850	0.9788	0.9857	0.9823	0.9907	0.9850
cs-shr	0.9769	0.9842	0.9863	0.9893	0.9842	0.9733	0.9871	0.9802	0.9840	0.9830
t-bu	1	1	1	1	1	0.9219	0.9665	0.9439	0.8763	0.9653
t-ols	1.1554	1.0714	1.0422	1.0240	1.0721	1.0243	0.9987	1.0114	0.9294	1.0331
t-struc	1.0772	1.0288	1.0146	1.0060	1.0313	0.9671	0.9755	0.9713	0.8964	0.9937
t-wlsh	0.9919	0.9992	1.0025	0.9969	0.9976	0.9170	0.9642	0.9403	0.8726	0.9623
t-wlsv	0.9997	0.9988	0.9967	0.9953	0.9976	0.9212	0.9617	0.9412	0.8714	0.9624
t-shr	0.9973	1.0007	1.0059	1.0032	1.0017	0.9166	0.9675	0.9417	0.8707	0.9647
t-acov	0.9893	0.9951	1.0020	0.9971	0.9959	0.9106	0.9632	0.9365	0.8697	0.9598
t-strar1	1.0773	1.0291	1.0148	1.0062	1.0315	0.9672	0.9757	0.9714	0.8965	0.9938
t-sar1	0.9997	0.9990	0.9964	0.9953	0.9976	0.9213	0.9615	0.9412	0.8712	0.9624
t-har1	0.9915	0.9993	1.0024	0.9969	0.9975	0.9171	0.9642	0.9404	0.8725	0.9623
<i>32 upper series</i>										
base	1	1	1	1	1	1	1	1	1	1
cs-ols	0.9820	0.9878	0.9875	0.9852	0.9856	0.9704	0.9857	0.9780	1.0073	0.9865
cs-struc	0.9821	0.9876	0.9840	0.9849	0.9846	0.9664	0.9738	0.9701	0.9927	0.9816
cs-wls	0.9562	0.9673	0.9664	0.9692	0.9648	0.9565	0.9656	0.9610	0.9775	0.9655
cs-shr	0.9484	0.9628	0.9595	0.9652	0.9590	0.9521	0.9679	0.9600	0.9691	0.9607
t-bu	1	1	1	1	1	0.9246	0.9628	0.9435	0.8665	0.9636
t-ols	1.0976	1.0686	1.0406	1.0339	1.0599	1.0120	1.0011	1.0065	0.9280	1.0247
t-struc	1.0350	1.0291	1.0157	1.0148	1.0236	0.9613	0.9784	0.9698	0.8941	0.9887
t-wlsh	0.9953	1.0063	0.9996	1.0017	1.0007	0.9278	0.9629	0.9452	0.8694	0.9650
t-wlsv	0.9947	1.0034	0.9994	1.0006	0.9995	0.9273	0.9628	0.9448	0.8689	0.9641
t-shr	1.0044	1.0068	0.9992	1.0025	1.0032	0.9310	0.9617	0.9462	0.8656	0.9660
t-acov	0.9965	1.0061	1.0019	1.0011	1.0014	0.9270	0.9627	0.9447	0.8688	0.9651
t-strar1	1.0355	1.0282	1.0151	1.0148	1.0234	0.9612	0.9781	0.9696	0.8936	0.9884
t-sar1	0.9947	1.0034	0.9993	1.0005	0.9995	0.9275	0.9626	0.9449	0.8686	0.9640
t-har1	0.9954	1.0063	0.9995	1.0015	1.0007	0.9281	0.9628	0.9453	0.8691	0.9649
<i>63 bottom series</i>										
base	1	1	1	1	1	1	1	1	1	1
cs-ols	1.1922	1.1373	1.1313	1.1183	1.1444	1.1280	1.1032	1.1155	1.1553	1.1376
cs-struc	1.1647	1.1111	1.1009	1.0842	1.1148	1.0909	1.0607	1.0757	1.0860	1.0994
cs-wls	0.9913	0.9936	0.9971	0.9996	0.9954	0.9903	0.9961	0.9932	0.9975	0.9951
cs-shr	0.9917	0.9953	1.0002	1.0018	0.9972	0.9842	0.9970	0.9906	0.9917	0.9945
t-bu	1	1	1	1	1	0.9205	0.9684	0.9441	0.8813	0.9661
t-ols	1.1859	1.0728	1.0430	1.0190	1.0783	1.0306	0.9974	1.0139	0.9301	1.0373
t-struc	1.0993	1.0287	1.0140	1.0016	1.0352	0.9700	0.9741	0.9721	0.8976	0.9963
t-wlsh	0.9902	0.9956	1.0040	0.9944	0.9960	0.9116	0.9649	0.9378	0.8743	0.9610
t-wlsv	1.0022	0.9965	0.9953	0.9926	0.9967	0.9181	0.9611	0.9393	0.8727	0.9615
t-shr	0.9936	0.9975	1.0093	1.0035	1.0010	0.9094	0.9705	0.9395	0.8733	0.9640
t-acov	0.9856	0.9896	1.0021	0.9951	0.9931	0.9023	0.9635	0.9324	0.8702	0.9571
t-strar1	1.0991	1.0295	1.0147	1.0018	1.0356	0.9703	0.9744	0.9724	0.8980	0.9966
t-sar1	1.0023	0.9968	0.9950	0.9926	0.9967	0.9183	0.9609	0.9393	0.8726	0.9615
t-har1	0.9896	0.9957	1.0039	0.9946	0.9959	0.9116	0.9649	0.9379	0.8743	0.9609

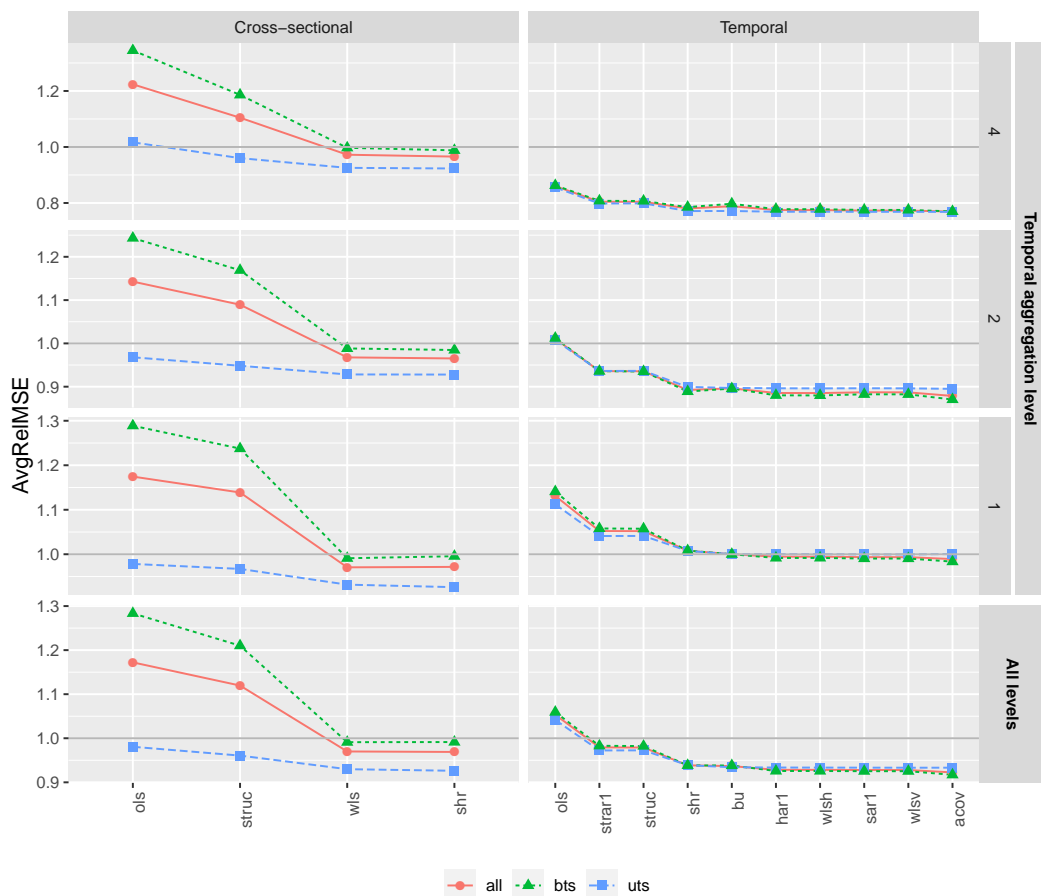

	all				bts				uts			
	all	1	2	4	all	1	2	4	all	1	2	4
t acov	1	3	1	1	1	1	1	1	4	11	1	1
t wlsv	2	4	4	3	2	2	4	3	3	5	3	2
t sar1	3	5	5	2	3	3	5	2	5	6	5	3
t wls	4	7	2	4	4	6	2	4	6	9	2	4
t har1	5	6	3	5	5	5	3	5	7	10	4	5
t bu	6	8.5	7	7	6	8.5	7	7	8	7.5	6	7
t shr	7	10	6	6	7	10	6	6	9	12	7	6
cs shr	8	2	10	11	11	7	10	11	1	1	8	11
cs wls	9	1	11	12	10	4	11	12	2	2	9	12
t struc	10	11	8	8	8	11	8	8	12	14	11	9
t strar1	11	12	9	9	9	12	9	9	11	13	10	8
base	12	8.5	12	13	12	8.5	12	13	14	7.5	14	14
t ols	13	13	13	10	13	13	13	10	15	15	15	10
cs struc	14	14	14	14	14	14	14	14	10	3	12	13
cs ols	15	15	15	15	15	15	15	15	13	4	13	15

Figure A.14: Top panel: Average Relative MSE across all series and forecast horizons, by frequency of observation. Bottom panel: Rankings by frequency of observation and forecast horizon.

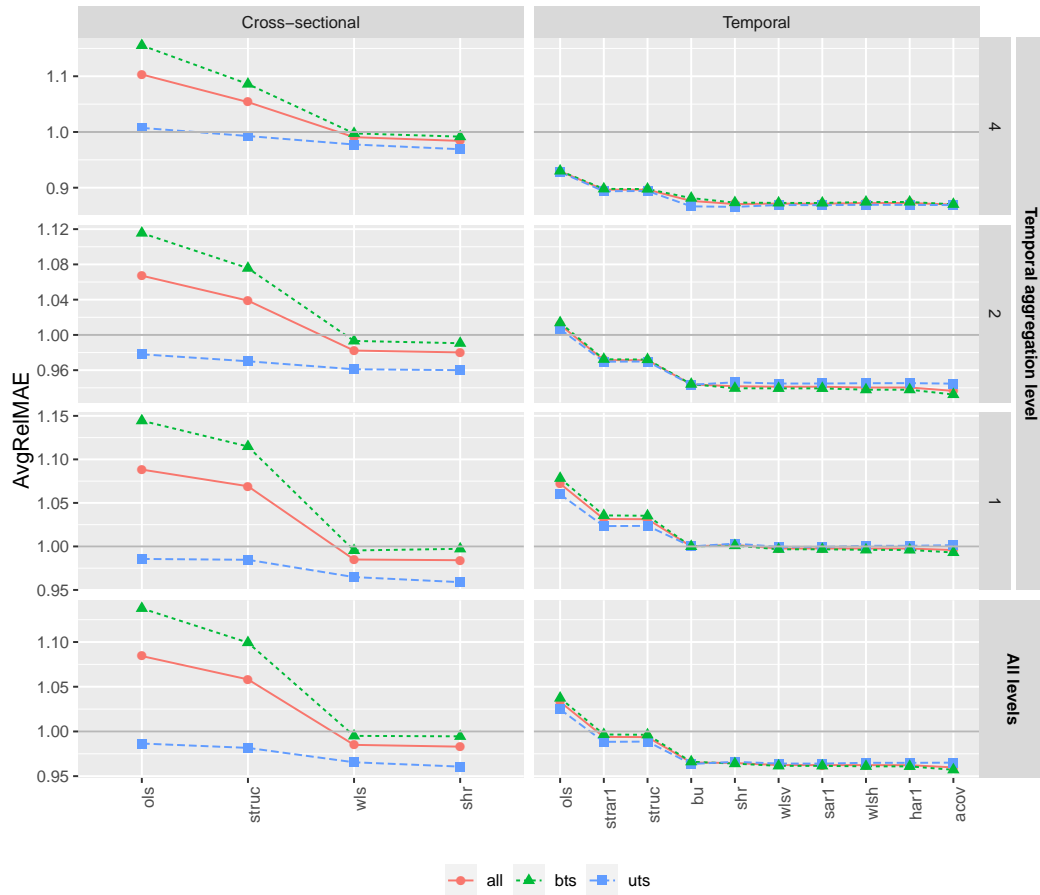

	all				bts				uts			
	all	1	2	4	all	1	2	4	all	1	2	4
t acov	1	3	1	1	1	1	1	1	7	11	2	4
t har1	2	4	3	5	2	3	3	6	5	9	6	6
t wls	3	6	2	6	3	4	2	5	6	10	5	7
t sar1	4	5	5	3	4	6	4	2	3	5	4	3
t wlsv	5	7	4	4	5	5	5	3	4	6	3	5
t shr	6	10	6	2	6	10	6	4	9	12	7	1
t bu	7	8.5	7	7	7	8.5	7	7	2	7.5	1	2
cs shr	8	1	10	11	8	7	10	11	1	1	8	11
cs wls	9	2	11	12	9	2	11	12	8	2	9	12
t struc	10	11	8	8	10	11	8	8	13	14	11	9
t strar1	11	12	9	9	11	12	9	9	12	13	10	8
base	12	8.5	12	13	12	8.5	12	13	14	7.5	14	14
t ols	13	14	13	10	13	13	13	10	15	15	15	10
cs struc	14	13	14	14	14	14	14	14	10	3	12	13
cs ols	15	15	15	15	15	15	15	15	11	4	13	15

Figure A.15: Top panel: Average Relative MAE across all series and forecast horizons, by frequency of observation. Bottom panel: Rankings by frequency of observation and forecast horizon.

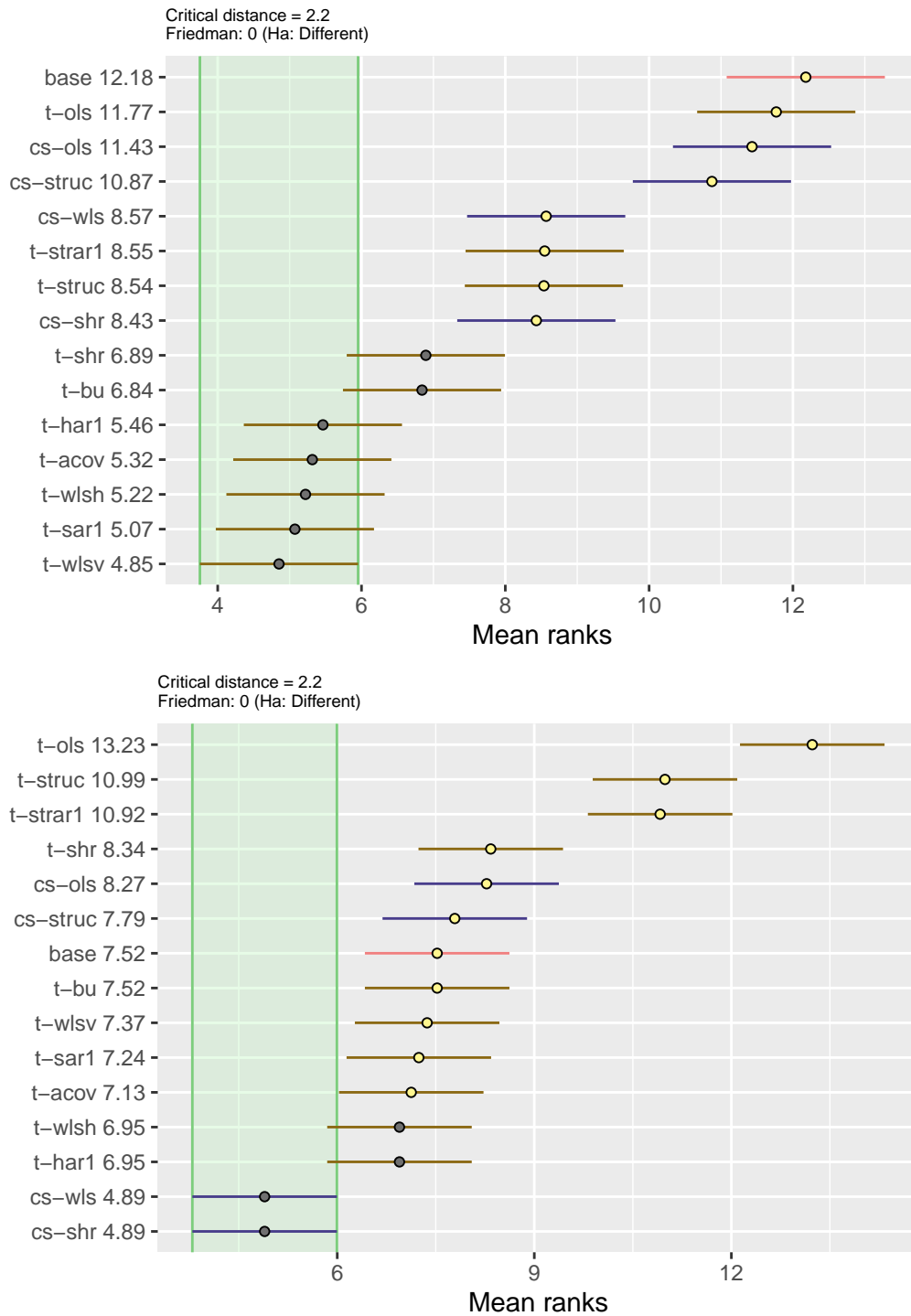

Figure A.16: Nemenyi test results at 5% significance level for all 95 series. The cross-sectional and temporal reconciliation procedures are sorted vertically according to the MSE mean rank (i) across all time frequencies and forecast horizons (top), and (ii) for one-step-ahead quarterly forecasts (bottom).

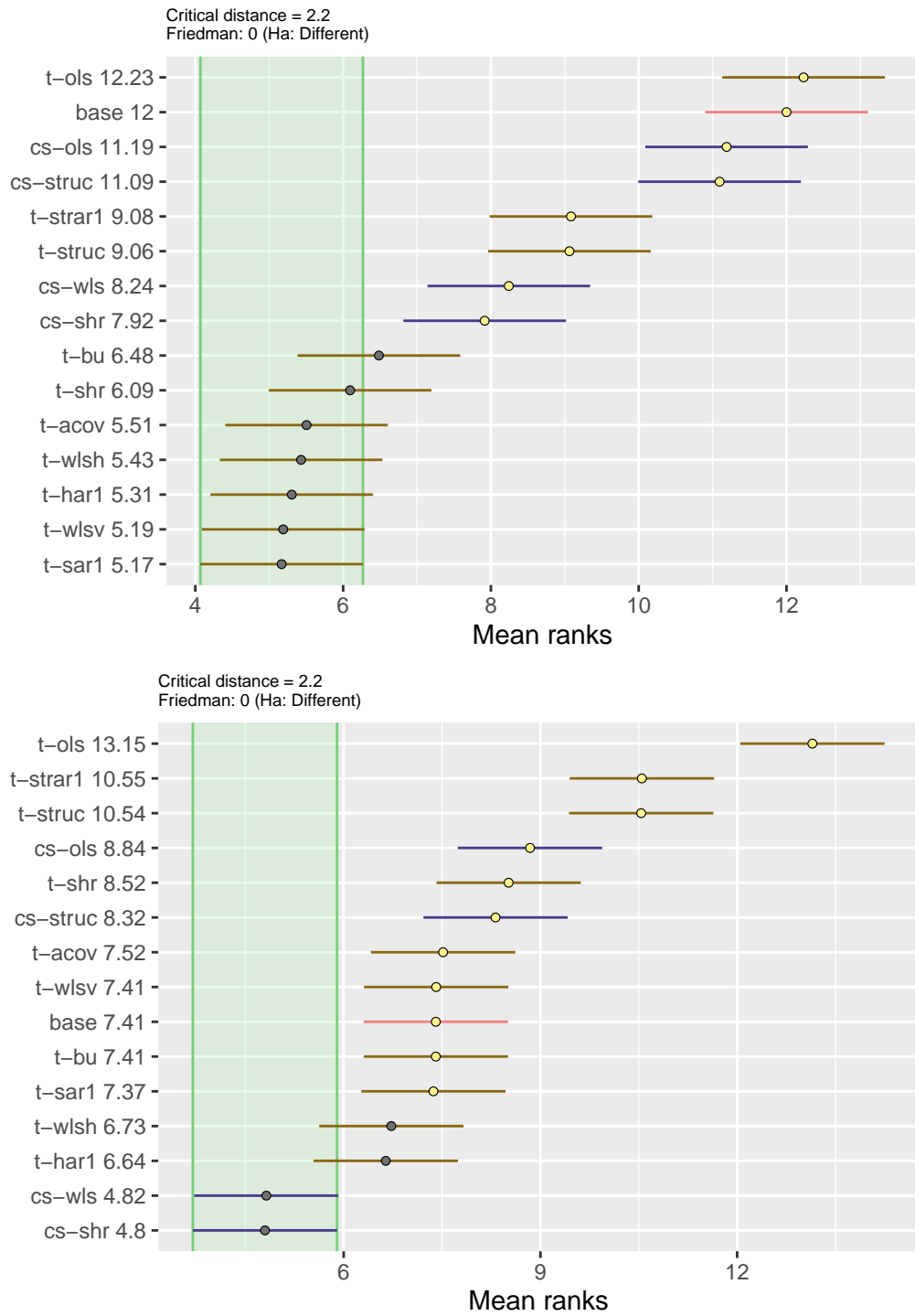

Figure A.17: Nemenyi test results at 5% significance level for all 95 series. The cross-sectional and temporal reconciliation procedures are sorted vertically according to the MAE mean rank (i) across all time frequencies and forecast horizons (top), and (ii) for one-step-ahead quarterly forecasts (bottom).

A.8.3 Heuristic KA, alternatives and iterative cross-temporal reconciliation procedures

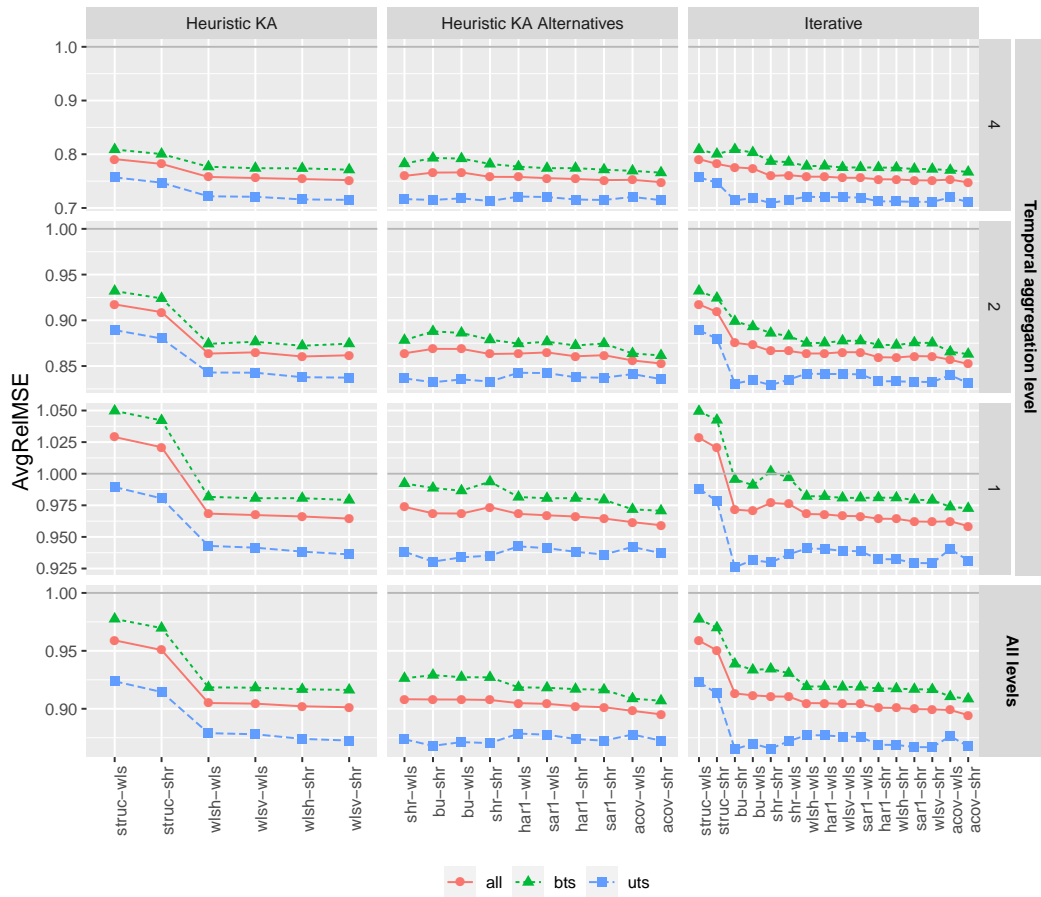

Figure A.18: Average Relative MSE across all series and forecast horizons, by frequency of observation (selected procedures).

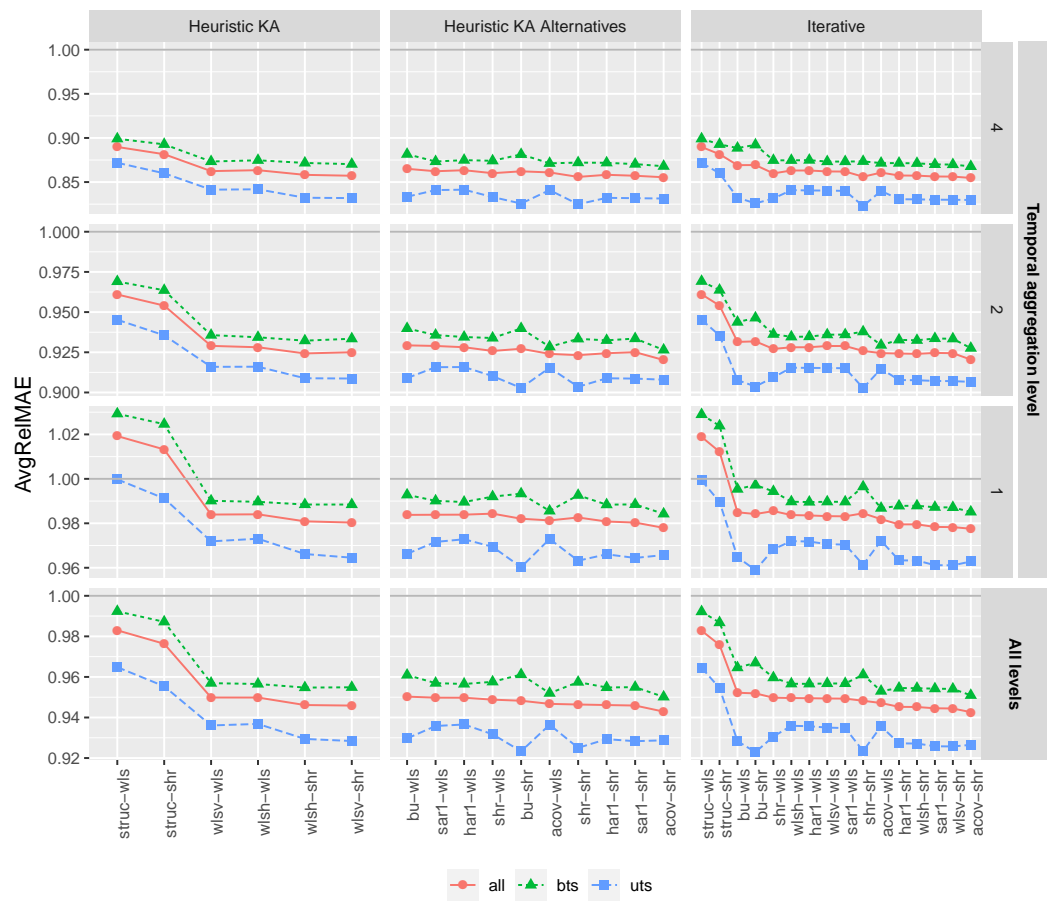

Figure A.19: Average Relative MAE across all series and forecast horizons, by frequency of observation (selected procedures).

	all				bts				uts			
	all	1	2	4	all	1	2	4	all	1	2	4
ite acov-shr	1	1	1	1	2	3	2	2	5	6	3	2
tcs acov-shr	2	2	2	2	1	1	1	1	14	15	13	9
ite acov-wls	3	3	3	7	3	2	3	3	25	26	21	24
ite acov-wls	4	6	4	8	4	4	4	4	21	21	19	20
ite wlsv-shr	5	4	8	3	7	5	14	7	3	2	5	3
ite sar1-shr	6	5	10	4	9	8	16	8	4	3	6	4
ite wls-shr	7	7	5	9	11	15	7	13	7	8	8	5
ite har1-shr	8	8	6	10	12	16	8	14	8	9	9	6
kah wlsv-shr	9	9	11	5	5	6	10	5	15	14	16	12
tcs sar1-shr	10	10	12	6	6	7	12	6	13	12	15	10
kah wls-shr	11	12	7	11	8	10	5	9	18	18	18	15
tcs har1-shr	12	11	9	12	10	11	6	12	17	16	17	14
ite sar1-wls	13	13	21	15	17	13	20	15	19	19	20	19
ite wlsv-wls	14	14	22	16	18	14	19	16	20	20	22	21
tcs sar1-wls	15	15	19	13	13	9	18	10	24	24	25	23
kah wlsv-wls	16	16	20	14	14	12	17	11	26	25	27	26
ite har1-wls	17	17	17	21	20	19	15	20	22	22	23	22
tcs har1-wls	18	19	15	18	16	17	11	18	27	27	26	27
ite wls-wls	19	18	16	20	19	20	13	19	23	23	24	25
kah wls-wls	20	20	14	17	15	18	9	17	28	28	28	28
tcs shr-shr	21	25	13	19	22	25	22	21	10	11	7	7
tcs bu-wls	22	21	25	26	23	21	25	25	11	10	12	17
tcs bu-shr	23	22	26	25	24	22	26	26	6	5	4	11
tcs shr-wls	24	26	18	22	21	24	21	22	16	17	14	16
ite shr-wls	25	27	24	24	25	27	23	23	12	13	11	13
ite shr-shr	26	28	23	23	27	28	24	24	2	4	1	1
ite bu-wls	27	23	27	27	26	23	27	31	9	7	10	18
ite bu-shr	28	24	28	28	28	26	28	34	1	1	2	8
ite struc-shr	29	29	30	29	30	30	30	28	43	49	45	45
kah struc-shr	30	31	29	30	29	29	29	27	45	57	48	46
ite strar1-shr	31	30	32	32	32	32	32	30	44	52	46	44
tcs strar1-shr	32	32	31	31	31	31	31	29	46	58	47	43
ite struc-wls	33	33	34	33.5	33	33	34	33	62	62	63	49
ite strar1-wls	34	34	36	36	35	35	36	35	61	61	61	48
kah struc-wls	35	35	33	33.5	34	34	33	32	64	64	64	50
tcs strar1-wls	36	36	35	35	36	36	35	36	63	63	62	47
tcs ols-shr	37	37	37	37	37	37	37	37	73	73	73	69
ite ols-shr	38	38	38	38	38	38	38	38	74	74	74	74
tcs ols-wls	39	39	49	40	40	39	39	40	75	75	75	75
ite ols-wls	40	40	50	39	39	40	40	39	76	76	76	76
ite wlsv-struc	41.5	41.5	43	43	41.5	41.5	45	43.5	33	33.5	42	37
tcs wlsv-struc	41.5	41.5	44	44	41.5	41.5	46	43.5	34	33.5	41	38
tcs sar1-struc	43.5	43.5	48	45.5	43.5	43.5	49.5	46	31.5	31.5	40	33
ite sar1-struc	43.5	43.5	47	45.5	43.5	43.5	49.5	45	31.5	31.5	39	34
ite wls-shr	45.5	45.5	41.5	47.5	45.5	45.5	43.5	47.5	39	37	37	39.5
tcs wls-shr	45.5	45.5	41.5	47.5	45.5	45.5	43.5	47.5	40	38	38	39.5
ite har1-struc	47	47.5	45	49.5	47	47.5	47.5	50	37	35.5	33	35
tcs har1-struc	48	47.5	46	49.5	48	47.5	47.5	49	38	35.5	34	36
ite acov-struc	49.5	49.5	39	41	49.5	49.5	41	41	35	39	30	29.5
tcs acov-struc	49.5	49.5	40	42	49.5	49.5	42	42	36	40	29	29.5
ite struc-struc	51.5	53	51.5	52	51.5	51	52	52	67	67.5	67.5	68
tcs struc-struc	51.5	54	51.5	51	51.5	52	51	51	68	67.5	67.5	67
ite strar1-struc	53.5	55	53	53.5	53	53	53.5	53	65.5	65	65.5	66
tcs strar1-struc	53.5	56	54	53.5	54	54	53.5	54	65.5	66	65.5	65
tcs bu-struc	55.5	51.5	55.5	57.5	55	55.5	55	57	29.5	30	32	41.5
ite bu-struc	55.5	51.5	55.5	57.5	56	55.5	56	58	29.5	29	31	41.5
ite shr-struc	57.5	67.5	57.5	55	61.5	67.5	57.5	55	41	41	35	31
tcs shr-struc	57.5	67.5	57.5	56	61.5	67.5	57.5	56	42	42	36	32
ite wlsv-ols	59	57.5	63.5	61	57	57	63	63	52	46	53	55.5
ite wlsv-ols	60	57.5	63.5	62	58	58	64	64	51	45	54	55.5
tcs sar1-ols	61	59	67.5	65.5	59.5	59	67	67	49	43	55	54
ite sar1-ols	62	60	67.5	65.5	59.5	60	68	68	50	44	56	53
tcs wls-shr	63	61	62	63	63	61	61.5	65	54	55.5	50	58
ite wls-shr	64	62	61	64	64	62	61.5	66	53	55.5	49	57
tcs acov-ols	65.5	65	59	59	67	65	59	61	48	48	44	52
ite acov-ols	65.5	66	60	60	68	66	60	62	47	47	43	51
tcs har1-ols	67.5	63.5	65	67.5	65.5	63.5	65.5	69	55.5	53	51	60
ite har1-ols	67.5	63.5	66	67.5	65.5	63.5	65.5	70	55.5	54	52	59
tcs bu-ols	69.5	69.5	71	77	75	73	75	77	57.5	51	57	63.5
ite bu-ols	69.5	69.5	72	78	76	74	76	78	57.5	50	58	63.5
tcs struc-ols	71.5	71	70	69.5	69.5	69	69.5	71.5	71.5	71.5	71.5	72
ite struc-ols	71.5	72	69	69.5	69.5	70	69.5	71.5	71.5	71.5	71.5	73
tcs strar1-ols	73.5	73.5	73.5	71	71.5	71.5	71	73	69	69	69.5	70
ite strar1-ols	73.5	73.5	73.5	72	71.5	71.5	72	74	70	70	69.5	71
tcs shr-ols	75	75.5	75.5	75.5	77	77	77.5	75.5	59.5	59.5	59.5	61
ite shr-ols	76	75.5	75.5	75.5	78	78	77.5	75.5	59.5	59.5	59.5	62
ite ols-struc	77.5	77.5	77.5	73	73	75.5	73.5	59	77.5	77.5	77	77
tcs ols-struc	77.5	77.5	77.5	74	74	75.5	73.5	60	77.5	77.5	78	78
tcs ols-ols	79.5	79	79.5	79.5	79	79	79.5	79.5	79.5	79.5	79.5	79.5
ite ols-ols	79.5	80	79.5	79.5	80	80	79.5	79.5	79.5	79.5	79.5	79.5

Figure A.20: Rankings (Average Relative MSE) by frequency of observation and forecast horizon.

	all				bts				uts			
	all	1	2	4	all	1	2	4	all	1	2	4
ite acov-shr	1	1	2	1	2	2	2	1	7	6	5	5
tcs acov-shr	2	2	1	2	1	1	1	2	13	13	11	10
ite wlsv-shr	3	3	9	5	5	5	10	3	5	3	6	6
ite sar1-shr	4	4	11	6	6	6	13	4	6	4	7	7
ite wls-hr	5	6	5	9	7	8	7	7	8	8	8	8
ite har1-shr	6	5	6	10	8	7	8	9	9	9	10	9
kah wlsv-shr	7	8	12	7	11	10	11	5	12	11	13	13
tcs sar1-shr	8	7	13	8	12	12	12	6	10	10	12	12
kah wls-hr	9	10	7	11	9	11	5	11	15	15	15	15
tcs har1-shr	10	9	8	12	10	9	6	12	14	14	14	14
tcs shr-shr	11	14	3	3	21	22	9	13	4	7	3	2
tcs acov-wls	12	11	4	16	3	3	3	8	26	27	23	24
ite acov-wls	13	12	10	15	4	4	4	10	21	25	19	19
ite shr-wls	14	26	14	4	25	27	24	18	3	5	1	1
tcs bu-shr	15	13	17	19	26	24	25	25	2	2	2	3
tcs shr-wls	16	25	15	14	22	21	14	19	18	18	18	17
ite sar1-wls	17	15	22	17	18	16	22	15	19	19	20	20
ite wlsv-wls	18	16	23	18	17	17	21	14	20	20	21	21
ite har1-wls	19	17	20	22	15	13	18	23	22	22	22	22
ite wls-hr	20	18	18	23	16	18	17	21	24	24	24	23
tcs har1-wls	21	21	21	24	14	14	16	24	27	26	26	26
ite shr-wls	22	28	16	13	23	25	23	20	17	17	17	11
tcs sar1-wls	23	20	24	20	20	19	20	17	23	21	25	25
kah wls-hr	24	23	19	25	13	15	15	22	28	28	28	28
kah wlsv-wls	25	22	25	21	19	20	19	16	25	23	27	27
tcs bu-wls	26	19	26	26	24	23	26	26	16	16	16	18
ite bu-shr	27	24	28	28	28	28	28	28	1	1	4	4
ite bu-wls	28	27	27	27	27	26	27	27	11	12	9	16
ite struc-shr	29	29	30	30	29	29	30	30	58	56	57	59
ite strar1-shr	30	30	32	32	31	30	32	32	57	55	58	57
kah struc-shr	31	31	29	29	30	31	29	29	60	60	59	60
tcs strar1-shr	32	32	31	31	32	32	31	31	59	59	60	58
ite struc-wls	33	33	34	33	33	33	34	34	63	62	64	63
ite strar1-wls	34	34	36	36	35	34	36	36	61	61	62	61
kah struc-wls	35	35	33	34	34	35	33	33	64	64	63	64
tcs strar1-wls	36	36	35	35	36	36	35	35	62	63	61	62
tcs ols-shr	37	37	47	37	37	38	37	38	73	73	73	73
ite ols-shr	38	38	48	38	38	37	38	37	74	74	74	74
ite wlsv-struc	39.5	39.5	41	43	41	41.5	45	43	33.5	35	39.5	39
tcs wlsv-struc	39.5	39.5	42	44	42	41.5	46	44	33.5	36	39.5	40
ite sar1-struc	41	41	45	41.5	43.5	43.5	49.5	45	31.5	33	35	36
tcs sar1-struc	42	42	46	41.5	43.5	43.5	49.5	46	31.5	34	36	35
ite wls-hr	43.5	43.5	39	47.5	45.5	45.5	43.5	47	39	43	41.5	41.5
tcs wls-hr	43.5	43.5	40	47.5	45.5	45.5	43.5	48	40	44	41.5	41.5
ite har1-struc	45.5	45	43	45	47	47	47	49.5	35	41.5	37	37
tcs har1-struc	45.5	46	44	46	48	48	48	49.5	36	41.5	38	38
ite acov-struc	47.5	49	37	39.5	49.5	49.5	41.5	41	43	47	34	33.5
tcs acov-struc	47.5	50	38	39.5	49.5	49.5	41.5	42	44	48	33	33.5
tcs ols-wls	49	48	49	50	40	40	39	40	75	75	75	75
ite ols-wls	50	47	50	49	39	39	40	39	76	76	76	76
tcs bu-struc	51.5	51.5	54	58	55.5	55.5	57.5	58	29.5	29.5	30	32
ite bu-struc	51.5	51.5	53	57	55.5	55.5	57.5	57	29.5	29.5	29	31
ite shr-struc	53	59.5	51.5	51	57	57	55.5	55	37	53.5	31	29
tcs shr-struc	54	59.5	51.5	52	58	58	55.5	56	38	53.5	32	30
ite struc-struc	55.5	53.5	55.5	55	51.5	51.5	51.5	51.5	67	67.5	67	67.5
tcs struc-struc	55.5	53.5	55.5	56	51.5	51.5	51.5	51.5	68	67.5	68	67.5
ite strar1-struc	57	55.5	57	53.5	53	53.5	53.5	53	65.5	65.5	65	66
tcs strar1-struc	58	55.5	58	53.5	54	53.5	53.5	54	65.5	65.5	66	65
tcs wlsv-ols	59	57.5	61	61.5	59.5	59	61.5	63	47.5	39.5	51	53.5
ite wlsv-ols	60	57.5	62	61.5	59.5	60	61.5	64	47.5	39.5	52	53.5
tcs sar1-ols	61.5	61.5	65.5	66	61.5	61.5	65	67.5	45	37	47	50
ite sar1-ols	61.5	61.5	65.5	65	61.5	61.5	66	67.5	46	38	48	49
tcs wls-hr	63.5	63.5	63.5	63	63	63	64	65	53.5	51.5	56	55.5
ite wls-hr	63.5	63.5	63.5	64	64	64	63	66	53.5	51.5	55	55.5
tcs acov-ols	65	67	59.5	59.5	67.5	67.5	59.5	59.5	49.5	45.5	45.5	47.5
ite acov-ols	66	68	59.5	59.5	67.5	67.5	59.5	59.5	49.5	45.5	45.5	47.5
tcs har1-ols	67	65.5	67	67.5	65.5	65.5	67	69.5	51.5	49	53.5	52
ite har1-ols	68	65.5	68	67.5	65.5	65.5	68	69.5	51.5	50	53.5	51
tcs bu-ols	69.5	69.5	69	75	75	73.5	75.5	77	41.5	32	43	45.5
ite bu-ols	69.5	69.5	70	76	76	73.5	75.5	78	41.5	31	44	45.5
tcs struc-ols	71.5	71	71.5	69	69.5	69	69	71.5	71.5	71	71.5	71
ite struc-ols	71.5	72	71.5	70	69.5	70	70	71.5	71.5	72	71.5	72
tcs strar1-ols	73.5	73.5	73.5	71	71.5	71.5	71	73	69.5	69.5	69.5	69
ite strar1-ols	73.5	73.5	73.5	72	71.5	71.5	72	74	69.5	69.5	69.5	70
tcs shr-ols	75.5	75.5	76	73.5	77.5	77	77.5	75.5	55.5	57.5	50	43.5
ite shr-ols	75.5	75.5	75	73.5	77.5	78	77.5	75.5	55.5	57.5	49	43.5
tcs ols-struc	77.5	77.5	78	78	73.5	76	73.5	62	77.5	77.5	78	78
ite ols-struc	77.5	77.5	77	77	73.5	75	73.5	61	77.5	77.5	77	77
tcs ols-ols	79.5	79.5	79	79.5	79.5	79	79.5	79.5	79.5	80	79	79
ite ols-ols	79.5	79.5	80	79.5	79.5	80	79.5	79.5	79.5	79	80	80

Figure A.21: Rankings (Average Relative MAE) by frequency of observation and forecast horizon.

Table A.10: AvgRelMSE for the 63 bottom series at any temporal aggregation level and any forecast horizon.

Procedure	Quarterly bts					Semi-annual bts			Annual bts	All bts
	1	2	3	4	1-4	1	2	1-2	1	1
base	1	1	1	1	1	1	1	1	1	1
kah-struct-shr	1.1655	1.037	0.9986	0.9774	1.0422	0.9146	0.9335	0.9240	0.8004	0.9697
kah-struct-wls	1.1776	1.044	1.0045	0.9832	1.0497	0.9241	0.9399	0.9320	0.8088	0.9775
kah-wlsh-shr	0.9665	0.9806	0.9954	0.9802	0.9806	0.8156	0.9327	0.8722	0.7738	0.9168
kah-wlsh-wls	0.9677	0.9812	0.9961	0.9819	0.9817	0.8180	0.9344	0.8743	0.7767	0.9185
kah-wlsv-shr	0.9832	0.9817	0.9760	0.9759	0.9792	0.8267	0.9250	0.8745	0.7712	0.9163
kah-wlsv-wls	0.9852	0.9826	0.9772	0.9776	0.9806	0.8292	0.9267	0.8766	0.7741	0.9182
tcs-acov-ols	1.3388	1.2584	1.2274	1.1982	1.2546	1.0590	1.1541	1.1055	0.9941	1.1705
tcs-acov-shr	0.9474	0.9659	0.9921	0.9780	0.9707	0.7988	0.9294	0.8616	0.7658	0.9069
tcs-acov-struct	1.3029	1.2033	1.1716	1.1406	1.2031	1.0117	1.0845	1.0474	0.9149	1.1120
tcs-acov-wls	0.9482	0.9664	0.9926	0.9806	0.9718	0.8009	0.9316	0.8638	0.7691	0.9088
tcs-bu-ols	1.3679	1.2763	1.2690	1.2456	1.2889	1.1056	1.2150	1.1590	1.0525	1.2147
tcs-bu-shr	0.9829	0.9880	0.9886	0.9953	0.9887	0.8347	0.9445	0.8879	0.7931	0.9291
tcs-bu-struct	1.3207	1.2316	1.2155	1.1861	1.2375	1.0595	1.1444	1.1011	0.9765	1.1571
tcs-bu-wls	0.9802	0.9852	0.9866	0.9943	0.9866	0.8331	0.9426	0.8862	0.7920	0.9272
tcs-har1-ols	1.3363	1.2496	1.2271	1.1976	1.2516	1.0619	1.1568	1.1083	0.9982	1.1704
tcs-har1-shr	0.9653	0.9809	0.9959	0.9808	0.9806	0.8157	0.9333	0.8725	0.7742	0.917
tcs-har1-struct	1.2958	1.1954	1.1721	1.1392	1.1993	1.0126	1.0866	1.049	0.9180	1.1110
tcs-har1-wls	0.9664	0.9812	0.9965	0.9824	0.9816	0.8179	0.9350	0.8745	0.7770	0.9185
tcs-ols-ols	1.7104	1.3863	1.2740	1.2026	1.3806	1.2869	1.1842	1.2345	1.0876	1.2924
tcs-ols-shr	1.3474	1.1180	1.0442	1.0021	1.1205	1.0262	0.9673	0.9963	0.8529	1.0421
tcs-ols-struct	1.6399	1.3133	1.2004	1.1375	1.3095	1.2109	1.1017	1.1550	0.9844	1.2129
tcs-ols-wls	1.3654	1.1295	1.0541	1.0111	1.1323	1.0407	0.9776	1.0086	0.8656	1.0543
tcs-sar1-ols	1.3374	1.2433	1.2162	1.1903	1.2456	1.0659	1.1529	1.1085	0.9975	1.1672
tcs-sar1-shr	0.9832	0.9818	0.9762	0.9761	0.9793	0.8268	0.9253	0.8746	0.7713	0.9164
tcs-sar1-struct	1.2916	1.1925	1.1595	1.1318	1.1924	1.0168	1.0828	1.0493	0.9171	1.1073
tcs-sar1-wls	0.9850	0.9824	0.9773	0.9777	0.9806	0.8291	0.9268	0.8766	0.7740	0.9181
tcs-shr-ols	1.4139	1.3282	1.2923	1.2264	1.3135	1.1276	1.1991	1.1628	1.0454	1.2278
tcs-shr-shr	0.9704	0.9856	1.0148	1.0045	0.9937	0.8118	0.9515	0.8789	0.7819	0.9271
tcs-shr-struct	1.3675	1.2744	1.2369	1.1710	1.2605	1.0762	1.1297	1.1027	0.9616	1.1672
tcs-shr-wls	0.9675	0.9832	1.0146	1.0045	0.9923	0.8103	0.9518	0.8782	0.7826	0.9263
tcs-strar1-ols	1.4718	1.2772	1.2113	1.1662	1.2765	1.1307	1.1334	1.1321	1.0033	1.1918
tcs-strar1-shr	1.1644	1.0386	1.0001	0.9778	1.0428	0.9152	0.9344	0.9247	0.8011	0.9704
tcs-strar1-struct	1.4217	1.2193	1.1495	1.1083	1.2191	1.0749	1.0620	1.0684	0.9202	1.1278
tcs-strar1-wls	1.1764	1.0453	1.0057	0.9836	1.0502	0.9245	0.9407	0.9326	0.8093	0.9780
tcs-struct-ols	1.4716	1.2748	1.2104	1.1649	1.2753	1.1291	1.1323	1.1307	1.0022	1.1905
tcs-struct-shr	1.4219	1.2178	1.1486	1.1073	1.2182	1.074	1.0610	1.0675	0.9196	1.1269
tcs-struct-wls	1.3362	1.2468	1.2255	1.1961	1.2501	1.0595	1.1553	1.1063	0.9964	1.1687
tcs-wlsh-ols	1.2960	1.1939	1.1712	1.1385	1.1985	1.0112	1.0857	1.0478	0.9173	1.1101
tcs-wlsh-struct	1.3368	1.2407	1.2151	1.1890	1.2442	1.0637	1.1515	1.1067	0.9958	1.1656
tcs-wlsh-wls	1.2917	1.1909	1.1589	1.1311	1.1916	1.0156	1.0821	1.0483	0.9165	1.1065
ite-acov-ols	1.3388	1.2584	1.2274	1.1982	1.2546	1.0590	1.1541	1.1055	0.9941	1.1705
ite-acov-shr	0.9457	0.9679	0.9945	0.9830	0.9726	0.7989	0.9323	0.8631	0.7669	0.9086
ite-acov-struct	1.3029	1.2033	1.1716	1.1406	1.2031	1.0117	1.0845	1.0474	0.9149	1.1120
ite-acov-wls	0.9482	0.9698	0.9942	0.9836	0.9738	0.8022	0.9340	0.8656	0.7703	0.9106
ite-bu-ols	1.3679	1.2763	1.2690	1.2456	1.2889	1.1056	1.2150	1.1590	1.0525	1.2147
ite-bu-shr	0.9806	0.9928	0.9998	1.0094	0.9956	0.8384	0.9639	0.8989	0.809	0.9387
ite-bu-struct	1.3207	1.2316	1.2155	1.1861	1.2375	1.0595	1.1444	1.1011	0.9765	1.1571
ite-bu-wls	0.9801	0.9894	0.9929	1.0017	0.9910	0.8366	0.9534	0.8931	0.8032	0.9335
ite-har1-ols	1.3363	1.2496	1.2271	1.1976	1.2516	1.0619	1.1568	1.1083	0.9982	1.1704
ite-har1-shr	0.9606	0.9813	0.9984	0.9843	0.9811	0.8147	0.9362	0.8733	0.7753	0.9176
ite-har1-struct	1.2958	1.1954	1.1721	1.1392	1.1993	1.0126	1.0866	1.049	0.9180	1.1110
ite-har1-wls	0.9634	0.9826	0.9980	0.9845	0.9821	0.8175	0.9372	0.8753	0.7782	0.9193
ite-ols-ols	1.7104	1.3863	1.2740	1.2026	1.3806	1.2869	1.1842	1.2345	1.0876	1.2924
ite-ols-shr	1.3601	1.1188	1.0441	0.9997	1.1226	1.0313	0.9661	0.9982	0.8531	1.0438
ite-ols-struct	1.6399	1.3133	1.2004	1.1375	1.3095	1.2109	1.1017	1.1550	0.9844	1.2129
ite-ols-wls	1.3694	1.1288	1.0536	1.0100	1.1325	1.0414	0.9773	1.0088	0.8641	1.0542
ite-sar1-ols	1.3374	1.2433	1.2162	1.1903	1.2456	1.0659	1.1529	1.1085	0.9975	1.1672
ite-sar1-shr	0.9800	0.9817	0.9779	0.9778	0.9793	0.8262	0.9278	0.8755	0.7725	0.9169
ite-sar1-struct	1.2916	1.1925	1.1595	1.1318	1.1924	1.0168	1.0828	1.0493	0.9171	1.1073
ite-sar1-wls	0.9836	0.9826	0.9783	0.9790	0.9809	0.8290	0.9290	0.8776	0.7754	0.9188
ite-shr-ols	1.4139	1.3282	1.2923	1.2264	1.3135	1.1276	1.1991	1.1628	1.0454	1.2278
ite-shr-shr	0.9786	0.9960	1.0231	1.0095	1.0017	0.8204	0.9570	0.8861	0.7869	0.9344
ite-shr-struct	1.3675	1.2744	1.2369	1.1710	1.2605	1.0762	1.1297	1.1027	0.9616	1.1672
ite-shr-wls	0.9710	0.9911	1.0195	1.0070	0.9970	0.8156	0.9556	0.8828	0.7854	0.9307
ite-strar1-ols	1.4718	1.2772	1.2113	1.1662	1.2765	1.1307	1.1334	1.1321	1.0033	1.1918
ite-strar1-shr	1.1692	1.0373	0.9997	0.9768	1.0432	0.9161	0.9345	0.9252	0.8012	0.9707
ite-strar1-struct	1.4217	1.2193	1.1495	1.1083	1.2191	1.0749	1.0620	1.0684	0.9202	1.1278
ite-strar1-wls	1.1782	1.0441	1.0049	0.9830	1.0499	0.9245	0.9409	0.9327	0.8093	0.9779
ite-struct-ols	1.4716	1.2748	1.2104	1.1649	1.2753	1.1291	1.1323	1.1307	1.0022	1.1905
ite-struct-shr	1.1699	1.0357	0.9983	0.9764	1.0425	0.9152	0.9336	0.9244	0.8004	0.9700
ite-struct-struct	1.4219	1.2178	1.1486	1.1073	1.2182	1.074	1.0610	1.0675	0.9196	1.1269
ite-struct-wls	1.1793	1.043	1.0036	0.9826	1.0495	0.9241	0.9402	0.9321	0.8088	0.9774
ite-wlsh-ols	1.3362	1.2468	1.2255	1.1961	1.2501	1.0595	1.1553	1.1063	0.9964	1.1687
ite-wlsh-shr	0.9618	0.9809	0.9979	0.9837	0.9810	0.8144	0.9355	0.8729	0.7748	0.9174
ite-wlsh-struct	1.2960	1.1939	1.1712	1.1385	1.1985	1.0112	1.0857	1.0478	0.9173	1.1101
ite-wlsh-wls	0.9649	0.9826	0.9976	0.9841	0.9822	0.8176	0.9367	0.8751	0.7780	0.9192
ite-wlsv-ols	1.3368	1.2407	1.2151	1.1890	1.2442	1.0637	1.1515	1.1067	0.9958	1.1656
ite-wlsv-shr	0.9798	0.9814	0.9776	0.9776	0.9791	0.8259	0.9275	0.8753	0.7723	0.9166
ite-wlsv-struct	1.2917	1.1909	1.1589	1.1311	1.1916	1.0156	1.0821	1.0483	0.9165	1.1065
ite-wlsv-wls	0.9837	0.9828	0.9782	0.9789	0.9809	0.8292	0.9288	0.8776	0.7754	0.9188

Table A.11: AvgRelMSE for the 32 upper series at any temporal aggregation level and any forecast horizon.

Procedure	Quarterly bts					Semi-annual bts			Annual bts	All bts
	1	2	3	4	1-4	1	2	1-2	1	1
base	1	1	1	1	1	1	1	1	1	1
kah-struc-shr	1.0261	0.9976	0.9521	0.9483	0.9805	0.863	0.8976	0.8801	0.7471	0.9145
kah-struc-wls	1.0369	1.0072	0.9605	0.9556	0.9895	0.8729	0.9060	0.8893	0.757	0.9237
kah-wlsh-shr	0.9432	0.9481	0.9295	0.9326	0.9383	0.7995	0.8780	0.8378	0.7159	0.8740
kah-wlsh-wls	0.9469	0.9544	0.9345	0.9359	0.9429	0.8047	0.883	0.843	0.7217	0.8790
kah-wlsv-shr	0.9398	0.9467	0.9281	0.9302	0.9362	0.7996	0.8769	0.8373	0.7151	0.8726
kah-wlsv-wls	0.9457	0.9528	0.9335	0.9341	0.9415	0.8053	0.8819	0.8427	0.7209	0.8780
tcs-acov-ols	0.9727	0.9873	0.9744	0.9779	0.9781	0.8319	0.9306	0.8799	0.7600	0.9154
tcs-acov-shr	0.9411	0.9435	0.9307	0.9331	0.9371	0.7956	0.8779	0.8357	0.7146	0.8725
tcs-acov-struc	0.9820	0.9837	0.9593	0.9579	0.9706	0.8277	0.9055	0.8657	0.7411	0.9039
tcs-acov-wls	0.9447	0.9513	0.9351	0.9371	0.942	0.8012	0.8832	0.8412	0.7205	0.8778
tcs-bu-ols	0.9713	0.9767	0.9798	0.9852	0.9782	0.8325	0.9403	0.8847	0.7659	0.9179
tcs-bu-shr	0.9278	0.9299	0.9327	0.9313	0.9305	0.7864	0.8809	0.8323	0.7150	0.8680
tcs-bu-struc	0.9720	0.9696	0.9655	0.9610	0.967	0.8219	0.9132	0.8663	0.7443	0.9027
tcs-bu-wls	0.9316	0.9342	0.9362	0.9333	0.9338	0.7898	0.8837	0.8354	0.7179	0.8712
tcs-har1-ols	0.9774	0.9857	0.9723	0.9795	0.9787	0.8351	0.9316	0.8821	0.7613	0.9166
tcs-har1-shr	0.9432	0.9480	0.9294	0.9325	0.9382	0.7995	0.8779	0.8377	0.7158	0.8739
tcs-har1-struc	0.9826	0.9827	0.9576	0.9582	0.9702	0.8296	0.9058	0.8668	0.7419	0.9041
tcs-har1-wls	0.9467	0.9538	0.9341	0.9356	0.9425	0.8044	0.8826	0.8426	0.7213	0.8786
tcs-ols-ols	1.2156	1.1122	1.0452	1.0300	1.0984	1.0087	0.9962	1.0024	0.858	1.0330
tcs-ols-shr	1.1411	1.0635	0.9885	0.9758	1.0402	0.9478	0.9300	0.9388	0.7931	0.9718
tcs-ols-struc	1.1940	1.0989	1.0203	1.0044	1.0768	0.9860	0.9627	0.9743	0.827	1.0078
tcs-ols-wls	1.1567	1.0767	1.0007	0.9859	1.0528	0.9620	0.9418	0.9518	0.8071	0.9848
tcs-sar1-ols	0.9788	0.9832	0.9727	0.9763	0.9778	0.8369	0.9307	0.8825	0.7610	0.9162
tcs-sar1-shr	0.9399	0.9464	0.9280	0.9301	0.9361	0.7995	0.8767	0.8372	0.7149	0.8725
tcs-sar1-struc	0.9819	0.9802	0.9568	0.9560	0.9686	0.8307	0.9054	0.8672	0.7417	0.9034
tcs-sar1-wls	0.9454	0.9522	0.9331	0.9338	0.9411	0.8049	0.8815	0.8423	0.7204	0.8776
tcs-shr-ols	0.9825	0.9866	0.9832	0.9846	0.9842	0.8367	0.9369	0.8854	0.7650	0.9211
tcs-shr-shr	0.9375	0.9368	0.9300	0.9363	0.9352	0.7905	0.8780	0.8331	0.7128	0.8704
tcs-shr-struc	0.9825	0.9789	0.9637	0.9645	0.9724	0.8262	0.9096	0.8669	0.7415	0.9052
tcs-shr-wls	0.9375	0.9410	0.9359	0.9387	0.9383	0.7927	0.8826	0.8365	0.7165	0.8737
tcs-strar1-ols	1.0736	1.031	0.9969	0.9946	1.0235	0.9021	0.9524	0.9269	0.7954	0.9597
tcs-strar1-shr	1.0269	0.9968	0.9520	0.9486	0.9805	0.8629	0.8977	0.8801	0.7471	0.9145
tcs-strar1-struc	1.0668	1.0255	0.9776	0.9729	1.0100	0.8908	0.9245	0.9075	0.7726	0.9428
tcs-strar1-wls	1.0373	1.0057	0.9600	0.9557	0.9891	0.8723	0.9058	0.8889	0.7565	0.9233
tcs-struc-ols	1.0727	1.0323	0.9980	0.9940	1.0238	0.9024	0.9526	0.9272	0.7957	0.9600
tcs-struc-struc	1.0664	1.0268	0.9786	0.9726	1.0104	0.8912	0.9249	0.9079	0.7731	0.9432
tcs-wlsh-ols	0.9774	0.9856	0.9727	0.9793	0.9787	0.8348	0.9317	0.8819	0.7612	0.9165
tcs-wlsh-struc	0.9828	0.9829	0.958	0.9585	0.9705	0.8295	0.9062	0.8670	0.7422	0.9044
tcs-wlsv-ols	0.9789	0.9832	0.9731	0.9761	0.9778	0.8367	0.9307	0.8825	0.7610	0.9162
tcs-wlsv-struc	0.9823	0.9804	0.9572	0.9561	0.9689	0.8307	0.9057	0.8674	0.7420	0.9036
ite-acov-ols	0.9727	0.9873	0.9744	0.9779	0.9781	0.8319	0.9306	0.8799	0.7600	0.9154
ite-acov-shr	0.9283	0.9398	0.9259	0.9314	0.9313	0.7893	0.8754	0.8313	0.7111	0.8675
ite-acov-struc	0.9820	0.9837	0.9593	0.9579	0.9706	0.8277	0.9055	0.8657	0.7411	0.9039
ite-acov-wls	0.9414	0.9502	0.9337	0.9364	0.9404	0.7997	0.8825	0.8401	0.7196	0.8764
ite-bu-ols	0.9713	0.9767	0.9798	0.9852	0.9782	0.8325	0.9403	0.8847	0.7659	0.9179
ite-bu-shr	0.9157	0.9270	0.9300	0.9315	0.9260	0.7824	0.8823	0.8309	0.7142	0.8651
ite-bu-struc	0.9720	0.9696	0.9655	0.9610	0.967	0.8219	0.9132	0.8663	0.7443	0.9027
ite-bu-wls	0.9271	0.9324	0.9349	0.9323	0.9317	0.7883	0.8837	0.8346	0.7182	0.8699
ite-har1-ols	0.9774	0.9857	0.9723	0.9795	0.9787	0.8351	0.9316	0.8821	0.7613	0.9166
ite-har1-shr	0.9305	0.9452	0.9240	0.9301	0.9324	0.7939	0.8750	0.8335	0.7123	0.8689
ite-har1-struc	0.9826	0.9827	0.9576	0.9582	0.9702	0.8296	0.9058	0.8668	0.7419	0.9041
ite-har1-wls	0.9428	0.9523	0.9324	0.9346	0.9405	0.8028	0.8818	0.8414	0.7204	0.8770
ite-ols-ols	1.2156	1.1122	1.0452	1.0300	1.0984	1.0087	0.9962	1.0024	0.858	1.0330
ite-ols-shr	1.1518	1.0704	0.9897	0.9751	1.0444	0.9589	0.9320	0.9454	0.7990	0.9770
ite-ols-struc	1.1940	1.0989	1.0203	1.0044	1.0768	0.9860	0.9627	0.9743	0.8270	1.0078
ite-ols-wls	1.1593	1.0771	1.0004	0.9847	1.0531	0.9646	0.9421	0.9533	0.8083	0.9856
ite-sar1-ols	0.9788	0.9832	0.9727	0.9763	0.9778	0.8369	0.9307	0.8825	0.7610	0.9162
ite-sar1-shr	0.9256	0.9424	0.9223	0.9274	0.9294	0.7936	0.8738	0.8327	0.7114	0.8669
ite-sar1-struc	0.9819	0.9802	0.9568	0.9560	0.9686	0.8307	0.9054	0.8672	0.7417	0.9034
ite-sar1-wls	0.9409	0.9500	0.9312	0.9324	0.9386	0.803	0.8807	0.8409	0.7195	0.8757
ite-shr-ols	0.9825	0.9866	0.9832	0.9846	0.9842	0.8367	0.9369	0.8854	0.7650	0.9211
ite-shr-shr	0.9277	0.9340	0.9234	0.9340	0.9298	0.7864	0.8741	0.8291	0.709	0.8656
ite-shr-struc	0.9825	0.9789	0.9637	0.9645	0.9724	0.8262	0.9096	0.8669	0.7415	0.9052
ite-shr-wls	0.9329	0.9405	0.9333	0.9380	0.9362	0.7915	0.8813	0.8352	0.7154	0.8720
ite-strar1-ols	1.0736	1.0310	0.9969	0.9946	1.0235	0.9021	0.9524	0.9269	0.7954	0.9597
ite-strar1-shr	1.0230	0.9967	0.9489	0.9467	0.9783	0.8635	0.8966	0.8799	0.7471	0.9132
ite-strar1-struc	1.0668	1.0255	0.9776	0.9729	1.0100	0.8908	0.9245	0.9075	0.7726	0.9428
ite-strar1-wls	1.0362	1.0045	0.9588	0.9547	0.9879	0.8722	0.9056	0.8888	0.7565	0.9227
ite-struc-ols	1.0727	1.0323	0.9980	0.9940	1.0238	0.9024	0.9526	0.9272	0.7957	0.9600
ite-struc-shr	1.0220	0.9975	0.9493	0.9462	0.9782	0.8635	0.8966	0.8799	0.7471	0.9132
ite-struc-struc	1.0664	1.0268	0.9786	0.9726	1.0104	0.8912	0.9249	0.9079	0.7731	0.9432
ite-struc-wls	1.0357	1.0060	0.9594	0.9544	0.9883	0.8728	0.9059	0.8892	0.757	0.9231
ite-wlsh-ols	0.9774	0.9856	0.9727	0.9793	0.9787	0.8348	0.9317	0.8819	0.7612	0.9165
ite-wlsh-shr	0.9302	0.9448	0.9242	0.9301	0.9323	0.7934	0.8751	0.8333	0.7122	0.8688
ite-wlsh-struc	0.9828	0.9829	0.958	0.9585	0.9705	0.8295	0.9062	0.8670	0.7422	0.9044
ite-wlsh-wls	0.943	0.9528	0.9328	0.9349	0.9408	0.803	0.8821	0.8417	0.7207	0.8773
ite-wlsv-ols	0.9789	0.9832	0.9731	0.9761	0.9778	0.8367	0.9307	0.8825	0.7610	0.9162
ite-wlsv-shr	0.9253	0.9420	0.9224	0.9274	0.9292	0.7932	0.8739	0.8326	0.7114	0.8668
ite-wlsv-struc	0.9823	0.9804	0.9572	0.9561	0.9689	0.8307	0.9057	0.8674	0.7420	0.9036
ite-wlsv-wls	0.9411	0.9506	0.9316	0.9326	0.9390	0.8032	0.8811	0.8412	0.7198	0.8760

Table A.12: AvgRelMSE for all 95 series at any temporal aggregation level and any forecast horizon.

Procedure	Quarterly all					Semi-annual all			Annual all	All all
	1	2	3	4	1-4	1	2	1-2	1	1
base	1	1	1	1	1	1	1	1	1	1
kah-struc-shr	1.1165	1.0235	0.9827	0.9675	1.021	0.8968	0.9212	0.9090	0.7820	0.9507
kah-struc-wls	1.1282	1.0314	0.9894	0.9738	1.029	0.9065	0.9284	0.9174	0.7909	0.9591
kah-wlsh-shr	0.9586	0.9696	0.9727	0.9639	0.9662	0.8101	0.9139	0.8605	0.7538	0.9021
kah-wlsh-wls	0.9607	0.9721	0.9749	0.9662	0.9684	0.8135	0.9168	0.8636	0.7578	0.9050
kah-wlsv-shr	0.9684	0.9697	0.9596	0.9603	0.9645	0.8175	0.9085	0.8618	0.7518	0.9013
kah-wlsv-wls	0.9717	0.9725	0.9623	0.9627	0.9673	0.8211	0.9113	0.8650	0.7557	0.9044
tcs-acov-ols	1.2022	1.1597	1.1356	1.1189	1.1537	0.9763	1.0734	1.0237	0.9082	1.0775
tcs-acov-shr	0.9453	0.9583	0.9710	0.9626	0.9592	0.7977	0.9117	0.8528	0.7481	0.8952
tcs-acov-struc	1.1845	1.1243	1.0953	1.0755	1.1192	0.9455	1.0205	0.9823	0.8522	1.0371
tcs-acov-wls	0.9470	0.9613	0.9729	0.9657	0.9617	0.8010	0.9150	0.8561	0.7524	0.8982
tcs-bu-ols	1.2189	1.1663	1.1631	1.1510	1.1745	1.0049	1.1145	1.0583	0.9456	1.1053
tcs-bu-shr	0.9640	0.9680	0.9694	0.9733	0.9687	0.8181	0.9226	0.8688	0.7659	0.9080
tcs-bu-struc	1.1911	1.1363	1.1248	1.1049	1.1388	0.9726	1.0607	1.0157	0.8912	1.0643
tcs-bu-wls	0.9635	0.9678	0.9693	0.9733	0.9685	0.8183	0.9223	0.8687	0.7662	0.9080
tcs-har1-ols	1.2027	1.1537	1.1345	1.1192	1.1521	0.9793	1.0755	1.0263	0.9111	1.0779
tcs-har1-shr	0.9578	0.9697	0.9730	0.9642	0.9661	0.8102	0.9143	0.8607	0.7540	0.9022
tcs-har1-struc	1.1805	1.1191	1.0949	1.0747	1.1166	0.9468	1.0220	0.9837	0.8544	1.0365
tcs-har1-wls	0.9597	0.9719	0.9750	0.9664	0.9682	0.8134	0.9170	0.8636	0.7578	0.9049
tcs-ols-ols	1.5246	1.2871	1.1918	1.1415	1.2782	1.1855	1.1172	1.1508	1.0041	1.1984
tcs-ols-shr	1.2740	1.0994	1.0251	0.9932	1.0928	0.9991	0.9545	0.9765	0.8323	1.0178
tcs-ols-struc	1.4737	1.2368	1.1364	1.0908	1.2260	1.1299	1.0528	1.0907	0.9283	1.1395
tcs-ols-wls	1.2912	1.1114	1.0358	1.0026	1.1049	1.0135	0.9654	0.9891	0.8455	1.0303
tcs-sar1-ols	1.2039	1.1488	1.1281	1.1134	1.1481	0.9825	1.0727	1.0266	0.9106	1.0757
tcs-sar1-shr	0.9684	0.9697	0.9597	0.9603	0.9645	0.8175	0.9086	0.8619	0.7518	0.9013
tcs-sar1-struc	1.1777	1.1163	1.0869	1.0692	1.1118	0.9498	1.0195	0.9841	0.8538	1.0339
tcs-sar1-wls	0.9715	0.9721	0.9622	0.9627	0.9671	0.8209	0.9113	0.8649	0.7555	0.9043
tcs-shr-ols	1.2507	1.2016	1.1786	1.1390	1.1918	1.0198	1.1035	1.0608	0.9410	1.1146
tcs-shr-shr	0.9592	0.9689	0.9854	0.9810	0.9736	0.8045	0.9261	0.8632	0.7579	0.9076
tcs-shr-struc	1.2234	1.166	1.1372	1.0969	1.1550	0.9845	1.0502	1.0168	0.8810	1.0714
tcs-shr-wls	0.9573	0.9688	0.9874	0.9818	0.9738	0.8044	0.9279	0.8640	0.7597	0.9082
tcs-strar1-ols	1.3234	1.1883	1.1344	1.1053	1.1850	1.0479	1.0689	1.0583	0.9278	1.1079
tcs-strar1-shr	1.1161	1.0243	0.9836	0.9679	1.0214	0.8972	0.9219	0.9095	0.7825	0.9512
tcs-strar1-struc	1.2906	1.1503	1.0885	1.0607	1.1442	1.009	1.0135	1.0113	0.8676	1.0617
tcs-strar1-wls	1.1276	1.0318	0.9900	0.9741	1.0292	0.9066	0.9288	0.9176	0.7911	0.9593
tcs-struc-ols	1.3229	1.1874	1.1342	1.1043	1.1843	1.0470	1.0683	1.0576	0.9272	1.1073
tcs-struc-shr	1.2906	1.1497	1.0883	1.0600	1.1438	1.0086	1.0131	1.0108	0.8674	1.0613
tcs-struc-wls	1.2026	1.1519	1.1338	1.1182	1.1512	0.9777	1.0746	1.0250	0.9100	1.0768
tcs-wlsh-ols	1.1807	1.1182	1.0946	1.0744	1.1163	0.9459	1.0216	0.9830	0.8541	1.0361
tcs-wlsh-struc	1.2036	1.1472	1.1275	1.1125	1.1472	0.9810	1.0719	1.0254	0.9096	1.0748
tcs-wlsh-wls	1.1779	1.1154	1.0867	1.0688	1.1114	0.9491	1.0192	0.9835	0.8535	1.0335
ite-acov-ols	1.2022	1.1597	1.1356	1.1189	1.1537	0.9763	1.0734	1.0237	0.9082	1.0775
ite-acov-shr	0.9398	0.9583	0.9709	0.9653	0.9585	0.7957	0.9127	0.8522	0.7476	0.8945
ite-acov-struc	1.1845	1.1243	1.0953	1.0755	1.1192	0.9455	1.0205	0.9823	0.8522	1.0371
ite-acov-wls	0.9459	0.9632	0.9734	0.9674	0.9624	0.8013	0.9163	0.8569	0.7528	0.8989
ite-bu-ols	1.2189	1.1663	1.1631	1.1510	1.1745	1.0049	1.1145	1.0583	0.9456	1.1053
ite-bu-shr	0.9583	0.9701	0.9757	0.9824	0.9716	0.8191	0.9356	0.8754	0.7757	0.9132
ite-bu-struc	1.1911	1.1363	1.1248	1.1049	1.1388	0.9726	1.0607	1.0157	0.8912	1.0643
ite-bu-wls	0.9619	0.9698	0.9730	0.9778	0.9706	0.8200	0.9293	0.8730	0.7735	0.9116
ite-har1-ols	1.2027	1.1537	1.1345	1.1192	1.1521	0.9793	1.0755	1.0263	0.9111	1.0779
ite-har1-shr	0.9504	0.9690	0.9727	0.9657	0.9644	0.8076	0.9151	0.8597	0.7535	0.9009
ite-har1-struc	1.1805	1.1191	1.0949	1.0747	1.1166	0.9468	1.0220	0.9837	0.8544	1.0365
ite-har1-wls	0.9565	0.9723	0.9754	0.9674	0.9679	0.8125	0.9182	0.8637	0.7582	0.9048
ite-ols-ols	1.5246	1.2871	1.1918	1.1415	1.2782	1.1855	1.1172	1.1508	1.0041	1.1984
ite-ols-shr	1.286	1.1022	1.0254	0.9913	1.0956	1.0063	0.9545	0.9801	0.8345	1.0208
ite-ols-struc	1.4737	1.2368	1.1364	1.0908	1.2260	1.1299	1.0528	1.0907	0.9283	1.1395
ite-ols-wls	1.2947	1.1111	1.0353	1.0014	1.1051	1.0149	0.9653	0.9898	0.8449	1.0306
ite-sar1-ols	1.2039	1.1488	1.1281	1.1134	1.1481	0.9825	1.0727	1.0266	0.9106	1.0757
ite-sar1-shr	0.9613	0.9683	0.9588	0.9605	0.9622	0.8151	0.9092	0.8609	0.7514	0.8997
ite-sar1-struc	1.1777	1.1163	1.0869	1.0692	1.1118	0.9498	1.0195	0.9841	0.8538	1.0339
ite-sar1-wls	0.9690	0.9715	0.9622	0.9631	0.9664	0.8202	0.9125	0.8651	0.7561	0.9041
ite-shr-ols	1.2507	1.2016	1.1786	1.1390	1.1918	1.0198	1.1035	1.0608	0.9410	1.1146
ite-shr-shr	0.9612	0.9747	0.9884	0.9834	0.9769	0.8088	0.9282	0.8664	0.7597	0.9107
ite-shr-struc	1.2234	1.1660	1.1372	1.0969	1.1550	0.9845	1.0502	1.0168	0.8810	1.0714
ite-shr-wls	0.9580	0.9738	0.9896	0.9832	0.9761	0.8074	0.9299	0.8665	0.7611	0.9105
ite-strar1-ols	1.3234	1.1883	1.1344	1.1053	1.1850	1.0479	1.0689	1.0583	0.9278	1.1079
ite-strar1-shr	1.1178	1.0235	0.9823	0.9666	1.0209	0.8980	0.9215	0.9097	0.7825	0.9510
ite-strar1-struc	1.2906	1.1503	1.0885	1.0607	1.1442	1.009	1.0135	1.0113	0.8676	1.0617
ite-strar1-wls	1.1283	1.0306	0.9891	0.9734	1.0286	0.9065	0.9289	0.9176	0.7911	0.9590
ite-struc-ols	1.3229	1.1874	1.1342	1.1043	1.1843	1.047	1.0683	1.0576	0.9272	1.1073
ite-struc-shr	1.1178	1.0227	0.9815	0.9661	1.0204	0.8975	0.9210	0.9091	0.7820	0.9505
ite-struc-struc	1.2906	1.1497	1.0883	1.0600	1.1438	1.0086	1.0131	1.0108	0.8674	1.0613
ite-struc-wls	1.1289	1.0304	0.9885	0.9730	1.0284	0.9065	0.9285	0.9174	0.7909	0.9588
ite-wlsh-ols	1.2026	1.1519	1.1338	1.1182	1.1512	0.9777	1.0746	1.0250	0.9100	1.0768
ite-wlsh-shr	0.9510	0.9686	0.9725	0.9653	0.9643	0.8073	0.9147	0.8593	0.7531	0.9007
ite-wlsh-struc	1.1807	1.1182	1.0946	1.0744	1.1163	0.9459	1.0216	0.9830	0.8541	1.0361
ite-wlsh-wls	0.9574	0.9725	0.9753	0.9672	0.9681	0.8127	0.9179	0.8637	0.7582	0.9049
ite-wlsv-ols	1.2036	1.1472	1.1275	1.1125	1.1472	0.9810	1.0719	1.0254	0.9096	1.0748
ite-wlsv-shr	0.9611	0.9680	0.9587	0.9604	0.9620	0.8148	0.9091	0.8606	0.7512	0.8995
ite-wlsv-struc	1.1779	1.1154	1.0867	1.0688	1.1114	0.9491	1.0192	0.9835	0.8535	1.0335
ite-wlsv-wls	0.9692	0.9719	0.9622	0.9631	0.9666	0.8203	0.9125	0.8652	0.7562	0.9042

Table A.13: AvgRelMAE for the 63 bottom series at any temporal aggregation level and any forecast horizon.

Procedure	Quarterly bts				Semi-annual bts			Annual bts	All bts	
	1	2	3	4	1-4	1	2	1-2	1	
base	1	1	1	1	1	1	1	1	1	
kah-struct-shr	1.0858	1.0187	1.0046	0.9918	1.0246	0.9603	0.9669	0.9636	0.8928	0.9872
kah-struct-wls	1.092	1.0238	1.0082	0.9957	1.0293	0.9665	0.9716	0.9690	0.8991	0.9923
kah-wlsh-shr	0.9833	0.9884	0.9960	0.9861	0.9884	0.9054	0.9598	0.9322	0.8717	0.9548
kah-wlsh-wls	0.9840	0.9895	0.9969	0.9882	0.9897	0.9072	0.9622	0.9343	0.8747	0.9565
kah-wlsv-shr	0.9930	0.9888	0.9875	0.9844	0.9884	0.9115	0.9559	0.9334	0.8703	0.9549
kah-wlsv-wls	0.9949	0.9906	0.9887	0.9863	0.9901	0.9137	0.9582	0.9357	0.8733	0.9569
tcs-acov-ols	1.1773	1.1274	1.1123	1.0935	1.1272	1.0369	1.0682	1.0525	0.9922	1.0853
tcs-acov-shr	0.9751	0.9807	0.9953	0.9859	0.9842	0.8957	0.9582	0.9265	0.8680	0.9502
tcs-acov-struct	1.1558	1.0964	1.0830	1.0631	1.0991	1.0106	1.0329	1.0217	0.9488	1.0540
tcs-acov-wls	0.9756	0.9820	0.9962	0.9886	0.9856	0.8972	0.9607	0.9284	0.8713	0.9520
tcs-bu-ols	1.1922	1.1373	1.1313	1.1183	1.1444	1.0589	1.100	1.0792	1.0212	1.1072
tcs-bu-shr	0.9934	0.9921	0.9939	0.9939	0.9933	0.9146	0.9657	0.9398	0.8814	0.9612
tcs-bu-struct	1.1647	1.1111	1.1009	1.0842	1.1148	1.0333	1.0615	1.0473	0.9774	1.0747
tcs-bu-wls	0.9918	0.9911	0.9935	0.9949	0.9928	0.9141	0.9663	0.9398	0.8816	0.9609
tcs-har1-ols	1.1751	1.1244	1.1108	1.0933	1.1255	1.0387	1.0703	1.0544	0.9942	1.0853
tcs-har1-shr	0.9827	0.9886	0.9961	0.9862	0.9884	0.9056	0.9600	0.9324	0.8718	0.9548
tcs-har1-struct	1.1501	1.0937	1.0816	1.0630	1.0966	1.0104	1.0348	1.0225	0.9500	1.0531
tcs-har1-wls	0.9833	0.9897	0.9970	0.9884	0.9896	0.9074	0.9624	0.9345	0.8749	0.9565
tcs-ols-ols	1.3301	1.1831	1.1399	1.0992	1.1850	1.1405	1.0880	1.1139	1.0419	1.1430
tcs-ols-shr	1.1678	1.0611	1.0312	1.0070	1.0650	1.0194	0.9877	1.0034	0.9239	1.0260
tcs-ols-struct	1.2967	1.1489	1.1052	1.0676	1.1514	1.1045	1.049	1.0764	0.9922	1.1057
tcs-ols-wls	1.1774	1.0673	1.0362	1.0124	1.0716	1.0273	0.9938	1.0104	0.9322	1.0330
tcs-sar1-ols	1.1759	1.1220	1.1060	1.0914	1.1234	1.0402	1.0684	1.0542	0.9939	1.0840
tcs-sar1-shr	0.9930	0.9891	0.9875	0.9844	0.9885	0.9117	0.9559	0.9335	0.8704	0.9550
tcs-sar1-struct	1.1516	1.0929	1.0761	1.0605	1.0947	1.0123	1.0330	1.0226	0.9497	1.0520
tcs-sar1-wls	0.9947	0.9908	0.9886	0.9863	0.9901	0.9138	0.9582	0.9357	0.8733	0.9569
tcs-shr-ols	1.2098	1.1593	1.1377	1.1055	1.1525	1.0714	1.0884	1.0799	1.0161	1.1111
tcs-shr-shr	0.9854	0.9883	1.0015	0.9954	0.9926	0.9015	0.9664	0.9334	0.8720	0.9574
tcs-shr-struct	1.1808	1.1267	1.1050	1.0757	1.1214	1.0403	1.0513	1.0458	0.9676	1.0763
tcs-shr-wls	0.9828	0.9867	1.0021	0.9965	0.9920	0.9007	0.9683	0.9339	0.8741	0.9576
tcs-strar1-ols	1.2352	1.1351	1.1060	1.0815	1.1380	1.0681	1.0623	1.0652	0.9987	1.0961
tcs-strar1-shr	1.0852	1.0195	1.0055	0.9920	1.0250	0.9606	0.9674	0.9640	0.8934	0.9876
tcs-strar1-struct	1.2088	1.1065	1.0768	1.0526	1.1096	1.0406	1.0279	1.0342	0.9566	1.0647
tcs-strar1-wls	1.0916	1.0245	1.0089	0.9959	1.0296	0.9668	0.9720	0.9694	0.8994	0.9927
tcs-struct-ols	1.2344	1.1341	1.1058	1.0811	1.1374	1.0672	1.0619	1.0645	0.9983	1.0955
tcs-struct-struct	1.2084	1.1061	1.0763	1.0521	1.1092	1.0398	1.0277	1.0337	0.9565	1.0643
tcs-struct-wls	1.1747	1.1229	1.1101	1.0928	1.1247	1.0370	1.0696	1.0532	0.9934	1.0844
tcs-wlsh-struct	1.1500	1.0931	1.0812	1.0627	1.0963	1.0097	1.0344	1.0220	0.9499	1.0527
tcs-wlsv-ols	1.1752	1.1203	1.1054	1.0909	1.1225	1.0384	1.0679	1.0530	0.9931	1.0831
tcs-wlsv-struct	1.1512	1.0921	1.0759	1.0602	1.0943	1.0118	1.0328	1.0222	0.9495	1.0517
ite-acov-ols	1.1773	1.1274	1.1123	1.0935	1.1272	1.0369	1.0682	1.0525	0.9922	1.0853
ite-acov-shr	0.9746	0.9819	0.9963	0.9878	0.9851	0.8965	0.9597	0.9276	0.8677	0.9509
ite-acov-struct	1.1558	1.0964	1.0830	1.0631	1.0991	1.0106	1.0329	1.0217	0.9488	1.0540
ite-acov-wls	0.9758	0.9839	0.9972	0.9905	0.9868	0.8980	0.9620	0.9295	0.8715	0.9530
ite-bu-ols	1.1922	1.1373	1.1313	1.1183	1.1444	1.0589	1.100	1.0792	1.0212	1.1072
ite-bu-shr	0.9917	0.9953	1.0002	1.0018	0.9972	0.9175	0.9763	0.9464	0.8922	0.9669
ite-bu-struct	1.1647	1.1111	1.1009	1.0842	1.1148	1.0333	1.0615	1.0473	0.9774	1.0747
ite-bu-wls	0.9913	0.9936	0.9971	0.9996	0.9954	0.9162	0.9721	0.9438	0.8885	0.9646
ite-har1-ols	1.1751	1.1244	1.1108	1.0933	1.1255	1.0387	1.0703	1.0544	0.9942	1.0853
ite-har1-shr	0.9794	0.9880	0.9967	0.9874	0.9878	0.9053	0.9610	0.9327	0.8715	0.9545
ite-har1-struct	1.1501	1.0937	1.0816	1.0630	1.0966	1.0104	1.0348	1.0225	0.9500	1.0531
ite-har1-wls	0.9806	0.9901	0.9978	0.9898	0.9896	0.9070	0.9633	0.9348	0.8749	0.9566
ite-ols-ols	1.3301	1.1831	1.1399	1.0992	1.1850	1.1405	1.0880	1.1139	1.0419	1.1430
ite-ols-shr	1.1712	1.0600	1.0301	1.0057	1.0649	1.0218	0.9868	1.0041	0.9234	1.0261
ite-ols-struct	1.2967	1.1489	1.1052	1.0676	1.1514	1.1045	1.049	1.0764	0.9922	1.1057
ite-ols-wls	1.1782	1.0661	1.0356	1.0120	1.0711	1.0279	0.9937	1.0107	0.9307	1.0326
ite-sar1-ols	1.1759	1.1220	1.1060	1.0914	1.1234	1.0402	1.0684	1.0542	0.9939	1.0840
ite-sar1-shr	0.9897	0.9879	0.9869	0.9844	0.9872	0.9109	0.9569	0.9336	0.8700	0.9542
ite-sar1-struct	1.1516	1.0929	1.0761	1.0605	1.0947	1.0123	1.0330	1.0226	0.9497	1.0520
ite-sar1-wls	0.9927	0.9903	0.9887	0.9870	0.9897	0.9134	0.9591	0.9360	0.8733	0.9568
ite-shr-ols	1.2098	1.1593	1.1377	1.1055	1.1525	1.0714	1.0884	1.0799	1.0161	1.1111
ite-shr-shr	0.9895	0.9931	1.0057	0.9976	0.9965	0.9075	0.9691	0.9378	0.8735	0.9611
ite-shr-struct	1.1808	1.1267	1.1050	1.0757	1.1214	1.0403	1.0513	1.0458	0.9676	1.0763
ite-shr-wls	0.9831	0.9915	1.0049	0.9980	0.9943	0.9036	0.9700	0.9362	0.8746	0.9596
ite-strar1-ols	1.2352	1.1351	1.1060	1.0815	1.1380	1.0681	1.0623	1.0652	0.9987	1.0961
ite-strar1-shr	1.0854	1.0180	1.0047	0.9915	1.0243	0.9607	0.9676	0.9641	0.8934	0.9872
ite-strar1-struct	1.2088	1.1065	1.0768	1.0526	1.1096	1.0406	1.0279	1.0342	0.9566	1.0647
ite-strar1-wls	1.0919	1.0236	1.0085	0.9957	1.0293	0.9667	0.9723	0.9695	0.8994	0.9925
ite-struct-ols	1.2344	1.1341	1.1058	1.0811	1.1374	1.0672	1.0619	1.0645	0.9983	1.0955
ite-struct-shr	1.0856	1.0172	1.0038	0.9913	1.0239	0.9603	0.9671	0.9637	0.8928	0.9868
ite-struct-struct	1.2084	1.1061	1.0763	1.0521	1.1092	1.0398	1.0277	1.0337	0.9565	1.0643
ite-struct-wls	1.0923	1.0228	1.0078	0.9955	1.029	0.9664	0.9719	0.9692	0.8991	0.9922
ite-wlsh-ols	1.1747	1.1229	1.1101	1.0928	1.1247	1.037	1.0696	1.0532	0.9934	1.0844
ite-wlsh-shr	0.9801	0.9877	0.9966	0.9872	0.9879	0.9051	0.9607	0.9325	0.8713	0.9544
ite-wlsh-struct	1.1500	1.0931	1.0812	1.0627	1.0963	1.0097	1.0344	1.0220	0.9499	1.0527
ite-wlsh-wls	0.9815	0.9899	0.9979	0.9897	0.9897	0.9069	0.9632	0.9346	0.8747	0.9566
ite-wlsv-ols	1.1752	1.1203	1.1054	1.0909	1.1225	1.0384	1.0679	1.053	0.9931	1.0831
ite-wlsv-shr	0.9898	0.9874	0.9869	0.9844	0.9871	0.9106	0.9568	0.9334	0.8699	0.9541
ite-wlsv-struct	1.1512	1.0921	1.0759	1.0602	1.0943	1.0118	1.0328	1.0222	0.9495	1.0517
ite-wlsv-wls	0.9929	0.9901	0.9888	0.9870	0.9897	0.9133	0.9591	0.9360	0.8732	0.9568

Table A.14: AvgRelMAE for the 32 upper series at any temporal aggregation level and any forecast horizon.

Procedure	Quarterly					Semi-annual			Annual	All
	bts					bts			bts	bts
	1	2	3	4	1-4	1	2	1-2	1	1
base	1	1	1	1	1	1	1	1	1	1
kah-struc-shr	0.9972	0.9988	0.9846	0.9842	0.9912	0.9266	0.9447	0.9356	0.8599	0.9554
kah-struc-wls	1.0058	1.0070	0.9925	0.9938	0.9998	0.9351	0.9555	0.9452	0.8718	0.9648
kah-wlsh-shr	0.9584	0.9711	0.9655	0.9697	0.9662	0.8909	0.9271	0.9088	0.8322	0.9294
kah-wlsh-wls	0.9644	0.9777	0.9727	0.9775	0.9731	0.8969	0.9356	0.9160	0.8418	0.9368
kah-wlsv-shr	0.9538	0.9713	0.9646	0.9685	0.9645	0.8912	0.9265	0.9087	0.8319	0.9284
kah-wlsv-wls	0.9610	0.9780	0.9724	0.9763	0.9719	0.8975	0.9347	0.9160	0.8414	0.9361
tcs-acov-ols	0.9798	0.9938	0.9886	0.9891	0.9878	0.9113	0.9531	0.9319	0.8571	0.9520
tcs-acov-shr	0.9595	0.9679	0.9655	0.9700	0.9657	0.8895	0.9269	0.9080	0.8314	0.9288
tcs-acov-struc	0.9850	0.9926	0.9848	0.9888	0.9878	0.9113	0.9482	0.9296	0.8524	0.9506
tcs-acov-wls	0.9656	0.9752	0.9729	0.9782	0.9730	0.8956	0.9356	0.9154	0.8409	0.9364
tcs-bu-ols	0.9820	0.9878	0.9875	0.9852	0.9856	0.9104	0.9522	0.9311	0.8570	0.9505
tcs-bu-shr	0.9541	0.9618	0.9611	0.9640	0.9603	0.8834	0.9226	0.9028	0.8257	0.9233
tcs-bu-struc	0.9821	0.9876	0.9840	0.9849	0.9846	0.9082	0.9465	0.9271	0.8491	0.9476
tcs-bu-wls	0.9588	0.9682	0.9677	0.9704	0.9663	0.8887	0.9297	0.9090	0.8334	0.9297
tcs-har1-ols	0.9806	0.9937	0.9884	0.9892	0.9880	0.9125	0.9537	0.9329	0.8578	0.9525
tcs-har1-shr	0.9584	0.9710	0.9652	0.9696	0.9661	0.8910	0.9270	0.9088	0.8321	0.9293
tcs-har1-struc	0.9816	0.9930	0.9844	0.9882	0.9868	0.9122	0.9482	0.9300	0.853	0.9502
tcs-har1-wls	0.9643	0.9773	0.9724	0.9773	0.9728	0.8969	0.9351	0.9158	0.8414	0.9366
tcs-ols-ols	1.0857	1.0534	1.0331	1.0249	1.0491	1.0027	0.9971	0.9999	0.9226	1.0159
tcs-ols-shr	1.0498	1.0321	1.0073	1.0025	1.0227	0.9725	0.9664	0.9695	0.8934	0.9880
tcs-ols-struc	1.0772	1.0535	1.0276	1.0205	1.0445	0.9935	0.9912	0.9923	0.9169	1.0103
tcs-ols-wls	1.0616	1.0427	1.0171	1.0137	1.0336	0.9827	0.9791	0.9809	0.9067	0.9994
tcs-sar1-ols	0.9793	0.9913	0.9877	0.9875	0.9864	0.9129	0.9529	0.9327	0.8576	0.9516
tcs-sar1-shr	0.9539	0.9711	0.9643	0.9684	0.9644	0.8913	0.9263	0.9086	0.8318	0.9283
tcs-sar1-struc	0.9790	0.9928	0.9840	0.9873	0.9858	0.9119	0.9483	0.9299	0.8529	0.9496
tcs-sar1-wls	0.9610	0.9776	0.9720	0.9760	0.9716	0.8975	0.9344	0.9157	0.8410	0.9358
tcs-shr-ols	0.9926	0.9919	0.9878	0.9907	0.9907	0.9134	0.9526	0.9328	0.8569	0.9538
tcs-shr-shr	0.9617	0.9623	0.9588	0.9699	0.9632	0.8836	0.9240	0.9036	0.8249	0.9250
tcs-shr-struc	0.9913	0.9900	0.9837	0.9911	0.9890	0.9101	0.9486	0.9291	0.8487	0.9505
tcs-shr-wls	0.9638	0.9688	0.9676	0.9775	0.9694	0.8882	0.9327	0.9102	0.8331	0.9317
tcs-strar1-ols	1.0214	1.0151	1.0039	1.0034	1.0109	0.9469	0.9693	0.958	0.8837	0.9766
tcs-strar1-shr	0.9975	0.9983	0.9843	0.9844	0.9911	0.9267	0.9446	0.9356	0.8598	0.9553
tcs-strar1-struc	1.0173	1.0161	1.0006	1.0003	1.0085	0.9431	0.9647	0.9538	0.8793	0.9733
tcs-strar1-wls	1.0060	1.0062	0.9919	0.9939	0.9995	0.9350	0.9551	0.945	0.8714	0.9645
tcs-struc-ols	1.0209	1.0163	1.0046	1.0032	1.0112	0.9473	0.9697	0.9584	0.8841	0.9769
tcs-struc-shr	1.0170	1.0171	1.0013	1.0003	1.0089	0.9433	0.9651	0.9541	0.8800	0.9737
tcs-wlsh-ols	0.9805	0.9940	0.9888	0.9893	0.9881	0.9124	0.9541	0.9330	0.8581	0.9527
tcs-wlsh-struc	0.9817	0.9934	0.9848	0.9885	0.9871	0.9121	0.9487	0.9302	0.8534	0.9505
tcs-wlsv-ols	0.9792	0.9918	0.9881	0.9875	0.9866	0.9103	0.9532	0.9329	0.8579	0.9518
tcs-wlsv-struc	0.9790	0.9930	0.9845	0.9874	0.9860	0.9118	0.9488	0.9301	0.8533	0.9499
ite-acov-ols	0.9798	0.9938	0.9886	0.9891	0.9878	0.9113	0.9531	0.9319	0.8571	0.9520
ite-acov-shr	0.9528	0.9674	0.9627	0.9684	0.9628	0.8879	0.9257	0.9066	0.8297	0.9265
ite-acov-struc	0.9850	0.9926	0.9848	0.9888	0.9878	0.9113	0.9482	0.9296	0.8524	0.9506
ite-acov-wls	0.9640	0.9750	0.9720	0.9778	0.9722	0.8950	0.9349	0.9147	0.8399	0.9357
ite-bu-ols	0.9820	0.9878	0.9875	0.9852	0.9856	0.9104	0.9522	0.9311	0.857	0.9505
ite-bu-shr	0.9484	0.9628	0.9595	0.9652	0.9590	0.8844	0.9234	0.9037	0.8259	0.9229
ite-bu-struc	0.9821	0.9876	0.9840	0.9849	0.9846	0.9082	0.9465	0.9271	0.8491	0.9476
ite-bu-wls	0.9562	0.9673	0.9664	0.9692	0.9648	0.8875	0.9283	0.9077	0.8323	0.9283
ite-har1-ols	0.9806	0.9937	0.9884	0.9892	0.9880	0.9125	0.9537	0.9329	0.8578	0.9525
ite-har1-shr	0.9517	0.9712	0.9624	0.9681	0.9633	0.8901	0.9257	0.9078	0.8305	0.9273
ite-har1-struc	0.9816	0.9930	0.9844	0.9882	0.9868	0.9122	0.9482	0.9300	0.853	0.9502
ite-har1-wls	0.9621	0.9770	0.9714	0.9768	0.9718	0.8965	0.9345	0.9153	0.8405	0.9357
ite-ols-ols	1.0857	1.0534	1.0331	1.0249	1.0491	1.0027	0.9971	0.9999	0.9226	1.0159
ite-ols-shr	1.0534	1.0362	1.0083	1.0026	1.0249	0.9781	0.9685	0.9733	0.8972	0.9909
ite-ols-struc	1.0772	1.0535	1.0276	1.0205	1.0445	0.9935	0.9912	0.9923	0.9169	1.0103
ite-ols-wls	1.0629	1.0435	1.0175	1.0135	1.0342	0.9851	0.9803	0.9827	0.9084	1.0005
ite-sar1-ols	0.9793	0.9913	0.9877	0.9875	0.9864	0.9129	0.9529	0.9327	0.8576	0.9516
ite-sar1-shr	0.9469	0.9704	0.9611	0.9665	0.9612	0.8901	0.9246	0.9072	0.8300	0.9258
ite-sar1-struc	0.9790	0.9928	0.9840	0.9873	0.9858	0.9119	0.9483	0.9299	0.8529	0.9496
ite-sar1-wls	0.9589	0.9770	0.9708	0.9750	0.9704	0.8970	0.9335	0.9151	0.8400	0.9348
ite-shr-ols	0.9926	0.9919	0.9878	0.9907	0.9907	0.9134	0.9526	0.9328	0.8569	0.9538
ite-shr-shr	0.9585	0.9624	0.9562	0.9684	0.9614	0.8838	0.9221	0.9028	0.8229	0.9235
ite-shr-struc	0.9913	0.9900	0.9837	0.9911	0.9890	0.9101	0.9486	0.9291	0.8487	0.9505
ite-shr-wls	0.9615	0.9690	0.9657	0.9772	0.9683	0.8874	0.9319	0.9094	0.8314	0.9306
ite-strar1-ols	1.0214	1.0151	1.0039	1.0034	1.0109	0.9469	0.9693	0.9580	0.8837	0.9766
ite-strar1-shr	0.9946	0.9986	0.9823	0.9829	0.9896	0.9270	0.9441	0.9355	0.8598	0.9545
ite-strar1-struc	1.0173	1.0161	1.0006	1.0003	1.0085	0.9431	0.9647	0.9538	0.8793	0.9733
ite-strar1-wls	1.0055	1.0056	0.9915	0.9932	0.9990	0.9352	0.9550	0.9451	0.8714	0.9642
ite-struc-ols	1.0209	1.0163	1.0046	1.0032	1.0112	0.9473	0.9697	0.9584	0.8841	0.9769
ite-struc-shr	0.9941	0.999	0.9829	0.9827	0.9896	0.9267	0.9442	0.9354	0.8599	0.9545
ite-struc-struc	1.0170	1.0171	1.0013	1.0003	1.0089	0.9433	0.9651	0.9541	0.8800	0.9737
ite-struc-wls	1.0054	1.0065	0.9922	0.9932	0.9993	0.9353	0.9554	0.9453	0.8718	0.9646
ite-wlsh-ols	0.9805	0.9940	0.9888	0.9893	0.9881	0.9124	0.9541	0.9330	0.8581	0.9527
ite-wlsh-shr	0.9515	0.9709	0.9627	0.9681	0.9633	0.8897	0.9258	0.9076	0.8304	0.9272
ite-wlsh-struc	0.9817	0.9934	0.9848	0.9885	0.9871	0.9121	0.9487	0.9302	0.8534	0.9505
ite-wlsh-wls	0.9621	0.9773	0.9717	0.9770	0.9720	0.8964	0.9349	0.9155	0.8409	0.9359
ite-wlsv-ols	0.9792	0.9918	0.9881	0.9875	0.9866	0.9130	0.9532	0.9329	0.8579	0.9518
ite-wlsv-shr	0.9466	0.9700	0.9614	0.9665	0.9611	0.8897	0.9247	0.9071	0.8299	0.9257
ite-wlsv-struc	0.9790	0.9930	0.9845	0.9874	0.9860	0.9118	0.9488	0.9301	0.8533	0.9499
ite-wlsv-wls	0.9589	0.9773	0.9712	0.9752	0.9706	0.8969	0.9339	0.9152	0.8404	0.9350

Table A.15: AvgRelMAE for the 95 series at any temporal aggregation level and any forecast horizon.

Procedure	Quarterly all					Semi-annual all			Annual all	All all
	1	2	3	4	1-4	1	2	1-2	1	1
base	1	1	1	1	1	1	1	1	1	1
kah-struc-shr	1.0551	1.0120	0.9978	0.9893	1.0132	0.9488	0.9593	0.954	0.8816	0.9763
kah-struc-wls	1.0622	1.0181	1.0029	0.9951	1.0192	0.9558	0.9661	0.9610	0.8898	0.9830
kah-wlsh-shr	0.9749	0.9826	0.9856	0.9805	0.9809	0.9005	0.9487	0.9243	0.8582	0.9461
kah-wlsh-wls	0.9774	0.9855	0.9887	0.9846	0.9840	0.9038	0.9532	0.9281	0.8635	0.9498
kah-wlsv-shr	0.9796	0.9829	0.9797	0.9790	0.9803	0.9046	0.9459	0.9250	0.8572	0.9459
kah-wlsv-wls	0.9833	0.9863	0.9832	0.9829	0.9839	0.9082	0.9502	0.9290	0.8624	0.9499
tcs-acov-shr	1.1067	1.0805	1.0690	1.0571	1.0782	0.9928	1.028	1.0102	0.9444	1.0385
tcs-acov-struc	0.9698	0.9764	0.9852	0.9805	0.9780	0.8936	0.9476	0.9202	0.8555	0.9429
tcs-acov-wls	1.0952	1.0603	1.0489	1.0375	1.0603	0.9760	1.0036	0.9897	0.9152	1.0180
tcs-bu-ols	0.9723	0.9797	0.9883	0.9851	0.9813	0.8967	0.9522	0.9240	0.8609	0.9467
tcs-bu-shr	1.1168	1.0846	1.0806	1.0716	1.0883	1.0064	1.0478	1.0269	0.9626	1.0518
tcs-bu-struc	0.9800	0.9818	0.9827	0.9837	0.9821	0.9040	0.9510	0.9272	0.8622	0.9483
tcs-bu-wls	1.0997	1.0679	1.0600	1.0497	1.0692	0.9893	1.0213	1.0052	0.9322	1.0301
tcs-har1-ols	0.9805	0.9833	0.9847	0.9866	0.9838	0.9055	0.9538	0.9293	0.8650	0.9503
tcs-har1-shr	1.1056	1.0786	1.0680	1.0571	1.0772	0.9944	1.0295	1.0118	0.9460	1.0386
tcs-har1-struc	0.9745	0.9826	0.9856	0.9806	0.9808	0.9007	0.9488	0.9244	0.8583	0.9461
tcs-har1-wls	1.0903	1.0587	1.0478	1.0372	1.0583	0.9762	1.0048	0.9904	0.9162	1.0173
tcs-ols-ols	0.9768	0.9855	0.9886	0.9847	0.9839	0.9038	0.9531	0.9282	0.8634	0.9497
tcs-ols-shr	1.2422	1.1377	1.1027	1.0736	1.1373	1.0921	1.0565	1.0741	1.0001	1.0985
tcs-ols-struc	1.1267	1.0512	1.0231	1.0055	1.0506	1.0034	0.9805	0.9919	0.9135	1.0130
tcs-ols-wls	1.2181	1.1158	1.0785	1.0515	1.1142	1.0658	1.0292	1.0473	0.9662	1.0726
tcs-sar1-ols	1.137	1.0590	1.0298	1.0129	1.0586	1.0121	0.9888	1.0004	0.9235	1.0215
tcs-sar1-shr	1.1056	1.0762	1.0646	1.0552	1.0752	0.9954	1.028	1.0116	0.9457	1.0375
tcs-sar1-struc	0.9797	0.9830	0.9796	0.9790	0.9803	0.9048	0.9459	0.9251	0.8572	0.9459
tcs-sar1-wls	1.0903	1.0581	1.0441	1.0353	1.0567	0.9773	1.0037	0.9904	0.9159	1.0164
tcs-shr-ols	0.9832	0.9864	0.9830	0.9828	0.9839	0.9082	0.9501	0.9289	0.8623	0.9498
tcs-shr-shr	1.1318	1.100	1.0848	1.0654	1.0952	1.0153	1.0407	1.0279	0.9594	1.0554
tcs-shr-struc	0.9773	0.9795	0.9869	0.9867	0.9826	0.8954	0.9519	0.9232	0.8558	0.9464
tcs-shr-wls	1.1133	1.0787	1.0626	1.0464	1.0749	0.9945	1.0155	1.0049	0.9258	1.0322
tcs-strar1-ols	0.9763	0.9807	0.9904	0.9901	0.9843	0.8965	0.9561	0.9258	0.8601	0.9488
tcs-strar1-shr	1.1586	1.0932	1.0705	1.0546	1.0935	1.0256	1.0300	1.0278	0.9584	1.0543
tcs-strar1-struc	1.0549	1.0123	0.9983	0.9894	1.0134	0.9491	0.9596	0.9543	0.8819	0.9766
tcs-struc-ols	1.1406	1.0752	1.0505	1.0347	1.0745	1.0067	1.0062	1.0064	0.9299	1.0330
tcs-struc-shr	1.0620	1.0183	1.0031	0.9952	1.0193	0.9560	0.9662	0.9611	0.8899	0.9831
tcs-struc-wls	1.1579	1.0929	1.0707	1.0542	1.0932	1.0252	1.0299	1.0275	0.9583	1.0540
tcs-wlsh-ols	1.1402	1.0753	1.0504	1.0343	1.0743	1.0062	1.0062	1.0062	0.9300	1.0329
tcs-wlsh-struc	1.1053	1.0777	1.0677	1.0568	1.0767	0.9932	1.0292	1.0111	0.9456	1.0381
tcs-wlsh-wls	1.0903	1.0585	1.0477	1.0371	1.0582	0.9757	1.0047	0.9901	0.9162	1.0171
tcs-wlsv-ols	1.1052	1.0752	1.0644	1.0549	1.0748	0.9943	1.0278	1.0109	0.9453	1.0369
tcs-wlsv-struc	1.0901	1.0576	1.0442	1.0351	1.0566	0.9770	1.0037	0.9902	0.9160	1.0162
ite-acov-shr	1.1067	1.0805	1.0690	1.0571	1.0782	0.9928	1.028	1.0102	0.9444	1.0385
ite-acov-struc	0.9672	0.9770	0.9849	0.9812	0.9776	0.8936	0.9481	0.9205	0.8547	0.9426
ite-acov-wls	1.0952	1.0603	1.0489	1.0375	1.0603	0.9760	1.0036	0.9897	0.9152	1.0180
ite-bu-ols	0.9718	0.9809	0.9887	0.9862	0.9819	0.8970	0.9528	0.9245	0.8607	0.9471
ite-bu-shr	1.1168	1.0846	1.0806	1.0716	1.0883	1.0064	1.0478	1.0269	0.9626	1.0518
ite-bu-struc	0.9769	0.9842	0.9863	0.9893	0.9842	0.9062	0.9581	0.9318	0.8693	0.9519
ite-bu-wls	1.0997	1.0679	1.0600	1.0497	1.0692	0.9893	1.0213	1.0052	0.9322	1.0301
ite-har1-ols	0.9793	0.9846	0.9866	0.9893	0.9850	0.9065	0.9572	0.9315	0.8692	0.9522
ite-har1-shr	1.1056	1.0786	1.0680	1.0571	1.0772	0.9944	1.0295	1.0118	0.9460	1.0386
ite-har1-struc	0.9700	0.9823	0.9850	0.9808	0.9795	0.9002	0.9489	0.9242	0.8575	0.9453
ite-har1-wls	1.0903	1.0587	1.0478	1.0372	1.0583	0.9762	1.0048	0.9904	0.9162	1.0173
ite-ols-ols	0.9743	0.9856	0.9889	0.9854	0.9835	0.9035	0.9535	0.9282	0.8631	0.9495
ite-ols-shr	1.2422	1.1377	1.1027	1.0736	1.1373	1.0921	1.0565	1.0741	1.0001	1.0985
ite-ols-struc	1.1301	1.0519	1.0227	1.0047	1.0513	1.0068	0.9806	0.9936	0.9145	1.0141
ite-ols-wls	1.2181	1.1158	1.0785	1.0515	1.1142	1.0658	1.0292	1.0473	0.9662	1.0726
ite-sar1-ols	1.1380	1.0584	1.0295	1.0125	1.0585	1.0133	0.9892	1.0012	0.9231	1.0216
ite-sar1-shr	1.1056	1.0762	1.0646	1.0552	1.0752	0.9954	1.028	1.0116	0.9457	1.0375
ite-sar1-struc	0.9751	0.9819	0.9781	0.9784	0.9784	0.9038	0.9459	0.9246	0.8563	0.9445
ite-sar1-wls	1.0903	1.0581	1.0441	1.0353	1.0567	0.9773	1.0037	0.9904	0.9159	1.0164
ite-shr-ols	0.9812	0.9858	0.9827	0.9829	0.9831	0.9078	0.9504	0.9289	0.8619	0.9493
ite-shr-shr	1.1318	1.100	1.0848	1.0654	1.0952	1.0153	1.0407	1.0279	0.9594	1.0554
ite-shr-struc	0.9790	0.9827	0.9888	0.9877	0.9845	0.8994	0.9530	0.9258	0.8561	0.9483
ite-shr-wls	1.1133	1.0787	1.0626	1.0464	1.0749	0.9945	1.0155	1.0049	0.9258	1.0322
ite-strar1-ols	0.9758	0.9839	0.9915	0.9909	0.9855	0.8981	0.9570	0.9271	0.8598	0.9498
ite-strar1-shr	1.1586	1.0932	1.0705	1.0546	1.0935	1.0256	1.0300	1.0278	0.9584	1.0543
ite-strar1-struc	1.0539	1.0114	0.9971	0.9886	1.0125	0.9492	0.9596	0.9544	0.8819	0.9761
ite-strar1-wls	1.1406	1.0752	1.0505	1.0347	1.0745	1.0067	1.0062	1.0064	0.9299	1.0330
ite-struc-ols	1.0620	1.0175	1.0027	0.9949	1.0190	0.9560	0.9665	0.9612	0.8899	0.9829
ite-struc-shr	1.1579	1.0929	1.0707	1.0542	1.0932	1.0252	1.0299	1.0275	0.9583	1.0540
ite-struc-wls	1.0539	1.0110	0.9967	0.9884	1.0122	0.9489	0.9593	0.9541	0.8816	0.9758
ite-struc-struc	1.1402	1.0753	1.0504	1.0343	1.0743	1.0062	1.0062	1.0062	0.9300	1.0329
ite-struc-wls	1.0622	1.0173	1.0025	0.9947	1.0189	0.9558	0.9663	0.9611	0.8898	0.9828
ite-wlsh-ols	1.1053	1.0777	1.0677	1.0568	1.0767	0.9932	1.0292	1.0111	0.9456	1.0381
ite-wlsh-shr	0.9703	0.9820	0.9851	0.9808	0.9795	0.8999	0.9488	0.9240	0.8573	0.9452
ite-wlsh-struc	1.0903	1.0585	1.0477	1.0371	1.0582	0.9757	1.0047	0.9901	0.9162	1.0171
ite-wlsh-wls	0.9749	0.9856	0.9890	0.9854	0.9837	0.9033	0.9536	0.9281	0.8631	0.9496
ite-wlsv-ols	1.1052	1.0752	1.0644	1.0549	1.0748	0.9943	1.0278	1.0109	0.9453	1.0369
ite-wlsv-shr	0.9750	0.9815	0.9783	0.9784	0.9783	0.9035	0.9459	0.9245	0.8562	0.9444
ite-wlsv-struc	1.0901	1.0576	1.0442	1.0351	1.0566	0.9770	1.0037	0.9902	0.9160	1.0162
ite-wlsv-wls	0.9813	0.9858	0.9829	0.9830	0.9832	0.9078	0.9506	0.9289	0.8620	0.9494

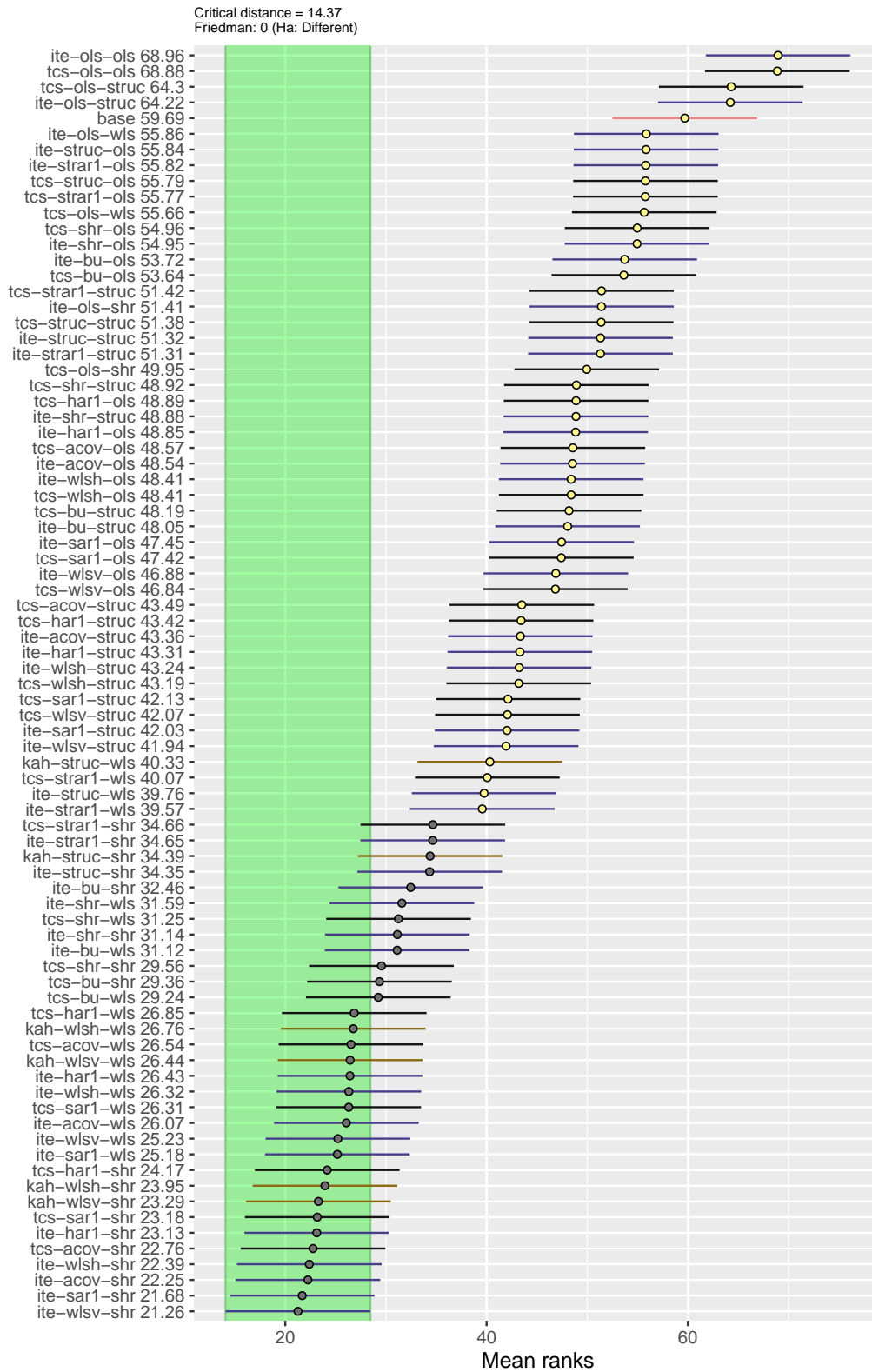

Figure A.22: Nemenyi test results at 5% significance level for all 95 series. The reconciliation procedures are sorted vertically according to the MSE mean rank across all time frequencies and forecast horizons.

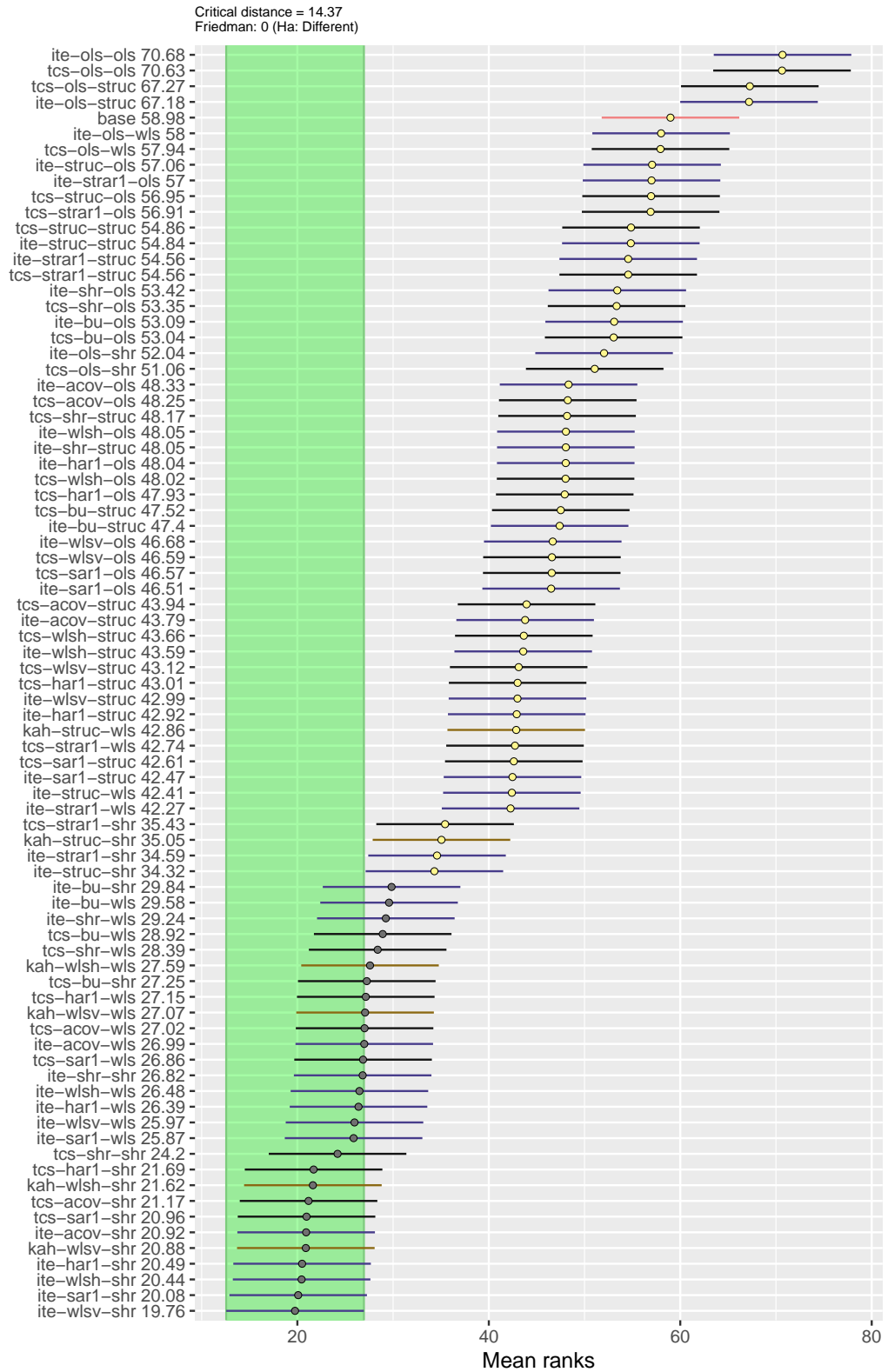

Figure A.23: Nemenyi test results at 5% significance level for all 95 series. The reconciliation procedures are sorted vertically according to the MAE mean rank across all time frequencies and forecast horizons

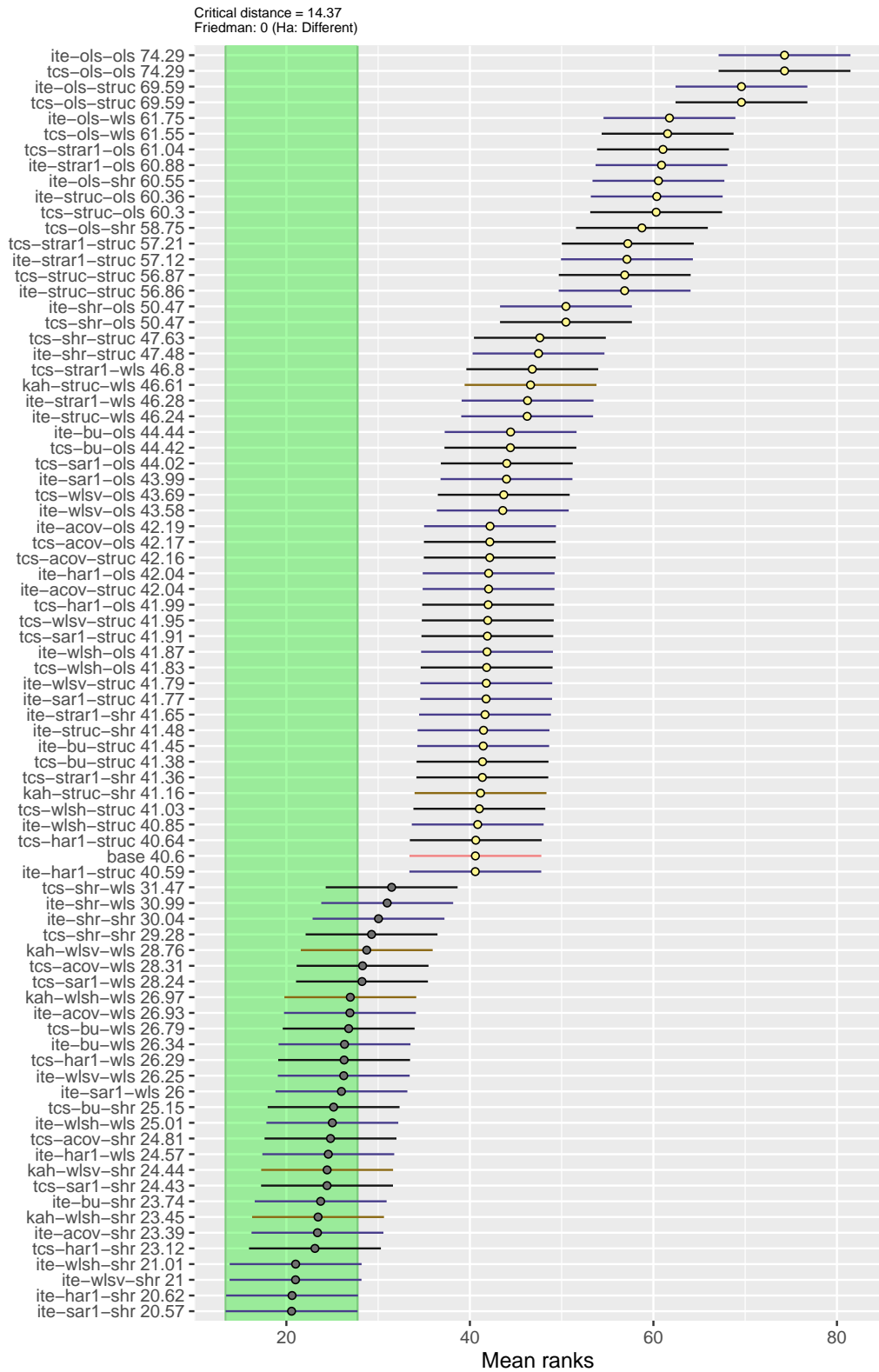

Figure A.24: Nemenyi test results at 5% significance level for all 95 series. The reconciliation procedures are sorted vertically according to the MSE mean rank for the one-step ahead quarterly forecasts.

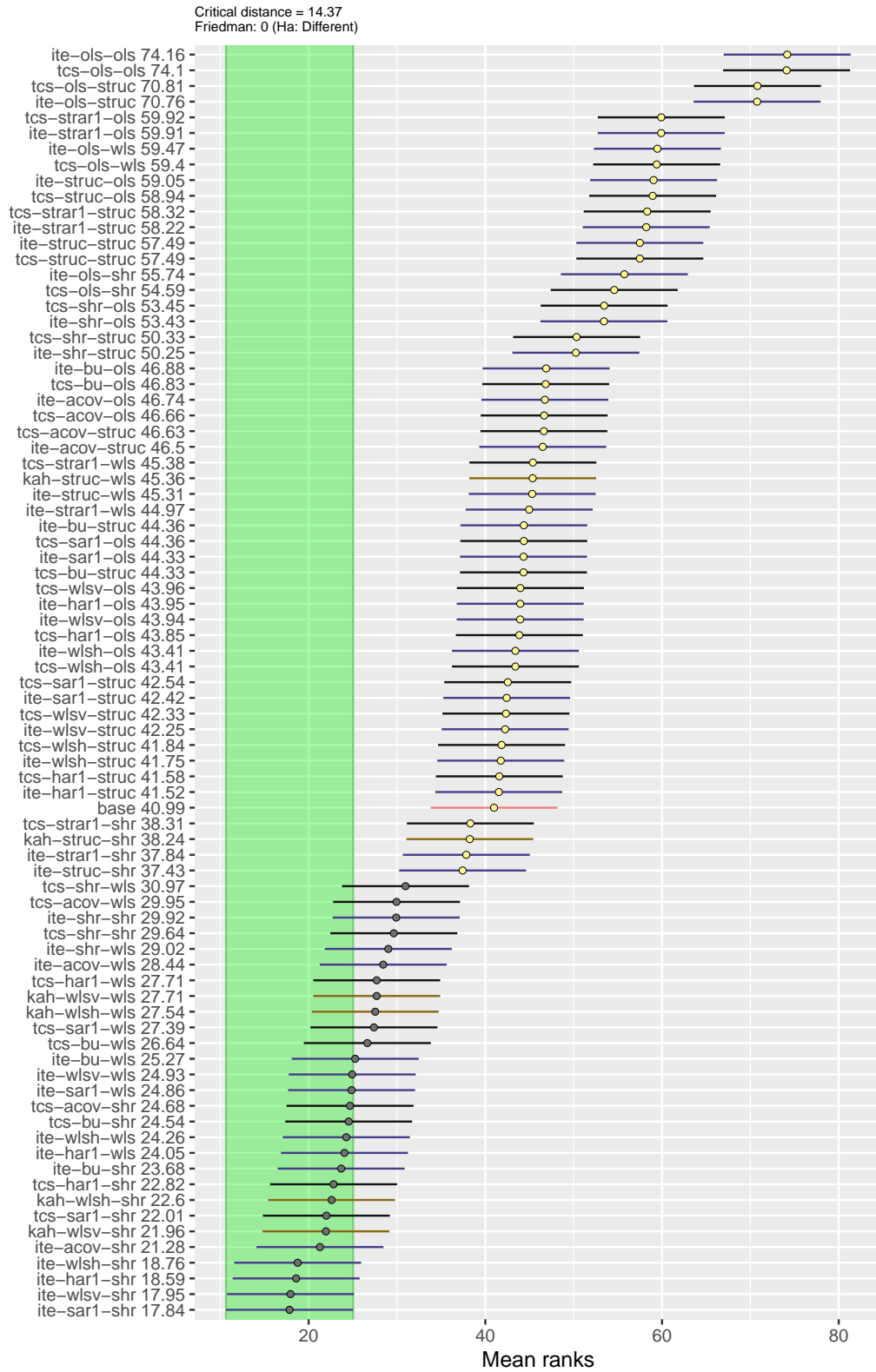
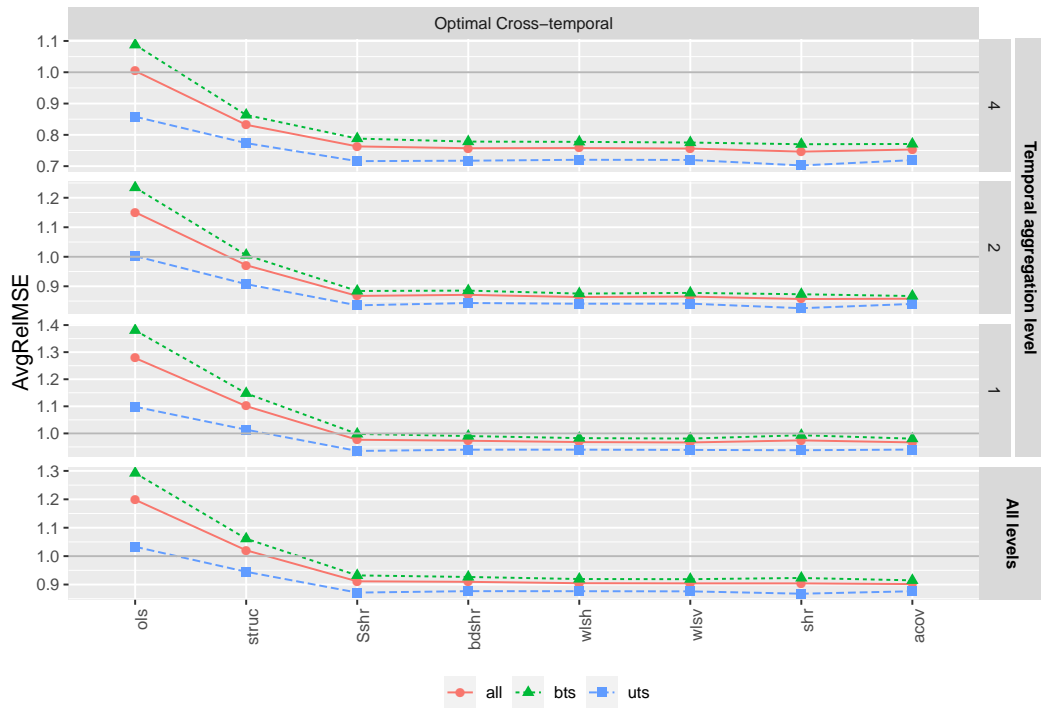

Figure A.25: Nemenyi test results at 5% significance level for all 95 series. The reconciliation procedures are sorted vertically according to the MAE mean rank for the one-step ahead quarterly forecasts.

A.8.4 Optimal combination forecast cross-temporal reconciliation procedures



	all				bts				uts			
	all	1	2	4	all	1	2	4	all	1	2	4
oct acov -	1	2	2	2	1	1	1	2	4	6	3	4
oct shr -	2	5	1	1	4	5	2	1	1	2	1	1
oct wlsv -	3	1	4	3	2	2	4	3	3	3	5	5
oct wls -	4	3	3	5	3	3	3	4	5	5	4	6
oct bdshr -	5	4	6	4	5	4	6	5	6	4	6	3
oct Sshr -	6	6	5	6	6	6	5	6	2	1	2	2
base -	7	7	8	8	7	7	7	8	8	7	8	9
oct struc -	8	8	7	7	8	8	8	7	7	8	7	7
oct ols -	9	9	9	9	9	9	9	9	9	9	9	8

Figure A.26: Top panel: Average Relative MSE across all series and forecast horizons, by frequency of observation. Bottom panel: Rankings by frequency of observation and forecast horizon.

Table A.16: AvgRelMSE at any temporal aggregation level and any forecast horizon.

Procedure	Quarterly					Semi-annual			Annual	All
	1	2	3	4	1-4	1	2	1-2	1	
<i>all 95 series</i>										
base	1	1	1	1	1	1	1	1	1	1
oct-ols	1.5246	1.2871	1.1918	1.1415	1.2782	1.1855	1.1172	1.1508	1.0041	1.1984
oct-struc	1.2511	1.1084	1.0430	1.0154	1.1008	0.9746	0.9682	0.9714	0.8322	1.0206
oct-wlsh	0.9548	0.9718	0.9760	0.9696	0.9680	0.8112	0.9194	0.8636	0.7579	0.9048
oct-wlsv	0.9692	0.9719	0.9622	0.9631	0.9666	0.8203	0.9125	0.8652	0.7562	0.9042
oct-bdshr	0.9838	0.9798	0.9618	0.9665	0.9730	0.8297	0.9144	0.8710	0.7573	0.9095
oct-acov	0.9553	0.9648	0.9767	0.9707	0.9668	0.8013	0.9185	0.8579	0.7531	0.9016
oct-shr	0.9652	0.9610	0.9875	0.9835	0.9742	0.7971	0.9211	0.8569	0.7465	0.9041
oct-Sshr	0.9547	0.9720	0.9913	0.9884	0.9765	0.8054	0.9343	0.8674	0.7631	0.9113
<i>32 upper series</i>										
base	1	1	1	1	1	1	1	1	1	1
oct-ols	1.2156	1.1122	1.0452	1.0300	1.0984	1.0087	0.9962	1.0024	0.858	1.0330
oct-struc	1.0667	1.0341	0.9814	0.9756	1.0138	0.8898	0.9252	0.9073	0.7737	0.9449
oct-wlsh	0.9387	0.9510	0.9339	0.9360	0.9399	0.7999	0.8842	0.8410	0.7204	0.8766
oct-wlsv	0.9411	0.9506	0.9316	0.9326	0.9390	0.8032	0.8811	0.8412	0.7198	0.8760
oct-bdshr	0.9453	0.9559	0.9246	0.9340	0.9399	0.8091	0.8791	0.8433	0.7174	0.8767
oct-acov	0.9388	0.9498	0.9353	0.9371	0.9402	0.7984	0.8844	0.8403	0.7193	0.8763
oct-shr	0.9309	0.9237	0.9438	0.9532	0.9379	0.7691	0.8867	0.8258	0.7023	0.8678
oct-Sshr	0.9291	0.9381	0.9339	0.9398	0.9352	0.7892	0.8846	0.8355	0.7160	0.8717
<i>63 bottom series</i>										
base	1	1	1	1	1	1	1	1	1	1
oct-ols	1.7104	1.3863	1.2740	1.2026	1.3806	1.2869	1.1842	1.2345	1.0876	1.2924
oct-struc	1.3567	1.1481	1.0757	1.0362	1.1479	1.0208	0.9908	1.0057	0.8636	1.0613
oct-wlsh	0.9631	0.9825	0.9981	0.9871	0.9826	0.8170	0.9378	0.8753	0.7776	0.9194
oct-wlsv	0.9837	0.9828	0.9782	0.9789	0.9809	0.8292	0.9288	0.8776	0.7754	0.9188
oct-bdshr	1.004	0.9922	0.9813	0.9835	0.9902	0.8404	0.9329	0.8854	0.7784	0.9267
oct-acov	0.9639	0.9725	0.9984	0.9881	0.9806	0.8028	0.9363	0.8670	0.7709	0.9147
oct-shr	0.9830	0.9805	1.0105	0.9992	0.9932	0.8117	0.9391	0.8731	0.7700	0.9231
oct-Sshr	0.9680	0.9897	1.0218	1.0140	0.9982	0.8138	0.9606	0.8841	0.7881	0.9322

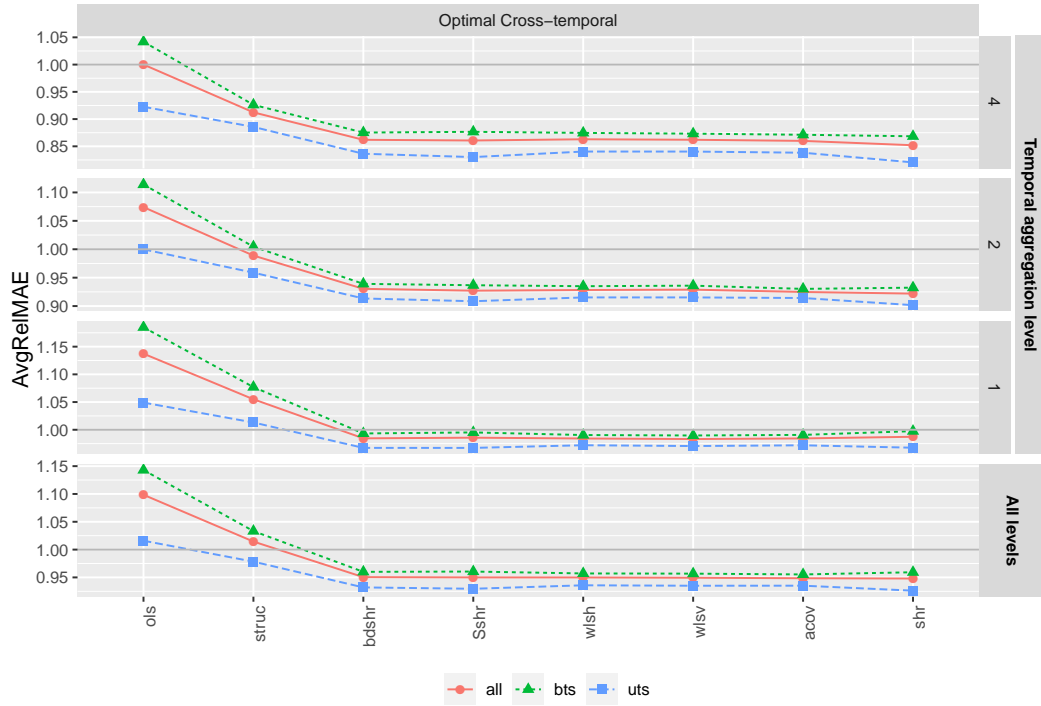

	all				bts				uts			
	all	1	2	4	all	1	2	4	all	1	2	4
oct shr	1	6	1	1	4	6	2	1	1	3	1	1
oct acov	2	3	2	2	1	3	1	2	5	5	4	4
oct wlvh	3	1	5	5	2	1	4	3	4	4	5	5
oct wlvh	4	2	4	6	3	2	3	4	6	6	6	6
oct Sshr	5	5	3	3	6	5	5	6	2	1	2	2
oct bdshr	6	4	6	4	5	4	6	5	3	2	3	3
base	7	7	8	8	7	7	7	8	8	7	9	9
oct struc	8	8	7	7	8	8	8	7	7	8	7	7
oct ols	9	9	9	9	9	9	9	9	9	9	8	8

Figure A.27: Top panel: Average Relative MAE across all series and forecast horizons, by frequency of observation. Bottom panel: Rankings by frequency of observation and forecast horizon.

Table A.17: AvgRelMAE at any temporal aggregation level and any forecast horizon.

Procedure	Quarterly					Semi-annual			Annual	All
	1	2	3	4	1-4	1	2	1-2	1	
<i>all 95 series</i>										
base	1	1	1	1	1	1	1	1	1	1
oct-ols	1.2422	1.1377	1.1027	1.0736	1.1373	1.0921	1.0565	1.0741	1.0001	1.0985
oct-struct	1.1219	1.0563	1.0298	1.0153	1.0551	0.9908	0.9870	0.9889	0.9123	1.0144
oct-wlsh	0.9745	0.9863	0.9895	0.9867	0.9842	0.9028	0.9545	0.9283	0.8630	0.9499
oct-wlsv	0.9813	0.9858	0.9829	0.9830	0.9832	0.9078	0.9506	0.9289	0.8620	0.9494
oct-bdshr	0.9858	0.9880	0.9809	0.9833	0.9845	0.9112	0.9499	0.9304	0.8620	0.9505
oct-acov	0.9762	0.9831	0.9904	0.9879	0.9844	0.8965	0.9541	0.9248	0.8600	0.9485
oct-shr	0.9825	0.9804	0.9944	0.9920	0.9873	0.8939	0.9509	0.9219	0.8520	0.9480
oct-Sshr	0.9739	0.9832	0.9922	0.9936	0.9857	0.8962	0.9591	0.9271	0.8607	0.9500
<i>32 upper series</i>										
base	1	1	1	1	1	1	1	1	1	1
oct-ols	1.0857	1.0534	1.0331	1.0249	1.0491	1.0027	0.9971	0.9999	0.9226	1.0159
oct-struct	1.0173	1.0227	1.0058	1.0069	1.0131	0.9467	0.9712	0.9589	0.8857	0.9784
oct-wlsh	0.9604	0.9780	0.9727	0.9773	0.9721	0.8948	0.9362	0.9152	0.8404	0.9358
oct-wlsv	0.9589	0.9773	0.9712	0.9752	0.9706	0.8969	0.9339	0.9152	0.8404	0.9350
oct-bdshr	0.9552	0.9790	0.9632	0.9719	0.9673	0.8983	0.9288	0.9134	0.8364	0.9320
oct-acov	0.9631	0.9756	0.9729	0.9764	0.9720	0.8933	0.9356	0.9142	0.8383	0.9351
oct-shr	0.9591	0.9594	0.9700	0.9820	0.9676	0.8746	0.9295	0.9016	0.8205	0.9262
oct-Sshr	0.9587	0.9675	0.9660	0.9769	0.9673	0.885	0.9327	0.9085	0.8303	0.9296
<i>63 bottom series</i>										
base	1	1	1	1	1	1	1	1	1	1
oct-ols	1.3301	1.1831	1.1399	1.0992	1.1850	1.1405	1.088	1.1139	1.0419	1.1430
oct-struct	1.1791	1.0737	1.0422	1.0196	1.0770	1.0140	0.9951	1.0045	0.9262	1.0333
oct-wlsh	0.9818	0.9906	0.9981	0.9916	0.9905	0.9069	0.9639	0.9350	0.8746	0.9571
oct-wlsv	0.9929	0.9901	0.9888	0.9870	0.9897	0.9133	0.9591	0.9360	0.8732	0.9568
oct-bdshr	1.0018	0.9925	0.9900	0.9892	0.9933	0.9178	0.9609	0.9391	0.8753	0.9600
oct-acov	0.9830	0.9869	0.9994	0.9937	0.9907	0.8981	0.9636	0.9303	0.8712	0.9554
oct-shr	0.9946	0.9913	1.0070	0.9972	0.9975	0.9038	0.9619	0.9324	0.8684	0.9593
oct-Sshr	0.9818	0.9912	1.0059	1.0021	0.9952	0.9019	0.9728	0.9367	0.8766	0.9606

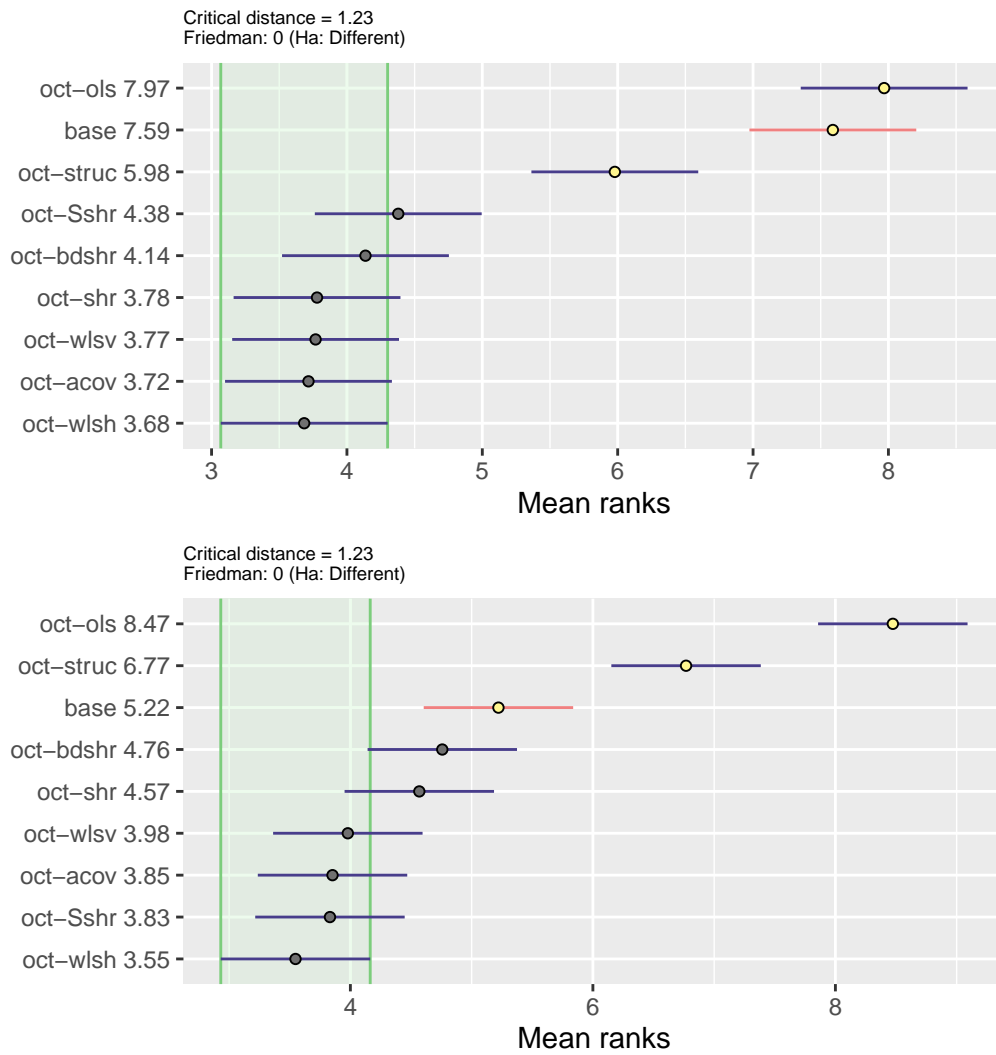

Figure A.28: Nemenyi test results at 5% significance level for all 95 series. The optimal combination reconciliation procedures are sorted vertically according to the MSE mean rank (i) across all time frequencies and forecast horizons (top), and (ii) for 1-step-ahead quarterly forecasts (bottom).

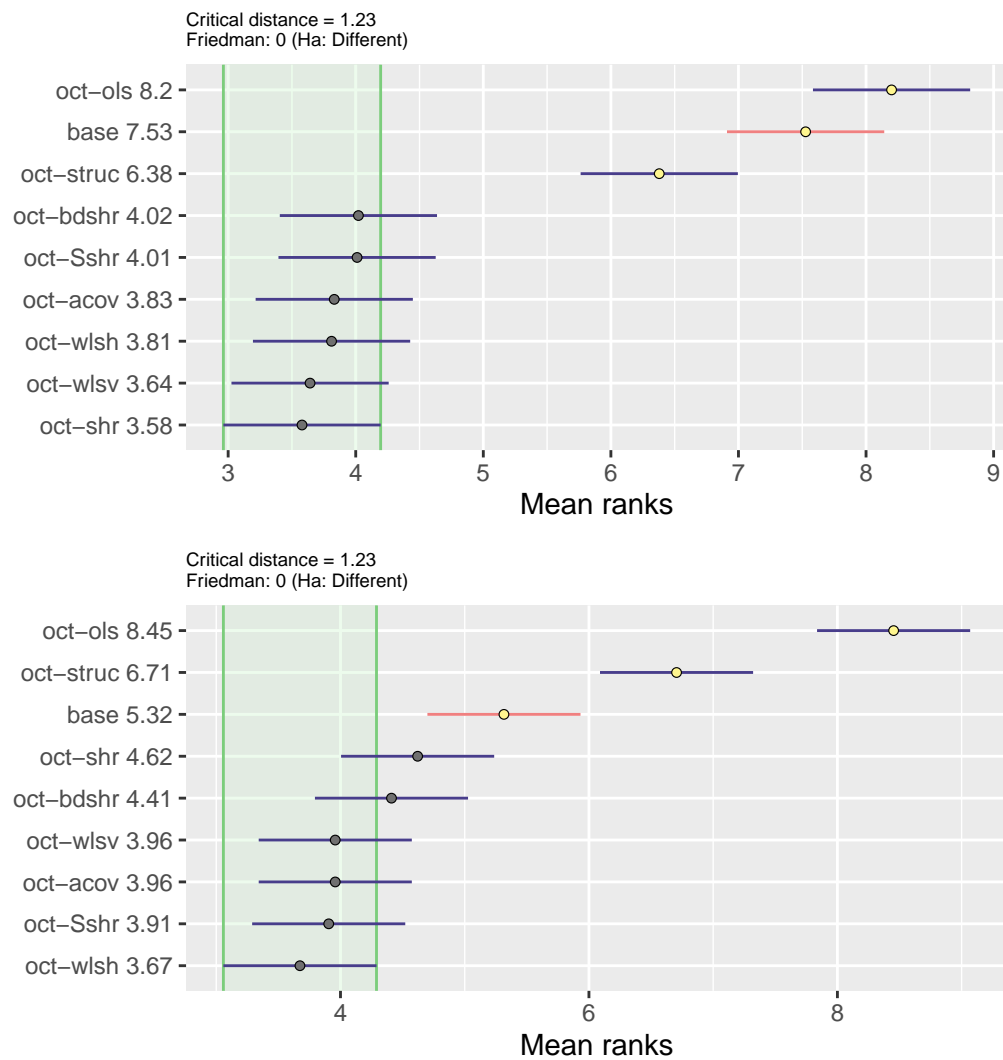

Figure A.29: Nemenyi test results at 5% significance level for all 95 series. The optimal combination reconciliation procedures are sorted vertically according to the MAE mean rank across (i) all time frequencies and forecast horizons (top), and (ii) for 1-step-ahead quarterly forecasts (bottom).

Working Paper Series
Department of Statistical Sciences, University of Padua

You may order paper copies of the working papers by emailing wp@stat.unipd.it

Most of the working papers can also be found at the following url: <http://wp.stat.unipd.it>

