

# Estimating the cutting force when skiving with a radius cutter

A V Filippov<sup>1,2</sup> and E O Filippova<sup>1</sup>

<sup>1</sup> Tomsk polytechnic university, Tomsk, Lenina av. 30, Russia

<sup>2</sup> Institute of strenght physics and materials sciences SB RAS, Tomsk, per. Academicheskii 2/4, Russia

E-mail: andrey.v.filippov@yandex.ru

**Abstract.** The paper considers the method of determining the components of the cutting force under cutting completed with a radius cutter. The authors provide the design of the experimental study. The authors provide the data on the cutting force change in the process of turning with a radius cutter according to the cutting edge inclination, cutting depth and supply obtained experimentally and calculated analytically. The paper also provides the results of experimental work approximation and theoretical error checking related to experimental data.

## 1. Introduction

Theoretical estimation of cutting force components is an important problem for the study and analysis of machining process. The complexity of finding the theoretical values is determined by the wide ranges of initial parameters (tool geometry, cutting conditions, properties of the machined and tool material) which have various influence upon the force dependences in terms of character and value.

One of the promising methods of machining is cutting with radius cutters. Such tools are known [1-3] to ensure high productivity of machining and high quality of the surface of machined item. At the same time the problem of tool geometry and setting influence upon the force parameters remains understudied. Radius cutters are traditionally applied as rotary cutting tool with driven cutter or as auto rotary tool which rotation is caused by friction [3].

In his work [3] V.F. Bobrov notes that cutting with auto rotary cup-tip (radius) tools is often accompanied by vibrations due to the bearing clearance which allows rotation of the tool cutting part. That is why it is more preferable to consider the case of machining with non-rotary cutters which have more rigid construction and are less liable to vibrations.

Force dependences are an important parameter of machining as they determine the possibility of achieving the required accuracy of nonrigid axles. Currently the theoretical analysis of machining accuracy based on estimation of elastic displacement of the workpiece influenced by the cutting force is regarded as generally accepted. In the works of V.V. Podporkin [4], A.A. Matalin [5], V.S. Korsakov [6] the thrust force  $P_y$  is considered as the force which determines this displacement. K.S. Kolev [7], in his turn, to analyze the accuracy of machining suggests considering the bending force of cutting which is equivalent from radial ( $P_y$ ) and tangential ( $P_z$ ) components. In general the formula for estimating the value of elastic displacement of the workpiece is as follows:

$$y = \frac{P \cdot L^3}{k \cdot E \cdot J}, \quad (1)$$

<sup>1</sup> Corresponding author: A V Filippov - [andrey.v.filippov@yandex.ru](mailto:andrey.v.filippov@yandex.ru).



where  $k$  – coefficient taking into consideration the method of workpiece setting,

$P$  – the force effecting the workpiece,

$E$  – elastic modulus of the workpiece material,

$J$  – second moment of area of the workpiece,

$L$  – the distance from the fixed part of the workpiece to the place of bending force application.

During the process of cutting dynamic change of the cutting force occurs due to the nonuniformity of properties of the workpiece material, variations of tolerance and other dynamically changing processes. Despite all these, equation (1), taking only the static displacement of the workpiece allows estimating the possible accuracy of machining under the known value of the cutting force.

Relevance of the given work is in the lack of data on the impact of supply, cutting depth and cutting edge inclination upon the force dependences under turning with radius cutters with the blade which does not overtravel. Besides, the known works do not provide data for the theoretical estimation of the force components.

## 2. Results and discussions

Figure 1 presents the scheme of oblique turning with radius cutter. The cutting edge of the tool cut off a layer of material which is formed by three intervals:  $AB$  – the working area of the cutting edge,  $AC$  – belongs to the cut surface,  $CB$  – belongs to the machined surface. The working area of the cutting edge is placed below the axis of rotation of the workpiece which makes a considerable difference from the traditional method of machining with single point tools. As a result the cutting conditions and the geometry of the tool undergo a considerable change. The method of estimation of cut off layer cross-section parameters and operating length of the cutting edge is described in work [8].

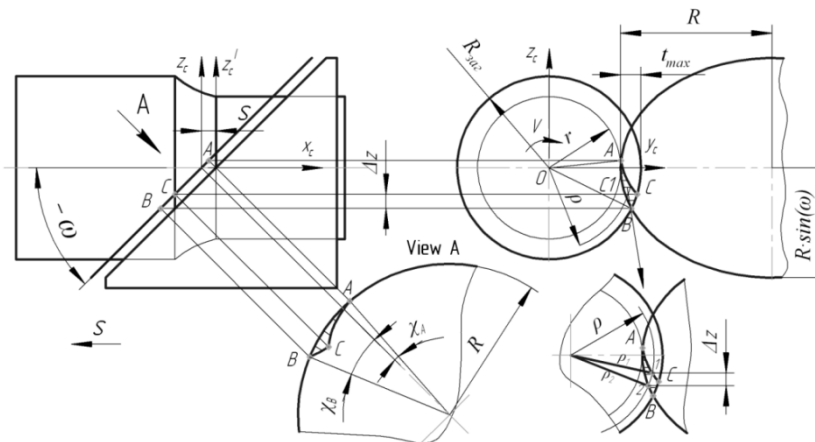
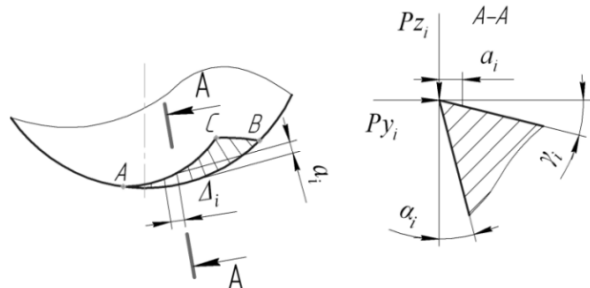

**Figure 1.** The scheme of oblique turning with radius cutter [8]

In the theory of cutting the components of the cutting force are found through correction factors taking various variables into consideration: work conditions, cutting conditions, workpiece and tool material [4]. Such factors are chosen on the base of experimental results and are attributed to some value of the considered parameter (for example, to the material of the tool cutting part). At the same time these factors cannot be attributed to the whole range of the studied parameters alteration.

In relation to the above-mentioned the given work suggests applying the approach based on summing up the specific components of the cutting force for estimation of the cutting force components. The essence of the approach can be described as follows: the cross-section of the cut off layer considered as projection on the front surface of the tool is divided into surface elements with an equal interval  $\Delta z$  and the thickness value  $a_i$  of the cut layer is estimated for the given surface element (see Figure 2). Thickness, according to the common approach is determined normally in the considered point of the cutting edge. For the singled out element of the cutting edge the scheme of free cutting is accepted when the cutting edge is effected only by two components of the cutting force  $Pz_i$

and  $P_{y_i}$ . Then it is enough to study the impact of tool geometry and thickness of the cut layer upon the specific force dependences under free cutting than complete the studies for all possible combinations of the impact of considered machining parameters.



**Figure 2.** The scheme of the way specific components of the cutting force impact the cutting edge of the radius cutter

According to the chosen approach we completed experimental study of the impact the front and the clearance angles of the tool under various width of the cut layer have upon the specific components of the cutting force  $P_z$  and  $P_y$ . During the experiment the front angle was varied within  $(-45...35)^\circ$ , the clearance angle – within  $(2...40)^\circ$  and the thickness of the cut layer altered from 0,035mm to 0,115mm. These ranges were obtained by means of analysis of the tool cutting edge geometry parameters and of the cut layer cross-section parameters typical for turning with radius cutters [8-11]. After the experiments the obtained dependences were approximated with division into the positive and the negative ranges of front angle change. Such division into ranges was completed to achieve better accuracy and reliability of results approximation.

Below we present formulas for calculating the specific components of the cutting force  $P_{z_i}$  and  $P_{y_i}$  depending upon the thickness of the cut layer and front and clearance angles of the tool.

To estimate the specific force  $P_{z_i}$ :

a) within the positive range  $\gamma$ :

$$P_{z_i} = k(\gamma) \cdot a \cdot k(\alpha), \quad (2)$$

where  $k(\gamma)$  – coefficient of the front angle impact:

$$k(\gamma) = 2315.6 - 18.02 \cdot \gamma;$$

$k(\alpha)$  – coefficient of the clearance angle impact:

$$k(\alpha) = 0.0001 \cdot \alpha^2 - 0.0079 \cdot \alpha + 1.0512;$$

$a$  – thickness of the cut layer.

b) within the negative range  $\gamma$ :

$$P_{z_i} = k(\gamma) \cdot a \cdot k(\alpha), \quad (3)$$

where  $k(\gamma)$  – coefficient of the front angle impact:

$$k(\gamma) = 24.101 \cdot \gamma + 2081.8;$$

$k(\alpha)$  – coefficient of the clearance angle impact:

$$k(\alpha) = 0.0003 \cdot \alpha^2 - 0.0153 \cdot \alpha + 1.1028;$$

$a$  – thickness of the cut layer.

For estimation the specific force  $P_{y_i}$ :

a) within the positive range  $\gamma$ :

$$P_{y_i} = (-A \cdot a^2 + B \cdot a) \cdot k(\alpha) \cdot k(\lambda), \quad (4)$$

where  $A$  and  $B$  – coefficients of the front angle impact:

$$A = 1.6608 \cdot \gamma^2 + 0.3345 \cdot \gamma + 3759.1;$$

$$B = 0.093 \cdot \gamma^2 - 21.904 \cdot \gamma + 1769.2;$$

$k(\alpha)$  – coefficient of the clearance angle impact:

$$k(\alpha) = 1.196 - 0.0142 \cdot \alpha;$$

$k(\lambda)$  – coefficient of cutting edge inclination impact:

$$k(\lambda) = -0.0005 \cdot \lambda^2 + 0.037 \cdot \lambda + 0.7577 \text{ within the positive range of angle alteration } \lambda - (30 \dots 60)^\circ;$$

$$k(\lambda) = 0.0375 \cdot \lambda + 2.9772 \text{ within the negative range of angle alteration } \lambda - (-30 \dots -60)^\circ;$$

$a$  – thickness of the cut layer.

b) within the negative range  $\gamma$ :

$$P_{y_i} = A \cdot a^B \cdot k(\alpha) \cdot k(\lambda). \quad (5)$$

where  $A$  and  $B$  – coefficients of the front angle impact:

$$A = -0.0022 \cdot \gamma^4 - 0.085 \cdot \gamma^3 + 15.05 \cdot \gamma^2 - 103.23 \cdot \gamma + 835;$$

$$B = 8E - 07 \cdot \gamma^4 - 1E - 04 \cdot \gamma^3 + 0.0033 \cdot \gamma^2 - 0.0109 \cdot \gamma + 0.7222;$$

$k(\alpha)$  – coefficient of the clearance angle impact:

$$k(\alpha) = 1.126 - 0.0196 \cdot \alpha;$$

$k(\lambda)$  – coefficient of the cutting edge inclination impact:

$$k(\lambda) = -0.0005 \cdot \lambda^2 + 0.037 \cdot \lambda + 0.7577 \text{ within the positive range of angle change } \lambda - (30 \dots 60)^\circ;$$

$$k(\lambda) = 0.0375 \cdot \lambda + 2.9772 \text{ within the negative range of angle change } \lambda - (-30 \dots -60)^\circ;$$

$a$  – thickness of the cut layer.

To test the obtained calculating formulas (2-5) we completed the experimental study of the impact produced by supply, cutting depth, cutting edge radius and cutting edge inclination upon the cutting force components  $P_z$  и  $P_y$ . Figure 3 shows the skiving radius cutter developed for the experimental study. The suggested design allows changing the cutting edge inclination and applying replaceable indexable inserts.

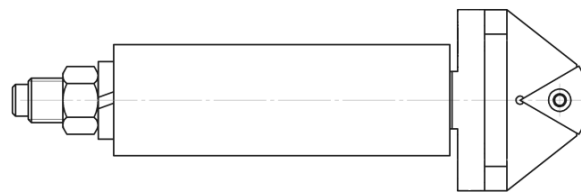

**Figure 3** Skiving radius cutter

Figure 4 shows the design of the experimental device. For the experimental study we used axles 38mm in diameter from 45 steel which were previously turned to obtain the necessary diameter. The cutting speed for all the experiments was 100 m/min.

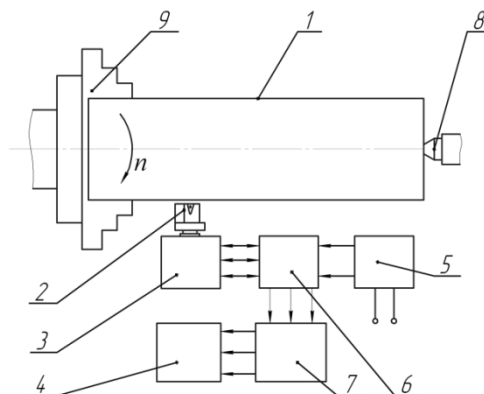

**Figure 4** The experimental device for measuring the cutting force components:

1 – workpiece, 2 – radius cutter, 3 – turning dynamometer, 4 – personal computer, 5 – direct-current power supply, 6 – strain-gauge station, 7 – ADC (analog-digital converter) USB 3000, 8 – turning center, 9 – lathe chuck

Figures 5-7 present dependences of the cutting force components  $P_z$  and  $P_y$  upon the cutting edge inclination, supply and cutting depth estimated (the dashed line) according to the formulas (2-5) with insertion of corresponding coefficients and found experimentally (continuous line).

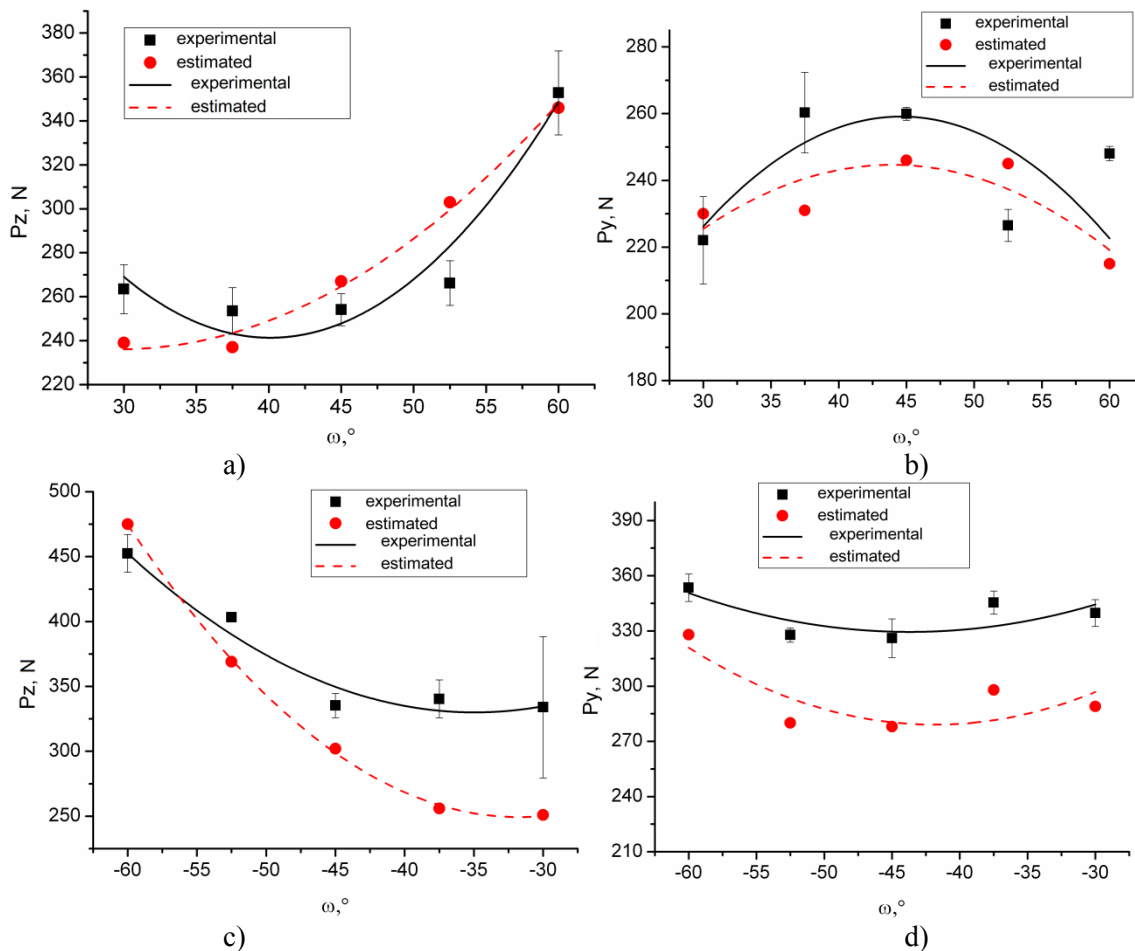

**Figure 5.** Dependence of changes of cutting force components  $P_z$  and  $P_y$  upon the cutting edge inclination under cutting according to reverse (a, b) and direct (c, d) schemes

As we can see from the given graphic charts (see Figure 5) the cutting force components  $P_z$  and  $P_y$  change differently. Increase of angle  $\omega$  from 30° to 45° under cutting according to the reverse scheme does not cause significant change of component  $P_z$ . Similar situation is observed under cutting according to direct scheme. Further increase of angle  $\omega$  from 45° to 60° is accompanied by significant growth of component  $P_z$ , both for direct and for reverse schemes. This kind of dependence  $P_z=f(\omega)$  is associated with the peculiarities of changes of cut layer cross-section parameters and parameters of the operating length of the cutting edge [8]. Under the values  $\omega=30^\circ\dots45^\circ$  insignificant increase of cut layer thickness and decrease of operating length of the cutting edge occurs.

Changing of component  $P_y$  due to the front angle change does not demonstrate any unique dependence for designs under consideration.  $P_y$  within the range of angle  $\omega$  changes by 20...40N which is not significant under the given parameters of machining. Thus, change of angle  $\omega$  does not have significant impact upon the value of component  $P_y$ .

The obtained calculation dependences correspond well to the experimental ones. At the same time we observe some disarrangement of their value within the range of angle  $\omega$  from -30° to -45° for the

direct scheme of cutting. This must result from the conditions of the cut layer deformation [12-14] when under small thickness of the cut layer cutting is completed within the radius of the cutting edge with negative values of the front angle.

Changing the scheme of cutting from the direct to the reverse one contributes to the decrease of the values of cutting force components  $P_z$  and  $P_y$ . It is related to the change of the conditions of cutting the layer of material which are expressed in the free passage of the cutting waste along the front surface of the tool under cutting according to reverse scheme and positive range of front angle changing.

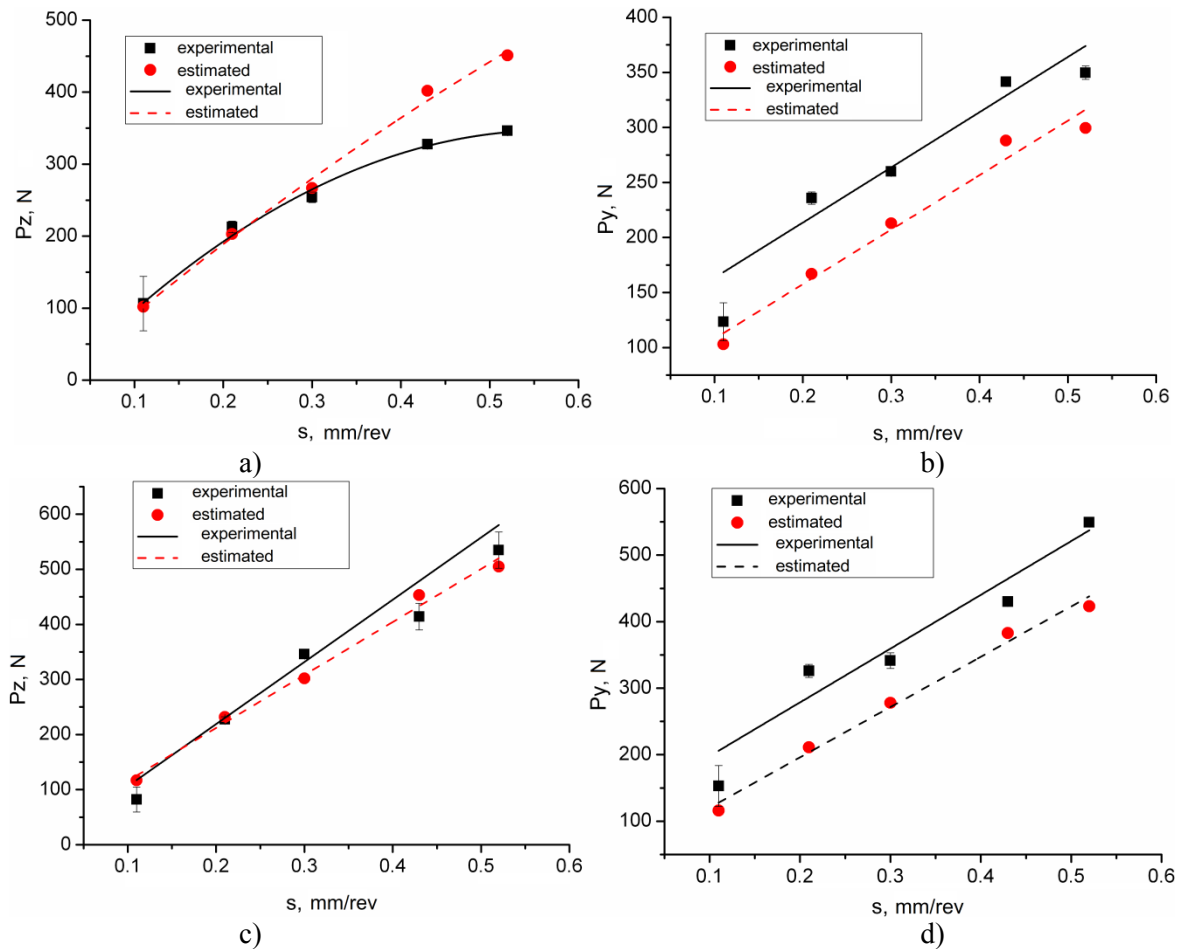

**Figure 6.** Dependence of the change of cutting force components  $P_z$  and  $P_y$  upon the supply under cutting according to the reverse (a, b) and the direct (c, d) schemes

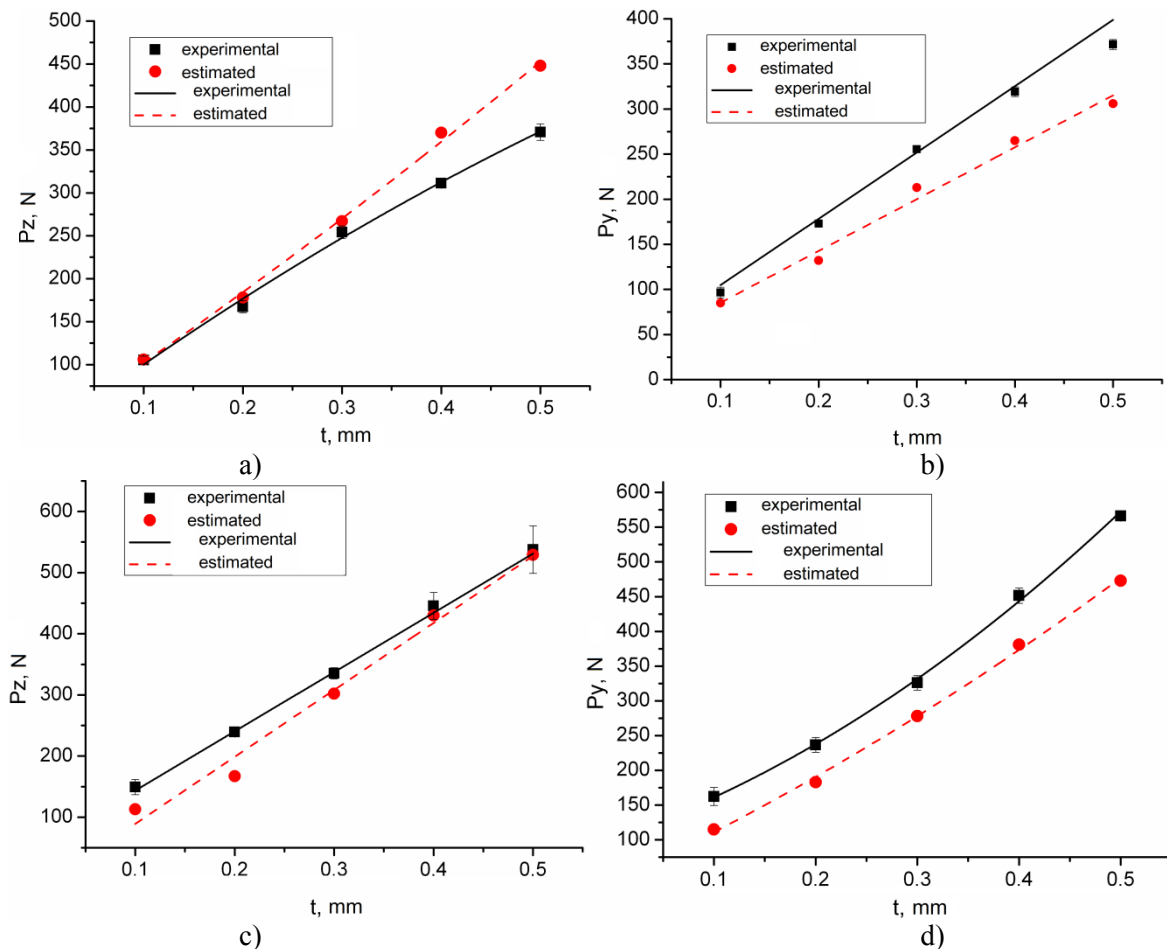

**Figure 7.** Dependence of the change of cutting force components  $P_z$  and  $P_y$  upon the cutting depth under cutting according to the reverse (a, b) and the direct (c, d) schemes

According to the obtained graphic charts (see Figures 6 and 7) increase of supply and cutting depth leads to almost linear increase of cutting force components  $P_z$  and  $P_y$ . It is a natural phenomenon as with the increase of supply and cutting depth the thickness of the cut layer and operating length of the cutting edge also grow. Changing the scheme of cutting from the direct into the reverse one leads to the decrease of the values of cutting force components while the obtained dependences upon cutting depth and supply remain constant. The calculated dependences  $P_z=f(s)$ ,  $P_z=f(t)$ ,  $P_y=f(s)$ ,  $P_y=f(t)$  obtained according to formulas (2-5) agree well to the experimental results.

### 3. Conclusion

Comparison of the obtained dependences of cutting force components upon supply, cutting depth and cutting edge inclination allows making an important conclusion. From the point of view of the energy consumption of the process, machining according to the reverse scheme will be more efficient than machining according to the direct one. The given effect is achieved due to the fact that with the five-time increase of the cutting conditions (supply and/or cutting depth) under cutting according to the reverse scheme the value of the cutting force components will be two-time less than when working according to the direct scheme, thus, the machine tool will have to perform less work during the machining process.

To estimate the validity of the method for calculating the cutting forces by the specific components of the cutting force we calculated the amount of average relative error of theoretical values from the experimental ones and obtained the following results:

1. Average relative error of component Pz calculation for the reverse scheme made 10.3% and for the direct one – 14.3% under the correlation ratio about 0.96.

2. Average relative error of component Py for the reverse scheme made 15% and for the direct one – 18.3% under the correlation ratio about 0.95.

3. The high level of correlation between the theoretical and experimental dependences proves the agreement of the obtained dependences at the qualitative level.

So we can consider the application of the presented method appropriate for estimating the cutting force under cutting with radius cutters.

### References

- [1] Bobrov V F 1962 *Influence of the inclination angle of the main cutting edge upon the process of metal cutting* (Moscow: Mashgiz)
- [2] Grzesik W and Żak K 2011 *Archives of Mat. Sci. and Eng.* **52** 46-53
- [3] Bobrov V F 1972 *Metal-cutting with auto rotary cutters* (Moscow: Mashinostroyeniye)
- [4] Podporkin V V 1959 *Machining of nonrigid parts* (Moscow: Mashgiz)
- [5] Matalin A A 1977 *Accuracy of machining* (Leningrad: Mashinostroyeniye)
- [6] Korsakov V S 1961 *Accuracy of machining* (Moscow: Mashgiz)
- [7] Kolev K S 1976 *Accuracy of machining and cutting conditions* (Moscow: Mashinostroyeniye)
- [8] Filippov A V 2014 *Russ. Eng. Res.* **35** 385-388
- [9] Petrushin S I and Filippov A V 2013 *Machining of met. Tech. Equip. Tools.* **2** 8-14
- [10] Filippov A V 2013 *Appl. Mech. and Mat.* **379** 139-144
- [11] Filippov A V 2014 *Russ. Eng. Res.* **34** 718-721
- [12] Filippov A V 2014 Bull. of MSTU N.E. Bauman. Ser. "Mashinostroyeniye" **2** 100-113
- [13] Fillipov A V, Proskokov A V and Verbitskaya O Yu 2013 *Nauchnoye obozreniye* **5** 53-56
- [14] Filippov A V and Gorbatenko V V 2014 *Appl. Mech. and Mat.* **682** 525-529