

UDC 316.455:621.372.852

## FACTOR AND REGRESSION MODELING OF THE VARIABLE STATE DEVICES IN THE SYSTEM STATISTICA

O.V. Stukach

Tomsk Polytechnic University  
E-mail: tomsk@iee.org

For designing the discrete variable state devices the methods of statistical modeling, in particular, the factor and multi-variable regression analysis have been offered to use. It was shown that the statistical methods which were not used earlier for solving the given problem, allow revealing physical laws of the elements operation in the device that promotes creating the structure optimal from the point of view of supporting minimum phase shift at controlling transfer constant. Reveal and substantial interpretation of the factor loadings influencing various researched characteristics allow changing traditional methodology and simplifying significantly optimization of correction and regulation parameters in phase-invariance devices. The computer system Statistica 6.0 was used for modeling in the paper.

The device with variable states (DVS) is the system the response of which depends not only on input action but also on generalized constant in time parameter determining state. Adjustable amplifier or attenuator is the example of the simplest DVS in which transfer constant may be changed discretely or smoothly by some law. DVS is usually studied for linearized models in which transient connected with state parameter change is considered to be completed [1].

In practice when using DVS there is a necessity to achieve minimal dependence of some characteristics on the others. For example, delay control should not be accompanied by a significant change of the form of gain-amplitude characteristic (GAC) in frequency band and GAC control should not cause phase shift change. It is necessary to take into account the demands for phase shift constancy at controlling when designing transmitters with addition of power, modules of active phase arrays, precision wide-band amplifiers, attenuators and other devices [2]. Change of phase shift is stipulated by the influence of stray reactivity of controlled elements. Their technological decrease is connected with significant difficulties. Therefore, in practice schematic compensation of stray reactivity of controlled elements is actively used.

### 1. The problem of DVS computer-aided design

The problem of synthesizing the best circuit solutions for phaseinvariant DVS has no general solution at present. In the given paper the new approach to designing controlled discrete microwave attenuator by the method of statistic modeling of characteristics is examined.

Attenuators performed on the basis of L-, T- and U-shaped connection of series and parallel diodes became the most widespread. Diode resistance may be changed within wide limits under the influence of control current that allows changing GAC and attenuation in the path [2]. Phase shift independence at attenuation control in such attenuators is achieved by reactive circuits included into basic structure. It is obvious that one and the same level of introduced attenuation may be obtained at various ratios of parallel and series diode resistance. But phase shift change is different [3]. Therefore, two nested optimization cycles – for control elements and correcting circuits are provided for designing DVS in programs

of schematic design. Each iteration of correcting circuit parameter changes requires separate optimization procedure for control elements (Fig. 1).

Let us study a capacity of simplifying computer-aided design of attenuators excluding double optimization of correcting circuits and control element parameters.

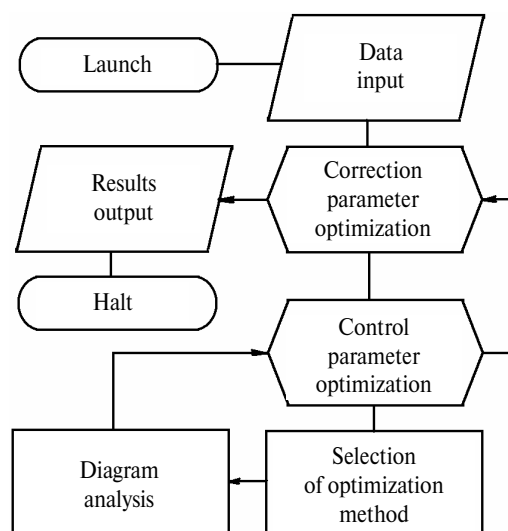

Fig. 1. Diagram of algorithm of optimization of DVS parameters

### 2. Model of DVS and its characteristics

Let us use electrically-operated attenuator the equivalent circuit of which is given in Fig. 2 as an investigated DVS. Minimal level of attenuation is supported in the case of low resistance of the element  $R_s$  and high resistance of the element  $R_p$ . Insertion attenuation raises at increasing element  $R_s$  resistance and decreasing element  $R_p$  resistance.

Transmission lines  $l_1, l_2, l_3$  support response phase invariance relative to input action. The distributed inductance and capacity of lines are combined with stray parameters  $L, C$  of controlled elements, for example, diodes and compensate phase shift change at attenuation adjustment.

Diode equivalent circuit from the article [4] with the following parameters was used for computer simulation: junction capacitance  $C=0,02$  pF, lead inductance

$L=0,16$  nHn, spreading resistance was not taken into account due to its trifle. Let us notice that stray reactivity parameters of controlled elements are the main reason limiting an operation frequency band. Volume resistance  $R_s$  and  $R_p$  changed from 3 to 200 Ohm. Resistances of generator and load as well as resistor  $R$  equal to 50 Ohm. As a result of optimization by criterion of phase shift minimum by the program [3] the correction parameters were found – transmission line length  $l$  and their impedance  $\rho$ :  $l_1=3$  mm,  $l_2=1,1$  cm,  $l_3=2$  mm,  $\rho_1=70$  Ohm,  $\rho_2=75$  Ohm,  $\rho_3=40$  Ohm. Insertion attenuation  $A(\omega)$  was computed depending on circular frequency  $\omega$ , that is the value inverse to GAC and change of phase shift  $\Delta\varphi(\omega)$ , that is phase difference at initial ( $A_0$ ) and selected level of attenuation ( $A$ ).

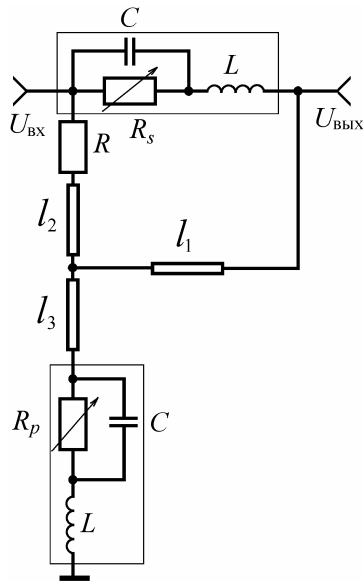

Fig. 2. DVS model

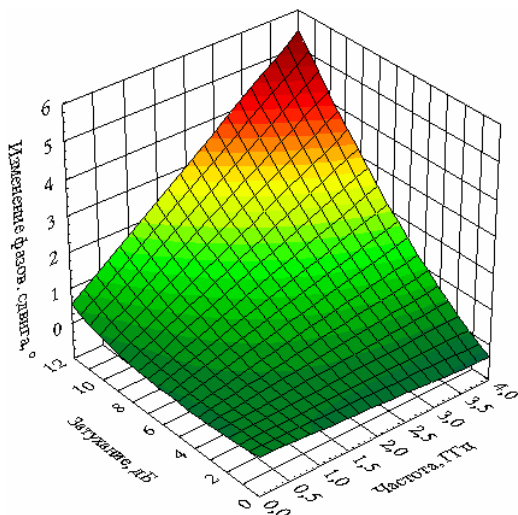

Fig. 3. Phase shift change depending on frequency and attenuation for non compensated attenuator

Dependences of phase shift change on frequency and attenuation for the diagram without and with correction are given in Fig. 3 and 4 respectively. Graphs are

constructed in the system Statistica 6.0 [5]. Change of phase shift not more than  $0,2^\circ$  was achieved in updated attenuator in attenuation range of 1,3...7,7 dB and frequency band of 0,01...4,0 GHz. In attenuator without correction phase shift change in the same frequency band and attenuation range achieves  $3^\circ$ . Thus, phase shift is decreased due to almost 15 times compensation.

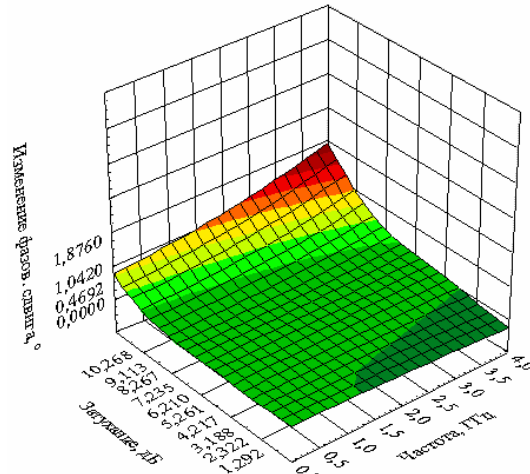

Fig. 4. Change of phase shift depending on frequency and attenuation for updated attenuator

### 3. DVS statistic simulation

Let us consider parameters of correction and control the independent variables or factors influencing attenuation and change of phase shift. This gives a capability of carrying out factor and regression analysis of DVS for stating physical laws between circuit parameters and separate characteristics as well as for simplifying the search of circuit optimal parameters.

Mathematical model of DVS may be presented in the form:

$$A(\omega) = a_0 + \sum_i a_i X_i + \varepsilon;$$

$$\Delta\varphi(\omega) = b_0 + \sum_i b_i X_i + \delta,$$

where  $X$  are the independent variables or factors,  $\varepsilon$ ,  $\delta$  are the random components,  $a$ ,  $b$  are the coefficients being subject to determine. In the case of regression model correction and control parameters directly are taken as  $X$ . For the factor model  $X$  is inner causes requiring their informal interpretation.

Initial data for the system Statistica were formed in the following way. For correction parameters and control resistance differing from optima ones up or down at frequency spectrum 0,01...4 GHz the insertion attenuation and phase shift change were computed.

The results of factor analysis carried out in the system Statistica 6.0 are given in Fig. 5. The diagram of factor loadings plotted for two factors shows that correction and control parameters are clear separated in their influence on attenuator characteristics. Therefore, two nested loops of optimization are not required that simplifies significantly the device synthesis.

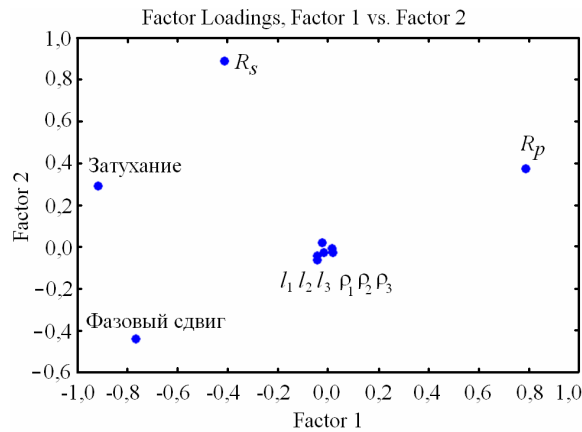

Fig. 5. Values of factor loadings for attenuator

Factor models for changing phase shift and insertion attenuation were constructed by the module «general regression models – factor regression». As a result of simulation the coefficients of factor regression which are given in the form of bar diagrams in Fig. 6, 7 were found. The influence of one or another parameter on corresponding characteristic of the device may be judged by the value of factor regression coefficients.

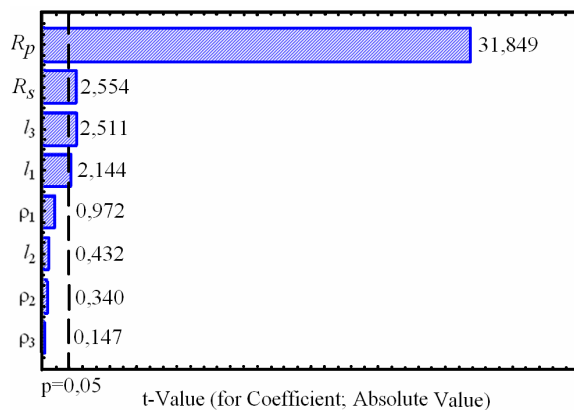

Fig. 6. Factor regression coefficients for phase shift change

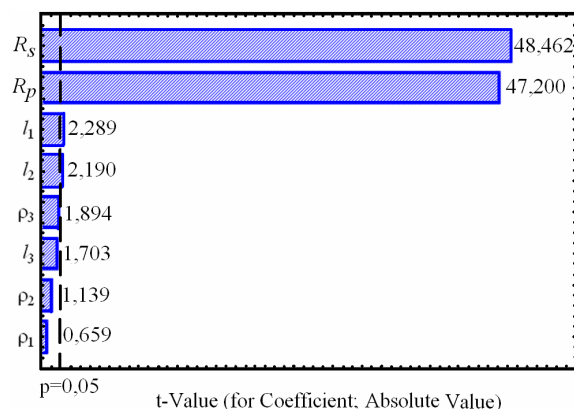

Fig. 7. Factor regression coefficients for insertion attenuation

#### 4. Summary

The constructed factor models do not take into account the influence of stray parameters of controlled elements and their linear combinations with other elements

and frequency. Nevertheless, it is not reasonable to complicate the model as the aim of simulation is not to search the parameters for which phase shift change is minimal but it was necessary only to estimate the influence of each element on characteristics of the device. By the results of the analysis the informal conclusions on the influence of correction and control parameters on changing phase shift and attenuation may be made as well as physical suppositions about scheme operation may be confirmed.

1. Control parameters influence first of all the change of phase shift (Fig. 6, the largest coefficients for  $R_p$  and  $R_s$ ). This conclusion is not obvious as, for example, in [2, 4, 6] and in some other papers it was considered that the main contribution to phase shift change is made by stray parameters of controlled elements
2. Correcting lines  $l_3$  and  $l_1$  support phase stabilization. Influence of the line  $l_2$  is not statistically significant and it may be excluded from the diagram without considerable characteristic degradation.
3. Parallel controlled element influences most of all both the phase change and working attenuation (Fig. 6 and 7, the largest coefficients for  $R_p$  equal to 31,849 and 47,200 respectively).
4. Both controlled elements influence equally the insertion attenuation. Therefore, formation of control law for  $R_p$  and  $R_s$  is necessary for increasing precision characteristics of the device. Influence of the other parameters including line  $l_2$  on attenuation is not significant by the level 0,05.
5. Optimization of correction and control parameters may be carried out separately as they influence different factors and have various factor loadings. This result makes it possible to simplify optimization procedure of DVS characteristics.

#### Conclusion

Methods of statistical simulation in particular factor and regression analysis which were not used before for designing discrete devices with variable states allow revealing physical laws of operation of device scheme elements. It promotes developing structure or topology of the device in terms of specified criterion of optimality. In this paper, in particular, the phase-invariant attenuator of reflecting type as a typical example of the device with variable state was examined. Identification and informal interpretation of factor loadings influencing different studied characteristics allows changing traditional methodology and simplify significantly the search of control and correction parameters.

It was stated that the use of statistical approach to designing such devices is justified both for estimating physics of their performance and for reasoning circuit diagrams. Statistic simulation allows avoiding nested dependence of optimization of parameters of correcting circuits and controlled elements that is firstly to optimize operation modes of controlled elements in non-compensated device and then minimize the change of phase shift. Besides, the volume of experimental investigations of the developed devices may be significantly reduced.

## REFERENCES

1. Kozlov V.I., Yufit G.A. Computer design of microwave devices. – Moscow: Sovetskoe radio, 1975. – 157 p.
2. Stukach O.V. Variable Attenuator with Low Phase Shift / Proceedings of the 9<sup>th</sup> European Conference on Wireless Technology. – Manchester, UK, 10-12 September 2006. – P. 241–244.
3. Ilyushenko V.N., Stukach O.V., Tuev V.I. Optimization of attenuators with phase shift invariant to insertion attenuation // Tekhnika Sredstv Svyazi. Ser. Radioizmeritel'naya Tekhnika. – 1990. – Issue 7. – P. 25–29.
4. Walker S. A Low Phase Shift Attenuator // IEEE Transactions on Microwave Theory and Techniques. – 1994. – V. 42. – № 2. – P. 182–185.
5. Application statistic analysis / S.V. Aleksakhin, A.V. Baldin. – Moscow: Prior, 2004. – 221 p.
6. Controlled attenuators / G.M. Krylov, S.I. Khonyak, A.N. Tynnyka et al. – Moscow: Radio i Svyaz, 1985. – 200 p.

Received on 20.09.2007

UDC 004.94

## STUDYING SIMULATING TECHNIQUES OF THE SYSTEMS WITH DISCRETE TIME AND SOFTWARE TOOLS IN THE SYSTEM MARS

T.N. Zaychenko

«Research institute of automatics and electromechanics», Tomsk

E-mail: aem@snc.com.ru

Questions of formalized presentation and simulation of systems with discrete time and software tools in domestic simulation system MARS have been considered. The ways of formalized presentation of discrete systems specified by difference equations and transfer functions and models of algorithm diagram elements are given. The examples of simulating in the system MARS are presented.

### Introduction and statement of the problem

The universal system of simulation for personal computer and operational system *Windows 97/98/NT* [2, 3] was developed at the department of electrical engineering theory of Tomsk State university of control systems and radio electronics on the basis of the method of component circuits (MCC) of E.A. Arais and V.M. Dvitriev [1]. In papers [3–5] the questions of solving the problems of electric device dynamics in the system MARS were examined. Simulation of electron control tools of key of power electronics devices and electric apparatus of controlling electric device implementing some private control modes (launch, inhibition and electrical motor reverse, load reception and rejection) was implemented with the help of structure chart components – source of actions of saw tooth and square-stepwise form, comparators and logic elements. The analysis of the devices with microprocessor control sets the problems of simulation of software tools (ST) on PC without development computer. The aim of the given article is studying the approaches to modeling systems with discrete time and software tools in the range of MCC and simulation system MARS.

### Concept of simulating systems with discrete time

There are two ways of describing processes in discrete systems: by difference equation (DE) and transfer functions (TF). So, for example, for linear DE of the form

$$y(k) = \sum_{l=0}^L a_l x(k-l) - \sum_{m=1}^M b_m y(k-m) = 0, \quad k \geq 0, \quad (1)$$

TF of the argument  $z=e^{j\omega}$  has the form

$$W(z) = \frac{a_0 + \sum_{l=1}^L a_l z^{k-l}}{1 + \sum_{m=1}^M b_m z^{k-m}} = 0, \quad k \geq 0, \quad (2)$$

where  $x(k-l)$ ,  $y(k-m)$  are input and output signals at time moments  $(k-l)T$  and  $(k-m)T$ ;  $k, l, m, L, M$  are the integers;  $T$  is the sampling time;  $a_l, b_m$  are the coefficients;  $\omega$  is the frequency.

The aim of studying the systems with discrete time is calculation of timing charts or signal numerical sequences.

System MARS gives opportunities of simulating objects permitting formalize presentation in the form of component circuits (CC) from components with bonds of energy and information type in time and frequency domains for linear CC. Energy type bonds are incident two variables – potential and stream; information type bonds – potential. CC mathematical with energy type bonds consists of topological and component equations; with information type bond – only of component ones. The main modes of analysis in time domain in the system MARS are «statics» and «dynamics» including «dynamics explicit» and «dynamics implicit». In the first case differential equation of component models is algebraized by the explicit method of Euler, in the second case – by implicit one. In both cases nonlinear equations are linearized by the method of Newton [1–3]. To organize computing experiment in CC the component-sources of actions and components for visualization of computation results are included. Let us study the capabilities of applying MCC and system MARS for formalize presentation and simulation of systems with discrete time.