



Progress Report on Target Development

A. Cadiou, Y. Foucher, Arnaud Guertin, T. Kirchner, J.S. Stutzmann, J.M. Gautier, J.F. Lecolley, N. Marie, M. Krauth, F. Barbier, et al.

► **To cite this version:**

A. Cadiou, Y. Foucher, Arnaud Guertin, T. Kirchner, J.S. Stutzmann, et al.. Progress Report on Target Development. 2003. <in2p3-00025252>

HAL Id: in2p3-00025252

<http://hal.in2p3.fr/in2p3-00025252>

Submitted on 16 Jan 2006

HAL is a multi-disciplinary open access archive for the deposit and dissemination of scientific research documents, whether they are published or not. The documents may come from teaching and research institutions in France or abroad, or from public or private research centers.

L'archive ouverte pluridisciplinaire **HAL**, est destinée au dépôt et à la diffusion de documents scientifiques de niveau recherche, publiés ou non, émanant des établissements d'enseignement et de recherche français ou étrangers, des laboratoires publics ou privés.



Laboratoire de physique subatomique et des
technologies associées

Unité Mixte de Recherche 6457

École des Mines de Nantes - IN2P3/CNRS, Université de Nantes

MEGAPIE – TEST

(CONTRACT N° FIKW-CT-2001-00159)

PROGRESS REPORT ON TARGET DEVELOPMENT

(DELIVERABLE D08)

A. Cadiou, Y. Foucher, A. Guertin, T. Kirchner, JS. Stutzmann,
J.M Gautier, J.F Lecolley, N. Marie, M. Krauth, F. Barbier,
L. Cachon, J.L Courouau, R. Enderle, J. Henry, G. Laffont,
P. Roubin, P. Saignes, A. Terlain, J.M. Zuena, T. Auger,
D. Gorse, V. Ghetta, J.B Vogt, A. Legris, G. Guittier,
G. Corsini, P. Agostini, G. Benemati, P. Turrone, A. Zucchini,
C. Broeders, X. Cheng, C. Fazio, H. Jacobs, J. Konys,
G. Müller, R. Stieglitz, Y. Dai, S. Dementjev, T.V Dury,
H. Glasbrenner, F. Gröschel, F. Heinrich, H. Heyck,
G. von Holzen, A. Janett, B. Sigg, B. Smith, W. Wagner,
P. Kupschus, I. Platnieks

Rapport Interne SUBATECH 2003 / 03

Subatech - École des Mines de Nantes

4, rue Alfred Kastler - La Chantrerie - BP 20722 - 44307 Nantes

cedex 3

Tél. 02 51 85 81 00 - Fax 02 51 85 84 79 – [http://www-](http://www-subatech.in2p3.fr)

[subatech.in2p3.fr](http://www-subatech.in2p3.fr)





EUROPEAN COMMISSION
5th EURATOM FRAMEWORK PROGRAMME 1998-2002
KEY ACTION : NUCLEAR FISSION

TITLE OF THE PROJECT

CONTRACT N° FIKW-CT-2001-00159 MEGAPIE - TEST

WP1 TARGET DEVELOPMENT

DELIVERABLE D08

PROGRESS REPORT ON WP1

List of Authors

CNRS/IN2P3 (F)

**A. Cadiou, Y. Foucher, A. Guertin, T. Kirchner, JS. Stutzmann (SUBATECH),
J.M Gautier, J.F Lecolley, N. Marie (LPC),
M. Krauth (IReS)**

CEA (F)

**F. Barbier, L. Cachon, J.L Courouau, R. Enderle, J. Henry, G. Laffont,
P. Roubin, P. Saignes, A. Terlain, J.M. Zuena**

CNRS (F)

**T. Auger, D. Gorse, V. Ghetta (IDFE),
J.B Vogt, A . Legris, G. Guittier (LMPGM)**

ENEA (I)

**G. Corsini (ANSALDO), P. Agostini, G. Benemati, P. Turroni, A. Zucchini
FZK (D)**

**C. Broeders, X. Cheng, C. Fazio, H. Jacobs, J. Konys, G. Müller, R. Stieglitz
PSI (CH)**

**Y. Dai, S. Dementjev, T.V Dury, H. Glasbrenner, F. Gröschel, F. Heinrich, H. Heyck,
G. von Holzen, A. Janett, B. Sigg, B. Smith, W. Wagner**

SCK-CEN (B)

P. Kupschus

IPUL (L)

I. Platnieks

Dissemination level :

PU: public

RE: restricted to a group specified by the partners of the [MEGAPIE-TEST] project

CO: confidential, only for partners of the [MEGAPIE-TEST] project

M: Management, **S/T:** Scientific/Technical reports, **MT:** Mid-term, **nnn** = number

Abstract :

The present document is the D08 deliverable report of work package 1 (*Target Development*) from the MEGAPIE – TEST project of the 5th European Framework Program.

Deliverable D08 is the progress report on the activities performed within WP 1. The due date of this deliverable was the 5th month after the start of the EU project. This coincided with a technical status meeting of the MEGAPIE Initiative, that was held in March 2002 in Bologna (Italy). The content of the present document reflects the status of the MEGAPIE target development at that stage. It gives an overview of the Target Design, the related Design Support activities and the progress of the work done for the safety assessment and licensing of the target.

Table of contents :

1	Introduction.....	6
2	General overview on the progress of the Target Development	8
2.1	Target Design overview	8
2.1.1	The main MEGAPIE target parameters	8
2.1.2	A short functional description of the MEGAPIE target	9
2.2	Relevant design issues	10
2.3	Overview of the Ancillary Systems	11
3	TARGET DESIGN (Subtask 1.1)	13
3.1	The Target Head.....	14
3.2	The Target Top Shielding	14
3.3	The Target Heat Exchanger and Upper Liquid Metal Container	15
3.4	The electromagnetic pump system	16
3.5	The Upper Target Enclosure.....	18
3.6	The Lower Liquid Metal Container	18
3.7	The Lower Target Enclosure.....	19
3.8	The Main Flow Guide Tube.....	19
3.9	The Central Rod	20
4	ANCILLARY SYSTEMS (Subtask 1.1).....	21
4.1	LM Cover Gas System.....	21
4.2	Insulating Gas System	22
4.3	LM Fill & Drain System	23
4.4	Heat Removal System	24
5	DESIGN SUPPORT AND VALIDATION (Subtask 1.2)	26
5.1	Objectives of the R&D.....	26
5.1.1	Thermal-hydraulic and structural mechanics	26
5.1.2	Materials Behaviour in MEGAPIE relevant conditions'	27
5.1.3	Liquid Metal Technology	28
5.1.4	Neutronic and Nuclear Assessment	28
5.2	First results obtained in the frame of the R&D Subtask	29
5.2.1	Thermal-hydraulic and structural mechanics	29
5.2.2	Materials Behaviour in MEGAPIE relevant conditions	32
5.2.3	Liquid metal technology.....	39
5.2.4	Neutronic and Nuclear Assessment	44
6	SAFETY AND RELIABILITY ASSESSMENT (Subtask 1.3).....	46
7	LICENSING (Subtask 1.4)	47
8	CONCLUSION.....	47

1 Introduction

Partitioning and Transmutation (P&T) techniques could contribute to reduce the radioactive inventory and its associated radiotoxicity. Sub-critical Accelerator Driven Systems are potential candidates as dedicated transmutation systems, where the main characteristic of ADS (i.e. sub-criticality) is particular favourable and allows a maximum transmutation rate while operating in a safe manner. For these reasons, waste transmutation using ADS has become a relevant R&D topic in Europe. Following a first phase of R&D focused on the understanding of the basic principles of ADS (e.g. the programme MUSE), the programmes have been streamlined and focused on practical demonstration key issues. These demonstrations cover high intensity proton accelerators (beam current in the range 1 – 20 mA), spallation targets of high power (~ 1 MW, like MEGAPIE) and their effective coupling with a subcritical core. Thus, the MEGawatt Pilot Experiment (MEGAPIE), an international initiative, which was launched in 1999 in order to design, build, operate and explore a liquid lead-bismuth spallation target for 1 MW of beam power¹, represents a key experiment in the ADS roadmap². The decision to install the MEGAPIE target into the Swiss spallation neutron facility SINQ at PSI fitted also with the appreciation that liquid metal targets represent the most promising solution for increasing significantly the thermal neutron flux used for irradiation purposes.

The EU MEGAPIE-TEST has the objectives to develop, improve and validate expertise, knowledge and experience about the design and operation of a heavy liquid metal (HLM) target and to verify its feasibility under realistic operating conditions. The main results expected at the end of the project are: development and comprehensive testing of a liquid metal spallation target both under beam – off and beam – on conditions, and the set up of a handbook on the design of a neutron spallation source in general.

The project has been divided into four work packages (WP 0: *Co-ordination*; WP 1: *Target Development*; WP 2: *Target Testing* and WP 3 *Synthesis*). The present document constitutes the progress report of WP 1.

The main objectives of WP 1 (*Target Development*) can be summarised as follows:

Preparation of the complete design of the target with ancillary systems by taking advantage of the MEGAPIE feasibility study and the existing MEGAPIE design work, and considering the boundary conditions of the SINQ Facility. Definition of critical issues and required R&D needs which are inherent in the design and operation of a spallation target.

¹ G. S. Bauer, M. Salvatores, G. Heusner, J. of Nucl. Mater., 296 (2001) 17-33.

- Solution of target specific critical issues in the fields of neutronics, materials, thermal hydraulics, mass and heat transfer, structure mechanics and liquid metal technology, using analytical, numerical and experimental approaches. Selection of best design options according to evaluation criteria established earlier.
- Assessment of safety and reliability aspects which might endanger the integrity and operability of the target; definition and evaluation of countermeasures. Preparation and definition of licensing requirements and criteria.

This report summarises the status of the target design and the first results obtained by the R&D working group. Part of the results described here is based on the presentations made at the **technical review meeting held in Bologna in March 2002**. (Ref.: the presentations are collected on the Internet site www.megapie.web.psi.ch).

In particular:

- The contributions to the general target and ancillary overview were from : F. Groeschel (PSI), W. Wagner (PSI), B. Sigg (PSI).
- The contribution to the target design were from : A. Cadiou (CNRS), T. Kirchner (CNRS), G. Laffont (CEA), S. Dementjev (IPUL).
- The Thermal-hydraulic and Structural Mechanic contributions were from:
B. Smith (PSI), B. Sigg (PSI), A. Zucchini (ENEA), P. Agostini (ENEA), R. Stieglitz (FZK), X. Cheng (FZK). The Benchmark participants were: PSI, CEA, FZK, CRS4/ENEA
- The contributions to the materials behaviour under neutron/proton irradiation and in presence to the liquid metal were from:
J. Henry (CEA), Y. DAI (PSI), F. Barbier (CEA), A. Terlain (CEA), C. Fazio³ (ENEA), G. Benamati (ENEA), J. Konys (FZK), J. B. Vogt (CNRS), D. Gorse (CNRS), H. Glasbrenner (PSI), F. Gröschel (PSI), G. Müller (FZK).
- The contributions to the liquid metal technology part were from:
G. Corsini / P. Agostini (ANSALDO / ENEA), H. Jacobs (FZK), S. Dementjev (PSI), J-L. Courouau (CEA), J. Konys (FZK), C. Fazio³ (ENEA), G. Benamati (ENEA), A. Zucchini (ENEA), Y. Dai (PSI).
- Concerning the contributions from the neutronic and nuclear assessment, the participants to a relevant benchmark were:
CEA, PSI, ENEA, CNRS, FZK and JAERI. The benchmark results were collected in a CEA report (Rapport DM2S SERMA / LCA/ RT/ 01-XX/A issued the 05/10/01) by R. Enderlè et. al.
- Contributions to the safety and licensing were from : F. Groeschel (PSI), Ch. Perret (PSI).

² The European Technical Working Group on ADS, Ed. ENEA, April 2001, ISBN 88-8286-008-6.

³ Presently at FZK

2 General overview on the progress of the Target Development

The MEGAPIE Initiative has experienced important changes since its start from the administrative and technical point of view and some serious technical challenges have surfaced, which cause additional efforts and have caused some delay according to the original schedule. This might have some consequences on the progress and schedule (delivery dates) of the 5th European Framework Project MEGAPIE – TEST as it is directly linked to the MEGAPIE – Initiative.

Considerable progress, however, has been made in the design and on a number of issues relevant to the design and operation of the target, but vital input data are still expected and needed from ongoing or scheduled experiments.

2.1 Target Design overview

2.1.1 The main MEGAPIE target parameters

The main MEGAPIE lead bismuth eutectic (LBE) target parameters are summarised in the following table 1 :

Target geometry

Overall length of the target	5.39 m
Weight (empty, without LBE)	1.5 t

Proton beam

Reference proton beam intensity	1.74 mA
Proton energy	575 MeV
Heat deposition	650 kW

Liquid metal

Coolant and spallation material	Lead bismuth eutectic (LBE)
LBE volume	82 l
Wetted surface	8 m ²
LBE temperature range	240°C – 380°C
Max. flow rate	~ 1 m/s

Beam window

Beam window material	T91
T91 temperature range	330°C – 380°C
Expected dpa rate	20 – 25 dpa

Table 1: Main MEGAPIE target parameters

2.1.2 A short functional description of the MEGAPIE target

Figure 1 shows a schematic view of the different MEGAPIE target sub-systems and the list of ancillary systems.

The proton beam penetrates the target via two windows from below. The double-walled enclosure hull (lower target enclosure) is cooled by a forced convection heavy water flow. The inner beam window is cooled by the liquid lead-bismuth eutectic. The lower target enclosure and the beam window are separated by an insulating gap filled with Helium.

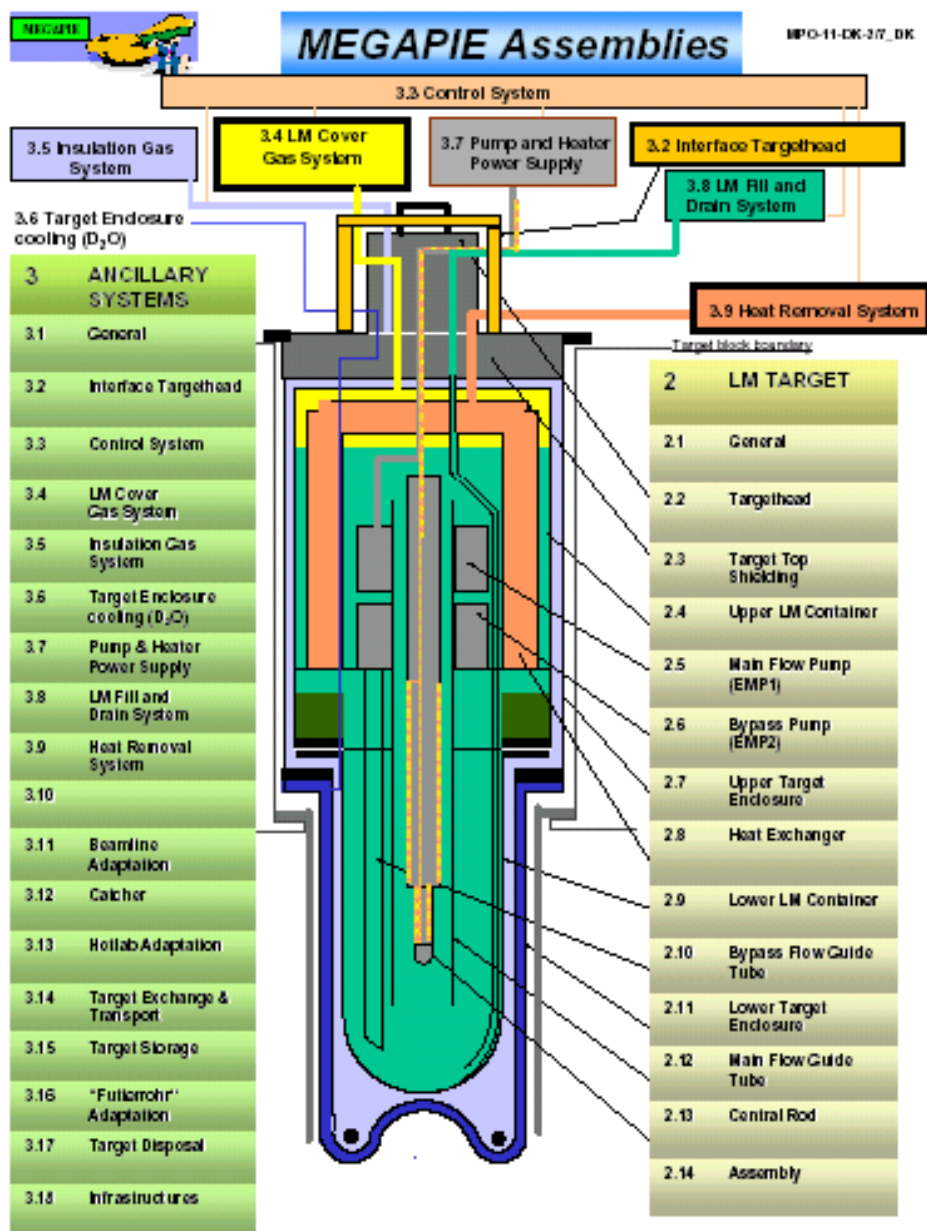

Figure 1: Schematic view of the MEGAPIE target with its target sub-systems and ancillary systems.

The lead bismuth flow is provided by two electromagnetic pumps: an axis-symmetric main flow down an annulus (between main flow guide tube and lower liquid metal container) and an additional flow via a by-pass tube. Due to the large height of the target the character of the flow is mixed convection. The combination of main flow and by-pass flow ensures the cooling of the beam window.

The spallation heat which is produced in the lower part of the main flow guide tube (in the region up to 30 cm above the beam window), is removed via double walled heat exchanger pins to an intermediate cooling loop and finally to an existing secondary cooling system. The fluid of the secondary system is high-pressure heavy water.

In the centre of the main flow guide tube an instrumentation pin (central rod) is inserted which holds instrumentation for the measurement of the neutron flux density and thermo-hydraulic data.

A shielding plug is provided in the top part of the MEGAPIE target, in order to avoid excessive radiation levels in the target head room from direct gamma radiation from the liquid metal.

From the description above the main target sub-systems are:

- the double containment composed of a double walled lower target enclosure (LTE made of AlMg3 with a concave sphere shape) and the liquid metal container (LMC) that contains the LBE;
- the central rod equipped with heaters, instrumentation and neutron monitors;
- the 12 pin single walled target heat exchanger;
- the electromagnetic pump system, the main pump for the main flow and a second smaller pump for an LBE by-pass flow across the beam window;
- the helium insulating gas system;
- the cover gas system equipped with absorbers for volatile spallation products ad

2.2 Relevant design issues

The main relevant design issues are focalised (list not exhaustive):

- on the structural integrity of the target in order to keep all active material confined inside the target and this for normal operating conditions and hypothetical accidents;
- on performances of the heat exchanger to evacuate the deposited heat;
- on performances of the electromagnetic pump system and the risk of cavitation;

- on the (freezing) properties of the LBE and the behaviour of the spallation products;
- on the integrity and the cooling of the beam window.

These, and other, relevant issues streamlined the activities performed within the scientific design support. The main items are given in the following list (see chapter ???? for the status of these topics):

- neutronic benchmark and a detailed assessment of the nuclear reactions to determine relevant input data for the design and safety assessment of the target;
- thermo-hydraulic and thermo-mechanical modelling of the systems and components under normal, transient and accidental conditions, including experimental validation;
- investigation of material properties under irradiation, corrosion behaviour and the risk of liquid metal embrittlement;
- assessment of the LBE properties and the behaviour of the spallation products.

2.3 Overview of the Ancillary Systems

Figure 1 shows also the list of the ancillary systems necessary for the target operation. The sub-systems directly connected to the target can be seen in figure 2. It shows the different systems as they are planned to be installed very close to the top of the target inside the shielding of the SINQ target block.

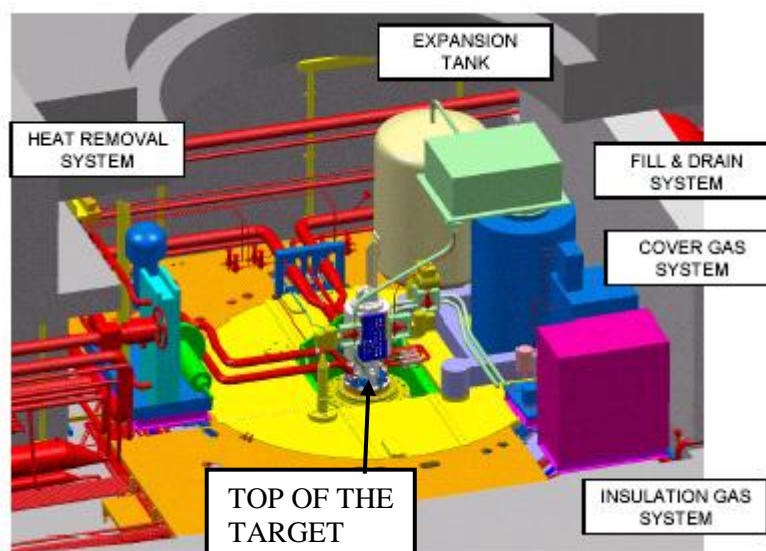

Figure 2: Arrangement of the ancillary systems close to the top of the target.

The ancillary systems to be designed are:

- The heat removal system, with DIPHYL THT oil a cooling medium and an intermediate water loop;
- The cover gas system to cope with the overpressure in the target and to assure the confinement of all gases and a regular and controlled venting;
- The LBE fill and drain system with a double containment and an appropriate system for disconnecting the tubes after operation.

Before the irradiation phase, these systems will be tested in a dedicated test stand (see WP 3 of the Project).

3 TARGET DESIGN (Subtask 1.1)

The design subtask is based on the MEGAPIE feasibility study and is divided into:

- the Conceptual Design phase: concentrating on the identification of critical issues, selection of a reference technical design, selection of reference materials, analytical sizing of individual components, definition of instrumentation and operation control, identification of possible sources of failure and consequences, outline design for ancillary systems;
- the Engineering Design phase: concentrating on the numerical optimisation of single components and complete system using 1D approach, identification of component and system failure modes including lifetime expectancy of the system, engineering design of ancillary systems and the preparation of a Quality Assurance Plan for manufacturing and testing

The geometrical boundary conditions and the fact that the MEGAPIE target has to fit to the existing SINQ facility at PSI fixes the main dimensions of the target as shown in figure 3. An outer view of the complete target is shown on the right side of the figure.

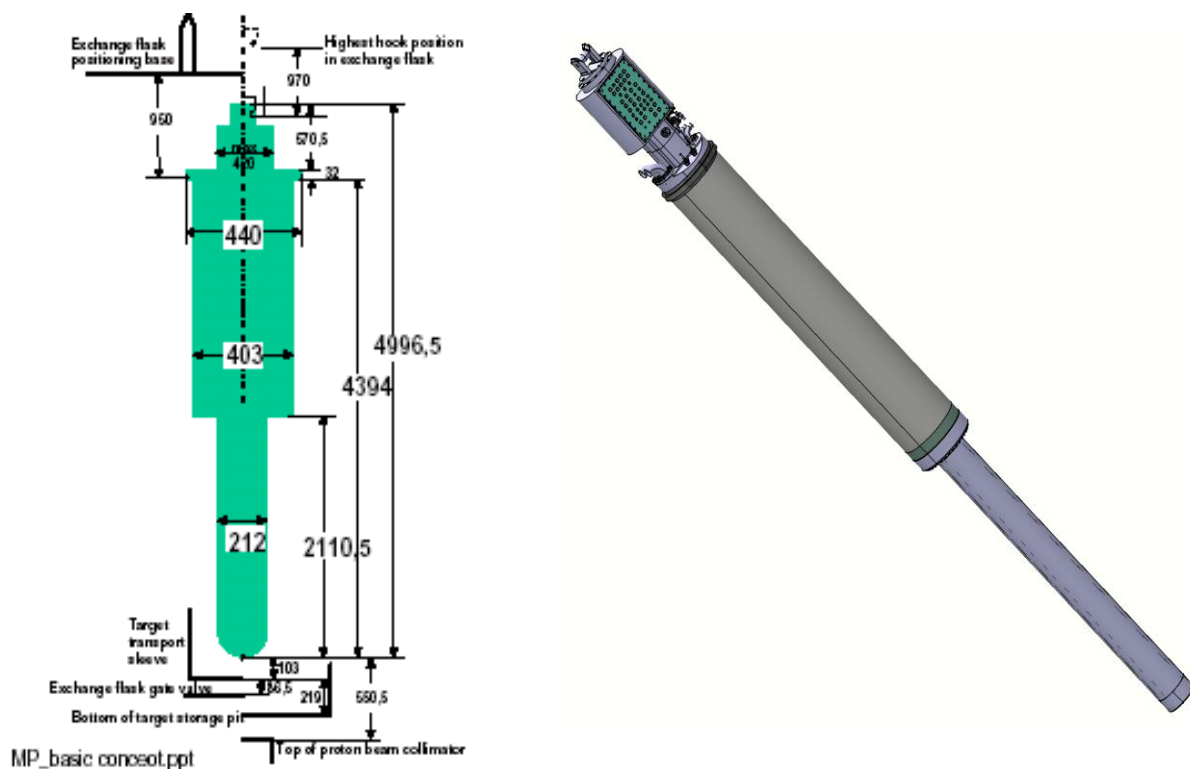

Figure 3: Main dimensions of the MEGAPIE target and a complete view of the target

The target is composed of:

- major structural elements: Upper Target Enclosure (UTE), Lower Target Enclosure (LTE), Upper Liquid Metal Container (ULC), Lower Liquid Metal Container (LLMC);
- major components: Target Heat Exchanger (THE), two Electromagnetic Pumps (EMP1 and EMP2), Target Head (TH), Target Top Shielding (TTS), the central rod and the main and by-pass flow guide tube.

For the target components and structural elements, the engineering design phase is finished and the detailed design phase is in progress. The detail design drawings are under preparation and the detail design calculations in progress. More details are given in the following chapters.

3.1 The Target Head

A 3 dimensional view of the target head is shown in figure 4. The target head assures the interface to the ancillary systems. All electrical cables, oil, water and cover gas pipes as well as the fill and drain (F&d) tubes for the LBE have to be designed adequately for an easy disconnection after the target operation. It has to conform with the safety requirements assuring confinement of radioactive products during all handling steps of the target after irradiation. This requires a system of double enclosure for the cover gas system and the LBE fill and drain pipes.

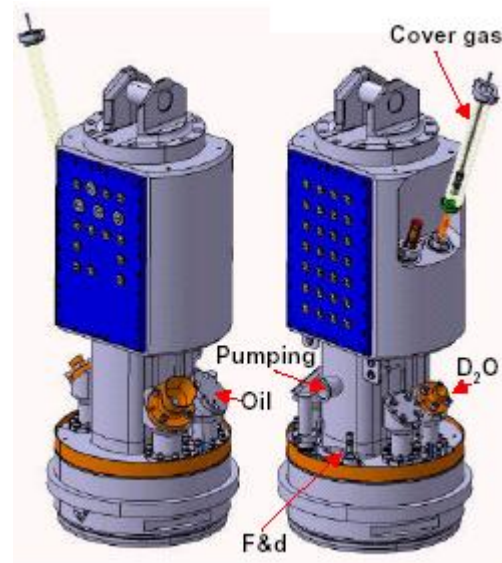

Figure 4: 3D view of the target head.

3.2 The Target Top Shielding

The target top shielding is the part located just below the target head (see figure 5). At this level the oil distribution boxes (for the thermal heat exchanger) and the water distribution boxes (for the lower target enclosure) are located. The trap composed of CaO and CuO is for

absorbing the hydrogen produced in the target due to the spallation reaction in the liquid metal.

The free space in-between these different components has to be filled up with shielding material, in a sort of 3D puzzle. The shielding is a critical issue because of the fact that radioactive material is transported via the liquid metal up to the top of the target. In solid targets, the radioactive material is localised in the lower part of the target, in region of the beam interaction with the spallation material. This is not the case for MEGAPIE where radioactive material circulates with the LBE throughout the target. The radioactivity in the target constitutes a source term for the activation of structural material surrounding the target. To keep this activation (mainly gamma activation) at the requested levels the shielding is being optimised. Whenever possible, feeds through this shield should be designed to avoid direct sight.

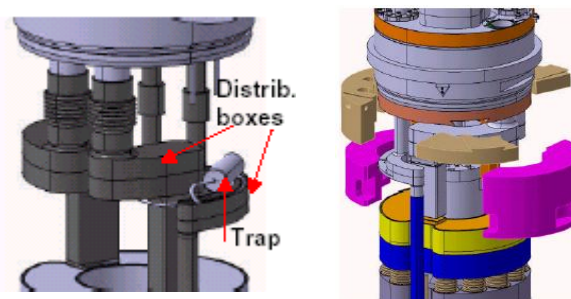

Figure 5: Target top shielding without (left) and with the shielding blocks (right)

3.3 The Target Heat Exchanger and Upper Liquid Metal Container

The target heat exchanger (THE) has to evacuate 650 kW of heat deposited by the beam into the liquid metal. At the same time the design must be such that freezing of the liquid metal can be safely avoided everywhere in the system in cases of variable beam power or extended shutdown periods.

The THE design consists of a single annulus of 12 cooling bayonet pins (2 sectors of 6 pins) inserted into separate channels in which the LBE flows. Heat removal is effected by an intermediate Diphyl® (Bayer) loop. Principal running parameters are :

- Flow rate of the LBE: 0.4 l/s;
- Diphyl flow rate: 10 l/s;

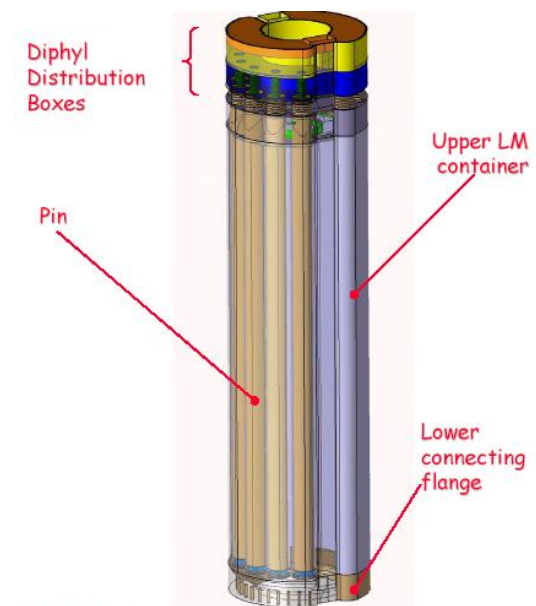

Figure 6 : View of the target heat exchanger with the upper liquid metal container.

- Inlet temperature of LBE can be lowered beneath 350°C;
- To avoid liquid metal embrittlement, the minimum surface temperature on the liquid metal side should stay at least about 50°C above the melting point, i.e. above 175°C for the LBE.

The actual THE design (see figure 6) can be separated into 3 parts:

- Diphyl distribution boxes that allow the uniform distribution of the oil into the 12 heat exchanger pins. The in and outlet diphyl boxes have to be thermally insulated with respect to the LBE. To reduce thermal stresses, bellows assure the binding between the two tubes of each pin and the diphyl boxes. The shape of the containment wall in the inlet should be designed to avoid zones of stagnant fluid, where impurities could be collected or bubbles could be trapped.
- The upper liquid metal container assures the bond with the lower liquid metal container. It also has to centre the two electromagnetic pumps and to guide the liquid metal around the pins.
- The heat exchanger pins are constituted of two coaxial tubes. The inside thick tube collects two functions : inflow duct and shielding because of its high thickness.

Engineering calculations did not show structural problems due to mechanical and thermal stresses. Design uncertainties remain on the behaviour of the bellows and the welds under thermal fatigue. Additional analytical and numerical calculations are ongoing.

3.4 The electromagnetic pump system

The MEGAPIE EMP System (EMPS) maintains LBE flow in the MEGAPIE target to ensure reliable cooling of LBE container (beam entrance window).

The system consists of a main pump (EMP1), responsible for a transit flow between the LBE container and heat exchanger elements mounted on the periphery of the target and a by-pass pump (EMP2), responsible for a flow through the special nozzle situated radial in the container to destroy the flow symmetry (see figure 7).

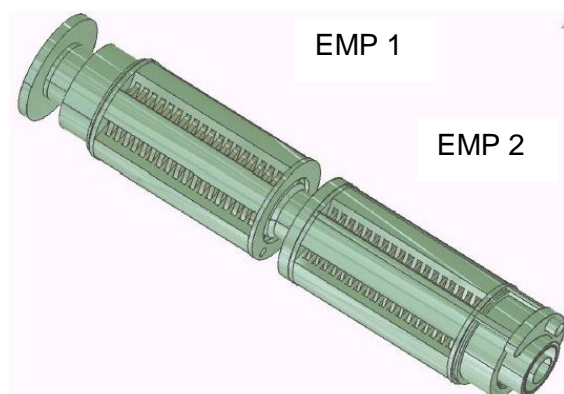

Figure 7 : View of electromagnetic pump system

Electromagnetic flow meters in each LBE path control EM pumps regimes. The EMPS is mounted in steel housing to protect it from LBE.

One of the critical issues is the risk of cavitation. A literature study and an evaluation of the pump specifications show that cavitation is of no concern in the present configuration. Test on a prototype pump will have to confirm the absence of cavitation.

The main parameters of the main (EMP1) and by-pass pump (EMP2) are summarised in the table 2.

Parameters	Regime		
	Min	Nom	Max
Pressure, atm	0.2	0.5	0.91
LBE flow rate, l/s	0.35		
Active power, kW	3	6.8	12
Power, kVA	3.6	8.14	14.4
Current freq, Hz	50 (3 phase)		
Current, A	20	30	40
Current density in coils, A/mm ²	4	6	8
Voltage, phase/linear, V	60/104	90/156	120/207
Induction in passive magnetic core, T	0.76	1.14	1.52
Temperature, °C		300	370

Parameters	Regime		
	Min	Nom	Max
Pressure, atm	0.04	0.2	0.3
LBE flow rate, l/s	5	5	5
Active power, kW	3.5	8.2	11
Power, kVA	4.3	9.8	17.1
Current freq, Hz	50		
Current, A	20	30	35
Current density in coils, A/mm ²	4	6	7
Voltage, phase/linear, V	71/123	108/187	125/216
Induction in passive magnetic core, T	0.79	1.2	1.37
Temperature, °C		460	500

Table 2 : Design pump characteristics for EMP1 (left) and EMP2 (right)

An extended test period is foreseen in order to perform experiments with LBE. The test will be performed on a test stand developed specially for this purpose at RIGA. The main goals of the tests will be:

- To test results of calculations and the basic design of the pump system;
- To test the workability, quality and reliability of the pump system;
- To perform calibration of the EMPS integrated with power supplies and the corresponding control system;
- To perform thermo-hydraulic tests of the EMPS;
- To accumulate experience on the EMPS development and operation.

First EMPS tests are foreseen in summer 2002 after a successful detail design revue scheduled in April 2002.

3.5 The Upper Target Enclosure

Compared to the other target components the upper target enclosure is a simple cylinder made out of stainless steel A316L, with connecting flanges. The upper part is connected to the lower target enclosure. No particular cooling is foreseen for the upper target enclosure.

3.6 The Lower Liquid Metal Container

The lower liquid metal container is one of the critical structural parts of the MEGAPIE target. In particular the beam window is exposed to severe constraints: proton and neutron irradiation, thermal and mechanical load and the presence of flowing LBE. The structural material for the target container is foreseen to be martensitic (French designation T91 type) steel. For the upper liquid metal container (see above) the use of austenitic (316L type) steel is being considered, which is more readily available and easier to weld. This is contingent upon sufficiently high liquid metal corrosion resistance, because the highest temperature gradient in the system will occur along the heat exchanger. In order to facilitate the transition between two different materials the two parts will be joined by a flange system.

Figure 8 shows the lower liquid metal container with a zoom on the beam window region (right). For buckling reasons the thickness of the cylindrical part is 2 mm in the lower part and 4 mm in the upper part.

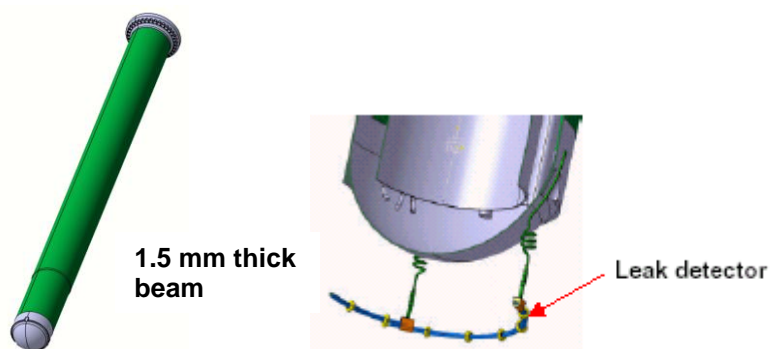

Figure 8: The lower liquid metal container (left) showing a cut through the 1.5 mm thick beam window (right) with the lower LBE leak detector.

LBE leaks out of the liquid metal container into the gap filled with helium must be detected very rapidly. Dedicated leak detectors are under investigation that allow to detect very small quantities of LBE. One solution is a ring detector (see figure 8) fixed to the liquid metal container. A system of springs maintains the leak detector on the inner part of the lower target enclosure. Small ceramic rings around the detector assure electrical insulation with

respect to the lower target enclosure. When LBE is leaking into the gap it will cause an electrical contact between the ring-detector and the lower target enclosure.

Investigations are ongoing for an additional LBE leak detector on the cylindrical part of the lower liquid metal container. The idea is to have a large surface leak detector added on the tube via a plasma spray method. The feasibility of such a procedure is actually being assessed.

3.7 The Lower Target Enclosure

The whole target container will be surrounded by a second enclosure (lower target enclosure: LTE) with helium gas in-between. In the lower part this enclosure will be double walled with heavy water cooling as is the present target shell. The material for this part will be chosen for minimum neutron absorption and sufficient strength at any temperature the shell might reach in the case of a breach of the target container. Presently Aluminium is the favoured material, the same as for the actual solid SINQ targets.

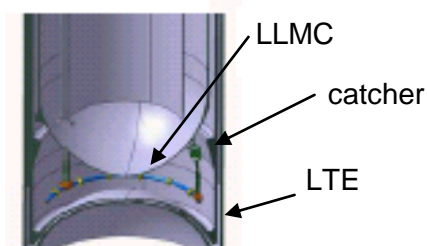

Figure 9: Cut through the three shells of the lower part of the MEGAPIE target

The reversed spherical shape of the LTE (see figure 9) has been adopted because it allows the LBE in case of a leak to flow into the lower edges of the LTE. This avoids accumulation of LBE in the centre where the beam hits the target. Remaining LBE in the beam interaction zone would lead to a strong power deposition and could provoke the rupture of the aluminium double walled shell.

3.8 The Main Flow Guide Tube

The main flow guide tube separates the down-coming cooled LBE on the outside from the up-streaming hot LBE in the inside. Main components (see figure 10) are the main flow guide tube itself (1), made out of A316L stainless steel, the interface flange (2) for the electromagnetic pump and two spacers (3) to keep the components in the defined position in hot as well as in cold conditions. A zoom on the lower part of the main flow guide tube shows the by-pass tube (4) for the additional window cooling, the fill and drain tubes (5) and nine thermocouples (6) for the temperature measurement in the lower part of the target.

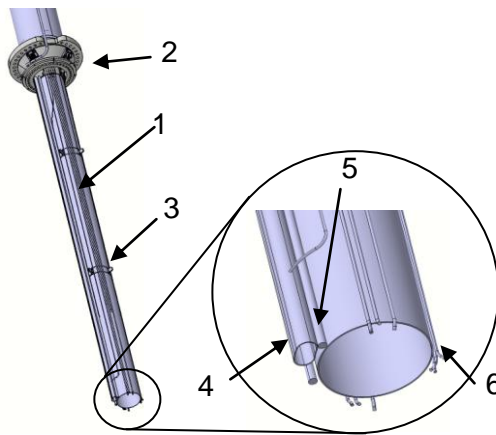

Figure 10: The main flow guide tube (1) with its different components : EMP interface (2), the spacers (3), the by-pass tube (4), the LBE fill and drain tubes (5) and thermocouples (6).

The final shape of the by-pass tube outlet, the length of the fill and drain tubes as well as the position of the thermocouples are not yet fixed. Their final design will depend on results of thermo-hydraulic calculations performed by the MEGAPIE scientific design support.

3.9 The Central Rod

The central rod (figure 11) will be inserted from the top into the MEGAPIE target. The central rod fills up the central part of the target and reduces the amount of LBE. It is equipped with two heaters (not seen on figure 11) for the heating up of the target prior to the filling in of the LBE and to avoid uncontrolled freezing during operation when the beam is off. Under the interface flange a palladium getter will be mounted. This

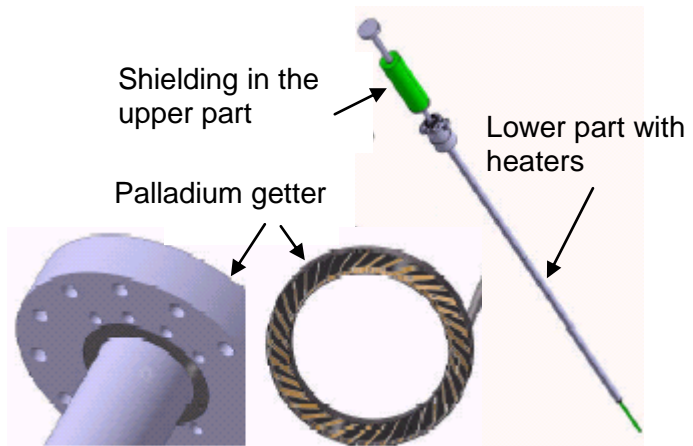

Figure 11: Central rod with the palladium getter for absorbing Hg vapours in the cover gas.

palladium getter is in direct contact with the cover gas above the free LBE surface. Mercury that is produced by the spallation reaction evaporates into the cover gas and will then be absorbed by the palladium. This avoids uncontrolled condensation of Hg vapour in the cover gas system outside the target. Investigations are ongoing in order to check the possibility to install neutron detectors (small fission chambers) in the bottom part inside the central rod to measure the thermal and fast neutron fluency.

4 ANCILLARY SYSTEMS (Subtask 1.1)

Special attention has to be paid on the Fill-and-Drain System, the Cover-Gas System and the Insulating Gas System, in particular with respect to the required interfaces and double enclosure concept, the latter to some extent also affecting the target head interface. Directly related to the target heat exchanger is the heat removal system as one of the main ancillary systems. The arrangement of the systems in the TKE is now well elaborated (see figure

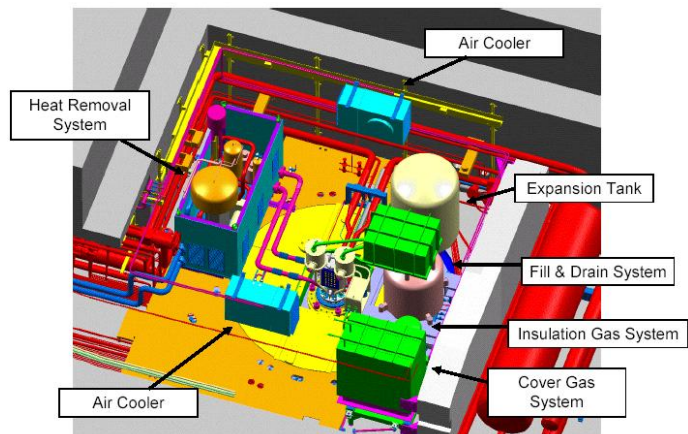

Figure 12: Arrangement of the main ancillary systems in the TKE.

12). Regarding the beam line adaptation, there are still ongoing considerations for a special beam collimator to prevent a focussed beam from hitting the target, in conjunction with the VIMOS system for visualizing possible beam focussing. A further important task, the Hot lab adaptation, has finished its feasibility study in collaboration with the Hot lab operation division.

In this progress report we will mainly concentrate on the cover and insulating gas system, the fill and drain system as well as the heat removal system.

4.1 LM Cover Gas System

The Target Cover Gas System (CGS) is located near the north wall of TKE. The CGS system is actually in the detailed design phase. The main component parts of the CGS are a relatively large-volume decay tank, a vacuum pump and interconnecting tubing fitted with 5 solenoid valves for remote operation. As the CGS is containing to a large extend radioactive gases all components of the system have to be confined in a secondary containment to prevent any release into the TKE (see also F&D system).

Extraction of cover gas will be necessary whenever the pressure increase due to the gases produced in PbBi by spallation will reach 0.04 MPa at beam-down conditions. The functions of the cover gas system are:

- to extract periodically these gases, to restore the design pressure.
- to keep the radioactive contamination under control with absorbers and filters.
- to let the radioactivity of noble gases decay

- and to emit the remaining gas into the controlled air exhaust of the accelerator plant when its airborne radioactivity is well below the allowed limits.

Vapours of volatile elements - mainly Hg and Po - are adsorbed within the expansion tank on a Pd-coated surface. Hydrogen isotopes and water vapour will be continuously chemically bound in a mixture of CuO and CaO inside the upper target shielding. The production of hydrogen isotopes would otherwise require too frequent gas exhaust. The He production rate determines the frequency of extractions.

Gases shall be extracted by the cover gas system only during beam-downs. Electromagnetic pumps EMP are shut down to avoid cavitation in case that cover gas pressure dropped below the required pressure during the extraction procedure. Valve 4 is open only during gas extraction. The gas is cooled from approximately 240 C to 50 C by streaming slowly through the cold trap built inside the upper target shielding, where the main part of remaining vapours condense.

Within the cover gas system the gas passes first through an active carbon filter, then through an aerosol filter, so that only noble gases He, Ar, Kr and Xe enter the decay tank, where they remain until the next gas extraction. The decay tank stays always at under-pressure. Decay tank emptying and cover gas extraction is expected to be due less than once every month. Samples can be taken by the health physics dept. for radioactivity checks before each main action.

4.2 Insulating Gas System

The insulating gas system has to handle the Ar gas that fills up the volume between the lower liquid metal container (T91) and the lower target enclosure (double walled AlMg3).

The system has to assure the following functionality:

- Surveillance of integrity of the confinement (leak detection into the insulating gap);
- Evacuation of D₂O vapour in case of a leak into the insulating gap;
- Counter-pressure on the lower liquid metal container during the draining of the target.

The selection of an Argon gas system (Ar at 0.005MPa in normal operation) is based on the following arguments :

- The gas must be chemically inert;
- Ar is better than He due to its lower heat transfer capacity;

The system is composed of the Ar filling tubes and the evacuation tube equipped with a certain number of valves. The evacuation of the insulating gas goes via a cooling system and a filter system (active carbon filters and aerosol filters) to the controlled exhaust system. Before venting there is the possibility to perform gas-sampling for γ -spectroscopy analysis.

4.3 LM Fill & Drain System

The liquid metal Fill & Drain System (F&D) of Megapie is intended to provide:

- the initial filling of the target with fresh LBE,
- the final draining of the irradiated LBE from the target,
- the intermediate drain and fill in case of operations at the beam collimator,
- the safe storage of the irradiated LBE to be finally disposed.

The operations are quite simple, nevertheless, the manipulation of the irradiated LBE is very demanding on terms of safety. For this reason, before its installation, the system has to be tested to reassure about its functionality with special attention to the following items :

- Pipe plugging (to be prevented during the phase of final or intermediate LBE draining).
- Final squeezing and cutting of pipes for the remote disconnection (separation of the drain vessel from the other parts of the system). This double operation has to assure that there will be no release of LBE and contaminated gas out of the tubes.
- Valve failure;
- Recrystallization: The volume increase after freezing represents one of the main drawbacks of LBE. The volume increase can turn into stresses of the container walls and of its internals (e.g. during transport from Italy to PSI after testing of the F&D system).
- Seal filling by fresh LBE: The final sealing of the vessel containing the irradiated LBE is performed, in order to assure a sufficient radiation shield, pouring on the free level of the frozen irradiated LBE, a layer (50 mm) of un-irradiated LBE.
- Overall functionality will be guaranteed by a series of tests performed at the nominal operating conditions following the complete F&D procedure, except for the final cutting.

An additional major issue is the double containment of the F&D system. The Polonium concentration in the contaminated LBE is such that the vapour emission and sputtering that

will condense on the surrounding surfaces will produce a contamination beyond the limits. Even if the design of radioactive containment and manufacture has been made with the higher standard, for safety reason one has to assume that a failure may happen producing a leakage. Therefore the parts of the system containing activated LBE (or the CGS as mentioned above) must be enclosed in a secondary containment that prevent any spill into the TKE in case of an LBE leak. The secondary containment must assure early leak detection out of the primary containment wall, the collection and containment of the leaked matter so that extraordinary provisions can be made to restore a safe situation inside the TKE. The secondary containment has an impact on the operation required when equipment and components have to be disconnected for independent handling and transportation.

The F&D systems has passed the engineering design and is actually in the detailed design phase taking into account all the above mentioned specifications.

4.4 Heat Removal System

The Heat Removal System (HRS) of Megapie is designed to transfer heat from the target heat exchanger (THE) and dissipate it to the cooling water circuit via the intermediate heat exchanger (IHE). The target heat removal will be effected by means of an organic coolant Diphyl THT, Bayer).

The HRS consists essentially of a closed loop filled with Diphyl THT, one re-circulation pump and two heat exchangers. The first heat exchanger is the LBE/diathermic fluid heat exchanger integrated in the MEGAPIE target and the second one is the diathermic fluid/heavy water heat exchanger that back-cools the diathermic fluid. The HRS allows the target to be operated at temperatures between about 200 and 350°C without the risk of a liquid-metal water interaction.

The main functions performed by the HRS are:

- LBE cooling during normal beam operation, by removal of heat from the LBE coolant;
- Control of the LBE temperature, on the cold leg, during normal beam operation, beam trips and extended shutdown phases;
- Provide a barrier to the release to the environment of radioactive isotopes from the LBE circuit;
- Confine any ingress of radioactive isotopes from LBE side, further to accidental rupture of THE pins;
- THE heating up, to accept LBE filling;

- Minimise the frequency of conveying to the gas venting system the gases formed in the diathermic fluid as a consequence of radiolysis and pyrolysis;
- Monitor and collect small leakages of the diathermic fluid from any point of the HRS.

Power transients, which are caused by the relatively frequent proton beam interrupts, require a control system that enables one to keep the target temperature variations within acceptable limits. First simulation results show that the temperatures can be maintained sufficiently far above the melting temperature of Pb-Bi.

The main argument for the selection of the organic coolant for the intermediate cooling circuit of MEGAPIE are

- low vapour pressure (3mbar at 158°C)
- satisfactory heat transfer capability (0.15 kJ/(kg*K) for LBE at 300°C)
- tolerable decomposition and irradiation effects under the operating conditions

Based on a certain number of irradiation experiments (sealed capsule in a TRIGA reactor, electron irradiation experiment, analysis of early experiments under reactor conditions) extrapolations of the data to MEGAPIE conditions were performed with the conclusion that the max. decomposition of THT (23wt%) would be of no concern for risk of fouling. The radiolysis is likely to be half that figure.

5 DESIGN SUPPORT AND VALIDATION (Subtask 1.2)

5.1 Objectives of the R&D

During the first phase of the MEGAPIE project, jointly to the design activities, an R&D working group is supporting the design of the MEGAPIE target with experimental and computational issues. The major fields covered by the R&D working group were: thermal-hydraulic and structural mechanics, materials behaviour under neutron / proton irradiation and in presence of the liquid metal, liquid metal technology, neutronics and nuclear assessment.

5.1.1 Thermal-hydraulic and structural mechanics⁴

Thermal-hydraulic and structural mechanics studies were addressed towards the demonstration of the overall coolability and structural integrity of the MEGAPIE target in terms of efficient heat transport from heat-producing regions to the heat exchangers, and the protection of structures from strong thermal gradients. In addition the identification and quantification of normal and abnormal transient behaviour of the target, operational efficiency, fault propagation and damage limitation aspects are relevant topics. Objectives of the studies conducted in the frame of thermal – hydraulic and structural mechanics are: the definition of the primary circuit flow configuration within the geometric constraints imposed by the boundary conditions; the identification of the optimum target window design to minimise thermal loads and pressure drops, and to avoid hot-spots and flow instabilities; the demonstration of reliable cooling of the safety-hull window using existing SINQ water circuits as well as the structural integrity of the target vessel and internal components, and of the safety hull. A further key action is the investigation of transferring the heat produced by the proton beam in the target from the liquid metal to the secondary D₂O cooling system by means of a reliable and manageable heat exchange unit. The design of the heat exchanger (HEX) has to be elaborated in close connection with target thermal-hydraulics and auxiliary system adaptation (secondary coolant, control, etc.). Different heat removal systems were discussed and a realistic design that ensures reliable cooling of the target metal without exceeding given operating temperature limits (avoidance of freezing, overheating and excessive temperature differences between hot and cold parts) and satisfies the requirements of safety, shielding and the boundary conditions of the existing structures at SINQ (geometry and auxiliary systems) has been worked out.

The previously mentioned activities include basic analytical studies, detailed numerical simulations, and careful experimentation using actual and simulant materials. In the frame of numerical simulations CFD analyses as well as associated stress analyses of the target

⁴ Brian L. Smith and B. Sigg, PSI/LTH, MEGAPIE Baseline report MPB-4-BR-2/2_BR and MPB-5-BR-3/2_BR and X6.

window (Benchmark) and of the safety windows were started. The HYTAS water experiment and the Pb-Bi experiments (KILOPIE and Heated Jet experiment) to be performed in KALLA (FZK) are related to the heat transport phenomena at the beam window, while the cooling pin tests in which thermal exchange characteristics between LBE and an organic coolant are determinate and compared with numerical calculations (ENEA), are related to the heat exchanger.

5.1.2 Materials Behaviour in MEGAPIE relevant conditions^{5,6}

Regarding the structural material, the martensitic steel T91 was selected as reference material for the target window on the basis that this steel offers the best compromise between high irradiation damage resistance, reasonable compatibility with liquid Pb alloys, good ability to sustain energy deposition and industrial experience on transformability and weldability. The proposed materials for the safety hull were the Al and Zr alloys (AlMg₃ and Zircaloy-2) that showed a good behaviour in the Mark II experiment at SINQ, where the peak fluence was up to 3.2×10^{21} p/cm².

The materials related Work Package can be split in two parts, the first part mainly concerns to the irradiation issues, its objectives are (i) to assess the availability of the martensitic steels in the required geometry and metallurgical condition (ii) to specify the selected base materials and welds practice, (iii) to provide the rationale for the selection of the structural materials of the window and the safety hull and (iv) to gather the mechanical properties of non-irradiated and irradiated structural materials (taking into account the production of spallation products, He and H) in a handbook. The second part addresses the evaluation of the corrosion resistance of the T91 steel in flowing liquid metal without and with neutron / proton irradiation, in MEGAPIE relevant conditions. The objectives of this second part are (i) to characterise the T91 steel in terms of corrosion rate and corrosion mechanism for both not – welded and welded parts and consequently the possible requirements of structural materials protection; (ii) to evaluate the mechanical behaviour in terms of tensile and fatigue properties both in air and in molten Pb-Bi; (iii) to estimate the mechanical behaviour in LBE with neutron / proton irradiation. To achieve these objectives several experiments are foreseen: 1) Corrosion experiments on not welded and welded materials in static and flowing liquid metal and under MEGAPIE relevant conditions, 2) fatigue and LME experiments in static Pb-Bi on T91 steel in different heat-treated states, 3) the LISOR experiment which has the aim to estimate the tensile and creep resistance of T91 steel in flowing Pb-Bi and in presence of a proton beam.

⁵ MEGAPIE Pilot-Target Level 1 Baseline Report Work Package X.7 SOLID-LIQUID INTERFACE, J. Konys (FZK), D. Gorse (CNRS), C. Fazio (ENEA), F. Barbier (CEA), Y. Dai (PSI), T. Kirchner (Subatech)

⁶ Selection of the industrial grade T91 on the basis of the presentation by J.L. Boutard, Y. Dai and K. Ehrlich Cadarache Megapie Meeting, June 14th and 15th, 2000.

5.1.3 Liquid Metal Technology⁷

The technological aspects of the MEGAPIE system design, operation and decommissioning are taken into account in the frame of the liquid metal technology studies. The objectives of the technology task are for instance the evaluation of the pumping system, the assessment of the purification system, the identification of consequences and solutions for contamination problems, and the investigation of issues related to the operation procedures. Liquid metal technology issues are strictly related with both the target and the ancillary systems designs and the achievements of the objectives are supported by several experimental activities covering all the fields related to the technology tasks. Experiments and literature reviews were foreseen for the following topics:

- Literature review on the characteristics of the organic coolant chosen for the primary heat exchanger.
- Literature review, numerical calculation and experimental activities on LBE / coolant interaction.
- Tests on the EM pump and flowmeter aimed at evaluating their performance and at demonstrating whether cavitations could occur in the MEGAPIE conditions.
- Study on the need and adaptability of an oxygen control and monitoring system in the MEGAPIE target.
- Literature review and experimental activities on the chemical and physical characteristics of the Pb-Bi in the liquid and solid state.
- Theoretical and experimental evaluation of the LBE spallation products with a particular attention on the gaseous products and Polonium.

5.1.4 Neutronic and Nuclear Assessment⁸

The objective of neutronics and nuclear assessment is to evaluate neutron production, energy deposition, radiation damage levels, spallation and activation products and radiation level in the MEGAPIE target by means of computational tools. A key action of this task is to compare and qualify neutronic models and codes on a full scale 1 MW spallation experiment. A Neutronic Benchmark to compare the numerical codes SPARTE, MCNPX, FLUKA, LAHET, NMTC was also launched.

The main characteristic to be evaluated in the frame of the neutronic and nuclear assessment is the overall neutron source performance. However, beyond the evaluation of

⁷MEGAPIE, outline for the workpackage LIQUID METAL TECHNOLOGY, G. Benamati (ENEA), C.Latgè (CEA), V. Ghetta and D. Gorse (CNRS), J.Knebel (FZK), P. Kupschus (SCK-CEN), Bernd Eichler (PSI)

⁸ MEGAPIE, baselining document for the workpackage on NEUTRONICS AND NUCLEAR ASSESSMENT, Y. Poitevin (CEA), E. Lehmann (PSI), T. Kirchner (CNRS), S. Leray (CEA), G. Fioni (CEA), JF. Lecolley (CNRS), F. Haddad (CNRS), P. Eudes (CNRS), JC. Klein (CEA), C. Broeders (FZK), M. Carta (ENEA)

nuclide inventory and source terms, which are crucial for performance, design and material issues, the goals of this work package are also:

- to participate in the safety demonstration (radionuclide inventory),
- to give requirements and contributions for instrumentation & operation,
- to contribute to the qualification & development of nuclear data, spallation code and calculation schemes.

5.2 First results obtained in the frame of the R&D Subtask

5.2.1 Thermal-hydraulic and structural mechanics

5.2.1.1 Computational activities

Computational Fluid Dynamics (CFD) simulations are being performed simultaneously by different organisations, concentrating on different aspects of the lower-target design. Generally, the calculations support the basic concept of forced-convection, downward flow in the annulus, a U-turn over the window, and upward flow in the riser, provided there is a strong, supplementary cross-flow over the window itself, produced either by design asymmetry or bypass flow from a separate pump. The diversity of approach -different groups working in parallel- means that a large number of parameter variations are possible in the study. However, much higher quality data will be produced if certain cross - checks are made. Consequently, a Benchmark Exercise has been defined in which a representative (though simplified) thermal hydraulic simulation of the target window, with clearly specified boundary conditions, is undertaken by all groups, and results are compared. Some details of this exercise will be described.

The 1st Benchmark Test was made using the geometry based on actual Megapie dimensions, but for this first exercise the guide tube is slanted and there is no bypass flow, see figure 13. All CFD simulations are based on a total flow rate of 40 kg/s. Participants in the Benchmark are PSI, CEA, FZK, CRS4, KAERI using the CFD codes CFX-4 and STAR-CD. The data are being collected and a comparison will be made. Concerning structural mechanics, the stress analysis of the lower target design was made with the ABAQUS code (ENEA). From these first studies, it was possible to give some recommendations concerning the design of the target, though some remained speculative until more information becomes available:

- For the elliptical beam footprint, better window cooling and less severe guide tube heating are obtained for the case in which the bypass flow is aligned with the minor axis.

- Better window cooling and, particularly, less severe temperature differences (and associated stresses) in the lower part of the guide tube are obtained if the guide tube is slanted at the bottom with bypass on large-gap side.
- With the slanted guide tube, there is evidence that the target could still be operated if the bypass pump fails (but at reduced power).
- The target cannot be operated if the main pump fails.
- Bypass flow rate should be 2.5 kg/s (through a nozzle of about 200 mm², resulting in a discharge velocity of about 1 m/s), and main flow rate 37.5 kg/s
- More studies are needed to optimise bypass nozzle shape, but a rectangular shape of 10 mm/20 mm looks promising.
- Significant heat transfer occurs from (hot) riser flow to (cool) annulus flow, through the guide-tube wall. A more even temperature distribution in the riser is obtained if the guide tube is insulated above the spallation zone.
- Spacers should be inserted between the guide tube and the target hull (as low as possible) to limit the bending of the guide tube as a result of differential heating in the riser. With the insertion of the spacers the calculated max. Mises stress (to be around 50 MPa) in the target window is insensitive to the proposed design option. The max. stress in the guide tube, on the contrary, is highly dependent on the design and it would be reduced significantly by slanting of the guide tube end.
- Due to thermal expansion, the vertical extent of the target hull increases by 5.5 mm and the guide tube by 10 mm from cold conditions.

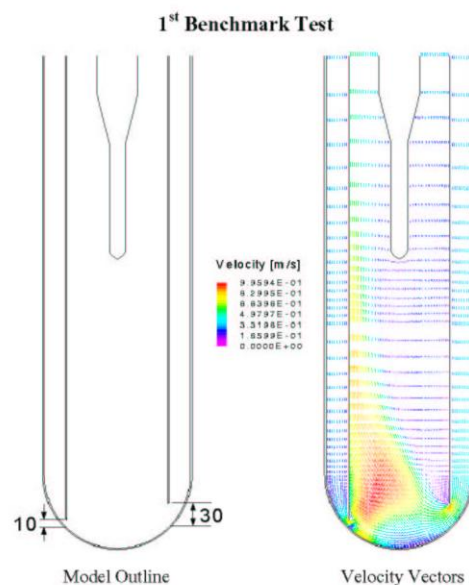

Figure 13: Taken from B. Smith (PSI), Thermal – Hydraulic and Structural Mechanic, MEGAPIE Technical Review Meeting, March 5 – 6, 2002, Bologna, Italy.

5.2.1.2 Experimental activities

A major step to deduce the convective - diffusive heat transport phenomena in laminar and turbulent liquid metal flow for a specific problem like the cooling of the MEGAPIE beam window is a combined experimental-numerical effort by treating the “real” geometry. Due to the low Prandtl number of liquid metals a decoupling of kinematic and thermal transfer processes appears, which is often not treated in commercial CFD codes. Therefore, a plexiglass module (HYTAS) operating with water and representing the nearly MEGAPIE geometry at 1:1 scale has been built up and set into operation at FZK, see figure 14. In parallel to the HYTAS module a lead bismuth experiments (Heated Jet and KILOPIE) are in preparation in the THEADES loop of KALLA at FZK. For the KILOPIE experiment, for instance, a prototype-relevant heat flux of up to 140 W/cm^2 at the centre of the proton beam will be simulated using Heat Emitting Temperature Sensing Surfaces (HETSS).

Cooling pin tests were performed at the ENEA site in Brasimone in order to measure the thermal exchange characteristics between the LBE and the diathermic oil formed by partially hydrogenated terphenyls (THT).



Figure 14: Taken From R. Stieglitz (FZK), HYTAS test facility and Set – up.

The tests were performed with a flow rate of the diathermic oil in the range of $0.2 - 0.6 \text{ l/s}$ whilst the LBE flow rate was between $0.14 - 0.18 \text{ l/s}$. Temperature measurements were performed at the LBE and oil inlet and outlet, with the thermocouples placed on the test section as showed in figure 15. The experimental results were compared with STAR-CD calculations and a good agreement between computational and experimental results were experienced. Convection coefficients extrapolated for the MEGAPIE conditions were

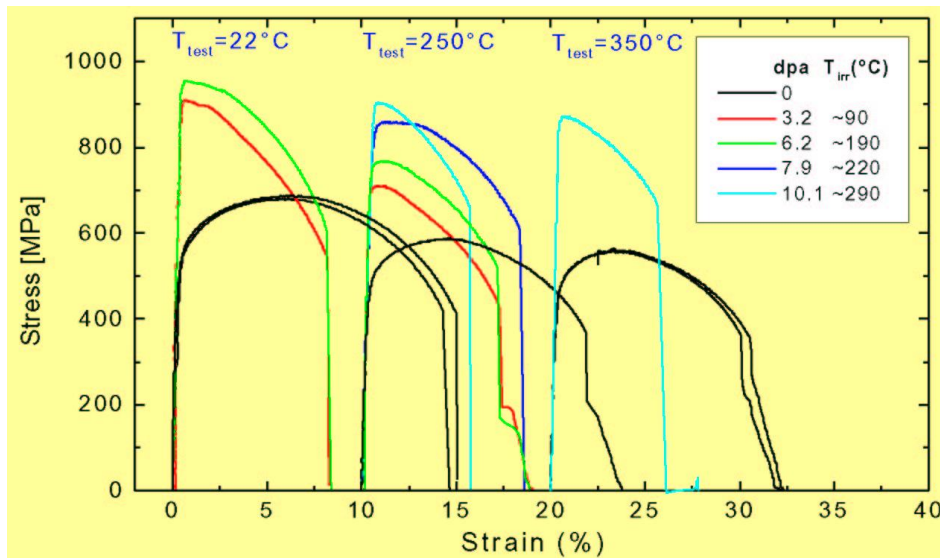

Figure 16: Taken from Y. Dai (PSI), Preliminary studies of martensitic steels irradiated at SINQ Target-3, MEGAPIE Technical Review Meeting, March 5 – 6, 2002, Bologna, Italy.

Effect of helium on the tensile properties of T91

Miniature tensile specimens were implanted with He at different temperatures (in the range 250-550°C) and up to various concentrations (from 625 to 5000 appm). The results obtained so far have shown that for a given implanted concentration, tensile properties are much more affected at 250°C than at higher temperatures. Following implantation to 5000 appm at 250°C, a very high amount of hardening is observed, together with a total loss of ductility and a predominantly intergranular fracture mode. At 550°C, however, the specimens implanted to the same concentration, still retained significant ductility. Recent implantation experiments performed up to 2500 appm at 250°C, have shown that embrittlement is as pronounced for this He concentration than following implantations of 5000 appm He. For 625 appm He implanted at 250°C, ductility is affected only to a limited extent. For specimens implanted at 325°C with 1250 appm and at 400°C with 2500 appm, ductility remains acceptable. Further experiments are underway in order to complete the data base of He effects on tensile properties as a function of the concentration and temperature. In addition to tensile testing, TEM and SANS investigations were carried out in an effort to understand the pronounced embrittling effect of helium at low temperature. The proposed mechanism is the following: the very high hardening measured following implantation at 250°C, 5000 appm, is due to a high density of small He bubbles. This pronounced hardening, together with a decrease of grain boundary cohesion due to the presence of He¹⁰, triggers the brittle, intergranular fracture mode.

¹⁰ R. Gupta, SPIRE progress meeting (June 2001)

Effect of irradiation at low temperature on impact properties/fracture toughness

Data relative to irradiation effects on impact properties/toughness of 9Cr-1Mo martensitic steels are very scarce in the temperature range relevant for the MEGAPIE window (250-350°C). For instance, a DBTT of 97°C (i.e. a DBTT shift of 175°C) and a toughness transition temperature (at 100 MPa√m) of 50°C was measured on samples irradiated at 300 °C up to 2,5 dpa¹¹. Results of impact tests on T91 samples irradiated in BOR-60 (irradiation performed as part of Spire, at 330°C up to about 35-40 dpa) will be available in future and clarify this picture. In addition, also He effects on impact properties will be studied within the SPIRE programme using alpha particle implantations in the notch region of Charpy specimens.

Comments on the service life of the Megapie window

According to the latest available data¹², in the central, most irradiated part of the window (6 cm in diameter) the temperature range for the inner wall in contact with Pb-Bi is 265- 340°C. The inner wall has the highest stress level which remains however relatively low (maximum value of the von Mises equivalent stress is about 50 MPa). The hottest region is also the most irradiated with total dpa damage (resp. He content) evaluated to reach 23 dpa (1690 appm He) for a service time of 9 months. The coldest region of the central part will experience a radiation load of 12 dpa together with 850 appm He within the same service time. This corresponds roughly to the irradiation temperature and irradiation load (dpa and appm He) of the T91 tensile specimens irradiated to the highest fluence in SINQ target-3, which retained significant ductility as shown by the results of the tensile tests. Tensile data corresponding to the irradiation load of the hottest region are not available. However, the results of the tensile tests on He implanted specimens at 325°C, 1250 appm show that T91 still retains ductility. Although this concentration is somewhat lower than the 1690 appm expected after 9 months (implantation at 325°C, 2500 appm will be carried out shortly), one should add that the simulation experiments are performed with an implantation rate approximately 2 orders of magnitude higher than the He creation rate in the window. Therefore these experiments give “conservative “ informations as regards He effects on tensile properties, since the consequence of a higher creation rate is a higher bubble density and hence more pronounced hardening. Concerning the irradiation-induced degradation of impact properties and toughness, data is lacking, as mentioned above, in the temperature range of interest, both for irradiation in fission or spallation environments. Data in the relevant temperature range and irradiation load will be provided by impact tests to be performed on T91 and EM10 Charpy samples which have been irradiated in SINQ target-4. One point

¹¹ Horsten et al., Effects of radiations in Materials, 19th International Symposium, ASTM STP 1366 (2000) 579

however must be stressed here. The low value of the maximal stress in normal service conditions is obviously a favourable parameter, since it will lead to low stress intensity factors for existing defects, thus lowering the danger of sudden brittle failure. Low stress intensity factors are also favourable with respect to possible LME. Nevertheless, the existing data do not allow determining whether the materials properties will still be sufficient following nine months of irradiation for the window to operate safely. Based on the results of the tensile tests mentioned above, it is suggested not to exceed the dpa damage and He range reached in the specimens irradiated in Mark II, i.e. to limit the service time to 4-5 months. Once new results are available (He effects on tensile properties and DBTT, DBTT shift and toughness following irradiation at high dose at 330°C, LISOR outcomes, tensile and impact test results for the specimens irradiated in SINQ target-4) the possible service time will have to be reassessed.

5.2.2.2 Liquid Metal corrosion and mechanical behaviour

Corrosion in dynamic conditions

Concerning the evaluation of the corrosion resistance of the T91 steel in Pb-Bi a first estimation was performed taking into consideration the Pb-17Li experience gained in the Fusion Technology Programme¹³. Here the corrosion tests performed on martensitic steels are brought to a general equation, which is:

$$v = 8 \cdot 10^9 \exp(-25690/1.98T) V^{0.875} d^{-0.125}$$

where v is the corrosion rate in [$\mu\text{m}/\text{y}$]; T the temperature in [K]; V the velocity of the liquid metal [m/s] and d the hydraulic diameter [m]. This equation was extended to the MEGAPIE conditions and preliminary corrosion rates were calculated. For instance the corrosion rate calculated for a fixed tube diameter of 0.05 m a liquid metal velocity of 0.5 m/s and a temperature of 400 °C corresponds to 27 $\mu\text{m}/\text{y}$.

Dynamic Pb – Bi corrosion tests were performed with two different installations one located at CEA (CYCLAD) and one at ENEA (LECOR). The experiments were conducted in both cases in dynamic conditions but with different parameters. In the LECOR loop the T91 samples were corroded at 400 °C and with a flow velocity of the liquid metal of 1 m/s with a Re number in the test section of 10^4 . The oxygen concentration, which was measured with an electrochemical oxygen sensor placed in the test section of the loop, was about 10^{-10} wt. %. In these conditions, after 1500 h, a weight loss of the T91 steel was observed corresponding to a corrosion rate of 25 $\mu\text{m}/\text{y}$. The micrograph of the cross section of the specimen reported in figure 17 shows that the liquid metal corroded uniformly the steel surface. An estimation of the corrosion rate with the equation previously reported and using

¹² Y. Dai, KA Seminar, 31-01-2002, PSI

the LECOR parameters indicated a corrosion rate of 63 $\mu\text{m}/\text{y}$, demonstrating that the corrosion rate was initially overestimated.

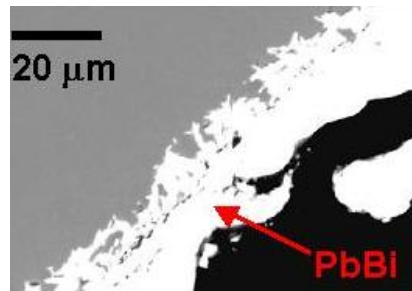

Figure 17: Taken from C. Fazio et. al., Preliminary results on the behaviour of T91 exposed in flowing Pb-Bi, MEGAPIE Technical Review Meeting, March 5 – 6, 2002, Bologna, Italy.

The CYCLAD testing conditions were: temperature in the test section 470 °C, the Pb-Bi velocities were 0.075 m/s for about 1200 h and 1.74 m/s for about 400 h the oxygen content estimated on the basis of measurements performed before and after test was 10^{-12} wt. %. In these conditions the T91 steel showed again a loss of weight (see also SEM- micrographs reported in figure 18) and a stream effect could be observed. The measured corrosion rates were: 1) 54 $\mu\text{m}/\text{y}$ on the upper sample placed downstream at 0.075 m/s and 18 $\mu\text{m}/\text{y}$ on the lower sample placed upstream. 2) at 1.74 m/s of flow rate the downstream (upper) sample exhibited a corrosion rate of 1290 $\mu\text{m}/\text{y}$ and the upstream (lower) sample showed a rate of 698 $\mu\text{m}/\text{y}$. Also for the CYCLAD experiment, the previously reported equation was used to calculate the corrosion rate and the estimated values were 38 $\mu\text{m}/\text{y}$ for the lower velocity of Pb-Bi and 612 $\mu\text{m}/\text{y}$ for the higher velocity of Pb-Bi. In the CYCLAD experiment a stream effect on the corrosion rate was observed, nevertheless it could be shown that the corrosion rate calculated with the Pb-17Li equation using the thermal and hydraulic characteristics of the CYCLAD loop did not reflect the real behaviour of the material in flowing Pb-Bi.

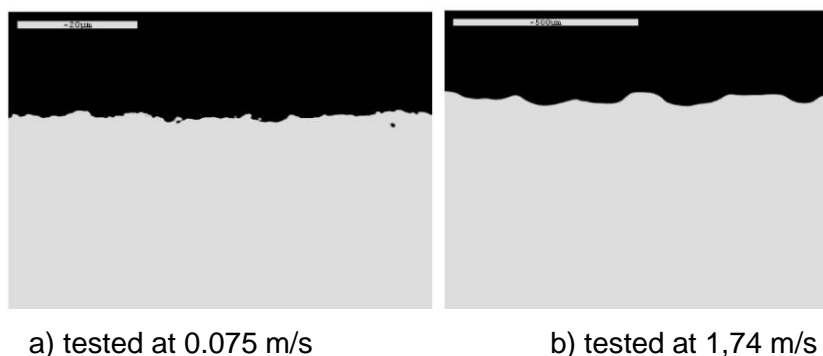

Figure 18: Taken from A. Terlain et. al., Corrosion of steels by Pb-Bi, MEGAPIE Technical Review Meeting, March 5 – 6, 2002, Bologna, Italy.

¹³ F. Barbier, Megapie Technical Meeting, Cadarache, June 1999.

5.2.2.3 Mechanical behaviour of Martensitic steel exposed to liquid Pb-Bi

Concerning the mechanical behaviour of the T91 steel when in contact with Pb-Bi, Liquid Metal Embrittlement (LME) tests as well as tensile tests on corroded specimens and stress corrosion tests were performed. Results of fatigue experiments are available only from the MANET II steel.

LME and tensile tests

The LME tests have shown that on T91 normal heat-treated steel no LME occurs, whilst on specimens hardened and notched LME was observed. Further, LME tests performed on only notched specimens with Ar-4% H_2 as cover gas has evidenced that H_2 could play a significant role to the steel embrittlement (see figure 19).

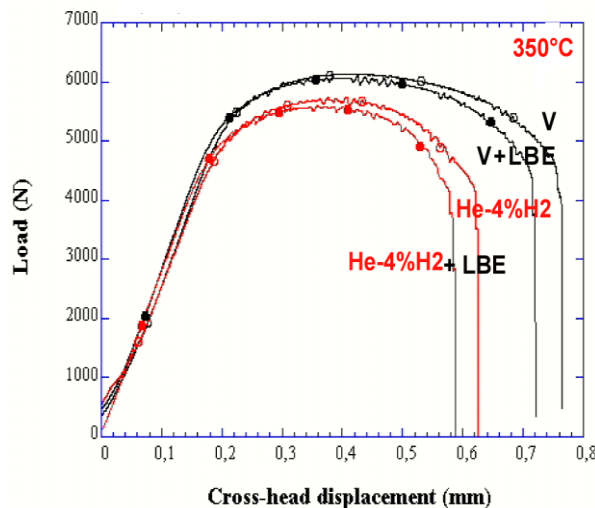

Figure 19: Taken from D. Gorse, 5th International Workshop on Spallation Materials Technologies, May 19 – 24, 2002, Charleston, South Carolina.

T91 steel tensile specimens were inserted in the test section of the LECOR loop and tested in the same conditions as reported previously. After 1500 h, the tensile specimens were extracted from the test section and tensile tested at 673 K. The tensile specimens exhibited a total elongation reduction and a decrease in the area reduction factor. As reported in figure 20, the fractography performed on those specimens, showed that the steel exhibited a mixed ductile – brittle fracture mode. It was assumed that these findings could be due to the Pb-Bi long-term exposition and the aggressiveness of the Bi. Tensile tests were also performed directly in the flowing liquid metal with the LISOR loop. In this case the steel used was the MANET II steel and also in this case it was observed that the ductility of the steel was

reduced at a testing temperature of 300 °C and again a mixed ductile – brittle fracture mode could be observed.

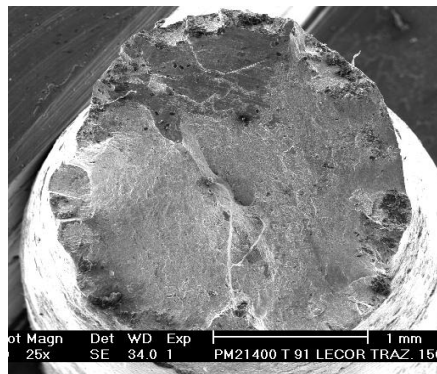

Figure 20: Taken from C. Fazio, Status of corrosion investigation, MEGAPIE-TEST Technical meeting, CEA/Saclay , June 25, 2002

Fatigue experiment in liquid metal

Fatigue tests in Pb-Bi were performed also on MANET steels. The tests were made in a strain-controlled mode at 260 °C. The strain amplitudes used were 0.2 – 0.3 – 0.5 – 0.7 and the frequency 1 Hz. Tests were performed both in air and in PbBi (stagnant). The results showed that the cycle number N_f is significant lower in the PbBi environment with respect to the air. The lifetime is reduced by factors of 2 up to 7. The crack propagation in PbBi is very fast compared to air¹⁴.

Even if fatigue tests on T91 steel as well as mechanical tests in flowing liquid metal with proton /neutron irradiation are not completed, some experimental evidence showed that there could be an effect due to the presence of Bi on the mechanical properties of the T91 steel reducing the mechanical performances of the steel. Further tests are needed to confirm this trend, and in addition the protection of the window materials could become relevant for MEGAPIE.

5.2.2.4 Corrosion protection

Since the oxygen control and monitoring methods, useful also for the in-situ oxidation, have been discarded for MEGAPIE (see next paragraph), artificial coatings instead to the back up solution could become the reference one. It has been also shown that aluminised coatings obtained via pack – cementation or GESA are very resistant in Pb-Bi even at high temperature (600°C), but as a drawback it seems that these techniques are not suitable to

¹⁴ D. Kalkhof, et. al., 5th International Workshop on Spallation Materials Technologies, May 19 – 24, 2002, Charleston, South Carolina.

coat the MEGAPIE window geometry. Alternative solutions could be TiN based coatings obtained via PVD or the DLC coating, but preliminary compatibility tests with Pb-Bi and in flowing Pb-Bi are mandatory.

5.2.3 Liquid metal technology

The activities performed in the frame of the liquid metal technology covers a wide range of disciplines and touches different parts of the MEGAPIE target and ancillary systems. The first results are hereafter listed:

5.2.3.1 Organic coolant and Water

The suggested diathermic fluid for the intermediate heat exchanger is based on partially hydrogenated terphenyls (THT), some properties are reported in table 3.

TABLE 3 Composition and Some Properties of Diphy-THT

Chemical composition	$M(C_{18}H_{14+2n}) = 230.3$ to 248.5 $n = 0$ to 9	Mainly mixture of part. hydrogenated terphenyls plus balance hydrogenated biphenyl and quaterphenyls
molecular mass	$M_{av_THT} \sim 240$	$M_{av_terphenyls} \sim 230$
Properties at 158°C		Supplementary data
Vapour pressure	3 mbar	62 mbar at 240°C 908 mbar at 350°C
Density	914 kg/m ³	
Heat Capacity	2.0 kJ/(kg*K)	0.15 kJ/(kg*K) for LBE at 300°C
Viscosity, dynamic	1.3 mPas	0.65 mPas for water at 40°C
Prandtl Nr	24.2	4.35 for water at 40°C
Sodium contents	< 1 ppm	It means negligible activation of THT under neutron irradiation
Pourpoint	- 33°C	
Boiling point, start	~ 352°C	
Self-ignition	380°C	

A literature review was made to evaluate the amount of radiolysis and the composition of the by-products of the THT in reactor conditions and under electron – irradiation. In this review it was argued that the decomposition of THT and the consequent production of high boiling products would be of no concern, when the MEGAPIE conditions are taken into account. In addition it has been discussed that concerning the gas generation, mainly hydrogen can be produced, as a consequence of THT decomposition and the produced hydrogen gas could be continuously absorbed, in-situ, with the CuO/CaO system.

Since water is the coolant in the safety hull of the target, a preliminary calculation with the MATINA code has been performed in order to evaluate the pressure increase due to the LBE/water interaction as a consequence of the three-wall rupture incident. The calculations

have shown that there are no concerns on pressurization. However, it is worth mentioning that the MATINA code has been developed for steam explosion, thus it is most suitable for higher temperatures and pressures. It can be advised that for the future LBE/water interaction experiments in MEGAPIE relevant conditions are worthwhile.

Electromagnetic Pump and flow meters

Preliminary tests were conducted on the prototype of the electromagnetic pump system developed at IPUL (Riga) for the MEGAPIE target. The main operational parameters of the EM prototype pump were: Maximum temperature, 520 °C; maximum LBE inflow temperature, 440 °C; maximum velocity in the EMP channel, 2 m/s. The EM pump was tested at IPUL in order to determine its flow rate – pressure drop performance, see figure 21, and its flow rate – voltage characteristics. Further tests performed on the EM pump in the temperature range 150 – 500 °C with a LBE flow < 10 l/s and a EMP pressure of 0.36 bar were completed in a satisfying way. The cavitation issue was treated as well with normal and reverse flow. In both cases no cavitation could be detected. In these tests the LBE flow rate was measured with an electromagnetic flow meter developed at IPUL and a HD flow meter (“inverted” Venturi tube). The EM flow meter was characterised as well and a calibration attempt was also done. However, it was shown that the accuracy of the electromagnetic flow meter was not acceptable due to high data dispersion and more tests are needed, see figure 22. Future activities foreseen are more tests with reverse flow for the cavitation topic and EM pump long-term performance tests at 450 °C.

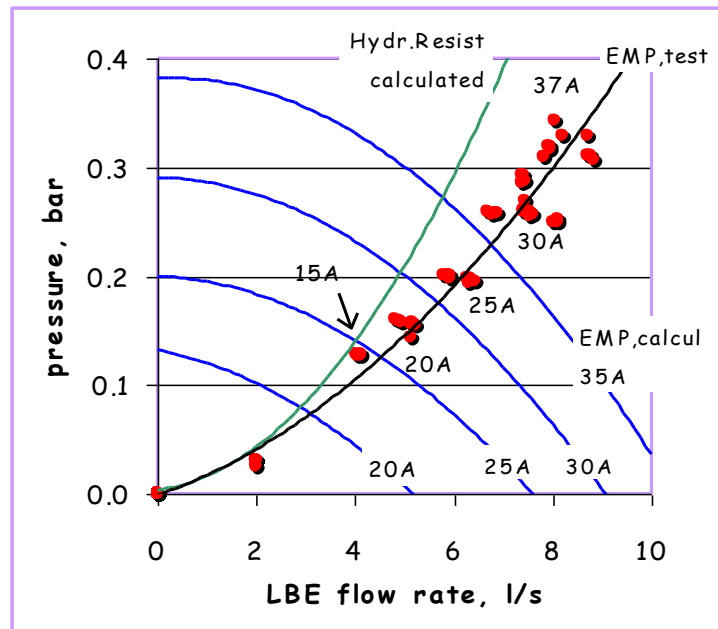

Figure 21: Taken from S.Dementjevet. al., Electromagnetic Pumps System Prototype LBE Test IPUL-June-July 2002, presented at the, PCG meeting, September 3, 2002, PSI Switzerland.

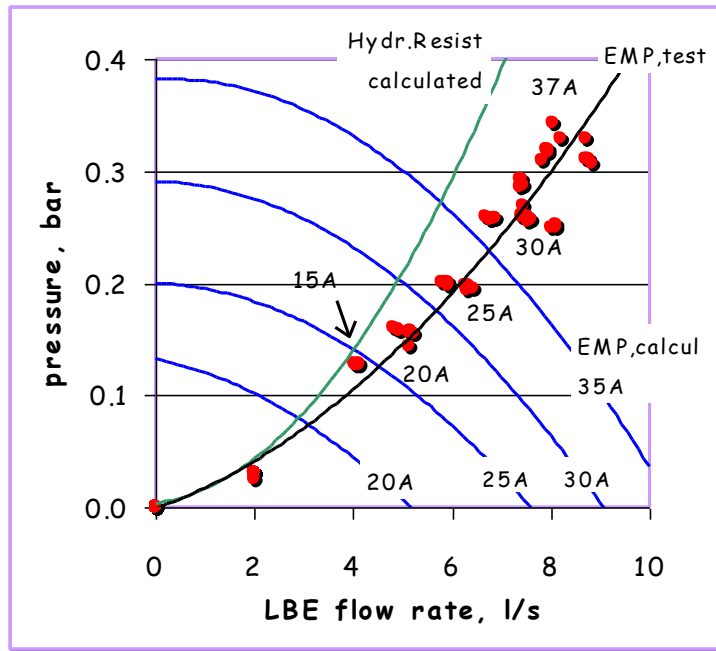

Figure 22: Taken from S.Dementjevet. al., Electromagnetic Pumps System Prototype LBE Test IPUL-June-July 2002, presented at the, PCG meeting, September 3, 2002, PSI Switzerland.

5.2.3.2 Oxygen control and monitoring in MEGAPIE

A large effort on the development of oxygen control and monitoring methods is being done worldwide. The reference oxygen monitoring method in Pb-Bi is an Electrochemical sensor constructed with Ytria stabilised Zirconia as solid electrolyte. Several types of sensors were developed and studies on suitable calibration methods as well as endurance tests are still ongoing. The current drawbacks of these sensors are mainly the signal instability, their high operation temperature (higher than 300 °C) and their resistance against thermal shock. In addition also oxygen control methods are studied and these are based on the addition of hydrogen – water mixture or separate addition of oxygen (or PbO) and hydrogen. The oxygen control and monitoring methods to be used for the “in situ” oxidation, thus the corrosion resistance enhancement of the steel are still under development. Further, as stated in the previous paragraph the alternative protection method, e.g. the artificial coating, for the structural materials, considered as a back – up solution could become as the reference one. In turn, the fill and drain procedure should be accurately evaluated also in term of oxygen control and monitoring, in order to avoid plugging problems.

5.2.3.3 Physical – chemical and metallurgical characterisation of Pb-Bi

A review on general thermodynamic and thermophysical properties of the binary eutectic alloy Pb-Bi, in the liquid state was prepared. The Pb-Bi phase diagram was discussed with particular references to liquidus curves and eutectic compositions as well as the thermophysical properties as volume mass, thermal capacity, dynamic viscosity, surface energy, vapour pressure, electrical and thermal conductivity were reported¹⁵.

Due to the perspective to freeze the liquid metal in the MEGAPIE target (considered as a lack of the heating system or for inactive fill and drain), attention was put on the ability of the solid Pb-Bi to expand after solidification, due to recrystallisation. Volume change rate¹⁶ and mechanical properties^{17,18} were measured and linked each other to calculate with structural mechanic tools the associated stress on the window and the target¹⁹. The volume change experiments, as reported in figure 23, showed that a volume increase starts immediately after solidification of the LBE and exhibited a steep phase during the first 30 min and then it grows gradually. The behaviour of the first phase is quite dependent on the testing temperature, at 35 °C, the volume increase, including the second phase, is very slow and after 20 hours the saturation value is not reached. On the other hand at 110 °C, the change is rather quick and easily reached to the saturation value.

The measured saturation value is about 1.2%. However, it was also experienced that this value may depend on the history of the procedure of solidification.

The Elastic modulus measured with compression tests on aged LBE was at 20 °C about 8 GPa and at 94 °C less than 3 GPa. As reported in figures 24 and 25, the yield stress measured at different strain rates exhibited at each temperature an increase with increasing the strain rate and at the same strain rate it decreased with increasing the temperature. Typical values of yield stress used, for the stress calculations are: 4 MPa (at 94 °C, for a strain rate of $1 \cdot 10^5$) and 1 MPa (at 112 °C for a strain rate of $1 \cdot 10^6$). Moreover, for the calculations it was assumed an isotropic volume expansion of the LBE and no slip (a perfect bond). A LBE layer-by-layer solidification was assumed in the target and the calculations showed that the LBE expansion could produce high stress both in the window and in the target. The stress level increases mainly with the height of solidified layer and the LBE yield stress. Both parameters, and consequently the stress level, can be controlled, in principle, by appropriate temperature control both in space (axial profile) and in time (cooling rate). For instance, with an LBE solid layer of 350 mm at 110 °C, the maximum Mises stress in the window is below 240 MPa (100 MPa on the beam axis). In addition it was shown that the

¹⁵ ENEA Report, DT-EUB-00001, 17.11.1999, ENEA – Bologna.

¹⁶ Y. Takeda, PSI Report, TM-87-02-01, 13.02.01.

¹⁷ Y. Dai, et. al., Megapie PCG meeting, Sept. 3, 2002, PSI, Switzerland.

¹⁸ P. Agostini et. al., ENEA - Report

¹⁹ A. Zucchini, MEGAPIE, PCG meeting, March 29, 2002, PSI, Switzerland.

solidification sequence, after the first layer, can still affect the final stress level in the window. It was thus suggested that the introduction of expansion cavities can reduce the maximum stresses in the target and in the window.

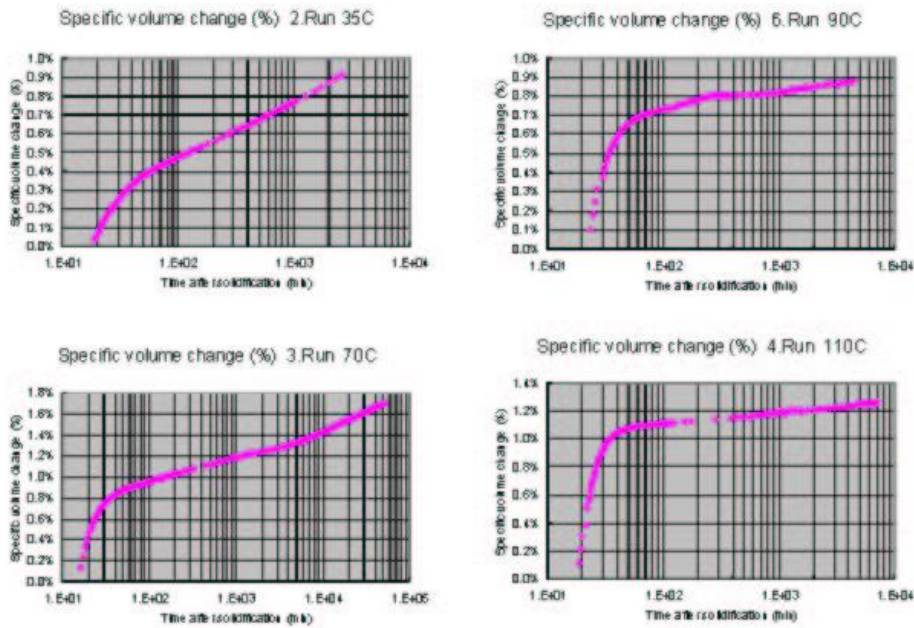

Figure 23: Taken from Y. Takeda, PSI Report, TM-87-02-01, 13.02.01.

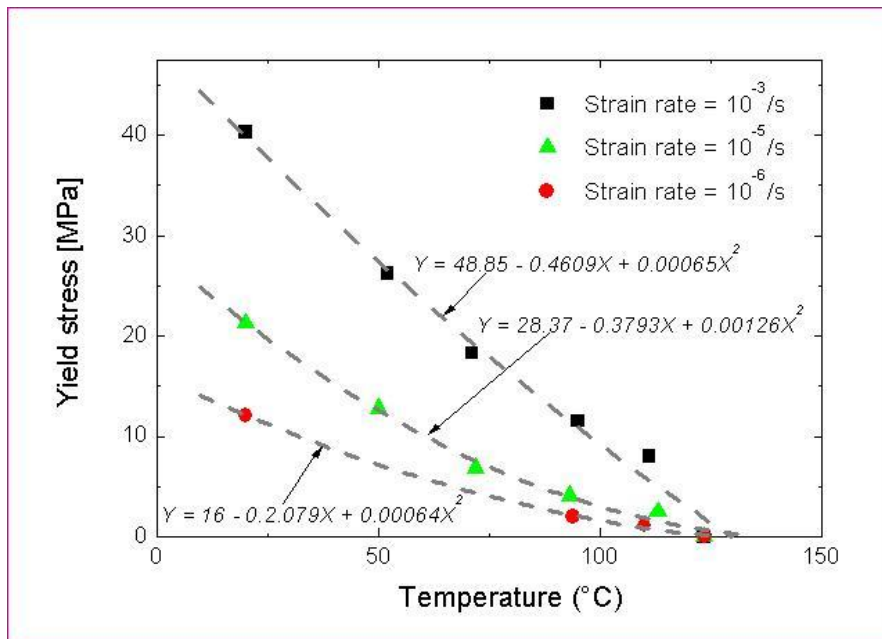

Figure 24: Taken from Y. Dai et. al., Compression Tests on PbBi at Different Temperatures and Strain-rates, Megapie PCG meeting, September 3, 2002, PSI, Switzerland.

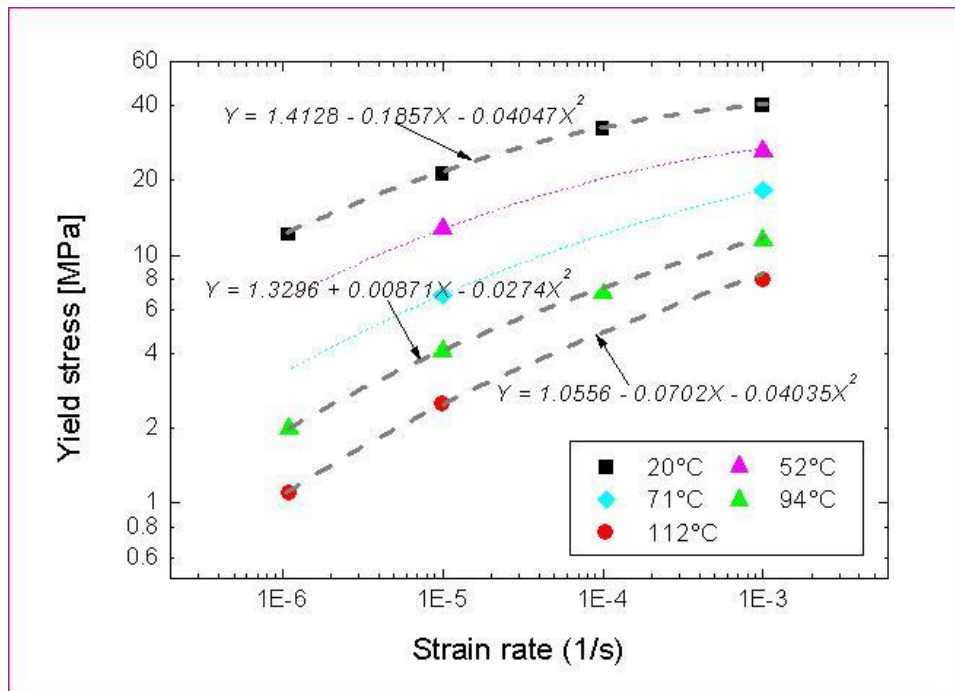

Figure 25: Taken from Y. Dai et. al., Compression Tests on PbBi at Different Temperatures and Strain-rates, Megapie PCG meeting, September 3, 2002, PSI, Switzerland.

5.2.4 Neutronic and Nuclear Assessment

The objective of Neutronics and Nuclear Assessment is to evaluate, by means of computational tools, neutron production, energy deposition, radiation damage levels, spallation and activation products, radiation level in the MEGAPIE target. A key action of this task is to compare and qualify neutronic models and codes on a full scale 1 MW spallation experiment. A Neutronic Benchmark to compare the numerical codes: SPARTE, MCNPX, FLUKA, LAHET, NMTC was also launched.

The main characteristic to be evaluated in the frame of the neutronic and nuclear assessment is the overall neutron source performance. However, beyond the evaluation of nuclide inventory and source terms, which are crucial for performances, design and material issues, the goals of this work package are also:

- to participate to the safety demonstration (radionuclide inventory);
- to give requirements and contribution for instrumentation and operation;
- to contribute to the qualification and development of nuclear data, spallation code and calculation schemes.

The first neutronic benchmark involved the associations CEA, PSI, ENEA, CNRS, JAERI and FZK and the codes used were SPARTE, MCNPX, FLUKA, LAHET, NMTC. The goal of the benchmark was to evaluate neutronic performances in a simplified cylindrical beam model

with the following characteristics: incident protons energy 575 MeV, total beam power 1 MW, current 1,74 mA. Each association used a given specification and different hypothesis. The output data were: heat deposition in Pb-Bi, heat deposition in the 316L guide tube and AlMg₃ tank wall, heat deposition in the T91, the Zircaloy and the AlMg₃ windows. The decay heat in Pb-Bi, in the 316L guide tube, in the T91, the Zircaloy and the AlMg₃ windows. Activation in Pb-Bi, in the 316L guide tube, in the T91, the Zircaloy and the AlMg₃ windows. Neutron currents and fluxes distribution, He and Hydrogen production and dpa in structural materials, spallation products yield in LBE, damages.

This first benchmark has provided a lot of numerical results showing however for some data large discrepancies amongst different codes. Although an assessment is still ongoing in order to clarify the origin of the differences, the obtained results allowed to get already a first rough indication on the neutronics of the MEGAPIE target.

Additional and more focalised calculations were performed with the FLUKA code taking into account the latest design parameters for the target and the newest beam profile (see figure 26). Concerning the power density, heat deposition and expected dpa values the results are the following :

- Max. current density in the center: 51.75 $\mu\text{A}/\text{cm}^2$
- Max. power deposition: 316 W/cm^3 for the AlMg₃ outer container shell of the lower target enclosure (322 W/cm^3 for the inner shell);
- Max. power deposition in the T91 liquid metal container: 860 W/cm^3 ;
- Max. power deposition in the D₂O: 155 W/cm^3 ;
- Max dpa rate: 19 dpa (T91) and 9 dpa (inner AlMg₃ shell)

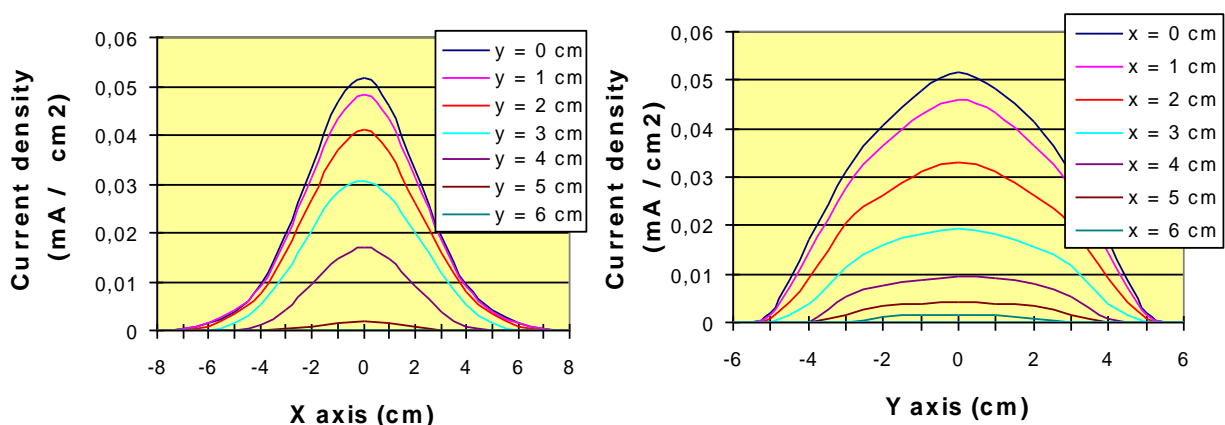

Figure 26: Updated beam profile (Rohrer beam profile): current density along the X and Y axis at different positions y and x respectively.

The project agreed on using the codes FLUKA and MCNPX for performing a final set of reference calculations on all the required parameters.

6 SAFETY AND RELIABILITY ASSESSMENT (Subtask 1.3)

The Preliminary Safety Analysis Report (PSAR) has been completed (in German) and is now on an internal PSI review round.

The main safety problems are due to the volatile radioactive spallation products in conjunction with supposed low probability accidents.

These are :

- The possible release of airborne activity due to a leakage from one of the first containments of radioactive gases, i.e. cover gas , insulation gas , or trapped gases of the fill and drain system, despite of the quality management. These systems have to be enclosed in second containments that will be kept at under pressure relative to that of the surrounding rooms, even in the case of a leakage.
- PSI wants to stay below the limits of radioactive emissions above which an emergency system is required. As a consequence, we will have to prove that the gas containments will stand the strongest possible earthquake at the PSI site.
- The main hazard to the Pb-Bi container within the target system is the rise in beam power density up to 20 fold in case of an unscattered proton beam or a error in beam setting. An independent detector coupled with a fast beam shut off will control the beam density right in front of the beam window.
- A plane crash followed by a kerosene fire had to be considered. The possible consequences can be kept within the limits mentioned above.

Today the PSAR is composed of the following chapters :

- Chapter 1 with some definitions (glossary) and basic informations (short description of the project and the installation, existing license; objective and justification of the project.
- Chapter 2 describes the existing SINQ installation.
- Chapter 3 gives a functionally description of the MEGAPIE installation and main components (Target system, material properties of the LBE and the spallation products, thermohydraulic and structural mechanics and the main ancillary systems).
- Chapter 4 presents the boundary conditions for radioactivity and radiation-protection at SINQ and the impact of the MEGAPIE operation.
- Chapter 5 summarises the incident and safety considerations (protection against intrusion form outside, incidents directly related to MEGAPIE, ...).
- Chapter 6 covers the surveillance and the waste management.

- Chapter 7 summarises the safety relevant organisation and
- Chapter 8 gives details on the quality management of the MEGAPIE project.

At a later stage of the project an English version of the PSAR will be available. Within the MEGAPIE-TEST project the deliverable D11 will directly deal with the safety aspects of the MEGAPIE Target.

7 LICENSING (Subtask 1.4)

The licensing process for the operation of the MEGAPIE target will be an iterative process with the corresponding Swiss authorities. Up to now the following steps have been undertaken for licensing:

- Informal pre-information of the Swiss relevant authority (BAG);
- Assessment of the PSAR by a PSI internal group of radioprotection, radiochemist, accelerator and licensing experts;

Formal request for licensing of MEGAPIE with submittal of PSAR was scheduled for mid-June 2002. The assessment of the PSAR by BAG, probably with the help of independent experts, will require more time than anticipated. The deliverable D12 is directly dedicated to this subtask.

8 CONCLUSION

In the present document we summarised the design status of the target and the corresponding main ancillary systems of the MEGAPIE spallation target. The design is accompanied by a strong effort in R&D activities where the available results have been discussed in this report.

For both, the target design and the R&D support activities, there will be a final deliverable report that will be issued at the end of the target design phase.

Within the MEGAPIE initiative and the MEGAPIE-TEST project we have for the first time engineers and designers working in close interaction with teams working on related design support and R&D activities. Although it is not evident to get both sides progressing in parallel an important progress has been achieved. Already today relevant information is available on the feed back for the future design of ADS spallation targets, as a preparation for the work to be done within WP 3 of the MEGAPIE-TEST project.