



Towards a Littlewood Richardson rule for Kac-Moody homogeneous spaces

Pierre-Emmanuel Chaput, Nicolas Perrin

► **To cite this version:**

Pierre-Emmanuel Chaput, Nicolas Perrin. Towards a Littlewood Richardson rule for Kac-Moody homogeneous spaces. *Journal of Lie Theory*, 2012. <hal-00358861>

HAL Id: hal-00358861

<https://hal.archives-ouvertes.fr/hal-00358861>

Submitted on 4 Feb 2009

HAL is a multi-disciplinary open access archive for the deposit and dissemination of scientific research documents, whether they are published or not. The documents may come from teaching and research institutions in France or abroad, or from public or private research centers.

L'archive ouverte pluridisciplinaire **HAL**, est destinée au dépôt et à la diffusion de documents scientifiques de niveau recherche, publiés ou non, émanant des établissements d'enseignement et de recherche français ou étrangers, des laboratoires publics ou privés.

Towards a Littlewood-Richardson rule for Kac-Moody homogeneous spaces

P.-E. Chaput, N. Perrin

February 4, 2009

Abstract

We prove a general combinatorial formula yielding the intersection number $c_{u,v}^w$ of three particular Λ -minuscule Schubert classes in any Kac-Moody homogeneous space, generalising the Littlewood-Richardson rule. The combinatorics are based on jeu de taquin rectification in a poset defined by the heap of w .

1 Introduction

Schubert calculus is an old important problem. Its main focus is the computation of the structure constants (the Littlewood-Richardson coefficients) in the cup product of Schubert classes in the cohomology of a homogeneous space. Schubert calculus is now well understood in many aspects (see for example [Bor53], [Dem74], [BeGeGe73], [Dua05]) but several problems remain open. In particular a combinatorial formula for the Littlewood-Richardson coefficients is not known in general. The most striking example of such a formula is the celebrated Littlewood-Richardson rule computing these coefficients for Grassmannian using jeu de taquin (see Section 2). This rule was conjectured by D.E. Littlewood and A.R. Richardson in [LiRi34] and proved by M.P. Schützenberger in [Sch77]. For a historical account, the reader may consult [VLe01]. Generalisation to minuscule and cominuscule homogeneous spaces of classical types were proved by D. Worley [Wor84] and P. Pragacz [Pra91]. Recently, this rule has been extended to exceptional minuscule homogeneous spaces by H. Thomas and A. Yong [ThYo08].

In this paper, we largely extend their rule to any homogeneous space X for certain cohomology classes called Λ -minuscule classes (see Definition 2.1). For X minuscule, any cohomology class is Λ -minuscule. We even prove this rule in many cases where the space X is homogeneous under a Kac-Moody group.

Let us be more precise and introduce some notation. Let G be a Kac-Moody group and let P be a parabolic subgroup of G . Let X be the homogeneous space G/P . A basis of the cohomology group $H^*(X, \mathbb{Z})$ is indexed by the set of minimal length representative W^P of the quotient W/W_P where W is the Weyl group of G and W_P the Weyl group of P . Let us denote with σ^w the Schubert class corresponding to $w \in W^P$. The Littlewood-Richardson coefficients are the constants $c_{u,v}^w$ defined for u and v in W^P by the formula:

$$\sigma^u \cup \sigma^v = \sum_{w \in W^P} c_{u,v}^w \sigma^w.$$

Key words: Littlewood-Richardson rule, Schubert calculus, Kac-Moody homogeneous spaces, jeu de taquin.
Mathematics Subject Classification: 14M15, 14N35

Let us denote with Λ the dominant weight associated to P . Following Dale Peterson, we define special elements in W^P called Λ -minuscule (see Definition 2.1). These elements have the nice property of being fully commutative: they admit a unique reduced expression up to commuting relations. In particular, they have a well defined heap which is a colored poset, the colors being simple roots (see Definition 2.2, this was first introduced by X. G. Viennot in [Vie86], we use J. Stembridge's definition in [Ste96], heaps were reintroduced in [Per07] as Schubert quivers). One of the major points we shall use here to define our combinatorial rule is the fact proved by R. Proctor [Pro04] that these heaps do have the jeu de taquin property (see Section 2). In particular, given two elements u and v in W smaller than a Λ -minuscule element w , we define combinatorially using jeu de taquin an integer $t_{u,v}^w$ (see Proposition 2.5). We make the following conjecture:

Conjecture 1.1 For w a Λ -minuscule element and u and v in W smaller than w , we have the equality $c_{u,v}^w = t_{u,v}^w$.

Following [ThYo08], we extend these considerations to Λ -cominuscule elements (see Definition 2.1) defined using Λ -minuscule elements in the Langlands dual group. Let $S(\Lambda)$ denote the set of roots α such that $\langle \Lambda, \alpha^\vee \rangle > 0$. Let w be a Λ -cominuscule element, if $w = s_{\alpha_1} \cdots s_{\alpha_l}$ is a reduced expression we define

$$m(w) := \prod_{\substack{i \in [1, l], \alpha \in S(\Lambda), \\ (\alpha, \alpha) > (\alpha_i, \alpha_i), i \geq (\alpha, 1)}} \frac{(\alpha, \alpha)}{(\alpha_i, \alpha_i)},$$

where (\cdot, \cdot) is any W -invariant scalar product and $(\alpha, 1)$ is the minimal element of the heap colored by α . This only depends on w and not on the choice of a reduced expression. Let u and v in W smaller than w , we denote with $m_{u,v}^w$ the number $m(w)/(m(u) \cdot m(v))$. If w is Λ -minuscule, the same definition gives $m_{u,v}^w = 1$, by Lemma 2.7. We extend the previous conjecture as follows:

Conjecture 1.2 For w a Λ -cominuscule element and u and v in W smaller than w , we have the equality $c_{u,v}^w = m_{u,v}^w t_{u,v}^w$.

Our inspiration in the work of H. Thomas and A. Yong is very clear with these conjectures. The first evidences for them are the Littlewood-Richarson rule (*i.e.* Conjecture 1.1 is true for X a Grassmannian) and the result of H. Thomas and A. Yong [ThYo08] proving that conjectures 1.1 and 1.2 are true for X a minuscule or a cominuscule homogeneous space. Our main result is a proof of these conjectures in many cases including all finite dimensional homogeneous spaces X . Indeed, we define for w a Λ -minuscule or Λ -cominuscule element of the Weyl group the condition of being slant-finite-dimensional (see Definition 3.1). This includes all Λ -minuscule or Λ -cominuscule elements in the Weyl group W of a finite dimensional group G . Our main result is the following:

Theorem 1.3 *Let G/P be a Kac-Moody homogeneous space where P corresponds to the dominant weight Λ . Let $u, v, w \in W$ be Λ -(co)minuscule. Assume that w is slant-finite-dimensional. Then we have $c_{u,v}^w = m_{u,v}^w t_{u,v}^w$.*

Let us observe here that we restrict the statement to slant-finite dimensional elements essentially for technical reasons: this simplifies a lot the combinatorics involved and allows us to find easily generators of the cohomology algebra.

The strategy of proof is very similar to the one of H. Thomas and A. Yong but we add two powerful ingredients: first we prove *a priori* that jeu de taquin numbers $t_{u,v}^w$ as well as modified jeu de taquin numbers $m_{u,v}^w t_{u,v}^w$ define a commutative and associative algebra (see Subsection 2.7). As an example of the strength of this fact, we will reprove that in classical (co)minuscule homogeneous

spaces the modified jeu de taquin coefficients are equal to the intersection numbers, assuming that only very few intersection numbers are known. For example, to reprove the case of Grassmannians we only need to assume that we know the cohomology ring of the 4-dimensional Grassmannian $G(2,4)$: see Lemma 4.2. We believe that this was not possible without this fact only with the arguments of H. Thomas and A. Yong. Our main use of this result relies on the fact that we will only need to prove Conjectures 1.1 and 1.2 for a system of generators of the cohomology.

Another powerful tool is the decomposition of any Λ -minuscule element into a product of so-called slant-irreducible elements and the classification, by Proctor and Stembridge, of the irreducible ones. We are thus able to reduce the proof of Theorem 1.3 to the classical cases plus a finite number of exceptional ones: see Subsection 3.4.

To prove theorem 1.3 we need two more ingredients already contained in [ThYo08]: the fact that our rule is compatible with the Chevalley formula and a Kac-Moody recursion which enables to boil the computation of certain Littlewood-Richardson coefficients down to the computation of other Littlewood-Richardson coefficients in a smaller group. This idea of recursion was contained in the work of H. Thomas and A. Yong [ThYo08], however we had to adapt their proof in the general Kac-Moody situation. This is done in Subsection 2.5.

Before describing in more details the sections in this article, let us remark that, even if Λ -(co)minuscule elements may be rare in certain homogeneous spaces, our result can be applied to compute an explicit presentation of the cohomology ring of adjoint varieties and thus to compute all their Littlewood-Richardson coefficients. This will be done in a subsequent work [ChPe09].

In Section 2, we define Λ -minuscule and Λ -cominuscule elements and the combinatorial invariants $t_{u,v}^w$ and $m_{u,v}^w$. We state our main conjecture. We prove that this conjecture is compatible with the Chevalley formula and define an associative and commutative algebra using these combinatorial invariants. We also define the notion of Bruhat recursion and prove that the Littlewood-Richardson coefficients $c_{u,v}^w$ satisfy Bruhat recursion. In Section 3, we define the notion of slant-finite-dimensional elements and state our main result. We explain our strategy to prove Theorem 1.3. We prove several lemmas implying that the two products (the cup product and the combinatorial product) are equal. In Section 4, we prove by a case by case analysis that Theorem 1.3 holds for simply laced Kac-Moody groups. In type A , Lemma 4.2 gives a very short proof (using the fact that our combinatorial product is commutative and associative) of the classical Littlewood-Richardson rule. In Section 5, we explain how, using foldings, we can deduce Theorem 1.3 in the non simply laced cases, using the simply laced case. We will need in particular to make involved computations to deal with a single coefficient in one case related to F_4 .

Acknowledgement: We would like to thank Gérald Gaudens and Antoine Touzé for discussions about topology of infinite dimensional spaces. Both authors are thankful to the Max-Planck Institut for providing ideal research conditions, and Pierre-Emmanuel Chaput thanks the Nantes university for giving a special funding.

Convention: We work over an algebraically closed field of characteristic zero. We will use several times the notation in [Bou54] especially for labelling the simple roots of a semisimple Lie algebra.

Contents

1	Introduction	1
2	Jeu de taquin	4

2.1	The jeu de taquin property	4
2.2	Jeu de taquin poset associated with a Λ -(co)minuscule element	4
2.3	Conjecture on a general Littlewood-Richardson rule	6
2.4	Chevalley formula in the (co)minuscule case	7
2.5	Recursions	8
2.5.1	Homogeneous subspaces	8
2.5.2	Bruhat and taquin recursions	9
2.5.3	A Λ -(co)minuscule element defines a Bruhat recursion	11
2.6	System of posets associated with a dominant weight	13
2.7	Algebra associated with a system of posets having the jeu de taquin property	13
3	Main result and strategy for the proof	15
3.1	Statement of the main result	15
3.2	Definition of some systems of posets	16
3.3	Reduction to indecomposable posets	17
3.4	Strategy for the proof of the main Theorem	22
4	Simply laced case	22
4.1	Generators for the cohomology	22
4.2	Quadrics	23
4.3	Type A_n	24
4.4	Type D_n	25
4.5	Type E_6 case	26
4.6	Type E_7 case	27
4.7	Type E_8 case	31
5	Non simply-laced case	35
5.1	General results for the push-forward of a minuscule class	35
5.2	Type B_n case	37
5.3	Type F_4 minuscule case	38
5.4	General result for Λ -cominuscule classes	38
5.5	Type C_n case	41
5.6	Type F_4 cominuscule case	42
5.6.1	Foldings with F_4	43
5.6.2	Proof for F_4	48

2 Jeu de taquin

2.1 The jeu de taquin property

Jeu de taquin is a combinatorial game encoding all Schubert intersection numbers for (co)minuscule varieties, as it was shown by H. Thomas and A. Yong in [ThYo08]. For the convenience of the reader we recall their definition of the jeu de taquin. Let P be a poset which we assume to be *bounded below*, meaning that for any $x \in P$ the set $\{y : y \leq x\}$ is finite. Elements of P will be called boxes. Recall that a subset λ of a poset P is an order ideal if for $x \in \lambda$ and $y \in P$ we have the implication ($y \leq x \Rightarrow y \in \lambda$). We denote with $I(P)$ the set of finite order ideals of P . For $\lambda \subset \nu$ two finite order ideals in P we denote with ν/λ the pair (λ, ν) . Any such pair is called a skew shape. A standard tableau T of skew shape ν/λ is an increasing bijective map $(\nu - \lambda) \rightarrow [1, d]$, where d is the cardinal of the set theoretic difference $(\nu - \lambda)$.

Consider $x \in \lambda$ and maximal in λ among the elements that are below some element of $(\nu - \lambda)$. We associate another standard tableau $j_x(T)$ (of a different skew shape) arising from T : let y be the box of $(\nu - \lambda)$ with the smallest label, among those that cover x . Move the label of the box y to x , leaving y vacant. Look for the smallest label of $(\nu - \lambda)$ that covers y and repeat the process. The tableau $j_x(T)$ is outputted when no more such moves are possible. A rectification of T is the result of an iteration of jeu de taquin slides until we terminate at a standard tableau which shape is an order ideal. By the assumption that P is bounded below this will occur after a finite number of slides.

According to Proctor [Pro04], we will say that P has the *jeu de taquin property* if the rectification of any tableau does not depend on the choices of the empty boxes used to perform jeu de taquin slides.

2.2 Jeu de taquin poset associated with a Λ -(co)minuscule element

Let us first recall some results of Proctor and Stembridge. Let A be a symmetrisable matrix, G be the associated symmetrisable Kac-Moody group and let $(\varpi_i)_{i \in I}$ be the set of fundamental weights. Let W be the Weyl group of A with generators denoted with s_i . Note that W acts on the root system $R(A)$ of A , and since the Weyl group of the dual root system $R(\check{A})$ is isomorphic with W in a canonical way, W also acts on $R(\check{A})$. The fundamental weights of $R(\check{A})$ will be denoted with ϖ_i^\vee . According to Dale Peterson [Pro99a, p.273] we give the following definition:

Definition 2.1 Let $\Lambda = \sum_i \Lambda_i \varpi_i$ be a dominant weight.

- An element $w \in W$ is Λ -minuscule if there exists a reduced decomposition $w = s_{i_1} \cdots s_{i_l}$ such that for any $k \in [1, l]$ we have $s_{i_k} s_{i_{k+1}} \cdots s_{i_l}(\Lambda) = s_{i_{k+1}} \cdots s_{i_l}(\Lambda) - \alpha_{i_k}$.
- w is Λ -cominuscule if w is $(\sum \Lambda_i \varpi_i^\vee)$ -minuscule.
- We will write that w is Λ -(co)minuscule when we mean that w is either Λ -minuscule or Λ -cominuscule. We denote with W_m the set of all Λ -(co)minuscule elements of W .
- w is fully commutative if all the reduced expressions of w can be deduced one from the other using commutation relations.

By [Ste96, Proposition 2.1], any Λ -minuscule element is fully commutative. Since the property of being fully commutative depends on W only, and not on the underlying root system, Λ -cominuscule elements are also fully commutative. Moreover Stembridge shows that if the above condition, defining Λ -minuscule elements, holds for one reduced expression $w = s_{i_1} \cdots s_{i_l}$, then it holds for any reduced expression of w .

For the convenience of the reader we recall the definition of the heap of w given by Stembridge [Ste96] (except that we reverse the order):

Definition 2.2 Let $w \in W$ be fully commutative and let $w = s_{i_1} \cdots s_{i_l}$ be a reduced expression. The heap $H(w)$ of w is the set $[1, l]$ ordered by the transitive closure of the relations “ p is smaller than q ” if $p > q$ and s_{i_p} and s_{i_q} do not commute.

As Stembridge explains, the full commutativity implies that the heap is well-defined up to isomorphisms of posets. Moreover he shows the following (he shows this for Λ -minuscule elements, the statement for Λ -cominuscule elements follows because the statement only depends on the Weyl group):

Proposition 2.3 *Let w be Λ -(co)minuscule. There is an order-preserving bijection between the set of order ideals of $H(w)$ and the Bruhat interval $[e, w]$.*

The bijection maps an ideal $\lambda = \{n_1, \dots, n_k\}$ to the element $u = s_{n_1} \cdots s_{n_k}$.

Proposition 2.4 *Let $w \in W$ be Λ -(co)minuscule. The poset $H(w)$ has the jeu de taquin property.*

Proof. If w is Λ -minuscule, by [Ste96, Corollary 4.3], $H(w)$ is a d -complete poset (the precise definition of d -completeness is given in [Pro99a, Section 3]). By [Pro04, Theorem 5.1], any d -complete poset has the jeu de taquin property, proving the proposition. Since the definition of the heap $H(w)$ does not involve the root system, the same property holds for w a Λ -cominuscule element. \square

Proposition 2.5 *Let $w \in W$ be Λ -(co)minuscule and let λ, μ, ν be order ideals in $H(w)$. Then the number of tableaux of shape ν/λ which rectify on a standard tableau U of shape μ does not depend on the given standard tableau U of shape μ . Denote with $t_{\lambda, \mu}^{\nu}(W)$ this number: we have $t_{\lambda, \mu}^{\nu}(W) = t_{\mu, \lambda}^{\nu}(W)$.*

When W will be clear from the context, the notation $t_{\lambda, \mu}^{\nu}(W)$ will be simplified to $t_{\lambda, \mu}^{\nu}$.

Proof. In [ThYo08, Section 4], the authors study properties of the jeu de taquin on so-called (co)minuscule posets, which are a very special class of posets with the jeu de taquin property. In fact they use two main properties of these posets, namely the jeu de taquin property and the fact that there is a decreasing involution on these posets. However, this involution is used only for results involving the Poincaré duality. As one readily checks, Proposition 4.2(b-c), Theorem 4.4, its Corollary 4.5 and the first equality of Corollary 4.6 are still true for any poset enjoying the jeu de taquin property. The last two statements are the two claims of the proposition. \square

Remark 2.6 As the proof shows, a similar result holds for any poset having the jeu de taquin property.

We now prove an easy combinatorial lemma for Λ -(co)minuscule elements.

Lemma 2.7 *Let Λ be a fundamental weight with corresponding simple root α_{Λ} . Let $w = s_{\alpha_1} \cdots s_{\alpha_l}$ a reduced expression of an element in W . Let $i \in [1, l]$. If w is Λ -minuscule then the root α_i cannot be shorter than α_{Λ} , and if w is Λ -cominuscule then α_i cannot be longer than α_{Λ} .*

Proof. It is enough to consider the case when w is Λ -minuscule. Write $w = s_{\alpha_1} \cdots s_{\alpha_l}$ and assume on the contrary that there exists an integer i such that $(\alpha_i, \alpha_i) < (\alpha_{\Lambda}, \alpha_{\Lambda})$. Let then i_0 be the maximal such integer. Since $\langle \Lambda, \alpha_{i_0} \rangle = 0$ (in fact Λ is fundamental and $\alpha_{i_0} \neq \alpha_{\Lambda}$), we have $1 = \langle s_{i_0+1} \cdots s_l(\Lambda), \alpha_{i_0}^{\vee} \rangle = -\sum_{i>i_0} \langle \alpha_i, \alpha_{i_0}^{\vee} \rangle$, so there exists $i > i_0$ such that $\langle \alpha_i, \alpha_{i_0}^{\vee} \rangle < 0$. Since α_{i_0} is shorter than α_i we have $\langle \alpha_i, \alpha_{i_0}^{\vee} \rangle < -1$. Furthermore, for any $j > i_0$, we have the inequalities $(\alpha_{i_0}, \alpha_{i_0}) < (\alpha_{\Lambda}, \alpha_{\Lambda}) \leq (\alpha_j, \alpha_j)$ thus $\alpha_j \neq \alpha_{i_0}$ and $\langle \alpha_j, \alpha_{i_0}^{\vee} \rangle \leq 0$. This contradicts the above equality $\sum_{i>i_0} \langle \alpha_i, \alpha_{i_0}^{\vee} \rangle = -1$. \square

Remark 2.8 Let w be a Λ -(co)minuscule element and let D be the subdiagram of the Dynkin diagram made of simple roots appearing in a reduced expression of w . Let A be the generalised Cartan matrix associated to D , then with arguments similar to those in the previous lemma one can show that: for any couple $i < j$, if $a_{i,j} \neq 0$, then one of the equalities $a_{i,j} = -1$ or $a_{j,i} = -1$ holds.

We now recall some notation of [Pro99b] and [Ste96], and introduce some new ones. If D is a marked diagram and $d \in D$, then we say that (D, d) is a marked diagram. A D -colored poset is the data of a poset P and a map $c : P \rightarrow D$ satisfying the condition: if $s_{c(i)}s_{c(j)} \neq s_{c(j)}s_{c(i)}$, then $i \leq j$ or $j \leq i$ in P . To such a poset is associated an element w of the Weyl group of D defined by $w = \prod_{p \in P} s_{c(p)}$, where the order in this product is any order compatible with the partial order in P . We say that P is d -**(co)minuscule** if w is Λ -(co)minuscule for Λ the fundamental weight corresponding to d . In the sequel, we shall assume that the element w corresponding to the poset P is Λ -(co)minuscule.

If P is a D -colored poset with coloring function $c : P \rightarrow D$, $\alpha \in D$ and i is an integer, we denote with $(\alpha, i) \in P$ the unique element p , if it exists, such that $c(p) = \alpha$ and such that $\#\{q \leq p : c(q) = \alpha\} = i$. In particular, for each α in $c(P)$, $(\alpha, 1) \in P$ is the minimal element colored by α . The set of all elements of the form $(\alpha, 1)$ is an ideal in P called the **rooted tree** of P and denoted with T . The map $\alpha \mapsto (\alpha, 1)$ establishes a bijection from $c(P)$ to T which is a poset, thus yielding a partial order on $c(P)$. We say that P is **slant-irreducible** if each color in $c(P)$ which is non maximal with respect to this order is the color of at least two elements in P . In [Pro99b] and [Ste01], the D -colored slant-irreducible d -minuscule posets are classified for any marked Dynkin diagram (D, d) .

If $(p_i)_{i \in [1, k]}$ are elements of a poset P , we denote with $\langle (p_i)_{i \in [1, k]} \rangle$ the ideal generated by $(p_i)_{i \in [1, k]}$.

2.3 Conjecture on a general Littlewood-Richardson rule

We now are in position to state a conjecture relating the Schubert calculus and the jeu de taquin. Let Λ be a dominant weight. Let $X = G/P$ be the homogeneous space corresponding to Λ , W_P be the Weyl group of P , and W^P the set of minimum length representatives of the coset W/W_P . Let $(\sigma^w)_{w \in W^P}$ denote the basis of the cohomology of G/P dual to the Schubert basis in homology (see [Kum02, Proposition 11.3.2]). We denote with $c_{u,v}^w$ the integer coefficients such that $\sigma^u \cup \sigma^v = \sum c_{u,v}^w \sigma^w$. Note the following:

Fact 2.9 *If $w \in W$ is Λ -(co)minuscule then $w \in W^P$.*

Proof. We may assume that w is Λ -minuscule. Write a length additive expression $w = vp$ with $v \in W^P$ and $p \in W_P$. By [Ste96, Proposition 2.1] any reduced expression of a Λ -minuscule element satisfies the condition of Definition 2.1, thus $p(\Lambda) = \Lambda$ implies $p = e$; thus $w \in W^P$. \square

On the other hand, let $w \in W$ be Λ -(co)minuscule and $u, v \in W$ be less or equal to w . To u and v we can associate order ideals $\lambda(u), \lambda(v)$ of the poset $H(w)$ of w by Proposition 2.3. Recall the definition of $t_{\lambda(u), \lambda(v)}^{H(w)}$ in Proposition 2.5; this number will be denoted just with $t_{u,v}^w$.

Let $S(\Lambda)$ denote the set of roots α such that $\langle \Lambda, \alpha^\vee \rangle > 0$. If $u = s_{\alpha_1} \cdots s_{\alpha_l}$ is a reduced expression we define

$$m(u) := \prod_{\substack{i \in [1, l], \alpha \in S(\Lambda), \\ (\alpha, \alpha) > (\alpha_i, \alpha_i), i \geq (\alpha, 1)}} \frac{(\alpha, \alpha)}{(\alpha_i, \alpha_i)},$$

where (\cdot, \cdot) is any W -invariant scalar product. Let $u, v \leq w \in W$, we denote with $m_{u,v}^w$ the number $m(w)/(m(u) \cdot m(v))$.

Conjecture 2.10 *Let $w \in W$ be Λ -(co)minuscule and $u, v \in W$ with $u, v \leq w$. Then the Schubert intersection number $c_{u,v}^w$ is equal to the jeu de taquin combinatorial number $m_{u,v}^w \cdot t_{u,v}^w$.*

By [ThYo08] this conjecture holds for G/P a (co)minuscule homogeneous space and Theorem 3.2 proves it when G/P is a finite dimensional homogeneous space. Our strategy of proof is essentially the same as in [ThYo08]: we argue that the numbers $c_{u,v}^w$ and $m_{u,v}^w \cdot t_{u,v}^w$ both satisfy some recursive identities (this holds for any G/P), and then we check in the particular case of finite dimensional varieties that these identities together with a few number of equalities $c_{u,v}^w = m_{u,v}^w \cdot t_{u,v}^w$ imply the theorem. The recursive identities are:

- The numbers $m_{u,v}^w \cdot t_{u,v}^w$ satisfy the same identity as the identity on the numbers $c_{u,v}^w$ implied by the Chevalley formula: see Subsection 2.4.
- A Kac-Moody recursion which is a general procedure drawing down the computation of some numbers $c_{u,v}^w$ (resp. $t_{u,v}^w$) for G/P to the computation of the similar numbers for a quotient H/Q with H a Levi subgroup of G : see Subsection 2.5.
- Jeu de taquin defines a natural algebra with basis indexed by all Λ -(co)minuscule elements which is commutative and associative (and will turn out to be, once the theorem is proved, isomorphic with a quotient of $H^*(G/P)$): see Subsection 2.7.

The last point was not used in [ThYo08]. We will see that it simplifies a lot our argument, since it implies that to prove the theorem it is enough to show some Pieri formulas. The statement corresponding to the Chevalley formula is well-known; we prove the two other fundamental results in the general context of Kac-Moody groups.

2.4 Chevalley formula in the (co)minuscule case

Let $w \in W$ and $i \in I$ such that $l(s_{\alpha_i} w) = l(w) + 1$. We denote with $m(w, i)$ the integer $(\alpha_\Lambda, \alpha_\Lambda) / (\alpha_i, \alpha_i)$ if $(\alpha_\Lambda, \alpha_\Lambda) > (\alpha_i, \alpha_i)$ and $m(w, i) = 1$ otherwise.

Proposition 2.11 *If $s_{\alpha_i} w$ is length additive and Λ -(co)minuscule, then the coefficient of the class $\sigma^{s_{\alpha_i} w}$ in the product $\sigma^w \cup \sigma^{s_{\alpha_\Lambda}}$ is $m(w, i)$.*

Thus, Conjecture 2.10 is true when u or v has length one.

Proof. Recall the Chevalley formula

$$\sigma^{s_{\alpha_\Lambda}} \cup \sigma^w = \sum_{\alpha: l(s_{\alpha} w) = l(w) + 1} \langle w(\Lambda), \alpha^\vee \rangle \sigma^{s_{\alpha} w}.$$

This follows from [Kum02, Theorem 11.1.7(i) and Remark 11.3.18]. We only want to compute the coefficient of $\sigma^{s_{\alpha_i} w}$ in $\sigma^{s_{\alpha_\Lambda}} \cup \sigma^w$ for $s_{\alpha_i} w$ a Λ -(co)minuscule element thus we may in the sequel assume that α is simple (this comes from the fact that weak and strong Bruhat order coincide for Λ -(co)minuscule elements).

Assume first that $s_{\alpha} w$ is Λ -minuscule. This means by definition that $\langle w(\Lambda), \alpha^\vee \rangle = 1$. Thus we only have to prove that $(\alpha_\Lambda, \alpha_\Lambda) \leq (\alpha, \alpha)$. This follows from Lemma 2.7.

Assume now that $s_{\alpha} w$ is Λ -cominuscule. This means that $\langle \alpha, w(\Lambda^\vee) \rangle = 1$, and therefore $\langle w^{-1}(\alpha), \Lambda^\vee \rangle = 1$. By the following Lemma 2.12 we have $\langle \Lambda, w^{-1}(\alpha^\vee) \rangle = (\alpha_\Lambda, \alpha_\Lambda) / (\alpha, \alpha)$. Since $s_{\alpha} w$ is Λ -cominuscule, by Lemma 2.7 the root α cannot be longer than α_Λ so this integer is $m(w, i)$ and the proposition is proved. \square

Lemma 2.12 *Let α, β be simple roots and $w \in W$. Then*

$$\langle w(\alpha), \varpi_\beta^\vee \rangle \cdot (\beta, \beta) = \langle \varpi_\beta, w(\alpha^\vee) \rangle \cdot (\alpha, \alpha).$$

Proof. We prove this by induction on the length of w . If $w = e$, then both members of the equality equal $\langle \alpha, \alpha \rangle$ if $\alpha = \beta$ and 0 otherwise. Assume that

$$\langle w(\alpha), \varpi_\beta^\vee \rangle \cdot (\beta, \beta) = \langle \varpi_\beta, w(\alpha^\vee) \rangle \cdot (\alpha, \alpha).$$

and let γ be a simple root. Since $\langle \varpi_\beta, \gamma^\vee \rangle$ (resp. $\langle \gamma, \varpi_\beta^\vee \rangle$) is by definition the coefficient of β^\vee (resp. β) in γ^\vee (resp. γ), these coefficients are 1 if $\gamma = \beta$ and 0 otherwise. If $\gamma \neq \beta$, then $\langle s_\gamma w(\alpha), \varpi_\beta^\vee \rangle = \langle w(\alpha), \varpi_\beta^\vee \rangle$ and $\langle \varpi_\beta, s_\gamma w(\alpha^\vee) \rangle = \langle \varpi_\beta, w(\alpha^\vee) \rangle$, so the lemma is still true for $s_\gamma w$. Moreover $\langle s_\beta w(\alpha), \varpi_\beta^\vee \rangle = \langle w(\alpha), \varpi_\beta^\vee \rangle - \langle w(\alpha), \beta^\vee \rangle$ and $\langle \varpi_\beta, s_\beta w(\alpha^\vee) \rangle = \langle \varpi_\beta, w(\alpha^\vee) \rangle - \langle \beta, w(\alpha^\vee) \rangle$. Since $\langle w(\alpha), \beta^\vee \rangle \cdot (\beta, \beta) = \langle \beta, w(\alpha^\vee) \rangle \cdot (\alpha, \alpha) = \langle \alpha, \beta \rangle$, the lemma is again true for $s_\beta \cdot w$. \square

2.5 Recursions

Let us now introduce the notion of recursion, which is our essential inductive argument, and was introduced in [ThYo08].

2.5.1 Homogeneous subspaces

Let $G_1 \subset G_2$ be an inclusion of Kac-Moody groups defined by an inclusion of their Dynkin diagrams (in particular we have an inclusion of the maximal torus T_1 of G_1 in the maximal torus T_2 of G_2). Let Λ_2 be a dominant weight for G_2 and Λ_1 its restriction to T_1 . We have an inclusion of the corresponding Weyl groups $W_1 \subset W_2$ and of the homogeneous spaces $G_1/P_1 \subset G_2/P_2$ where P_i is associated to Λ_i for $i \in \{1, 2\}$.

Proposition 2.13 *With the above notation, let u, v and w be elements in W_1 such that $u, v \leq w$. Assume that w is Λ_1 -(co)minuscule. We have $c_{u,v}^w(G_1/P_1) = c_{u,v}^w(G_2/P_2)$. Moreover we have $t_{u,v}^w(W_1)m_{u,v}^w(W_1) = t_{u,v}^w(W_2)m_{u,v}^w(W_2)$.*

Proof. The claim for the coefficients t and m follows from the fact that the heap of w does not depend on whether we consider w as an element of W_1 or W_2 .

Let $i : G_1/P_1 \rightarrow G_2/P_2$ denote the natural inclusion. Observe that w (and thus also u and v) is Λ_2 -(co)minuscule. To prove the proposition it is enough to use the fact i^* preserves the cup product: in fact, we have the equality $i^*(\sigma^u(G_2/P_2)) = \sigma^u(G_1/P_1)$, and thus the equality $i^*(\sigma^u(G_2/P_2) \cup \sigma^v(G_2/P_2)) = \sigma^u(G_1/P_1) \cup \sigma^v(G_1/P_1)$ holds. Expanding these products with the coefficients $c_{u,v}^w$ yields the result. \square

Using this proposition, we see that that the coefficients $c_{u,v}^w(G/P)$ resp. $t_{u,v}^w(W)$ do not depend on G/P resp. W , allowing us to simplify the notation into $c_{u,v}^w$ resp. $t_{u,v}^w$.

Corollary 2.14 *If Conjecture 2.10 holds when P is a maximal parabolic subgroup, then it holds in general.*

Proof. Let $u, v, w \in W$ and assume w is Λ -(co)minuscule. Write $\Lambda = \sum \Lambda_i \varpi_i$, with ϖ_i the fundamental weights. Let $S(\Lambda) \subset S$ be the set of indices i such that $\Lambda_i > 0$. By [Pro99b, Proposition page 65] we can write w as a commutative product $w = \prod_{i \in S(\Lambda)} w_i$ where the supports of all the w_i 's are disjoint and $i \in \text{Supp}(w_i)$. In the same way we write $u = \prod_{i \in S(\Lambda)} u_i$ and $v = \prod_{i \in S(\Lambda)} v_i$. It follows that $m(w) = \prod m(w_i)$, that $m_{u,v}^w = \prod m_{u_i, v_i}^{w_i}$ and that $t_{u,v}^w = \prod t_{u_i, v_i}^{w_i}$. Moreover by Proposition 2.13 we have $c_{u,v}^w = \prod c_{u_i, v_i}^{w_i}$. Thus assuming that $c_{u_i, v_i}^{w_i} = m_{u_i, v_i}^{w_i} \cdot t_{u_i, v_i}^{w_i}$ we get $c_{u,v}^w = m_{u,v}^w \cdot t_{u,v}^w$. \square

2.5.2 Bruhat and taquin recursions

Definition 2.15 Let $x \in W$ be a Λ -(co)minuscule element.

- Let $S(x) \subset S$ defined by $\alpha \in S(x)$ if and only if $\langle \alpha^\vee, x(\Lambda) \rangle \geq 0$.
- Let $H_x \subset G$ be generated by the subgroups $SL_2(\alpha)$ of G for $\alpha \in S(x)$.
- Let $Q_x \subset H_x$ be the stabiliser of $[x]$ in H_x .
- Let $W_x \subset W$ be generated by the simple reflections s_α for $\alpha \in S(x)$.
- We denote with $W_x \cdot x \subset W$ the subset of all elements of the form yx for some $y \in W_x$.

Fact 2.16 Q_x is a parabolic subgroup of H_x .

Proof. Let α be a positive root of H_x . We can write

$$\alpha = \sum_{i \in S(x)} n_i \alpha_i,$$

with $n_i \geq 0$. By definition of $S(x)$ it follows that $\langle \alpha^\vee, x(\Lambda) \rangle \geq 0$. Since the set of weights of the $SL_2(\alpha)$ -representation generated by the weight line L_x of weight x is the interval $[x(\Lambda), s_\alpha(x(\Lambda))]$, it therefore contains weights of the form $x(\Lambda) - n\alpha$ with $n \geq 0$. Thus \mathfrak{g}_α acts trivially on L_x . \square

Let x be a Λ -(co)minuscule element and let $H(x)$ be its heap. We define the peaks of $H(x)$ to be the maximal elements in $H(x)$ with respect to the partial order (see [Per07] for more combinatorics on these peaks and some geometric interpretations). Denote with $\text{Peak}(x)$ the set of peaks in $H(x)$. Recall that we denote with $c : H(x) \rightarrow D$ the coloration of the heap.

Proposition 2.17 We have $S(x) = S \setminus c(\text{Peak}(x))$.

Proof. Remark that it is enough to prove this statement for Λ -minuscule elements, the corresponding statement for Λ -cominuscule elements will follow by taking the dual root system.

Take $x = s_{\beta_1} \cdots s_{\beta_n}$ a reduced expression for x . We have for any index $i \in [1, n-1]$ the equality $s_{\beta_i} \cdots s_{\beta_n}(\Lambda) = s_{\beta_{i+1}} \cdots s_{\beta_n}(\Lambda) - \beta_i$. If $\alpha \in c(\text{Peak}(x))$ we may assume that $\beta_1 = \alpha$ and we have $s_\alpha(s_{\beta_2} \cdots s_{\beta_n}(\Lambda)) = x(\Lambda) = s_{\beta_2} \cdots s_{\beta_n}(\Lambda) - \alpha$. We get

$$\langle \alpha^\vee, x(\Lambda) \rangle = \langle \alpha^\vee, s_{\beta_2} \cdots s_{\beta_n}(\Lambda) \rangle - \langle \alpha^\vee, \alpha \rangle = 1 - 2 = -1$$

therefore $c(\text{Peak}(x))$ does not meet $S(x)$.

Now consider a simple root α not in $c(\text{Peak}(x))$ and keep the reduced expression $x = s_{\beta_1} \cdots s_{\beta_n}$ for x . We have

$$\langle \alpha^\vee, x(\Lambda) \rangle = \langle \alpha^\vee, \Lambda \rangle - \sum_{i=1}^n \langle \alpha^\vee, \beta_i \rangle.$$

If α is not in the support of x , then for all i we have $\langle \alpha^\vee, \beta_i \rangle \leq 0$ thus $\langle \alpha^\vee, x(\Lambda) \rangle \geq 0$ and $\alpha \in S(x)$. If α is in the support of x , then there exists an index j with $\alpha = \beta_j$. Because α is not in $c(\text{Peak}(x))$, there exists an index $k < j$ such that for all $i \in [1, k-1]$ we have $\langle \beta_i, \alpha^\vee \rangle = 0$ and $\langle \beta_k, \alpha^\vee \rangle < 0$. We may even assume that $\beta_{k+1} = \alpha$ and we have $s_\alpha(s_{\beta_{k+2}} \cdots s_{\beta_n}(\Lambda)) = s_{\beta_{k+2}} \cdots s_{\beta_n}(\Lambda) - \alpha$ thus the equality

$$\langle \alpha^\vee, x(\Lambda) \rangle = \langle \alpha^\vee, s_{\beta_k} \cdots s_{\beta_n}(\Lambda) \rangle = \langle \alpha^\vee, s_{\beta_{k+2}} \cdots s_{\beta_n}(\Lambda) - \alpha - \beta_k \rangle = 1 - 2 - \langle \alpha^\vee, \beta_k \rangle$$

holds. As $\langle \alpha^\vee, \beta_k \rangle < 0$ we get $\langle \alpha^\vee, x(\Lambda) \rangle \geq 0$. \square

Let w be a Λ -(co)minuscule element with $w \geq x$ and denote with $H(w)$ its heap.

Corollary 2.18 *The element w is in $W_x \cdot x$ as soon as $c(H(w) - H(x)) \cap c(\text{Peak}(x)) = \emptyset$.*

Remark 2.19 In particular, we shall consider the special case of recursion when x is such that $c(\text{Peak}(x))$ consists of a unique simple root: see Lemma 3.6.

Definition 2.20 Let $x \in W$. We say that x is a Bruhat recursion resp. a taquin recursion if for all $u, w \in W_x \cdot x$ with $u \leq w$ and w a Λ -(co)minuscule element, and for all $v \leq w$, the following holds:

$$\begin{aligned} c_{u,v}^w(G/P) &= \sum_{s \in [e, wx^{-1}]} c_{ux^{-1},s}^{wx^{-1}}(H_x/Q_x) \cdot c_{x,v}^{sx}(G/P). \\ \text{resp. } t_{u,v}^w(W)m_{u,v}^w(W) &= \sum_{s \in [e, wx^{-1}]} t_{ux^{-1},s}^{wx^{-1}}(W_x)m_{ux^{-1},s}^{wx^{-1}}(W_x) \cdot t_{x,v}^{sx}(W)m_{x,v}^{sx}(W). \end{aligned}$$

By [Ste96, Proposition 2.1] if $x \leq w$ and w is Λ -(co)minuscule, then x is also Λ -(co)minuscule; thus if x is not Λ -(co)minuscule then the above statement is empty.

Proposition 2.21 *Let $x \in W$ be Λ -(co)minuscule. Then x is a taquin recursion.*

Proof. We start with the same formula involving only the taquin terms:

$$t_{u,v}^w(W) = \sum_{s \in [e, wx^{-1}]} t_{ux^{-1},s}^{wx^{-1}}(W_x) \cdot t_{x,v}^{sx}(W).$$

This formula was proved by Thomas and Yong in the more restrictive setting of cominuscule recursion (see [ThYo08, Theorem 5.5]). Their proof adapts here verbatim.

We need to include the $m_{u,v}^w$ terms. For u a Λ -minuscule element, we have, by Lemma 2.7, the equality $m(u) = 1$ and the result follows. For u a Λ -cominuscule element, we may by Lemma 2.7 rewrite $m(u)$ as follows:

$$m(u) = \prod_{a \in H(u)} \frac{(\alpha_\Lambda, \alpha_\Lambda)}{(c(a), c(a))}.$$

In particular we get for $m_{u,v}^w(W)$ an expression independent of α_Λ and thus independent of W . It only depends on the heaps of u , v and w :

$$m_{u,v}^w(W) = \frac{\prod_{a \in H(u)} (c(a), c(a)) \prod_{a \in H(v)} (c(a), c(a))}{\prod_{a \in H(w)} (c(a), c(a))} \quad (1)$$

Now we remark that for $u' \in W_x$ with $u = u'x$, the heap $H(u)$ of u is the union of the heaps $H(x)$ and $H(u')$. In particular this gives $m(u) = m(ux^{-1})m(x)$ so $m_{u,v}^w = m_{ux^{-1},s}^{wx^{-1}}m_{x,v}^{sx}$ and the result follows. \square

2.5.3 A Λ -(co)minuscule element defines a Bruhat recursion

Let us first prove a result on the length of elements of the form wx .

Lemma 2.22 *Let $w \in (W_x)^{Q_x}$.*

- (i) *We have $wx \in W^P$.*
- (ii) *We have $l(wx) = l(w) + l(x)$.*

Proof. Let us prove this result for a Λ -minuscule element first. The result for a Λ -cominuscule element follows since all these properties depend only on the Weyl group and thus not on the orientations of the arrows in the Dynkin diagram. Recall the characterisation

$$W^P = \{w \in W \mid w(\alpha) > 0 \text{ for } \alpha > 0 \text{ with } \langle \Lambda, \alpha^\vee \rangle = 0\}.$$

Recall also that for $u \in W^P$ we have $l(u) = |\text{Inv}(u)|$ where $\text{Inv}(u)$ is the set of inversions in u defined by:

$$\text{Inv}(u) = \{\alpha > 0 \mid u(\alpha) < 0 \text{ and } \langle \Lambda, \alpha \rangle > 0\}.$$

(i) Let α be a positive root with $\langle \Lambda, \alpha^\vee \rangle = 0$, we need to prove that $wx(\alpha)$ is positive. Because $x \in W^P$, we have $x(\alpha) > 0$. Assume first that $x(\alpha)$ is a root of H_x , then we have $\langle x(\Lambda), x(\alpha)^\vee \rangle = 0$ thus, because $w \in W_x^{Q_x}$, we have $w(x(\alpha)) > 0$. If $x(\alpha)$ is not a root of H_x , then it has a positive coefficient on a simple root not in the root system of H_x . But as $w \in W_x^{Q_x}$, the root $w(x(\alpha))$ has the same coefficient on that root and $wx(\alpha) > 0$.

(ii) We have the inequality $l(wx) \leq l(w) + l(x)$. To prove the converse inequality, we prove the following inclusion (and thus equality) on the set of inversions:

$$\text{Inv}(x) \cup x(\text{Inv}(w)) \subset \text{Inv}(wx).$$

We will also prove that the first two sets are disjoint proving the result.

Let α a positive root with $\langle \Lambda, \alpha^\vee \rangle > 0$ and $x(\alpha) < 0$. Assume that $x(\alpha)$ is in the root system of H_x . We may write $x(\alpha)$ has a linear combination of positive roots in H_x with non positive coefficients. Thus by definition of H_x , we get $\langle x(\Lambda), x(\alpha)^\vee \rangle \leq 0$. But we have the equality $\langle x(\Lambda), x(\alpha)^\vee \rangle = \langle \Lambda, \alpha^\vee \rangle > 0$ a contradiction. This implies, by the same argument as in the end of (i) that $wx(\alpha) < 0$. Thus $\text{Inv}(x) \subset \text{Inv}(wx)$.

Let β a positive root of H_x with $w(\beta) < 0$ and $\langle x(\Lambda), \beta^\vee \rangle > 0$. We have $\langle \Lambda, x^{-1}(\beta)^\vee \rangle > 0$ thus $x^{-1}(\beta) > 0$ and $x^{-1}(\beta) \in \text{Inv}(wx)$. The second inclusion follows. The sets $\text{Inv}(x)$ and $x^{-1}(\text{Inv}(w))$ are disjoint since by our proof $x(\text{Inv}(x))$ is disjoint from the root system of H_x while $x(x^{-1}(\text{Inv}(w))) = \text{Inv}(w)$ is contained in that root system. \square

Let B be a Borel subgroup of G and U^- an opposite unipotent subgroup (see [Kum02, Page 215] for more details). Given $w \in W^P$ we denote with X_w resp. X^w the closure of the B -orbit resp. U^- -orbit in G/P through the point wP/P in G/P . For $u \in W_x^{Q_x}$ we define similarly the subvarieties Y_u and Y^u of H_x/Q_x . We also denote with $i : H_x/Q_x \rightarrow G/P$ the natural injection.

Lemma 2.23 *Let x be Λ -(co)minuscule and let $u, w \in (W_x)^{Q_x}$. We have $X^{ux} \cap X_{wx} = i(Y^u \cap Y_w)$, as subvarieties of G/P .*

Proof. For $v \in W^P$ let $[v] \in G/P$ denote the corresponding T -fixed point, and define similarly $[u] \in H_x/Q_x$ for $u \in W_x^{Q_x}$. Let $U(x) \subset B$ resp. $U(w) \subset B_x$ denote the unipotent subgroups corresponding to x resp. w . We have $X_x = \overline{U(x) \cdot [e]}$ thus $x \in \overline{U(x) \cdot [e]}$, from which it follows that $U(w) \cdot x \subset \overline{U(w)U(x) \cdot [e]} = X_{wx}$. Since $i([e]) = [x]$ and i is H_x -equivariant, it follows that $i(Y_w) \subset X_{wx}$. Similarly we have $i(Y^u) \subset X^{ux}$. Thus we have an injection $i : Y^u \cap Y_w \rightarrow X^{ux} \cap X_{wx}$.

By [Kum02, Lemma 7.3.10], both intersections are transverse and irreducible, so that, by Lemma 2.22, the intersections $Y^u \cap Y_w$ and $X^{ux} \cap X_{wx}$ have the same dimension, namely $l(w) - l(u)$, and thus the lemma is proved. \square

For $u \in (W_x)^{Q_x}$, let us denote with τ_u resp. τ^u the Schubert class in the homology group $H_*(H_x/Q_x, \mathbb{Z})$ resp. its dual in $H^*(H_x/Q_x, \mathbb{Z})$.

Lemma 2.24 *Let x be Λ -(co)minuscule and let $u, w \in (W_x)^{Q_x}$. We have $\sigma^{ux} \cap \sigma_{wx} = i_*(\tau^u \cap \tau_w)$, in $H_*(G/P)$.*

Proof. We still denote with σ^{ux} the restriction of the cohomology class σ^{ux} to X_{wx} . We choose a reduced expression \mathbf{w} for wx and denote with $q : \tilde{X}_{wx} \rightarrow X_{wx}$ the Bott-Samelson resolution associated to this expression (see for example [Kum02, Chapter 7]). Recall that, since the expression is reduced, the morphism q is birational. We denote with p its inverse which is a rational morphism. Observe that p is defined at $[wx]$.

Since \tilde{X}_{wx} is smooth, homology and cohomology are identified via Poincaré duality and moreover the cup product identifies with the intersection product in the Chow ring. We assume that $u \leq w$, since otherwise the terms of the lemma both equal 0. In this case $[ux] \in X^{ux} \cap X_{wx}$ and we define $\tilde{X}^{ux} = \overline{p(X^{ux} \cap X_{wx})}$. We claim that $[\tilde{X}^{ux}] = q^*\sigma^{ux} \in H^*(\tilde{X}_{wx})$. Note that $q^*\sigma^{ux}$ is characterised by the equality $\langle q^*\sigma^{ux}, \gamma \rangle = \langle \sigma^{ux}, q_*\gamma \rangle$. To prove our claim, we use the fact that $H_{2l(ux)}(\tilde{X}_{wx})$ has a basis consisting of the classes $[\tilde{X}_{\mathbf{v}}]$ where $\tilde{X}_{\mathbf{v}}$ is the Bott-Samelson subvariety of \tilde{X}_{wx} defined by the subword \mathbf{v} of \mathbf{w} and the length of \mathbf{v} is $l(ux)$. The claim is now implied by the fact that the intersection $\tilde{X}^{ux} \cap \tilde{X}_{\mathbf{v}}$ is a reduced point if $q(X_{\mathbf{v}}) = X_{ux}$ and is empty otherwise. Indeed, first remark that $q(\tilde{X}_{\mathbf{v}})$ is a Schubert variety. We may thus use Lemma 7.1.22 and Lemma 7.3.10 in [Kum02]. If $\dim q(X_{\mathbf{v}}) < l(u) + l(x)$ then $q(X_{\mathbf{v}})$ will not meet X^{ux} and we are done. If $\dim q(X_{\mathbf{v}}) = l(u) + l(x)$, then $q(X_{\mathbf{v}})$ can meet X^{ux} only if $q(X_{\mathbf{v}}) = X_{ux}$, in which case they meet transversely at $[ux]$. Moreover, since p is defined at $[ux]$, it follows that $\langle \tilde{X}^{ux}, \tilde{X}_{\mathbf{v}} \rangle = 1$ in this case.

Remark that because q is birational, we have the equality $q_*[\tilde{X}_{wx}] = \sigma_{wx}$. Since furthermore p is defined at $[wx]$, we have the equality $q_*[\tilde{X}^{ux} \cap \tilde{X}_{wx}] = q_*[\tilde{X}^{ux}] = [X^{ux} \cap X_{wx}]$. Applying projection formula we get:

$$\sigma^{ux} \cap \sigma_{wx} = q_*(q^*\sigma^{ux} \cap [\tilde{X}_{wx}]) = q_*([\tilde{X}^{ux} \cap \tilde{X}_{wx}]) = [X^{ux} \cap X_{wx}].$$

The same argument gives $\tau^u \cap \tau_w = [Y^u \cap Y_w]$ and the lemma follows from Lemma 2.23. \square

Theorem 2.25 *Let x be Λ -(co)minuscule, let $u, w \in (W_x)^{Q_x}$ and let $v \in W^P$. Then we have*

$$c_{ux,v}^{wx}(G/P) = \sum_{s \in [e,w]} c_{u,s}^w(H_x/Q_x) \cdot c_{x,v}^{sx}(G/P).$$

In other words, x is a Bruhat recursion.

Proof. The proof goes as in [ThYo08]. Let $x, u, v, w \in W$ be as in the hypothesis of the theorem.

The left hand side of the equality in Lemma 2.24 is equal to $\sum_v c_{ux,v}^{wx}(G/P)\sigma_v$, and the right hand side is equal to $i_* \sum_s c_{u,s}^w(H_x/Q_x)\tau_s$. By Lemma 2.24 again, we have the equalities $i_*\tau_s = \sigma^x \cap \sigma_{sx} = \sum_v c_{x,v}^{sx}(G/P)\sigma_v$, so the right hand side is $\sum_{v,s} c_{u,s}^w(H_x/Q_x) \cdot c_{x,v}^{sx}(G/P)\sigma_v$. Equating the coefficient of σ_v we get the theorem. \square

2.6 System of posets associated with a dominant weight

Contrary to the situation of [ThYo08], to compute the intersection numbers in a general homogeneous space, it will not be possible to use only one poset. Therefore it is necessary to show that the notion of ideals, of skew ideals, of tableaux, and of rectification make sense for a system of posets.

Let J be a poset. A J -system \mathbf{P} of posets is the data of a poset P_i for each i in J and an injective morphism of posets $f_{i,j} : P_i \rightarrow P_j$ for all pairs (i, j) with $i \leq j$, such that $f_{i,j}(P_i)$ is an order ideal in P_j and $f_{j,k} \circ f_{i,j} = f_{i,k}$ if $i \leq j \leq k$. We assume that J and each P_i 's are bounded

below. Thus if $\lambda \subset P_i$ is an order ideal and $i \leq j$ then $f_{i,j}(\lambda) \subset P_j$ is also an order ideal in P_j , and we consider the order in the set $S := \{(\lambda, P_i) : \lambda \text{ is an order ideal in } P_i\}$ generated by the relations $(\lambda, P_i) \leq (f_{i,j}(\lambda), P_j)$. The set of order ideals of the system \mathbf{P} is by definition the direct limit of S . A skew ideal is a pair (ν, λ) of order ideals of \mathbf{P} such that $\lambda \subset \nu$; it will be denoted with ν/λ . A tableau T in \mathbf{P} of skew shape ν/λ , where ν/λ is a skew ideal, is a list of compatible tableaux in each of the P_i where ν is defined, of skew shape ν_i/λ_i .

We say that \mathbf{P} has the jeu de taquin property if each P_i has this property. Let T_i be a tableau of skew shape λ/ν in P_i , let $i \leq j$, and denote with $T_j := f_{i,j}(T_i)$. If R_i (resp. R_j) denotes the rectification of T_i (resp. T_j) in P_i (resp. P_j), then note that $R_j = f_{i,j}(R_i)$ (informally, the rectification of a tableau does not depend on what is above this tableau). Therefore the rectification of a tableau in the system of posets \mathbf{P} is well-defined as a tableau in \mathbf{P} . Moreover an analogue of Proposition 2.5 holds in this context, thus defining the integer $t_{\lambda,\mu}^\nu$ for three order ideals in \mathbf{P} .

Recall that Λ is a dominant weight in a root system with Weyl group W . We now show that Λ defines a system of posets with the jeu de taquin property. Let J be the set of Λ -(co)minuscule elements in W , equipped with the weak Bruhat order (which coincides with the strong Bruhat order). If $v, w \in J$ and $v \leq w$, then we may write $w = s_{i_1} \cdots s_{i_k} \cdot v$, thus the heap $H(v)$ of v embeds naturally in $H(w)$ as an order ideal of $H(w)$. This gives a map $f_{v,w}$ and defines the system \mathbf{P}_Λ associated with Λ . Note that the set of order ideals of \mathbf{P}_Λ is the set of heaps of Λ -(co)minuscule elements in W . We refer to the pictures (4) in Subsection 3.2 for pictures of such posets.

2.7 Algebra associated with a system of posets having the jeu de taquin property

Using the jeu de taquin, we now define a \mathbb{Z} -algebra $H(\mathbf{P})$ attached to any system of posets \mathbf{P} having the jeu de taquin property. As a \mathbb{Z} -module, $H(\mathbf{P})$ is just a free \mathbb{Z} -module with basis $\{x_\lambda\}$ indexed by all order ideals λ of \mathbf{P} . We then define a product on $H(\mathbf{P})$ by

$$x_\lambda *_{\mathbf{P}} x_\mu := \sum_{\nu} t_{\lambda,\mu}^\nu x_\nu,$$

where $t_{\lambda,\mu}^\nu$ is the integer defined in Proposition 2.5. If T' is a tableau of skew shape ν/λ , we denote with $x_{T'} := x_\nu$ and say that T' is *relative to* λ . We also write $T' \rightsquigarrow T$ when the rectification of T' is a standard tableau T . Our definition of the algebra $H(\mathbf{P})$ may thus be rewritten as $x_\lambda *_{\mathbf{P}} x_\mu := \sum_{T' \rightsquigarrow T} x_{T'}$, where the sum runs over all T' relative to λ and where T is a fixed standard tableau of shape μ .

Proposition 2.26 *Let \mathbf{P} be a system of posets having the jeu de taquin property. Then the algebra $H(\mathbf{P})$ with the product $*_{\mathbf{P}}$ is commutative and associative.*

Proof. The commutativity of $H(\mathbf{P})$ amounts to the fact that $t_{\lambda,\mu}^\nu = t_{\mu,\lambda}^\nu$, which is proved in Proposition 2.5. Let us prove that $H(\mathbf{P})$ is associative.

So let λ, μ, ν be order ideals. We choose standard tableaux U and V , of shapes μ and ν , and labelled respectively with the indices $\{1, \dots, |\mu|\}$ and $\{|\mu| + 1, \dots, |\mu| + |\nu|\}$. If γ is a skew ideal, let $sh(\gamma)$ denote its shape. By definition, we have

$$(x_\lambda *_{\mathbf{P}} x_\mu) *_{\mathbf{P}} x_\nu = \sum_{U' \rightsquigarrow U, V'' \rightsquigarrow V} x_{V''} \quad (2)$$

where U' is relative to λ and V'' to $\lambda \cup sh(U')$. Since by definition we have $x_\mu *_{\mathbf{P}} x_\nu = \sum_{V' \rightsquigarrow V} x_{V'}$, where V' is relative to μ , and since for each such V' , $U \cup V'$ is a standard tableau, we also have by definition

$$x_\lambda *_{\mathbf{P}} (x_\mu *_{\mathbf{P}} x_\nu) = \sum_{V' \rightsquigarrow V, W' \rightsquigarrow U \cup V'} x_{W'} \quad (3)$$

where V' is relative to μ and W' is relative to λ .

We finish the proof of the proposition exhibiting a bijection between the set of pairs (U', W'') in (2) and the set of pairs (V', W') in (3). We hope that the following scheme will help following the argument (the order ideals λ, μ, ν correspond to the shapes: circle, rectangle, triangle).

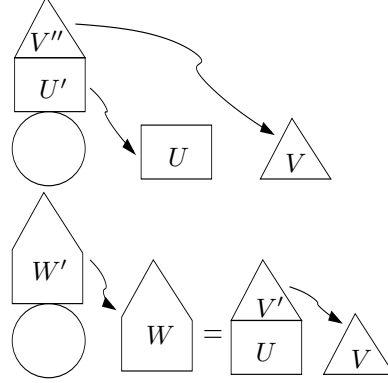

Given a pair (U', V'') as in (2), we may consider the standard tableau $W' = U' \cup V''$. While performing the rectification of W' , we get at each step a union of two tableaux which are obtained from U' and V'' applying suitable jeu de taquin slides. At the end, the rectification W of W' is a standard tableau $W = U_1 \cup T_1$, with U_1 (resp. T_1) obtained by jeu de taquin slides from U' (resp. V''). Therefore, $U_1 = U$, and V_1 rectifies to V . Therefore, if we set $V' = V_1$, we get a pair (V', W') in (3). The inverse of this bijection is given by setting U' (resp. V'') to be the tableau made of all elements of W with labels less or equal to $|\mu|$ (resp. bigger than $|\mu|$). We thus have proved that $(x_\lambda *_{\mathbf{P}} x_\mu) *_{\mathbf{P}} x_\nu = x_\lambda *_{\mathbf{P}} (x_\mu *_{\mathbf{P}} x_\nu)$. \square

In the situation of a system of posets \mathbf{P} associated to a dominant weight Λ as defined in Section 2.6, we define a perturbation of this product by the numbers $m_{\lambda, \mu}^\nu$ as follows:

$$x_\lambda \odot x_\mu := \sum_{\nu} t_{\lambda, \mu}^\nu m_{\lambda, \mu}^\nu x_\nu.$$

Using Equation (1) of the proof of Proposition 2.21, we obtain:

Corollary 2.27 *Let \mathbf{P} be a system of posets having the jeu de taquin property. Then the algebra $H(\mathbf{P})$ with the product \odot is commutative and associative.*

We therefore have a purely combinatorially-defined algebra $H(\mathbf{P})$. On the cohomology side there is also a natural algebra with basis indexed by the Λ -minuscule (resp. Λ -cominuscule) elements of W , because of the following fact (here we denote with W_{mi} resp. W_{co} the set of Λ -minuscule resp. Λ -cominuscule elements).

Fact 2.28 *The \mathbb{Z} -modules $\bigoplus_{w \notin W_{mi}} \mathbb{Z} \cdot \sigma^w$ and $\bigoplus_{w \notin W_{co}} \mathbb{Z} \cdot \sigma^w$ are ideals in $H^*(G/P)$.*

Proof. Let $v \in W$ be non Λ -(co)minuscule and let $x \in H^*(G/P)$. We want to show that $\sigma^v \cup x$ is a linear combination of some σ^w 's with w non Λ -(co)minuscule. To this end we may assume that x is a Schubert cohomology class of degree d ; thus $x \leq h^d$ (h denotes the degree 1 Schubert cohomology class).

Write $\sigma^v \cup x = \sum c_w \sigma^w$, and let w be such that $c_w > 0$. Thus the coefficient of σ^w in $\sigma^v \cdot h^d$ is positive. Thus in the strong Bruhat order we have $v \leq w$. By [Ste96, Proposition 2.1], w cannot be Λ -(co)minuscule. So the fact is proved. \square

Fact 2.29 *Let $w_1, \dots, w_s \in W$. Then the \mathbb{Z} -module $\bigoplus_{v_i, w \not\leq w_i} \mathbb{Z} \cdot \sigma^w$ is an ideal in $H^*(G/P)$. We denote with $H_{(w_i)}^*(X)$ the corresponding quotient algebra.*

Proof. For all $i \in [1, s]$, if $v \geq u$ and $u \not\leq w_i$, then $v \not\leq w_i$. Thus the argument is the same as for the previous fact. \square

3 Main result and strategy for the proof

3.1 Statement of the main result

Let $X = G/P$ be a homogeneous space and let W resp. Λ denote the Weyl group of G resp. the dominant weight associated to P . Denote with D the Dynkin diagram of G . Let $w \in W$ be Λ -(co)minuscule. As in Definition 2.2 we associate to w a heap $H(w)$. By [Pro99b, Proposition A] (see also the end of Subsection 2.2), we may decompose $H(w)$ into a so-called slant product of irreducible heaps that we denote with $(H_i)_{0 \leq i \leq k}$. We also denote with $D(H_i) = c(H_i) \subset D$ the Dynkin diagram corresponding to H_i .

Definition 3.1 Let $w \in W$ be Λ -(co)minuscule. We say that w is slant-finite-dimensional if all the Dynkin diagrams $D(H_i)$ are Dynkin diagrams of finite-dimensional algebraic groups, in other words $D(H_i)$ belongs to $\{A_n, B_n, C_n, D_n, E_6, E_7, E_8, F_4, G_2\}$ for all i .

Our main result is the following.

Theorem 3.2 *Let G/P be a Kac-Moody homogeneous space where P corresponds to the dominant weight Λ . Let $u, v, w \in W$ be Λ -(co)minuscule. Assume that w is slant-finite-dimensional. Then we have $c_{u,v}^w = m_{u,v}^w t_{u,v}^w$.*

3.2 Definition of some systems of posets

In order to prove Theorem 3.2 we may assume, thanks to Corollary 2.13, that P is a maximal parabolic subgroup of G . The proof of Theorem 3.2 will be done by induction on the rank of G , considering the different possible cases for the irreducible component $H_0(w)$ of $H(w)$ containing the minimal element of $H(w)$. In this subsection we give general lemmas to enable this.

For the basic definitions concerning posets, we refer the reader to Subsection 2.1. We fix a marked Dynkin diagram (D_0, Λ) which has no cycle, and we consider a system of Λ -(co)minuscule D_0 -colored posets that we denote with \mathbf{P}_0 . We denote with I_0 the poset indexing this system, so that for all $i \in I_0$ we are given a Λ -(co)minuscule D_0 -colored poset $\mathbf{P}_0(i)$. The choice of Λ equips D_0 with the structure of a poset, because we set $d_1 \leq d_2$ in D_0 if d_1 and Λ belong to the same connected component of $D_0 - \{d_2\}$. We assume that any $\alpha \in D_0$ is the color of at least one element in $\mathbf{P}_0(i)$ for each i in I_0 , thus the rooted tree of $\mathbf{P}_0(i)$ is equivalent, as a poset, with D_0 .

We denote with S_0 the set of maximal elements in D_0 . For each $\alpha \in S_0$ we suppose we are given a marked Dynkin diagram $(D_\alpha, \Lambda_\alpha)$ and a Λ_α -(co)minuscule D_α -colored poset P_α , and we now define a system of posets \mathbf{P} which contains all the possible ways of adjoining the posets P_α to the posets $\mathbf{P}_0(i)$. Let D be the Dynkin diagram obtained from the disjoint union of D_0 and the D_α 's for $\alpha \in S_0$, where we connect $\alpha \in S_0$ with $\Lambda_\alpha \in D_\alpha$ with an arbitrary number of edges. The colors of \mathbf{P} will be the elements of D .

The system \mathbf{P} is indexed by the set of triples (i, S_1, S_2) where $i \in I_0$ and (S_1, S_2) are subsets of S_0 with $S_1 \supset S_2$. This index set is itself a poset if we set $(i, S_1, S_2) \leq (j, T_1, T_2)$ if $i \leq j$, $S_1 \subset T_1$ and $S_2 \subset T_2$.

To any subset $S_1 \subset S_0$ and $i \in I_0$ we associate the subposet $\mathbf{P}_0(i, S_1)$ of $\mathbf{P}_0(i)$ which is the maximal subposet such that all the colors α in $S_0 - S_1$ occur only once in $\mathbf{P}_0(i, S_1)$ (in other words $\mathbf{P}_0(i, S_1)$ contains all the elements in $\mathbf{P}_0(i)$ which are not bigger or equal to some element $(\alpha, 2)$ with $\alpha \in S_0 - S_1$). Thus if $(i, S_1) \leq (j, T_1)$ then $\mathbf{P}_0(i, S_1) \subset \mathbf{P}_0(j, T_1)$, and $\mathbf{P}_0(i, \emptyset) = \mathbf{P}_0(i)$. We define $\mathbf{P}(i, S_1, S_2)$ to be the slant product of $\mathbf{P}_0(i, S_1)$ and the posets P_α for $\alpha \in S_2$, where the poset P_α is attached to $\mathbf{P}_0(i, S_1)$ on the unique node colored by α in $\mathbf{P}_0(i, S_1)$. By [Pro99b, Proposition A], $\mathbf{P}(i, S_1, S_2)$ is Λ -minuscule (resp. Λ -cominuscule) if $\mathbf{P}_0(i, S_1)$ is Λ -minuscule (Λ -cominuscule) and Λ_α is not shorter (resp. longer) than α . Moreover for $(i, S_1, S_2) \leq (j, T_1, T_2)$ we obviously have an injection $\mathbf{P}(i, S_1, S_2) \subset \mathbf{P}(j, T_1, T_2)$, so that \mathbf{P} is indeed a system of Λ -(co)minuscule D -colored posets.

Notation 3.3 We denote with $\mathbf{P}_{\mathbf{P}_0, (P_\alpha)}$ the system of posets constructed above.

Example 3.4 In the following array we give explicitly the obtained system of posets when \mathbf{P}_0 contains only one element which is the heap of the maximal Schubert cell in D_7/P_6 . Note that in this case $S_0 = \{1, 7\}$. Since I_0 has only one element we abbreviate $\mathbf{P}(i, S_1, S_2)$ into $\mathbf{P}(S_1, S_2)$. In the drawings we represent the rooted tree with solid dots and solid diamonds (for the maximal elements), we represent the elements which must belong to an ideal in order for this ideal to be slant-irreducible with \otimes , and the other elements are depicted with hollow dots. The posets P_α for $\alpha \in S_0$ are represented by angular sectors.

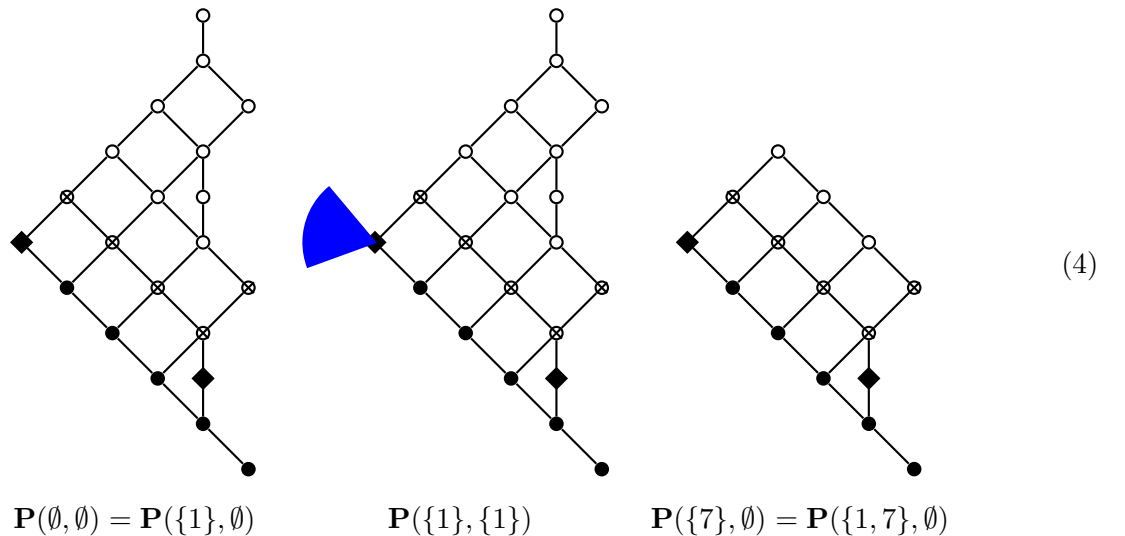

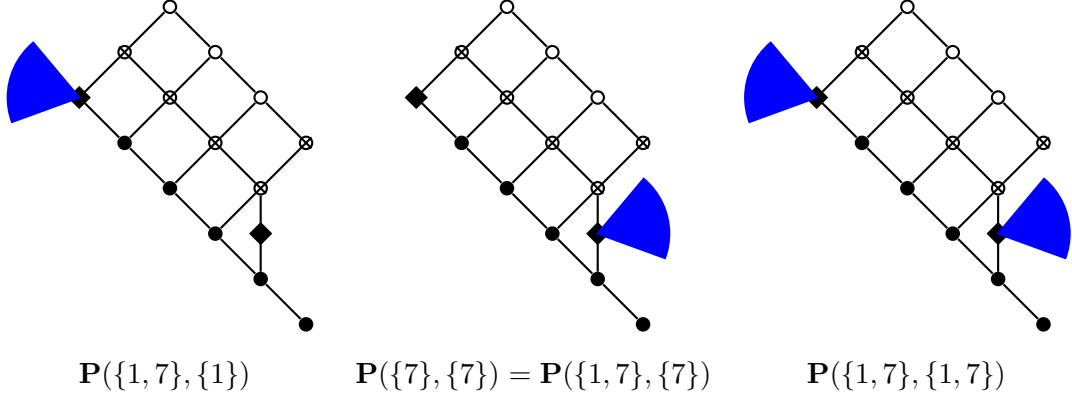

We also consider the Kac-Moody homogeneous space defined by the marked Dynkin diagram (D_0, Λ) resp. (D, Λ) , that we denote with X_0 resp. X . Let W be the Weyl group corresponding to D , and for each triple (i, S_1, S_2) let $w_{i, S_1, S_2} \in W$ be the Λ -(co)minuscule element corresponding to the Λ -(co)minuscule poset $\mathbf{P}(i, S_1, S_2)$. We denote with $H_t^*(X)$ the truncation $H_{\{w_{i, S_1, S_2}\}}^*(X)$ of $H^*(X)$ obtained with the elements w_{i, S_1, S_2} (see Fact 2.29).

3.3 Reduction to indecomposable posets

In the rest of this subsection $\mathbf{P}_0, S_0, (P_\alpha), \mathbf{P}, X, H_t^*(X)$ are as above, and we assume that Conjecture 2.10 holds for any marked Dynkin diagram (D', d') and any D' -colored d' -minuscule poset as soon as $D' \subsetneq D$.

We will give some lemmas which help comparing $H^*(\mathbf{P})$ with $H_t^*(X)$. Note that these two \mathbb{Z} -modules have a basis indexed by the same set, namely the set of ideals of \mathbf{P} . Thus, in order to simplify notation, we will identify these \mathbb{Z} -modules and denote with $x \cdot y$ resp. $x \odot y$ the product in $H_t^*(X)$ resp. $H^*(\mathbf{P})$.

Notation 3.5 For $\alpha \in S_0$ we denote with $\lambda_\alpha = \langle(\alpha, 1)\rangle$ the ideal in \mathbf{P}_0 , and we define the cohomology class $\sigma^\alpha = \sigma^{\lambda_\alpha} \in H^*(\mathbf{P}_0)$.

We now make use of Theorem 2.25.

Lemma 3.6 *Let $\sigma \in H^*(\mathbf{P})$.*

1. *Let $\alpha \in D$ and let i be an integer. Assume that $\sigma \cdot \sigma^\lambda = \sigma \odot \sigma^\lambda$ for $\lambda = \langle(\alpha, i)\rangle$. Then $c_{\sigma, \mu}^\nu = t_{\sigma, \mu}^\nu \cdot m_{\sigma, \mu}^\nu$ for $\mu, \nu \in I(\mathbf{P})$ such that $(\alpha, i) \in \mu$ and $(\alpha, i+1) \notin \nu$.*
2. *In particular, assume that α and i are such that for each poset P in the system \mathbf{P} the number of elements of P colored by α is not bigger than i , and that $\sigma \cdot \sigma^\lambda = \sigma \odot \sigma^\lambda$ for $\lambda = \langle(\alpha, i)\rangle$. Then $\sigma \cdot \sigma^\mu = \sigma \odot \sigma^\mu$ if $(\alpha, i) \in \mu$.*
3. *In particular, if $\alpha \in S_0$ and $\sigma \cdot \sigma^\alpha = \sigma \odot \sigma^\alpha$, then $\sigma \cdot \sigma^\lambda = \sigma \odot \sigma^\lambda$ for λ containing $(\alpha, 1)$.*

Proof. Let $\sigma \in H^*(\mathbf{P})$ and let α, i as in the first point, and let $\mu, \nu \in I(\mathbf{P})$ such that $\mu \supset \langle(\alpha, i)\rangle$ and $(\alpha, i+1) \notin \nu$.

Let x resp. u, w be the elements in W corresponding to the ideals $\langle(\alpha, i)\rangle$ resp. μ, ν . Since $\langle(\alpha, i)\rangle$ has only one peak namely (α, i) , by Corollary 2.18 and the assumption on λ, μ we have $u, w \in W_x \cdot x$. By assumption, Conjecture 2.10 holds for posets colored by $D - \{\alpha\}$. Thus for

$s \in W_x$ we have $c_{ux^{-1},s}^{wx^{-1}} = t_{ux^{-1},s}^{wx^{-1}} \cdot m_{ux^{-1},s}^{wx^{-1}}$. Moreover the hypothesis that $\sigma \cdot \sigma^x = \sigma \odot \sigma^x$ says that $c_{x,\sigma}^{sx} = t_{x,\sigma}^{sx} \cdot m_{x,\sigma}^{sx}$ for $s \in W_x$. Thus by Theorem 2.25 it follows that $c_{u,\sigma}^w = t_{u,\sigma}^w \cdot m_{u,\sigma}^w$. This proves the first point.

The second point follows because under the hypothesis for any ideal μ we have $(\alpha, i+1) \notin \mu$. The third point is a special case, for $i = 1$, of the second one. \square

Lemma 3.7 *Let $\gamma \in H^*(\mathbf{P})$ such that $\gamma \cdot \sigma = \gamma \odot \sigma$ for $\sigma \in H^*(\mathbf{P}_0)$, then $\gamma \cdot \sigma = \gamma \odot \sigma$ for $\sigma \in H^*(\mathbf{P})$.*

Proof. Assume $\sigma = \sigma^\lambda$. For $\lambda \in I(\mathbf{P}) - I(\mathbf{P}_0)$, there exists $\alpha \in S_0$ such that $\lambda \supset \lambda^\alpha$. But the class σ^α is in $H^*(\mathbf{P}_0)$ thus the equality $\gamma \cdot \sigma^\alpha = \gamma \odot \sigma^\alpha$ holds and by Lemma 3.6 we have $\gamma \cdot \sigma = \gamma \odot \sigma$. \square

In the following lemma (γ^i) is a list of elements in $H^*(\mathbf{P}_0)$ and we denote with $\langle\langle \gamma^i \rangle\rangle$ the subalgebra they generate in $H^*(\mathbf{P}_0)$. For d an integer we denote with $\langle\langle \gamma^i \rangle\rangle_d$ the classes of $\langle\langle \gamma^i \rangle\rangle$ of degree at most d . Moreover we denote with $\pi : H^*(\mathbf{P}) \rightarrow H^*(\mathbf{P}_0)$ the algebra morphism obtained by moding out by the ideal of $H^*(\mathbf{P})$ linearly generated by the Schubert classes σ^λ with $\lambda \in I(\mathbf{P}) - I(\mathbf{P}_0)$. Finally let $H_d \subset H^*(\mathbf{P})$ denote the space of linear combinations of σ^λ for $\lambda \in I(\mathbf{P}) - I(\mathbf{P}_0)$ such that there exists $\alpha \in S_0$ with $\deg(\sigma^\alpha) \leq d$ and $\lambda \supset \lambda_\alpha$.

Lemma 3.8 *Let $(\gamma^i)_{i \in [1,k]}$ be elements in $H^*(\mathbf{P}_0)$ and d an integer. Assume that*

- *For all i and all $\sigma \in H^*(\mathbf{P}_0)$ we have $\sigma \cdot \gamma^i = \sigma \odot \gamma^i$.*
- *For each α in S_0 with $\deg(\sigma^\alpha) \leq d$, we have $\sigma^\alpha \in \langle\langle \gamma^i \rangle\rangle$.*

Then for all σ in $H^(\mathbf{P})$ and for all τ in $H^*(\mathbf{P})$ such that $\pi(\tau) \in \langle\langle \gamma^i \rangle\rangle_d$ and $\tau - \pi(\tau) \in H_d$ we have $\sigma \cdot \tau = \sigma \odot \tau$.*

Proof. By Lemma 3.7 we have the equality $\sigma \cdot \gamma^i = \sigma \odot \gamma^i$ for general $\sigma \in H^*(\mathbf{P})$. In particular a polynomial expression in the γ^i 's is the same whether it is computed with the product \cdot or \odot . If P is a polynomial and $\sigma \in H^*(\mathbf{P})$ we moreover have $\sigma \cdot P(\gamma^i) = \sigma \odot P(\gamma^i)$.

We then prove by induction on $d' \leq d$ that if $\alpha \in S_0$ with $\deg(\sigma^\alpha) \leq d'$ and $\sigma \in H^*(\mathbf{P})$, then

$$\sigma \cdot \sigma^\lambda = \sigma \odot \sigma^\lambda \text{ if } \lambda \supset \lambda_\alpha.$$

Let $d' \leq d$ be an integer and let α such that $\deg(\sigma^\alpha) = d'$. Let P be a polynomial such that $\sigma^\alpha = \pi(P(\gamma^1, \dots, \gamma^k))$ (such a P exists because of the hypothesis that $\sigma^\alpha \in \langle\langle \gamma^i \rangle\rangle$). In $H^*(\mathbf{P})$ we therefore have $P(\gamma^1, \dots, \gamma^k) = \sigma^\alpha + \sum_{m \in M} x_m \sigma^{\lambda_m}$ with λ_m some elements in $I(\mathbf{P}) - I(\mathbf{P}_0)$. For each m in M , since $\lambda_m \notin I(\mathbf{P}_0)$, λ_m must contain some element λ_β with $\beta \in S_0$ and $\deg(\sigma^\beta) < d'$ and by induction hypothesis $\sigma \cdot \sigma^{\lambda_m} = \sigma \odot \sigma^{\lambda_m}$. Thus from $\sigma \cdot P(\gamma^i) = \sigma \odot P(\gamma^i)$ we get $\sigma \cdot \sigma^\alpha = \sigma \odot \sigma^\alpha$. By recursion with respect to λ_α (Lemma 3.6 point 3) it follows that $\sigma \cdot \sigma^\lambda = \sigma \odot \sigma^\lambda$ if $\lambda \supset \lambda_\alpha$ and we are done.

We thus have proved that if $\sigma \in H^*(\mathbf{P})$ and $\tau' \in H_d$ then $\sigma \cdot \tau' = \sigma \odot \tau'$. Let finally $\tau \in H^*(\mathbf{P})$ such that $\pi(\tau) \in \langle\langle \gamma^i \rangle\rangle_d$ and $\tau - \pi(\tau) \in H_d$, and let $\sigma \in H^*(\mathbf{P})$ be arbitrary. Let P as before such that $P(\gamma^i) = \tau + \tau'$ with $\tau' \in H_d$. Since $\sigma \cdot P(\gamma^i) = \sigma \odot P(\gamma^i)$ and we already know that $\sigma \cdot \tau' = \sigma \odot \tau'$, we deduce $\sigma \cdot \tau = \sigma \odot \tau$. \square

We now specialise this lemma.

Lemma 3.9 *Let $(\gamma^i)_{i \in [1,k]}$ be elements in $H^*(\mathbf{P}_0)$. Assume that*

- For all i and all $\sigma \in H^*(\mathbf{P}_0)$ we have $\sigma \cdot \gamma^i = \sigma \odot \gamma^i$.
- For each α in S_0 , we have $\sigma^\alpha \in \langle \langle \gamma^i \rangle \rangle$.

Then for all σ in $H^*(\mathbf{P})$ and for all τ in $H^*(\mathbf{P})$ such that $\pi(\tau) \in \langle \langle \gamma^i \rangle \rangle$, we have $\sigma \cdot \tau = \sigma \odot \tau$.

Lemma 3.10 Let $(\gamma^i)_{i \in [1, k]}$ be elements in $H^*(\mathbf{P}_0)$ such that:

- For all $i \in \{1, \dots, k\}$ and for all $\sigma \in H^*(\mathbf{P}_0)$ we have $\gamma^i \cdot \sigma = \gamma^i \odot \sigma$.
- $\gamma^1, \dots, \gamma^k$ generate $H^*(\mathbf{P}_0)$.

Then for all $\sigma, \tau \in H^*(\mathbf{P})$ we have $\sigma \cdot \tau = \sigma \odot \tau$.

For $\sigma \in H^*(\mathbf{P})$ let us denote with σ^n resp. $\sigma^{\odot n}$ the n -th power of σ computed with the product \cdot resp. \odot .

Lemma 3.11 Let $\sigma, \gamma^1, \dots, \gamma^k \in H^*(\mathbf{P}_0)$ and d an integer such that we have:

- $\forall \tau \in H^*(\mathbf{P}_0), \gamma^i \cdot \tau = \gamma^i \odot \tau$.
- $\forall n \leq d, \sigma^n = \sigma^{\odot n}$.

Then for any polynomial $P(X, X_1, \dots, X_n)$ of degree at most $d - 1$ in X we have the relation

$$\sigma \cdot P(\sigma, \gamma^1, \dots, \gamma^k) = \sigma \odot P(\sigma, \gamma^1, \dots, \gamma^k).$$

In particular $P(\sigma, \gamma^1, \dots, \gamma^k)$ itself does not depend on the product.

Proof. In fact we may assume that $P = X^n Q(X_1, \dots, X_k)$ with $n \leq d - 1$. We compute

$$\begin{aligned} \sigma \cdot P(\sigma, \gamma^1, \dots, \gamma^k) &= \sigma \cdot \sigma^n \cdot Q(\gamma^1, \dots, \gamma^k) = \sigma^{(n+1)} \cdot Q(\gamma^1, \dots, \gamma^k) \\ &= \sigma^{\odot n+1} \odot Q(\gamma^1, \dots, \gamma^k) = \sigma \odot (\sigma^{\odot n} \odot Q(\gamma^1, \dots, \gamma^k)) \\ &= \sigma \odot P(\sigma, \gamma^1, \dots, \gamma^k). \end{aligned}$$

□

Lemma 3.12 Let $\lambda, \mu \in I(\mathbf{P}_0)$, and assume the following:

- (i) $\forall \nu \in I(\mathbf{P}_0)$ we have $c_{\lambda, \mu}^\nu = m_{\lambda, \mu}^\nu t_{\lambda, \mu}^\nu$.
- (ii) For all α in S_0 , we have either
 - $\mu \supset \lambda_\alpha$ and $\sigma^\lambda \cdot \sigma^\alpha = \sigma^\lambda \odot \sigma^\alpha$ or
 - $\lambda \supset \lambda_\alpha$ and $\sigma^\mu \cdot \sigma^\alpha = \sigma^\mu \odot \sigma^\alpha$.

Then $\sigma^\lambda \cdot \sigma^\mu = \sigma^\lambda \odot \sigma^\mu$.

Proof. The lemma amounts to the fact that $\forall \nu \in I(\mathbf{P})$ we have $c_{\lambda, \mu}^\nu = m_{\lambda, \mu}^\nu t_{\lambda, \mu}^\nu$. This holds by assumption if $\nu \in I(\mathbf{P}_0)$. Otherwise there exists a simple root α in S_0 such that $\mu \supset \lambda_\alpha$. By (ii) we may assume that $\mu \supset \lambda_\alpha$ and $\sigma^\lambda \cdot \sigma^\alpha = \sigma^\lambda \odot \sigma^\alpha$. The result follows by the third part of Lemma 3.6. □

Recall from Proposition 2.11, the equality of combinatorial and cohomological Chevalley formula.

Notation 3.13 Let $\lambda, \nu \in I(\mathbf{P})$ and let d be an integer. We define

- $\lambda \cap \mathbf{P}_0$ the ideal in \mathbf{P} defined by $(\lambda \cap \mathbf{P}_0)(i, S_1, S_2) = \lambda(i, S_1, S_2) \cap \mathbf{P}_0(i)$.

- $A_{\lambda,d} = \{\mu \in I(\mathbf{P}_0) : \deg(\mu) = d, \sigma^\lambda \cdot \sigma^\mu \neq \sigma^\lambda \odot \sigma^\mu\}$.
- $A'_{\lambda,d} = \{\mu \in I(\mathbf{P}_0) : \deg(\mu) = d, c'_{\lambda,\mu} \neq t'_{\lambda,\mu} \cdot m'_{\lambda,\mu}\}$.

Lemma 3.14 *Let $\lambda \in I(\mathbf{P})$ be a fixed ideal and d be an integer.*

(i) *Assume that for all $\mu \in I(\mathbf{P})$ such that $\deg(\mu \cap \mathbf{P}_0) < d$ we have $\sigma^\lambda \cdot \sigma^\mu = \sigma^\lambda \odot \sigma^\mu$ and that $\#A_{\lambda,d} \leq 1$. Then $A_{\lambda,d} = \emptyset$.*

(ii) *More specifically, let $\nu \in I(\mathbf{P})$ be another ideal and assume that for all $\mu \in I(\mathbf{P})$ such that $\deg(\mu \cap \mathbf{P}_0) < d$ we have $c'_{\lambda,\mu} = t'_{\lambda,\mu} \cdot m'_{\lambda,\mu}$ and that $\#A'_{\lambda,d} \leq 1$. Then $A'_{\lambda,d} = \emptyset$.*

Proof. Let us prove (i). Let λ, d be as in the lemma. By Proposition 2.11 the d -th powers of h computed in $H_t^*(X)$ and $H^*(\mathbf{P})$ are equal. Let $\mu \in I(\mathbf{P})$ with $\deg(\mu) = d$. We have the following properties:

- By Chevalley formula the coefficient of σ^μ in h^d is positive.
- If $\sigma \notin I(\mathbf{P}_0)$ then $\deg(\mu \cap \mathbf{P}_0) < d$.
- $h^d \cdot \sigma^\lambda = h^d \odot \sigma^\lambda$.

Thus it follows from the hypothesis that $\sigma^\lambda \cdot \sigma^\mu = \sigma^\lambda \odot \sigma^\mu$. The proof of (ii) is similar. \square

Recall that X_0 is the homogeneous space associated to the marked Dynkin diagram (D_0, Λ) .

Lemma 3.15 *Let σ be a fixed Schubert class and d be an integer.*

(i) *Assume that $\dim H^d(X_0) \geq \dim H^{d+1}(X_0)$ and assume that $\sigma \cdot \sigma^\mu = \sigma \odot \sigma^\mu$ for any $\mu \in I(\mathbf{P}_0)$ such that $\deg(\mu) \leq d$. Assume moreover that X_0 is finite dimensional. Then for any $\mu \in I(\mathbf{P})$ such that $\deg(\mu \cap \mathbf{P}_0) \leq d+1$ we have $\sigma \cdot \sigma^\mu = \sigma \odot \sigma^\mu$.*

(ii) *Assume there exists a subset C of $I(\mathbf{P}_0)$ such that for all $\mu \in C$ we have $\sigma \cdot \sigma^\mu = \sigma \odot \sigma^\mu$. Assume furthermore that the natural map given by multiplication by h :*

$$\bigoplus_{\substack{\mu \in I(\mathbf{P}_0)_d \\ \mu \notin C}} \mathbb{Z} \cdot \sigma^\mu \rightarrow \bigoplus_{\substack{\mu' \in I(\mathbf{P}_0)_{d+1} \\ \mu' \notin C}} \mathbb{Z} \cdot \sigma^{\mu'}$$

is surjective and that $\sigma \cdot \sigma^\mu = \sigma \odot \sigma^\mu$ for $\mu \in I(\mathbf{P}_0)$ such that $\deg(\mu) \leq d$. Then for any μ in $I(\mathbf{P})$ such that $\deg(\mu \cap \mathbf{P}_0) \leq d+1$ we have $\sigma \cdot \sigma^\mu = \sigma \odot \sigma^\mu$.

Proof. (i) Let $h_d : H^d(X_0, \mathbb{Q}) \rightarrow H^{d+1}(X_0, \mathbb{Q})$ and $\kappa_d : H^d(\mathbf{P}_0, \mathbb{Q}) \rightarrow H^{d+1}(\mathbf{P}_0, \mathbb{Q})$ be the maps induced by multiplication by the class of degree 1. If $2d \geq \dim(X_0)$, then by Lefschetz Theorem (see for example [Laz04, Theorem 3.1.39]), h_d is surjective. If $2d < \dim(X_0)$ again by Lefschetz Theorem h_d is injective and hence, under hypothesis (i), surjective. It follows that the induced quotient map $H_t^d(X_0) \rightarrow H_t^{d+1}(X_0)$ is also surjective. Since this map identifies with κ_d , κ_d is surjective.

We first prove that for any $\mu \in I(\mathbf{P})$ such that $\deg(\mu \cap \mathbf{P}_0) \leq d$ we have $\sigma \cdot \sigma^\mu = \sigma \odot \sigma^\mu$. In fact, let μ be such an ideal and let $\alpha \in S_0$. If $\mu \supset \lambda_\alpha$ then $\deg(\lambda_\alpha) \leq d$ and thus by assumption $\sigma \cdot \sigma^\alpha = \sigma \odot \sigma^\alpha$. By Lemma 3.6(3) we deduce that $\sigma \cdot \sigma^\mu = \sigma \odot \sigma^\mu$. If $\mu \not\supset \lambda_\alpha$ for all elements $\alpha \in S_0$ then $\mu \in I(\mathbf{P}_0)$ and this equality is true by assumption.

Now we consider $\mu \in I(\mathbf{P})$ such that $\deg(\mu) = d+1$. If $\mu \notin I(\mathbf{P}_0)$ then we have already proved the result, so assume $\mu \in I(\mathbf{P}_0)$. Since κ_d is surjective, there exists $\rho \in H^*(\mathbf{P}_0)$ such that $h \cdot \rho = \sigma^\mu + \tau$, where τ is a linear combination of some σ^μ with $\mu \in I(\mathbf{P}) - I(\mathbf{P}_0)$ and therefore $\sigma \cdot \tau = \sigma \odot \tau$. Since $\sigma \cdot (h \cdot \rho) = \sigma \odot (h \cdot \rho)$, we get $\sigma \cdot \sigma^\mu = \sigma \odot \sigma^\mu$.

Finally we prove that if $\deg(\mu \cap \mathbf{P}_0) \leq d + 1$ then $\sigma \cdot \sigma^\mu = \sigma \odot \sigma^\mu$. This is similar to what we have done in the first case.

(ii) In this case the proof is as for (i). \square

We end this subsection with a lemma specific to the finite dimension and even specific to the minuscule and cominuscule case. This lemma corresponds to Lemma 5.8.(iii) in [ThYo08]. In the following lemma we assume that the longest element w^P in W^P is Λ -(co)minuscule. This is equivalent to saying that Λ itself is (co)minuscule. We define \mathbf{P}_0 as the heap of w^P .

Lemma 3.16 *Let λ and μ be two ideals in \mathbf{P}_0 and assume that for all ideals ν in \mathbf{P}_0 except one we have $c_{\lambda,\mu}^\nu = t_{\lambda,\mu}^\nu \cdot m_{\lambda,\mu}^\nu$, then we have $c_{\lambda,\mu}^\nu = t_{\lambda,\mu}^\nu \cdot m_{\lambda,\mu}^\nu$ for all ν .*

Proof. We denote with σ^λ , σ^μ and σ^ν the classes corresponding to the ideals λ , μ and ν .

This lemma amounts to the fact that Poincaré duality is compatible with jeu de taquin in this situation. In other words, if λ is an ideal in \mathbf{P}_0 , then there exists a unique ideal λ^c in \mathbf{P}_0 of degree $\deg(\mathbf{P}_0) - \deg(\lambda)$ such that for any μ with $\deg(\mu) = \deg(\mathbf{P}_0) - \deg(\lambda)$, we have

$$\sigma^\lambda \cdot \sigma^\mu = \delta_{\mu,\lambda^c} \cdot [\text{pt}] = \sigma^\lambda \odot \sigma^\mu$$

where $[\text{pt}] \in H^{\dim X}(X)$ is the Poincaré dual of the class of a point. This result was proved in [ThYo08, Corollary 4.7].

Let us prove the lemma. Let $m = \deg(\mathbf{P}_0) - (\deg(\lambda) + \deg(\mu))$ and h the hyperplane class. We have

$$\sigma^\lambda \cdot \sigma^\mu = \sum_{\substack{\nu \subset \mathbf{P}_0 \\ \deg(\nu)=m}} c_{\lambda,\mu}^\nu \sigma^\nu \text{ and } \sigma^\lambda \odot \sigma^\mu = \sum_{\substack{\nu \subset \mathbf{P}_0 \\ \deg(\nu)=m}} t_{\lambda,\mu}^\nu m_{\lambda,\mu}^\nu \sigma^\nu.$$

By the discussion above, we have $\sigma \cdot \tau = \sigma \odot \tau$ for any classes σ and τ such that $\deg(\sigma) + \deg(\tau) = \deg(\mathbf{P}_0)$. Because $\deg(h^m \cdot \sigma^\lambda) + \deg(\mu) = \deg(\mathbf{P}_0)$, we have

$$(h^m \cdot \sigma^\lambda) \cdot \sigma^\mu = (h^m \cdot \sigma^\lambda) \odot \sigma^\mu = (h^m \odot \sigma^\lambda) \odot \sigma^\mu.$$

But this is also equal to

$$h^m \cdot (\sigma^\lambda \cdot \sigma^\mu) = \sum_{\substack{\nu \subset \mathbf{P}_0 \\ \deg(\nu)=m}} c_{\lambda,\mu}^\nu (h^m \cdot \sigma^\nu) \text{ and } h^m \odot (\sigma^\lambda \odot \sigma^\mu) = \sum_{\substack{\nu \subset \mathbf{P}_0 \\ \deg(\nu)=m}} t_{\lambda,\mu}^\nu m_{\lambda,\mu}^\nu (h^m \odot \sigma^\nu).$$

As for all ν of degree m the class $h^m \cdot \sigma^\nu = h^m \odot \sigma^\nu$ is non zero, and because $c_{\lambda,\mu}^\nu = t_{\lambda,\mu}^\nu \cdot m_{\lambda,\mu}^\nu$ for all ν but one we get the result. \square

3.4 Strategy for the proof of the main Theorem

We now reduce the proof of Theorem 3.2 to some tractable cases. So let D be a Dynkin diagram with Weyl group W , Λ a dominant weight, X the corresponding Kac-Moody homogeneous space, and let u, v, w be Λ -minuscule elements in W . By Corollary 2.14 we may assume that Λ is a fundamental weight; let $d \in D$ be the corresponding node.

Let us first introduce some notation. If (D, d) is a marked Dynkin diagram and w is a Λ_d -(co)minuscule element, we denote with $P_0(w)$ the slant-irreducible component of $H(w)$ containing the minimal element $(d, 1)$ of $H(w)$. We also denote with $D_0(w) \subset D$ the set of colors of $P_0(H(w))$.

The heap of w is a slant product of $P_0(w)$ and some P_α 's. We first prove Theorem 3.2 in the case $D_0(w)$ is simply laced. Arguing by induction, we may assume that Theorem 3.2 holds for P_α

and for any u', v', w' with $D_0(w') \subsetneq D_0(w)$. Note moreover that $P_0(w)$, being slant-irreducible, must fall in one of the cases of [Pro99b] and its corresponding Dynkin diagram must correspond to a finite-dimensional Kac-Moody group (by our assumption). In the following array, we indicate, depending on $P_0(w)$, which lemma allows to finish the proof.

$P_0(w)$ as in Proctor's case	$D_0(w)$	Lemma
1	A_n	4.2
2	D_n	4.3
3 ($f = 1; g = 2; 2 \leq h \leq 4$)	E_{h+4}	4.5, 4.7, 4.10
4 ($f \geq 2; h = 1$)	D_n	4.1
4, 5, 6, 7 ($f = 2; 2 \leq h \leq 4$)	E_{4+h}	4.4, 4.6, 4.9
4, 5, 6, 7, 8, 9, 10, 11, 12, 13, 14 ($3 \leq f \leq 4; h = 2$)	E_{f+4}	4.8, 4.11
15	E_7	4.8

Once Theorem 3.2 is proved in case $D_0(w)$ is simply laced, we prove it in general thanks to Lemmas 5.5, 5.6, 5.9 and 5.14. We end this section with the following notation we shall use in the sequel:

Notation 3.17 A generator γ of the algebra $H^*(\mathbf{P})$ will be called a good generator if $\gamma \cdot \sigma = \gamma \odot \sigma$ for all classes σ in $H^*(\mathbf{P})$.

4 Simply laced case

4.1 Generators for the cohomology

For the convenience of the reader, we reproduce here arguments of [ChMaPe08] on well known fact concerning the cohomology of a rational finite dimensional homogeneous space G/P . As we have seen we may assume that P is maximal. The cohomology with coefficients in a ring k will be denoted with $H^*(X, k)$.

First, we recall the *Borel presentation* of the cohomology ring with rational coefficients. Let W (resp. W_P) be the Weyl group of G (resp. of P). Let \mathcal{P} denote the weight lattice of G . The Weyl group W acts on \mathcal{P} . We have

$$H^*(G/P, \mathbb{Q}) \simeq \mathbb{Q}[\mathcal{P}]^{W_P} / \mathbb{Q}[\mathcal{P}]_+^W,$$

where $\mathbb{Q}[\mathcal{P}]^{W_P}$ denotes the ring of W_P -invariants polynomials on the weight lattice, and $\mathbb{Q}[\mathcal{P}]_+^W$ is the ideal of $\mathbb{Q}[\mathcal{P}]^{W_P}$ generated by W -invariants without constant term (see [Bor53, Proposition 27.3] or [BeGeGe73, Theorem 5.5]).

Recall that the full invariant algebra $\mathbb{Q}[\mathcal{P}]^W$ is a polynomial algebra $\mathbb{Q}[F_{e_1+1}, \dots, F_{e_{max}+1}]$, where e_1, \dots, e_{max} is the set $E(G)$ of exponents of G . If d_1, \dots, d_{max} denote the exponents of a Levi subgroup $L(P)$ of P , we get that $\mathbb{Q}[\mathcal{P}]^{W_P} = \mathbb{Q}[I_1, I_{d_1+1}, \dots, I_{d_{max}+1}]$, where I_1 represents the fundamental weight ϖ_P defining P . Geometrically, it corresponds to the hyperplane class.

Each W -invariant F_{e_i+1} must be interpreted as a polynomial relation between the W_P -invariants $I_1, I_{d_1+1}, \dots, I_{d_{max}+1}$. In particular, if e_i is also an exponent of the semi-simple $L(P)$ part of P , this relation allows to eliminate I_{e_i+1} . We thus get the presentation, by generators and relations,

$$H^*(G/P, \mathbb{Q}) \simeq \mathbb{Q}[I_1, I_{p_1+1}, \dots, I_{p_n+1}] / (R_{q_1+1}, \dots, R_{q_r+1}),$$

where $\{p_1, \dots, p_n\} = E(L(P)) - E(G)$ and $\{q_1, \dots, q_r\} = E(G) - E(L(P))$.

4.2 Quadrics

Let us start with the case of quadrics. Thus we consider the system of ϖ_1 -minuscule D_n -colored posets \mathbf{P}_0 given by the following maximal element:

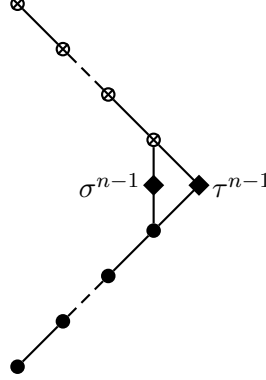

We have $S_0 = \{n-1, n\}$. For $i \in \{n-1, n\}$, let (D_i, d_i) be a marked Dynkin diagram and P_i be any d_i -minuscule D_i -colored poset. Set $\mathbf{P} = \mathbf{P}_{\mathbf{P}_0, \{P_{n-1}, P_n\}}$.

Lemma 4.1 *With the above notation, assume that Conjecture 2.10 holds for P_{n-1} , P_n and any λ in $I(\mathbf{P})$ with $D_0(\lambda) \not\subseteq D_n$. Then Conjecture 2.10 holds for \mathbf{P} .*

Proof. Let us define the degree $n-1$ ideals $\lambda_{n-1} = \langle (\alpha_{n-1}, 1) \rangle$ and $\mu_{n-1} = \langle (\alpha_n, 1) \rangle$ in \mathbf{P}_0 . The corresponding Schubert classes are denoted with σ^{n-1} and with τ^{n-1} . Let $\{\gamma^1, \gamma^{n-1}\}$ be a set of generators of the cohomology ring of the quadric, with $\deg(\gamma^i) = i$. The variety D_n/P_1 has dimension $2(n-1)$, the dimensions of $H^d(D_n/P_1)$ are

d	$d \neq n-1$	$n-1$
$\dim H^d(D_n/P_1)$	1	2

Since by assumption the conjecture holds for any $\lambda \in I(\mathbf{P})$ with $D(\lambda) \not\subseteq D_n$, we have $c_{\lambda, \mu}^\nu = t_{\lambda, \mu}^\nu$ as soon as $\nu \not\subseteq \mathbf{P}_0$.

By Proposition 2.11, γ^1 is a good generator. For γ^{n-1} , by Lemma 3.15, we have the equality $\gamma^{n-1} \cdot \sigma^\lambda = \gamma^{n-1} \odot \sigma^\lambda$ for any class σ^λ with $\deg(\lambda \cap \mathbf{P}_0) \leq n-2$. Furthermore, we have the equality $c_{\gamma^{n-1}, \sigma^\lambda}^{\sigma^\nu} = t_{\gamma^{n-1}, \sigma^\lambda}^{\sigma^\nu}$ for $\nu \not\subseteq \mathbf{P}_0$. For $\deg(\sigma^\lambda) = n-1$, we are left with the equality $c_{\gamma^{n-1}, \sigma^\lambda}^{\sigma^\nu} = t_{\gamma^{n-1}, \sigma^\lambda}^{\sigma^\nu}$ for $\nu = \mathbf{P}_0$. But in this case we are reduced to the same computation in the quadric and the result follows, for example by Poincaré duality. For higher degree, we use Lemma 3.15. \square

4.3 Type A_n

In this case, we consider the system of ϖ_p -minuscule A_n -colored posets \mathbf{P}_0 given by the poset of a Grassmannian $\mathbb{G}(p, n+1)$:

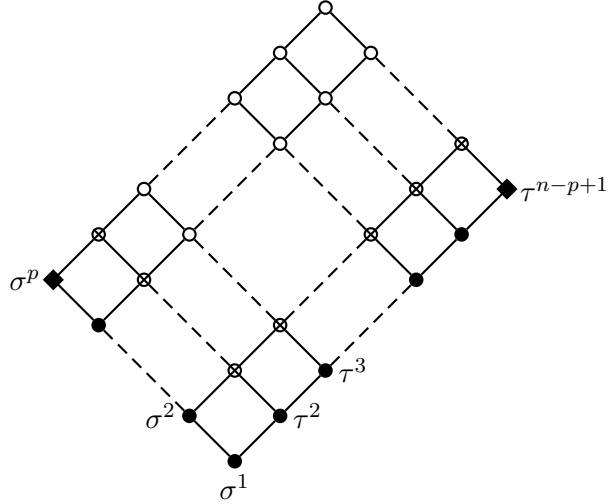

We have $S_0 = \{1, n\}$. For $i \in \{1, n\}$, let (D_i, d_i) be a marked Dynkin diagram and P_i be any d_i -minuscule D_i -colored poset. Set $\mathbf{P} = \mathbf{P}_{\mathbf{P}_0, \{P_1, P_n\}}$.

Lemma 4.2 *With the above notation, assume that Conjecture 2.10 holds for P_1, P_n , and any λ in $I(\mathbf{P})$ with $D_0(\lambda) \subsetneq A_n$. Then Conjecture 2.10 holds for \mathbf{P} .*

Proof. By Proposition 2.11, we may assume $n \geq 2$, by irreducibility of \mathbf{P}_0 we may then assume $n \geq 3$ and by Proposition 4.3, we may assume that $n \geq 4$.

Let us define the degree i ideals $\lambda_i = \langle (\alpha_{p+1-i}, 1) \rangle$ for $i \in [1, p]$ and $\mu_i = \langle (\alpha_{p+i-1}, 1) \rangle$ for $i \in [1, n+1-p]$ in \mathbf{P}_0 . The corresponding Schubert cells are denoted with σ^i and with τ^i . Take $(\gamma^i)_{i \in [1, p]}$ a set of generators of the cohomology ring of the Grassmannian, with $\deg(\gamma^i) = i$.

Since by assumption the conjecture holds for any $\lambda \in I(\mathbf{P})$ with $D_0(\lambda) \subsetneq A_n$, we have $c_{\lambda, \mu}^{\nu} = t_{\lambda, \mu}^{\nu}$ as soon as $\deg(\nu \cap \mathbf{P}_0) \leq 2n - 3$. In particular because for $n \geq 4$ we have $i + j \leq 2n - 3$ for $i \leq p$ and $j \leq n + 1 - p$, the equality $\gamma^i \cdot \sigma^j = \gamma^i \odot \sigma^j$ holds for all $i \leq p$ and $j \leq p$ and the equality $\gamma^i \cdot \tau^j = \gamma^i \odot \tau^j$ holds for all $i \leq p$ and $j \leq n + 1 - p$.

Now let $\lambda \in I(\mathbf{P}_0)$. If $\lambda \supset \lambda_p$ or $\lambda \supset \mu_{n+1-p}$, then by recursion with respect to λ_p or μ_{n+1-p} we have $\gamma^i \cdot \sigma^\lambda = \gamma^i \odot \sigma^\lambda$.

If $\lambda \not\supset \lambda_p$ and $\lambda \not\supset \mu_{n+1-p}$, then we first consider the case where λ is an ideal of the form $\langle (\alpha_k, l) \rangle$ for some simple root α_k and some integer l . We prove the equality $\gamma^i \cdot \sigma^\lambda = \gamma^i \odot \sigma^\lambda$ by induction on $\deg(\lambda)$ in that case. We may of course assume that λ is distinct from all the λ_i and the μ_j . Consider the two subideals λ' and λ'' in λ described by $\lambda' = \langle (\alpha_{k-1}, l') \rangle$ and $\lambda'' = \langle (\alpha_{k+1}, l'') \rangle$ where $l' = \max\{a / (\alpha_{k-1}, a) \in \lambda\}$ and $l'' = \max\{a / (\alpha_{k+1}, a) \in \lambda\}$. By recursion with respect to λ' or λ'' , we have $c_{\gamma^i, \sigma^\lambda}^{\sigma^\nu} = t_{\gamma^i, \sigma^\lambda}^{\sigma^\nu}$ for any ν not containing $(\alpha_{k-1}, l' + 1)$ or $(\alpha_{k+1}, l'' + 1)$. By induction on \mathbf{P}_0 it is also true if ν does not contain $(\alpha_1, 1)$ or $(\alpha_n, 1)$. For an ideal ν in \mathbf{P} containing all these elements of \mathbf{P}_0 , we have $\deg(\nu \cap \mathbf{P}_0) \geq \deg(\lambda) + n - 1$. For such a ν we have $c_{\gamma^i, \sigma^\lambda}^{\sigma^\nu} = 0 = t_{\gamma^i, \sigma^\lambda}^{\sigma^\nu}$ for degree reasons.

We finish by dealing with $\lambda \in I(\mathbf{P}_0)$ not of the previous form. Let us consider the set $M(\lambda)$ of maximal elements in λ . For $(\alpha_k, l) \in M(\lambda)$, define the ideal $\lambda(\alpha_k, l) = \langle (\alpha_k, l) \rangle$. By what we have just done, we have $\gamma^i \cdot \sigma^{\lambda(\alpha_k, l)} = \gamma^i \odot \sigma^{\lambda(\alpha_k, l)}$. In particular we can use recursion with respect to $\lambda(\alpha_k, l)$ and we deduce that $c_{\gamma^i, \sigma^\lambda}^{\sigma^\nu} = t_{\gamma^i, \sigma^\lambda}^{\sigma^\nu}$ for any ν not containing $(\alpha_k, l + 1)$. By induction on \mathbf{P}_0 it is also true if ν does not contain $(\alpha_1, 1)$ or $(\alpha_n, 1)$. For an ideal ν in \mathbf{P} containing all the elements

$(\alpha_k, l+1)$ for $(\alpha_k, l) \in M(\lambda)$ as well as $(\alpha_1, 1)$ and $(\alpha_n, 1)$, we have $\deg(\nu \cap \mathbf{P}_0) \geq \deg(\lambda) + n$. For such a ν we have $c_{\gamma^i, \sigma^\lambda}^{\sigma^\nu} = 0 = t_{\gamma^i, \sigma^\lambda}^{\sigma^\nu}$ for degree reasons. \square

4.4 Type D_n

In this case, we consider the system of ϖ_{n-1} -minuscule D_n -colored posets \mathbf{P}_0 given by the posets of an orthogonal Grassmannian $\mathbb{G}_Q(n, 2n)$. We have $S_0 = \{1, n\}$. For $i \in \{1, n\}$, let (D_i, d_i) be a marked Dynkin diagram and P_i be any d_i -minuscule D_i -colored poset. Set $\mathbf{P} = \mathbf{P}_{\mathbf{P}_0, \{P_1, P_n\}}$. The quiver \mathbf{P} for D_7 was described in (4).

Lemma 4.3 *With the above notation, assume that Conjecture 2.10 holds for P_1, P_n , and any λ in $I(\mathbf{P})$ with $D_0(\lambda) \not\subseteq D_n$. Then Conjecture 2.10 holds for \mathbf{P} .*

Proof. By irreducibility of \mathbf{P}_0 we may assume $n \geq 4$ and by Proposition 4.1, we may assume that $n \geq 5$.

Let us define the degree i ideals $\lambda_i = \langle (\alpha_{n-i}, 1) \rangle$ for $i \in [1, n-1]$ and the degree 3 ideal $\mu_3 = \langle (\alpha_n, 1) \rangle$. The corresponding Schubert cells are denoted with σ^i and with τ^3 . Take $(\gamma^i)_{i \in [1, n-1]}$ a set of generators of the cohomology ring of the isotropic Grassmannian, with $\deg(\gamma^i) = i$.

Since by assumption the conjecture holds for any $\lambda \in I(\mathbf{P})$ with $D_0(\lambda) \not\subseteq D_n$, we have $c_{\lambda, \mu}^{\nu} = t_{\lambda, \mu}^{\nu}$ as soon as $\deg(\nu \cap \mathbf{P}_0) \leq 2n-3$. In particular because for $n \geq 5$ we have $i+3 \leq 2n-3$ for $i \leq n-1$, the equality $\gamma^i \cdot \tau^3 = \gamma^i \odot \tau^3$ holds for all $i \leq n-1$.

For any ideal λ in \mathbf{P} containing μ_3 , we obtain by recursion with respect to τ^3 that $c_{\gamma^i, \sigma^\lambda}^{\sigma^\nu} = t_{\gamma^i, \sigma^\lambda}^{\sigma^\nu}$ for ν with $\deg(\nu \cap \mathbf{P}_0) \leq 2n-1$. In particular if $\deg(\lambda) \leq n-1$ we have $\deg(\lambda) + i \leq 2n-1$ and $\gamma^i \cdot \sigma^\lambda = \gamma^i \odot \sigma^\lambda$. But there is a unique class in $H^*(\mathbf{P})$ of degree $j \in [1, n-1]$ not bigger than τ^3 : the class σ^j , thus by Lemma 3.14 we obtain $\gamma^i \cdot \sigma^j = \gamma^i \odot \sigma^j$ for all i and j in $[1, n-1]$.

If $\lambda \supset \lambda_{n-1}$, then by recursion with respect to λ_{n-1} we have $\gamma^i \cdot \sigma^\lambda = \gamma^i \odot \sigma^\lambda$ for $i \in [1, n-1]$.

If $\lambda \not\supset \lambda_{n-1}$, then we first consider the case where λ is an ideal of the form $\langle (\alpha_k, l) \rangle$ for some simple root α_k and some integer l . We prove the equality $\gamma^i \cdot \sigma^\lambda = \gamma^i \odot \sigma^\lambda$ by induction on $\deg(\lambda)$ in that case. We may of course assume that λ is distinct from all the λ_i and from μ_3 . We have to discuss two cases. If $k \notin \{n-2, n-1, n\}$, then consider the three subideals λ', λ'' and λ''' in λ described by $\langle (\alpha_{k-1}, l') \rangle$, $\langle (\alpha_{k+1}, l'') \rangle$ and $\langle (\alpha_{k'}, l''') \rangle$ where $l' = \max\{a / (\alpha_{k-1}, a) \in \lambda\}$, $l'' = \max\{a / (\alpha_{k+1}, a) \in \lambda\}$ and $(\alpha_{k'}, l''')$ is the largest element in λ with $k' \in \{n-1, n\}$. If $k \in \{n-2, n-1, n\}$, then consider the subideal λ' in λ described by $\langle (\alpha_{k'}, l') \rangle$ where $(\alpha_{k'}, l')$ is the largest element in λ with $\{k, k'\} = \{n-1, n\}$. By recursion with respect to λ', λ'' or λ''' , we have $c_{\gamma^i, \sigma^\lambda}^{\sigma^\nu} = t_{\gamma^i, \sigma^\lambda}^{\sigma^\nu}$ for any ν not containing $(\alpha_{k-1}, l'+1)$, $(\alpha_{k+1}, l''+1)$ and $(\alpha_{k'}, l'''+1)$ in the first case and $(\alpha_{k'}, l'+1)$ in the second one. By induction on \mathbf{P}_0 it is also true if ν does not contain $(\alpha_1, 1)$. For an ideal ν in \mathbf{P} containing all these elements of \mathbf{P}_0 , we have $\deg(\nu \cap \mathbf{P}_0) \geq \deg(\lambda) + n-1$. For such a ν we have $c_{\gamma^i, \sigma^\lambda}^{\sigma^\nu} = 0 = t_{\gamma^i, \sigma^\lambda}^{\sigma^\nu}$ for degree reasons. Remark that here this method does not work for $i = n-1$ however, we proved the equality $c_{\gamma^{n-1}, \sigma^\lambda}^{\sigma^\nu} = t_{\gamma^{n-1}, \sigma^\lambda}^{\sigma^\nu}$ for all λ and ν except for some $\nu = \langle (\alpha_k, l+1) \rangle$. We obtain $c_{\gamma^{n-1}, \sigma^\lambda}^{\sigma^\nu} = t_{\gamma^{n-1}, \sigma^\lambda}^{\sigma^\nu}$ for this ν by Lemma 3.16.

We finish by dealing with λ not of the previous form. Let us consider the set $M(\lambda)$ of maximal elements in λ . For $(\alpha_k, l) \in M(\lambda)$, define the ideal $\lambda(\alpha_k, l) = \langle (\alpha_k, l) \rangle$. We have $\gamma^i \cdot \sigma^{\lambda(\alpha_k, l)} = \gamma^i \odot \sigma^{\lambda(\alpha_k, l)}$. In particular we can use recursion with respect to $\lambda(\alpha_k, l)$ and we deduce that $c_{\gamma^i, \sigma^\lambda}^{\sigma^\nu} = t_{\gamma^i, \sigma^\lambda}^{\sigma^\nu}$ for any ν not containing $(\alpha_k, l+1)$. By induction on \mathbf{P}_0 it is also true if ν does not contain $(\alpha_1, 1)$. For an ideal ν in \mathbf{P} containing all the elements $(\alpha_k, l+1)$ for $(\alpha_k, l) \in M(\lambda)$ as well as $(\alpha_1, 1)$, we have $\deg(\nu \cap \mathbf{P}_0) \geq \deg(\lambda) + n-1$. For such a ν we have $c_{\gamma^i, \sigma^\lambda}^{\sigma^\nu} = t_{\gamma^i, \sigma^\lambda}^{\sigma^\nu}$ for degree reasons. Once more, for $i = n-1$, we proved the equality $c_{\gamma^{n-1}, \sigma^\lambda}^{\sigma^\nu} = t_{\gamma^{n-1}, \sigma^\lambda}^{\sigma^\nu}$ for all ν except for $\nu = \langle (\alpha_1, 1), (\alpha_k, l) \in M(\lambda) \rangle$. We conclude by Lemma 3.16. \square

4.5 Type E_6 case

Let us start with the case of E_6/P_1 . Thus we consider the system of ϖ_1 -minuscule E_6 -colored posets \mathbf{P}_0 given by the following maximal element:

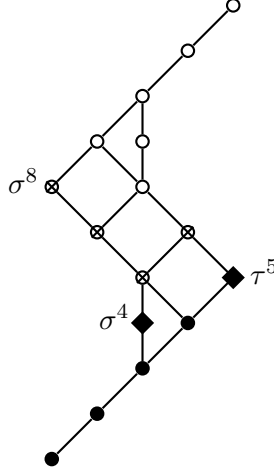

We have $S_0 = \{2, 6\}$. For $i \in \{2, 6\}$ let (D_i, d_i) be a marked Dynkin diagram and P_i be any d_i -minuscule D_i -colored poset. Set $\mathbf{P} = \mathbf{P}_{\mathbf{P}_0, (P_2, P_6)}$ with notation 3.3.

Lemma 4.4 *With the above notation, assume that Conjecture 2.10 holds for P_2, P_6 , and any λ in $I(\mathbf{P})$ with $D_0(\lambda) \not\subseteq E_6$. Then Conjecture 2.10 holds for \mathbf{P} .*

Proof. We consider the ideals $\lambda_4 = \langle(\alpha_2, 1)\rangle$ resp. $\mu_5 = \langle(\alpha_6, 1)\rangle$ in \mathbf{P}_0 , of degree 4 resp. 5. The corresponding Schubert cells are denoted with σ^4 resp. τ^5 . Let $\{\gamma^1, \gamma^4\}$ be a set of generators of the cohomology ring of E_6/P_1 , with $\deg(\gamma^i) = i$. The variety E_6/P_1 has dimension 16 and the dimensions of $H^d(E_6/P_1)$ are

d	0	1	2	3	4	5	6	7	8
$\dim H^d(E_6/P_1)$	1	1	1	1	2	2	2	2	3

Since by assumption the conjecture holds for any $\lambda \in I(\mathbf{P})$ with $D_0(\lambda) \not\subseteq E_6$, we have $c_{\lambda, \mu}^\nu = t_{\lambda, \mu}^\nu \cdot m_{\lambda, \mu}^\nu$ as soon as $\deg(\nu \cap \mathbf{P}_0) \leq 9$.

By Proposition 2.11, γ^1 is a good generator. By the above argument, we have $\gamma^4 \cdot \sigma = \gamma^4 \odot \sigma$ for all σ of degree at most 5. Furthermore, for any ideal λ in $I(\mathbf{P})$ such that $\deg(\lambda \cap \mathbf{P}_0) = 5$, we have $\lambda \supset \lambda_4$, $\lambda \supset \mu_5$ or $\lambda \subset \mathbf{P}_0$. In any case we have $\gamma^4 \cdot \sigma^\lambda = \gamma^4 \odot \sigma^\lambda$ either by recursion with respect to σ^4 , to τ^5 or by the previous argument. By Proposition 3.15 we get the same equality for σ^λ with $\deg(\lambda \cap \mathbf{P}_0) \leq 7$.

Let σ^λ be a degree 8 class associated to an ideal λ in \mathbf{P} . If λ is not contained in \mathbf{P}_0 , then $\deg(\lambda \cap \mathbf{P}_0) \leq 7$ and we have $\gamma^4 \cdot \sigma^\lambda = \gamma^4 \odot \sigma^\lambda$. Moreover, if $\lambda \supset \mu_5$, then by recursion with respect to τ^5 we have $\gamma^4 \cdot \sigma^\lambda = \gamma^4 \odot \sigma^\lambda$. Finally, there is a unique ideal λ in \mathbf{P} satisfying $\lambda \subset \mathbf{P}_0$ and $\lambda \not\supset \mu_5$. For this class we conclude by Lemma 3.14.

Let σ^λ be a class associated to an ideal λ in \mathbf{P} such that $\deg(\lambda \cap \mathbf{P}_0) = 8$. If $\lambda \not\subseteq \mathbf{P}_0$, then $\lambda \supset \lambda_4$ or $\lambda \supset \mu_5$ and we have $\gamma^4 \cdot \sigma^\lambda = \gamma^4 \odot \sigma^\lambda$ by recursion with respect to σ^4 or τ^5 . If $\lambda \subset \mathbf{P}_0$, then we already proved the equality $\gamma^4 \cdot \sigma^\lambda = \gamma^4 \odot \sigma^\lambda$. By Lemma 3.15, we get equality $\gamma^4 \cdot \sigma^\lambda = \gamma^4 \odot \sigma^\lambda$ for higher degree classes. \square

We now consider the case of E_6/P_2 . Thus we consider the system of ϖ_2 -minuscule E_6 -colored posets \mathbf{P}_0 given by:

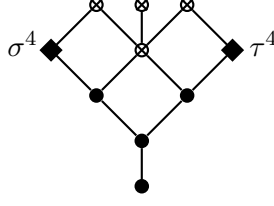

We have $S_0 = \{1, 6\}$. For $i \in \{1, 6\}$ let (D_i, d_i) be a marked Dynkin diagram and P_i be any d_i -minuscule D_i -colored poset. Set $\mathbf{P} = \mathbf{P}_{\mathbf{P}_0, (P_1, P_6)}$ with notation 3.3.

Lemma 4.5 *With the above notation, assume that Conjecture 2.10 holds for P_1, P_6 , and any λ in $I(\mathbf{P})$ with $D_0(\lambda) \not\subseteq E_6$. Then Conjecture 2.10 holds for \mathbf{P} .*

Proof. We consider the ideals $\lambda_4 = \langle(\alpha_1, 1)\rangle$ resp. $\mu_4 = \langle(\alpha_6, 1)\rangle$ in \mathbf{P}_0 both are of degree 4. The corresponding Schubert cells are denoted with σ^4 resp. τ^4 . Let $\{\gamma^1, \gamma^3, \gamma^4\}$ be a set of generators of the cohomology ring of E_6/P_2 , with $\deg(\gamma^i) = i$.

Since by assumption the conjecture holds for any $\lambda \in I(\mathbf{P})$ with $D_0(\lambda) \not\subseteq E_6$, we have $c'_{\lambda, \mu} = t'_{\lambda, \mu} \cdot m'_{\lambda, \mu}$ as soon as $\deg(\nu \cap \mathbf{P}_0) \leq 9$.

By Proposition 2.11, γ^1 is a good generator. By the previous argument, we have $\gamma^3 \cdot \sigma = \gamma^3 \odot \sigma$ for all σ in \mathbf{P}_0 of degree at most 6. In particular this holds for $\sigma = \sigma^4$ or $\sigma = \tau^4$. Let $\lambda \subset \mathbf{P}_0$ with $\deg(\lambda) \geq 7$. We have $\lambda \supset \lambda_4$ or $\lambda \supset \mu_4$ and by recursion with respect to σ^4 or τ^4 we get the equality $\gamma^3 \cdot \sigma = \gamma^3 \odot \sigma$ for $\sigma = \sigma^\lambda$.

By induction on \mathbf{P}_0 , we have $\gamma^4 \cdot \sigma = \gamma^4 \odot \sigma$ for all σ in \mathbf{P}_0 of degree at most 5. Let $\lambda \in I(\mathbf{P})$ with $\deg(\lambda \cap \mathbf{P}_0) \leq 6$. If $\deg(\lambda \cap \mathbf{P}_0) < 6$, then by induction on \mathbf{P}_0 we have $\gamma^4 \cdot \sigma^\lambda = \gamma^4 \odot \sigma^\lambda$. If $\deg(\lambda \cap \mathbf{P}_0) = 6$, then we have $\lambda \supset \lambda_4$ or $\lambda \supset \mu_4$ for all λ except one and by recursion with respect to σ^4 or τ^4 we get equality $\gamma^4 \cdot \sigma^\lambda = \gamma^4 \odot \sigma^\lambda$ for those λ . Equation $\gamma^4 \cdot \sigma^\lambda = \gamma^4 \odot \sigma^\lambda$ holds for the last ideal λ by Lemma 3.14. Finally, let $\lambda \subset \mathbf{P}_0$ with $\deg(\lambda) \geq 7$. We have $\lambda \supset \lambda_4$ or $\lambda \supset \mu_4$ and by recursion with respect to σ^4 or τ^4 we get equality $\gamma^4 \cdot \sigma^\lambda = \gamma^4 \odot \sigma^\lambda$ for σ^λ . \square

4.6 Type E_7 case

Let us start with the case of E_7/P_1 . Thus we consider the system of ϖ_1 -minuscule E_7 -colored posets \mathbf{P}_0 given by the following maximal elements:

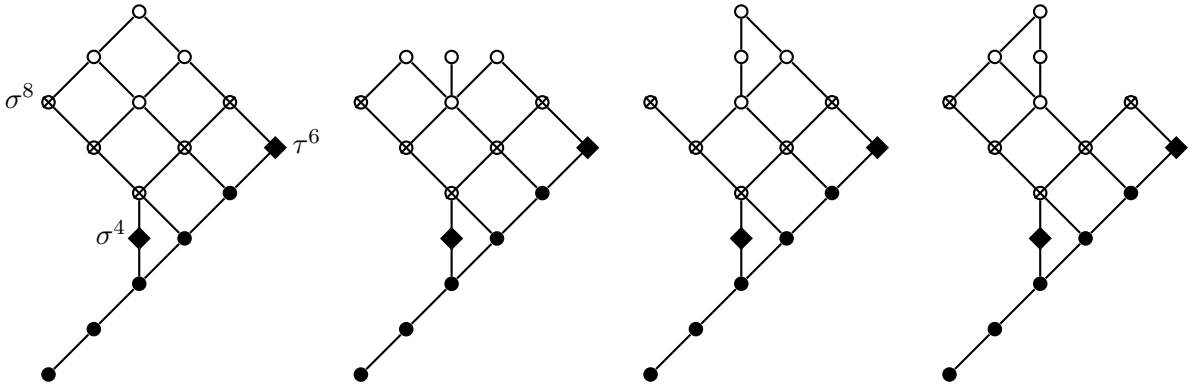

We have $S_0 = \{2, 7\}$. For $i \in \{2, 7\}$ let (D_i, d_i) be a marked Dynkin diagram and P_i be any d_i -minuscule D_i -colored poset. Set $\mathbf{P} = \mathbf{P}_{\mathbf{P}_0, (P_2, P_7)}$ with notation 3.3.

Lemma 4.6 *With the above notation, assume that Conjecture 2.10 holds for P_2, P_7 , and any λ in $I(\mathbf{P})$ with $D_0(\lambda) \subsetneq E_7$. Then Conjecture 2.10 holds for \mathbf{P} .*

Proof. We consider the ideals $\lambda_4 = \langle(\alpha_2, 1)\rangle$ resp. $\mu_6 = \langle(\alpha_7, 1)\rangle$ and $\lambda_8 = \langle(\alpha_1, 2)\rangle$ in \mathbf{P}_0 , of degree 4 resp. 6 and 8. The corresponding Schubert cells are denoted with σ^4 resp. τ^6 and σ^8 . Let $\{\gamma^1, \gamma^4, \gamma^6\}$ be a set of generators of the cohomology ring of E_7/P_1 , with $\deg(\gamma^i) = i$. The variety E_7/P_1 has dimension 33 and the dimensions of $H^d(E_7/P_1)$ are

d	0	1	2	3	4	5	6	7	8	9	10	11	12	13	14	15	16
$\dim H^d(E_7/P_1)$	1	1	1	1	2	2	3	3	4	4	5	5	6	6	6	6	7

Since by assumption the conjecture holds for any $\lambda \in I(\mathbf{P})$ with $D_0(\lambda) \subsetneq E_7$, we have $c'_{\lambda, \mu} = t'_{\lambda, \mu} \cdot m'_{\lambda, \mu}$ as soon as $\deg(\nu \cap \mathbf{P}_0) \leq 11$.

By Proposition 2.11, γ^1 is a good generator. By the above argument, we have $\gamma^4 \cdot \sigma = \gamma^4 \odot \sigma$ for all σ in \mathbf{P}_0 of degree at most 7. In particular this is valid for $\sigma = \sigma^4$, for τ^6 , for any class σ^λ with $\lambda \not\supset \lambda_4$ and for any class σ^λ with $\lambda \in I(\mathbf{P}) - I(\mathbf{P}_0)$. By recursion with respect to σ^4 , an ideal ν such that $c'_{\lambda_4, \lambda} \neq t'_{\lambda_4, \lambda}$ has to contain $(\alpha_2, 2)$ and in particular $\deg(\nu \cap \mathbf{P}_0) \geq 14$ (we also use induction with respect to \mathbf{P}_0). We thus have $\gamma^4 \cdot \sigma = \gamma^4 \odot \sigma$ for any class σ with $\deg(\sigma) \leq 9$. By recursion with respect to τ^6 or σ^8 we have $\gamma^4 \cdot \sigma^\lambda = \gamma^4 \odot \sigma^\lambda$ for any ideal $\lambda \supset \mu_6$ or $\lambda \supset \lambda_8$. As there is only one ideal $\lambda \in \mathbf{P}_0$ with $\lambda \not\supset \mu_6$ and $\lambda \not\supset \lambda_8$ in degree 10 and 11 and none in higher degree, we have $\gamma^4 \cdot \sigma = \gamma^4 \odot \sigma$ for any $\sigma \in H^*(\mathbf{P})$ by Lemma 3.14.

By induction on \mathbf{P}_0 , we have $\gamma^6 \cdot \sigma = \gamma^6 \odot \sigma$ for all σ in \mathbf{P}_0 of degree at most 5. Let $\sigma^\lambda \in H^*(\mathbf{P})$ of degree 6 and $\sigma^\lambda \neq \tau^6$, then $\lambda \supset \lambda_4$ and by recursion with respect to σ^4 we have $c'_{\mu_6, \lambda} = t'_{\mu_6, \lambda}$ for $\nu \not\supset (\alpha_2, 2)$ (or $\nu \not\supset (\alpha_6, 2)$ or $\nu \not\supset (\alpha_1, 2)$ by induction on \mathbf{P}_0). But for degree reasons we have $\deg(\nu \cap \mathbf{P}_0) \leq 12$ thus $\gamma^6 \cdot \sigma^\lambda = \gamma^6 \odot \sigma^\lambda$. By Lemma 3.14 we obtain $\gamma^6 \cdot \tau^6 = \gamma^6 \odot \tau^6$. In particular $\gamma^6 \cdot \sigma = \gamma^6 \odot \sigma$ for σ with associated ideal λ in $I(\mathbf{P}) - I(\mathbf{P}_0)$. By Lemma 3.15, we obtain $\gamma^6 \cdot \sigma = \gamma^6 \odot \sigma$ for σ of degree 7. As any degree 8 class in $H^*(\mathbf{P}_0)$ is a linear combination, in $H^*(\mathbf{P}_0)$, of $(\gamma^4)^{\odot 2}$ and multiples of γ^1 we conclude by Lemma 3.9 for degree 8 classes. For degree 9 classes we conclude by Lemma 3.15 and for higher degree classes we conclude as for γ^4 . \square

We now deal with the case E_7/P_2 . Thus we consider the system of ϖ_2 -minuscule E_7 -colored posets \mathbf{P}_0 given by:

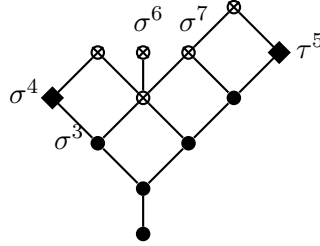

We have $S_0 = \{1, 7\}$. For $i \in \{1, 7\}$ let (D_i, d_i) be a marked Dynkin diagram and P_i be any d_i -minuscule D_i -colored poset. Set $\mathbf{P} = \mathbf{P}_{\mathbf{P}_0, (P_1, P_7)}$ with notation 3.3.

Lemma 4.7 *With the above notation, assume that Conjecture 2.10 holds for P_1, P_7 , and any λ in $I(\mathbf{P})$ with $D_0(\lambda) \subsetneq E_7$. Then Conjecture 2.10 holds for \mathbf{P} .*

Proof. We consider the ideals $\lambda_4 = \langle(\alpha_1, 1)\rangle$ resp. $\mu_5 = \langle(\alpha_7, 1)\rangle$ and $\lambda_6 = \langle(\alpha_2, 2)\rangle$ in \mathbf{P}_0 , of degree 4 resp. 5 and 6. The corresponding Schubert cells are denoted with σ^4 resp. τ^5 and σ^6 . Let $\{\gamma^1, \gamma^3, \gamma^4, \gamma^5, \gamma^7\}$ be a set of generators of the cohomology ring of E_7/P_2 , with $\deg(\gamma^i) = i$.

Since by assumption the conjecture holds for any $\lambda \in I(\mathbf{P})$ with $D_0(\lambda) \subsetneq E_7$, we have $c'_{\lambda, \mu} = t'_{\lambda, \mu} \cdot m'_{\lambda, \mu}$ as soon as $\deg(\nu \cap \mathbf{P}_0) \leq 11$.

By Proposition 2.11, γ^1 is a good generator. By the above argument, we have $\gamma^3 \cdot \sigma = \gamma^3 \odot \sigma$ for all σ in \mathbf{P}_0 of degree at most 8. In particular this equation is valid for $\sigma = \sigma^4$ and τ^5 . As any class σ^λ of degree at least 9 in $H^*(\mathbf{P}_0)$ satisfies $\lambda \supset \lambda_4$ or $\lambda \supset \mu_5$ we conclude by recursion with respect to σ^4 or τ^5 .

We know that $\gamma^4 \cdot \sigma^\lambda = \gamma^4 \odot \sigma^\lambda$ for all λ in $I(\mathbf{P})$ with $\deg(\lambda \cap \mathbf{P}_0) \leq 7$. In particular this equation is valid for $\lambda = \lambda_4$ and $\lambda = \mu_5$ and thus for any class σ^λ with $\lambda \in I(\mathbf{P}) - I(\mathbf{P}_0)$. As any class σ^λ of degree at least 8 in $H^*(\mathbf{P}_0)$ satisfies $\lambda \supset \lambda_4$ or $\lambda \supset \mu_5$ except one in degree 8, we conclude by recursion with respect to σ^4 or τ^5 and Lemma 3.14.

We know that $\tau^5 \cdot \sigma^\lambda = \tau^5 \odot \sigma^\lambda$ for all λ in $I(\mathbf{P})$ with $\deg(\lambda \cap \mathbf{P}_0) \leq 6$. In particular this equation is valid for $\lambda = \lambda_4$ and $\lambda = \mu_5$ and thus for any class σ^λ with $\lambda \in I(\mathbf{P}) - I(\mathbf{P}_0)$. As any class σ^λ of degree at least 7 in $H^*(\mathbf{P}_0)$ satisfies $\lambda \supset \lambda_4$ or $\lambda \supset \mu_5$ except one in degree 7 and one in degree 8, we conclude by recursion with respect to σ^4 or τ^5 and Lemma 3.14.

By what we already did and Lemma 3.9, we have $\gamma^7 \cdot \sigma = \gamma^7 \odot \sigma$ for all σ in $H^*(\mathbf{P}_0)$ of degree at most 6. In particular this equation is valid for $\sigma = \sigma^4$, $\sigma = \tau^5$ and $\sigma = \sigma^6$. As a consequence, it is also valid for any class σ^λ with $\lambda \in I(\mathbf{P}) - I(\mathbf{P}_0)$. As any class σ^λ of degree at least 7 in $H^*(\mathbf{P}_0)$ satisfies $\lambda \supset \lambda_4$, $\lambda \supset \mu_5$ or $\lambda \supset \lambda_8$, we conclude by recursion with respect to σ^4 , τ^5 or σ^6 . \square

We now deal with the case of E_7/P_7 . Thus \mathbf{P}_0 contains only one poset which is the following:

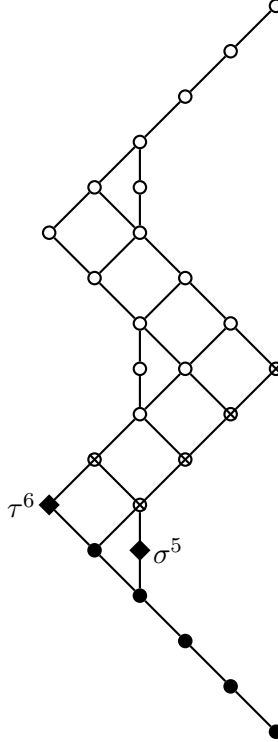

We have $S_0 = \{1, 2\}$. For $i \in \{1, 2\}$ let (D_i, d_i) be a marked Dynkin diagram and P_i be any d_i -minuscule D_i -colored poset. Set $\mathbf{P} = \mathbf{P}_{\mathbf{P}_0, (P_1, P_2)}$ with notation 3.3.

Lemma 4.8 *With the above notation, assume that Conjecture 2.10 holds for P_1, P_2 , and any λ in $I(\mathbf{P})$ with $D_0(\lambda) \subsetneq E_7$. Then Conjecture 2.10 holds for \mathbf{P} .*

Proof. Let σ^5 resp. τ^6 be the Schubert classes corresponding to the ideals generated by $(\alpha_2, 1)$ resp. $(\alpha_7, 1)$. They are of degree 5 resp. 6. Let $\{\gamma^1, \gamma^5, \gamma^9\}$ be a set of generators of $H^*(E_7/P_7)$, where γ^i has degree i . The variety E_7/P_7 has dimension 27 and the dimensions of $H^d(E_7/P_7)$ are

d	0	1	2	3	4	5	6	7	8	9	10	11	12	13
$\dim H^d(E_7/P_7)$	1	1	1	1	1	2	2	2	2	3	3	3	3	3

By Proposition 2.11, γ^1 is a good generator. If $c'_{\lambda,\mu} \neq t'_{\lambda,\mu} \cdot m'_{\lambda,\mu}$, then $\nu \cap \mathbf{P}_0$ must have degree at least 12. Thus $\gamma^5 \cdot \sigma = \gamma^5 \odot \sigma$ if $\deg(\sigma) \leq 6$. By recursion with respect to σ^5 and τ^6 we have $\gamma^5 \cdot \sigma^\lambda = \gamma^5 \odot \sigma^\lambda$ if $\lambda \in I(\mathbf{P}) - I(\mathbf{P}_0)$. Thus by Lemma 3.15 we have $\gamma^5 \cdot \sigma = \gamma^5 \odot \sigma$ if $\deg(\sigma) \leq 8$. Let $\mu, \nu \in I(\mathbf{P}_0)$ such that $c'_{\gamma^5,\mu} \neq t'_{\gamma^5,\mu} \cdot m'_{\gamma^5,\mu}$. Assume $\deg(\mu) = 9$. If $(\alpha_1, 1) \in \mu$ then by recursion with respect to τ^6 we have $(\alpha_1, 2) \in \nu$, thus $\deg(\nu) \geq 18$, a contradiction. Thus μ cannot contain $(\alpha_1, 1)$. Since there is a unique ideal in \mathbf{P}_0 of degree 9 not containing $(\alpha_1, 1)$ (namely $\langle(\alpha_6, 2)\rangle$), we conclude by Lemma 3.14 that $\gamma^5 \cdot \sigma = \gamma^5 \odot \sigma$ if $\deg(\sigma) = 9$. By Lemma 3.15, γ^5 is a good generator.

Since we know that $\gamma^9 \cdot \gamma^5 = \gamma^9 \odot \gamma^5$, by Lemma 3.9 we deduce that $\gamma^9 \cdot \sigma = \gamma^9 \odot \sigma$ if σ is in the subalgebra generated by γ^1 and γ^5 in $H^*(E_7/P_7)$ and in particular for $\deg(\sigma) \leq 9$. By recursion with respect to σ^5 and τ^6 we have $\gamma^9 \cdot \sigma^\lambda = \gamma^9 \odot \sigma^\lambda$ if $\lambda \in I(\mathbf{P}) - I(\mathbf{P}_0)$. Let $\mu, \nu \in I(\mathbf{P}_0)$ such that $c'_{\gamma^9,\mu} \neq t'_{\gamma^9,\mu} \cdot m'_{\gamma^9,\mu}$. Assume $\deg(\mu) = 9$. If $(\alpha_1, 1) \in \mu$ then by recursion with respect to τ^6 we have $(\alpha_1, 2) \in \nu$, thus $\nu = \langle(\alpha_1, 2), (\alpha_7, 2)\rangle$. Since there is a unique ideal in \mathbf{P}_0 of degree 9 not containing $(\alpha_1, 1)$ (namely $\langle(\alpha_6, 2)\rangle$), we conclude by Lemma 3.14 that $c'_{\gamma^5,\sigma} = t'_{\gamma^5,\sigma} \cdot m'_{\gamma^5,\sigma}$ except for $\nu = \langle(\alpha_1, 2), (\alpha_7, 2)\rangle$. For $\nu = \langle(\alpha_1, 2), (\alpha_7, 2)\rangle$, we only need to compute in $H^*(\mathbf{P}_0)$ and because \mathbf{P}_0 is a complete d -poset we conclude by Lemma 3.16. Then we conclude that γ^9 is a good generator by Lemma 3.15. \square

4.7 Type E_8 case

Let us start with the case of E_8/P_1 . Thus we consider the system of ϖ_1 -minuscule E_8 -colored posets \mathbf{P}_0 given by the three following maximal elements and their obvious intersections:

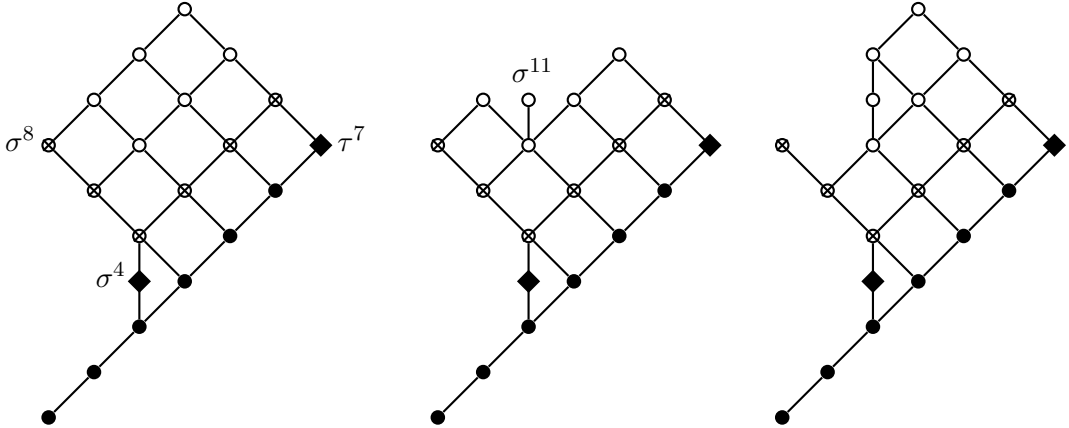

We have $S_0 = \{2, 8\}$. For $i \in \{2, 8\}$ let (D_i, d_i) be a marked Dynkin diagram and P_i be any d_i -minuscule D_i -colored poset. Set $\mathbf{P} = \mathbf{P}_{\mathbf{P}_0, (P_2, P_8)}$ with notation 3.3.

Lemma 4.9 *With the above notation, assume that Conjecture 2.10 holds for P_2, P_8 , and any λ in $I(\mathbf{P})$ with $D_0(\lambda) \subsetneq E_8$. Then Conjecture 2.10 holds for \mathbf{P} .*

Proof. For $i = 4$ resp. $7, 8, 11$ we consider the ideals $\lambda_i = \langle(\alpha_2, 1)\rangle$ resp. $\langle(\alpha_8, 1)\rangle, \langle(\alpha_1, 2)\rangle, \langle(\alpha_2, 2)\rangle$ in \mathbf{P}_0 , of degree i . The corresponding Schubert cells are denoted with σ^i . We denote τ^7 the Schubert cell corresponding to the ideal $\langle(\alpha_8, 1)\rangle$, and σ^{11} the cell corresponding to the ideal

$\langle(\alpha_2, 2)\rangle$ in the two last posets. Let $\{\gamma^1, \gamma^4, \gamma^6, \gamma^7, \gamma^{10}\}$ be a set of generators of the cohomology ring of E_8/P_1 , with $\deg(\gamma^i) = i$.

Since by assumption the conjecture holds for any $\lambda \in I(\mathbf{P})$ with $D_0(\lambda) \subsetneq E_8$, we have $c'_{\lambda, \mu} = t'_{\lambda, \mu} \cdot m'_{\lambda, \mu}$ as soon as $\deg(\nu \cap \mathbf{P}_0) \leq 13$.

By Proposition 2.11, γ^1 is a good generator. Let μ, ν such that $c'_{\gamma^4, \mu} \neq t'_{\gamma^4, \mu} \cdot m'_{\gamma^4, \mu}$. By the above we have $\deg(\nu) \geq 14$. In particular $\gamma^4 \cdot \sigma^4 = \gamma^4 \odot \sigma^4$. By recursion with respect to σ^4 we deduce that ν must contain $(\alpha_2, 2)$. Thus $\deg(\nu) \geq 16$. Thus $\gamma^4 \cdot \sigma^{11} = \gamma^4 \odot \sigma^{11}$. By recursion with respect to τ^7, σ^8 and σ^{11} we get that μ does not contain these elements. Since moreover μ must have degree at least 12 it follows that μ is one of the two elements $\langle(\alpha_5, 3)\rangle, \langle(\alpha_4, 3), (\alpha_6, 2)\rangle$, of degree respectively 13, 12. Thus we can conclude by Lemma 3.14 that γ^4 is a good generator.

Let us show that γ^6 is a good generator. Let μ, ν such that $c'_{\gamma^6, \mu} \neq t'_{\gamma^6, \mu} \cdot m'_{\gamma^6, \mu}$. We know that $\gamma^6 \cdot \sigma = \gamma^6 \odot \sigma$ for $\deg(\sigma) \leq 7$ thus for $\sigma \in \{\sigma^4, \tau^7\}$. By recursion with respect to these elements we deduce that μ cannot contain $(\alpha_8, 1)$, thus $(\alpha_2, 1) \in \mu$, and ν must contain $(\alpha_2, 2)$. Thus $\deg(\nu) \geq 16$ and $\gamma^6 \cdot \sigma = \gamma^6 \odot \sigma$ if $\deg(\sigma) \leq 9$. The number of Schubert classes of degree 9 resp. 10, 11, 12, 13, 14, 15, 16 not bigger than σ^8 and τ^7 is 3 resp. 3, 3, 2, 2, 1, 1, 0, and moreover the map induced by the multiplication by h is surjective on this sets. Thus we conclude thanks to Lemma 3.15(v).

Let μ, ν such that $c'_{\gamma^7, \mu} \neq t'_{\gamma^7, \mu} \cdot m'_{\gamma^7, \mu}$. Assume first that $\deg(\mu) = 7$. If $\mu \supset \sigma^4$ then by recursion with respect to σ^4 it follows that $(\alpha_2, 2) \in \nu$ and $\deg(\nu) \geq 16$, contradicting $\deg(\mu) = 7$. Since there is only one cell of degree 7 which is not bigger than σ^4 (namely τ^7), it follows that $\gamma^7 \cdot \sigma = \gamma^7 \odot \sigma$ if $\deg(\sigma) = 7$. By recursion with respect to τ^7 we also have this property for any $\mu \supset \lambda_7$. Thus, again by recursion with respect to σ^4 , $\gamma^7 \cdot \sigma = \gamma^7 \odot \sigma$ if $\deg(\sigma) \leq 8$. By recursion with respect to σ^8 we have $(\alpha_1, 2) \notin \mu$. Since $h^8(E_8/P_1) = h^9(E_8/P_1) = 5$, we deduce from Lemma 3.15 that $\gamma^7 \cdot \sigma = \gamma^7 \odot \sigma$ if $\deg(\sigma) = 9$. Then we can argue as for γ^6 .

For γ^{10} we already know that $\gamma^{10} \cdot \sigma = \gamma^{10} \odot \sigma$ if (σ) is one of the γ^i 's or $\sigma = \sigma^4$ or $\sigma = \tau^7$. By recursion with respect to σ^4 and τ^7 we deduce $\gamma^{10} \cdot \sigma^\lambda = \gamma^{10} \odot \sigma^\lambda$ if $\lambda \in I(\mathbf{P}) - I(\mathbf{P}_0)$, and since the γ^i 's for $i \leq 7$ generate $H^9(\mathbf{P}_0)$ we have $\gamma^{10} \cdot \sigma = \gamma^{10} \odot \sigma$ for $\deg(\sigma) = 9$. Then we can argue as for γ^6 and γ^7 . \square

We now consider the case of E_8/P_2 . Thus we consider the system of ϖ_2 -minuscule E_8 -colored posets \mathbf{P}_0 given by only one quiver \mathbf{P}_0 :

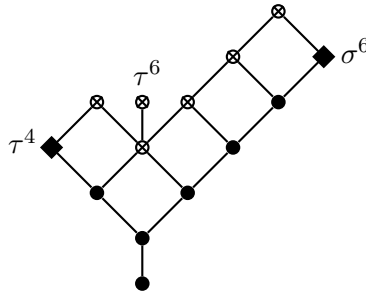

Set $S = S(D_0)$: we have $S = \{1, 8\}$. For $i \in \{1, 8\}$ let (D_i, d_i) be a marked Dynkin diagram and P_i be any d_i -minuscule D_i -colored poset. Set $\mathbf{P} = \mathbf{P}_{\mathbf{P}_0, (P_1, P_8)}$ with notation 3.3.

Lemma 4.10 *With the above notation, assume that Conjecture 2.10 holds for P_1, P_8 , and any poset \mathbf{P}' with $D_0(\mathbf{P}') \subsetneq E_8$. Then Conjecture 2.10 holds for \mathbf{P} .*

Proof. Let us define $\lambda_6 = \langle(\alpha_8, 1)\rangle$ and $\mu_4 = \langle(\alpha_1, 1)\rangle$ and define $\sigma^6 = \sigma^{\lambda_6}$ and $\tau^4 = \sigma^{\mu_4}$ which

are classes of degree 6 and 4 respectively. We also consider τ^6 which corresponds to the ideal $\mu_6 = \langle (\alpha_2, 2) \rangle$. Let $\{\gamma^1, \gamma^3, \gamma^4, \gamma^5, \gamma^6, \gamma^7\}$ be a set of generators of $H^*(E_8/P_2)$, with $\deg(\gamma^i) = i$.

Let $u, v, w \in W$ correspond to ideals $\lambda, \mu, \nu \in I(\mathbf{P})$. Since Conjecture 2.10 holds if $D_0(w) \not\subseteq E_8$, we may have $c_{\lambda, \mu}^\nu \neq t_{\lambda, \mu}^\nu \cdot m_{\lambda, \mu}^\nu$ only if $\nu \supset \mathbf{P}_0$.

By Proposition 2.11 γ^1 is a good generator. For γ^3 we therefore have $\gamma^3 \cdot \sigma = \gamma^3 \odot \sigma$ if $\deg(\sigma) \leq 10$. In particular $\gamma^3 \cdot \tau^4 = \gamma^3 \odot \tau^4$, $\gamma^3 \cdot \sigma^6 = \gamma^3 \odot \sigma^6$ and $\gamma^3 \cdot \tau^6 = \gamma^3 \odot \tau^6$. By recursion we deduce that $\gamma^3 \cdot \sigma = \gamma^3 \odot \sigma$ if the ideal λ associated to σ satisfies $\lambda \supset \lambda_6$, $\lambda \supset \mu_4$, or $\lambda \supset \mu_6$. If not, then $\deg(\sigma) \leq 9$. Thus γ^3 is a good generator. The same argument works for γ^4 .

For γ^5 the same argument says that we have $\gamma^5 \cdot \sigma^\lambda = \gamma^5 \odot \sigma^\lambda$ except possibly for the degree 9 ideal $\lambda = \langle (\alpha_6, 2) \rangle$.

But then we can use Lemma 3.14. Thus γ^5 is a good generator. For γ^6 the same argument also works because there is also only one element of degree 8 not bigger than σ^6, τ^6, τ^4 , namely $\langle (\alpha_5, 2), (\alpha_7, 1) \rangle$.

For γ^7 we observe that we have already shown that $\gamma^7 \cdot \sigma = \gamma^7 \odot \sigma$ for σ of degree at most 6 or $\sigma \geq \sigma^6$ or $\sigma \geq \tau^4$. Since $H^7(\mathbf{P}, \mathbb{Q})$ is generated as a \mathbb{Q} -vector space by $h \cdot H^6(\mathbf{P}, \mathbb{Q})$ and the elements σ greater than σ^6 or τ^4 , γ^7 is a good generator. \square

We finally deal with E_8/P_8 . Thus we consider the system of ϖ_8 -minuscule E_8 -colored posets \mathbf{P}_0 given by the seven following maximal elements and their obvious intersections:

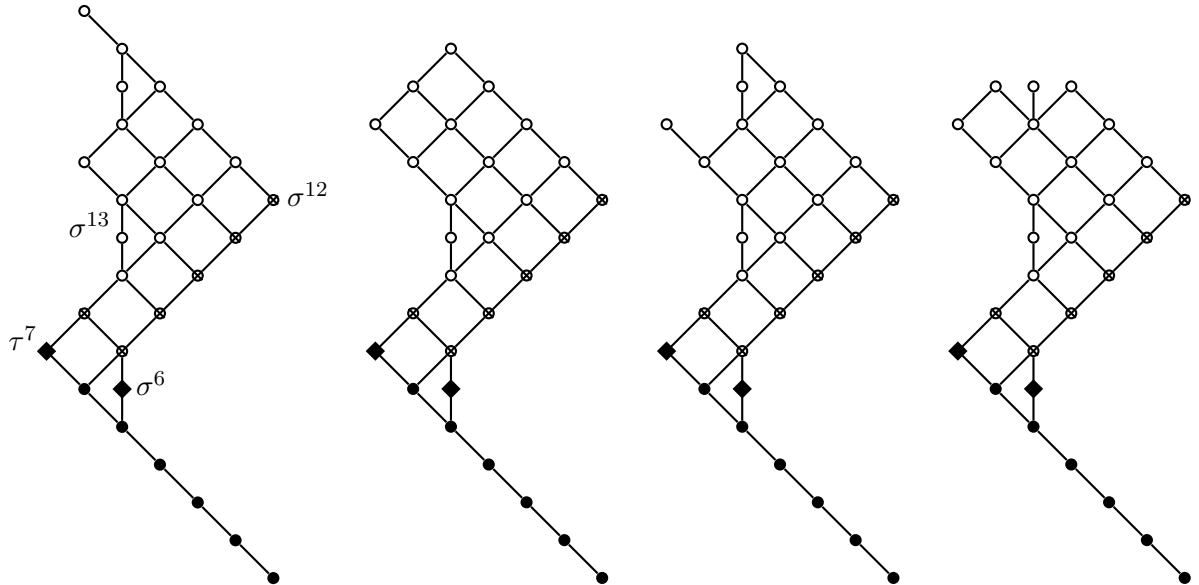

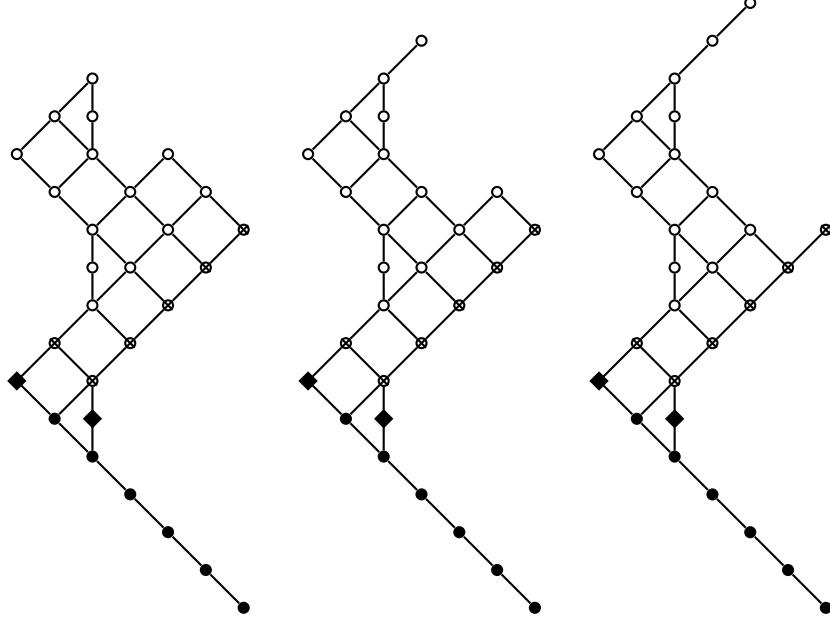

We have $S(D_0) = \{1, 2\}$. For $i \in \{1, 2\}$ let (D_i, d_i) be a marked Dynkin diagram and P_i be any d_i -minuscule D_i -colored poset. Set $\mathbf{P} = \mathbf{P}_{\mathbf{P}_0, (P_1, P_2)}$ with notation 3.3.

Lemma 4.11 *With the above notation, assume that Conjecture 2.10 holds for P_1, P_2 , and any λ in $I(\mathbf{P})$ with $D_0(\lambda) \not\subseteq E_8$. Then Conjecture 2.10 holds for \mathbf{P} .*

Proof. Set $\lambda_6 = \langle (\alpha_2, 1) \rangle$, set $\mu_7 = \langle (\alpha_1, 1) \rangle$, set $\lambda_{12} = \langle (\alpha_8, 2) \rangle$ and set $\lambda_{13} = \langle (\alpha_2, 2) \rangle$. Set $\sigma^i = \sigma^{\lambda_i}$ and $\tau^7 = \sigma^{\mu_7}$. Let $\{\gamma^1, \gamma^6, \gamma^{10}\}$ be a set of generators of $H^*(E_8/P_8)$, with $\deg(\gamma^i) = i$. By the hypothesis of the lemma we know that $c_{\lambda, \mu}^\nu = t_{\lambda, \mu}^\nu \cdot m_{\lambda, \mu}^\nu$ if $\deg(\nu) \leq 13$. Let us also give the dimensions of the graded parts of the cohomology:

d	0	1	2	3	4	5	6	7	8	9	10	11	12	13	14
$\dim H^d(E_8/P_8)$	1	1	1	1	1	1	2	2	2	2	3	3	4	4	4
d	15	16	17	18	19	20	21	22	23	24	25	26	27	28	
$\dim H^d(E_8/P_8)$	4	5	5	6	6	6	6	7	7	7	7	7	7	8	

By Proposition 2.11 we know that γ^1 is a good generator. For γ^6 we have $\gamma^6 \cdot \sigma = \gamma^6 \odot \sigma$ if $\sigma \leq 7$. In particular we get $\gamma^6 \cdot \tau^7 = \gamma^6 \odot \tau^7$ and $\gamma^6 \cdot \sigma^6 = \gamma^6 \odot \sigma^6$. Let μ, ν such that $c_{\gamma^6, \mu}^\nu \neq t_{\gamma^6, \mu}^\nu \cdot m_{\gamma^6, \mu}^\nu$. By recursion with respect to σ^6 and τ^7 we deduce that $\gamma^6 \cdot \sigma^\lambda = \gamma^6 \odot \sigma^\lambda$ if $\lambda \in I(\mathbf{P}) - I(\mathbf{P}_0)$. Thus $\mu \in I(\mathbf{P}_0)$.

Assume that $\deg(\mu) \leq 13$. By recursion with respect to τ^7 it follows that if $(\alpha_1, 1) \in \mu$ then $(\alpha_1, 2) \in \nu$. But ν must also contain $(\alpha_8, 2)$, thus $\deg(\nu) \geq 20$ and this contradicts $\deg(\mu) \leq 13$. Thus $(\alpha_1, 1) \notin \mu$. Since there is exactly one possible μ with $7 \leq \deg(\nu) \leq 12$ and none with $\deg(\mu) > 12$, by Lemma 3.14 it follows that $\gamma^6 \cdot \sigma = \gamma^6 \odot \sigma$ if $\deg(\sigma) \leq 13$. By Lemma 3.15 it follows that $\gamma^6 \cdot \sigma = \gamma^6 \odot \sigma$ if $\deg(\sigma) \leq 15$.

Let us assume that $\deg(\mu) = 16$ and $(\alpha_2, 2) \in \mu$. By recursion with respect to σ^{13} we deduce that $(\alpha_2, 3) \in \nu$. Since $(\alpha_1, 2) \in \nu$ also it follows that $\deg(\nu) \geq 23$, and we get a contradiction. Since moreover there is only one class μ of degree 16 such that $(\alpha_8, 2) \notin \mu$ and $(\alpha_2, 2) \notin \mu$, we conclude that $\deg(\mu) > 16$ by Lemma 3.14. By Lemma 3.15 it follows that $\gamma^6 \cdot \sigma = \gamma^6 \odot \sigma$ if $\deg(\sigma) \leq 17$.

There are three classes σ^λ of degree 17 resp. 18 such that $(\alpha_8, 2) \notin \lambda$, namely $\langle(\alpha_2, 2), (\alpha_6, 3)\rangle$, $\langle(\alpha_4, 4), (\alpha_7, 2)\rangle$, $\langle(\alpha_3, 2)\rangle$ resp. $\langle(\alpha_1, 2)\rangle$, $\langle(\alpha_3, 3), (\alpha_7, 2)\rangle$, $\langle(\alpha_4, 4), (\alpha_6, 3)\rangle$, and the corresponding map given by multiplication by h is surjective; thus we conclude thanks to Lemma 3.15(u) that $\gamma^6 \cdot \sigma = \gamma^6 \odot \sigma$ if $\deg(\sigma) = 18$. Then Lemma 3.15(v) gives the same identity for $\deg(\sigma) \leq 21$.

We finish showing that γ^6 is a good generator thanks again to Lemma 3.15(u), because there are exactly two classes in each degree 21 and 22 which are not bigger than σ^{12} .

We now consider γ^{10} . By Lemma 3.9 we have already proved that $\gamma^{10} \cdot \sigma = \gamma^{10} \odot \sigma$ for $\deg(\sigma) \leq 9$. For $\deg(\sigma) = 10$, we must consider some degrees and we shall assume $\gamma^{10} = \sigma^{10}$. Remark first that all classes $(\tau^{20,i})_{i \in [1,6]}$ of degree 20 in $H^*(\mathbf{P}_0)$ do not contain one of the vertices $(\alpha_1, 2)$ or $(\alpha_8, 2)$ except for $\tau^{20,4} = \langle(\alpha_1, 2), (\alpha_8, 2)\rangle$. In particular, we have the equalities $c_{\gamma^{10}, \sigma}^{\sigma'} = t_{\gamma^{10}, \sigma}^{\sigma'} \cdot m_{\gamma^{10}, \sigma}^{\sigma'}$ for all degree 10 classes σ and all degree 20 classes $\sigma' \neq \tau^{20,4}$. Let us be more precise here, define the following ideals

$$\begin{aligned} \lambda_{20,1} &= \langle(\alpha_4, 4), (\alpha_7, 3)\rangle & \lambda_{20,2} &= \langle(\alpha_5, 4), (\alpha_8, 2)\rangle & \lambda_{20,3} &= \langle(\alpha_3, 3), (\alpha_6, 3), (\alpha_8, 2)\rangle \\ \lambda_{20,4} &= \langle(\alpha_1, 2), (\alpha_8, 2)\rangle & \lambda_{20,5} &= \langle(\alpha_1, 2), (\alpha_6, 3)\rangle & \lambda_{20,6} &= \langle(\alpha_3, 3), (\alpha_5, 4)\rangle \end{aligned}$$

and the cohomology classes $\tau^{20,i} = \sigma^{\lambda_{20,i}}$ for $i \in [1, 6]$.

As we have seen, the algebras $H^*(\mathbf{P})$ and $H_t^*(X)$ coincide in degree 20 except maybe for that class $\tau^{20,4}$. Using jeu de taquin, we have the equality

$$\sigma^{10} \odot \sigma^{10} = 16\tau^{20,1} + 8\tau^{20,2} + 14\tau^{20,3} + 7\tau^{20,4} + 4\tau^{20,5} + 2\tau^{20,6}.$$

and because of the coincidence of the two algebras we get

$$\sigma^{10} \cdot \sigma^{10} = 16\tau^{20,1} + 8\tau^{20,2} + 14\tau^{20,3} + x\tau^{20,4} + 4\tau^{20,5} + 2\tau^{20,6}$$

for some non negative integer x . However, we are able to compute the coefficient $x = c_{\sigma^{10}, \sigma^{10}}^{\tau^{20,4}}$ using the degree of these classes. To compute x we use the Hasse diagram to obtain the following degrees:

$$\begin{aligned} \deg(\tau^{20,1}) &= 4322859480 & \deg(\tau^{20,2}) &= 6717795480 & \deg(\tau^{20,3}) &= 8298453240 \\ \deg(\tau^{20,4}) &= 1560699960 & \deg(\tau^{20,5}) &= 3789366840 & \deg(\tau^{20,6}) &= 10269733320 \\ \deg(\sigma^{10} \cdot \sigma^{10}) &= 285708294600. \end{aligned}$$

Remark that here we made the computation in the cohomology of the finite dimensional homogeneous space E_8/P_8 and used Poincaré duality over this space. The degree is linear and we get the value $x = 7$. Thus the two algebras also coincide in degree 20.

Let us remark here that these computation were made with the help of a computer. It is a quite easy computation for the Hasse diagram. For the jeu de taquin, we made an (easy) adaptation of the computer program written by H. Thomas and A. Yong for the cominuscule jeu de taquin.

Since any class of degree at most 19 can be expressed as $P(\gamma^1, \gamma^6) + \gamma^{10} \cdot Q(\gamma^1, \gamma^6)$ we have $\gamma^{10} \cdot \sigma = \gamma^{10} \odot \sigma$ if $\deg(\sigma) \leq 19$ by Lemma 3.11. For higher degree classes, we conclude as for γ^6 . \square

5 Non simply-laced case

5.1 General results for the push-forward of a minuscule class

We will now explain how it is possible to obtain Theorem 3.2 in the non simply-laced cases using folding. First we deal with the minuscule case. More precisely, let $(D_0, d_0), (E, e)$ be marked

Dynkin diagrams, p an integer, and $x_0 \in D_0$. We consider the disjoint union $\coprod_{1 \leq i \leq p} D_0^i$ of p copies of D_0 denoted D_0^i and an automorphism θ of $\coprod_i D_0^i$ induced by a cyclic permutation of order p of $[1, p]$. In each D_0^i we denote x_0^i the element corresponding to x_0 . We consider the Dynkin diagram obtained from the disjoint union of E and $\coprod_i D_0^i$ connecting each x_0^i with e . We still denote θ the automorphism of D extending θ by setting $\theta(x) = x$ for $x \in E$. Moreover we denote $d = d_0^1 \in D$.

Thus D defines a Kac-Moody algebra \mathfrak{g} , and θ an automorphism of \mathfrak{g} . We denote \mathfrak{g}^θ the subalgebra of invariant elements, with Dynkin diagram D^θ indexed by the equivalence classes of elements in D modulo θ , G^θ the corresponding subgroup of G , and W^θ the Weyl group of D^θ . For $i \in D$ let $\bar{i} \in D^\theta$ denote its natural projection. Denote \bar{D}_0 resp. \bar{E} the image of D_0^1 resp. E under this projection. We denote \bar{x}_0 the element \bar{x}_0^i for any $i \in [1, p]$.

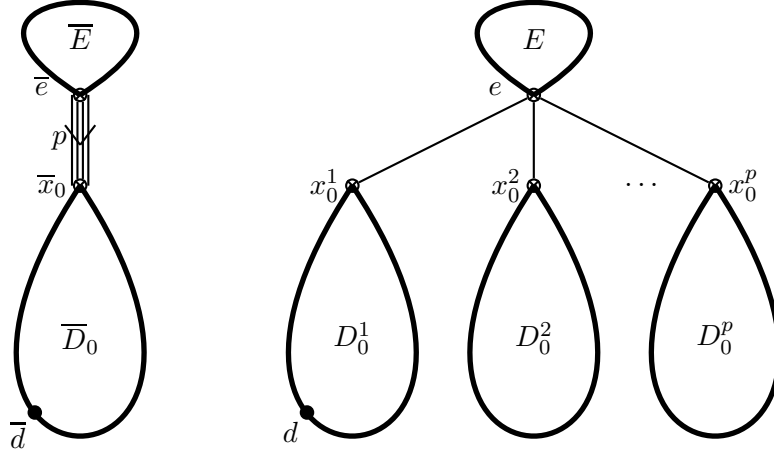

Let P resp. P^θ be the parabolic subgroup of G resp. G^θ corresponding to d resp. \bar{d} ; we have injections $i : W^\theta \rightarrow W$ and $\iota : G^\theta/P^\theta \rightarrow G/P$. Denoting with t_m the simple reflections in W^θ and with s_j the simple reflections in W , note that we have $i(t_m) = \prod_{j: \bar{j}=m} s_j \in W$. The idea to prove Conjecture 2.10 in this situation is to use the fact that $\iota^* : H^*(G/P) \rightarrow H^*(G^\theta/P^\theta)$ and $\iota_* : H^*(G^\theta/P^\theta) \rightarrow H^*(G/P)$ are adjoint and to compare Littlewood-Richardson coefficients on G/P with those on G^θ/P^θ . For this it is useful to show that minuscule Schubert cells are mapped to minuscule Schubert cells by ι_* .

We first show that if $p \geq 3$ then the situation is quite simple because there are very few \bar{d} -minuscule elements.

Lemma 5.1 *If $p \geq 3$ then any \bar{d} -minuscule element is either in $W(\bar{D}_0)$ or can be written as vu with $u \in W(\bar{D}_0)$ a \bar{d} -minuscule element and $v \in W(\bar{E})$ an \bar{e} -minuscule element.*

Proof. If the reflexion with respect to \bar{e} does not appear in a reduced expression of w , then clearly w belongs to $W(\bar{D}_0)$. Assuming now that there exists an integer k such that $m_k = \bar{e}$, since we have $\langle t_{m_{k+1}} \cdots t_{m_l}(\bar{\Lambda}), \beta_{\bar{x}_0}^\vee \rangle \geq -1$, we deduce $\langle t_{m_k} \cdots t_{m_l}(\bar{\Lambda}), \beta_{\bar{x}_0}^\vee \rangle \geq p - 1 \geq 2$, so that for all $k' \leq k$ we have $\langle t_{m_{k'}} \cdots t_{m_l}(\bar{\Lambda}), \beta_{\bar{x}_0}^\vee \rangle \geq 2$ and $m_{k'} \neq \bar{x}_0$. Therefore up to using some commutation relations we may write w as vu with $v \in W(\bar{E})$ and $u \in W(\bar{D}_0)$. Since any reduced expression of w satisfies the conditions of Definition 2.1, v is \bar{e} -minuscule and u is \bar{d} -minuscule. \square

Lemma 5.2 *Let $w \in W^\theta$ be \bar{d} -minuscule. Then the class of $i(w)$ in W/W_P can be represented by a unique d -minuscule element u . This element satisfies $l(u) = l(w)$ and we have the equality $\iota(\overline{B^\theta w P^\theta / P^\theta}) = \overline{BuP/P}$.*

Proof. Let Λ resp. $\bar{\Lambda}$ be the weight corresponding to d resp. \bar{d} . Then $\bar{\Lambda}$ is the restriction of Λ to \mathfrak{h}^θ . Let $\alpha_j, j \in D$ resp. $\beta_m, m \in D^\theta$ denote the simple roots of G resp. G^θ . Let us denote $t_m \in W^\theta$ the reflexion corresponding to $m \in D^\theta$. Let $w \in W^\theta$ be $\bar{\Lambda}$ -minuscule and let $w = t_{m_1} \cdots t_{m_l}$ be a reduced decomposition of w . Since w is $\bar{\Lambda}$ -minuscule, we have $\langle t_{m_2} \cdots t_{m_l}(\bar{\Lambda}), \beta_{m_1}^\vee \rangle = 1$. We have

$$\beta_{m_1}^\vee = \sum_{j: \bar{j}=m_1} \alpha_j^\vee,$$

thus we get that $\sum_j \langle \iota(t_{m_2} \cdots t_{m_l})(\Lambda), \alpha_j^\vee \rangle = 1$.

We claim that if $\bar{j} = m_1$ then $\langle \iota(t_{m_2} \cdots t_{m_l})(\Lambda), \alpha_j^\vee \rangle$ is nonnegative. In case $p > 2$ the claim is easily verified using Lemma 5.1.

Let us now assume that $p = 2$ and let us choose j with $\bar{j} = m_1$ and $\langle \iota(t_{m_2} \cdots t_{m_l})(\Lambda), \alpha_j^\vee \rangle > 0$. If j is the unique element k such that $\bar{k} = m_1$, then the claim is true, so we can assume that $\theta(j) \neq j$, so that $\{j, \theta(j)\} = \{k : \bar{k} = m_1\}$. For $w \in W$ let $l_P(w)$ denote the length of its minimal length representative in W/W_P . Since $Bi(t_{m_1} \cdots t_{m_l})P/P$ contains $\iota(B^\theta t_{m_1} \cdots t_{m_l} P^\theta / P^\theta)$, of dimension $l = l_{P^\theta}(w)$, we have $l_P(i(t_{m_1} \cdots t_{m_l})) \geq l$. By induction we may assume that $l_P(i(t_{m_2} \cdots t_{m_l})) = l - 1$. If $\langle \iota(t_{m_2} \cdots t_{m_l})(\Lambda), \alpha_{\theta(j)}^\vee \rangle < 0$, then we would have $l_P(s_{\theta(j)} \cdot \iota(t_{m_2} \cdots t_{m_l})) < l - 1$ and thus $l_P(\iota(t_{m_1} \cdots t_{m_l})) \leq l - 1$. We have already seen that this does not occur.

Thus the claim is proved and the class of $\iota(w)$ in W/W_P is equal to the class of $s_j \cdot t_{m_2} \cdots t_{m_l}$, and thus $l_P(\iota(w)) = l$. Moreover if u_2 is a d -minuscule element which represents the class of $i(t_{m_2} \cdots t_{m_l})$ in W/W_P , then $s_j \cdot u_2$ represents $i(w)$. Finally, ι restricts to an inclusion $B^\theta w P^\theta / P^\theta \rightarrow BuP/P$ of l -dimensional irreducible varieties, so we have the equality $\iota(\overline{B^\theta w P^\theta / P^\theta}) = \overline{BuP/P}$. \square

Notation 5.3 Let $w \in W^\theta$ be \bar{d} -minuscule. We denote $\bar{i}(w)$ the unique d -minuscule element in W which has the same class as $i(w)$ modulo P . Such an element exists by Lemma 5.2.

For $w \in W^\theta$ resp. $v \in W$ let σ_w, σ^w resp. τ_v, τ^v denote the corresponding homology and cohomology classes.

Lemma 5.4 (i) Let $w \in W^\theta$ be \bar{d} -minuscule. Then $\iota_* \sigma_w = \tau_{\bar{i}(w)}$.

(ii) Let $w \in W^\theta$ be \bar{d} -minuscule and assume that all degree d classes in G^θ/P^θ are d -minuscule. Then $\iota^* \tau^{\bar{i}(w)} = \sigma^w$.

Proof. Point (i) follows directly from Lemma 5.2. Let $w \in W^\theta$ be as in (ii). Then for $w' \in W^\theta$ a d -minuscule element one computes that

$$\langle \iota^* \tau^{\bar{i}(w)}, \sigma_{w'} \rangle = \langle \tau^{\bar{i}(w)}, \iota_* \sigma_{w'} \rangle = \langle \tau^{\bar{i}(w)}, \tau_{\bar{i}(w')} \rangle = \delta_{w', w} = \langle \sigma^w, \sigma_{w'} \rangle,$$

thus the lemma is proved. \square

5.2 Type B_n case

In this case, we consider the system of ϖ_n -minuscule B_n -colored posets \mathbf{P}_0 given by the poset of an isotropic Grassmannian $\mathbb{G}_Q(n, 2n+1)$. We have $S_0 = \{1\}$. Let (D_1, d_1) be a marked Dynkin diagram and P_1 be any d_1 -minuscule D_1 -colored poset. Set $\mathbf{P} = \mathbf{P}_{\mathbf{P}_0, \{P_1\}}$. We apply the above construction with D_0 reduced to one vertex $d_0 = d$, E obtained from a union $D_1 \cup A$, where A is of type A_{n-1} , attaching d_1 on the first node of A , e the last element of A , and $p = 2$. Thus D resp. D^θ is obtained as a union of D_1 and a Dynkin diagram of type D_{n+1} resp. B_n . Moreover we see

that the heaps of w and $\bar{\tau}(w)$ are isomorphic for any w corresponding to an ideal in \mathbf{P} (although they are not isomorphic as colored heaps).



Lemma 5.5 *With the above notation, assume that Conjecture 2.10 holds for P_1 . Then Conjecture 2.10 holds for \mathbf{P} .*

Proof. Let $\gamma^1, \dots, \gamma^n$ be a set of generators of $H^*(\mathbf{P}_0)$ with $\deg(\gamma^i) = i$. By Lemma 3.10 it is enough to show that $\gamma^i \cdot \sigma = \gamma^i \odot \sigma$ for any $\sigma \in H^*(\mathbf{P}_0)$.

Let $u_i \in W^\theta$ denote the element corresponding to γ^i . It is enough to show that for any elements v, w in W^θ we have $t_{u_i, v}^w = c_{u_i, v}^w$. We compute $c_{u_i, v}^w$ as the coefficient of σ_v in $\sigma^{u_i} \cap \sigma_w$. Since $\deg(\gamma^i) = i \leq n$, all classes of degree i correspond to ideals in \mathbf{P}_0 and thus are minuscule. So by Lemma 5.4 we deduce that $\iota^* \tau^{\bar{\tau}(u_i)} = \sigma^{u_i}$. Thus by Lemma 5.4 again we get

$$\iota_*(\sigma^{u_i} \cap \sigma_w) = \iota_*(\iota^* \tau^{\bar{\tau}(u_i)} \cap \sigma_w) = \tau^{\bar{\tau}(u_i)} \cap \iota_*(\sigma_w) = \tau^{\bar{\tau}(u_i)} \cap \tau_{\bar{\tau}(w)}.$$

Thus the coefficient of σ_v in $\sigma^{u_i} \cap \sigma_w$ is the same as the coefficient of $\tau_{\bar{\tau}(v)}$ in the cap product $\tau^{\bar{\tau}(u_i)} \cap \tau_{\bar{\tau}(w)}$. In other words $c_{u_i, v}^w = c_{\bar{\tau}(u_i), \bar{\tau}(v)}^{\bar{\tau}(w)}$. Now by Lemma 4.3 we know that the latter equals $t_{\bar{\tau}(u_i), \bar{\tau}(v)}^{\bar{\tau}(w)}$. Since the heaps of w and $\bar{\tau}(w)$ are isomorphic, we deduce $t_{\bar{\tau}(u_i), \bar{\tau}(v)}^{\bar{\tau}(w)} = t_{u_i, v}^w$. Therefore $c_{u_i, v}^w = t_{u_i, v}^w$, which is exactly what we wanted to prove. \square

5.3 Type F_4 minuscule case

In this case, we consider the system of ϖ_4 -minuscule F_4 -colored posets \mathbf{P}_0 given by the following picture:

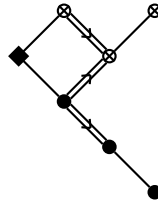

We have $S_0 = \{1\}$. Let (D_1, d_1) be a marked Dynkin diagram and P_1 be any d_1 -minuscule D_1 -colored poset. Set $\mathbf{P} = \mathbf{P}_{\mathbf{P}_0, \{P_1\}}$.



Lemma 5.6 *With the above notation, assume that Conjecture 2.10 holds for P_1 . Then Conjecture 2.10 holds for \mathbf{P} .*

Proof. Let γ^1, γ^4 be a set of generators of $H^*(\mathbf{P}_0)$ with $\deg(\gamma^i) = i$. By Lemma 3.10 it is enough to show that $\gamma^i \cdot \sigma = \gamma^i \odot \sigma$ for any $\sigma \in H^*(\mathbf{P}_0)$. For γ^1 this is already known by Proposition 2.11. Moreover by Lemma 3.15 (ii) it is enough to show that $\gamma^4 \cdot \gamma^4 = \gamma^4 \odot \gamma^4$.

To prove this we consider the above construction with D_0 of type A_2 and d_0 the first node of A_2 and d the last node, E obtained as a connected union of D_1 and again a Dynkin diagram of type A_2 , and $p = 2$. Here D resp. D^θ is a connected union of D_1 and a Dynkin diagram of type E_6 resp. F_4 (cf. the above picture). Again we see that the heaps of w and $\bar{\iota}(w)$ are isomorphic for any w corresponding to an ideal in \mathbf{P} .

The rest of the proof of the lemma is the same as for Lemma 5.5, using the fact that any class of degree 4 corresponding to an ideal in \mathbf{P} is minuscule and Lemma 4.4. \square

5.4 General result for Λ -cominuscule classes

Let (\mathcal{D}_0, d) be a marked Dynkin diagram, let G_0 be the associated Kac-Moody group and P_0 the corresponding parabolic subgroup. Let W_{G_0} the Weyl group of G_0 and let $w \in W_{G_0}^{P_0}$ (the set of minimal length representatives for P_0). We shall assume that \mathcal{D}_0 is the support of w . Choose a simple root α or equivalently a vertex of \mathcal{D}_0 (still denoted α) and a Dynkin diagram \mathcal{D}' containing \mathcal{D}_0 and one more root β only connected to α in \mathcal{D}' . If $\langle \beta, \alpha^\vee \rangle = p$ we also define a Dynkin diagram \mathcal{D} containing \mathcal{D}_0 and p more vertices labelled $(\beta_i)_{i \in [1, p]}$ all only connected to α with a simple edge. In the following we depicted \mathcal{D}' on the left and \mathcal{D} on the right.

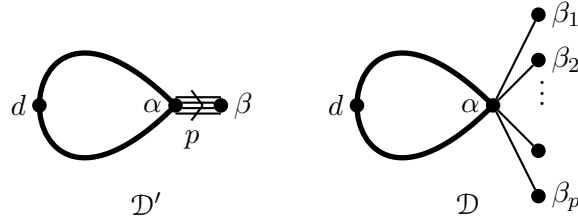

Let us denote with G' resp. G the group whose Dynkin diagram is \mathcal{D}' resp. \mathcal{D} and with P' resp. P the maximal parabolic subgroup of G' resp. G corresponding to the marked node d . We have a commutative diagram:

$$\begin{array}{ccc} G_0/P_0 & \xlongequal{\quad} & G_0/P_0 \\ \downarrow & & \downarrow \\ G'/P' & \xrightarrow{\iota} & G/P. \end{array}$$

We may define extended elements w' and $(w_i)_{i \in [1, n]}$ of w in $W_{G'}^{P'}$ and W_G^P by $w' = s_\beta w$ and $w_i = s_{\beta_i} w$. Their length is $l(w) + 1$. For example let us consider $w = s_{\alpha_1} s_{\alpha_3} s_{\alpha_2} s_{\alpha_4} s_{\alpha_3} s_{\alpha_2} s_{\alpha_1}$ in the Weyl group of F_4 (with notation as in [Bou54]). This is a ϖ_1 -cominuscule element. The elements w' and $(w_i)_{i \in [1, n]}$ will also be ϖ_1 -cominuscule. We depict here their heaps (in the following diagrams we depicted with crossed nodes the added vertices of w' and $(w_i)_{i \in [1, n]}$).

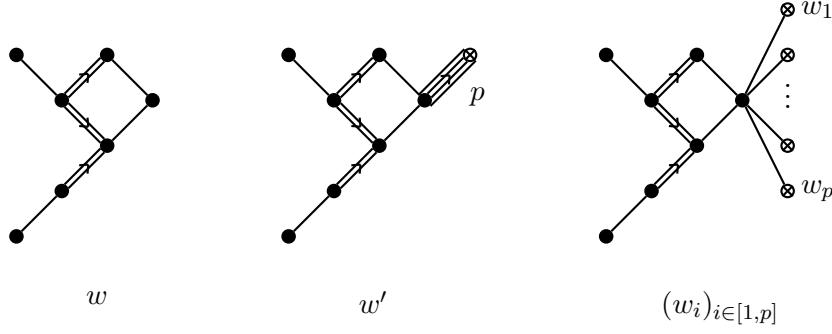

For w as above, we define σ_w the corresponding homology class in G_0/P_0 and also in G'/P' . We denote with τ_w the same class in $H_*(G/P)$. We denote with $\sigma_{w'}$ the homology class in G'/P' corresponding to w' and with τ_{w_i} the homology class in G/P corresponding to w_i for $i \in [1, p]$.

Proposition 5.7 *We have the equality $\iota_*\sigma_{w'} = \sum_{i=1}^p \tau_{w_i}$.*

Proof. We proceed by induction on the length of w . Let us write

$$\iota_*\sigma_{w'} = \sum_{x \in W_G^P: l(x)=l(w)+1} b_x \tau_x.$$

Let us first of all prove that the only classes appearing in this sum are the classes $(\tau_{w_i})_{i \in [1, p]}$.

Lemma 5.8 *Let $x \in W^P$ with $b_x > 0$, then we have $x = w_i$ for some $i \in [1, p]$.*

Proof. Let us introduce some notation. Let us denote with δ the simple root associated to the vertex d . We denote with $P'_{\beta, \delta}$ and P'_β (resp. $P_{\underline{\beta}, \delta}$ and $P_{\underline{\beta}}$) the parabolic subgroups of G' (resp. G) associated to the set of simple roots $\{\beta, \delta\}$ and $\{\beta\}$ (resp. $\{(\beta_i)_{i \in [1, p]}, \delta\}$ and $\{(\beta_i)_{i \in [1, p]}\}$). We also denote, for $u \in W_{G'}$ (resp. $v \in W_G$), with $X_{\beta, \delta}(u)$ and $X_\beta(u)$ (resp. $X_{\beta, \delta}(v)$ and $X_{\underline{\beta}}(v)$) the associated Schubert varieties in $G'/P'_{\beta, \delta}$ and G'/P'_β (resp. $G/P_{\beta, \delta}$ and $G/P_{\underline{\beta}}$). Finally we introduce the projections $p' : G'/P'_{\beta, \delta} \rightarrow G'/P'_\beta$ and $q' : G'/P'_{\beta, \delta} \rightarrow G'/P'_\beta$ (resp. $p : G/P_{\beta, \delta} \rightarrow G/P$ and $q : G/P_{\beta, \delta} \rightarrow G/P_{\underline{\beta}}$).

Choose a reduced expression $s_{\alpha_1} \cdots s_{\alpha_l}$ for w with α_i simple roots of G_0 . We must have the equality $\alpha_l = \delta$. We deduce a reduced expression $w' = s_\beta s_{\alpha_1} \cdots s_{\alpha_l}$. Let us consider the unipotent subgroup $U_w = U_{\alpha_1} \cdots U_{\alpha_l}$ of G_0 and the unipotent subgroup $U_{w'} = U_\beta U_w$ of G' . We have an inclusion $U_{w'} \subset U_{\beta_1} \cdots U_{\beta_p} U_w$. This induces the following inclusions of Schubert varieties $\iota : X(w') \subset X(s_{\beta_1} \cdots s_{\beta_p} w)$, $\iota_\beta : X_\beta(s_\beta) \subset X_{\underline{\beta}}(s_{\beta_1} \cdots s_{\beta_p} w)$ and $\iota_{\beta, \delta} : X_{\beta, \delta}(w') \subset X_{\underline{\beta}, \delta}(s_{\beta_1} \cdots s_{\beta_p} w)$. We have the commutative diagram:

$$\begin{array}{ccc}
 & X_\beta(s_\beta) \hookrightarrow X_{\underline{\beta}}(s_{\beta_1} \cdots s_{\beta_p} w) & \\
 & \uparrow q' & \uparrow q \\
 X_{\beta, \delta}(w') \hookrightarrow X_{\underline{\beta}, \delta}(s_{\beta_1} \cdots s_{\beta_p} w) & & \\
 \downarrow p' & & \downarrow p \\
 X(w') \hookrightarrow X(s_{\beta_1} \cdots s_{\beta_p} w) & &
 \end{array}$$

Remark that the Schubert variety $X_\beta(s_\beta)$ is isomorphic to the projective line \mathbb{P}^1 while the Schubert variety $X_{\underline{\beta}}(s_{\beta_1} \cdots s_{\beta_p})$ is isomorphic to $(\mathbb{P}^1)^p$ the map ι_β being given by the diagonal embedding.

Let τ_x be a class with $b_x > 0$. We thus have $x \leq s_{\beta_1} \cdots s_{\beta_p} w$. In particular, as any reduced expression for $s_{\beta_1} \cdots s_{\beta_p} w$ is obtained by multiplying on the left with $s_{\beta_1} \cdots s_{\beta_p}$ a reduced expression for w , we obtain (using the characterisation of Bruhat order described in [Dem74, Section 3 Proposition 5]) that

$$x = \prod_{k \in A} s_{\beta_k} y \quad (5)$$

with $A \subset [1, p]$ and $y \leq w$. The same argument gives that if we write

$$(\iota_{\beta, \delta})_* [X_{\beta, \delta}(w')] = \sum_{t \in W_G^{P_{\beta, \delta}} : l(t) = l(w) + 1} c_t \cdot [X_{\underline{\beta}, \delta}(t)],$$

then $c_t > 0$ implies

$$t = \prod_{k \in B} s_{\beta_k} u \quad (6)$$

with $B \subset [1, p]$ and $u \leq w$. We now prove that A has at most one element and for this, we prove that B has at most one element.

Let $[X_{\underline{\beta}, \delta}(t)]$ be a class with $c_t > 0$ and assume that in the expression (6) the set B contains at least two elements say i and j in $[1, p]$. Let us consider the two degree one cohomology classes h_i and h_j of $(\mathbb{P}^1)^p$ corresponding to the factors i and j . We have $(h_i \cup h_j) \cap [X_{\underline{\beta}, \delta}(t)] \neq 0$ by Chevalley formula and because $c_t > 0$ we get $(h_i \cup h_j) \cap (\iota_{\beta, \delta})_* [X_{\beta, \delta}(w')] \neq 0$. By projection formula we get $\iota_{\beta, \delta}^* (\iota_{\beta, \delta})_* ((h_i \cup h_j) \cap [X_{\beta, \delta}(w')]) \neq 0$. On the other hand we have $\iota_{\beta, \delta}^* (\iota_{\beta, \delta}^* (h_i \cup h_j) \cap [X_{\beta, \delta}(w')]) = 0$ because $\iota_{\beta, \delta}^* (h_i \cup h_j) = \iota_{\beta, \delta}^* q^* (h_i \cup h_j) = q^* \iota_{\beta}^* (h_i \cup h_j)$ and $\iota_{\beta}^* (h_i \cup h_j)$ vanishes as a degree 2 class on \mathbb{P}^1 , a contradiction. Thus B has at most one element.

Because the maps p' is birational, we have $p'_* [X_{\beta, \delta}(w')] = [X(w')] = \sigma_{w'}$ and thus the equality

$$\iota_* \sigma_{w'} = p_* (\iota_{\beta, \delta})_* [X_{\beta, \delta}(w')] = \sum_{t \in W_G^{P_{\beta, \delta}} : l(t) = l(w) + 1} c_t \cdot p_* [X_{\underline{\beta}, \delta}(t)].$$

Now for $t \in W_G^{P_{\beta, \delta}}$, we have

$$p_* [X_{\underline{\beta}, \delta}(t)] = \begin{cases} \tau_t & \text{for } t \in W_G^P \\ 0 & \text{otherwise.} \end{cases}$$

We deduce that A has only one element. Now from (5) and the fact that, $b_x > 0$ implies that $l(x) = l(w) + 1$, the result follows. \square

We deduce that there is an integer i such that $b_{w_i} > 0$. Furthermore, the group G' is obtained from G by taking the subgroup invariant by an automorphism of order p of the Dynkin diagram \mathcal{D} : the permutation of the p vertices we added to \mathcal{D}_0 . In particular the class $\iota_* \sigma_{w'}$ is invariant under this permutation thus we have the equalities $b_{w_i} = b_{w_j}$ for i and j in $[1, p]$. We may therefore set $b = b_{w_i}$ for any $i \in [1, p]$, we have $b > 0$ and

$$\iota_* \sigma_{w'} = b \sum_{i=1}^p \tau_{w_i}.$$

Computing the coefficient of τ_w in $h \cap \iota_* \sigma_{w'} = \iota_* (h \cap \sigma_{w'})$, we get the equality

$$bp \frac{(\alpha, \alpha)}{(\delta, \delta)} = p \frac{(\alpha, \alpha)}{(\delta, \delta)},$$

thus $b = 1$. \square

5.5 Type C_n case

In this case, we consider the system of ϖ_n -cominuscule C_n -colored posets \mathbf{P}_0 given by the posets of a Lagrangian Grassmannian $\mathbb{G}_\omega(n, 2n)$. We have $S_0 = \{1\}$. Let (D_1, d_1) be a marked Dynkin diagram and P_1 be any d_1 -minuscule D_1 -colored poset. Set $\mathbf{P} = \mathbf{P}_{\mathbf{P}_0, \{P_1\}}$. The heap \mathbf{P} for type C_6 is the same as the one for type D_7 except for the colors. It was described in (4).

Lemma 5.9 *With the above notation, assume that Conjecture 2.10 holds for P_1 and any λ in $I(\mathbf{P})$ with $D_0(\lambda) \not\subseteq C_n$. Then Conjecture 2.10 holds for \mathbf{P} .*

Proof. Let us define the degree i ideals $\lambda_i = \langle\langle \alpha_{n+1-i}, 1 \rangle\rangle$ for $i \in [1, n]$ and set $\sigma^i = s^{\lambda_i}$. Take a set of generators $\{\gamma^1, \dots, \gamma^n\}$ with $\deg(\gamma^i) = i$. We start to prove that the generators $(\gamma^i)_{i \in [1, n-1]}$ are good generators and shall prove at the end that γ^n is also a good generator.

Since by assumption the conjecture holds for any $\lambda \in I(\mathbf{P})$ with $D_0(\lambda) \not\subseteq C_n$, we have $c'_{\lambda, \mu} = t'_{\lambda, \mu}$ as soon as $\deg(\nu \cap \mathbf{P}_0) \leq 2n-2$. In particular if $\deg(\lambda) \leq n$ and $i \leq n-2$ we have $\deg(\lambda) + i \leq 2n-2$ and $\gamma^i \cdot \sigma^\lambda = \gamma^i \odot \sigma^\lambda$. Furthermore, for $i = n-1$ there is a unique ideal ν (namely $\nu = \langle\langle \alpha_2, 2 \rangle\rangle$) of degree $2n-1$ for which we cannot compute $c'_{\gamma^{n-1}, \lambda}$. By Lemma 3.16 we conclude that $\gamma^{n-1} \cdot \sigma^\lambda = \gamma^{n-1} \odot \sigma^\lambda$. In particular we have $\gamma^i \cdot \sigma^j = \gamma^i \odot \sigma^j$ for $i \in [1, n-1]$ and $j \in [1, n]$.

If $\lambda \supset \lambda_n$, then by recursion with respect to σ^n we have $\gamma^i \cdot \sigma^\lambda = \gamma^i \odot \sigma^\lambda$.

If $\lambda \not\supset \lambda_n$, then we first consider the case where λ is an ideal of the form $\langle\langle \alpha_k, l \rangle\rangle$ for some simple root α_k and some integer l . We prove the equality $\gamma^i \cdot \sigma^\lambda = \gamma^i \odot \sigma^\lambda$ by induction on $\deg(\lambda)$ in that case. We may of course assume that λ is distinct from all the λ_i . We consider the two subideals λ' and λ'' in λ described by $\langle\langle \alpha_{k-1}, l' \rangle\rangle$ and $\langle\langle \alpha_{k+1}, l'' \rangle\rangle$ (if $k = n$ we consider only λ') where $l' = \max\{a / (\alpha_{k-1}, a) \in \lambda\}$ and $l'' = \max\{a / (\alpha_{k+1}, a) \in \lambda\}$. By recursion with respect to λ' or λ'' , we have $c_{\gamma^i, \sigma^\lambda}^{\sigma^\nu} = t_{\gamma^i, \sigma^\lambda}^{\sigma^\nu}$ for any ν not containing $(\alpha_{k-1}, l' + 1)$ or $(\alpha_{k+1}, l'' + 1)$ (the last condition is empty for $k = n$). By induction on \mathbf{P}_0 it is also true if ν does not contain $(\alpha_1, 1)$. For an ideal ν in \mathbf{P} containing all these elements of \mathbf{P}_0 , we have $\deg(\nu \cap \mathbf{P}_0) \geq \deg(\lambda) + n - 1$. For such a ν and $i \leq n-2$, we have $c_{\gamma^i, \sigma^\lambda}^{\sigma^\nu} = 0 = t_{\gamma^i, \sigma^\lambda}^{\sigma^\nu}$ for degree reasons. For $i = n-1$ however, the equality $c_{\gamma^i, \sigma^\lambda}^{\sigma^\nu} = t_{\gamma^i, \sigma^\lambda}^{\sigma^\nu}$ holds for all $\lambda = \langle\langle \alpha_k, l \rangle\rangle$ and $\nu \neq \langle\langle \alpha_k, l + 1 \rangle\rangle$. We conclude by Lemma 3.16.

We finish by dealing with λ not of the previous form. Let us consider the set $M(\lambda)$ of maximal elements in λ . For $(\alpha_k, l) \in M(\lambda)$, define the ideal $\lambda(\alpha_k, l) = \langle\langle \alpha_k, l \rangle\rangle$. We have $\gamma^i \cdot \sigma^{\lambda(\alpha_k, l)} = \gamma^i \odot \sigma^{\lambda(\alpha_k, l)}$. In particular we can use recursion with respect to $\lambda(\alpha_k, l)$ and we deduce that $c_{\gamma^i, \sigma^\lambda}^{\sigma^\nu} = t_{\gamma^i, \sigma^\lambda}^{\sigma^\nu}$ for any ν not containing $(\alpha_k, l + 1)$. By induction on \mathbf{P}_0 it is also true if ν does not contain $(\alpha_1, 1)$. For an ideal ν in \mathbf{P} containing all the elements $(\alpha_k, l + 1)$ for $(\alpha_k, l) \in M(\lambda)$ as well as $(\alpha_1, 1)$, we have $\deg(\nu \cap \mathbf{P}_0) \geq \deg(\lambda) + n$. For such a ν and $i \leq n-1$, we have $c_{\gamma^i, \sigma^\lambda}^{\sigma^\nu} = 0 = t_{\gamma^i, \sigma^\lambda}^{\sigma^\nu}$ for degree reasons.

To finish the proof, we need to deal with γ^n . The first formula we need to verify is the equality $\gamma^n \cdot \gamma^n = \gamma^n \odot \gamma^n$. This will be the most difficult one. Indeed, assume this formula holds, then $\gamma^n \cdot \sigma^n = \gamma^n \odot \sigma^n$ and by recursion $\gamma^n \cdot \sigma^\lambda = \gamma^n \odot \sigma^\lambda$ for $\lambda \supset \lambda_n$. Now take $\lambda \not\supset \lambda_n$, then in the cohomology of $G_\omega(n-1, 2(n-1))$ we may write $\sigma^\lambda = P(\gamma^1, \dots, \gamma^{n-1})$ where P is a polynomial in $n-1$ variables. If we consider the class $P(\gamma^1, \dots, \gamma^{n-1})$ in $H^*(\mathbf{P})$ then its pull-back to $H^*(G_\omega(n-1, 2(n-1)))$ is σ^λ thus $P(\gamma^1, \dots, \gamma^{n-1}) = \sigma^\lambda + A$ where A is a linear combination of classes σ^μ with $\mu \supset \lambda_n$. We thus have $\gamma^n \cdot A = \gamma^n \odot A$. Furthermore, by Lemma 3.11 we have $\gamma^n \cdot P(\gamma^1, \dots, \gamma^{n-1}) = \gamma^n \odot P(\gamma^1, \dots, \gamma^{n-1})$ and the result follows.

To prove $\gamma^n \cdot \gamma^n = \gamma^n \odot \gamma^n$, we remark that there are two ideals ν of degree $2n$ for which we do not know that $c_{\gamma^n, \gamma^n}^{\sigma^\nu} = t_{\gamma^n, \gamma^n}^{\sigma^\nu} \cdot m_{\gamma^n, \gamma^n}^{\sigma^\nu}$. These ideals are $\nu = \langle\langle \alpha_2, 2 \rangle\rangle, \langle\langle \alpha_n, 3 \rangle\rangle$ and $\nu' = \langle\langle \alpha_0, 1 \rangle\rangle, \langle\langle \alpha_2, 2 \rangle\rangle$ where we denote with α_0 the simple root corresponding to the vertex d_1 in D_1 .

Since ν is contained in \mathbf{P}_0 and is the only class in that degree in \mathbf{P}_0 , we may apply Lemma 3.16 to get $c_{\gamma^n, \gamma^n}^{\sigma_\nu} = t_{\gamma^n, \gamma^n}^{\sigma_\nu} \cdot m_{\gamma^n, \gamma^n}^{\sigma_\nu}$. For ν' however, we may not apply Lemma 3.16 since $D_0(\nu')$ is not the Dynkin diagram of a finite group. However if the edge between α_0 and α_1 is simple, then $D_0(\nu') = C_{n+1}$ is of finite type and $c_{\gamma^n, \gamma^n}^{\sigma_{\nu'}} = t_{\gamma^n, \gamma^n}^{\sigma_{\nu'}} \cdot m_{\gamma^n, \gamma^n}^{\sigma_{\nu'}}$ by Lemma 3.16. If the edge between α_0 and α_1 is a p -tuple edge (i.e. $\langle \alpha_1, \alpha_0^\vee \rangle = p$), then by Proposition 5.7 we have

$$\iota_* \sigma_{\nu'} = \sum_{i=1}^p \tau_{\nu_i}$$

with notation as in Proposition 5.7. We then have, because $\iota^* \gamma^n = \gamma^n$, the equality

$$\iota_*(\gamma^n \cap \sigma_{\nu'}) = \sum_{i=1}^p \gamma^n \cap \tau_{\nu_i}$$

and it follows that $c_{\gamma^n, \gamma^n}^{\sigma_{\nu'}} = \sum_{i=1}^p c_{\gamma^n, \gamma^n}^{\tau_{\nu_i}}$ and the result follows. \square

5.6 Type F_4 cominuscule case

As for type C_n we shall need to use Proposition 5.7 and foldings to get the result. However, we need here one more step. Indeed, with the notation of Proposition 5.7, if $D = C_n$ then $D' = C_{n+1}$ is still of finite type with quite well understood cohomology, for $D = F_4$, then $D' = \tilde{F}_4^2$ which is a twisted affine Dynkin diagram (see [Kac90]). To compute some intersections in its cohomology we will use a folding of \tilde{E}_7^1 to \tilde{F}_4^2 and compute direct images by hand (this is done in Lemma 5.10 and in Proposition 5.12).

5.6.1 Foldings with F_4

We start with notation and set up. Let us denote with ι the inclusion of the group F_4 in the group E_6 given by folding of the Dynkin diagram. We also denote with ι the inclusion of F_4/P_1 in E_6/P_2 . We want to describe the map $\iota_* : H_*(F_4/P_1) \rightarrow H_*(E_6/P_2)$. For this we introduce some notation to describe the classes in these homology groups. Let Λ_F and Λ_E the fundamental weights corresponding to F_4/P_1 and E_6/P_2 respectively. Any element of length at most 7 in $(W_{F_4})^{P_1}$ is Λ_F -cominuscule. The two heaps of size 7 are as follows:

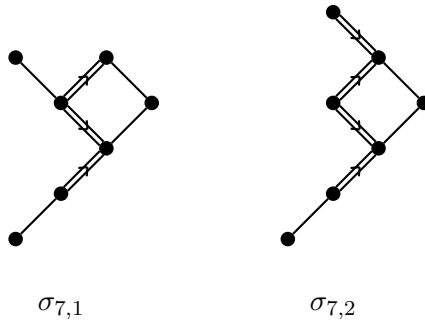

To fix notation we define the following homology classes in $H_*(F_4/P_1)$. These are all classes of degree $d \in [4, 7]$. By convention the notation $\sigma_{a,b}$ or $\tau_{a,b}$ (resp. $\sigma^{a,b}$ or $\tau^{a,b}$) denote homology (resp.

cohomology) classes of degree a . The set of all indices b is an index set of (co)homology classes of that degree. For example, as the following array shows, there are two homology classes of degree 4 denoted $\sigma_{4,1}$ and $\sigma_{4,2}$.

$$\begin{array}{llll} \sigma_{4,1} = \langle (\alpha_2, 2) \rangle & \sigma_{5,1} = \langle (\alpha_1, 2) \rangle & \sigma_{6,1} = \langle (\alpha_1, 2), (\alpha_4, 1) \rangle & \sigma_{7,1} = \langle (\alpha_1, 2), (\alpha_3, 2) \rangle \\ \sigma_{4,2} = \langle (\alpha_4, 1) \rangle & \sigma_{5,2} = \langle (\alpha_2, 2), (\alpha_4, 1) \rangle & \sigma_{6,2} = \langle (\alpha_3, 2) \rangle & \sigma_{7,2} = \langle (\alpha_2, 3) \rangle \end{array}$$

The two elements of length 8 are fully commutative. The heaps of these length 8 elements are as follows:

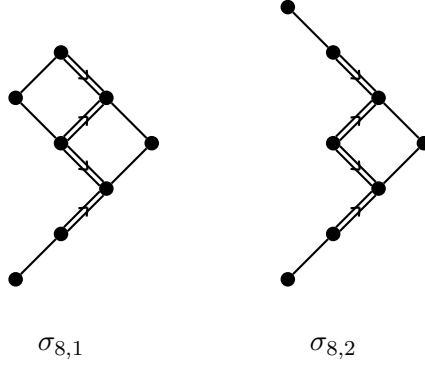

We define $\sigma_{8,1}$ to be the class associated to the left heap and $\sigma_{8,2}$ to be the class associated to the right one. Let us also give the Hasse diagram for F_4/P_1 . In the following picture we describe on the lowest raw the classes $\sigma_{i,1}$ and on the top raw the classes $\sigma_{i,2}$ with i growing from left to right. We also indicated the degree (with respect to the hyperplane class) of the lower dimension classes.

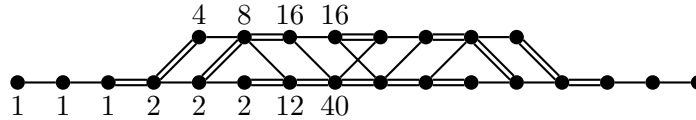

Let us now describe some classes in E_6/P_2 . Recall that we described the maximal slant-irreducible heap in E_6/P_2 in Section 4.5. To fix notation we define the following homology classes in $H_*(E_6/P_2)$. These are all classes of degree $d \in [3, 8]$.

$$\begin{array}{lll} \tau_{3,1} = \langle (\beta_3, 1) \rangle & \tau_{4,1} = \langle (\beta_1, 1) \rangle & \tau_{5,1} = \langle (\beta_1, 1), (\beta_5, 1) \rangle \\ \tau_{3,2} = \langle (\beta_5, 1) \rangle & \tau_{4,2} = \langle (\beta_3, 1), (\beta_5, 1) \rangle & \tau_{5,2} = \langle (\beta_4, 2) \rangle \\ & \tau_{4,3} = \langle (\beta_6, 1) \rangle & \tau_{5,3} = \langle (\beta_3, 1), (\beta_6, 1) \rangle \\ \tau_{6,1} = \langle (\beta_1, 1), (\beta_4, 2) \rangle & \tau_{7,1} = \langle (\beta_3, 2) \rangle & \tau_{8,1} = \langle (\beta_3, 2), (\beta_2, 2) \rangle \\ \tau_{6,2} = \langle (\beta_2, 2) \rangle & \tau_{7,2} = \langle (\beta_1, 1), (\beta_2, 2) \rangle & \tau_{8,2} = \langle (\beta_3, 2), (\beta_6, 1) \rangle \\ \tau_{6,3} = \langle (\beta_1, 1), (\beta_6, 1) \rangle & \tau_{7,3} = \langle (\beta_1, 1), (\beta_4, 2), (\beta_6, 1) \rangle & \tau_{8,3} = \langle (\beta_1, 1), (\beta_2, 2), (\beta_6, 1) \rangle \\ \tau_{6,4} = \langle (\beta_6, 1), (\beta_4, 2) \rangle & \tau_{7,4} = \langle (\beta_2, 2), (\beta_6, 1) \rangle & \tau_{8,4} = \langle (\beta_1, 1), (\beta_5, 2) \rangle \\ & \tau_{7,5} = \langle (\beta_5, 2) \rangle & \tau_{8,5} = \langle (\beta_5, 2), (\beta_2, 2) \rangle \end{array}$$

Lemma 5.10 *Let ι denote the inclusion of F_4/P_1 into E_6/P_2 . We have*

$$\begin{aligned} \iota_*\sigma_{4,1} &= \tau_{4,2} & \iota_*\sigma_{5,1} &= \tau_{5,2} & \iota_*\sigma_{6,1} &= \tau_{6,1} + \tau_{6,2} + \tau_{6,4} \\ \iota_*\sigma_{4,2} &= \tau_{4,1} + \tau_{4,2} + \tau_{4,3} & \iota_*\sigma_{5,2} &= \tau_{5,1} + \tau_{5,2} + \tau_{5,3} & \iota_*\sigma_{6,2} &= \tau_{6,1} + \tau_{6,3} + \tau_{6,4} \\ \iota_*\sigma_{7,1} &= \tau_{7,1} + \tau_{7,2} + \tau_{7,3} + \tau_{7,4} + \tau_{7,5} & \iota_*\sigma_{8,1} &= \tau_{8,1} + \tau_{8,2} + \tau_{8,3} + \tau_{8,4} + \tau_{8,5} \\ \iota_*\sigma_{7,2} &= \tau_{7,3} & \iota_*\sigma_{8,2} &= \tau_{8,2} + \tau_{8,3} + \tau_{8,4} \end{aligned}$$

Proof. We shall denote with h the hyperplane class in $H^*(E_6/P_2)$ and in $H^*(F_4/P_1)$ by identifying it to its pull-back. Let g be the Weyl involution of the Lie algebra \mathfrak{e}_6 . Then g induces an outer automorphism of E_6/P_2 , which fixes pointwise $\iota(F_4/P_1)$. Since $g \circ \iota = \iota$, we have $g_*\iota_*\sigma = \iota_*\sigma$ for $\sigma \in H_*(F_4/P_1)$. In other words, the classes in the image of ι_* are invariant under g .

Thus there exist non negative integers a, b, c, d such that

$$\begin{cases} \iota_*\sigma_{4,1} &= a(\tau_{4,1} + \tau_{4,3}) + b\tau_{4,2} \\ \iota_*\sigma_{4,2} &= c(\tau_{4,1} + \tau_{4,3}) + d\tau_{4,2}. \end{cases}$$

By the same argument there exist non negative integers $\alpha, \beta, \gamma, \delta, \epsilon, \eta$ such that

$$\begin{cases} \iota_*\sigma_{8,1} &= \alpha(\tau_{8,1} + \tau_{8,5}) + \beta(\tau_{8,2} + \tau_{8,4}) + \gamma\tau_{8,3} \\ \iota_*\sigma_{8,2} &= \delta(\tau_{8,1} + \tau_{8,5}) + \epsilon(\tau_{8,2} + \tau_{8,4}) + \eta\tau_{8,3}. \end{cases}$$

The degree of $\sigma_{4,1}$ resp. $\sigma_{4,2}, \tau_{4,1}, \tau_{4,2}, \tau_{4,3}$ is 2 resp. 4, 1, 2, 1 so we have

$$a + b = 1 \text{ and } c + d = 2. \quad (7)$$

The degree of $\sigma_{8,1}$ resp. $\sigma_{8,2}, \tau_{8,1}, \tau_{8,2}, \tau_{8,3}, \tau_{8,4}, \tau_{8,5}$ is 96 resp. 72, 12, 21, 30, 21, 12 so we have

$$24\alpha + 42\beta + 30\gamma = 96 \text{ and } 24\delta + 42\epsilon + 30\eta = 72. \quad (8)$$

To get more precise information we use the relation $\sigma^{4,2} \cup \sigma^{4,2} = \sigma^{8,1} + \sigma^{8,2}$, which follows from the fact that the degree of $(\sigma^{4,1})^2$ resp. $\sigma^{8,1}, \sigma^{8,2}$ is 56 resp. 40, 16 (here we identify via Poincaré duality the cohomology classes $\sigma^{8,i}$ with the homology classes $\sigma_{7,i}$ for $i \in \{1, 2\}$). We deduce the relations $\sigma^{4,1} \cup \sigma^{4,2} = 3\sigma^{8,1} + 2\sigma^{8,2}$ and $(\sigma^{4,1})^2 = 8\sigma^{8,1} + 6\sigma^{8,2}$. Thus one computes that $\iota^*\tau^{4,1} \cup \iota^*\tau^{4,1} = (8a^2 + 6ac + c^2)\sigma^{8,1} + (6a^2 + 4ac + c^2)\sigma^{8,2}$.

On the other hand using the jeu de taquin rule we have $\tau^{4,1} \cup \tau^{4,1} = \tau^{8,2}$ so $\iota^*(\tau^{4,1} \cup \tau^{4,1}) = \iota^*\tau^{8,2} = \beta\sigma_{8,1} + \epsilon\sigma_{8,2}$. This implies that $\beta = 8a^2 + 6ac + c^2$ and $\epsilon = 6a^2 + 4ac + c^2$. By (8) we have $\beta \leq 2$ so $a = 0$ and $\beta = c = 1$. By (7) and (8) we deduce the result for ι_* applied to degree 4 and 8 classes.

To compute ι_* for classes of degree lower than 8, we use the projection formula $h \cap \iota_*\sigma = \iota_*(h \cap \sigma)$. For example applying this to $\sigma_{8,1}$ and $\sigma_{8,2}$ we get

$$h \cap (\tau_{8,1} + \tau_{8,2} + \tau_{8,3} + \tau_{8,4} + \tau_{8,5}) = \iota_*(2\sigma_{7,1} + \sigma_{7,2}) \text{ and } h \cap (\tau_{8,2} + \tau_{8,3} + \tau_{8,4}) = \iota_*(\sigma_{7,1} + 2\sigma_{7,2}).$$

Resolving this system gives the result in degree 7. The same procedure gives the result in lower degrees. \square

Remark 5.11 Let us also remark that there is only one class in $H_*(F_4/P_1)$ in degree 3. We denote this class σ_3 . We have $\iota_*\sigma_3 = a\tau_{3,1} + b\tau_{3,2}$ but $2 = \deg(\sigma_3) = h^3 \cap \iota^*\sigma_3 = ah^3 \cap \tau_{3,1} + bh \cap \tau_{3,2} = a + b$ thus $a = b = 1$ by symmetry and $\iota_*\sigma_3 = \tau_{3,1} + \tau_{3,2}$.

We need to extend the Dynkin diagrams of F_4 and E_6 . We first consider the Kac-Moody groups \tilde{F}_4^2 and \tilde{E}_7^1 with the notation of [Kac90]. Their Dynkin diagrams are:

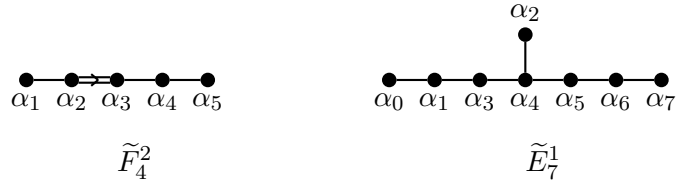

Any length 8 element is Λ_F -cominuscule and there are three new Λ_F -cominuscule heaps of length 8 in \tilde{F}_4^2 with heaps as follows:

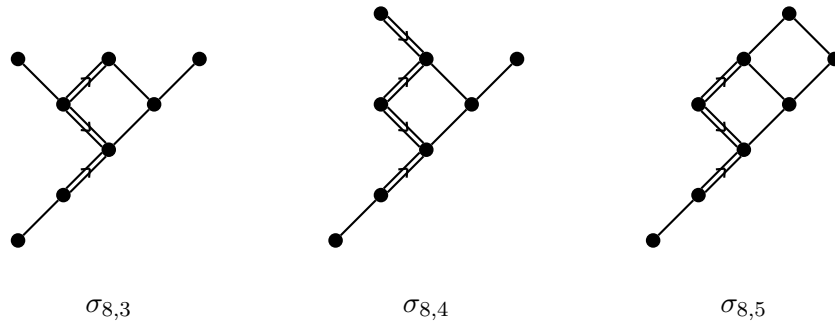

We shall also consider the following heap in \tilde{E}_7^1/P_2 :

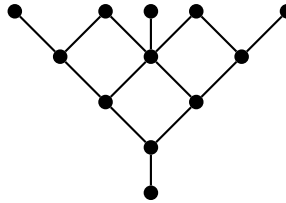

We complete our notation and define homology classes in $H_*(\tilde{F}_4^2/P_1)$. The previous classes are again classes and there are few more classes to obtain all classes of degree $d \in [4, 8]$.

$$\begin{aligned}
 \sigma_{5,3} &= \langle (\alpha_5, 1) \rangle & \sigma_{6,3} &= \langle (\alpha_2, 2), (\alpha_5, 1) \rangle & \sigma_{7,3} &= \langle (\alpha_1, 2), (\alpha_5, 1) \rangle & \sigma_{8,3} &= \langle (\alpha_1, 2), (\alpha_3, 2), (\alpha_5, 1) \rangle \\
 \sigma_{7,4} &= \langle (\alpha_3, 2), (\alpha_5, 1) \rangle & \sigma_{8,4} &= \langle (\alpha_2, 3), (\alpha_5, 1) \rangle & \sigma_{8,5} &= \langle (\alpha_4, 2) \rangle
 \end{aligned}$$

In the same way, we complete our notation and define homology classes in $H_*(\tilde{E}_7^1/P_2)$. The previous classes are again classes and there are few more classes to obtain all classes of degree

$d \in [4, 8]$. We define

$$\begin{array}{llll}
\tau_{5,4} = \langle (\beta_0, 1) \rangle & \tau_{6,5} = \langle (\beta_0, 1), (\beta_5, 1) \rangle & \tau_{7,6} = \langle (\beta_0, 1), (\beta_4, 2) \rangle & \tau_{8,6} = \langle (\beta_0, 1), (\beta_3, 2) \rangle \\
\tau_{5,5} = \langle (\beta_7, 1) \rangle & \tau_{6,6} = \langle (\beta_3, 1), (\beta_7, 1) \rangle & \tau_{7,7} = \langle (\beta_0, 1), (\beta_6, 1) \rangle & \tau_{8,7} = \langle (\beta_0, 1), (\beta_2, 2) \rangle \\
& & \tau_{7,8} = \langle (\beta_1, 1), (\beta_7, 1) \rangle & \tau_{8,8} = \langle (\beta_0, 1), (\beta_4, 2), (\beta_6, 1) \rangle \\
& & \tau_{7,7} = \langle (\beta_4, 2), (\beta_7, 1) \rangle & \tau_{8,9} = \langle (\beta_0, 1), (\beta_7, 1) \rangle \\
& & & \tau_{8,10} = \langle (\beta_1, 1), (\beta_4, 2), (\beta_7, 1) \rangle \\
& & & \tau_{8,11} = \langle (\beta_2, 2), (\beta_7, 1) \rangle \\
& & & \tau_{8,12} = \langle (\beta_5, 2), (\beta_7, 1) \rangle
\end{array}$$

We prove the following

Proposition 5.12 *We have the formula*

$$\tau_{4,1} \cap \iota_* \sigma_{8,3} = 4\tau_{4,1} + 12\tau_{4,2} + 4\tau_{4,3}.$$

Before going into the proof of this proposition, which is a long but simple computation we prove

Corollary 5.13 *We have the equalities*

$$c_{\sigma_{4,2}, \sigma_{4,2}}^{\sigma_{8,3}} = 4 = m_{\sigma_{4,2}, \sigma_{4,2}}^{\sigma_{8,3}} \cdot t_{\sigma_{4,2}, \sigma_{4,2}}^{\sigma_{8,3}} \quad \text{and} \quad c_{\sigma_{4,1}, \sigma_{4,2}}^{\sigma_{8,3}} = 8 = m_{\sigma_{4,1}, \sigma_{4,2}}^{\sigma_{8,3}} \cdot t_{\sigma_{4,1}, \sigma_{4,2}}^{\sigma_{8,3}}.$$

Proof. By Lemma 5.10, we have in F_4/P_1 the equality $\langle \iota^* \tau^{4,1}, \sigma_{4,i} \rangle = \langle \tau^{4,1}, \iota_* \sigma_{4,i} \rangle = \delta_{i,2}$. In particular, this implies the equality $\iota^* \tau^{4,1} = \sigma^{4,2}$. On the other hand, Lemma 5.10 and the previous Proposition imply the equality $\tau^{4,1} \cap \iota_* \sigma_{8,3} = \iota_*(8\sigma_{4,1} + 4\sigma_{4,2})$. We compute

$$\begin{aligned}
\iota_*(\sigma^{4,2} \cap \sigma_{8,3}) &= \iota_*(\iota^* \tau^{4,1} \cap \sigma_{8,3}) \\
&= \tau^{4,1} \cap \iota_* \sigma_{8,3} \\
&= 4\tau_{4,1} + 12\tau_{4,2} + 4\tau_{4,3} \\
&= \iota_*(8\sigma_{4,1} + 4\sigma_{4,2}).
\end{aligned}$$

The result follows by injectivity of ι_* . \square

Proof of Proposition 5.12. The main tool here will be the fact that the pull-back by ι of an hyperplane section is again an hyperplane section. We will write this as $\iota^* h = h$ and use it with projection formula to obtain

$$h \cap \iota_* \sigma = \iota_*(h \cap \sigma) \tag{9}$$

where $\sigma \in H_*(\tilde{F}_4^2/P_1)$. We shall also use the following observation: for $\sigma \in H_*(\tilde{F}_4^2/P_1)$ and $\tau \in H^*(\tilde{E}_7^1/P_2)$, the cap product $\tau \cap \iota_* \sigma$ is symmetric with respect to the folding. Indeed, we have $\tau \cap \iota_* \sigma = \iota_*(\iota^* \tau \cap \sigma)$. We shall in particular need the following cap products (we compute them using the product \odot which is valid for all degree 8 classes σ_λ in $H^*(\tilde{E}_7^1/P_2)$ because $D_0(\lambda)$ is of finite type and because we have already proved the simply laced case).

	$\tau_{6,1}$	$\tau_{6,2}$	$\tau_{6,3}$	$\tau_{6,4}$	$\tau_{6,5}$	$\tau_{6,6}$
$\tau^{3,1} \cap \bullet$	$2\tau_{3,1} + \tau_{3,2}$	$\tau_{3,2}$	$\tau_{3,1} + 2\tau_{3,2}$	$\tau_{3,1} + \tau_{3,2}$	$2\tau_{3,1} + \tau_{3,2}$	$\tau_{3,2}$
	$\tau_{8,1}$	$\tau_{8,2}$	$\tau_{8,3}$	$\tau_{8,4}$	$\tau_{8,5}$	$\tau_{8,6}$
$\tau^{4,1} \cap \bullet$	$\tau_{4,2}$	$\tau_{4,1} + \tau_{4,2}$	$\tau_{4,2} + \tau_{4,3}$	$\tau_{4,2}$	0	$2\tau_{4,1} + \tau_{4,2}$
	$\tau_{8,7}$	$\tau_{8,8}$	$\tau_{8,9}$	$\tau_{8,10}$	$\tau_{8,11}$	$\tau_{8,12}$
$\tau^{4,1} \cap \bullet$	$2\tau_{4,2}$	$\tau_{4,1} + 3\tau_{4,2} + \tau_{4,3}$	$\tau_{4,2} + 2\tau_{4,3}$	$\tau_{4,2} + \tau_{4,3}$	0	0

We will not explicitly commute the direct image $\iota_*\sigma_{8,3}$ (we will have four possible solutions) but this will be enough to get the result.

Write $\iota_*\sigma_{5,3} = a(\tau_{5,1} + \tau_{5,3}) + b\tau_{5,2} + c(\tau_{5,4} + \tau_{5,5})$ with (a, b, c) non negative integers. By equation (9), we get

$$2(\tau_{4,1} + \tau_{4,2} + \tau_{4,3}) = \iota_*(2\sigma_{4,2}) = \iota_*(h \cap \sigma_{5,3}) = h \cap \iota_*(a(\tau_{5,1} + \tau_{5,3}) + b\tau_{5,2} + c(\tau_{5,4} + \tau_{5,5}))$$

and the equalities $2a + b = 2 = a + c$. The only solutions are $(a, b, c) = (1, 0, 1)$ or $(0, 2, 2)$.

Now write $\iota_*\sigma_{6,3} = \alpha(\tau_{6,1} + \tau_{6,4}) + \beta\tau_{6,2} + \gamma\tau_{6,3} + \delta(\tau_{6,5} + \tau_{6,6})$ with $(\alpha, \beta, \gamma, \delta)$ non negative integers. As before, we get the equalities $\delta = c$, $\alpha + \gamma + \delta = a + 2$, $2\alpha + \beta = b + 2$. If $(a, b, c) = (1, 0, 1)$ then $(\alpha, \beta, \gamma, \delta) = (0, 2, 2, 1)$ or $(1, 0, 1, 1)$ and if $(a, b, c) = (0, 2, 2)$ then $(\alpha, \beta, \gamma, \delta) = (0, 4, 0, 2)$. Computing the cap product $\tau^{3,1} \cap \iota_*\sigma_{6,3}$ we see that the only solution for $(\alpha, \beta, \gamma, \delta)$ such that $\tau^{3,1} \cap \iota_*\sigma_{6,3}$ is symmetric with respect to the folding is $(1, 0, 1, 1)$ and we deduce that $(a, b, c) = (1, 0, 1)$.

Let us now write $\iota_*\sigma_{7,3} = x(\tau_{7,1} + \tau_{7,5}) + y(\tau_{7,2} + \tau_{7,4}) + z\tau_{7,3} + t(\tau_{7,6} + \tau_{7,9}) + u(\tau_{7,7} + \tau_{7,8})$ with (x, y, z, t, u) non negative integers. As before, we get the equalities $x + y + z + t = 3$, $2y = 2$, $z + 2u = 1$, $t + u = 1$. The only solution is $(x, y, z, t, u) = (0, 1, 1, 1, 0)$.

Write $\iota_*\sigma_{7,4} = x'(\tau_{7,1} + \tau_{7,5}) + y'(\tau_{7,2} + \tau_{7,4}) + z'\tau_{7,3} + t'(\tau_{7,6} + \tau_{7,9}) + u'(\tau_{7,7} + \tau_{7,8})$ with (x', y', z', t', u') non negative integers. As before, we get the equalities $x' + y' + z' + t' = 4$, $2y' = 0$, $z' + 2u' = 4$, $t' + u' = 2$. The only solutions are $(x', y', z', t', u') = (1, 0, 2, 1, 1)$ and $(4, 0, 0, 0, 2)$.

Write $\iota_*\sigma_{8,3} = A(\tau_{8,1} + \tau_{8,5}) + B(\tau_{8,2} + \tau_{8,4}) + C\tau_{8,3} + D(\tau_{8,6} + \tau_{8,12}) + E(\tau_{8,7} + \tau_{8,11}) + F(\tau_{8,8} + \tau_{8,10}) + G\tau_{8,9}$ with (A, B, C, D, E, F, G) non negative integers. We get the equalities $A + B + D = x' + 2$, $A + C + E = y' + 4$, $2B + C + 2F = z' + 4$, $D + E + F = t' + 2$, $F + G = u'$. If $(x', y', z', t', u') = (1, 0, 2, 1, 1)$ then $(A, B, C, D, E, F, G) = (0, 2, 2, 1, 2, 0, 1)$ or $(1, 1, 2, 1, 1, 1, 0)$ and if $(x', y', z', t', u') = (4, 0, 0, 0, 2)$ then $(A, B, C, D, E, F) = (4, 1, 0, 1, 0, 1, 1)$ or $(3, 2, 0, 1, 1, 0, 2)$. We now compute for all these solution the cap product with $\tau^{4,1}$. It gives in all cases $\tau^{4,1} \cap \iota_*\sigma_{8,3} = 4\tau_{4,1} + 12\tau_{4,2} + 4\tau_{4,3}$. \square

5.6.2 Proof for F_4

We consider the system of ϖ_1 -cominuscule F_4 -colored posets \mathbf{P}_0 given by the unique following poset:

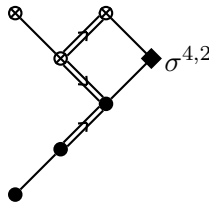

We have $S_0 = \{4\}$. Let (D_4, d_4) be a marked Dynkin diagram and P_4 be any d_4 -minuscule D_4 -colored poset. Set $\mathbf{P} = \mathbf{P}_{\mathbf{P}_0, \{P_4\}}$.

Lemma 5.14 *With the above notation, assume that Conjecture 2.10 holds for P_4 and any λ in $I(\mathbf{P})$ with $D_0(\lambda) \subsetneq F_4$. Then Conjecture 2.10 holds for \mathbf{P} .*

Proof. Choose some generators γ^1 and γ^4 of degree 1 and 4 of $H^*(\mathbf{P}_0)$. It is easy to see that we may choose $\gamma^4 = \sigma^{4,2}$ with the notation of the previous section. The variety F_4/P_1 has dimension 15 and the dimensions of $H^d(F_4/P_1)$ are

d	0	1	2	3	4	5	6	7	8
$\dim H^d(F_4/P_1)$	1	1	1	1	2	2	2	2	2

In particular by Lemma 3.15, we only need to prove $\gamma^4 \cdot \gamma^4 = \gamma^4 \odot \gamma^4$. Since by assumption the conjecture holds for any $\lambda \in I(\mathbf{P})$ with $D_0(\lambda) \subsetneq F_4$, we have $c_{\gamma^4, \gamma^4}^{\sigma_\nu} = t_{\gamma^4, \gamma^4}^{\sigma_\nu} \cdot m_{\gamma^4, \gamma^4}^{\sigma_\nu}$ as soon as the ideal ν , of degree 8 satisfies $(\alpha_1, 2) \notin \nu$ or $(\alpha_3, 2) \notin \nu$. There is a unique such ideal ν in \mathbf{P} . We denote it by ν' .

We first deal with the case $D_0(\nu') = \tilde{F}_4^2$. In that case, the class $\sigma_{\nu'}$ is $\sigma^{8,3}$ in the notation of the previous section. In particular, we have $c_{\gamma^4, \gamma^4}^{\sigma_{\nu'}} = c_{\sigma^{4,2}, \sigma^{4,2}}^{\sigma^{8,3}} = 4$ by Corollary 5.13.

Now we deal with the general case where $D_0(\nu')$ is obtained from F_4 by adding one vertex with n -tuple edge linking it to the simple root α_4 . By Proposition 5.7 and with the notation of that proposition, we have $\iota_* \sigma_{\nu'} = \sum_{i=1}^n \tau_{\nu_i}$. We then have, because $\iota^* \gamma^4 = \gamma^4$, the equality

$$\gamma^4 \cap \sigma_{\nu'} = \sum_{i=1}^n \gamma^4 \cap \tau_{\nu_i}$$

and it follows that $c_{\gamma^4, \gamma^4}^{\sigma_{\nu'}} = \sum_{i=1}^n c_{\gamma^4, \gamma^4}^{\tau_{\nu_i}}$ and the result follows. \square

References

- [BeGeGe73] Bernštejn, I. N., Gel'fand, I. M., Gel'fand, S. I., *Schubert cells and the cohomology of a flag space*. Funkcional. Anal. i Priložen. **7** (1973), no. 1.
- [Bor53] Borel, A., *Sur la cohomologie des espaces fibrés principaux et des espaces homogènes de groupes de Lie compacts*. Ann. of Math. (2) **57**, (1953).
- [Bou54] Bourbaki, N., *Groupes et algèbres de Lie*. Hermann 1954.
- [ChMaPe08] Chaput, P.-E., Manivel, L., Perrin, N., *Quantum cohomology of minuscule homogeneous spaces*. Transform. Groups **13** (2008), no. 1, 47–89.
- [ChPe09] Chaput, P.-E., Perrin, N., *Quantum cohomology of adjoint homogeneous spaces*. In preparation.
- [Dem74] Demazure, M., *Désingularisation des variétés de Schubert généralisées*. Collection of articles dedicated to Henri Cartan on the occasion of his 70th birthday, I. Ann. Sci. École Norm. Sup. (4) **7** (1974).
- [Dua05] Duan, H., *Multiplicative rule of Schubert class*. Invent. Math. **159** (2005), no. 2.
- [Kac90] Kac, V. G., *Infinite-dimensional Lie algebras*. Third edition. Cambridge University Press, Cambridge, 1990.
- [Kum02] Kumar, S., *Kac-Moody groups, their flag varieties and representation theory*. Progress in Mathematics, 204. Birkhäuser Boston, Inc., Boston, MA, 2002.
- [Laz04] Lazarsfeld, R., *Positivity in algebraic geometry. I. Classical setting: line bundles and linear series*. Ergebnisse der Mathematik und ihrer Grenzgebiete. 3. Folge. A Series of Modern Surveys in Mathematics, 48. Springer-Verlag, Berlin, 2004.
- [LiRi34] Littlewood, D.E., Richardson, A.R., *Group characters and algebras*. Phil. Trans. R. Soc. London Ser. A **233** (1934).

- [Per07] Perrin, N., *Small resolutions of minuscule Schubert varieties*. Compos. Math. **143** (2007), no. 5.
- [Pra91] Pragacz, P., *Algebro-geometric applications of Schur S- and Q-polynomials*. Topics in invariant theory (Paris, 1989/1990), Lecture Notes in Math., 1478, Springer, Berlin, 1991.
- [Pro99a] Proctor, R. A., *Minuscule elements of Weyl groups, the numbers game, and d-complete posets*. J. Algebra **213** (1999), no. 1.
- [Pro99b] Proctor, R. A., *Dynkin diagram classification of λ -minuscule Bruhat lattices and of d-complete posets*. J. Algebraic Combin. **9** (1999), no. 1.
- [Pro04] Proctor, R. A., *d-Complete posets generalize Young diagrams for the jeu de taquin property*. preprint 2004, available at <http://www.math.unc.edu/Faculty/rap>.
- [Sch77] Schützenberger, M.-P., *La correspondance de Robinson*. Combinatoire et représentation du groupe symétrique (Actes Table Ronde CNRS, Univ. Louis-Pasteur Strasbourg, Strasbourg, 1976). Lecture Notes in Math., Vol. 579, Springer, Berlin, 1977.
- [Ste96] Stembridge, J. R., *On the fully commutative elements of Coxeter groups*. J. Algebraic Combin. **5** (1996), no. 4.
- [Ste01] Stembridge, J. R., *Minuscule elements of Weyl groups*. J. Algebra **235** (2001), no. 2.
- [ThYo08] Thomas, H., Yong, A., *A combinatorial rule for (co)minuscule Schubert calculus*. To appear in Advances in Math.
- [VLe01] Van Leeuwen, M. A., *The Littlewood-Richardson rule, and related combinatorics*. Interaction of combinatorics and representation theory, MSJ Mem., **11**, Math. Soc. Japan, Tokyo, 2001.
- [Vie86] Viennot, G. X., *Heaps of pieces. I. Basic definitions and combinatorial lemmas*. Combinatoire énumérative (Montreal, Que., 1985/Quebec, Que., 1985), Lecture Notes in Math., **1234**, Springer, Berlin, 1986.
- [Wor84] Worley, D. R., *A theory of shifted Young tableaux*. Thesis, MIT, 1984. Available at <http://hdl.handle.net/1721.1/15599>.

Pierre-Emmanuel CHAPUT,

Laboratoire de Mathématiques Jean Leray, UMR 6629 du CNRS, UFR Sciences et Techniques, 2 rue de la Houssinière, BP 92208, 44322 Nantes cedex 03, France and
Max Planck Institut für Mathematik, Vivatsgasse 7, 53111 Bonn, Germany.
email: pierre-emmanuel.chaput@math.univ-nantes.fr.

Nicolas PERRIN,

Hausdorff Center for Mathematics, Universität Bonn, Villa Maria, Endenicher Allee 62, 53115 Bonn, Germany and
Institut de Mathématiques de Jussieu, Université Pierre et Marie Curie, Case 247, 4 place Jussieu, 75252 Paris Cedex 05, France.
email: nicolas.perrin@hcm.uni-bonn.de.