



## **ON THE APPLICATION AND LIMITATIONS OF SOUND-ABSORBING MATERIALS FOR AXIAL FAN BLADES**

Felix CZWIELONG<sup>1</sup>, Benedikt BERCHTENBREITER<sup>1</sup>, Christof OCKER<sup>2</sup>,  
Thomas F. GEYER<sup>3</sup>, Gabriel STOCKMEYER<sup>1</sup>,  
Markus MERKEL<sup>2</sup>, Stefan BECKER<sup>1</sup>

<sup>1</sup> *FAU Erlangen-Nuermberg, Aerodynamics and Acoustics, Institute of Fluid  
Mechanics, Cauerstr. 4, 91058 Erlangen, Germany*

<sup>2</sup> *Aalen University of Applied Sciences, Beethovenstr. 1,  
73430 Aalen, Germany*

<sup>3</sup> *Brandenburg University of Technology Cottbus-Senftenberg,  
Siemens-Halske-Ring 14, 03046 Cottbus, Germany*

### **SUMMARY**

In this work, various noise-reducing modifications known from airfoil investigations are applied to axial fans. Felts, micro-perforated plates, micro-porous resins, and porosities are applied to the leading edge of the fan blades. It was found that felts are unsuitable for the use in axial fans and that micro-perforated plates have too small active areas to be acoustically effective. The use of a separation layer indicated that a flow through the blade must exist in order to reduce noise emission. The high-frequency inherent noise of porosities can be attributed to a combination of roughness and flow-through. The investigations show that the direct effect of sound absorption on the achievable noise reduction is almost negligible.

### **INTRODUCTION**

Sound emission caused by axial fans continue to be a major challenge for research and industry. The disturbing noise of these machines should be reduced in order to comply with regulations and to increase acceptance [1]. To achieve this, various modifications have already been made to the blade, such as serrations, slots or waves, which are primarily intended to reduce the sound due to inflow turbulence [2-5]. Although these measures lead to a reduction of the sound radiation, the aerodynamic properties of the blade have also changed due to the modification. For a further refinement of blade modifications, an attempt was made to reduce sound generation from stationary airfoils by means of local porosity. This offers the advantage that the basic shape of the airfoil is retained. For example, airfoils were made from felts and porous resins. A correlation was found between the radiated sound pressure and the specific flow resistance of the materials [6, 7]. Low-

flow resistance led to lower sound radiation, but also lower aerodynamic properties. Attempts were also made to reduce the radiated sound power by introducing micro-perforated sound absorbers (MPA) on the surface of airfoils. For this purpose, a larger airfoil was equipped with a micro-perforated plate (MPP) and a cavity behind it [8]. Airfoils were also studied, which consist of a rigid skeleton with center separation, foam and a covering wire mesh. Sound reduction in the frequency range of 2 kHz – 18 kHz was achieved, but this was accompanied by an increase in the drag coefficient of the airfoil [9]. With the help of modern manufacturing techniques, additively manufactured structured porosities on airfoils and fans were investigated [10, 11]. These offer the possibility of individual adjustments to inflow turbulence and airfoil geometry with different designs of unit cells and positioning. Most of these investigations are currently limited to stationary airfoils and have not yet been investigated for application in rotating systems. Therefore, the question arises whether the materials investigated, such as felts, porous resins, MPP and structured porosities, are also suitable for application on axial fan blades. The interaction of these materials with the flow and the acoustics is also an unknown quantity; because it is not exactly known which sound reduction mechanism has which influence on the resulting sound pressure spectrum [12].

This paper investigates whether a transfer of sound reducing materials investigated on airfoils is also useful for axial fans and how the sound absorbing properties affect the sound pressure spectrum. In addition, the influence of separating layers on the noise reduction is investigated. Separating layers ensure that no flow can pass between the pressure side and the suction side of the blades.

## AXIAL FANS AND SOUND-ABSORBING MATERIALS

In this study, the influence of different permeable and sound-absorbing materials on the sound emission of axial fans is investigated. These materials are positioned at the leading edge of the axial fan blades. This will help to gain a better understanding of the physical sound reduction mechanisms of porosities and to find out how much the acoustic absorption of materials contributes to this. A simplified academic fan was used to perform these investigations. The fan consists of  $z_{\text{fan}} = 9$  blades based on a *NACA 0018* profile. All twisting along the span direction was eliminated, resulting in a straight blade profile. This design allows cost-effective exchangeable leading edges, which are straight due to the simplified design. Leading edges, which are lined with different materials, can now be connected to the blades by grooves and screws and thus several leading edges of different design can be tested successively. This approach allows material and cost savings and provides first insights into the effects of permeable materials on the leading edge of the axial fan due to the simplified fan design. The base blade and replaceable leading edge are shown in Figure 1(a) and Figure 1(b). To avoid gaps between the leading edge and the basic blade, these are sealed with aluminum tape.

Figure 2 schematically shows the axial fan used. The fan rotates clockwise at a speed of  $n_{\text{fan}} = 1486$  rpm and is located in a short duct with a diameter of  $d_{\text{duct}} = 500$  mm. The fan has a diameter of  $d_{\text{fan}} = 495$  mm which results in a head gap of  $s_{\text{tip}} = 2.5$  mm. The hub diameter is  $d_{\text{hub}} = 247.5$  mm. The chord length of the blades is kept constant over the span at  $l_{\text{fan}} = 80$  mm. The replaceable leading edge is  $l_{\text{edge}} = 20$  mm long and takes up 25 % of the total chord of the blade. The avoidance of blade twisting results in angles of attack in the range  $\alpha \in [-1.4^\circ; 14.5^\circ]$  from hub to tip.

Based on the studies on stationary airfoils from the literature, various permeable leading edges made of felt, micro-perforated plates, micro-porous resin and structured porosities are investigated [6-11]. Figure 3 shows the different variants schematically with a photograph of the leading edge. On the one hand, these leading edges will be used to investigate whether or not and to what extent the sound reduction mechanisms found for stationary airfoils can be applied in rotating systems, and on the other hand, how individual mechanisms are exerted.

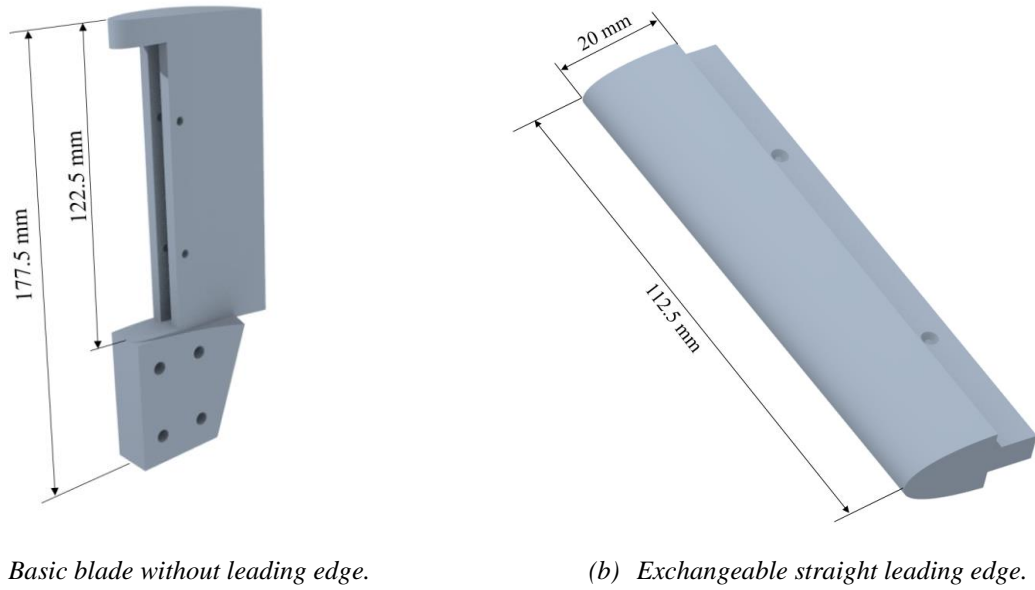

Figure 1: Illustration of the basic blade and a replaceable leading edge. The two components can be connected via a groove and two flat-head screws. In order to provide additional radial securing, the tip area of the blade is designed to be solid.

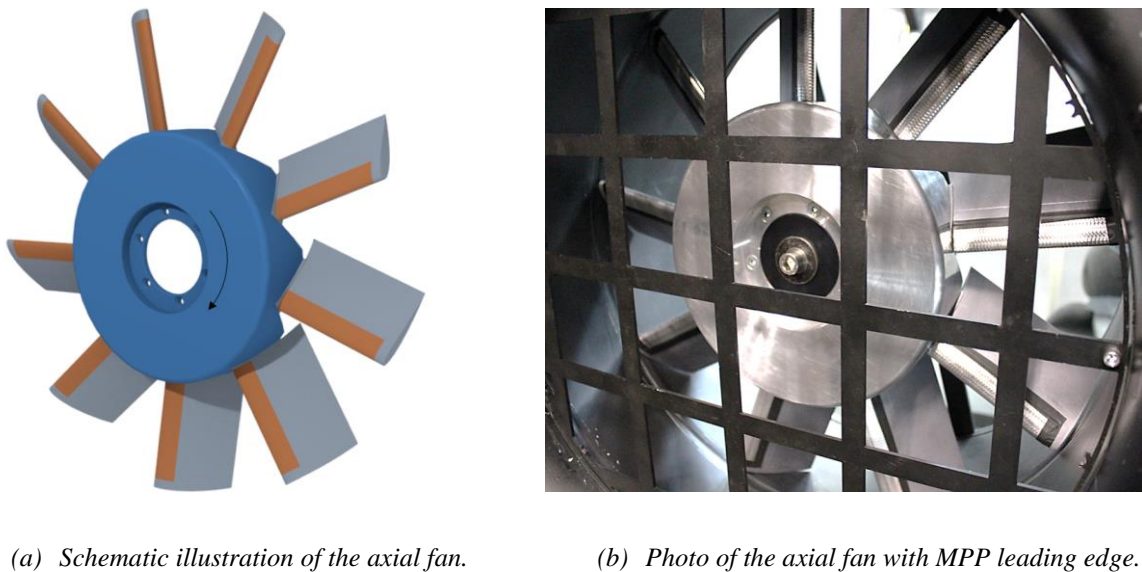
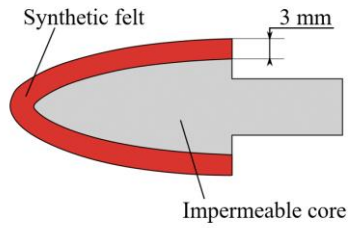

Figure 2: Schematic representation of the axial fan (a) with NACA 0018 profiles as blades. The replaceable leading edges are shown in orange. Photo of the installed axial ventilator with turbulence grid and MPP leading edge (b).

Leading edges with different types of felts are studied (Figure 3(a) and (b)). The felts differ in terms of density and specific flow resistance. On rigid airfoils, it was found that a lower specific flow resistance results in a higher reduction of turbulence interaction noise [6]. Thus, a transfer from the airfoil to the fan is to be used to determine whether it can be useful to attach permeable felts to fans in order to reduce sound emissions through their surface properties. In addition to the felts, leading edges are provided with micro-perforated plates, which are underlain with cavities. This arrangement is known as micro-perforated absorbers (MPA) from silencer applications [13, 14] and stationary airfoils [8].



(a) Leading edge with felt lining.



(b) Photo of a felt leading edge.

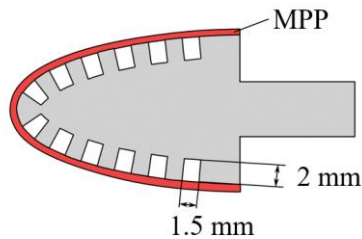

(c) Leading edge with MPP surface.

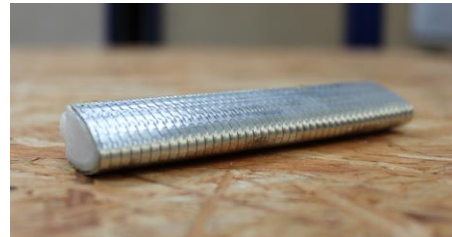

(d) Photo of a MPP surface.

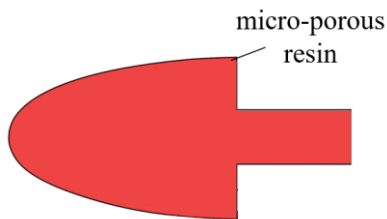

(e) Leading edge made of micro-porous resin.



(f) Photo of a micro-porous resin.

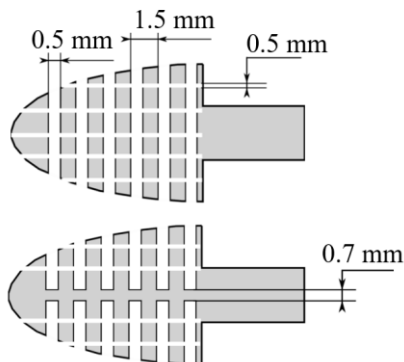

(g) Structured porosities with and without separation layer.



(h) Structured porosities with and without separating layer.

Figure 3: Schematic representation and photographs of the leading-edge modifications studied. The red areas represent a permeability for the flow.

The MPPs have a higher flow resistance than the felts, but are acoustically active due to the small openings and can dissipate sound waves within the small holes. It is to be investigated whether such an application of MPA on fans can be useful from an acoustic point of view. The specific flow resistance of the felts and MPP were determined experimentally using a two-port test rig [15]. In

this process, 2.5 mm thick samples of the material are inserted into a duct and subjected to a static flow through the sample. The pressure is measured both upstream and downstream of the sample, which can be used to determine the specific flow resistance. A schematic diagram of the test rig is shown in Figure 4.

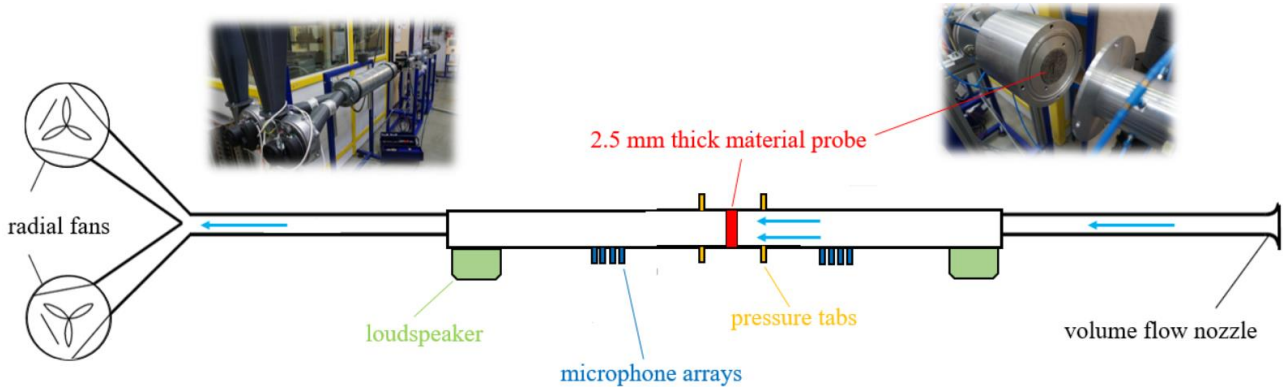

Figure 4: Illustration of the two-port test rig. The test rig can be excited with acoustic sound waves using two loudspeakers and flow can be generated using radial fans. The material samples are mounted in the center of the test rig.

The characteristics of the materials are listed in Table 1. No characteristic values could be determined for the leading edges with the porous resin and the structured porosities, because these either had too much flow through them or did not allow any measurable flow through. The structured porosity with separating layer (porosSL) and the referenced leading edge are impermeable to flow. The different materials can be classified by their density  $\rho$ , flow resistivity  $r$  and pore size  $s_{por}$ .

Table 1: Characteristic values of the used materials (given are density  $\rho$ , flow resistivity  $r$  and pore size  $s_{por}$ ).

<i>name</i>	<i>material</i>	$\rho$ (g/cm <sup>3</sup> )	$r$ (MPa s/m <sup>2</sup> )	$s_{por}$ (mm)
<i>felt015</i>	<i>felt</i>	0.28	0.15	-
<i>felt023</i>	<i>felt</i>	0.28	0.23	-
<i>felt038</i>	<i>felt</i>	0.36	0.38	-
<i>felt101</i>	<i>felt</i>	0.44	1.01	-
<i>MPP168</i>	<i>aluminum</i>	-	1.68	-
<i>MPP218</i>	<i>steel</i>	-	2.18	-
<i>MPP229</i>	<i>steel mesh</i>	-	2.29	-
<i>resin021</i>	<i>resin</i>	-	-	0.021
<i>resin031</i>	<i>resin</i>	-	-	0.031
<i>poros</i>	<i>aluminum</i>	-	-	0.5 & 1.5
<i>porosSL</i>	<i>aluminum</i>	-	$\infty$	0.5 & 1.5
<i>reference</i>	<i>aluminum</i>	-	$\infty$	-

## EXPERIMENTAL SETUP FOR AERODYNAMICS AND AEROACOUSTICS

The aerodynamic and acoustic properties of the axial fans are investigated in a standardized axial fan test rig at the University of Erlangen-Nuremberg. The test rig is designed and built according to DIN 5801 [16]. In addition, the test rig has a low-reflection chamber on the suction side of the tested axial fan, which allows the sound radiation of the axial fan to be characterized under different inflow conditions. Disturbed inflow conditions can be generated by heat exchangers, active turbulence grids or, as in this case, by passive turbulence grids mounted upstream of the fan [1, 17, 18]. A schematic layout within the low-reflection chamber is shown in Figure 5. The sound pressure generated by the axial fan is determined by seven free-field microphones located at a distance of  $R = 1$  m from the inlet nozzle of the axial fan. Simultaneously with the aeroacoustics properties on the suction side of the axial fan, its current operating point can be determined via the pressure rise and volume flow rate. The measurement is realized by means of a ring pressure line inside the chamber. This is connected to the environment with a differential pressure sensor. The current volume flow is determined by a standard volumetric flow nozzle in accordance with DIN 5801 [16]. The acoustic investigations are carried out with a measuring time of  $t_{ac} = 30$  s and a sampling rate of  $f_{ac} = 48$  kHz. The measurements of the aerodynamic quantities, on the other hand side, are carried out for a measuring time of  $t_{aero} = 10$  s with a sampling rate of  $f_{aero} = 1$  kHz, just like the measurement of the torque and the rotational speed. The torque and the speed of the fan are determined using a torque sensor on the drive motor of the fan. For detailed descriptions of the test rig and the measurement techniques used, the reader is referred to the published literature [2, 3, 17, 18].

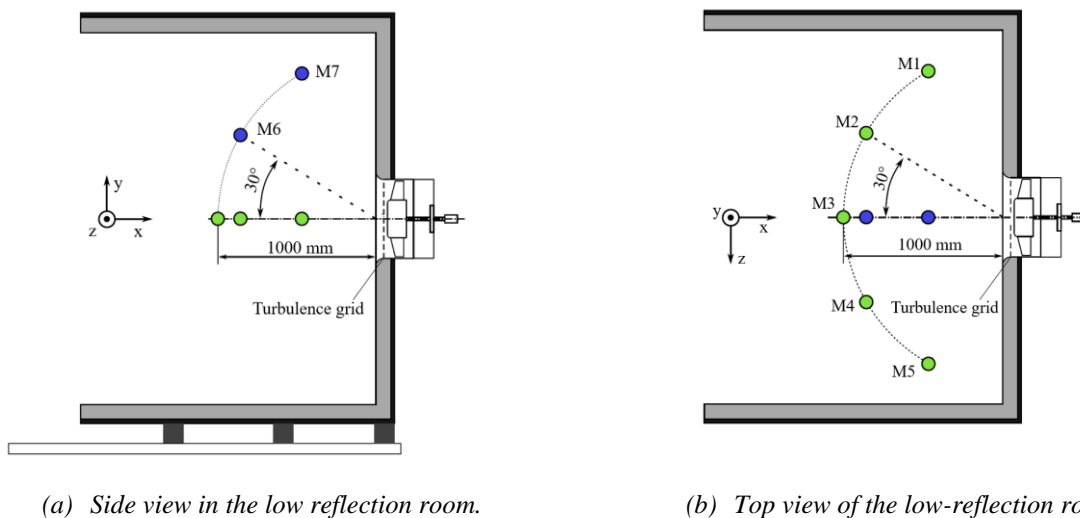

Figure 5: Schematic representation of the test setup for determining the aeroacoustics properties. Five microphones (M1-M5) are placed on a horizontal semicircle and two microphones (M6-M7) are placed on a vertical semicircle.

## EFFECTS OF SOUND-ABSORBING MATERIALS ON THE AEROACOUSTICS OF FANS

Figure 6 shows the aerodynamic curves and the sound pressure level spectra for the fans with different felt leading edges. The felts lead to a sound reduction above a frequency of 1 kHz. In contrast to the airfoils, these acoustic effects occur independently of the specific flow resistance of the felts. A possible reason for this could be that a larger area is usually covered with the felts during airfoil tests. In addition to the sound reduction, the felts also lead to a decrease in the pressure rise of the fan. This decrease in aerodynamic performance is due to the position of the felts. Moving them away from the leading edge or adding a separating layer could reduce this effect. Since the decrease in pressure rise is so high, this loss would have to be considered in the design process through increased chord lengths in order for the felts to be approved for application.

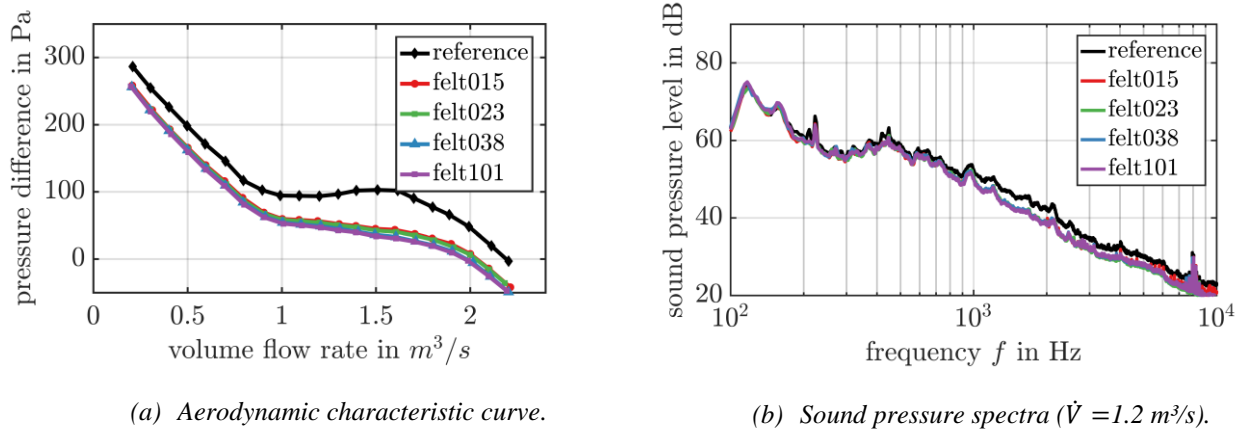

Figure 6: Influence of felts on aerodynamic properties and sound pressure level spectrum.

If MPPs are used on the leading edge of fans, only low aerodynamic losses are present (Figure 7(a)). However, it can be seen from the sound pressure spectra (Figure 7(b)) that no acoustic benefit is generated by the MPPs. This is due to the fact that the leading edge is only a small area and therefore the active area of the MPP absorbers is too small to make any significant contribution to the acoustics. In the high-frequency range, there is an inherent noise due to the MPP. This increases with a lower flow resistance of the MPP. This noise is due to surface roughness and flow through the MPP. When the flow resistance of the MPP decreases, the noise of the MPP increases, which is due to both an increased flow through of the MPP as well as an increased surface roughness [18].

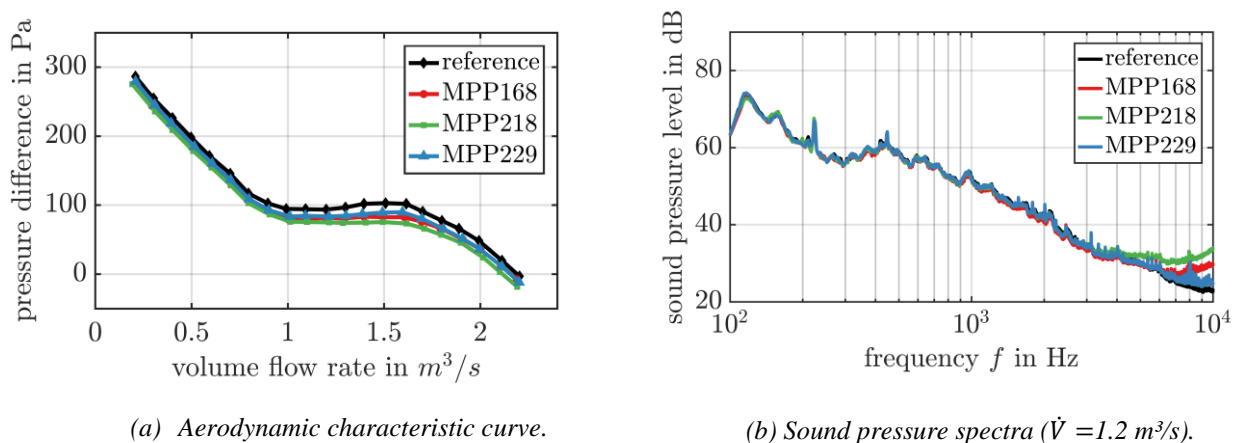

Figure 7: Influence of MPP absorbers on aerodynamic properties and sound pressure level spectrum.

The use of micro-porous resin shows that this small pore size has no effect on the aerodynamics or the acoustics of the fan. This means that this material can be used for the production of fans, but no acoustic absorption can be expected due to the fine pores (Figure 8).

The use of structured porosities indicates that broadband sound can be reduced (Figure 9(b)). However, a similar loss of aerodynamic properties as with the felts is also evident (Figure 9(a)). As already shown in [10, 12], this can be avoided if the expansion of the porosities is chosen to be much smaller and hence if they are not directly attached to the leading edge nose. The investigation of the separation layer shows that a flow-through, i.e., a connection between the suction side and pressure side of the blade, must be present for an acoustic benefit to occur. However, a separation layer can maintain the aerodynamic properties. The high-frequency sound is generated by the surface roughness and the flow through the openings. Since this sound is more prominent if a separation layer is installed in the blade, it can be concluded that the greater proportion in this case arises from the surface roughness, because in the case of the separation layer more volume flow passes over it.

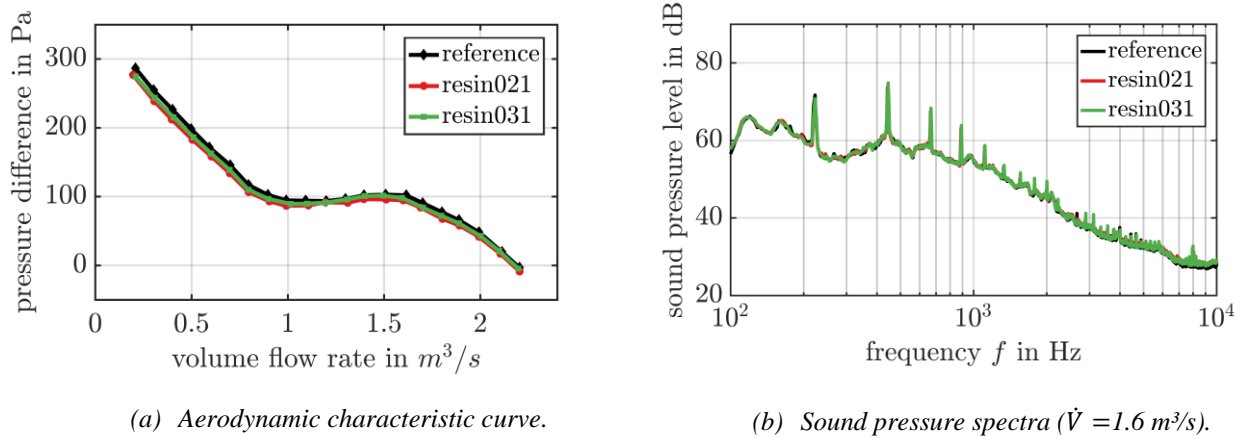

Figure 8: Influence of micro-porous resin on aerodynamic properties and sound pressure level spectrum.

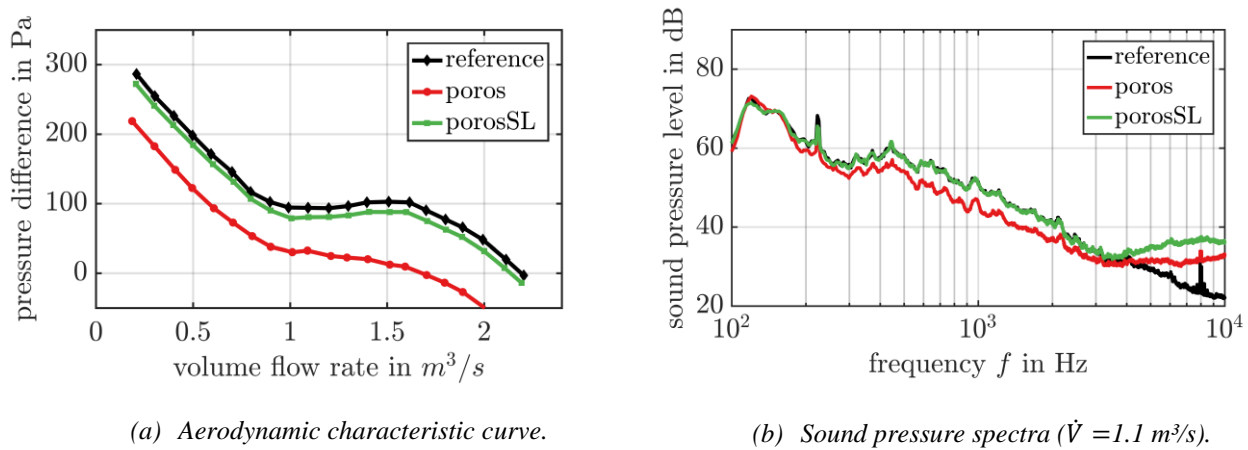

Figure 9: Influence of a structured porosity and separation layer on the aerodynamic and acoustic properties.

## CONCLUSION AND OUTLOOK

The research shows that there is no worthwhile acoustic benefit to incorporating sound-absorbing materials such as MPPs or micro-porous resins on the leading edge of axial fans. This allows the conclusion that the sound reduction mechanisms of porosities on the axial fan are not particularly affected by sound absorption. Felts result in a sound reduction above 1 kHz, but also cause a decrease in the pressure rise. No dependence on the specific flow resistance of the material was found here. Rather, it was shown that a connection between the suction side and pressure side must be present in order to achieve noticeable acoustic improvements. These connections cause effects such as the thickening of the boundary layer or the increase of the momentum exchange. Separation layers can reduce the negative effects on aerodynamics. The sound generation in the high-frequency range could be traced back to surface roughness and flow through. The results suggest that by the correct choice of the position and size of structured porosities an acoustic improvement with constant aerodynamic properties can be realized. This can be customized by the variable possibilities of additive manufacturing. The results indicate that the best choice for future applications may be to use a separation layer that separates only parts of the chord. In this way, both the aerodynamic properties and the local flow through the blade, which has a positive effect on sound radiation, can be preserved.



## BIBLIOGRAPHY

- [1] Czwielong F., Krömer F., Becker S. – *Experimental investigations of the sound emission of axial fans under the influence of suction-side heat exchangers*; 25th AIAA/CEAS Aeroacoustics Conference, **2019**
- [2] Krömer F., Czwielong F., Becker S. – *Experimental investigation of the sound emission of skewed axial fans with leading-edge serrations*; AIAA Journal 57.12, 5182-5196, **2019**
- [3] Czwielong F., Krömer F., Paruchuri C., Becker S. – *Experimental investigation of the influence of different leading edge modifications on the sound emission of axial fans downstream of a heat exchanger*; Universitätsbibliothek der RWTH Aachen, **2019**
- [4] Benschuai L., Ayton L., Paruchuri C. – *On the acoustic optimality of leading-edge serration profiles*; Journal of Sound and Vibration 462, 114923, **2019**
- [5] Biedermann T., Czeckay P., Geyer T.F., Kameier F., Paschereit C. – *Effect of inflow conditions on the noise reduction through leading edge serrations*; AIAA Journal 57.9, 4104-4109, **2019**
- [6] Geyer, T. F., Sarradj, E., Giesler, J., Hobracht, M. – *Experimental assessment of the noise generated at the leading edge of porous airfoils using microphone array techniques*. 17th AIAA/CEAS Aeroacoustics Conference, AIAA-Paper 2011-2713, **2011**
- [7] Sarradj, E., Geyer, T. F. – *Symbolic regression modeling of noise generation at porous airfoils*. Journal of Sound and Vibration, 3189-3202, **2014**
- [8] Zamponi R., Satcunanathan S., Moreau S., Ragni D., Meinke M., Schröder W., Schram C. – *On the role of turbulence distortion on leading-edge noise reduction by means of porosity*; Journal of Sound and Vibration ; 485:115561, **2020**
- [9] Bampanis G., Roger M. – *On the Turbulence-Impingement Noise of a NACA-12 Airfoil with Porous Inclusions*; AIAA AVIATION 2020 FORUM, **2020**
- [10] Ocker C., Geyer T. F., Czwielong F., Krömer F., Pannert W., Merkel M., Becker S. – *Permeable Leading Edges for Airfoil and Fan Noise Reduction in Disturbed Inflow*; AIAA Journal, **2021**
- [11] Bowen L., Celik A., Azarpeyvand M., da Silva C. – *Porous geometry effects on the generation of turbulence interaction noise*; AIAA AVIATION 2021 FORUM, **2021**
- [12] Ocker C., Czwielong F., Geyer T. F., Paruchuri C., Merkel M., Becker S. – *Permeable Structures for Leading Edge Noise Reduction*; AIAA AVIATION 2021 FORUM, **2021**
- [13] Floss S., Czwielong F., Kaltenbacher M., Becker S. – *Design of an in-duct micro-perforated panel absorber for axial fan noise attenuation*; Acta Acustica 5:24, **2021**
- [14] Sack S., Åbom M. – *Modal filters for mitigation of in-duct sound*; In Proceedings of Meetings on Acoustics 172ASA, vol. 29, no. 1, p. 040004. Journal of the Acoustical Society of America, **2016**
- [15] Berchtenbreiter B., Müller J., Becker S. – *Transmission und Reflexion akustischer Wellen in Rohrleitungssystemen*; DAGA 2017 Kiel, **2017**
- [16] DIN EN ISO 5801, International Organization for Standardization, *Industrial fans- Performance testing using standardized airways*, **2007**.
- [17] Czwielong F., Becker S. – *Aktives Turbulenzgitter -Generierung definierter Zuströmturbulenzen für Axialventilatoren*; DAGA 2021 Wien, **2021**

- [18] Krömer F. – *Sound emission of low-pressure axial fans under distorted inflow conditions*; FAU University Press, **2018**
- [19] Geyer, T. F. – *Trailing Edge Noise Generation of Porous Airfoils*; Brandenburgische Technische Universität (BTU), Cottbus, **2011**

Distributed under the terms of the Creative Commons Attribution 4.0 International License (CC BY 4.0).  
<https://creativecommons.org/licenses/by/4.0/>