



**Calhoun: The NPS Institutional Archive**  
**DSpace Repository**

---

Reports and Technical Reports

All Technical Reports Collection

---

1994

# Observations of Field Enhancement on the HMS Lancaster

Maruyama, Xavier K.; Osborne, Joseph; Martin, Vasco

Monterey, California. Naval Postgraduate School

---

<http://hdl.handle.net/10945/69404>

---

This publication is a work of the U.S. Government as defined in Title 17, United States Code, Section 101. Copyright protection is not available for this work in the United States.

*Downloaded from NPS Archive: Calhoun*



Calhoun is the Naval Postgraduate School's public access digital repository for research materials and institutional publications created by the NPS community. Calhoun is named for Professor of Mathematics Guy K. Calhoun, NPS's first appointed -- and published -- scholarly author.

**Dudley Knox Library / Naval Postgraduate School**  
**411 Dyer Road / 1 University Circle**  
**Monterey, California USA 93943**

<http://www.nps.edu/library>

2

AD-A275 660



NPS-PH-94-001

# NAVAL POSTGRADUATE SCHOOL

Monterey, California



**S** DTIC  
ELECTE  
FEB 14 1994  
**E D**

OBSERVATION OF FIELD ENHANCEMENT ON THE HMS LANCASTER

BY

XAVIER K. MARIYAMA, JOSEPH OSBORNE

and

VASCO MARTINS

DTIC QUALITY INSPECTED 2

Approved for public release; distribution unlimited.

Prepared for: Theater Nuclear Warfare Program Office, PMS 423  
Naval Sea Systems Command, Department of the Navy  
Washington, DC 20362-5001

And: Defense Nuclear Agency  
6801 Telegraph Road  
Alexandria, VA 22310-3398

1981

94-04913



10 237

**Best  
Available  
Copy**

NAVAL POSTGRADUATE SCHOOL  
Monterey, California 93943-5000

Rear Admiral T.A. Mercer  
Superintendent

H. Shull  
Provost

This report was prepared for PMS 423 and Defense Nuclear Agency and  
funded by PMS 423 and Defense Nuclear Agency.

Reproduction of all or part of this report is authorized.

This report was prepared by:

  
XAVIER MARUYAMA  
Professor of Physics

  
JOSEPH OSBORNE  
LCDR USN

Reviewed by:

Released by:

  
WILLIAM B. COLSON  
Chairman, Physics Department

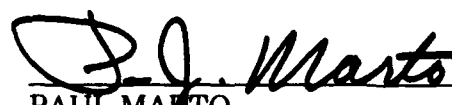
  
PAUL MANTO  
Dean of Research

REPORT DOCUMENTATION PAGE				Form Approved OMB No 0704-0188		
1a. REPORT SECURITY CLASSIFICATION <b>Unclassified</b>			1b. RESTRICTIVE MARKINGS			
2a. SECURITY CLASSIFICATION AUTHORITY			3. DISTRIBUTION / AVAILABILITY OF REPORT			
2b. DECLASSIFICATION / DOWNGRADING SCHEDULE						
4. PERFORMING ORGANIZATION REPORT NUMBER(S) <b>NPS-PH-94-001</b>			5. MONITORING ORGANIZATION REPORT NUMBER(S)			
6a. NAME OF PERFORMING ORGANIZATION <b>Naval Postgraduate School</b>		6b. OFFICE SYMBOL (if applicable) <b>PH</b>	7a. NAME OF MONITORING ORGANIZATION			
6c. ADDRESS (City, State, and ZIP Code) <b>Monterey, California 93943-5000</b>			7b. ADDRESS (City, State, and ZIP Code)			
8a. NAME OF FUNDING / SPONSORING ORGANIZATION <b>PMS 423</b>		8b. OFFICE SYMBOL (if applicable)	9. PROCUREMENT INSTRUMENT IDENTIFICATION NUMBER			
8c. ADDRESS (City, State, and ZIP Code) <b>PMS 423 Naval Sea Systems Command Department of the Navy, Washington, DC</b>			10. SOURCE OF FUNDING NUMBERS			
			PROGRAM ELEMENT NO	PROJECT NO	TASK NO	WOP UNIT ACCESSION NO
11. TITLE (Include Security Classification) <b>20862-5001 OBSERVATIONS OF FIELD ENHANCEMENT ON THE HMS LANCASTER</b>						
12. PERSONAL AUTHOR(S) <b>Xavier K. Maruyama, Joseph Osborne, and Vasco Martin</b>						
13a. TYPE OF REPORT <b>technical</b>		13b. TIME COVERED FROM <b>Aug 92</b> TO <b>Nov 93</b>	14. DATE OF REPORT (Year, Month, Day) <b>20 Nov 93</b>		15. PAGE COUNT	
16. SUPPLEMENTARY NOTATION The views expressed in this report are those of the authors and do not reflect the official policy or position of the Department of Defense or the U.S. Government.						
17. COSATI CODES			18. SUBJECT TERMS (Continue on reverse if necessary and identify by block number) <b>Electromagnetic Pulse, Field Enhancement, Empress II, HMS Lancaster, EMP</b>			
FIELD	GROUP	SUB-GROUP				
19. ABSTRACT (Continue on reverse if necessary and identify by block number)  <b>Field enhancement was observed aboard the HMS Lancaster, during EMP ship trials using Empress II. Measured fields exceeded nominal free fields by several hundred percent. This report describes measurements, present observations and makes suggestions for future trials.</b>  <b>Key Words:</b> Electromagnetic Pulse, EMP, Field Enhancement, Empress II, HMS Lancaster.						
20. DISTRIBUTION / AVAILABILITY OF ABSTRACT <input checked="" type="checkbox"/> UNCLASSIFIED/UNLIMITED <input type="checkbox"/> SAME AS RPT <input type="checkbox"/> DTIC USERS			21. ABSTRACT SECURITY CLASSIFICATION <b>UNCLASSIFIED</b>			
22a. NAME OF RESPONSIBLE INDIVIDUAL <b>Xavier K. Maruyama</b>			22b. TELEPHONE (Include Area Code) <b>(408) 656-2431</b>		22c. OFFICE SYMBOL <b>PH/Mx</b>	

**OBSERVATION OF FIELD ENHANCEMENT  
ON THE HMS LANCASTER**

**Xavier K. Maruyama, Joseph Osborne**  
Department of Physics  
Naval Postgraduate School  
Monterey, CA 93943

**Vasco C. Martins**  
Rockwell International Corp.  
Alexandria, VA 22202

Accession For	
NTIS CRA&I	<input checked="" type="checkbox"/>
DTIC TAB	<input type="checkbox"/>
Unannounced	<input type="checkbox"/>
Justification .....	
By .....	
Distribution /	
Availability Codes	
Dist	Avail and / or Special
A-1	

**I. INTRODUCTION**

DTIC QUALITY INSPECTED 2

Conducting structures dramatically enhance electromagnetic pulse (EMP) fields near corners and edges. This effect was observed aboard the HMS LANCASTER (F229) during EMPRESS II testing conducted on August 24, 1992. Because ships are by nature large conducting structures, surprising results were obtained which in retrospect can be explained<sup>1</sup>. Field enhancements were noticed on EMPRESS II trials of USS DEYO (DD 989) and USS OLIVER HAZARD PERRY (FFG 7) previously, but this was the first attempt to actually quantify the field enhancement.

Charge concentrations at intersecting edges and corners of box-like structures and elongated geometry caused measured fields often exceeding five times the nominal free field. Navy ship hardening specifications may perhaps not be sufficient for susceptible components in areas of enhanced fields. In this report we describe measurements, present observations, discuss conclusions and make suggestions for future trials and hardening measures. It must be emphasized that the effects are not small, but are enhancements of several hundred percent. Variations due to normal experimental conditions are relatively unimportant.

**II. HARDWARE**

The electric field measurements were made with a D-dot, RSI probe consisting of a D-dot probe connected to a buffer amplifier which fed a rapid survey instrument, RSI, capable of recording the peak electric field during the measurement interval. The D-dot sensor had a grounding plane 12" (30 cm) in diameter with probe area about 8" (20 cm) in diameter. Fig. 1 illustrates the instrument configuration. These instruments were provided from the Naval

Surface Warfare Center, Dahlgren Division, White Oak Detachment  
 DAAPS instrument pool<sup>2</sup>.

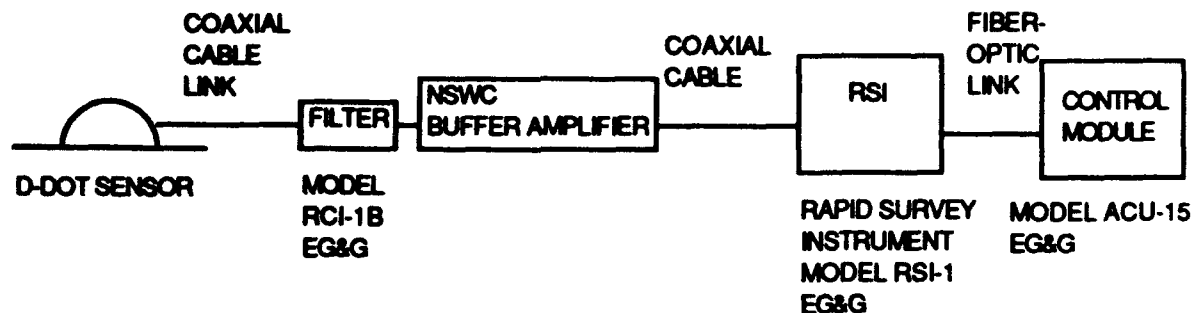

Figure 1. Equipment Configuration for the Rapid Survey Instrument D-dot probe.

### III. TEST CONFIGURATION

The UK frigate HMS LANCASTER<sup>3</sup> underwent EMPRESS II EMP hardness assuredness tests during the month of August 1992. We conducted field measurements on August 24, 1992 as an ad-hoc experiment. Initially, we intended only to make cursory measurements to guide us towards an understanding of the field enhancement phenomenon for use in a future study. Because of the availability of the RSI instruments, the cooperation of crew, NSWC and EG&G staff, the elements and encouragement from the US and UK test directors, we were able to make a much more comprehensive series of measurements than initially intended. HMS LANCASTER maintained station on EMPRESS II as outlined in fig. 2A - 2C for the 14 kV/m trial conducted 20 miles east of Cape Hatteras.

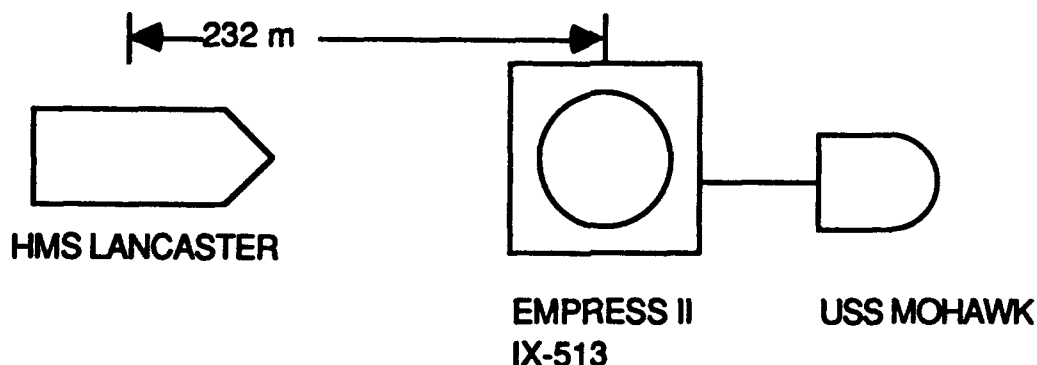
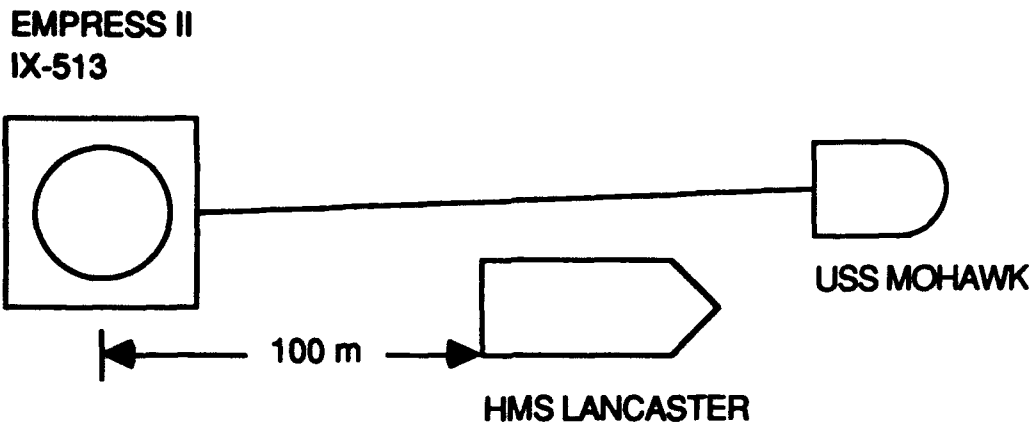
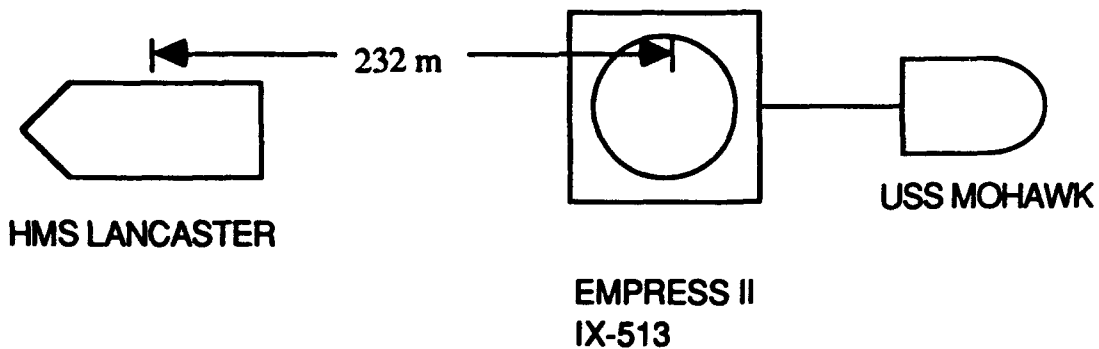

Figure 2A. Test Configuration with HMS Lancaster trailing the EMP barge. Empress II is the EMP barge and the USS Mohawk is the ocean going tug towing Empress II.



**Figure 2B.** Test Configuration with HMS LANCASTER between EMPRESS II and USS MOHAWK.



**Figure 2C.** Test configuration with HMS LANCASTER following EMPRESS II. HMS LANCASTER is moving astern.

Relative motion between the ship and barge, rolling of the EMPRESS II antenna and pulser variation combined for a measured field standard deviation of 18 percent. Station keeping caused the greatest variation; pulser output differences the least. Test instrumentation was calibrated to within one dB, but using the same instrument during all measurements eliminated calibration uncertainties. Fortunately, the observed effects are an order of magnitude greater than these experimental variations.



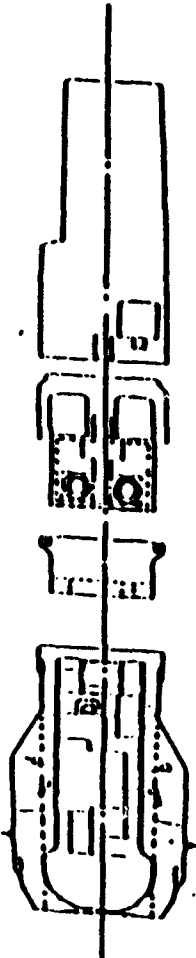
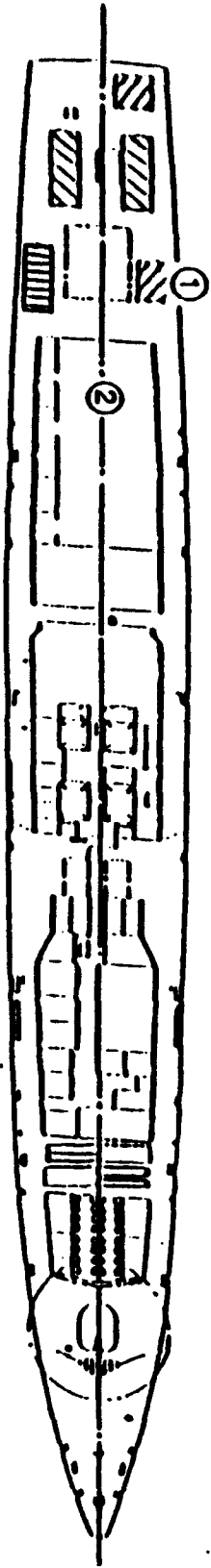
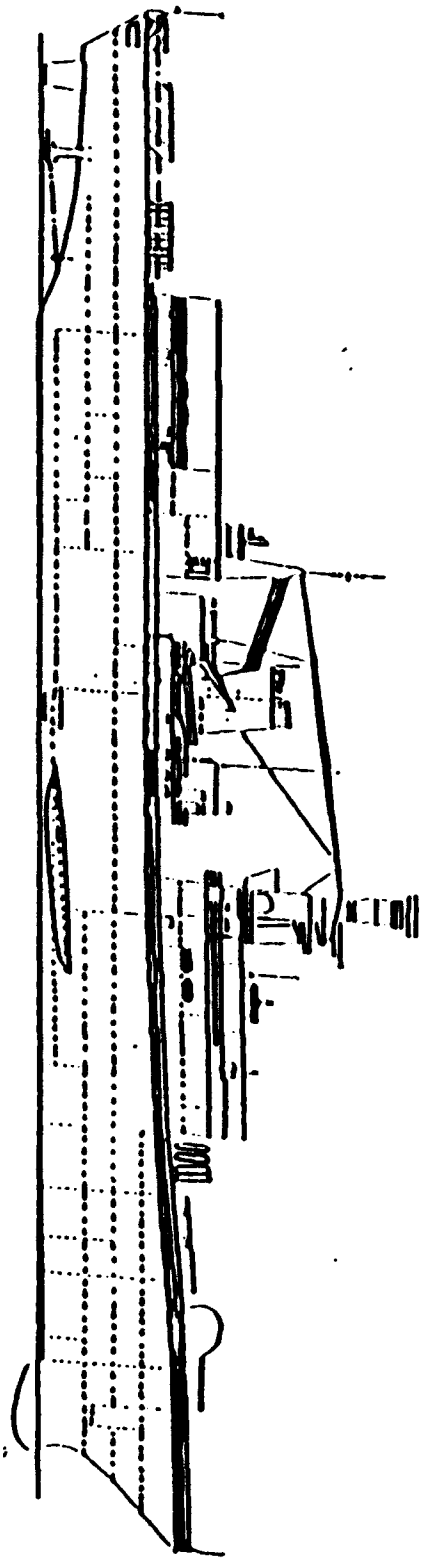

-  DAAPS Modules
-  Generator Sets
-  Instrument
-  Logistics Store

Figure 3. HMS Lancaster profile. Locations 1 and 2 are the metal box and hangar deck roof where measurements were conducted.

## **IV. MEASUREMENTS**

Figure 3 illustrates the ship profile and test locations. Measurements were made on the fantail (flight deck) and on the hangar deck roof.

A relatively simple, easily reachable box geometry was chosen for the first series of measurements. A large metal tool box located on the ship's flight deck produced enticing results, dramatically illustrating the magnitude and characteristic of field enhancement.

### **A. Metal Box**

The metal tool box illustrated in figure 4 was located in position 1 of figure 3. HMS LANCASTER was bow on to EMPRESS II as in figure 2A, producing some superstructure shadowing of the test location, but still producing a relatively uniform free field of 5 kV/m. We placed the D-dot probe at several locations as shown in figure 4, performing a series of three or four measurements at each location. This data provided anticipatory predictions of field enhancements to expect from other simple geometry's. The observed fields are shown on figure 4.

These preliminary measurements produced striking results. The field at the center of the box top, point A, was 5.5 kV/m, near nominal. At corner B, the field was 18 kV/m, an enhancement of 300 percent and highest on the box. The field at the outboard edge measured 14 kV/m. An inboard corner C, partially shadowed by ship structure, experienced an 8 kV/m field, less than half the outboard corner. The tool box location near deck edge also suggested some additional effects caused by the ship's hull.

Structure scattering could at most account for doubling due to phase addition. The observed field enhancement is most likely due to charge redistribution caused by the external EMP excitation on the conducting surface. The charge migration to the box top resulted in field measurements of 2 kV/m at the front face of the tool box, point I, and 5 kV/m at the corner J. The fields found on the metal box clearly indicate the importance of local conducting geometry to the enhancement effect.

Interestingly, measurements on the lifeline support stanchion at location F were as high as observed at corner B. Two effects are evident. Charge concentration is most apparent on tall thin structures, such as the 1.5 inch diameter, three foot high metal stanchion. The stanchion was also located at the top outer edge of the flight deck, further amplifying enhancement. Field lines tend to

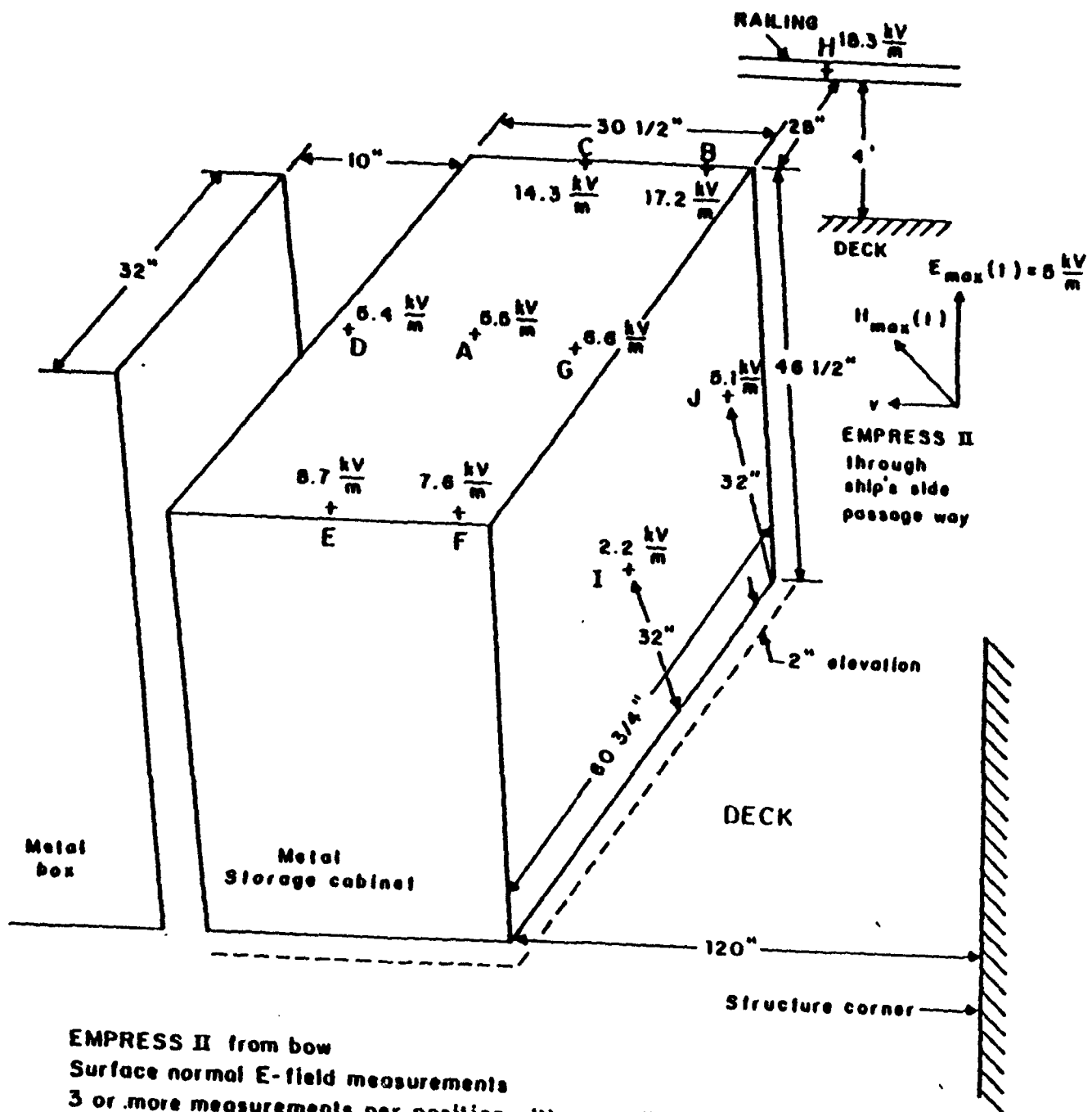

EMPRESS II from bow  
 Surface normal E-field measurements  
 3 or more measurements per position with repeatability  
 of measurements  $\approx \pm 10\%$

Figure 4. Metal box and railing location measurements.

concentrate on small cross section structures, an observation which was more evident in later testing.

## B. Hangar Roof Deck

More detailed measurements were conducted on the deck above the helicopter hangar, location 2 of figure 3. Test measurement locations are located as shown in figure 5. Progressive measurements were made at the deck edge, port corner and on top of taller structures on the deck. Hangar deck measurements were conducted with the LANCASTER's stern pointed toward EMPRESS II, first in the configuration of figure 2A and then of figure 2C. The measurements were thus clear field, not obstructed by superstructure shielding for the tool box measurements. Nominal fields were also significantly different than for the tool box test.

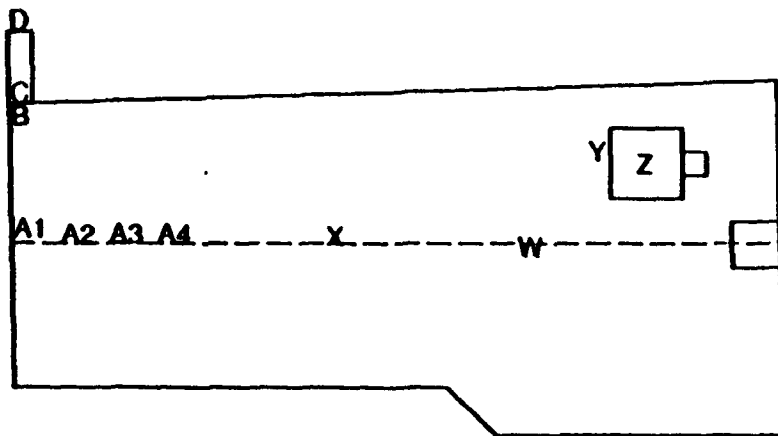

Figure 5. Hangar roof deck measurement locations. See Table 1 for locations.

With no obstructions, the taller structure demonstrated conclusively the effects of field enhancement. In a nominal 16 kV/m field, the after top edge of the helicopter hangar produced local fields of 45 kV/m, a three fold increase. Far from the hangar edge, centerline point W measured a significantly reduced 4.6 kV/m. Both measurements suggest EMP excited charge concentration. The hangar roof is far above the flight deck, suggesting that field enhancement is significantly amplified by height effects.

Measurements made at distances progressively back from the after deck edge demonstrated a rapid fall-off of local EMP field. As plotted in figure 6, the 45 kV/m field dropped by half within one

foot from the edge and to below nominal values six feet back. The nominal field was measured at the ship's stern, 30 meters closer to EMPRESS II than the hangar. Assuming a  $1/r$  reduction, the nominal field should have been 14 kV/m. The even lower measured local field toward the hangar center is likely caused by reduction in charge density and structure shielding. Most importantly, local edge fields were four times that measured far from the edge and double that found just one foot from the edge.

Local field varied little along the length of the edge. Surprisingly, even the corner of the hangar superstructure, point B, measured about the same. A light boom that extended two meters outboard from this corner evidently collected the charge concentration, resulting in the lower than expected field measurements. Field measurement just outboard of the deck edge, point C, were 20 percent higher than at the deck edge, but safety considerations prevented measurements at point D on the boom end. Detailed measurement data is provided in table 1.

### C. Ship Exterior Equipment

Electronic equipment with antennas or structure exterior to the ship structure is the primary shipboard EMP susceptibility concern. Field enhancement could dramatically impact EMP survivability requirements. Ship structures are inherently conducting, and equipment fully survivable in free field might experience enhanced fields well above specifications if adversely located. Two structure measurements help illustrate this effect. A 50.5 inch (128 cm) high compass stand was located 20 foot (6.1 m) forward of the hangar

**Table 1.** Electric field measurements on and near the edge of the hangar bay roof facing the EMP pulser.

Location	Distance From Edge	Field (kV/m)
A1 centerline	1" (2.5 cm)	45.6 ± 8.4
A2 centerline	10" (25 cm)	23.5 ± 1.2
A3 centerline	25" (64 cm)	19.0 ± 0.6
A4 centerline	6' (183 cm)	11.3 ± 2.1
B starboard stern corner		44.1 ± 8.7
C boom		53 ± 14

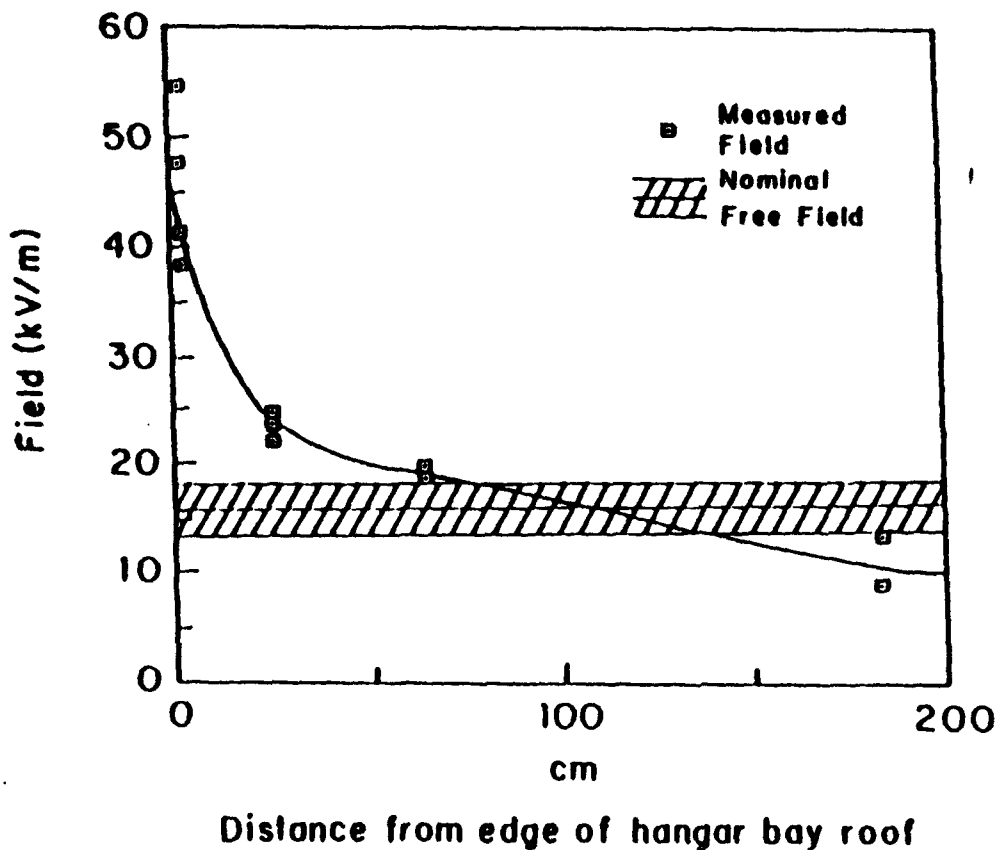

Figure 6. Field measurements on roof of hangar bay along the centerline. The squares are the measured fields and the line is a guide to the eye. The nominal peak free field value indicated by the hatch line was  $16.1 \pm 2.3$  kV/m.

door edge, point X of figure 5. The 2 inch (5 cm) diameter stand was isolated from other structures. The measured local EMP field was 75 kV/m, six times greater than the field at point A4. The compass stand clearly demonstrates field enhancement of conducting rods and the required design concerns.

The EMP test team noted high current readings on the after fire control-tracking radar compared to the forward radar. Local field measurements were made on a box 12 feet (3.7 m) above the deck at point Z of figure 5. The observed field was 78 kV/m, in stark contrast to tracker platform fields of 16 kV/m at point Y, five feet (1.5 m) above the hangar roof deck. Time demands prevented measurements on the forward tracker. Theoretically, the position of the after tracking radar at the superstructure edge with few obstructions should produce higher local EMP fields than the

centerline mounted forward tracking radar near the base of the tall forward mast.

Using the 4.62 kV/m measured at point W at the deck centerline, field measurements can be plotted as a function of height as in figure 7. The height to field correlation is noticeably nonlinear, although definitive conclusions are not possible from such complicated geometry's. Nominal field of 14 kV/m is indicated by the hatched line, amplifying the greatly reduced field at the hangar top deck centerline. Most importantly, the enhanced field on the tracker radar 12 feet higher exceed nominal free field by 540 percent and hangar deck measurements by a factor of 16.

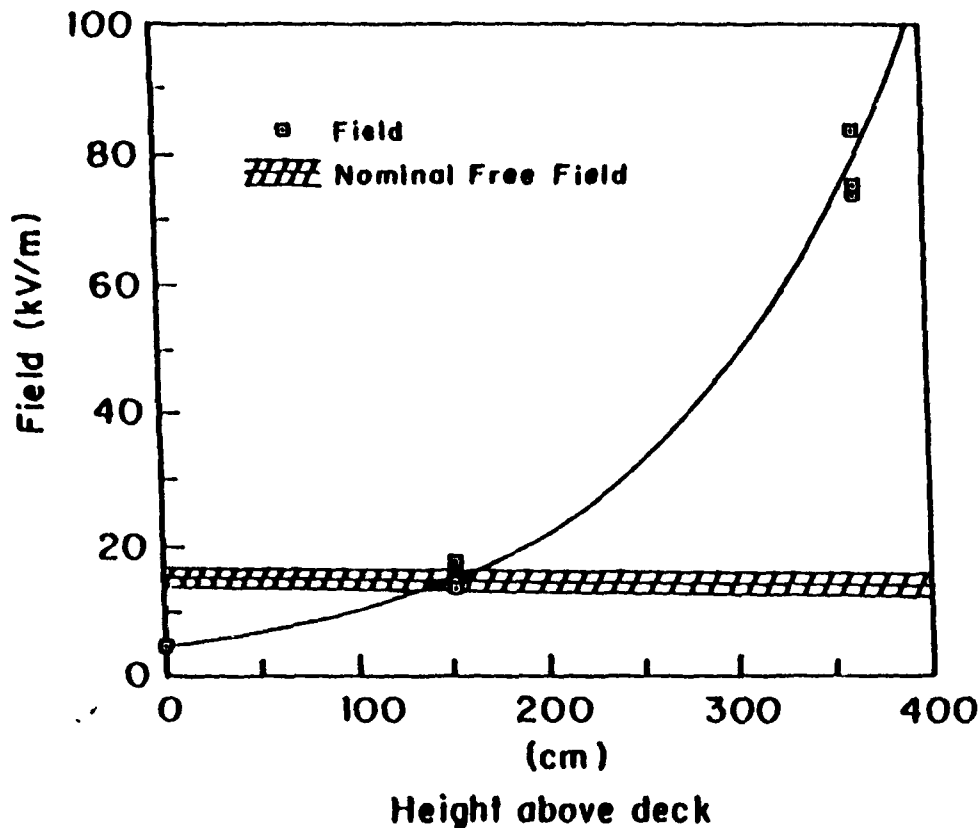

Figure 7. Field measurements around fire control tracking radar. The line is an exponential fit to the measurements. The nominal peak free field value indicated by the hatched line was  $14.2 \pm 2.5$  kV/m.

## D. Details

Because the D-dot sensor cannot physically lie flat against some grounding surfaces, several measurements were conducted to observe the effects of placement of sensors.

### i) Corner Measurement

At location B in fig. 5, hangar roof port stern corner, two measurements were made to determine the effect of a metal ridge at that location. There was no appreciable difference between the two configurations.

As seen in fig. 8, configuration B' extends over the ridge, whereas B is entirely on the hangar roof deck. At B, we observed 38 kV/m and at B', 46 kV/m, with uncertainty in both measurements of about 9 kV/m. The results were identical within experimental error, although they suggest higher edge effect measurements with the probe centered on the corner.

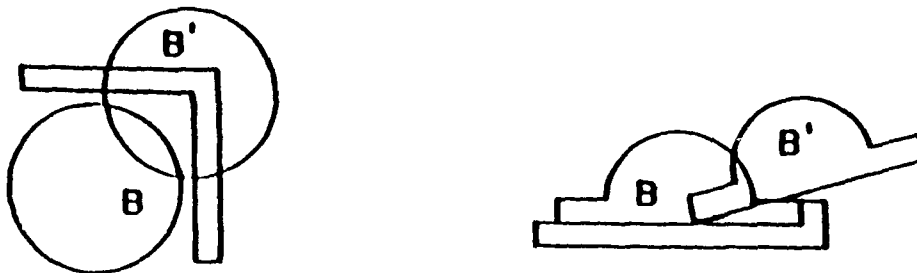

Figure 8. Corner of hangar roof. Effect of 1/4" high ridge. Configuration B extends over the ridge, whereas configuration B' is entirely on the hangar roof deck.

### ii) Boom

At location C of fig. 5, measurements were made on the boom extending out from the superstructure. Measurements were made with the probe ground plane horizontal and perpendicular to the ship deck. Parallel measurement was  $53.0 \pm 2.9$  kV/m, whereas the perpendicular measurement was  $53 \pm 14$  kV/m. Within the measurement variation, both give the same result.



### iii) Tracker

At the tracker mounting deck, position Y of figure 5, there is a deck lip illustrated in fig. 9. At location Y,  $15.7 \pm 1.9$  kV/m was observed, whereas at location Y',  $11.7 \pm 1.2$  was measured. This difference may be due to grounding difficulties at location Y' since there was effectively only a two line contact between the deck and the probe grounding plane.

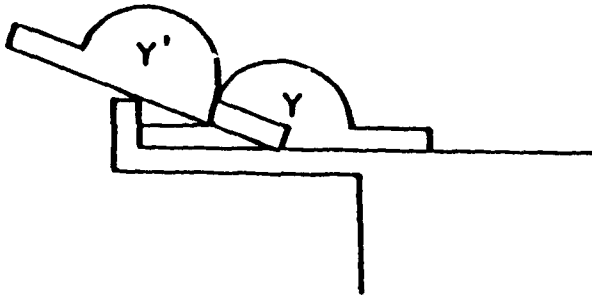

Figure 9. Probe placement on tracker mounting deck.

### iv) Probe size

The probe used had a grounding plane 12" in diameter with a probe area about 8" in diameter. The probe measured an average field over its volume. Since the enhancement effects are very geometry dependent, a smaller probe probably would have measured a larger local field and edge and corner measurements might have been substantially higher. The critical volume for various components may be quite small, so field enhancements may constitute a much greater effect than noted even in these dramatic results.

## V. CONCLUSIONS

These measurements clearly demonstrated that conducting geometry's inherent in ship design can produce dramatic EMP field enhancement. Edges of structures may have local EMP fields three to five time nominal, and corners may be even more enhanced. Tall structures such as masts and radar platforms can cause charge concentration that result in considerable EMP field enhancement. Electronic equipment designed for nominal fields may perhaps not be

survivable when placed on conducting ship structures. This limited study suggests several questions to be answered:

i) Do EMP field enhancements due to conductive geometry result in corresponding enhancement of induced currents?

ii) Enhancement is a strong function of structure geometry, especially at edges and tops of thin structures. The large probe of this investigation measured field averaged over a rather large volume. Does the integrating volume of the field sensor need to be as small as the structure under test?

iii) Because field enhancement is a geometry effect, relative field enhancement measurements for a series of tests need only be made once. Ship structures are often complicated, resulting in poor predictability beyond gross assumptions. Is there any alternative to total ship EMP survivability testing?

iv) Considering the observed field enhancement of three to five, does shipboard EMP testing need to restrict personnel access during testing at field strengths below the accepted limits?

Rockwell International has completed EMP enhancement predicting algorithms for NAVSEA PMS 423. The observed effects can be readily demonstrated for simple geometry's, but require extensive computer time and simplifying assumptions to predict for ship structures. This test represents a first attempt to validate these predictions. We have made further measurements in 1993 during EMPRESS II testing of USS ANZIO (CG68) and EMPRESS I testing of USS OLIVER HAZARD PERRY (FFG7). The results of these subsequent experiments are the subject of a later report.

## **ACKNOWLEDGEMENT**

Petty Office J.D. Braithwaite of the HMS Lancaster is thanked for his invaluable assistance in collecting data. Mr. Marvin Harris of EG&G provided instrumentation support. The NSWC EMP Branch, especially Mike Jump, Jean Visk, Jim Whitt and Neal Stetson, are gratefully acknowledged for the instrumentation and cooperation. This work was made possible by the support of PMS 423. XKM acknowledges the partial support of the Naval Postgraduate School and the Defense Nuclear Agency.

## REFERENCES

1. Rockwell International Corporation, EMP Surface Field and Density Predictions on a Simple Ship Model, Theater Nuclear Warfare Program Office Report C89-794034A/301, April 22, 1991.
2. Michael Jump, EMP Branch, Naval Surface Warfare Center, White Oak, private communications.
3. Jane's Fighting Ships, 1991-1992, Jane's Information Group, Sentinel House, Surrey, UK, 1991, p.683. The HMS Lancaster, F229, is a Duke Class Frigate built by Yarrow (Shipbuilders) Ltd, Glasgow, commissioned May 1992. It's displacement is 3500 tons standard ; 4200 tons full load. Speed is 28 knots, 15 knots in diesel-electric; Range 7800 miles at 15 knots; complement 169 (12 officers).
4. Rockwell International Corporation, Relationships for Determining Field and Coupling Enhancement Levels on Ship Topside Surfaces and Equipment Excited by EMP or Lightning, Theater Nuclear Warfare Program Office Report, September 1993.

## DISTRIBUTION LIST

- |    |  |    |
|----|--|----|
| 1. | <b>Library, Code 52<br/>Naval Postgraduate School<br/>Monterey, CA 93943-5002</b>  | 2  |
| 2. | <b>Professor Xavier K. Maruyama<br/>Department of Physics, Code PII/Mx<br/>Naval Postgraduate School<br/>Monterey, CA 93943</b>                                | 15 |
| 3. | <b>Dr. Vasco Martins<br/>Rockwell International Corporation<br/>Washington Operations, Suite 1100<br/>1745 Jefferson Davis Highway<br/>Arlington, VA 22202</b> | 5  |
| 4. | <b>Theater Nuclear Warfare Program Office<br/>PMS 423<br/>Naval Sea Systems Command<br/>Department of the Navy<br/>Washington D.C. 20362-5001</b>              | 5  |
| 5. | <b>Defense Nuclear Agency<br/>6801 Telegraph Road<br/>Alexandria, VA 22310-3398<br/>attn: Maj Mark Weitekamp, RAEE<br/>Lcdr Kay DiNova. RAEE</b>               | 2  |
| 6. | <b>Department of Physics, Chairman<br/>Code PII<br/>Naval Postgraduate School<br/>Monterey, CA 93943</b>   | 1  |
| 7. | <b>Mr. Sam Frazier<br/>SY84<br/>Naval Air Warfare Center<br/>Aircraft Division<br/>Patuxent River, Maryland 20670-5304</b>                                     | 1  |

8. **EMP Branch, F55** 5  
**Naval Surface Warfare Laboratory**  
**White Oak**  
**10901 New Hampshire Avenue**  
**Silver Spring, MD 20903-5000**  
**Attn: Mr. George Brackett**  
**Mr. Michael Jump**  
**Mr. Neal Stetson**  
**Mr. James Whitt**  
**Ms. Jean Visk**
9. **Mr. Larry McMurray** 2  
**Code 03K211**  
**Naval Sea Systems Command**  
**Department of the Navy**  
**Washington D.C. 20362-5001**
10. **Defense Technical Information Center** 2  
**Cameron Station**  
**Alexandria, VA 22314**