

Modeling and exergy analysis of domestic MED desalination with brine tank

Hamed Kariman^{a,*}, Siamak Hoseinzadeh^{b,*}, Stephan Heyns^b, Ali Sohani^c

^aFaculty of Mechanical and Energy Engineering, Shahid Beheshti University, A.C. Tehran, Iran, email: hamed.krmm@yahoo.com (H. Kariman)

^bCentre for Asset Integrity Management, Department of Mechanical and Aeronautical Engineering, University of Pretoria, Pretoria, South Africa, emails: Hoseinzadeh.siamak@gmail.com/Hosseinzadeh.siamak@up.ac.za (S. Hoseinzadeh)

^cOptimization of Energy Systems' Installations Lab., Faculty of Mechanical Engineering-Energy Division, K.N. Toosi University of Technology, P.O. Box: 19395-1999, No. 15–19, Pardis St., Mollasadra Ave., Vanak Sq., Tehran 1991 943344, Iran

Received 7 August 2019; Accepted 13 May 2020

ABSTRACT

Desalination systems are taken into account as one of the promising solutions to deal with the water scarcity problem. Among different kinds of desalination systems, having the advantages like using low grade thermal resources, multi-effect type is getting popular more and more. Considering the mentioned issues, in this study, a high performance multi-effect desalination (MED) system is introduced and the enhancement potential of that is evaluated in details. The introduced and reference designs are compared together from different points of view. The results showed that not only the fresh water production of the introduced MED device is enhanced from the range of 12–16 to 14–21.6 L h⁻¹ compared to the base case condition, but also gained output ratio increases up to 30%–40%. Moreover, the conducted exergy analysis shows that with the exergy efficiency of 82%, the brine tank has the highest performance among other components, while the exergy destruction for this part is negligible compared to the other parts. Therefore, a high level of improvement can be achieved using the introduced design.

Keywords: Brine; Desalination; Energy efficiency; Wastewater treatment; Seawater desalination technology

1. Introduction

Water scarcity is one of the most serious challenges for human beings to survive on the Earth, and it becomes bigger and bigger because of increasing population at a rapid pace. Among different solutions to deal with the water scarcity, using desalination units is increasingly gaining popularity thanks to providing more efficient and economical technologies.

Having the advantages like low energy consumption and operating temperature, not requiring pre-treatment, enjoying high reliability, and working with a relatively inexpensive operating cost, multi-effect desalination (MED)

systems is taken into account as one of the well-developed types of desalination technologies all around the world. They are the best alternative when a low-grade thermal source is available as the waste of another energy system.

As a very efficient and cost-effective type of MED desalination system, and following the EU's fifth research program, Renaudin et al. [1] introduced the Easy MED device. It is not only simple but also gives a great performance by having a high production rate. Moreover, the design of the device was done in a way that it can be used in both portable framework and residential applications. In this device, plate type heat exchangers are applied while the water point

* Corresponding authors.

boiling is reduced by reducing the pressure of the vapor compartment.

Going one step further, the Easy MED device introduced by Renaudin et al. [1] was modified by Kafi et al. [2]. They introduced a more complete and advanced version of the Easy MED water desalination system with new components such as a new grid and buffer. The results showed that the freshwater output became two times more than the original design while the quality was excellent [2]. After proposing the modified design by Kafi et al. [2], it has been widely used as the standard type of Easy MED device. Ng et al. [3] were also studied to investigate the different types of desalination systems. They have demonstrated the efficiency of the primary energy consumption assessment process for all types of practical desalting methods [4,5]. And achieved the normal performance ratio so far defined by the energy consumption of energy [6]. And observed that, although the legal efficiency is not thermodynamic. However, a common platform for expressing the effects of desalination processes can be significantly developed thermodynamically strong. Ideally, the seawater desalination thermodynamically created a passion for all scientists and engineers [7]. In order to study evaporative domestic desalination systems, the research of Kariman et al. [8] was studied they investigated a rotary vacuum domestic desalination system, and after exergy analysis of the system, they optimized the amount of freshwater output. And they

investigated economic analysis of the domestic desalination system and reported economic analysis results for several different cities around the world [9].

Hoseinzadeh et al. [10–12] also investigated and analyzed exergeoconomics of a reverse osmosis desalination system that works with geothermal energy and optimized production. Also, advanced exergy analysis also perform MED the same system and reported the results [13].

Also, to provide a short but extensive insight, the related studies which have been done in the field are listed in Table 1. As this table shows, after broad studies conducted on Easy MED systems, in this work, the Easy MED desalination device is modified by a brine tank, and the enhancement potential is evaluated. Employing such a modification has not been studied for the Easy MED device so far. As a result, considering the popularity of the Easy MED desalination system and the positive feedback reported on using a brine tank for other technologies, the current study is performed.

The brine tank is used for two reasons:

- *Having inlet water with the maximum amount of freshwater:* In the previously proposed design (both [1] and [2]), feedwater is cycled only once, then exits, and it is poured into the surroundings. However, in the modified system with the brine tank, feedwater passes through the system, and at each stage, a part goes to the next stage, and the remaining part returns to the brine tank. The returned

Table 1
List of the related research items done

Study	A short description of the work done	Was the brine tank employed in Easy MED device?	Was the exergy analysis conducted to investigate the system from that point?
Raach and Mitrovic [14]	A numerical model to describe heat and mass transfer was developed.	No	No
Renaudin et al. [15]	The potential of employing solar collectors for the system was investigated.	No	No
Renaudin et al. [16]	Experiments were carried out to evaluate the water desalination system.	No	No
Shen et al. [17]	Impacts of molecular weight on the device performance was studied through both simulation and experiment.	No	No
Suo et al. [18]	Inhibitors' effect on the output criteria of the system was found under high concentration conditions.	No	No
Tang et al. [19]	The optimized passage for flow in a desalination device was found.	No	No
Dong et al. [20]	A dynamic model to describe the system performance in the transient condition was developed.	No	No
Al-hotmani et al. [21]	The operating parameters of the system was determined by optimization based on minimizing the cost of freshwater generation.	No	No
Rezaei et al. [22]	By calculating levelized cost, the economic potential of using the desalination system for Qeshm Island, Iran, was evaluated.	No	No
Chong et al. [23]	The possibility of coupling the desalination device with an liquefied natural gas plant was investigated.	No	No

water is combined with the salty water, and the combination is fed into the system.

- *Operating like a temperature recovery system:* As discussed earlier, when the brine tank is used, a part of water passes through the unit, returns to the system. Because of thermal processes done at each stage, the temperature of the returned parts is relatively higher than the inlet salty water, and a combination of the returned with the salty water increases the temperature level of the input stream compared to the previously proposed design. It means that a part of the heat that was wasted in the previous design through the disposal is saved. Consequently, the temperature of the feedwater enters the evaporator significantly increases, which reduces the required energy for evaporation.

The MATLAB software program is used for mathematical modeling and simulation of both the base case (reference) system, proposed in [2] and the modified unit. Having obtained the results, the base case and modified systems are compared together from different aspects such as freshwater production and gain output ratio (GOR) while a comprehensive exergy analysis is carried out to analyze the modified system from that point of view. Based on the literature review, and to best of our knowledge, studying the enhancement potential of the system by adding the brine tank and conducting exergy analysis for that has been never done for Easy MED device before. The present study

helps to evaluate this popular MED technology better and with more details while it leads to finding the parts which have the highest exergy destruction values. Therefore, a comprehensive insight from the modified system in comparison to the reference condition is provided here.

2. Modified easy MED device

The modified Easy MED device is shown in Fig. 1. It is composed of heating and cooling units, and the brine tank. The role of each part is described in this section.

It should be noted that in the investigated modified Easy MED device plate heat exchangers are used. Each one is 0.72 m² in size and includes two sections.

2.1. Heating part

In the heating section, the heating cell operates at the ambient pressure while the hot water enters at a temperature of 70°C. Through the heat transfer process, the water flow which salt is going to be removed is preheated by the water stream which returns to the brine tank. After that, the remaining heat required to evaporate saline water is provided by a source. Here, it is supposed that this heat comes from the exhaust gases of a thermal power plant. It should be noted that the main attractive feature of MED is that it can be powered via low-grade heat that is readily available in thermal-based electric power plants (and that low-grade

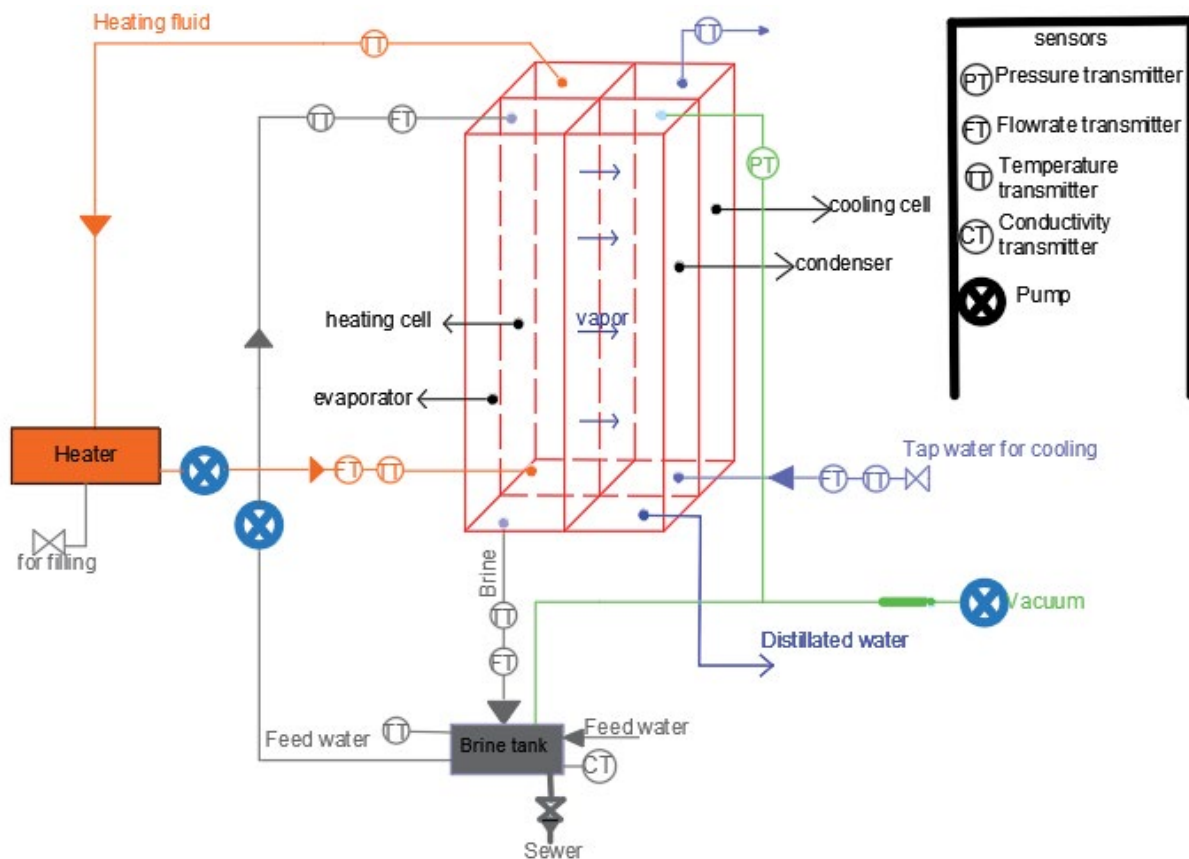

Fig. 1. The Easy MED desalination device.

heat would otherwise go to waste). In the modified design presented and investigated in this study, the number and capacity of heaters are considered 3 and 4,500 W, respectively.

The heating section does not change compared to the reference design, and therefore, the same condition as [2] for the heat transfer process, and its coefficients are considered.

2.2. Evaporator

In the evaporator, the pressure is reduced by a vacuum pump, and it reaches 120 mbar. In this way, the evaporation temperature of the water which is going to be made fresh decreases to approximately 49.6°C. A portion of water is evaporated and enters into the condenser, and the remaining part returns to the brine tank. As discussed, the returned brine is employed for preheating of the feed water.

2.3. Brine tank

In the brine tank used in the modified Easy MED device, by a concentration gauge, for a sample, the concentration of the feed water is measured after mixing with brine. The concentration gauge is connected to the brine tank, next to the sewage valve. On one hand, if the salt concentration of the feed water is higher than the permitted limit, the brine in the brine tank is removed from the system as wastewater. On the other hand, in case it is lower, the brine is combined with the stream comes from the surroundings, and the water desalination system runs to obtain a suitable condition.

System performance depends on several factors such as the flow rate of the feed water and evaporation rate at each stage in the evaporator. The latter itself is dependent on the flow rate of the heating water, the heat transfer area, and the heat transfer coefficient. As a result, in different condition for the three mentioned independent effective parameters, that is, feedwater flow rate, heat transfer area, and heat transfer coefficient, different values for operation time is achieved. For instance, the values for some conditions, which are calculated by the developed code in the MATLAB software, are given in Table 2.

The values of the effective factors in this investigation are in a way that for all the conditions in the investigation range of the study, the Easy MED device requires about 44 min to work and reach the discharging point, and then, it needs time to drain. At this time, the heaters and valves are shut down and shut off, respectively. With a feedwater flow rate of 0.105 kg s⁻¹, which is considered for this study, the brine tank is filled in about 4 min. The latter period is much

less than the former so that it could be neglected compared to that.

As it was discussed earlier, and based on the points mentioned here, using the brine tank prepares the chance of heat recovery from the hot brine stream. The positive effect of heat recovery is impressive. For example, for the values of the effective parameters considered in this study, and have been introduced so far, by using the heat recovery, the feed-water temperature increases by 45°C, which is significant. Based on the working principle of the Easy MED system, it also results in an increase in the freshwater production rate.

2.4. Cooling

According to what mentioned before, a part of heated salt water is evaporated by heating, and it must be cooled in order to achieve freshwater as the product. This goal is achieved by employing a cold plate on which evaporated water is condensed. While on one side of the cold plate, the condensate water is made and collected, on the other side the feed water flows. Feedwater is either seawater or brackish which keeps the plate cold enough. Like the reference design [2], the cooling water has a flow rate between 0.5 and 1 m³ h⁻¹.

There are also 9 thermometers at each inlet and outlet section of this part to measure the temperature, 5 flow meters to measure the flow rate, a concentration meter to measure the concentration of the brine tank, and a pressure gauge to control the vacuum pressure.

3. Modeling

MATLAB is one of the most popular software programs to investigate the performance of different energy systems, as shown in various references like [24–27].

In order to model the system, first, the mathematical equations governing all the components of a separate system are written, some of which are derived from the modeling in [2] and written for the new components of the system and Condenser equations are also obtained. Then, the simulation is performed by The MATLAB software is done and the results are mentioned.

3.1. Heater

The amount of energy needed to provide 70°C water in the first step and start the device as follows

$$E_1 = M_h^0 \times (T_h - T_{\text{ambient}}) \quad (1)$$

Table 2
Time to drain the brine water tank for different flows

Feed water flow rate (L h ⁻¹)	Heat transfer area (m ²)	Heat transfer coefficient (W m ⁻² K ⁻¹)	Time (s)
50	0.85 A	1,080	2,599
80	0.9 A	1,090	2,597
100	A	1,100	2,435
125	A	1,130	2,514
150	A	1,150	2,624

where M_h^0 is equal to the heating water flow rate. T_h is equal to the temperature of the heating water and C_p equal to the heat capacity of the water at constant pressure.

The amount of energy needed to keep the water temperature at 70°C after each temperature drop and heat transfer in the cell of the heating.

$$E_2 = M_h^0 \times (T_{hi} - T_{ho}) \quad (2)$$

where T_{hi} is equal to the inlet temperature of the heating water and T_{ho} the outlet temperature of the heating water.

3.2. Evaporator

The logarithmic temperature difference between the heating cell and the evaporator is obtained from the equation below:

$$\Delta T_{LMTD} = \frac{T_{hi} - T_{ho}}{\text{Ln} \frac{T_{hi} - T_b}{T_{ho} - T_b}} \quad (3)$$

where T_b is equal to the temperature of the brine water from the evaporator.

The amount of heat exchanged between the heating cell and the evaporator is obtained from the following equation:

$$Q_{(2)} = H \times A \times \Delta T_{LMTD} \quad (4)$$

where H is the average heat transfer coefficient between the heating cell and the evaporator and A of the active heat transfer surface.

The amount of evaporated water in the evaporator portion is obtained from the following equation:

$$M_d^0 = \frac{(Q(2) - (M_f^0 \times C_{pf} \times (T_b - T_f)))}{H_{fg}} \quad (5)$$

where C_{pf} is equal to the thermal capacity of the feed water and T_f at the inlet temperature of the feed water to the evaporator and the H_{fg} is equal to the heat of evaporation of the water under evaporation conditions. M_f^0 is equal to the amount of feed water.

Mass balance in evaporator:

$$M_f^0 = M_b^0 + M_d^0 \quad (6)$$

M_b^0 is the amount of saltwater that does not evaporate and enters the brine tank.

3.3. Brine tank

In the brine tank, the condition will continue to be the amount of salt concentration, because, in case of high recovery and rising salt concentration, salinity will increase and cause corrosion or deposition in the system. The permitted amount of water salinity is considered to be 70,000 ppm.

3.4. Salt mass balance in a brine tank

The initial volume in the tank is 25 L and the saline concentration is 36.5 g L⁻¹ in the paper [2], which is equal to 0.912 g/25 L for 25 L.

The amount of salinity in each step is obtained from the following equation;

$$S = \frac{M_{na-cl}}{M_t - M_d^0} \quad (7)$$

where M_{na-cl} is equal to the total mass of salt in the tank equal to 0.912 g and M_t is the amount of water in the tank at each stage, and M_d^0 is equal to the amount of evaporated water in each evaporator.

Enthalpy balance in a brine tank; the amount of enthalpy of water in each stage:

$$H_f = H_t + H_b \quad (8)$$

$$M_f^0 \times h_f = M_t \times h_t + M_b^0 \times h_b \quad (9)$$

where H_t is the amount of enthalpy of water in the tank and H_b is the amount of enthalpy of brine water and M_f^0 equal to the mass flow of the feed water and M_b^0 the mass flow of the brine water and M_t the mass of the tank water at each stage.

3.5. Condenser

To obtain the maximum amount of water that can be condensed with tap water in the condenser, must first obtain the Jacobin coefficient [28].

$$J_a = \frac{C_{pl} \times (T_{sat} - T_s)}{H_{fg2}} \quad (10)$$

In this equation, C_{pl} is equal to the heat capacity of saturated water and T_{sat} at the boiling point of water in vacuum conditions and T_s is equal to the surface temperature of the condenser and H_{fg2} is equal to the heat capacity of the water condensation.

Then obtain the corrected value of the special water heat capacity, which is obtained from the equation below.

$$H_{figg} = H_{fig2} \times (1 + (0.68 \times j_a)) \quad (11)$$

Then obtain the mean value of the heat transfer:

$$H_t = 0.943 \times \frac{(g \times \rho_l (\rho_l - \rho_v) \times H_{figg} \times L^3)^{0.25}}{\mu_l \times K_l \times (T_{sat} - T_s)} \quad (12)$$

where g is the gravitational acceleration of the earth and ρ_l the density of the water in the saturation fluid state and ρ_v the density of the water in the saturated water vapor, and L is the length of the surface, and μ_l is the dynamic viscosity in saturated liquid state and K_l is the temperature conductivity in a saturated liquid state.

The amount of heat transferred between the condenser and the cooling cell is the following:

$$Q(4) = H_L \times A \times (T_{\text{sat}} - T_S) \quad (13)$$

And the maximum amount of water that can be condensed by the tap water temperature is equal to:

$$M_{\text{max}}^0 = \frac{Q(4)}{H_{\text{fgg}}} \quad (14)$$

Since the highest amount of freshwater produce is less than the maximum amount that can be condensed, the remaining heat is used to reduce the temperature of the condensed freshwater and reduce its temperature to the ambient temperature [29,30].

The amount of heat that must be taken from freshwater to the first condensate and then reach the ambient temperature is:

$$Q_{(5)} = (M_d^0 \times H_{\text{fgg}}) + (M_d^0 \times C_{p_d} \times (49.6 - 25)) \quad (15)$$

GOR value [3]:

$$\text{GOR} = \frac{m_{\text{distillate}}^0 (\text{kg})}{m_{\text{steam consumed}}^0 (\text{kg})} \quad (16)$$

4. Exergy analysis

In the steady-state condition, in which the system is modeled, Eqs. (17)–(22) are the governing equations, by which exergy analysis is done.

$$E_D^0 = \sum_j \left(1 - \frac{T_0}{T_j} \right) - Q_j^0 - W_{\text{CV}}^0 + \sum_i m_i^0 e_i - \sum_e m_e^0 e_e \quad (17)$$

$$E_D^0 = T_0 S_{\text{gen}}^0 \quad (18)$$

$$e = e^{\text{PH}} + e^{\text{KN}} + e^{\text{PT}} + e^{\text{CH}} \quad (19)$$

$$e^{\text{PH}} = (h - h_0) - T_0 (S - S_0) \quad (20)$$

$$e^{\text{KN}} = \frac{1}{2} V^2 \quad (21)$$

$$e^{\text{PT}} = gz \quad (22)$$

In these equations, h_0 and s_0 are enthalpy and entropy at the ambient (reference) condition. Moreover, both the kinetic and potential exergy values are not taken into account due to the negligibility compared to the other types of exergy.

Eq. (23) is used to obtain the exergy destruction in the evaporator-heating and the condenser-cooling cells as well as the brine tank, and the primary heating water heater.

$$E_D^0 = E_{\text{IN}}^0 - E_{\text{out}}^0 \quad (23)$$

For each sub-system, as well as the whole desalination unit, the exergy efficiency is determined as follows:

$$\eta_{\text{EX}} = \frac{E_{\text{fuel}}}{E_{\text{product}}} \quad (24)$$

The fuel and product for each component are clear and introduced in the investigations each one was studied either separately or in combination with the other systems, and for that reason, like the equations of the modeling part, they are not reported to make the paper as brief as possible. Considering this point, here only the input and output for the whole system are introduced in Fig. 2.

5. Results

In this part, first, the modified Easy MED device with the brine tank is compared with the reference system from different aspects, and then, the exergy analysis is conducted to investigate the modified desalination unit from exergetic point of view.

5.1. Comparison of the modified and the reference designs

In order to evaluate the performance of the modified system compared to the reference design, the values of freshwater production are obtained at different rates for heating

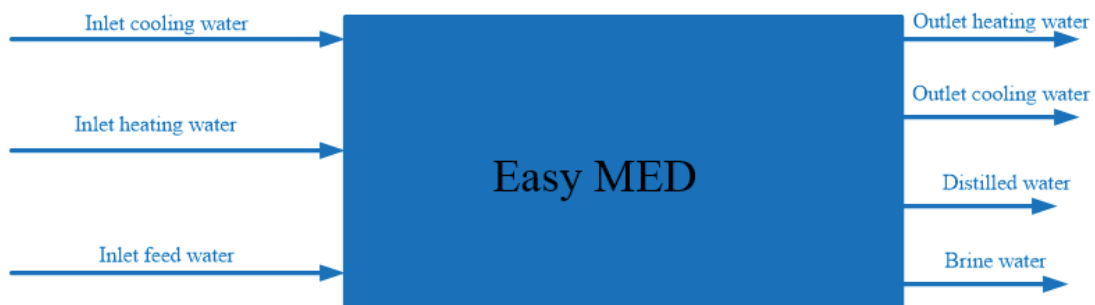

Fig. 2. Input and output of the modified investigated Easy MED with the brine tank.

water and feed water flow rates. The values are reported in Tables 3–6 for four different conditions.

In order to understand better, the reported results for different four conditions are also presented in Figs. 3–6. As Tables and figures both show, for all the investigated conditions, the modified Easy MED device provides higher performance. In a constant heating water flow rate, the higher the feedwater flow rate the system has, the more improvement is obtained, which is a huge achievement. For instance, at the heating water flow rate of 1.5 m³ h⁻¹, the enhancement in the evaporation rate is 8.4% for the feed flow rate of 50 L h⁻¹ while it becomes almost five times more and reaches 41.6% at the feed flow rate of 150 L h⁻¹. It means a notable increase in the freshwater production of the system in the modified Easy MED device compared to the reference design.

Using a similar way, the values of GOR for the Kafi et al. [2] and the modified designs are compared together in the four investigated conditions. As observed, the GOR value in

Easy MED is better. The reason is according to Eq. (16), the heating water flow rate is much greater than the distilled water, which makes GOR smaller compared to the reference design. The GOR values in different flow rates and its comparison with the reference value are reported in Tables 7–10.

By following a similar fashion to the evaporation rate, the results are also illustrated in Figs. 7–10. The comparison reveals that GOR values for the modified design are improved significantly compared to the reference design, and the enhancement has a direct relationship with the feedwater flow rate, which is a favorable outcome. As an example, at the heating water flow rate of 1.5 m h⁻¹, GOR increases 7.5% at the feed flow rate of 50 m h⁻¹ whilst by making the feedwater flow rate three times more, that is, 150 m h⁻¹, the GOR value becomes almost six times more, and it is enhanced to 41.0%.

Having evaluated the modified Easy MED design from both evaporation rate and freshwater production rate as well

Table 3
Results for heating water flow rate of 3 m³ h⁻¹

Feed water flow rate (L h ⁻¹)	Evaporation rate with brine tank (L h ⁻¹)	Evaporation rate with brine tank (%)	Evaporation rate without brine tank (L h ⁻¹)	Evaporation rate without brine tank (the design of [2]) (%)	Improvement in evaporation rate (%)
150	21.6	14.42	16.56	11.05	30.4
125	21.24	17	17.28	13.38	22.9
100	20.52	20.57	17.64	17.68	16.3
80	18.72	23.42	16.57	20.72	13.0
50	17.28	34.78	16.55	33.33	4.4

Table 4
Results for heating water flow rate of 2.5 m³ h⁻¹

Feed water flow rate (L h ⁻¹)	Evaporation rate with brine tank (L h ⁻¹)	Evaporation rate with brine tank (%)	Evaporation rate without brine tank (L h ⁻¹)	Evaporation rate without brine tank (the design of [2]) (%)	Improvement in evaporation rate (%)
150	20.52	13.7	15.12	10.09	35.8
125	20.54	16.42	16.56	13.25	23.9
100	20.16	20.21	17.28	17.32	16.7
80	18	22.52	15.84	19.81	13.7
50	16.92	34.05	16.2	32.06	6.2

Table 5
Results for heating water flow rate of 2 m³ h⁻¹

Feed water flow rate (L h ⁻¹)	Evaporation rate with brine tank (L h ⁻¹)	Evaporation rate with brine tank (%)	Evaporation rate without brine tank (L h ⁻¹)	Evaporation rate without brine tank (the design of [2]) (%)	Improvement in evaporation rate (%)
150	20.52	13.77	15.12	10.09	36.5
125	19.8	15.85	15.84	12.68	25.0
100	19.54	19.44	16.56	16.56	17.4
80	17.64	22.07	15.48	19.46	13.4
50	15.50	31.15	14.76	29.7	4.9

Table 6
Results for heating water flow rate of 1.5 m³ h⁻¹

Feed water flow rate (L h ⁻¹)	Evaporation rate with brine tank (L h ⁻¹)	Evaporation rate with brine tank (%)	Evaporation rate without brine tank (L h ⁻¹)	Evaporation rate without brine tank (the design of [2]) (%)	Improvement in evaporation rate (%)
150	18.36	12.25	12.96	8.65	41.6
125	17.64	14.12	13.32	10.66	32.5
100	16.56	16.56	13.34	13.32	24.3
80	15.48	19.36	12.98	16.2	19.5
50	14.04	28.26	12.94	26.08	8.4

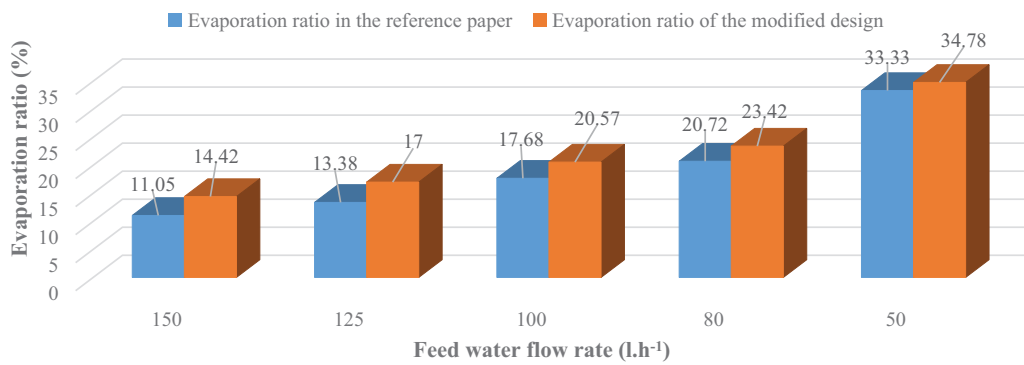

Fig. 3. Comparison of evaporation ratio for the modified and reference designs at heating water flow rate of 3 m³ h⁻¹.

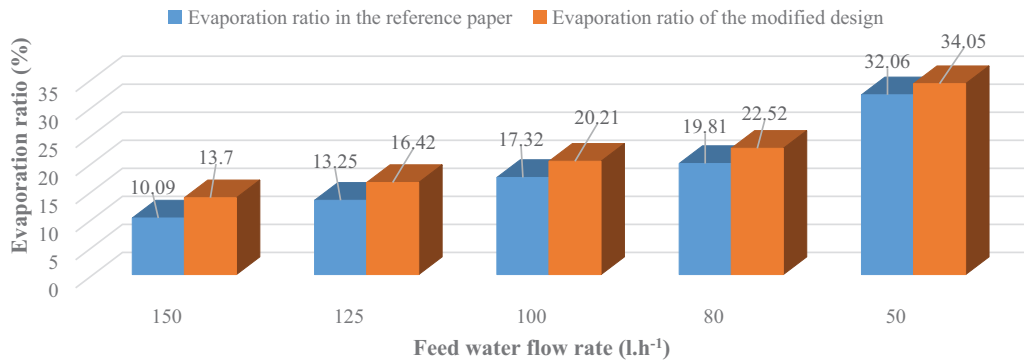

Fig. 4. Comparison of evaporation ratio for the modified and reference designs at heating water flow rate 2.5 m³ h⁻¹.

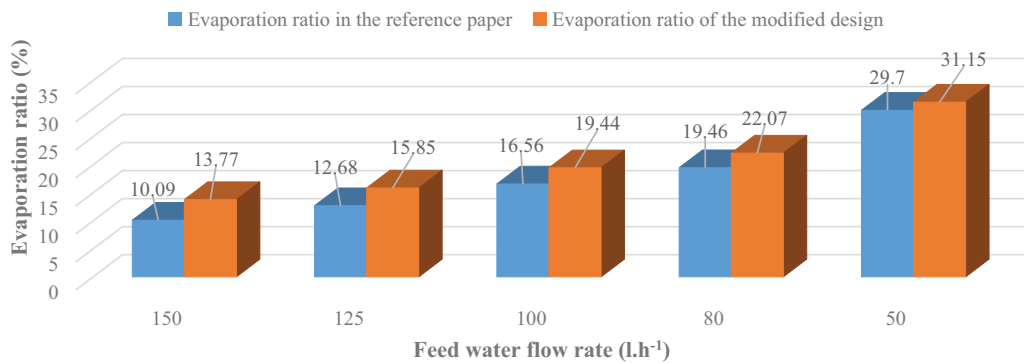

Fig. 5. Comparison of evaporation ratio for the modified and reference designs at heating water flow rate of 2 m³ h⁻¹.

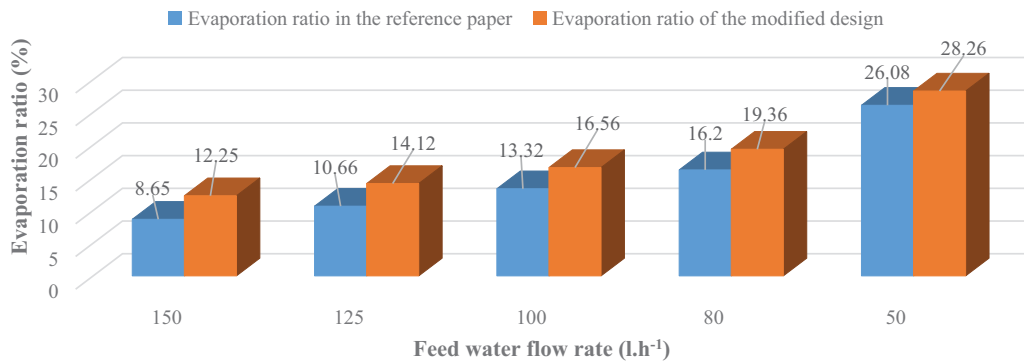

Fig. 6. Comparison of evaporation ratio for the modified and reference designs at heating water flow rate of 1.5 m³ h⁻¹.

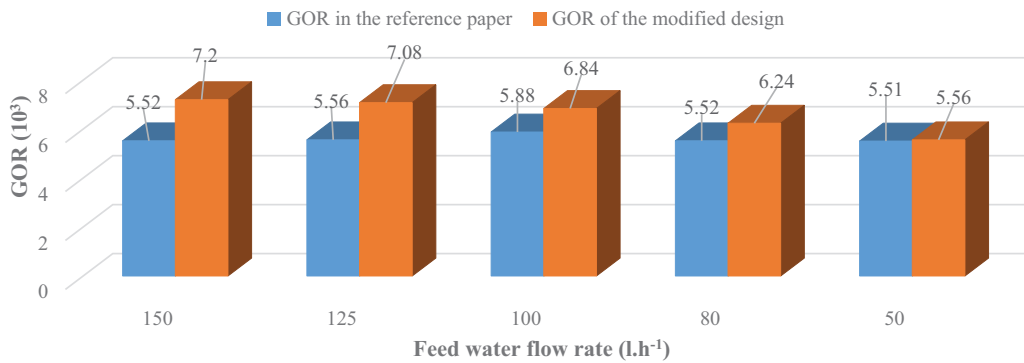

Fig. 7. Comparison of GOR values for the modified and reference designs at heating water flow rate of 3 m³ h⁻¹.

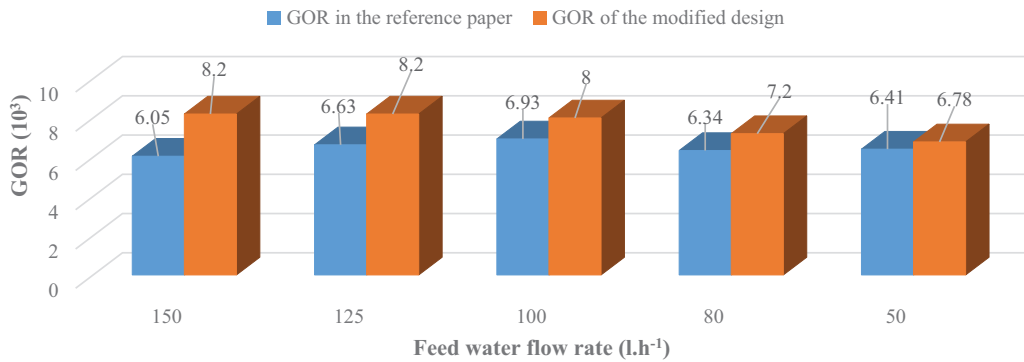

Fig. 8. Comparison of GOR values for the modified and reference designs at heating water flow rate of 2.5 m³ h⁻¹.

as GOR, it is found that for all the conditions, the modified design has a much higher performance; for the investigated cases, the freshwater production enhances from the range of 12–16 to 14–21.6 L h⁻¹, which is significant. GOR is also improved and for some conditions, 30%–40% increase is observed. Therefore, the superiority of the modified design compared to the reference device is proven.

5.2. Exergy analysis

After showing the superiority of the modified Easy MED system, in this part, exergy analysis is employed to evaluate

the brine tank and other components from this point of view and compare them together. Table 11 as well as Figs. 11 and 12 show the results. It should be noted that the values are the average the conditions considered in part 5.1.

As observed, the highest level of exergy destruction happens in the heating cell and evaporator. The best exergy performance is also seen for the brine tank, with the exergy destruction and efficiency of 24.31 W and 82%, respectively. The exergy destruction for the brine tank is so small that it can be neglected compared to the other parts, which means that the proposed modification for Easy MED system does not only have a negative impact on the exergy point of view

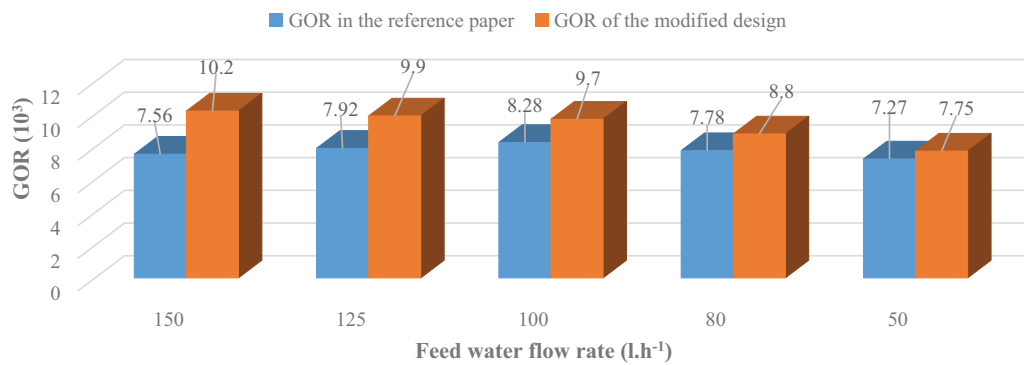

Fig. 9. Comparison of GOR values for the modified and reference designs at heating water flow rate of 2 m³ h⁻¹.

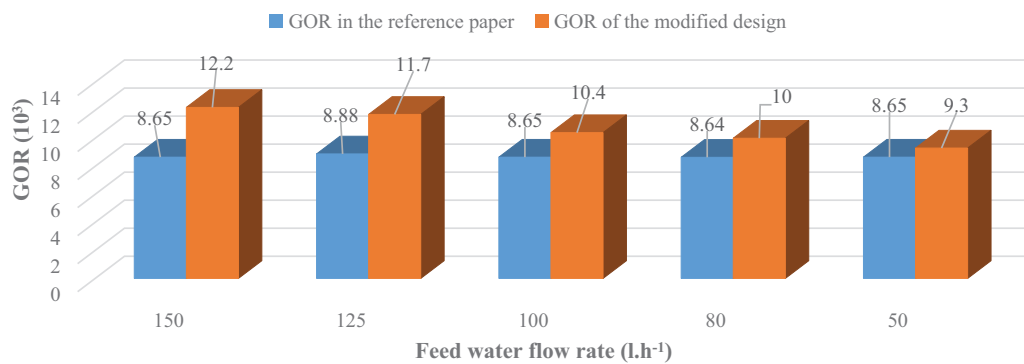

Fig. 10. Comparison of GOR values for the modified and reference designs at heating water flow rate of 1.5 m³ h⁻¹.

Table 7
Comparison of GOR values for heating water flow rate of 3 m³ h⁻¹

Feed water flow rate (L h⁻¹)	GOR of the modified design with the brine tank (10³)	GOR of the design without brine tank (the reference design presented in [2]) (10³)	Improvement (%)
150	7.20	5.52	30.4
125	7.08	5.56	27.3
100	6.84	5.88	16.3
80	6.24	5.52	13.0
50	5.56	5.51	0.9

Table 8
Comparison of GOR values for heating water flow rate of 2.5 m³ h⁻¹

Feed water flow rate (L h⁻¹)	GOR of the modified design with the brine tank (10³)	GOR of the design without brine tank (the reference design presented in [2]) (10³)	Improvement (%)
150	8.20	6.05	35.5
125	8.20	6.63	23.7
100	8.00	6.93	15.4
80	7.20	6.34	13.6
50	6.78	6.41	5.8

Table 9
Comparison of GOR values for heating water flow rate of 2 m³ h⁻¹

Feed water flow rate (L h ⁻¹)	GOR of the modified design with the brine tank (10 ³)	GOR of the design without brine tank (the reference design presented in [2]) (10 ³)	Improvement (%)
150	10.2	7.56	34.9
125	9.9	7.92	25.0
100	9.7	8.28	17.1
80	8.8	7.78	13.1
50	7.75	7.27	6.6

Table 10
Comparison of GOR values for heating water flow rate of 1.5 m³ h⁻¹

Feed water flow rate (L h ⁻¹)	GOR of the modified design with the brine tank (10 ³)	GOR of the design without brine tank (the reference design presented in [2]) (10 ³)	Improvement (%)
150	12.2	8.65	41.0
125	11.7	8.88	31.8
100	10.4	8.65	20.2
80	10	8.64	15.7
50	9.3	8.65	7.5

Table 11
Exergy destruction of sub-systems

Component	Exergy destruction(W)	Exergy efficiency (%)
Heater	7,788	57
Evaporator-heating cell	5,844	26
Condenser-cooling cell	554.67	43
Brine tank	24.31	82

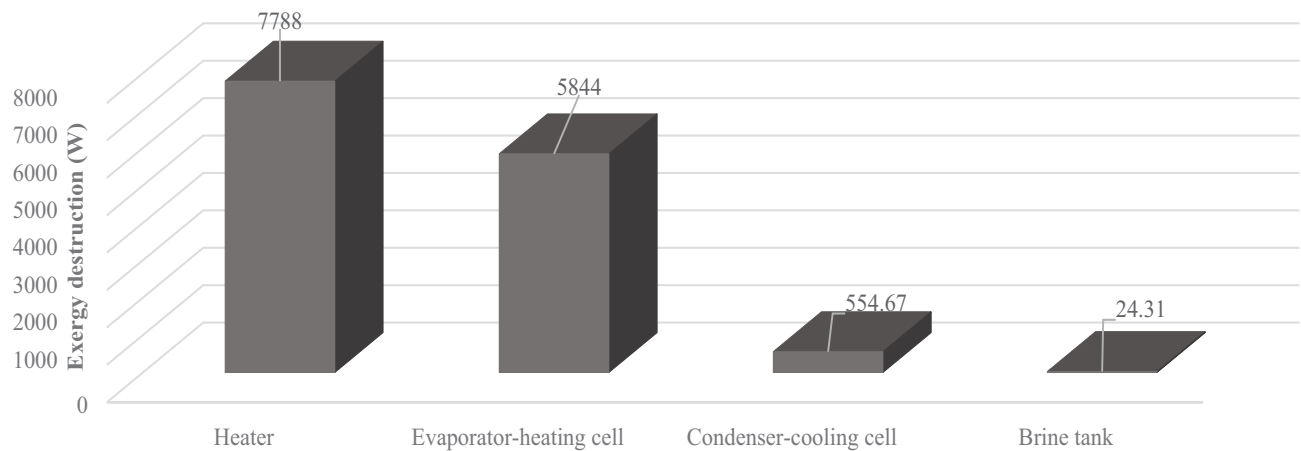

Fig. 11. Exergy destruction of the different components.

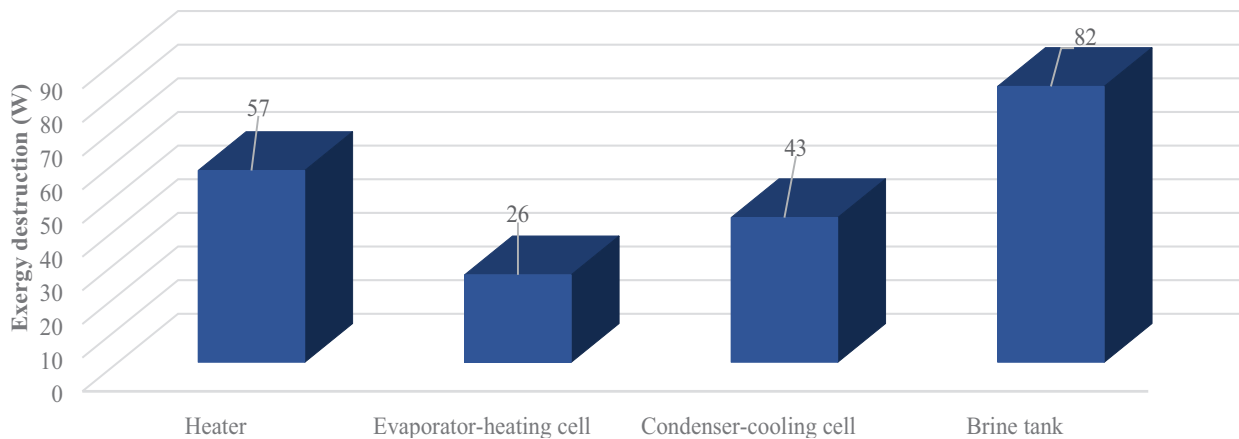

Fig. 12. Exergy efficiency of the different components.

but also improves the production and GOR of the system altogether.

6. Conclusion

Using the brine tank to enhance the performance of a previously introduced system (MED) design, which is known as Easy MED device, was suggested, and the improvement potential in comparison to the reference design was studied by considering different performance criteria. Four different values for the feed water rate and five magnitudes for heating flow rate were considered and studied. The results showed the superiority of the modified Easy MED unit with the brine tank; compared to the reference design, freshwater production increased from the range 12–16 to 14–21.6 L h⁻¹ while the GOR was enhanced between 30%–40%. Moreover, the exergy analysis demonstrated that, by having a value of 82%, the brine tank has the best exergetic efficiency while it has exergy destruction which is negligible compared to the other parts.

Symbols

A	— Active surface of the heat transfer, m ²
C_f	— Heat capacity of feed water, J kg ⁻¹ K ⁻¹
C_p	— Heat capacity of the water at constant pressure, J kg ⁻¹ K ⁻¹
C_{pl}	— Heat capacity of saturated water, J kg ⁻¹ K ⁻¹
C_{pd}	— Heat capacity of distillate water, J kg ⁻¹ K ⁻¹
E^{pd}	— Energy need to provide hot water, w
E_{0in}	— Exergy of inlet stream, J kg ⁻¹
E_{0out}	— Exergy of outlet stream, J kg ⁻¹
E_{0D}	— exergy destruction, J kg ⁻¹
E_{0F}	— Exergy of fuel, J kg ⁻¹
E_{0P}	— Exergy of product, J kg ⁻¹
E_{ch}	— Chemical exergy, J kg ⁻¹
E_{kn}	— Kinetic exergy, J kg ⁻¹
E_{ph}	— Physical exergy, J kg ⁻¹
E_{pT}	— Potential exergy, J kg ⁻¹
G	— Gravity, m s ⁻²
H	— Average heat transfer coefficient, w M ⁻² K ⁻¹
H_b	— Enthalpy of brine, J kg ⁻¹

H_i	— Enthalpy of tank water, J kg ⁻¹
H_f	— Enthalpy of feed water, J kg ⁻¹
H_{fg}	— Heat of evaporation, J kg ⁻¹
H_{fg2}	— Heat capacity of the water condensation, J kg ⁻¹
H_{fgg}	— Corrected value of the special water heat capacity, J kg ⁻¹
Ja	— Jacobin coefficient
K_l	— Temperature conductivity in saturated liquid state, W w ⁻¹ K ⁻¹
L	— Length, m
M_{ob}	— Brine flow rate, L h ⁻¹
M_{oc}	— Cooling water flow rate, L h ⁻¹
M_{of}	— Feed water flow rate, L h ⁻¹
M_{oh}	— Heating water flow rate, L h ⁻¹
Mn	— Mass of salt, g
Mn^{a-cl}	— Tank flow, L
Q	— Heat exchanged, J s ⁻¹
S	— Salinity, g L ⁻¹
$T_{ambient}$	— Temperature of ambient, °C
T_h	— Temperature of heating water, °C
T_b	— Temperature of brine, °C
T_f	— Temperature of feed water, °C
T_s	— Temperature of surface, °C
T_{sat}	— Temperature of saturation, °C
Z	— Height, m

Greek

ρ_l	— Density at saturated liquid, kg m ⁻³
ρ_v	— Density at saturated vapor, kg m ⁻³
η_{ex}	— Exergetic efficiency
μ_l	— Dynamic viscosity at saturated liquid, Pa·s
ΔT_{LMTD}	— Logarithmic temperature difference, °C

References

- [1] V. Renaudin, F. Kafi, D. Alonso, A. Andreoli, Performances of a three-effect plate desalination process, *Desalination*, 182 (2005) 165–173.
- [2] F. Kafi, V. Renaudin, D. Alonso, J.M. Hornut, New MED plate desalination process: thermal performances, *Desalination*, 166 (2004) 53–62.

- [3] K.C. Ng, M.W. Shahzad, H.S. Son, O.A. Hamed, An exergy approach to efficiency evaluation of desalination, *Appl. Phys. Lett.*, 110 (2017) 184101.
- [4] M.W. Shahzad, K.C. Ng, K. Thu, Future sustainable desalination using waste heat: kudos to thermodynamic synergy, *Environ. Sci. Water Res. Technol.*, 2 (2016) 206–212.
- [5] M.W. Shahzad, M. Burhan, N. Ghaffour, K.C. Ng, A multi evaporator desalination system operated with thermocline energy for future sustainability, *Desalination*, 435 (2018) 268–277.
- [6] M.W. Shahzad, K.C. Ng, An improved multievacuator adsorption desalination cycle for gulf cooperation council countries, *Energy Technol.*, 5 (2017) 1663–1669.
- [7] M.W. Shahzad, M. Burhan, L. Ang, K.C. Ng, Energy-water-environment nexus underpinning future desalination sustainability, *Desalination*, 413 (2017) 52–64.
- [8] H. Kariman, S. Hoseinzadeh, A. Shirkhani, P.S. Heyns, J. Wannenburg, Energy and economic analysis of evaporative vacuum easy desalination system with brine tank, *J. Therm. Anal. Calorim.*, 140 (2020) 1935–1944.
- [9] S. Hoseinzadeh, H. Kariman, P.S. Heyns, Energetic and exergetic analysis of evaporation desalination system integrated with mechanical vapor recompression circulation, *Case Stud. Therm. Eng.*, 16 (2019) 100548.
- [10] S. Hoseinzadeh, R. Yargholi, H. Kariman, P.S. Heyns, Exergoeconomic analysis and optimization of reverse osmosis desalination integrated with geothermal energy, *Environ. Prog. Sustainable Energy*, <https://doi.org/10.1002/ep.13405> (in Press).
- [11] S. Hoseinzadeh, R. Ghasemiasl, M.A. Javadi, P.S. Heyns, Performance evaluation and economic assessment of a gas power plant with solar and desalination integrated systems, *Desal. Water Treat.*, 174 (2020) 11–25, <https://doi.org/10.5004/dwt.2020.24850>.
- [12] S. Hoseinzadeh, M. Hadi Zakeri, A. Shirkhani, A.J. Chamkha, Analysis of energy consumption improvements of a zero-energy building in a humid mountainous area, *J. Renewable Sustainable Energy*, 11 (2019) 015103.
- [13] R. Yargholi, H. Kariman, S. Hoseinzadeh, M. Bidi, A. Naseri, Modeling and advanced exergy analysis of integrated reverse osmosis desalination with geothermal energy, *Water Supply*, 20 (2020) 984–996.
- [14] H. Raach, J. Mitrovic, Simulation of heat and mass transfer in a multi-effect distillation plant for seawater desalination, *Desalination*, 204 (2007) 416–422.
- [15] V. Renaudin, D. Alonso, F. Kafi, J.-M. Hornut, Potential Application of Solar Heat Collectors to an EasyMED® Thermal Desalination Unit, *Solar Desalination for the 21st Century*, Springer, 2007, pp.259–270.
- [16] V. Renaudin, F. Kafi, D. Alonso, A. Andreoli, Performances of a three-effect plate desalination process, *Desalination*, 182 (2005) 165–173.
- [17] C. Shen, X. Xu, X.-Y. Hou, D.-X. Wu, J.-H. Yin, Molecular weight effect on PAA antiscaling performance in LT-MED desalination system: static experiment and MD simulation, *Desalination*, 445 (2018) 1–5.
- [18] G. Suo, L. Xie, S. Xu, L. Feng, T. Dong, X. Shao, Study on inhibitors' performance under the condition of high concentration ratio in MED system, *Desalination*, 437 (2018) 100–107.
- [19] Y. Tang, Z. Liu, C. Shi, Y. Li, A novel steam ejector with pressure regulation to optimize the entrained flow passage for performance improvement in MED-TVC desalination system, *Energy*, 158 (2018) 305–316.
- [20] Z. Dong, M. Liu, X. Huang, Y. Zhang, Z. Zhang, Y. Dong, Dynamical modeling and simulation analysis of a nuclear desalination plant based on the MED-TVC process, *Desalination*, 456 (2019) 121–135.
- [21] O.M.A. Al-hotmani, M.A. Al-Obaidi, G. Filippini, F. Manenti, R. Patel, I.M. Mujtaba, Optimisation of multi effect distillation based desalination system for minimum production cost for freshwater, *Comput. Aided Chem. Eng.*, 46 (2019) 169–174.
- [22] A. Rezaei, A. Naserbeagi, G. Alahyarizadeh, M. Aghaie, Economic evaluation of Qeshm island MED-desalination plant coupling with different energy sources including fossils and nuclear power plants, *Desalination*, 422 (2017) 101–112.
- [23] Z.R. Chong, T. He, P. Babu, J.-N. Zheng, P. Linga, Economic evaluation of energy efficient hydrate based desalination utilizing cold energy from liquefied natural gas (LNG), *Desalination*, 463 (2019) 69–80.
- [24] A. Sohani, H. Sayyaadi, S. Hoseinpoori, Modeling and multi-objective optimization of an M-cycle cross-flow indirect evaporative cooler using the GMDH type neural network, *Int. J. Refrig.*, 69 (2016) 186–204.
- [25] A. Sohani, H. Sayyaadi, N. Mohammadhosseini, Comparative study of the conventional types of heat and mass exchangers to achieve the best design of dew point evaporative coolers at diverse climatic conditions, *Energy Convers. Manage.*, 158 (2018) 327–345.
- [26] M.E. Yousef Nezhad, S. Hoseinzadeh, Mathematical modelling and simulation of a solar water heater for an aviculture unit using MATLAB/SIMULINK, *J. Renewable Sustainable Energy*, 9 (2017) 063702, <https://doi.org/10.1063/1.5010828>.
- [27] M.H. Ghasemi, S. Hoseinzadeh, P.S. Heyns, D.N. Wilke, Numerical analysis of non-fourier heat transfer in a solid cylinder with dual-phase-lag phenomenon, *Comput. Modell. Eng. Sci.*, 122 (2020) 399–414.
- [28] T.L. Bergman, F.P. Incropera, D.P. DeWitt, A.S. Lavine, *Fundamentals of Heat and Mass Transfer*, John Wiley & Sons, 2011.