

© 2022. Nur Liza Rahim, Gary Raftery, Pierre Quenneville, Doh Shu Ing, Marcin Nabialek, Ramadhansyah Putra Jaya, Norlia Mohamad Ibrahim, Mohd Mustafa Al Bakri Abdullah, Agata Śliwa. pp. 37–50

This is an open-access article distributed under the terms of the Creative Commons Attribution-NonCommercial-NoDerivatives License (CC BY-NC-ND 4.0, <https://creativecommons.org/licenses/by-nc-nd/4.0/>), which permits use, distribution, and reproduction in any medium, provided that the Article is properly cited, the use is non-commercial, and no modifications or adaptations are made.



Research paper

The stiffness of steel-wood-steel connection loaded parallel to the grain

Nur Liza Rahim^{1,2}, Gary Raftery³, Pierre Quenneville⁴,
Doh Shu Ing⁵, Marcin Nabialek⁶, Ramadhansyah Putra Jaya^{7,8},
Norlia Mohamad Ibrahim^{9,10}, Mohd Mustafa Al Bakri Abdullah^{11,12},
and Agata Śliwa¹³

¹PhD., Eng., University Malaysia Perlis, Faculty of Civil Engineering Technology, 02600 Arau Perlis, Malaysia, e-mail: nurliza@unimap.edu.my, ORCID: 0000-0001-6609-8512

²Sustainable Environment Research Group (SERG), Centre of Excellence Geopolymer and Green Technology (CEGeoGTech), University Malaysia Perlis (UniMAP), 01000 Kangar Perlis, Malaysia

³PhD., Eng., University of Auckland, Faculty of Civil Engineering, Department of Civil and Environmental Engineering, Auckland, New Zealand, e-mail: g.raftery@auckland.ac.nz, ORCID: 0000-0003-4783-3897

⁴Prof., PhD., Eng., University of Auckland, Faculty of Civil Engineering, Department of Civil and Environmental Engineering, Auckland, New Zealand, e-mail: p.quenneville@auckland.ac.nz, ORCID: 0000-0002-7470-9990

⁵Assoc. Prof., PhD., Eng., Department of Civil Engineering, College of Engineering, University Malaysia Pahang, 26300 Gambang Kuantan, Pahang Malaysia, e-mail: dohsi@ump.edu.my, ORCID: 0000-0001-6607-0552

⁶Prof., Department of Physics, Częstochowa University of Technology, Częstochowa, Poland, e-mail: nmarcell@wp.pl, ORCID: 0000-0001-6585-3918

⁷Assoc. Prof., PhD., Eng., Department of Civil Engineering, College of Engineering, University Malaysia Pahang, 26300 Gambang Kuantan, Pahang Malaysia, e-mail: ramadhansyah@ump.edu.my, ORCID: 0000-0002-5255-9856,

⁸Centre of Excellence Geopolymer and Green Technology (CEGeoGTech), University Malaysia Perlis (UniMAP), 01000 Kangar Perlis, Malaysia

⁹PhD., Eng., University Malaysia Perlis, Faculty of Civil Engineering Technology, 02600 Arau Perlis, Malaysia, e-mail: norlia@unimap.edu.my, ORCID: 0000-0002-6350-3858,

¹⁰Sustainable Environment Research Group (SERG), Centre of Excellence Geopolymer and Green Technology (CEGeoGTech), University Malaysia Perlis (UniMAP), 01000 Kangar Perlis, Malaysia

¹¹Prof., PhD., University Malaysia Perlis, Faculty of Chemical Engineering Technology, 02600 Arau Perlis, Malaysia, e-mail: mustafa_albakri@unimap.edu.my, ORCID: 0000-0002-9779-8586,

¹²Centre of Excellence Geopolymer and Green Technology (CEGeoGTech), University Malaysia Perlis (UniMAP), 01000 Kangar Perlis, Malaysia

¹³PhD., Division of Materials Processing Technology and Computer Techniques in Materials Science, Silesian University of Technology, 44-100 Gliwice, Poland, e-mail: agata.sliwa@polsl.pl, ORCID: 0000-0001-9459-3895

Abstract: In Eurocode 5, the stiffness equation for bolted steel-wood-steel is stated as a function of wood density and fastener diameter only. In this research, an experimental study on various configurations of tested bolted steel-wood-steel (SWS) connections has been undertaken to predict the initial stiffness of each connection. In order to validate the Eurocode 5 stiffness equation, tests on 50 timber specimens (40 glued laminated timbers and 10 laminated veneer lumbers (LVL)) with steel plates were undertaken. The number of bolts was kept similar and the connector diameter, timber thickness, and wood density were varied. The results obtained in the experimental tests are compared with those obtained from the Eurocode 5 stiffness equation. From the analysis, it is signified that the stiffness equation specified in Eurocode 5 for bolted SWS connections does not adequately predict the initial stiffness. The results from Eurocode 5 stiffness equation are very far from the experimental values. The ratio of stiffness equation to experimental results ranges from 3.48 to 4.20, with the average at 3.77, where the equation over-predicted the experimental stiffness value for the connection. There is a need to consider or incorporated other parameters such as geometric configurations in Eurocode 5 stiffness equation to improve the ratio with the experimental data.

Keywords: stiffness, bolt connection, timber, steel-wood-steel, Eurocode 5

1. Introduction

The mechanical performances of timber connections are particularly crucial for timber engineers involved in the design of the wood structures. In general, connections are often one of the critical concerns when designing timber structures. Timber connections are complex to design or model since they are affected by several factors such as geometry, type of fasteners, moisture content of timber elements, loading duration and the density of the wood. The effect of the factors above should all be considered in the design of timber connections. Most of the research in the past was done on the load-carrying capacity of these connections. Johansen [1] did excellent research, attempting to establish formulas to calculate the maximum load for one single bolt. With modifications and improvements, this theory is the basis for the European Yield Model (EYM) [2], but this model has no rigorous mechanical basis such as stiffness. This data is critical for designers who are interested in designing for high wind and earthquakes, where stiffness and ductility, in addition to other serviceability issues, become a major issue.

The stiffness of a fastener is defined as the ratio of its lateral load per shear plane divided by its slip [3]. In Eurocode 5 (EC5) [4], the stiffness property is referred to as the slip modulus. Load-slip curves are important to determine the stiffness. They describe how much displacement will appear under a certain force. The technique to obtain the load-slip curves is described in EC5. To simplify the calculation of a connection's stiffness, EC5 provides formulas from which the slip modulus at yield load (K_{ser}) can be estimated. The formulas for K_{ser} are presented in Table 1 and represent values per shear plane per fastener, connecting two timber parts. For the steel-to-timber connection, the instantaneous slip will be half the value of the timber-to-timber connection and consequently, its stiffness will theoretically be twice the slip modulus of the timber-to-timber connection, i.e. $2 \times K_{ser}$ [3].

From Table 1, stiffness equations in EC5 are stated as a function of wood density (ρ) and fastener diameter (d) only. However, the latest study by [5] shows that row spacing and end distance affect the structural performance of dowelled cross-laminated timber connections.

Furthermore, another study by [6] also indicates that end distance and moisture content affect the behaviour of bolted connections. Thus, in this paper, an experimental study on the connection stiffness has been done to show that the stiffness equation given in EC5:

$$(1.1) \quad K_{\text{ser}} = \rho^{1.5} \cdot \frac{d}{23}$$

for bolted connections does not adequately predict the initial stiffness of bolted timber connections.

Table 1. Values for K_{ser} for fasteners (in N/mm) in timber to timber and wood-based panel-to-timber connections*

Type of fastener used	K_{ser}
Nails	
– Without pre-drilling	$\rho^{1.5} \cdot \frac{d^{0.8}}{30}$
– With pre-drilling	$\rho^{1.5} \cdot \frac{d}{23}$
Staples	$\rho^{1.5} \cdot \frac{d^{0.8}}{80}$
Screws	$\rho^{1.5} \cdot \frac{d}{23}$
Bolts with or without clearance	$\rho^{1.5} \cdot \frac{d}{23}$
Dowels	$\rho^{1.5} \cdot \frac{d}{23}$

*Based on Table 7.1 in EC5 [4]

2. Experimental program

This section describes the experimental study of bolted connections that was initiated to assess the stiffness of bolted timber connections. By conducting the bolted connection tests, the effect on stiffness caused by varying parameters can be determined. Also, the stiffness equations (as stated in EC5) in predicting the stiffness of bolted connections can be validated.

2.1. Material properties

In the laboratory tests of bolted connections, New Zealand Radiata Pine glued laminated timber and laminated veneer lumber (LVL) have been used. The material properties of each test specimen are presented in Sections 2.1.1, 2.1.2 and 2.2.

2.1.1. Radiata pine glued laminated timber

The glued laminated timber that was used in this study is a commercial product, “Prolam” provided by Prowood Limited. Prolams used in this study are made from New Zealand Radiata Pine. Using timber treatments from Boric H1.2 to Copper Chrome Arsenate (CCA) H5 [7], Prolam meets the durability requirements of almost any situation. Manufactured in New Zealand in three structural grades PL17, PL12 and PL8 [8]. PL8 has been used in this test as shown in Fig. 1a. The data for PL8 is shown in Table 2.



(a) Glued laminated timber (PL8)



(b) Laminated veneer lumber (LVL11)

Fig. 1. Specimens used in the test

Table 2. Characteristic stresses and elastic moduli for PL8 [9]

Property	Magnitude (MPa)
Bending	19
Tension parallel to the grain	10
Shear in Beam	3.7
Compression parallel to the grain	24
Modulus of elasticity	8000
Short duration modulus of rigidity for beams	530

2.1.2. Laminated veneer lumber (LVL)

The laminated veneer lumber (LVL) used in this study is a commercial product “J-Form” provided by New Zealand Wood Products Limited. J-Form is a structural LVL product made from 100% renewable plantation wood resources – Radiata Pine. As an engineered wood product, it has been specially designed and manufactured for use in construction.

Independently certified and made in accordance with strict quality and environmental standards, it is strong, durable, reliable and reusable. This LVL is manufactured under the requirements of [10]. LVL11 has been used in this test as shown in Fig. 1b. The data for LVL11 is shown in Table 3.

Table 3. Characteristic stresses and elastic moduli for LVL11 [11]

Property	Magnitude (MPa)
Bending	38
Tension parallel to grain	26
Shear in Beam	5
Compression parallel to grain	38
Modulus of elasticity	11 000
Short duration modulus of rigidity for beams	550

2.2. Timber properties determination

This section describes the tests conducted (i.e., moisture content and density) to determine the properties of Radiata Pine glued laminated timber and LVL. The main purpose of the tests is to provide the basic parameters that are required in the prediction of the bolted connection stiffness values. The density and moisture content of timber were determined as they will affect the stiffness and load-carrying capacities of the connections.

2.2.1. Moisture content and density

To determine the density of wood of Radiata Pine LVL and glued laminated timber, the testing procedures outlined in [12] were followed. As recommended by the standards, the test pieces were taken from the specimens that were prepared for the bolted connection tests. Thus, density test pieces were prepared after conducting the main bolted connection tests. An average dimension of 50 mm (length) \times 40 mm (width) \times 40 mm (thickness) tests pieces were prepared and measured with an accuracy of 0.1 mm. The mass of each test piece was recorded with an accuracy of 0.01 g. The density is calculated by dividing the weight by volume. Table 4 shows the results of the density tests conducted. The average

Table 4. Density tests results

Specimen type	Total number	ρ_{avg} (kg/m ³)	Standard deviation	Coefficient of variation (%)
Glued laminated timber, PL8	20	505	9.3	1.8
LVL11	5	570	9.8	1.7

density of glued laminated timber and LVL is found to be 505 kg/m^3 and 570 kg/m^3 , respectively.

All glued laminated timber and LVL specimens were stored prior to testing in an environmentally controlled chamber set at a relative humidity and temperature of approximately 65% and 20°C , respectively. This ensured that the tests specimens would maintain an equilibrium moisture content of approximately 12%. Before each test, all specimens were inspected for moisture content. An L601-3 hand-held moisture meter manufactured by Wagner Electronics was used to measure the moisture content at three faces of the specimens. The average measured moisture content for specimens is shown in Table 5.

Table 5. Moisture content results

Specimen type	Total number	Average moisture content (%)	Standard deviation	Coefficient of variation (%)
Glued laminated timber, PL8	40	12.1	0.9	7.6
LVL11	10	12.0	0.5	4.2

3. Test setup and instrumentation details

3.1. Materials

In the laboratory tests of bolted connections, the cross-section of each wood specimen used was 90 mm (thickness) \times 190 mm (width) and 135 mm (thickness) \times 190 mm (width) for glued laminated timber and 90 mm (thickness) \times 190 mm (width) for LVL. The diameters of bolts (d) that were used were 20 mm, 16 mm and 14 mm with a shank length of 180 mm and 160 mm to avoid the bolt thread in contact with the wood specimens. All bolts used were 4.8 grade and in accordance with [13]. The fastener tensile strength (f_{up}) and yield strength (f_{yf}) were 400 MPa. A total of four steel side plates as shown in Fig. 2, grade 300 W with ultimate tensile strength, f_{up} of 400 MPa were used in these connection tests, where the thickness of the plates is 10 mm.



Fig. 2. Steel side plates

3.2. Specimen configurations

All test specimens consisted of three-member connections with two steel side plates at each end sandwiching a wood centrepiece, as shown in Fig. 3. Five groups of different configurations of specimens were tested, where each group comprised of at least ten replicates. Each specimen consisted of an identical configuration of bolted connections at both ends. To ensure two independent connections were achieved in all specimens, a minimum distance of 400 mm between connections was used. The minimum distance chosen is in compliance with [14]. Group V2 was tested with LVL and the other groups were tested with glued laminated timber. All groups had two rows ($n_r = 2$), four bolts, same size of end distance (a_{3t}), row spacing (a_2) and bolt spacing (a_1) but the bolt diameter, thickness of the timber member and density of the wood was varied. Refer to Fig. 4 for a definition of the variables used and to Table 6 for the specimen configuration details.

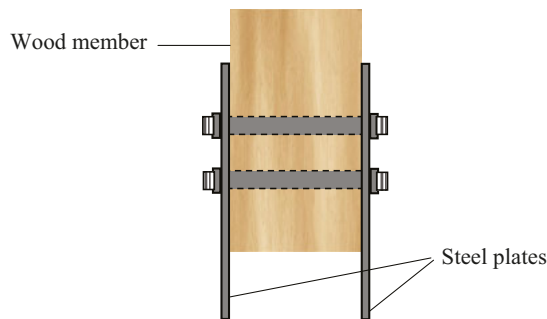

Fig. 3. Double shear joints with steel side plates

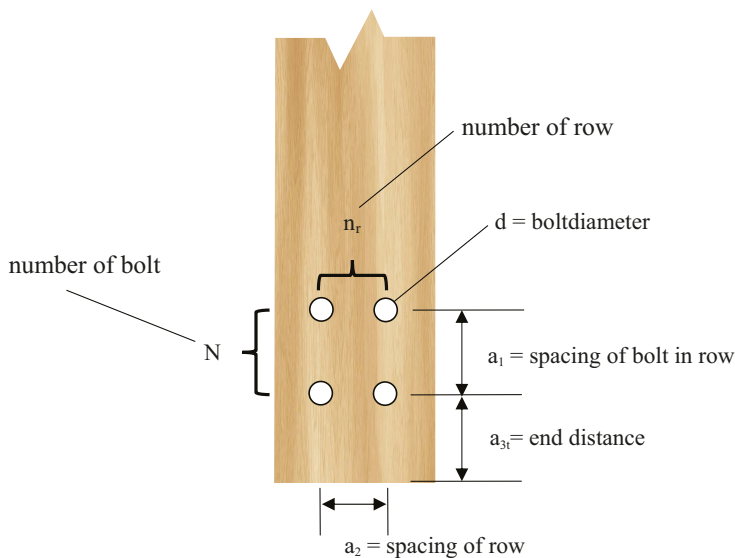

Fig. 4. Definitions of the variables used

Table 6. Specimen configuration details

Group	Type	d (mm)	a_{3t}	a_1	a_2	n_r	N	Cross-section (mm ²)	Timber length (mm)
V1	Glued laminated timber PL8	20	10d	10d	5d	2	2	90 × 190	1200
V2	LVL 11	20	10d	10d	5d	2	2	90 × 190	1200
V3	Glued laminated timber PL8	20	10d	10d	5d	2	2	135 × 190	1200
V4	Glued laminated timber PL8	16	10d	10d	5d	2	2	90 × 190	1200
V5	Glued laminated timber PL8	12	10d	10d	5d	2	2	90 × 190	1200

3.3. Instrumentation and test procedures

All specimens were loaded in tension parallel to the timber grain using a 500 kN MTS loading system. Finger tight force was applied to all fasteners to permit self-alignment of the test specimens, and a monotonic tension load was applied through the steel side plates. Each specimen was tested at a displacement-controlled rate of 1 mm per minute until it reached the plastic region. The load was applied by following the loading protocol specified in [15], where the load was firstly increased from zero to 0.4 times of estimated failure load, F_{EST} . Then it was decreased to 0.1 F_{EST} . After finishing this process, the specimen was reloaded until it reached the plastic region (see Fig. 5). Fig. 6a shows a typical specimen in the testing frame.

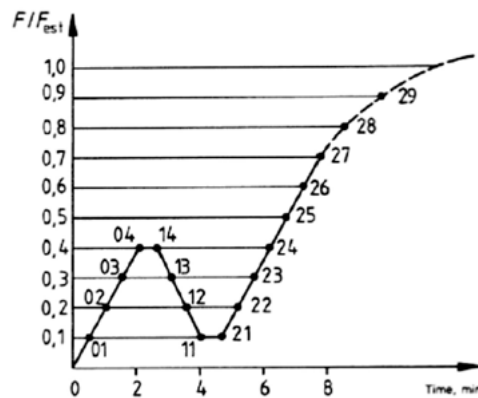

Fig. 5. Loading procedure followed in a bending test [15]

Both ends of each specimen were monitored for displacement. Four portal gauges were used to measure the displacement of the internal wood member with reference to the side

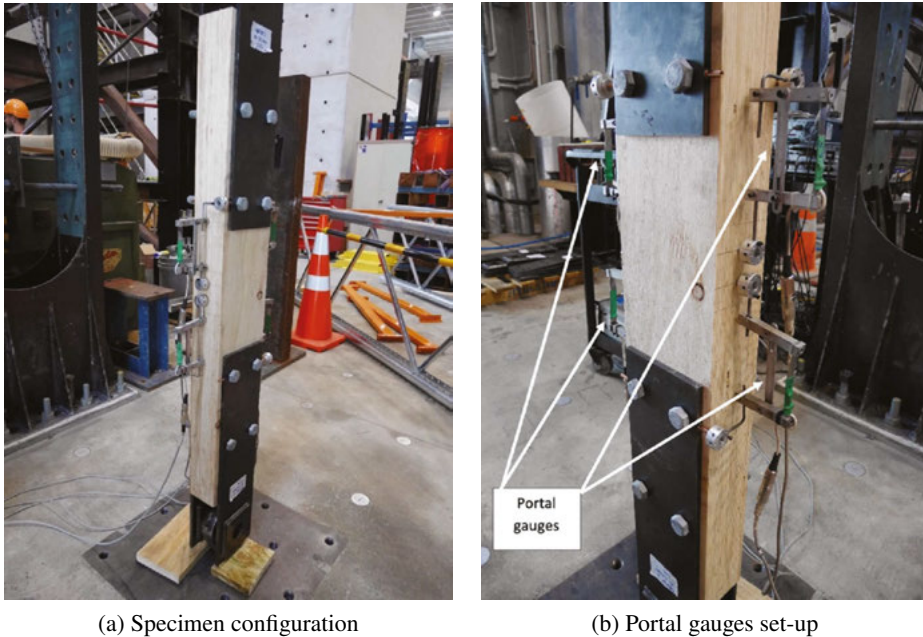

Fig. 6. Bolted connection test

steel plate at each extremity. Two portal gauges were used per connection, one attached to each steel plate, so an average displacement could be measured. The location of the portal gauges on the timber was kept consistent throughout the project. An example of the set-up for the portal gauges is shown in Fig. 6b. Each load and displacement data were recorded by a data acquisition system.

4. Bolted connection test results

4.1. General

This section provides the bolted connection test results of New Zealand Radiata Pine glued laminated timber and LVL loaded parallel to the grain. Load displacement curves have been processed for all 50 specimens based on the experimental data recorded. Each curve has been analysed to determine the initial stiffness $K_{ser(test)}$ of the bolted timber connection. The values of $K_{ser(test)}$ measured from tests for each group are presented in Section 4.2. The value of bolted connection stiffness, K_{ser} using Eq. (1.1) against the test results obtained are also described in detail.

4.2. Load-displacement and stiffness results

Figure 7 shows the typical load versus displacement curves for all groups. Referring to Figure 7a, the initial stiffness, $K_{ser(test)}$ for each curve has been calculated from 10% to 40%

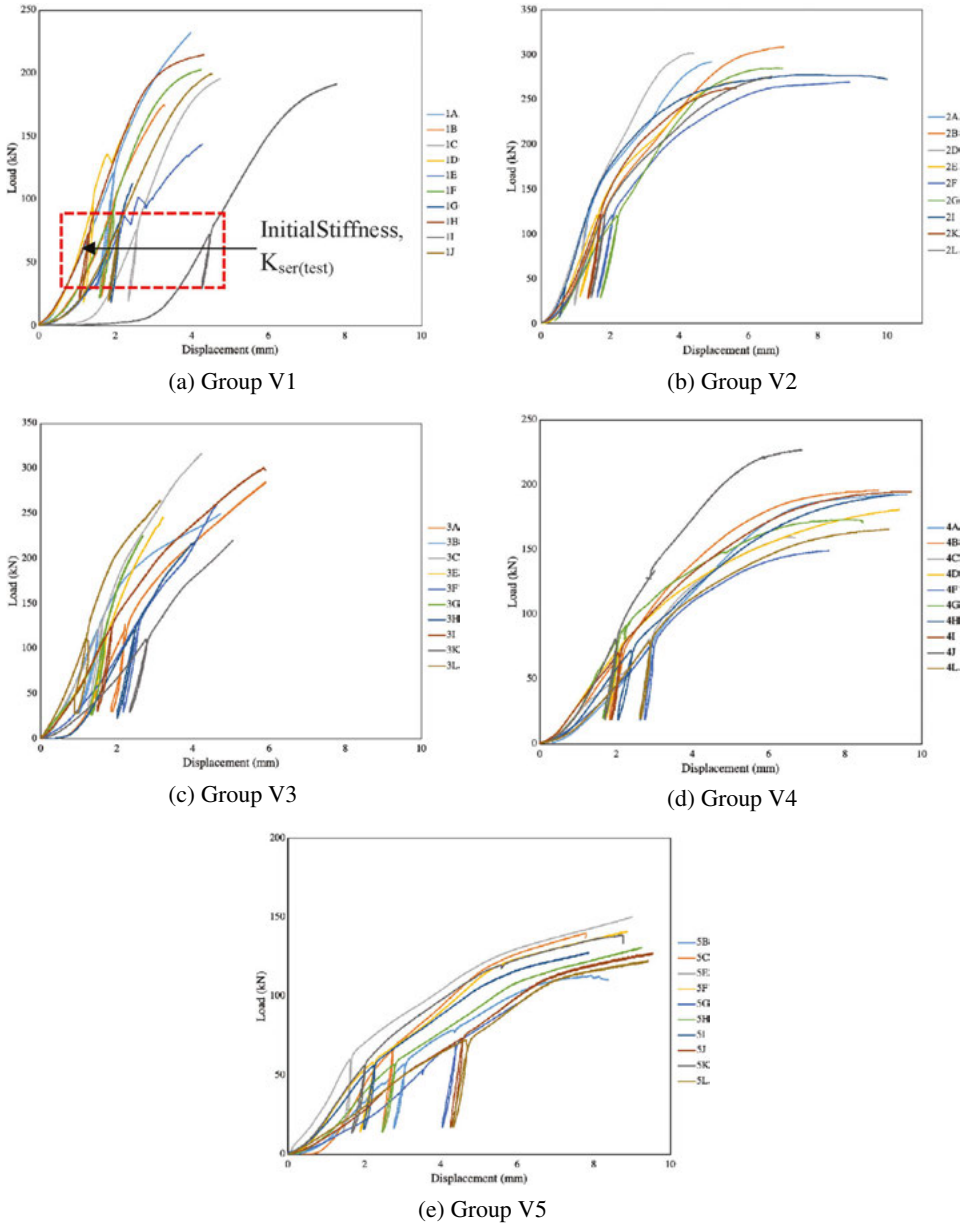

Fig. 7. Load-displacement curves for all groups

of P_{\max} . All values of $K_{\text{ser}(\text{test})}$ for group V1–V5 have been calculated and presented in Table 7. Figure 8 shows an example of a tested specimen, 2I of the permanent deformation in the wood underneath the bolt that was exhibiting ductile behaviour.

Table 7. Moisture content results

Group	d (mm)	a_{3t}	a_1	a_2	n_r	N	Cross-section (mm ²)	Type	Density (kg/m ³)	$K_{\text{ser}(\text{test})}$ (kN/mm)	$K_{\text{ser}(\text{test})}$ (per bolt) (kN/mm)
V1	20	10d	10d	5d	2	2	90 × 190	PL8	505	75.3	9.4
V2	20	10d	10d	5d	2	2	90 × 190	LVL11	570	92.0	11.5
V3	20	10d	10d	5d	2	2	135 × 190	PL8	505	103.5	12.9
V4	16	10d	10d	5d	2	2	90 × 190	PL8	505	63.4	7.9
V5	12	10d	10d	5d	2	2	90 × 190	PL8	505	54.2	6.8

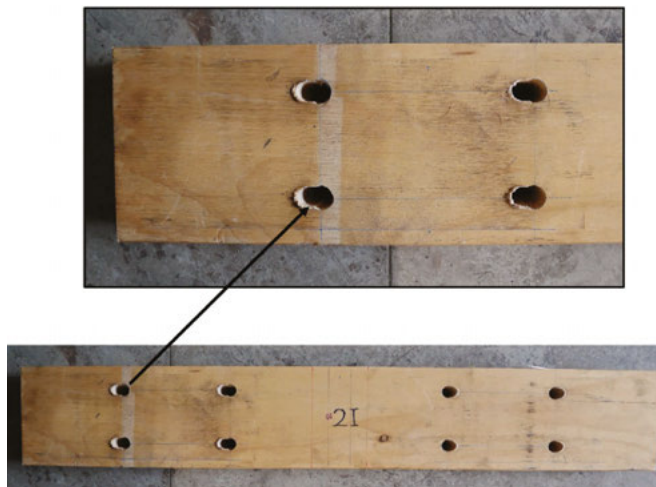

Fig. 8. Deformation of the wood for specimen 2I

For each specimen, the stiffness $K_{\text{ser}(\text{test})}$ was determined. Apart from an expected variation due to the natural scatter of wood, the determination of stiffness values is also heavily influenced by the test execution, mainly by two issues:

I. Estimated load-carrying capacity F_{est} :

Only after a first test, the chosen value for F_{est} can be verified. Therefore, F_{est} may change during a test series or may not correspond to the actual reached load-carrying capacity. Furthermore, in order not to damage the specimens, a lower value for F_{est} may be chosen. This is certainly necessary for big specimens that reach a high load-carrying capacity as then, 40% of F_{est} may damage the joint locally.

II. Measuring locations:

In the standards that define testing protocols such as EN 26891, no provisions are given as to where the testing data should be measured. For instance, whether the measuring instruments should be fastened in the barycentre lines of the joints or whether they should cover the whole joint by measuring outside the joint.

The mean values obtained in the tests, $K_{\text{ser}(\text{test})}$ for the connection stiffness for five groups are presented in Table 7. The value of $K_{\text{ser}(\text{test})}$ per bolt have been calculated by dividing it by the number of bolts and shear plane. As expected, one can see that the stiffness of the connection is clearly affected by the density of wood, bolt diameter and thickness of the member. The smaller the diameter of bolt, density and thickness of wood gives the smaller value of the initial stiffness of the connection. In terms of material properties, the results obtained generally show a significant variation of the joints stiffness with the variation of the timber properties. By comparing Groups V1 and V2, the values obtained for the stiffness of the joints made with LVL are around 22% higher than those for glued laminated timber.

On the other hand, a variation of the joint stiffness was observed when the bolt diameter varied. The results of the test series with 20 mm diameter bolts show the highest stiffness, followed by the test series with 16 mm diameter, and the lowest one corresponds to the 14 mm diameter. The analysis of the experimental load–displacement curves showed that the deformations increase slightly with the decrease of the bolt diameter.

As expected, the thickness of the wood member affected the stiffness of the connection. A decrease of around 37% was found (between Groups V1 and V3) when wood with 90 mm thickness was used. This result can be supported by [16], where the stiffness of bolted timber connection is strongly dependent on the wood density, fastener diameter, bolt spacing, end distance and thickness of timber member where the greater the density, diameter, bolt spacing, end distance and thickness of timber member, the higher the stiffness value of bolted timber connection.

4.3. Comparison to Eurocode 5 stiffness equation

By using Eq. (1.1), the initial stiffness values for each bolt were determined. In determining those values, an average density of Radiata Pine glued laminated timber and LVL was applied. The stiffness values per bolt for each group of connections are calculated and tabulated in Table 8 and Fig. 9 for comparison. The results from Eq. (1.1), K_{ser} are very far from the experimental values, $K_{\text{ser}(\text{test})}$. As can be seen in Table 8, the ratio of EC5 stiffness equation to experimental results ranges from 3.48 to 4.20, with the average at 3.77 where K_{ser} over predicted the stiffness value for the connection. From the result, it shows that other parameters such as geometric configuration need to be incorporated in Eq. (1.1) for initial stiffness estimation to improve the ratio with the experimental data.

From the comparisons made above, the use of Eq. (1.1) to estimate the initial stiffness on timber bolted connection was verified. However, the number of comparisons to validate the stiffness equation is limited. So, a more comprehensive analysis needs to be accomplished by comparing experimental data and EC5 stiffness equation.

Table 8. Moisture content results

Group	$K_{ser(test)}$ (kN/mm) (per bolt)	K_{ser} (kN/mm) (per bolt)	$K_{ser}/K_{a(test)}$
V1	9.4	39.47	4.20
V2	11.5	47.33	4.12
V3	12.9	39.47	3.06
V4	7.9	31.58	4.00
V5	6.8	23.69	3.48

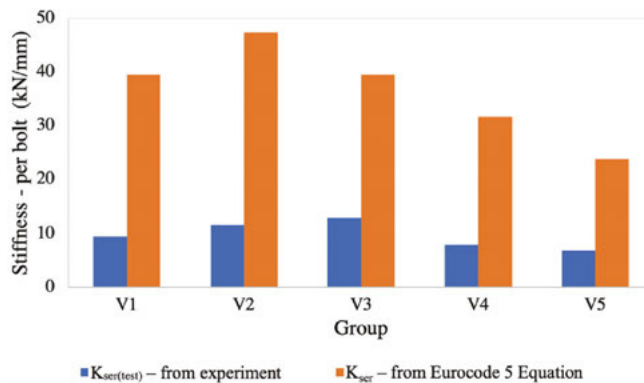
Fig. 9. Comparison between $K_{ser(test)}$ and K_{ser}

5. Conclusions

Based on the experimental study conducted, the following conclusions can be drawn:

1. Basic properties such as density of Radiata Pine glued laminated timber and LVL was determined. This parameter is important for predicting the initial stiffness of bolted connections using Eq. (1.1). The moisture content of timbers was also determined to ensure that international test procedures were followed.
2. In order to consider the factors that affect the stiffness of bolted connections, specimens consisting of steel-wood-steel connections with different configurations were tested in tension.
3. The load-displacement curves and stiffness of bolted connections for glued laminated timber and LVL were successfully assessed.
4. Eq. (1.1) to predict the initial stiffness of bolted connections were assessed for all five groups of connections.
5. The results from Eq. (1.1), K_{ser} are very far from the experimental values, $K_{ser(test)}$. The ratio of stiffness equation to experimental results ranges from 3.48 to 4.20, with the average at 3.77. K_{ser} over predicted the stiffness value for the connection. There is a need to consider or incorporated other parameters such as geometric configuration in Eq. (1.1) to improve the ratio with the experimental data.

References

- [1] K.W. Johansen, “Theory of timber connectors”, *International Association of Bridge and Structural Engineering (IABSE)*, Bern, Switzerland, 1949, vol. 9.
- [2] P. Quenneville, M. Mohammad, “On the failure modes and strength of steel wood-steel bolted timber connections loaded parallel-to-grain”, *Canadian Journal of Civil Engineering*, 2000, vol. 27, no. 4, pp. 761–773, DOI: [10.1139/l00-020](https://doi.org/10.1139/l00-020).
- [3] J. Porteous, A. Kermani, *Structural Timber Design to Eurocode 5*. United Kingdom: Wiley – Blackwell, 2013.
- [4] EN 1995-1-1:2004/A1:2008 *Eurocode 5: Design of Timber Structures – Part 1-1: General – Common Rules and Rules for Buildings*. European Committee for Standardization.
- [5] J.R. Brown, M. Li, “Structural performance of dowelled cross-laminated timber hold-down connections with increased row spacing and end distance”, *Construction and Building Materials*, 2021, vol. 271, DOI: [10.1016/j.conbuildmat.2020.121595](https://doi.org/10.1016/j.conbuildmat.2020.121595).
- [6] A. Lokaj, P. Dobes, O. Sucharda, “Effects of loaded end distance and moisture content on the behavior of bolted connections in squared and round timber subjected to tension parallel to the grain”, *Materials*, 2020, vol. 13, no. 23, DOI: [10.3390/ma13235525](https://doi.org/10.3390/ma13235525).
- [7] NZS 3602:2003 *Timber and wood-base product for use in building*. Standards New Zealand, 2003.
- [8] AS/NZS 1328.1:2003 *Glued laminated structural timber – Performance requirements and minimum production requirements*. Standards New Zealand, 2003.
- [9] Prowood NZ, “Prolam – Structural timber guide”. Motueka, New Zealand, 2016.
- [10] AS/NZS 4357.3:2004 *Structural laminated veneer lumber – Determination of structural properties – Evaluation methods*. Standards New Zealand, 2004.
- [11] Nelson Pine Industries Ltd., *LVL – specific engineering design guide*. New Zealand, 2012.
- [12] AS/NZS 1080.3:2003 *Timber – Methods of test – Method 3: Density*. Standards New Zealand, 2003.
- [13] EN ISO 898-1:1999 *Mechanical properties of fasteners part 1: bolts, screws and studs*. International Organization for Standardization, Switzerland, 1999.
- [14] ISO/DIS 10984-2 *Timber structures – dowel-type fasteners – Part 2: determination of embedding strength and foundation values*. International Organization for Standardization, Switzerland, 2008.
- [15] EN 26891 *Timber structures – Joints made with mechanical fasteners – General principles for the determination of strength and deformation characteristics*. CEN, Brussels, 1991.
- [16] N.L. Rahim, G.M. Raftery, P. Quenneville, “Stiffness of bolted timber connection”, presented at WCTE 2018 – World Conference on Timber Engineering, 2018.

Received: 28.05.2021, Revised: 10.08.2021