

This is a repository copy of *Bioethanol from autoclaved municipal solid waste : Assessment of environmental and financial viability under policy contexts*.

White Rose Research Online URL for this paper:
<https://eprints.whiterose.ac.uk/188848/>

Version: Accepted Version

Article:

Meng, Fanran, Dornau, Aritha, Mcqueen Mason, Simon J. orcid.org/0000-0002-6781-4768 et al. (3 more authors) (2021) Bioethanol from autoclaved municipal solid waste : Assessment of environmental and financial viability under policy contexts. *Applied Energy*. 117118. ISSN 1872-9118

<https://doi.org/10.1016/j.apenergy.2021.117118>

Reuse

This article is distributed under the terms of the Creative Commons Attribution-NonCommercial-NoDerivs (CC BY-NC-ND) licence. This licence only allows you to download this work and share it with others as long as you credit the authors, but you can't change the article in any way or use it commercially. More information and the full terms of the licence here: <https://creativecommons.org/licenses/>

Takedown

If you consider content in White Rose Research Online to be in breach of UK law, please notify us by emailing eprints@whiterose.ac.uk including the URL of the record and the reason for the withdrawal request.

1 Bioethanol from autoclaved municipal solid
2 waste: assessment of environmental and
3 financial viability under policy contexts

4 *Fanran Meng^{a,b}, Aritha Dornau^c, Simon J. McQueen Mason^c, Gavin H. Thomas^c, Alex*
5 *Conradie^b, Jon McKechnie^{b*}*

6 ^a Department of Engineering, University of Cambridge, Trumpington Street,
7 Cambridge CB2 1PZ, UK

8 ^b Sustainable Process Technologies, Faculty of Engineering, University of
9 Nottingham, Nottingham NG7 2RD, United Kingdom

10 ^c Centre for Novel Agricultural Products, Department of Biology, University of York,
11 York, YO10 5DD, United Kingdom

12 * Corresponding author. E-mail: jon.mckechnie@nottingham.ac.uk

13

1 **Abstract**

2 Globally, 2.01 billion tonnes of municipal solid waste (MSW) were generated in 2016,
3 about 37% of which was disposed of into landfills. This study evaluates the
4 environmental and financial viability of producing ethanol from autoclaved MSW via
5 fermentation. Experimental screening of four different microorganisms (i.e., *S.*
6 *cerevisiae*, *Z. mobilis*, *E. coli*, and *S. pombe*) and process modelling indicate that
7 MSW-derived ethanol can significantly reduce greenhouse gas emissions relative to
8 gasoline (84% reduction following EU Renewable Energy Directive accounting
9 methodology, and by 156% to 231% reduction following the US Energy Independence
10 and Security Act methodology). Utilisation of wastes for biofuel production in the UK
11 benefits from policy support and financial support for renewable fuels (Renewable
12 Transport Fuel Certificates). Financial analysis highlights that microorganisms
13 achieving higher ethanol yield and productivity (*S. cerevisiae* and *Z. mobilis*) can
14 achieve financial viability with higher cumulative net present value than *E. coli*, *S.*
15 *pombe*. However, the positive net present value can be achieved primarily due to the
16 benefit of gate fees received by diverting wastes to autoclave and ethanol production
17 (64% of total revenues), rather than from revenues from ethanol sales (7% of total
18 revenues). Key process improvements must be achieved to improve the financial
19 viability of ethanol production from MSW and deliver a clear advantage over waste
20 incineration, specifically improving hydrolysis yield, reducing enzyme loading rate and,
21 to a lesser extent, increasing solid loading rate. The results provide significant insights
22 into the role of policy and technology development to achieve viable waste-to-biofuel
23 systems.

24

25 **Keywords**

26 Municipal solid waste, Waste autoclaving, Fermentation, Incineration, Ethanol, Life
27 cycle assessment, Techno-economic analysis

28

29

30

31

32

33

1 Introduction

The development of biofuels from waste impacts significantly on current waste treatment within the context of a more circular economy, while also providing low carbon renewable fuels for transport sectors. Municipal solid waste (MSW) has been identified as a useful bioenergy source as it has a high organic content such as paper, card, garden, and food waste. There is potential for waste-derived fuels to simultaneously address the environmental impacts of conventional treatment processes, while providing biorenewable fuels that avoid land use implications of crop-based fuels. However, achieving financial viability can be challenging, due to the complex composition of wastes and presence of contaminants that may inhibit bioprocesses (enzymatic hydrolysis, fermentation). Comprehensive analyses of the environmental and financial performance of waste based biofuels are needed to better understand the waste-to-biofuel opportunity, to target technology development, and to inform the role for regulation in encouraging the uptake of viable waste-to-fuel technologies.

In the UK 14.6 million tonnes of MSW were landfilled in 2018 of which 49% (7.2million tonnes) was biodegradable material [1]. Globally, 2.01 billion tonnes of MSW was generated annually in 2016 and about 37% of waste is disposed of in some form of a landfill, only 8% of which is disposed of in sanitary landfills with landfill gas collection systems. Open dumping accounts for about 31 percent of waste, 19 percent is recovered through recycling and composting, and 11 percent is incinerated for final disposal [2]. Landfill and incineration are the least desirable steps in circular waste management as they contribute significantly to greenhouse gas (GHG) emissions and environmental pollution, while recovering minimal value from wastes. It was estimated that 1.6 billion tonnes of carbon dioxide equivalents (CO₂eq) were generated from solid waste treatment and disposal in 2016, or 5% of global emissions and is expected to increase to 2.38 billion tonnes of CO₂eq per year by 2050 if no efficiencies are introduced in this sector [2].

In 2014, global GHG emission was over 36 billion tonnes CO₂eq per year while about 20% of global emissions were the result of transportation [3]. The EU's climate change targets have already stated transport emissions must be cut by 60% by 2050 compared with 1990 levels [4]. The EU Renewable Energy Directive (RED) requires that renewable energy content should account for at least 10% of the energy used in transportation by 2020, increasing to 32% renewable energy share by 2030 under the revised RED II directive [5], which can be achieved through the use of biofuels. The overall production of biofuels in the EU has increased dramatically since the turn of the century, growing from 722,000 to 15.7 million metric tonnes of oil equivalent in 2018, largely from food crops [6]. In the US, total renewable fuel production was 26 billion gallons (~80 million metric tonnes of oil equivalent) in 2018. The EU RED II regulates that renewable biofuels must achieve a 60% life cycle GHG emission reduction compared to fossil fuel [7]. Similarly, the US Energy Independence and Security Act of 2007 (EISA) requires biofuels to achieve a life cycle GHG reduction threshold as compared to a 2005 petroleum baseline for different types of biofuels (e.g., 60% reduction for cellulosic biofuel), thereby boosting the long-term goal towards 36 billion US gallons of renewable fuel by 2022 [8]. In the UK, the Renewable Transport Fuel Obligation specifically provides a stricter limitation on crop-based fuels, incentivising waste-based fuels from classes of waste residue waste by awarding

1 double Renewable Transport Fuel Certificates (RTFC) per litre of liquid renewable
2 fuels. These credits are tradeable and have a market value of £0.12 to £0.22 per RTFC,
3 thus financially supporting biofuels production from waste [9].

4 Since the introduction of the RED quotas [5], concerns continue to rise about the
5 impact of biofuels upon world food prices, tropical deforestation and biodiversity. The
6 EU Fuel Quality Directive [10] restricts biofuel production from feedstocks grown on
7 virgin land or land with high carbon stocks. Second generation biofuels using non-food
8 feedstocks, agricultural wastes thus address concerns associated with first generation
9 biofuels related to food security, climate change, non-renewable energy use, air
10 pollutant emissions, energy security, and land use change [11]. Due to the high
11 lignocellulosic content of MSW, it has considerable potential as a renewable biomass
12 feedstock for biofuel production as it is abundant, low cost and does not compete with
13 agricultural production or purposely collected for biofuel production [12]. Furthermore,
14 producing biofuels from waste may offer advantages over current disposal techniques
15 (composting, anaerobic digestion, refuse derived fuel, incineration and landfilling) by
16 addressing environmental concerns with some current methods while producing a
17 valuable output [13].

18 Autoclaving is a process by which high pressure and steam are used to sterilise
19 organic and/or inorganic materials. It is a commercially proven method for the
20 separation of a heterogeneous MSW stream into several component parts: converting
21 the biogenic content of MSW to a biofibre material and enabling the recovery of
22 sterilized metal, glass, and plastic materials[14]. Autoclave conditions also act as a
23 mild hydrothermal pre-treatment for lignocellulosic material, increasing cellulose
24 accessibility for sugar production by enzymes while producing fewer inhibitory
25 compounds compared to other, harsher pre-treatments [15]. Several researchers have
26 studied the production of biofuels from the organic content of MSW produced through
27 autoclaving [12, 13, 16-18]. Compared to other lignocellulosic feedstocks such as
28 agricultural by-products, the organic fraction of MSW from autoclaving is typically
29 highly variable and heterogeneous in composition. The organic fraction contains
30 contaminants such as metals and other pollutants at levels that could potentially be
31 inhibitory to enzymes and/or fermentative microorganisms. Developing a viable
32 fermentation process for conversion of autoclave pretreated MSW therefore requires
33 a robust microorganism that has an intrinsic ability to ferment this complex feedstock
34 [13].

35 Life cycle assessment (LCA) has been widely used as a tool to examine environmental
36 implications of lignocellulosic biofuel production in the past decades. LCA allows
37 potential impacts to be identified at an early stage of process design, providing the
38 opportunity for decision making and improved process sustainability before scaling up
39 or commercialisation. Previous LCA studies have been widely reported in the literature
40 for bioethanol production from various feedstocks including corn stover, wheat straw,
41 poplar, eucalyptus and waste paper amongst others [19-24]. These studies suggest
42 that the use of lignocellulosic material will lead to a range of reductions in GHG
43 emissions (46-90% compared to conventional gasoline) compared to first generation
44 production using food crop feedstocks [20].

1 The selection of feedstocks or design of the production process must consider both
2 environmental and social criteria, in addition to capital and operational costs for
3 economic feasibility [25]. The National Renewable Energy Laboratory (NREL)
4 conducted a techno-economic analysis for lignocellulosic ethanol production and
5 reported a minimum selling price (MSP) of ethanol of 2.15 US\$/gal [26]. Similarly,
6 previous techno-economic analyses have primarily compared the process designs,
7 evaluated the potential to reduce the production cost and determined the MSP of
8 ethanol [27-29]. Results of these techno-economic models vary significantly from one
9 another although the same process technology methods and feedstock are taken into
10 account [30]. Few techno-economic studies have focused on waste to biofuel for
11 investment analysis, taking into account predicted biofuel prices whilst simultaneously
12 considering life cycle environmental implications. This study performs a
13 comprehensive investment analysis of autoclaved waste to ethanol conversion,
14 considering relevant financial incentives provided to waste-derived fuel production
15 and GHG emission accounting methods in life cycle analysis.

16 The study develops systematic models to comprehensively understand the technical,
17 environmental and financial impacts of bioethanol production from autoclave pre-
18 treated MSW and evaluate four microorganisms (i.e., *Saccharomyces cerevisiae*,
19 *Zymomonas mobilis*, *Escherichia coli*, *Schizosaccharomyces pombe*) previously
20 reported by Dornau, Robson [13] to robustly grow on this complex feedstock and
21 produce bioethanol. The overall environmental impacts (i.e., primary energy demand
22 and GHG emission) and investment case using net present value (NPV) are evaluated
23 across the integrated unit operations, including autoclave, hydrolysis, fermentation,
24 and distillation sited in the UK. The study follows current UK, EU and US renewable
25 fuel policies within the context of sustainability frameworks by considering alternative
26 system boundaries, allocation approaches, waste disposal gate fees and renewable
27 fuel incentives, providing a global perspective on the viability of ethanol production
28 from MSW via autoclave pretreatment. The results are then integrated to meaningfully
29 inform the investment case for waste-to-biofuel systems.

30 **2 Methods**

31 The study assesses the current and future viability of bioprocessing of municipal solid
32 waste feedstock pretreated by autoclaving to ethanol. Four fermentative
33 microorganisms are screened (i.e., *S. cerevisiae* ATCC200062, *Z. mobilis* DSM424,
34 *E. coli* LW06, *S. pombe* JB953), based on experimental results. The overall
35 environmental and cost implications of converting MSW to ethanol using four
36 fermentative microorganisms are compared via LCA and techno-economic analysis
37 based on process simulation of operation at commercially relevant scale. We consider
38 three different techno-economic scenarios: Base case (based on current experimental
39 evidence); Process Improved case (with anticipated process improvements (solid
40 loading rate, hydrolysis yield, fermentation productivity, and enzyme loading); and
41 Best Case (with anticipated process improvements and favourable market conditions
42 (gate fees; product markets)).

43 **2.1 Waste Composition**

44 The study utilised a synthetic feedstock representative of UK MSW with the following
45 wet composition by mass: paper and cardboard (22%), food waste (17%), wood
46 (8.7%), plastic (22%), glass (1%), garden waste (3%), metals (4%), textiles (6.6%) and

1 others (15.7%). This was adjusted by removing the “Carpet, underlay and furniture”
 2 and “Bricks, plaster and soil” as reported by Defra Digest of waste and resource
 3 statistics, 2018 edition [31] based on most recent experimental data done by Wilson
 4 BioChemicals.

5 2.2 Autoclave Pre-treatment

6 The MSW feedstock was subjected to autoclave pre-treatment in a pilot-scale Wilson
 7 System®[32]. This involved autoclaving with dry steam at 160°C and 72 psig for 45
 8 minutes in a baffled vessel rotating at 4 rpm. The pre-treated material was segregated
 9 into organic and inorganic fractions using manual sorting and sieving. The organic
 10 fibre fraction was homogenized and stored in ~1 kg bags at -20°C. This study assumes
 11 a plant capacity of 150,000 tonne MSW/yr based on two 20 tonne batch size. Previous
 12 studies [33] by the collaborating autoclave technology developer (Wilson Bio-chemical
 13 Ltd) had confirmed that autoclaved biofibre generated using a 50 L vessel was
 14 representative of full commercial scale. This study is based on this pilot scale,
 15 generating commercially representative data suitable for engineering design and
 16 scale-up. The pilot plant operation determined the process input requirements of 43
 17 MJ electricity, 274 MJ natural gas and water consumption of 245 L per tonne of MSW.
 18 As in Figure 1, two routes are considered to utilise autoclaved fibre: bioethanol
 19 production; or energy recovery in an offsite incineration plant.

20

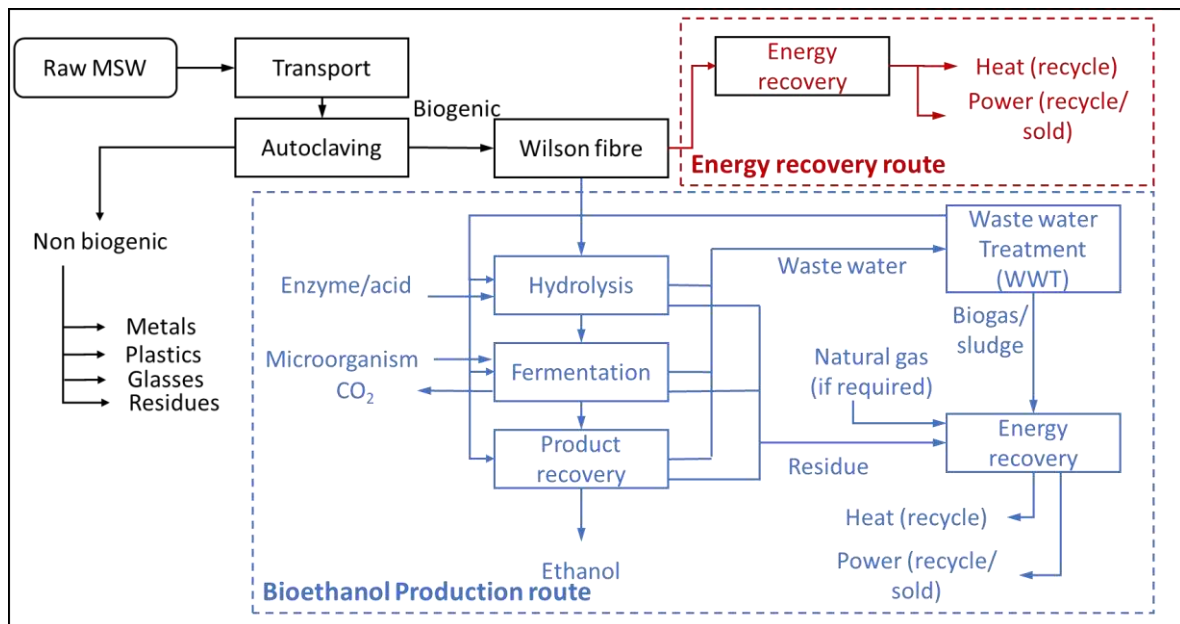

21

22

Figure 1 Overall diagram for MSW to ethanol/energy conversion.

23 2.3 Bioethanol Production from Autoclaved MSW

24 For bioethanol production, the autoclaved fibre is transferred to hydrolysis and
 25 fermentation for conversion. After product recovery, the main product ethanol is
 26 obtained while the wastewater is sent to treatment and residual biomass for energy
 27 recovery.

1 **2.3.1 Enzymatic Hydrolysis**

2 Samples of the MSW fibre were milled to a consistent particle size (0.5mm) and then
3 loaded into the hydrolysis vessel, where the sample was diluted with water from the
4 mains water tank into a dilute slurry (20wt% solids content). At this stage, adjustments
5 may also be made to process conditions such as pH adjustment to 5 with concentrated
6 H₂SO₄, which was the optimum for enzyme activity. The slurry was then dosed with
7 an enzyme cocktail Cellic Ctec2 (Novozymes) solution (5% wt/wt enzymes to total
8 available sugars) (15–60 filter paper units (FPU) per gram cellulase). Hydrolysis was
9 carried out for 48 hours at 50°C. The resulting slurry was centrifuged (4000 x g, 15
10 mins) to separate the hydrolysate from un-hydrolysed solids. This method gave a
11 monosaccharide content as follows: glucose (40-45wt%), xylose (4-5wt%), galactose
12 (0.7wt%) and arabinose (2.9wt%), where glucose is derived from cellulose and the
13 other three monosaccharides are derived from hemicellulose [34].

14 **2.3.2 Fermentation experiments**

15 Dornau et al. [13] reports the detailed fermentative performance of the four
16 microorganisms. Briefly: Each microorganism was cultivated in a fermentation medium
17 consisting of 9.4 ml of filter sterilised MSW fibre hydrolysate supplemented with 1%
18 w/v vitamin enriched yeast extract (Sigma) (to provide nutrients) and 40 mM MOPS
19 buffer to a final volume of 10 ml. The fermentation medium was transferred to sterile
20 conical flasks or serum bottles. Fermentations with *S. pombe*, *S. cerevisiae* and *E. coli*
21 were carried out in conical flasks (100 ml) sealed with airlocks to promote microaerobic
22 conditions. Fermentations with *Z. mobilis* were carried out under fully anaerobic
23 conditions in serum bottles (100 ml). Preparing the inoculum, overnight cultures of
24 each species were harvested in mid-exponential phase and re-suspended in
25 fermentation medium to give a starting optical density (OD₆₀₀) of 0.05. Fermentation
26 cultures were incubated at each species' optimal temperature with shaking at 160 rpm.
27 Samples were taken at regular intervals over 48 hours and used to measure OD₆₀₀,
28 sugar and ethanol concentration and final cell dry weight according to standard
29 methods. Key fermentation yield parameters for each species (i.e., *S. cerevisiae*
30 ATCC200062, *Z. mobilis* DSM424, *E. coli* LW06, *S. pombe* JB953) cultivated in MSW
31 fibre hydrolysate were reported in our previous work [13].

32 **2.3.3 Distillation**

33 Ethanol and water form a minimum boiling azeotrope, preventing purification via
34 simple distillation to a pure ethanol product. Pressure swing distillation using acetone
35 as an entrainer was employed to circumvent the azeotropic point, heat integrated to
36 reduce the overall energy consumption as in Figure 2. Given the minimum boiling
37 azeotrope, a pre-flash column concentrated the ethanol in the distillate as feed to the
38 pressure swing distillation, where the high- and low-pressure columns were heat
39 integrated through a combined reboiler condenser. The separations network outlined
40 in Figure 2 was rigorously simulated in Aspen HYSYS® v11.

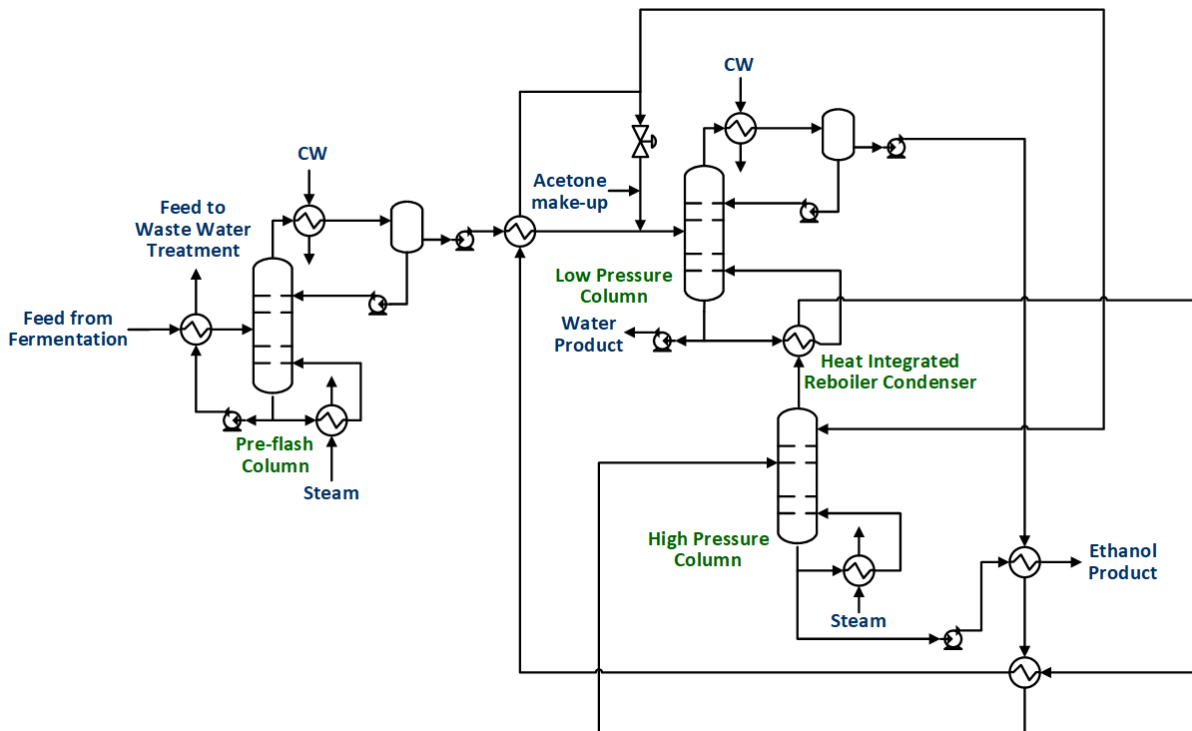

1

2 Figure 2 Pressure swing distillation of ethanol and water using acetone as entrainer,
 3 heat integrated for energy efficiency.

4 **2.4 Life cycle assessment**

5 **2.4.1 Scope and Functional Unit**

6 This study developed an LCA model of MSW-derived ethanol following the ISO
 7 Standards 14040 and 14044 [35, 36]. The LCA was undertaken in GaBi 9.2 (2019)
 8 using Ecoinvent 3.6 inventory databases supplemented from literature data and
 9 available pilot plant operation. Two environmental impacts are quantified: primary
 10 energy demand (PED) and (GHG) emissions, reported in MJ and gram CO₂
 11 equivalents (gCO₂eq.) based on the most recent IPCC 100-year global warming
 12 potential [37] respectively. The functional unit is defined as one MJ of ethanol, denoted
 13 as MJ_{ethanol}. When considering waste management, i.e., comparing bioethanol
 14 production to landfill/incineration, results are also considered on the basis of 1 tonne
 15 of treated MSW. The system boundaries start from the sorting and transportation of
 16 MSW. Prior energy use and environmental burdens of the processes and products
 17 that generated MSW are excluded in this study. Alternative LCA frameworks are used
 18 to compare accounting methodologies dictated by biofuel policies in EU and US[7, 8].
 19 The study employs energy allocation following current EU RED II policy to allocate co-
 20 products benefits [7]: excluding avoided waste treatment, exergy allocation of
 21 electricity and heat co-products (see Table S1 and Figure S1), and all other coproducts
 22 evaluated by energy allocation. The study also considers the system expansion
 23 method following US EISA/California LCFS policies: including avoided waste
 24 treatment processes (credit to primary ethanol product) and all co-products evaluated
 25 using system expansion (credit to primary ethanol product) [38].

1 2.4.2 Life Cycle Inventory

2 Inventory data was produced by adapting process models as developed for butanol
3 and ethanol production previously [34] and supplemented from the Ecoinvent
4 database and available literature data. The mass and energy balance data come from
5 the process simulation model described in 2.3. The study assumes that the inventory
6 data for the production of the inoculums of *S. cerevisiae*, *E. coli*, *S. pombe* would be
7 similar to that of *Z. mobilis* [26, 39]. Inventory data of nutrients were obtained from
8 publicly available data [40, 41] and GREET® Model developed by US Argonne
9 National Laboratory [42]. The GHG emissions assigned to enzyme production in this
10 study are 5.9 g CO₂eq/g of produced enzyme (commercially Novozymes Cellic CTec2)
11 [43], while studies investigating onsite enzyme production using cellulose as a
12 feedstock have been reported to emit 4.1–11.5 g CO₂eq/g cellulase [44, 45].

13 2.5 Financial Analysis

14 2.5.1 Capital and Operational Expenses

15 The study considers a plant capacity of 150,000 tonne MSW/yr operating 8000 hours
16 per year. All major equipment items are designed (e.g., each fermenter has a fixed
17 volume of 400 m³) and costed based on the material and energy flows from the model
18 described in Section 2.1 using the factor method [46, 47]. Costs are then extrapolated
19 to those of year 2019 based on the Chemical Engineering Plant Cost Index [48] as in
20 equation 1:

$$C_{p,v,2018} = C_{p,u,r} \left(\frac{v}{u}\right)^n \left(\frac{I_{2019}}{I_r}\right) \quad (1)$$

21 where $C_{p,v,2019}$ is the equipment purchase cost (free on board) with capacity v in the
22 year of 2019, $C_{p,u,r}$ is the reference equipment cost at capacity u in year r , I_{2019} is cost
23 index in the year of 2019 (= 607.5), I_r is cost index in year r . An exponent scaling factor
24 (n) of 0.6 is assumed. Due to economies of scale, the plant capital cost (CAPEX) per
25 unit output decreases with increasing capacity. Similarly, for the same amount of
26 feedstock input capacity, productivity and product yield influence CAPEX due to
27 economies of scale.

28 The annual operating cost of the process is calculated as the sum of operating costs
29 (OPEX) (labour, utility and chemical costs), plant overheads and maintenance cost
30 (see Table 1). For the bioethanol production route, the fermentation turn-around time
31 is 12 hours for all microorganisms while the batch cycle time differs amongst
32 microorganisms: 36 hours for *S. cerevisiae* and *Z. mobilis*, 60 hours for *E. coli* and *S.*
33 *pombe*, respectively [13]. Variable operational costs including materials and utilities
34 are obtained from mass and energy balance model and publicly available data where
35 appropriate. Enzyme (Novozymes Cellic CTec2/CTec3) used in this study has an
36 indicative cost of 3-5 Euro/kg (3.4-5.7 \$/kg) [49].

1

Table 1 Summary of the cost model input data.

Input Parameter	Value	Unit	
<i>Fixed capital cost</i>			
OSBL	25%	[% compounded to erected cost]	
Installed Cost ISBL Lang factor	3.2	[-]	
Location factor	1.2	[-]	
Commissioning Cost	5%	[% FCI]	
Working Capital	10%	[% FCI]	
<i>Fixed Operating Cost</i>			
Labour & Supervision	Salary [\$] (2019)	Number	Cost [\$]
Plant manager	154,460	1	154,460
Plant engineer	73,552	2	147,105
Maintenance supervisor	59,892	1	59,892
Maintenance technician	42,030	12	504,356
Lab manager	58,842	1	58,842
Lab technician	42,030	2	84,059
Shift supervisor	50,436	4	201,745
Shift operators	42,030	20	840,593
Yard employees	29,421	4	117,686
Clerks and secretaries	37,827	3	113,481
Total salaries			2,282,219
Labour burden	90 [%] of Total Salaries		2,053,997
Total labor cost			4,336,215
Other overhead			Annual cost [\$]
Maintenance	3 [%] of ISBL		2,090,429
Property insurance	0.7 [%] of FCI		573,201
Total fixed operating cost			6,999,845

2

3 2.5.2 Ethanol Selling Price

4 Time series analysis was used to forecast the long-term average price of ethanol.
5 Takens' theorem was used as the basis for this analysis [50]. Takens' theorem states
6 that for a deterministic system, the underlying state variables that created the time
7 series are embedded within the data. Using this theorem; a deterministic, dynamic
8 system can be reconstructed based on the observed time series. Such a forecast
9 model, constructed using only the embedded state variables, assumes that the market
10 drivers underpinning the trajectory of the state variables in phase space remain largely
11 unchanged. Particularly, policy frameworks and market forces are assumed to remain
12 largely unchanged over the forecast period. An embedding dimension of ten was used
13 to reconstruct the ethanol price model from weekly spot price data obtained from
14 publicly available daily price history between 2012 and 2018 [51]. In this work, a Radial
15 Basis Function Neural Network (RBFNN) containing 8 neurons was used as a model

1 to predict the future ethanol price [52, 53]. The RBFNN was trained as a one step
 2 ahead predictor by minimising the mean squared error of the difference between the
 3 actual and predicted prices. Once trained, the RBFNN was evaluated (tested) in free
 4 run mode, where successive predicted prices (outputs) become inputs to the RBFNN.
 5 The confidence limits corresponding to the trained RBFNN were calculated as a
 6 reliability measure of the prediction Leonard, Kramer [53]. In addition to the forecast
 7 long-term average ethanol price, the study considers sensitivity of results by
 8 considering the minimum and maximum ethanol price within the dataset (2012 to
 9 2018).

10 2.5.3 Investment Analysis

11 All sources of cost and income must be determined to inform an investment analysis.
 12 This study used a discounted cash flow analysis, where capital and operational costs
 13 are discounted and totalled to a cumulative NPV to determine the most cost-effective
 14 option among different alternatives.

$$NPV = \sum_{t=0}^{20} \frac{I_t - C_t}{(1+i)^t} \quad (2)$$

15 where total sources of income $I_t = I_{ethanol} + I_{electricity} + I_{by-products} + I_{RTFC} + I_{gate\ fee}$, sources
 16 of incomes are shown in Table 2; total sources of cost $C_t = CAPEX + OPEX$, we
 17 assume an 8% of discounted rate (i) of return for a plant life of 20 years (t). We consider
 18 a corporation tax rate of 20% and depreciation of 10 years.

19 Table 2 Sources of incomes for ethanol and incineration plant.

Sources of income	Price	Unit	Ref
Recovered metals	0.25	£/kg	[54]
	0.33	\$/kg	
Recovered plastic	0.01	£/kg	[54]
	0.013	\$/kg	
Landfill gate fee with tax	113.00	£/tonne	[55]
	147.53	\$/tonne	
Autoclave gate fee	85.00 (80.00-90.00)	£/tonne	[56]
	110.98	\$/tonne	
Autoclave fibre waste	20.00	£/tonne	[56]
	26.11	\$/tonne	
RTFC (Renewable Transport Fuel Certificates)	£0.18	£0.12-0.22 per RTFC	[9]
	\$0.24	\$0.17-0.32	
Ethanol	See section 2.5.2		Time series analysis model
Electricity wholesale	£0.0748	£/MJ	[57]
	\$0.027	\$/MJ	

1

2 **3 Results and Discussion**

3 **3.1 Material and Energy Balance**

4 The overall input to the process was 150,000 tonne MSW per annum, of which 31.8wt%
5 was dry convertible lignocellulosic content (53wt% wet). Glucose and xylose content
6 of the input waste stream was measured experimentally as 14.3wt% and 1.6wt%.
7 Given a hydrolysis yield of 38% for glucose and 70% for xylose [34], total sugar
8 production of 971 kg/hr glucose and 198 kg/hr xylose was achieved. Optimisation of
9 the hydrolysis process may achieve higher sugar yields, which would proportionally
10 increase the downstream output of ethanol. The implications of achieving hydrolysis
11 yields as high as 85% is considered in Section 3.3.

12 As reported previously [13], ethanol yield from sugar varies significantly between the
13 considered microorganisms, with *S. cerevisiae* and *Z. mobilis* achieving relatively high
14 yields (70wt% of theoretical) compared to *S. pombe* (51wt% of theoretical) and *E. coli*
15 (34wt% of theoretical). These yields are within the range of previous published results,
16 ranging from 44% to 74% of theoretical ethanol yield [58, 59], but lower than ethanol
17 yield from sugar derived from agricultural feedstocks (e.g., 90wt% from corn stover
18 sugars [26]). Overall, ethanol production from MSW is approximately 22 kg ethanol/wet
19 tonne MSW for the highest yielding microorganisms, *S. cerevisiae* and *Z. mobilis*. This
20 is significantly lower than previous reported results, which range from ~70 to 160 kg
21 ethanol/wet tonne MSW [58-60]. The low ethanol yield in the current study arises due
22 to the relatively low hydrolysis sugar yield (38wt%), and the low lignocellulosic content
23 of the MSW feedstock (53wt% in current study vs 79wt% to 100wt% in comparator
24 studies as above). The difference may be also due to the geographical variations, i.e.,
25 UK MSW in this study versus US MSW as reported in the above literatures.

26 Total energy yield from MSW, including ethanol and co-product electricity, ranges from
27 14% to 16% of energy content of the input MSW. Including excess co-generated heat
28 would increase the energy yield to ~24%, if useful applications can be found (e.g., co-
29 location with an industrial process/district heating, for sterilization, or for cooling
30 generation) (Table 3). Ethanol represents a small share of the energy outputs of the
31 system, ranging from a maximum of 4.5% of the energy content of MSW for *S.*
32 *cerevisiae* and *Z. mobilis*, to 2.2% for *E. coli*. In contrast, much higher overall energy
33 yield of ethanol production from corn stover is reported at 47% [26], of which ethanol
34 comprises 92%.

35

1 Table 3 Overall mass and energy balance of ethanol fermentation production from
 2 MSW.

	<i>S. cerevisiae</i>		<i>Z. mobilis</i>		<i>E. coli</i>		<i>S. pombe</i>	
Inputs	Tonne/y	Value	Tonne/y	Value	Tonne/y	Value	Tonne/y	Value
	r	MW	r	MW	r	MW	r	MW
MSW (40% moisture)*	150000	64.6	150000	64.6	150000	64.6	150000	64.6
Total input		64.6		64.6		64.6		64.6
Outputs								
Ethanol	3277	2.9	3218	2.9	1592	1.4	2393	2.1
Recycled plastics	13830		13830		13830		13830	
Recycled metals								
Total heat generation		10.3		10.3		10.5		10.4
Total electricity generation		8.9		8.9		9.1		9.0
Total output		22.1		22.1		21.1		21.6
Total heat demand		4.7		4.7		4.7		4.7
<i>Autoclave+Biorefinery</i>		4.7		4.7		4.7		4.7
Total electricity demand		1.7		1.7		1.7		1.7
<i>Autoclave+Biorefinery</i>		0.5		0.5		0.5		0.5
Net heat surplus		5.5		5.6		5.8		5.7
Net electricity surplus		7.2		7.3		7.5		7.4
Energy efficiency (main product - net electricity surplus)		15.7%		15.7%		13.8%		14.7%
Energy efficiency (main product - net electricity surplus)-Ethanol from cron stover (Humbird et al., 2011)		47.0%		47.0%		47.0%		47.0%

3

4 3.2 Life Cycle Assessment

5 3.2.1 Greenhouse Gas Emissions Evaluated Under Current Policies

6 The assessment of GHG emissions for ethanol production from MSW varies
 7 substantially between assessment methodologies mandated by EU and US policies
 8 (Figure 3) (the results of PED can be found in Figure S2). However, in all cases, low
 9 GHG emissions can be achieved compared to conventional fuels and emissions
 10 reduction requirements can be met. Employing the EU RED II methodology (Figure
 11 3a), biorefinery emissions are allocated between ethanol and co-product electricity.
 12 Overall GHG emissions are nearly identical for all microorganisms (~15 gCO₂eq./MJ
 13 or 84% GHG emissions reduction relative to gasoline) due to the allocation approach.
 14 Dependent on higher or lower ethanol yields, a proportional share of emissions
 15 associated with waste collection and biorefinery operations is allocated to ethanol.
 16 Ethanol production thus achieves classification as a renewable biofuel by exceeding
 17 the emissions target of at least 50% lower than that of the fossil fuel they replace (pre
 18 January 2018 installations) and 60% (installations from January 2018) [10].

1 When employing the system expansion method as in US EISA and CA LCFS policies,
2 it is noted that the system under all microorganisms cases show large reductions in
3 GHG emissions, but this result depends on microorganism-specific ethanol yield
4 (Figure 3b). Net GHG emissions range from -53 to -124 gCO₂eq./MJ ethanol (including
5 co-products credits of excess electricity and recyclable materials, but excluding
6 avoided waste treatment), reductions of 156% to 231% relative to gasoline. As
7 reported previously (e.g., [61]), lower ethanol yield (i.e., lower denominator in the
8 calculation) results in the greatest reduction in GHG emissions due to higher output of
9 co-products per unit of ethanol produced. Inclusion of avoided waste treatment results
10 in substantially negative net GHG emissions, due to diversion of biogenic wastes from
11 landfill and of plastics from incineration. The study assumes that incoming MSW would
12 otherwise be treated by incineration (71%) and landfilling (29%), based on current
13 practices in UK [62]. Therefore, diverting MSW from current waste treatment
14 contributes to reducing GHG emissions for the waste to ethanol process. On the basis
15 of per MJ ethanol, MSW-derived ethanol remains carbon negative for all four strains
16 with landfill/incineration avoidance (-544.8 to -1136.7 kg CO₂eq/MJethanol or 680% to
17 1309% GHG reduction relative to gasoline).

18 Primary due to the lower ethanol yield as stated above, LCA results are lower
19 compared with previous reported GHG emissions of ethanol production from MSW,
20 ranging from 35 to 68 gCO₂eq./MJ ethanol when using the system expansion
21 approach and excluding avoided waste treatment (see Figure S3) [58-60, 63]. LCA
22 results are not directly comparable between studies, due to differences in study
23 methodology (e.g., system boundaries; co-product considerations; treatment of
24 residual wastes) and data/assumptions (waste composition; enzyme production
25 impacts and enzyme loading; product yields) but provide a reasonable point of
26 comparison. Generally, MSW derived liquid biofuels have smaller GHG emissions
27 than ethanol produced from corn and sugarcane [23], primarily due to the credits from
28 a diverse range of material and energy co-products even with the exclusion of credits
29 from avoided waste treatment.

30 The LCA results presented here are specific to the UK context. With the system
31 expansion approach, mandated by US policies, GHG emissions results are sensitive
32 to 1) the electricity grid mix, as co-product electricity generates a “credit” by displacing
33 grid generation; 2) the current waste treatment mix, as avoiding conventional
34 treatment also generates a GHG emissions “credit”. In locations with a more GHG-
35 intensive electricity mix, or a larger share of waste currently destined to landfill, the
36 GHG emissions benefits of producing ethanol would be greater than the results here
37 indicate. In contrast, results based on the allocation-based approach required by EU
38 policy are independent of these factors, and so results are likely to be broadly similar
39 in different locations.

40

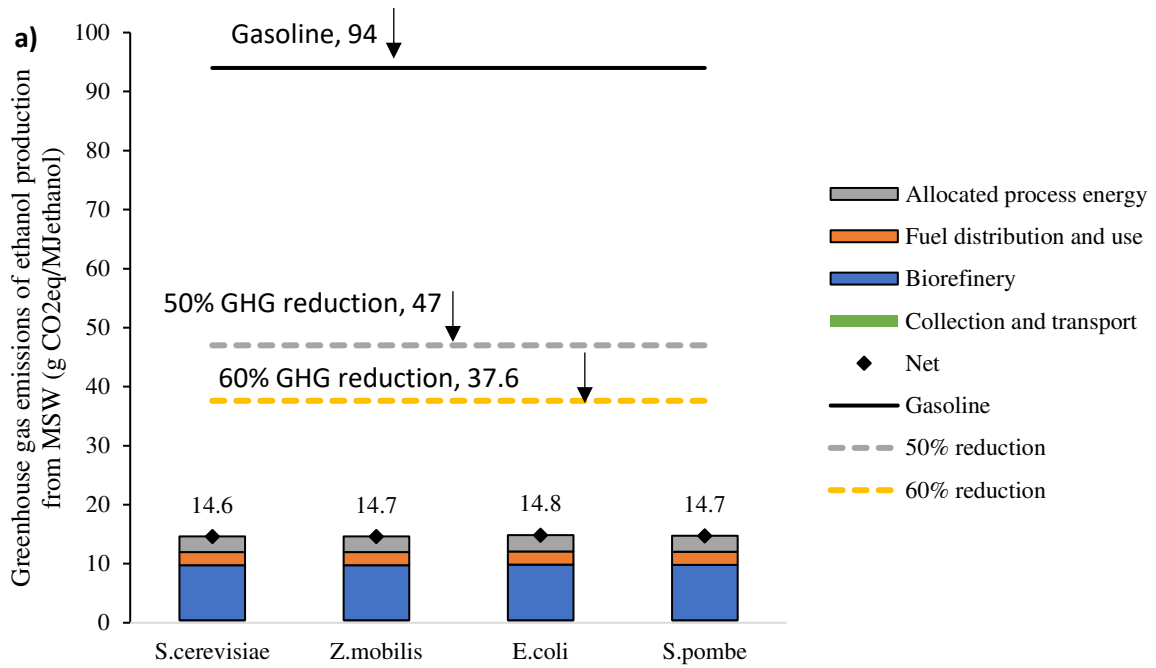

1

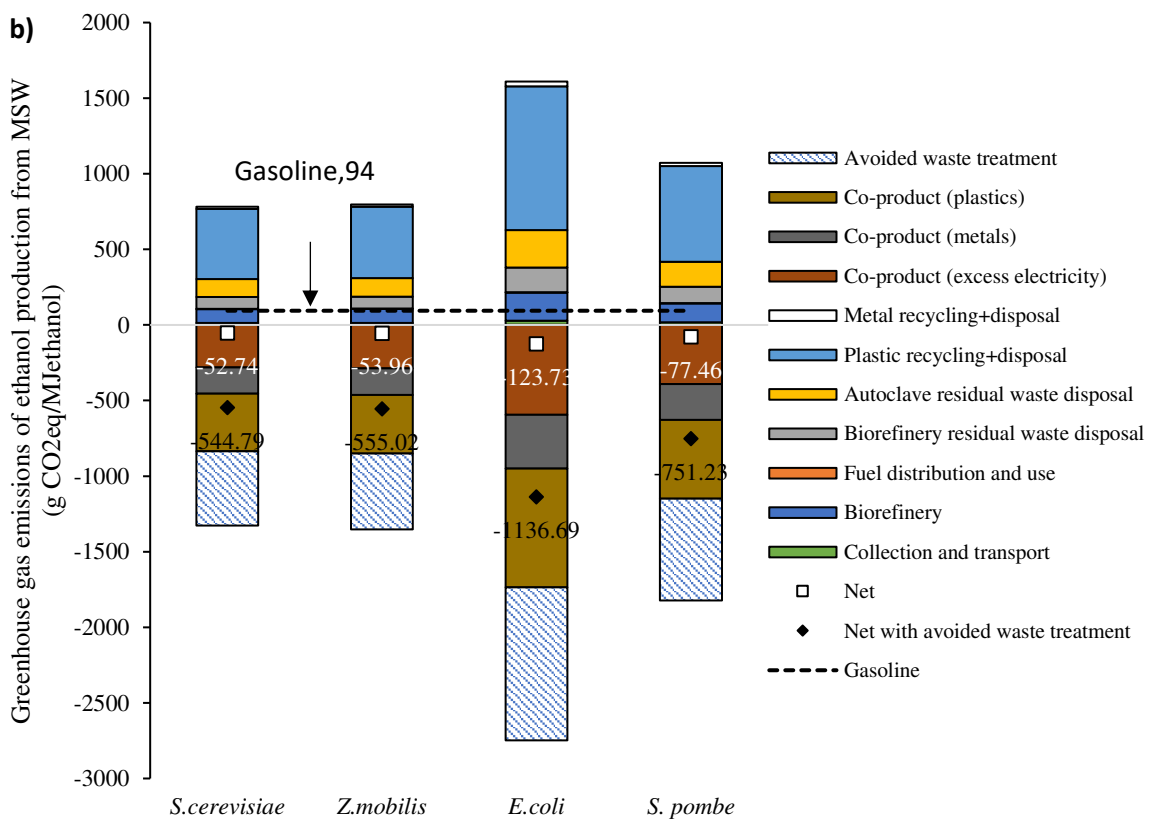

2

3 Figure 3 Life cycle greenhouse gas emissions associated with ethanol production
 4 from municipal solid waste under a) allocation method employed in EU RED
 5 methodology, and b) system expansion method based on US EISA/CA LCFS policy.

6

1 3.3 Financial Analysis

2 3.3.1 Costs of Bioethanol Production

3 Biorefinery CAPEX (~£53 million (~\$70 million)) and OPEX (~£7.6 million (~\$9.9
4 million)) is similar for all microorganisms considered (Figures 4 and 5, respectively),
5 despite significant differences in fermenter equipment size and cost. Fermenter
6 CAPEX is highly dependent on the volumetric productivity of the microorganisms, but
7 accounts for only ~2% of total CAPEX and so has minimal overall impact. Installed
8 Fermenter costs range from £0.7 million (\$0.92 million) to £1.4 million (\$1.84 million),
9 for 36 hour batch cycle time (*S. cerevisiae* and *Z. mobilis*) and 60 hour batch cycle
10 time (*E. coli* and *S. pombe*). Product yield has a minor influence (2% to 3%) on
11 wastewater treatment CAPEX, as higher ethanol yields correspond to lower residual
12 microbial biomass. Equipment costs for processes common to all microorganism
13 scenarios dominate the CAPEX: the autoclave alone accounts for ~36% of CAPEX;
14 energy recovery 27%; and distillation 16%.

15

S. cerevisiae

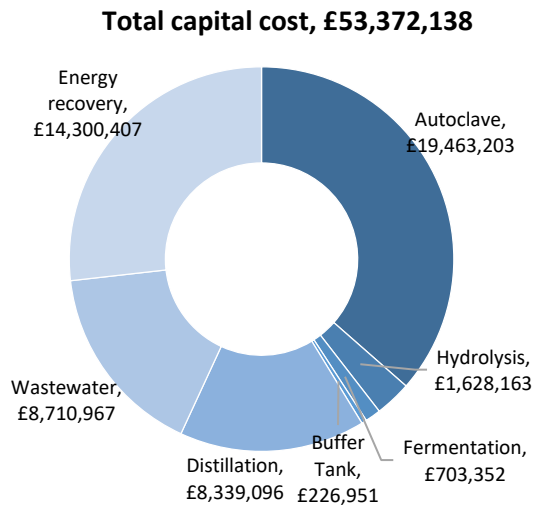

Z. mobilis

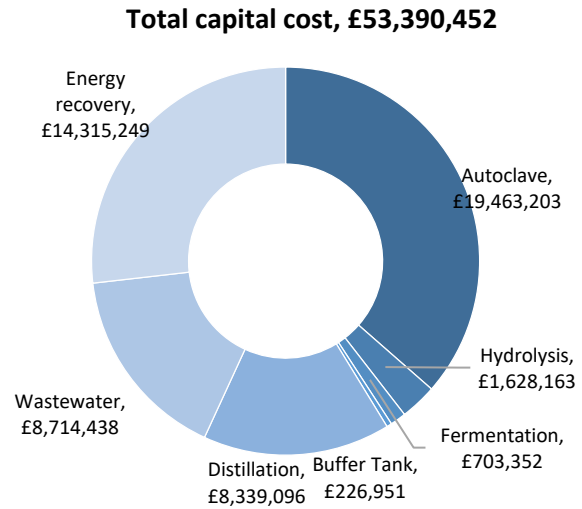

E. coli

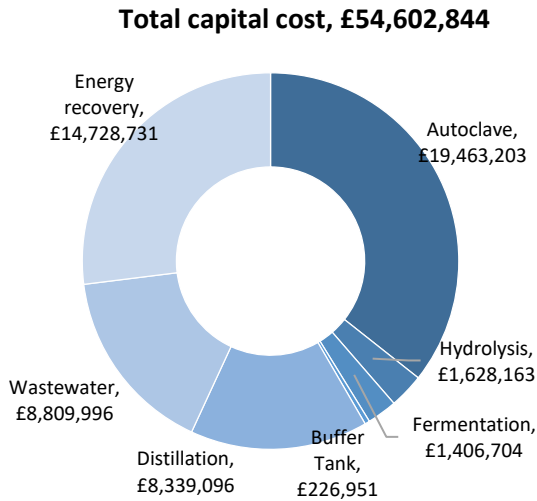

S. pombe

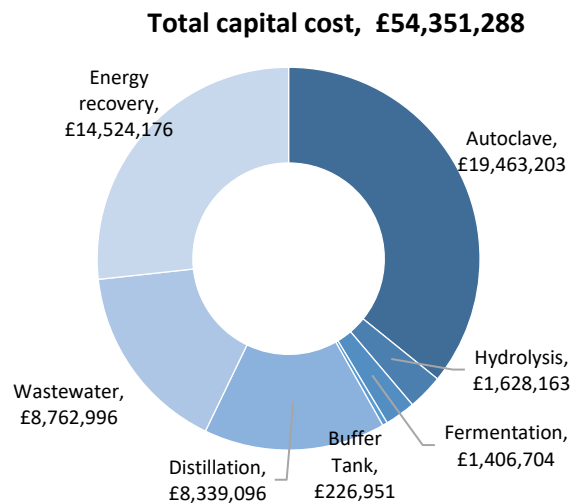

1 Figure 4 Fixed capital cost of MSW to ethanol using four different microorganisms-
2 *S. cerevisiae*, *Z. mobilis*, *E. coli*, *S. pombe*.

3 Fixed operating costs comprise approximately 54% of OPEX; of this total, labour costs
4 are common for all scenarios, while maintenance, property taxes, and insurance are
5 proportional to CAPEX and so little changed. Most variable OPEX items are common
6 to all microorganisms, with enzyme costs for hydrolysis representing 96% of the total.
7 The sensitivity of the financial analysis to enzyme costs is considered in Section 3.4.4.
8 Nutrient requirements are dependent on the generation of microbial biomass, and so
9 are higher for lower ethanol yielding microorganisms, but this difference does not
10 substantially influence overall operating costs.

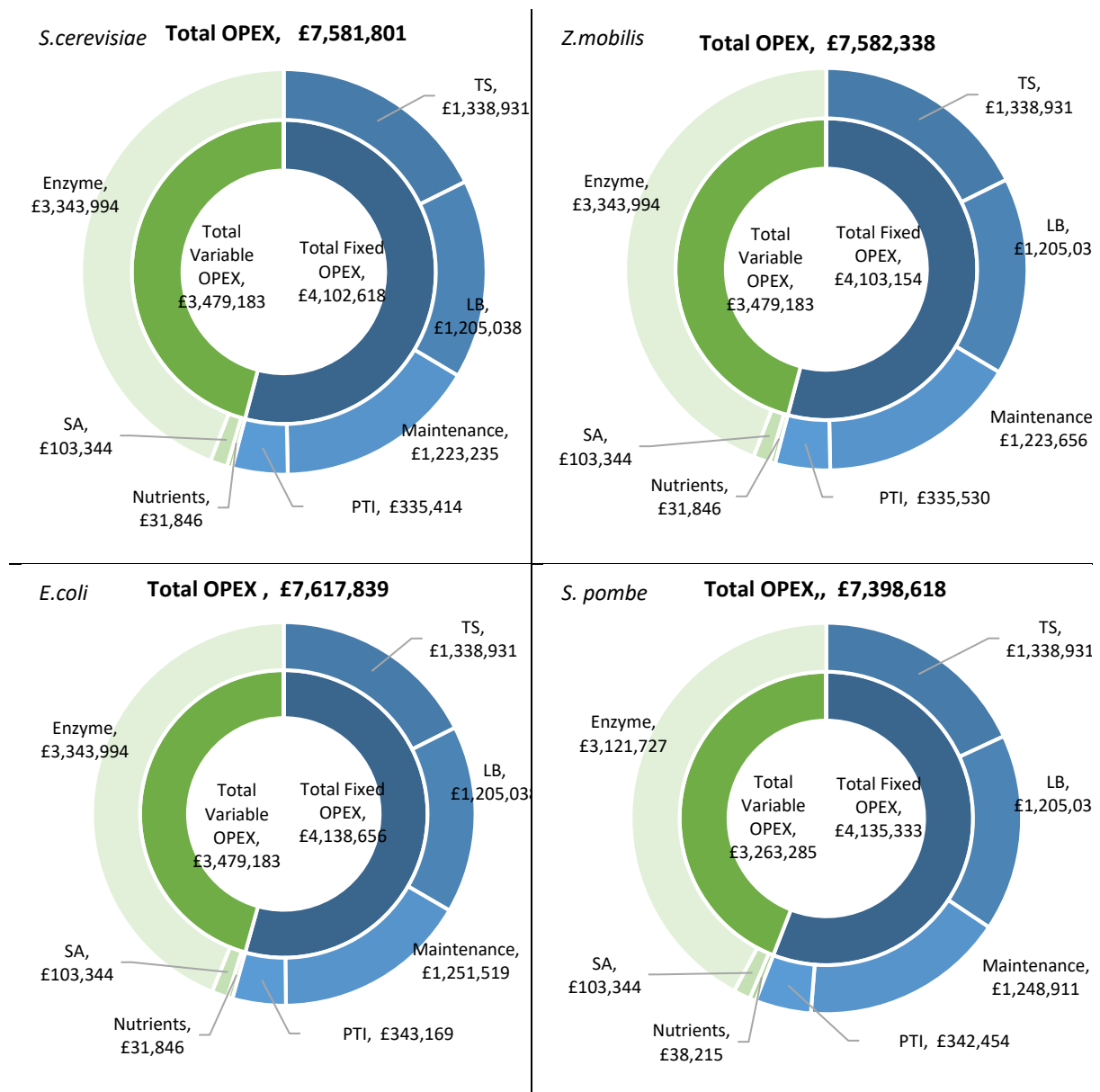

1 Figure 5 Total operating cost of MSW to ethanol using four different microorganisms-
 2 *S. cerevisiae*, *Z. mobilis*, *E. coli*, *S. pombe*. Note: OPEX= Operating cost, TS= Total
 3 salaries, LB= Labour burden, PTI= Property taxes and insurance, SA= Sulfuric acid
 4 (93%)

5 **3.3.2 Revenues of Ethanol Biorefinery and Overall Investment Analysis**

6 From Figure 6, a positive NPV can be achieved for all microorganisms (*S. cerevisiae*
 7 achieves the largest cumulative NPV), indicating a viable investment. However, this
 8 arises due to the benefit of gate fees received by diverting wastes to autoclave and
 9 ethanol production (64% of total revenues), rather than from revenues from ethanol
 10 sales (7% of total revenues) (Figure 6). As such, the financial viability of ethanol
 11 production from MSW is heavily dependent on its competitiveness with other waste
 12 treatment options, and on policy instruments, such as the RTFC. The UK's landfill tax
 13 that provide financial disincentive to dispose of wastes in landfill does not directly
 14 contribute to biofuel production. Ethanol sales (based on time series predicted ethanol

1 price of £1.23/US gal (\$1.61/US gal based on an exchange rate of 1.3 \$/£) in Figure
 2 7) and the value of associated RTFCs make a relatively small contribution to the
 3 overall financial viability of the process, representing between 8% and 15% of total
 4 revenues for all microorganisms. Variable OPEX costs related specifically to ethanol
 5 production – principally, the cost of enzyme input (£3,343,994/yr) – exceed revenues
 6 from ethanol sales and RTFCs in the base case (£2,844,364/yr), indicating ethanol
 7 production is not financially viable in these circumstances. In Section 3.3.3, the study
 8 considers in greater detail the relative merits of ethanol production through a
 9 comparison with an alternative scenario where autoclave fibre is instead incinerated
 10 to generate renewable electricity in an offsite incineration plant.

11 Key process improvements must be achieved to improve the financial performance of
 12 ethanol production from MSW, specifically improving hydrolysis yield (to increase
 13 ethanol output), reducing enzyme loading rate (to reduce variable OPEX), and, to a
 14 lesser extent, increasing solid loading rate to the “Process improved case” as in Figure
 15 8. Alongside these beneficial improvements, the production system would benefit
 16 further from non-process improvements by identifying waste streams with higher
 17 biogenic fraction, including residual waste from material recovery facilities (82wt%,
 18 based on standard composition of waste collected from households with recyclates
 19 removed at an material recycling plant prior to delivery to the autoclave plant, as in
 20 Table S2), or by isolating the organic fraction of MSW (see Figure 8). Ethanol
 21 production from MSW can be financially viable if key process improvements are
 22 achieved. Enzyme cost has considerable gearing on the financial viability of the
 23 process. Reducing enzyme unit cost and/or enzyme loading is critical for the financial
 24 viability of this (and other) biofuel production processes. Moreover, ethanol selling
 25 price influences ethanol sales revenues and thus has an impact on NPV.

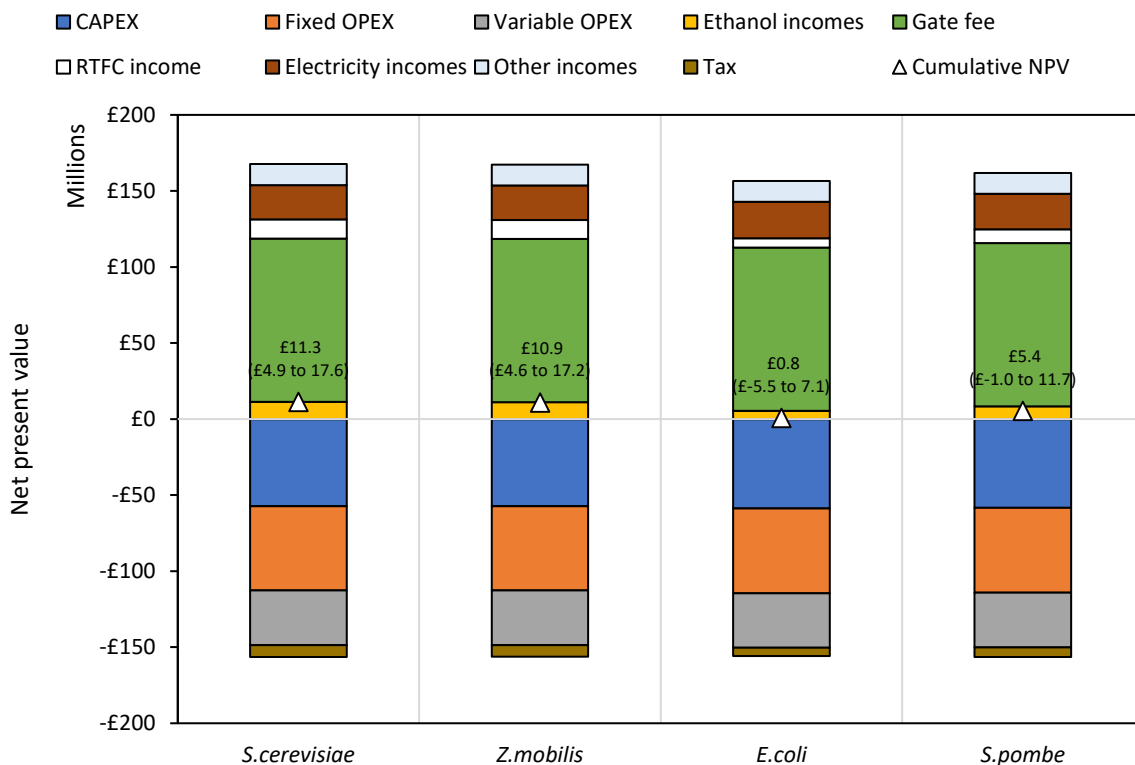

1 Figure 6 Cost and cumulative NPV for MSW to ethanol using *S. cerevisiae*, *Z.*
 2 *mobilis*, *E. coli*, *S. pombe cerevisiae* (the range of NPV values vary due to the range
 3 of gate fee: £80–90/tonne).

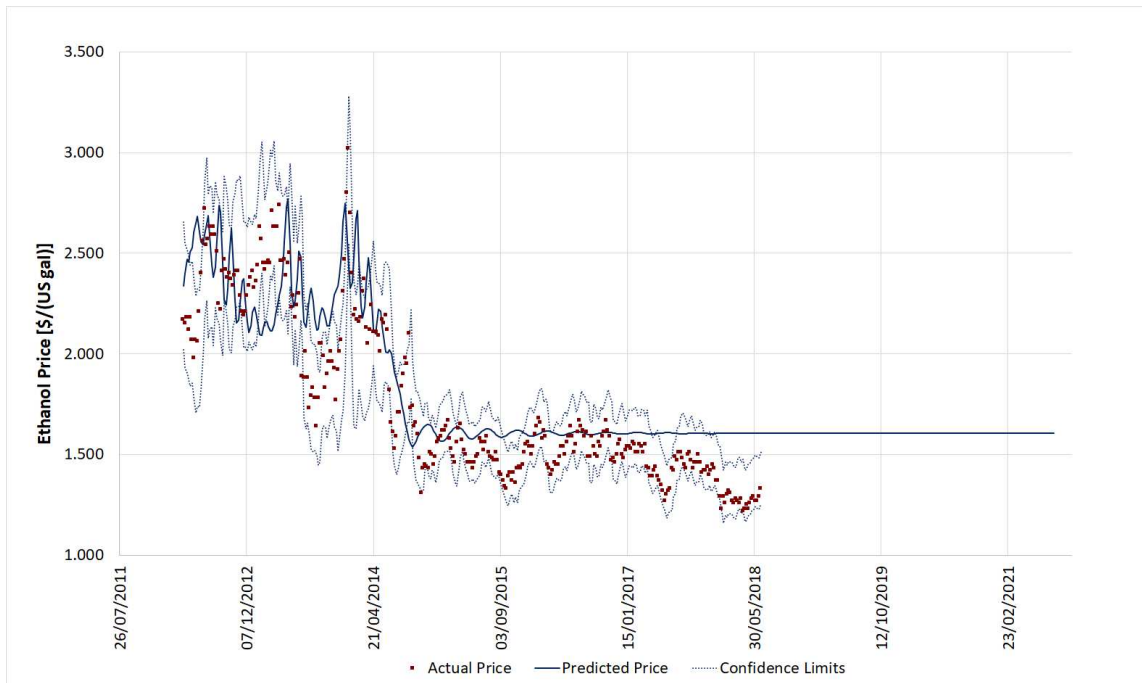

4
 5 Figure 7 Forecast for ethanol price, bounded by the confidence limits as obtained
 6 for the radial basis function neural network trained on actual (historical) price data. It
 7 shows the modelled ethanol price based on historical prices and the predicted long-
 8 term average price as £1.23/US gal (\$1.61/US gal).

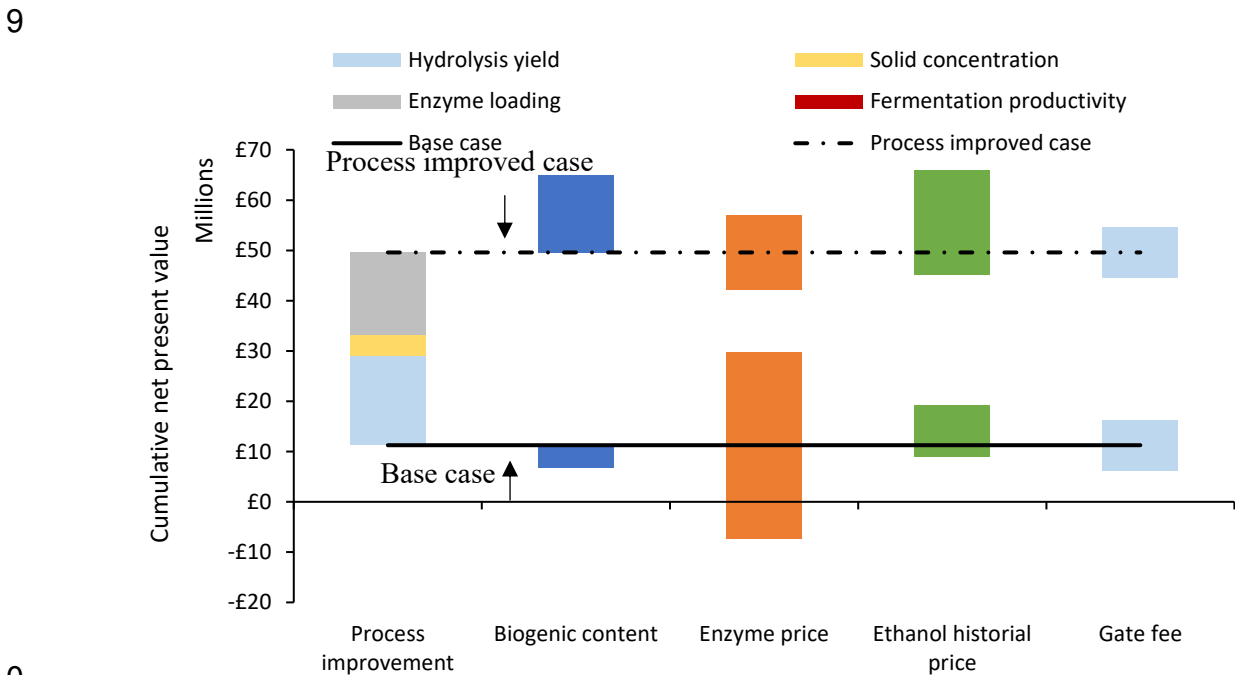

10

1 Figure 8 Sensitivity analysis of the values of cumulative net present value of MSW
2 derived ethanol at various process parameters and enzyme prices based on *S.*
3 *cerevisiae*. Solid line shows the “base case”, dashed line shows the “process
4 improved case” (process variables: hydrolysis yield from 38% to 85%, solid
5 concentration from 20% to 30%, enzyme loading from 5 wt% to 2 wt%, fermentation
6 productivity from 0.75 g·L⁻¹·h⁻¹ to 1.5 g·L⁻¹·h⁻¹). Non-process variables: biogenic
7 content: 53wt%-82wt%, enzyme price: £0.87-£4.4/kg (€1-5/kg); ethanol historical
8 price 2012-2018: £0.93-£2.31/US gal ((\$1.22-\$3.02/US gal) [51]; gate fee: £80-
9 90/tonne.

10

11 3.3.3 Comparison with Offsite Incineration

12 The preceding results indicate that ethanol production from MSW can be financially
13 viable if key process improvements are achieved. However, given the small
14 contribution of ethanol product to revenues, it is worth considering if this option is
15 competitive against other opportunities to divert waste from current waste treatment
16 processes. Towards this aim, this study evaluates an alternative scenario where the
17 autoclave fibre is instead sent to offsite incineration to generate renewable electricity.
18 The aim of this strategy is to reduce the total quantity of waste requiring conventional
19 landfill and thus avoiding landfill gate fees, while still enabling the recovery of non-
20 biogenic recyclates. In this strategy, the autoclave technology remains central. This
21 approach reduces CAPEX and OPEX requirements by excluding ethanol production
22 but forgoes revenues from ethanol sales and RTFCs.

23 Incineration of autoclaved MSW fibre diverts 150,000 tonne/yr from conventional
24 landfill disposal or direct incineration. After autoclave processing, a quantity of
25 autoclaved fibre (biogenic content of MSW), 79,500 tonne/yr, would then be sold to an
26 incineration plant receiving a potential revenue of £20/tonne (\$26/tonne) according to
27 Wilson Bio-Chemicals [56]. This will increase overall gate fee benefits (£85/tonne
28 incoming MSW + £20/tonne autoclaved fibre). Incineration of the autoclaved fibre
29 provides a higher cumulative NPV from the generation of renewable electricity than
30 the ethanol production base case, principally by reducing CAPEX expenditure by 60%
31 (Figure 9). Annual revenues from the ethanol system (base case) exceed those of the
32 alternative incineration scenario. As discussed previously, this is primarily from gate
33 fees charged to the incoming wastes to autoclave. After ethanol production and
34 recyclate recovery, only ~28,000 t/yr of residual waste needs disposing of by
35 conventional routes. Process improvements (the improved base case in Figure 8 or
36 the medium improved case in Figure 9) for ethanol production from autoclaved MSW
37 (hydrolysis yield; enzyme loading; solids loading) and enzyme/ethanol cost/gate fee
38 improvements (forming the best improved case in Figure 9) would achieve a superior
39 financial outcome to offsite renewable electricity energy recovery, with revenues from
40 ethanol sales justifying the greater CAPEX investment required.

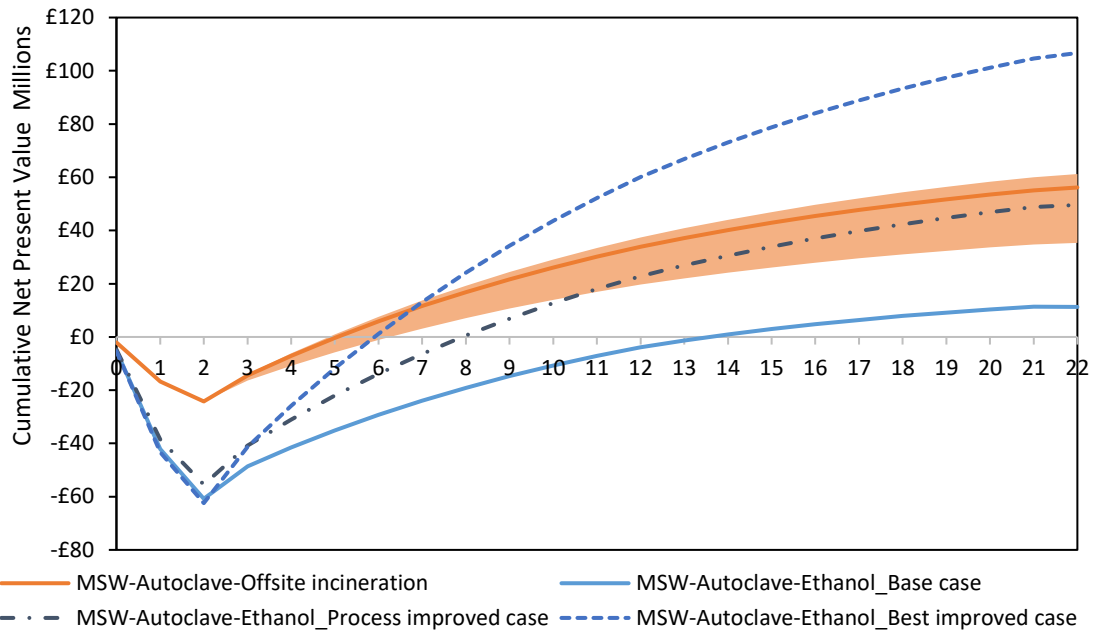

1

2 Figure 9 Cumulative NPV over project years for bioethanol production and offsite
 3 incineration of autoclaved MSW. In the shaded areas, the bottom borderline
 4 represents lower gate fee (£80/tonne) and the top borderline represents the higher
 5 gate fee (£90/tonne) relative to the base case (£85/tonne, the orange line in the
 6 middle). The solid line represents the base case MSW to ethanol production. The
 7 dashed line represents the medium and best improved MSW to ethanol production,
 8 respectively. Process improved case: with process improvements only; Best
 9 improved case: process improvement and non-process improvement (i.e., external
 10 enzyme/ethanol cost/gate fee improvements as in Figure 8).

11

12 3.3.4 Role of Policy in Supporting Biofuel Production from Wastes

13 Utilisation of wastes for biofuel production in the UK benefits from significant policy
 14 support to improve financial viability (RTFCs). This study compares the ethanol market
 15 price required to break even (NPV = 0) in the absence of this policy support to
 16 understand the viability of this opportunity in jurisdictions without equivalent support
 17 (Figure 10). As discussed previously, RTFC (£0.12 to £0.22 per RTFC and waste
 18 derived biofuels receive double RTFC per litre) is a key financial driver for ethanol
 19 production from MSW. In the absence of RTFC, diversion of wastes to ethanol
 20 production provides a much smaller benefit, requiring a break-even ethanol market
 21 price of £1.75/US gal (\$2.29/US gal) under a lower gate fee (£80/tonne). As this is on
 22 the high end of the range of historic ethanol market prices (£0.93-£2.31/US gal
 23 (\$1.22-\$3.02/US gal), 2012 to 2018 [51]), ethanol production from MSW without
 24 financial incentives is difficult to be financially viable. Producing a higher value
 25 alternative to ethanol could potentially address this issue, looking outside of transport
 26 fuel markets and can be the focus of future work.

1 RTFCs play a less significant role in the financial performance of MSW-derived ethanol
 2 in the UK compared to gate fee incomes. With current gate fee (£80-90/tonne), ethanol
 3 production from MSW remains financially viable in the absence of RTFCs, with a
 4 breakeven gate fee of £83.8/tonne (Figure 10). Although the breakeven gate fee is
 5 less than the median incineration gate fee of £89/tonne, it is less competitive than that
 6 of in-vessel composting (£50/tonne) and anaerobic digestion of mixed food waste
 7 (£27/tonne) [55].

8 Ethanol production from MSW delivers GHG savings, but the monetised value of
 9 emissions reductions is far less than main revenue sources. The social cost of carbon
 10 reported by UK Department for Business, Energy & Industrial Strategy is
 11 £12.76/tCO₂eq with a range of £2.33-25.51/tCO₂eq [64]. As above, MSW-derived
 12 ethanol can reduce approximately 79 gCO₂eq/MJ relative to gasoline (Figure 3).
 13 Therefore, it can save about 7,008 tCO₂eq/year equivalent to a carbon value of about
 14 £89,426/yr compared with much larger incomes from gate fee payments
 15 (~£13,500,000/yr) and RTFC payments (~£1,495,220/yr). It is noted that the value of
 16 GHG reduction is £0.02/L while the RTFC payment is £0.24-0.44/L. RTFC is well
 17 beyond the value of achieved GHG reductions from MSW derived ethanol. In the future,
 18 multiple viable opportunities may exist to utilise MSW (e.g., current anaerobic
 19 digestion or composting process) and therefore the role of a single use in avoiding
 20 conventional waste treatment would be questionable. The development of a relevant
 21 policy support framework that can account for the complexities of waste-to-
 22 biofuels/products is essential to promote the sustainable development of
 23 decarbonisation of the waste management, energy and transportation sectors.

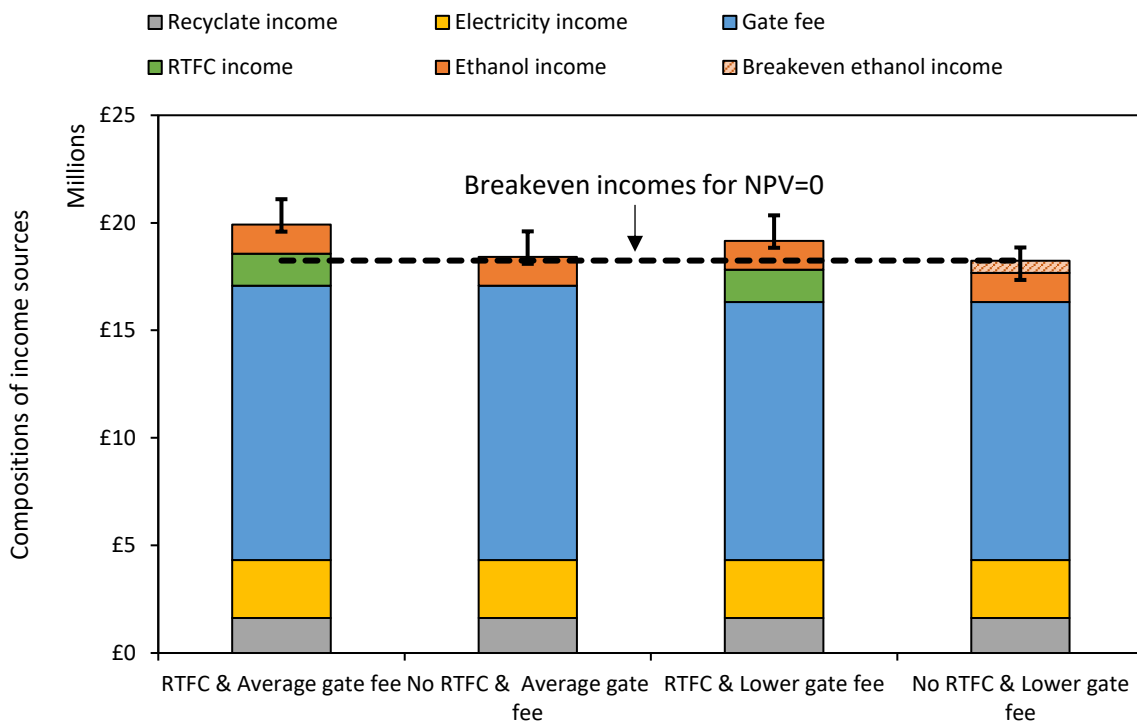

24

25 Figure 10 Compositions of income sources based on *S. cerevisiae* (error bars show
 26 the range of historical ethanol prices in 2012-2018).

4 Conclusions

The study assesses the current and future viability of bioprocessing of municipal solid waste feedstock to ethanol. The overall environmental and cost implications of converting MSW to ethanol using four fermentative microorganisms (i.e., *S. cerevisiae*, *Z. mobilis*, *E. coli*, *S. pombe*) are compared via LCA and techno-economic analysis based on process simulation of operation at commercially relevant scale. We consider three different techno-economic scenarios: Base case (based on current experimental evidence); Process Improved case (with anticipated process improvements (solid loading rate, hydrolysis yield, fermentation productivity, and enzyme loading); and Best Case (with anticipated process improvements and favourable market conditions (gate fees; product markets)).

Results based on experimental data and process modelling indicate that MSW-derived ethanol can significantly reduce GHG emissions relative to gasoline (84% reduction following EU RED calculation methodology, and by 156% to 231% reduction following the US EISA methodology). Financial analysis highlights that microorganisms achieving high ethanol yield and productivity (*S. cerevisiae* and *Z. mobilis*) are promising candidates for waste biorefining. Key process improvements must be achieved to improve the financial viability of ethanol production from MSW and deliver a clear advantage over waste incineration for renewable electricity generation, specifically improving hydrolysis yield (to increase ethanol output), reducing enzyme loading rate (to reduce variable OPEX) or using non-enzymatic hydrolysis, e.g. using acid hydrolysis, and, to a lesser extent, increasing solid loading rate. Future work can investigate supply chain and facility design optimisation (e.g., capacity; co-location) for comprehensive system analysis towards commercialisation of waste to biofuel production.

Utilisation of wastes for biofuel production in the UK benefits from significant policy support and financial support for renewable fuels (RTFCs). A positive net present value can be achieved with ethanol production from MSW, but this arises due to the benefit of gate fees by diverting wastes to ethanol production and RTFCs, rather than from revenues from ethanol sales. As such, the financial viability of ethanol production from MSW is heavily dependent on its competitiveness with other waste treatment options, and on policy instruments, such as the UK's landfill tax, that provide financial disincentive to dispose of wastes in landfill and RTFCs, that provide incentives to waste to biofuels. The comparatively low market value of ethanol at present would favour the bio-production of higher value commodity chemicals from MSW; in future, the strategic requirement for low carbon liquid fuels to meet net zero emissions targets (e.g., aviation, long distance transport) could provide higher market value for biofuels than the current ethanol market.

5 Notes

The authors declare no competing financial interest.

6 Acknowledgment

This work was supported by the funding from the Bioenergy Sustaining the Future 2 MSWBH Project 620103 and the Industrial Biotechnology (IB) Catalyst project ConBioChem funded by Innovate UK, BBSRC and EPSRC (grant BB/N023773/1).to support the translation, development and commercialisation of innovative Industrial

1 Biotechnology processes. Fermentation studies were supported by a BBSRC
2 industrial Collaborative Award in Science and Engineering (iCASE) studentship with
3 Grant No. BB/M014916/1.

4 **Author Contributions**

5 Conceptualisation: F.M., A.D., S.M.M., A.C., J.M.; Methodology: F.M., A.D., A.C., J.M.;
6 Software: F.M., A.D., A.C., J.M.; Formal Analysis: F.M., A.D., S.M.M., G.H.T., A.C.,
7 J.M.; Investigation: F.M., A.D., A.C., J.M.; Writing – Original Draft: F.M.; Writing –
8 Review & Editing: F.M., A.D., S.M.M., G.H.T., A.C., J.M.; Visualisation: F.M., A.D.,
9 A.C., J.M.; Supervision: S.M.M., G.H.T., J.M.; Funding Acquisition: S.M.M., G.H.T.,
10 A.C., J.M.

11 **7 References**

- 12 [1] Department for Environmental Food and Rural Affairs (Defra). UK Statistics on
13 Waste. 2020. Available at:
14 [https://assets.publishing.service.gov.uk/government/uploads/system/uploads/attach](https://assets.publishing.service.gov.uk/government/uploads/system/uploads/attachment_data/file/918270/UK_Statistics_on_Waste_statistical_notice_March_2020_accessible_FINAL_updated_size_12.pdf)
15 [ment_data/file/918270/UK_Statistics_on_Waste_statistical_notice_March_2020_acc](https://assets.publishing.service.gov.uk/government/uploads/system/uploads/attachment_data/file/918270/UK_Statistics_on_Waste_statistical_notice_March_2020_accessible_FINAL_updated_size_12.pdf)
16 [essible_FINAL_updated_size_12.pdf](https://assets.publishing.service.gov.uk/government/uploads/system/uploads/attachment_data/file/918270/UK_Statistics_on_Waste_statistical_notice_March_2020_accessible_FINAL_updated_size_12.pdf), accessed 29/04/2021
17 [2] The World Bank. Trends in Solid Waste Management. 2020.
18 [3] Ritchie H, Roser M. CO₂ and Greenhouse Gas Emissions.
19 OurWorldInData.org2019.
20 [4] The European Union. EU transport policy. 2014.
21 [5] Directive (EU) 2018/2001 of the European Parliament and of the Council of 11
22 December 2018 on the promotion of the use of energy from renewable sources.
23 [6] Statista. Biofuels production in selected countries in Europe in 2018. 2019.
24 [7] European Commission. Directive of the European Parliament and of the Council
25 on the Promotion of the Use of Energy from Renewable Sources (Recast). 2017.
26 [8] US EPA. Renewable Fuel Standard Program-Final Renewable Fuel Standards for
27 2017, and the Biomass-Based Diesel Volume for 2018. 2016.
28 [9] Department for Transport. Renewable Transport Fuel Obligation Annual Report
29 2017-18. 2019.
30 [10] European Union Fuel Quality Directive. Fuel quality. 2009.
31 [11] Morales M, Quintero J, Conejeros R, Aroca G. Life cycle assessment of
32 lignocellulosic bioethanol: Environmental impacts and energy balance. *Renewable*
33 *and Sustainable Energy Reviews*. 2015;42:1349-61.
34 [12] Farmanbordar S, Karimi K, Amiri H. Municipal solid waste as a suitable substrate
35 for butanol production as an advanced biofuel. *Energy Conversion and Management*.
36 2018;157:396-408.
37 [13] Dornau A, Robson JF, Thomas GH, McQueen-Mason SJ. Robust microorganisms
38 for biofuel and chemical production from municipal solid waste. *Microbial Cell*
39 *Factories*. 2020;19:68.
40 [14] Quirós R, Gabarrell X, Villalba G, Barrena R, García A, Torrente J, et al. The
41 application of LCA to alternative methods for treating the organic fiber produced from
42 autoclaving unsorted municipal solid waste: case study of Catalonia. *Journal of*
43 *Cleaner Production*. 2015;107:516-28.
44 [15] Jönsson LJ, Martín C. Pretreatment of lignocellulose: Formation of inhibitory by-
45 products and strategies for minimizing their effects. *Bioresource Technology*.
46 2016;199:103-12.

- 1 [16] Ballesteros M, Sáez F, Ballesteros I, Manzanares P, Negro MJ, Martínez JM, et
2 al. Ethanol Production from the Organic Fraction Obtained After Thermal Pretreatment
3 of Municipal Solid Waste. *Applied Biochemistry and Biotechnology*. 2010;161:423-31.
- 4 [17] Chen P, Xie Q, Addy M, Zhou W, Liu Y, Wang Y, et al. Utilization of municipal
5 solid and liquid wastes for bioenergy and bioproducts production. *Bioresource*
6 *Technology*. 2016;215:163-72.
- 7 [18] Mahmoodi P, Karimi K, Taherzadeh MJ. Hydrothermal processing as
8 pretreatment for efficient production of ethanol and biogas from municipal solid waste.
9 *Bioresource Technology*. 2018;261:166-75.
- 10 [19] Spatari S, Bagley DM, MacLean HL. Life cycle evaluation of emerging
11 lignocellulosic ethanol conversion technologies. *Bioresource Technology*.
12 2010;101:654-67.
- 13 [20] Borrion AL, McManus MC, Hammond GP. Environmental life cycle assessment
14 of lignocellulosic conversion to ethanol: A review. *Renewable and Sustainable Energy*
15 *Reviews*. 2012;16:4638-50.
- 16 [21] Mohammad P, Jon M, Heather LM, Bradley AS. Life cycle greenhouse gas
17 impacts of ethanol, biomethane and limonene production from citrus waste.
18 *Environmental Research Letters*. 2013;8:015007.
- 19 [22] Zhang Y, McKechnie J, MacLean HL, Spatari S. 14 - Environmental life cycle
20 assessment of lignocellulose-to-bioalcohol production A2 - Waldron, Keith. *Bioalcohol*
21 *Production: Woodhead Publishing; 2010. p. 365-90.*
- 22 [23] Michael W, Jeongwoo H, Jennifer BD, Hao C, Amgad E. Well-to-wheels energy
23 use and greenhouse gas emissions of ethanol from corn, sugarcane and cellulosic
24 biomass for US use. *Environmental Research Letters*. 2012;7:045905.
- 25 [24] Srivastava RK, Shetti NP, Reddy KR, Aminabhavi TM. Biofuels, biodiesel and
26 biohydrogen production using bioprocesses. A review. *Environmental Chemistry*
27 *Letters*. 2020;18:1049-72.
- 28 [25] Thapa B, Patidar SK, Khatiwada NR, KC AK, Ghimire A. Production of Ethanol
29 from Municipal Solid Waste of India and Nepal. Singapore: Springer Singapore; 2019.
30 p. 47-58.
- 31 [26] Humbird D, Davis R, Tao L, Kinchin C, Hsu D, Aden A, et al. Process design and
32 economics for biochemical conversion of lignocellulosic biomass to ethanol: dilute-
33 acid pretreatment and enzymatic hydrolysis of corn stover. National Renewable
34 Energy Laboratory (NREL), Golden, CO.; 2011.
- 35 [27] Klein-Marcuschamer D, Oleskowicz-Popiel P, Simmons BA, Blanch HW.
36 Technoeconomic analysis of biofuels: a wiki-based platform for lignocellulosic
37 biorefineries. *biomass and bioenergy*. 2010;34:1914-21.
- 38 [28] Hamelinck CN, Van Hooijdonk G, Faaij AP. Ethanol from lignocellulosic biomass:
39 techno-economic performance in short-, middle-and long-term. *Biomass and*
40 *bioenergy*. 2005;28:384-410.
- 41 [29] Gubicza K, Nieves IU, Sagues WJ, Barta Z, Shanmugam KT, Ingram LO. Techno-
42 economic analysis of ethanol production from sugarcane bagasse using a Liquefaction
43 plus Simultaneous Saccharification and co-Fermentation process. *Bioresource*
44 *Technology*. 2016;208:42-8.
- 45 [30] Chovau S, Degrauwe D, Van der Bruggen B. Critical analysis of techno-economic
46 estimates for the production cost of lignocellulosic bio-ethanol. *Renewable and*
47 *Sustainable Energy Reviews*. 2013;26:307-21.
- 48 [31] Department for Environmental Food and Rural Affairs (Defra). Digest of Waste
49 and Resource Statistics – 2018 Edition. 2018.

- 1 [32] Wilson Bio-Chemical. 2020.
- 2 [33] Ibbett R, Tucker G, McKechnie J, Meng F. Enzyme digestion of biofiber from
3 mechanical heat treated municipal solid waste: Accessing kinetic and rheological
4 design data using a pilot-scale high-solids mixer. *Biomass and Bioenergy*.
5 2020;143:105817.
- 6 [34] Meng F, Ibbett R, de Vrije T, Metcalf P, Tucker G, McKechnie J. Process
7 simulation and life cycle assessment of converting autoclaved municipal solid waste
8 into butanol and ethanol as transport fuels. *Waste Management*. 2019;89:177-89.
- 9 [35] International Organization for Standardization. ISO 14040: Environmental
10 Management: Life Cycle Assessment: Principles and Framework 2006.
- 11 [36] International Organization for Standardization. ISO 14044: Environmental
12 Management, Life Cycle Assessment, Requirements and Guidelines 2006.
- 13 [37] Stocker T, Qin D, Plattner G, Tignor M, Allen S, Boschung J, et al. IPCC, 2013:
14 climate change 2013: the physical science basis. Contribution of working group I to
15 the fifth assessment report of the intergovernmental panel on climate change. 2013.
- 16 [38] Meng F, McKechnie J. Challenges in Quantifying Greenhouse Gas Impacts of
17 Waste-Based Biofuels in EU and US Biofuel Policies: Case Study of Butanol and
18 Ethanol Production from Municipal Solid Waste. *Environmental Science & Technology*.
19 2019;53:12141-9.
- 20 [39] Dunn JB, Mueller S, Wang M, Han J. Energy consumption and greenhouse gas
21 emissions from enzyme and yeast manufacture for corn and cellulosic ethanol
22 production. *Biotechnology Letters*. 2012;34:2259-63.
- 23 [40] Edwards RP, Monica; Giuntoli, Jacopo; Koeble, Renate; O'Connell, Adrian;
24 Bulgheroni, Claudia; Marelli, Luisa. Biofuels pathways. Input values and GHG
25 emissions. Database. In: European Commission Joint Research Centre (JRC),
26 editor. 2016.
- 27 [41] Adom F, Dunn J. Material and energy flows in the production of macro and
28 micronutrients, buffers, and chemicals used in biochemical processes for the
29 production of fuels and chemicals from biomass. Lemont: Argonne National
30 Laboratory; 2015. 2015.
- 31 [42] US Argonne National Laboratory. The Greenhouse Gases, Regulated Emissions,
32 and Energy Use in Transportation (GREET) Model. 2019.
- 33 [43] Kløverpris JH. LCA data of Novozymes Cellic series, Personal Communication.
34 2018.
- 35 [44] Hsu DD, Inman D, Heath GA, Wolfrum EJ, Mann MK, Aden A. Life Cycle
36 Environmental Impacts of Selected U.S. Ethanol Production and Use Pathways in
37 2022. *Environmental Science & Technology*. 2010;44:5289-97.
- 38 [45] McKechnie J, Pourbafrani M, Saville BA, MacLean HL. Exploring impacts of
39 process technology development and regional factors on life cycle greenhouse gas
40 emissions of corn stover ethanol. *Renewable Energy*. 2015;76:726-34.
- 41 [46] Ulrich GD. A Guide to Chemical Engineering Process Design and Economics:
42 Wiley New York; 1984.
- 43 [47] Gerrard A. Guide to Capital Cost Estimating: IChemE; 2000.
- 44 [48] Chemical Engineering. Chemical Engineering's Plant Cost Index. 2020.
- 45 [49] Kløverpris; JH, Nielsen AB. Price data of Novozymes Cellic Ctec series, Personal
46 Communication. 2020.
- 47 [50] Takens F. Detecting strange attractors in turbulence. Berlin, Heidelberg: Springer
48 Berlin Heidelberg; 1981. p. 366-81.
- 49 [51] Business Insider. Ethanol market price. 2020.

- 1 [52] Park J, Sandberg IW. Universal approximation using radial-basis-function
2 networks. *Neural computation*. 1991;3:246-57.
- 3 [53] Leonard JA, Kramer MA, Ungar LH. Using radial basis functions to approximate
4 a function and its error bounds. *IEEE transactions on neural networks*. 1992;3:624-7.
- 5 [54] Pete Metcalf from Wilson Bio-Chemical. Personal communication: Recyclates
6 value from autoclave. 2018.
- 7 [55] WRAP (Waste & Resources Action Programme). Gate Fees 2018/19 final Report
8 2019.
- 9 [56] Bio-Chemical TWfW. Gate fees to Willson Bio-Chemical system. 2021.
- 10 [57] Department for Business Energy & Industrial Strategy. Contracts for Difference
11 (CFD) Second Allocation Round Results. 2017.
- 12 [58] Kalogo Y, Habibi S, MacLean HL, Joshi SV. Environmental Implications of
13 Municipal Solid Waste-Derived Ethanol. *Environmental Science & Technology*.
14 2007;41:35-41.
- 15 [59] Schmitt E, Bura R, Gustafson R, Cooper J, Vajzovic A. Converting lignocellulosic
16 solid waste into ethanol for the State of Washington: An investigation of treatment
17 technologies and environmental impacts. *Bioresource Technology*. 2012;104:400-9.
- 18 [60] Ebner J, Babbitt C, Winer M, Hilton B, Williamson A. Life cycle greenhouse gas
19 (GHG) impacts of a novel process for converting food waste to ethanol and co-
20 products. *Applied Energy*. 2014;130:86-93.
- 21 [61] McKechnie J, Zhang Y, Ogino A, Saville B, Sleep S, Turner M, et al. Impacts of
22 co-location, co-production, and process energy source on life cycle energy use and
23 greenhouse gas emissions of lignocellulosic ethanol. *Biofuels, Bioproducts and
24 Biorefining*. 2011;5:279-92.
- 25 [62] Department for Environmental Food and Rural Affairs (Defra). Statistics on waste
26 managed by local authorities in England in 2016-17. 2017.
- 27 [63] Chester M, Martin E. Cellulosic Ethanol from Municipal Solid Waste: A Case Study
28 of the Economic, Energy, and Greenhouse Gas Impacts in California. *Environmental
29 Science & Technology*. 2009;43:5183-9.
- 30 [64] Department for Business EIS. Carbon valuation. 2019.

31

32