



AMRA: Augmented Reality Assistance for Train Maintenance Tasks

Jean-Yves Didier, David Roussel, Malik Mallem, Samir Otmane, Sylvie Naudet, Quoc-Cuong Pham, Steve Bourgeois, Christine Mégard, Christophe Leroux, Arnaud Hocquard

► **To cite this version:**

Jean-Yves Didier, David Roussel, Malik Mallem, Samir Otmane, Sylvie Naudet, et al.. AMRA: Augmented Reality Assistance for Train Maintenance Tasks. Workshop Industrial Augmented Reality, 4th ACM/IEEE International Symposium on Mixed and Augmented Reality (ISMAR 2005), Oct 2005, Vienna, Austria. pp.(Elect. Proc.), 2005. <hal-00339457>

HAL Id: hal-00339457

<https://hal.archives-ouvertes.fr/hal-00339457>

Submitted on 17 Sep 2009

HAL is a multi-disciplinary open access archive for the deposit and dissemination of scientific research documents, whether they are published or not. The documents may come from teaching and research institutions in France or abroad, or from public or private research centers.

L'archive ouverte pluridisciplinaire **HAL**, est destinée au dépôt et à la diffusion de documents scientifiques de niveau recherche, publiés ou non, émanant des établissements d'enseignement et de recherche français ou étrangers, des laboratoires publics ou privés.

AMRA: Augmented Reality assistance in train maintenance tasks

Jean-Yves Didier David Roussel Malik Mallem Samir Otmane
Laboratoire Systèmes Complexes - Université d'Evry
40, rue du Pelvoux - 91000 Evry - FRANCE
{didier, roussel, mallem, otmane}@iup.univ-evry.fr

Sylvie Naudet Quoc-Cuong Pham Steve Bourgeois
Commissariat à l'Énergie Atomique (CEA) - CEA/LIST/SARC
CEN SACLAY - 91191 Saclay - FRANCE
{sylvie.naudet, quoc-cuong.pham, steve.bourgeois}@cea.fr

Christine Mégard Christophe Leroux
CEA/LIST/SCRI - CEN FAR BP 6
92265 Fontenay-aux-Roses - FRANCE
{christine.megard, christophe.leroux}@cea.fr

Arnaud Hocquard
Alstom Transport
23-25 Avenue Morane Saulnier
92364 Meudon la Forêt Cedex - FRANCE
arnaud.hocquard@transport.alstom.com

Abstract

The AMRA project, carried out by a consortium including industrials and research partners, aims at implementing an Augmented Reality (AR) system for mobile use in industrial applications such as train maintenance and repairs in industrial sites. The adopted solution is a video see-through system where a tablet-PC is used as an augmented window. The overall architecture of a prototype is unfolded, and its key points are detailed. For instance, a visual registration system has been developed to accurately overlay a video stream with information. A robust, real time registration, using a single camera tied to the tablet-PC, is performed. Besides, a hierarchical description of maintenance procedure is set up and enriched by new media such as photos, video and/or 3D models. These 3D models have been specially tailored to meet maintenance tasks requirements. The obtained multimedia contents allow easy access to technical documentation through a man machine interface managing a multimedia engine. All these features have been combined in the AMRA prototype which have been evaluated by a maintenance operator.

Keywords: augmented reality, registration, real-time object tracking, man-machine interface, industrial maintenance

1. Introduction

The AMRA project, sponsored by the French Ministry of Research, is carried out by a consortium of partners including industrials and research labs. This project aimed at implementing an Augmented Reality system for mobile use in industrial applications, especially train maintenance.

There were two objectives for such a system: the first of them was to transform cumbersome paper technical manuals to an electronic multimedia document allowing an easier data browsing. The second objective was to provide an helper application which could provide assistance and shorten the training course of a new-comer maintainer on real devices.

A video see-through system was developed, based on a tablet-PC used as an augmented window on the real world. This kind of systems raises some challenging issues such as: mobile computing, real-time object/camera registration, and contextual graphic help.

Since Augmented Reality involves field experimentations, an architecture has to be defined for sharing resources and data streams between mobile computer (on a tablet-PC) and remote computer(s) hosting maintenance database and heavy computing algorithms as detailed in section 3.

Among the critical tasks of mobile Augmented Reality appears the registration, since there is relative motion be-

tween the device and the tracked objects. These ones should be temporally and accurately registered. To overlay video streams with contextual information, a robust, real time registration system using a single camera tightly attached to the tablet-PC is introduced in section 4.

The AMRA system should provide contextual help during the execution of a maintenance procedure. Thus, an electronic description of a maintenance procedure have been designed as a structured document, enhanced with new media in addition to the textual instructions. Such an intuitive access is made available through a multimedia engine which allows to bring a contextual help at each step of the maintenance procedure as explained in section 5.

All these developments have been put together in the AMRA prototype and which is controlled through a Man machine Interface. This interface and its evaluation by a expert operator is detailed in section 6.

2. Related work

Many AR applications have, in the past, focused on the field of training and maintenance. One of the first demonstrator of AR technology was developed for Boeing for wire bundle assembly support [7]. The final prototype was composed, as far as we know, of an HMD (Head Mounted Display) as a display device and using magnetic sensors for tracking. Using very simple graphics, the operator was shown where he had to put the wires.

Another early demonstrator of AR technology was designed for a maintenance task on a photocopier [11]. The devices used in this case were a monochrome monoscopic HMD for visualization and ultrasonic sensors for objects tracking. The graphics used were simplified wireframe 3d models, not related to the CAD (Computer Assisted Design) models.

This application was followed by another one in the construction area [23] where the system was intended to help assembling spaceframe structures. An active optical tracking system composed of blinking LEDs was coupled to a passive inertial system. Once again, this system was using simple graphics. The next assembly part was identified (tagged with a conventional barcode) with an optical barcode reader.

The Fraunhofer IGD also developed an AR demonstrator for BMW. The selected task was a door-lock assembly into a car door [16]. CAD data issued from the design of the actual objects were used. Optical tracking have been chosen to localize the door, which was achieved by the mean of square targets forming a coded pattern. The visualization system was composed of an optical see-through HMD.

In the same maintenance scope using AR, a demonstrator was developed for nuclear powerplants maintenance [14].

This application focused mainly on the aspects of the informations streams for applications built on large database which couldn't fit within mobile devices such as a laptop. The system was using a HMD to display augmented informations and also a flat LCD screen as a complementary information source. Tracking technology was optical and consisted in locating black circles targets in the environment.

More recently, during four years (from 1999 to 2003), the co-ordinating German project ARVIKA [2] aimed at realizing AR-Technologies to support development, production and servicing (which also covers the maintenance aspects) with relation to complex technical products in a user-oriented and application driven manner. This project was involving more than twenty partners including research laboratories, car and aircraft manufacturers. Such project is showing the growing interest of industry and manufacturers in the AR technologies.

3. Overall architecture of the system

The first architectural choice was to determine which kind of sensors and which display we should use for our augmented reality application. We first thought to use head mounted displays (HMD) but this choice was discarded for several reasons:

- In the case of a video or optical see-through HMD we had to choose between cheap devices with a very narrow horizontal field of view (less than 30 degrees in most of the case) or expensive HMD with large field of view that were considered too bulky for our application,
- Positions of maintenance operators sometimes do not allow them to comfortably wear HMD,
- And finally, a field study revealed that maintenance operators did not want to wear any kind of HMD.

A tablet-PC was chosen as a display device (see figure 1) acting as an augmented window of the real world. Indeed, this kind of device is much lighter than classical laptops. Using this kind of display, the tracking device we selected was a camera. Real world was equipped with targets that would help recovering camera pose using image processing as explained in section 4.

At the time project started in year 2002, tablet-PC did not have enough computation power to display mixed virtual/real graphics and achieve image processing algorithm on the same CPU. The architecture exposed in figure 2 involved a remote server handling datastreams and heavy computations needed for registration.

Practically, the maintenance database is centralized and can

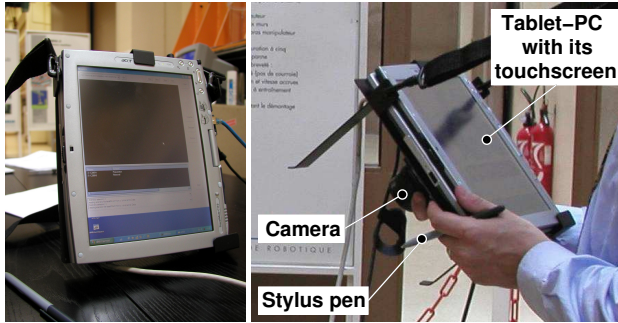

Figure 1. Tablet-PC (on the right) and tablet-PC with its camera (on the left).

be shared between different users which means we cannot store it in the operator’s maintenance tablet-PC.

The camera is tightened to the tablet-PC and connected to the remote computer through a IEEE1394 link (which has to be replaced by a radio link in order to obtain a complete wireless device). The remote computer and the tablet-PC are communicating together through a IEEE802.11g WIFI connection. The video stream transmitted by the remote computer to the tablet-PC is compressed in order to fit within the wireless network bandwidth.

Some parts of this architecture needed to be specifically developed for AR: especially the registration system, the multimedia engine for augmented reality and the graphical user interface as we will show in the next sections.

4. Visual registration system

4.1. The registration problem and related work

Registration is a necessary step in any interactive augmented reality applications. In the case of an optical see through system, the technician looks, through glasses, at annotations and virtual models which must be correctly aligned with his view. Since there is relative motion between the camera and the object, this last one should be temporally and accurately registered. Temporal registration can be achieved using two basic approaches. One is to track location beacons in the real world and/or to track the operator’s head ([4],[18]). The other is to track object features using image processing to compute one or several camera poses. Our solution is based on the second approach using a single camera.

The main technical issues concern:

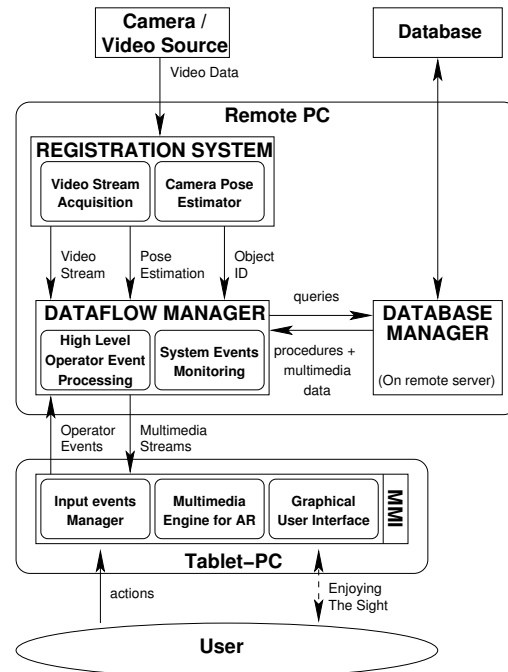

Figure 2. Software architecture overview

- the accuracy, ensuring a correct placement of CAD models with respects to the objects in the images,
- the robustness: the registration system must cope with the changes of object’s aspects, possible occlusions and changes of lighting conditions,
- the real time constraint,
- the high level of automation.

Finding a generic solution to these issues is still a challenge. Popular approaches include marker based methods [5] (ARToolKit), [16], [17](cybercode), [24] and feature based methods [10], [15], [20]. In the first case, markers are well defined in order to ease their detection in the image. It ensures that speed, stability and robustness of the registration system are quite independent of the environment. The main drawback is the preliminary set up of markers in real world which may be impossible for some particular environment. The second type of methods consists in visually tracking object features. Since features change in appearance with the point of view, these techniques generally use complex algorithms which leads to the unavoidable compromise between speed and robustness. Moreover, some techniques are specific for a type of feature, for example: lines [1], textured objects [20] or geometric primitives [15]. The most general purpose techniques are model-based tracking methods ([10],[15]). Finally, most of these methods are not yet fully automated: a human hand is usually needed to extract features in the first image and to match them with the model.

In the context of train maintenance, we have developed two registration solutions. The first one is a marker based method whereas the second one is an hybrid method combining a marker solution for the object identification and a model based tracking method. The two approaches address all the mentioned issues.

4.2. The proposed approach

4.2.1 Overview

The main steps of the registration system are:

1. the object recognition: which leads to the selection of the CAD model associated to the object,
2. the model-image matching: 2-D features are extracted and paired with 3-D known features of the CAD model,
3. the camera pose estimation: a 3-D rigid transformation composed of a rotation \mathbf{R} and a translation \mathbf{t} is obtained.

The first proposed algorithm extracts feature points from visual markers on the objects to compute the camera pose. The second algorithm starts with an initial pose estimation using a marker, and performs a markerless 2-D tracking of natural contours.

4.2.2 Marker based registration

Two type of markers were implemented: color coded markers and simple markers, as shown in figure 3. The color coded markers enable to: i) automatically recognize the equipment by the mean of an associated code, ii) provide five feature points (the corners and the center) to initialize the camera pose. Simple markers are smaller and easier to detect; their center is used to refine the pose estimation using an iterative process. For a set of n_c coded markers and n_s simple markers, there will be at most $5n_c + n_s$ feature points to extract from the image and to match to 3-D points. An overview of this algorithm is summed up by figure 4.

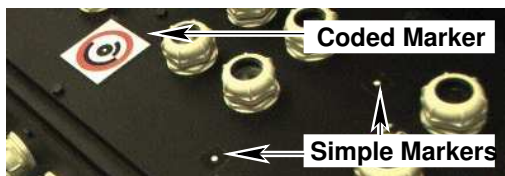

Figure 3. Markers used in the registration process

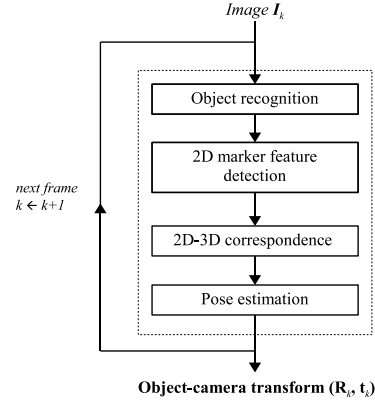

Figure 4. Algorithm 1 - marker based registration

Coded marker extraction: A coded marker is recognized using its ring of a specified color and the validity of its code. We use an efficient connected component extraction algorithm proposed in [8] combined with a fast color classification [6] method to detect colored rings in the image. Components are then filtered with different shape criteria such as the elliptic variance. The marker feature points are extracted using a RANSAC robust estimation [12]. The decoding of the markers is described in [13].

This solution has been originally developed for photogrammetry. It was modified to perform real time registration for AR applications. Compared to the ARToolkit marker system, which is quite a standard, our particular application requires a large number of markers (many different objects to recognize). Our approach was more efficient because the processing time of ARToolkit's code identification depends linearly on the number of possible codes, whereas our system performs this task at a constant time.

Iterative pose estimation: The pose estimation is computed by running a modified version of the POSIT algorithm detailed in [9]. A more accurate value of the pose parameters can be obtained by adding new points such as the centers of the simple markers. Thus, it is possible to iteratively refine \mathbf{R} and \mathbf{t} if the number of detected simple markers increases. The simple markers are searched in windows predicted by the previous pose, using a fast multi-resolution template matching technique (figure 5).

Robustness to occlusion: To improve the robustness to marker occlusions, the 2-D position of the simple markers is predicted at order 0 or 1. Searching for a hidden marker might result in creating outliers for the pose estimation (false detection), and in any case, in slowing down the whole process. To determine which markers are visible at the actual pose, we used a point occlusion test based on a space partitioning of the CAD mesh in octrees, and a collision detection algorithm. As the mesh is usually locally

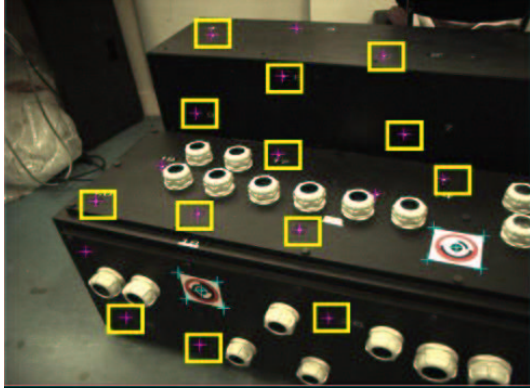

Figure 5. Marker detection - The coded marker feature points are denoted by crosses in cyan, the simple markers center by crosses in magenta. The yellow squares represent the search areas for the simple markers detection.

complex, the occlusion test is very fast.

4.2.3 Feature based registration

This method combines a coded marker method to identify the object and a feature based method to track it. In an initialization step, the coded marker is used in the first image to recognize the object and perform the model-image matching, as previously described. In all following images, the tracking and the 3-D registration are performed without marker using only the CAD model of the object and its edges. This technique, presented in figure 6, is an adaptation of the method proposed in [10] based on a Lie group formalism. In each new image, the model is rendered in order to get the position of the visible edges according to the current estimate of object pose. The new position of an edge is searched in the direction of its normal. The result measurement vector corresponding to the 2-D motion, helps to estimate the inter frame motion and retrieve the object pose. Under a small motion hypothesis, tracking errors may arise when there are large inter frame motions. To avoid this pitfall, the technique was adapted in a multi-resolution scheme.

4.3. Results and discussion

The figure 7 shows results obtained with the marker based registration. The required visual precision is achieved with a very good alignment of the 3-D model on the image. Even with a single coded marker, the pose estimation is satisfactory. An evaluation of the robustness of the coded marker

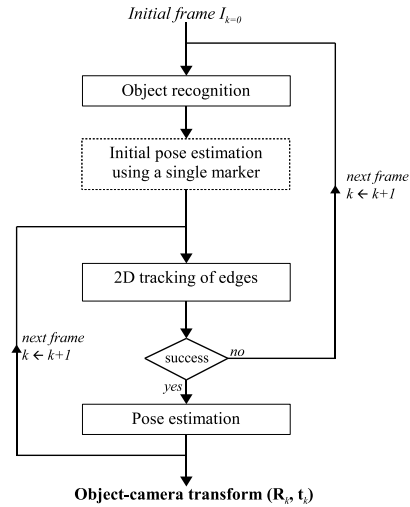

Figure 6. Algorithm 2 - Feature-based registration.

detection showed that, for a distance of 100 cm (marker size of 50x50 pixels), the marker is always detected for an angle varying from 30° to 150° . In these conditions, the precision of pose estimation from one marker is about 3mm and between 1° and 6° , depending on the viewing angles. Concerning the speed performance of the algorithm, the registration runs at about 30 Hz on a 3.0 GHz Pentium IV.

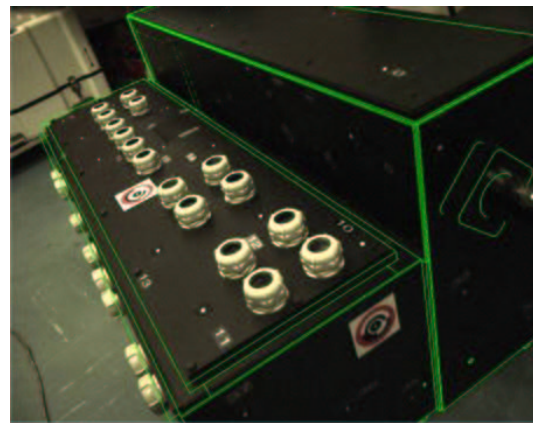

Figure 7. Results of the marker based registration. A simplified 3-D model is displayed in wireframe representation.

We also tested the feature based registration to perform a robust tracking of a table. After a coarse initialization of the pose, performed by the marker based algorithm, the feature algorithm estimates the camera pose and projects the CAD model onto the images. We obtained similar visual quality for the second registration method.

In order to tend to a markerless augmented reality system, we are investigating on an initial step without marker relying on a direct object recognition leading to a pose estimation.

5. Multimedia contents

The next step is to prepare documentation for maintenance operators. The main idea is to provide easy access to technical documentation as opposed to paper manuals that tend to become very cumbersome and poorly flexible as stated in [21]. By using electronic documents, we can also introduce more media, like 3D models, sounds and videos. Moreover, such electronic manuals should embed augmented reality features.

5.1. Key document: the electronic procedure

Since the maintenance procedure is the key document in such a system, all media will be related to the procedure. The choice of using an XML based technology was made to describe a typical maintenance procedure. Such choice was appropriate because a maintenance manual can be seen as a structured tree. Such a document will be composed of three main parts:

- pre-requirements: describing what operators will need in order to start activity. It includes safety notes, tools, spares and consumables that will be required.
- available-media: naming and listing all media that may be needed during the procedure in addition to the text of the procedure itself.
- phases: also called steps of the procedure. Such steps are also including notes, safety recommendations and the referenced media available as an illustration of the text describing each phase.

Each main part of the document and all the markup hierarchy is displayed on figure 8. Such kind of document could be seen as a lightweight version of IETMs (which stands for Interactive Electronic Technical Manuals) that are used by the American Department of Defense [19].

As we stated, we can link each step of our key document to some media to enhance the procedure's text understanding. These media could be: video, images (various format are accepted like jpeg, png and bmp), sounds and 3D models (registered or not with the video stream). Each kind of media is handled by a specific media manager registered by the application.

In our case, 3D models are augmented with graphical assistance to explain the procedure's steps. It means they meet the requirements of a special format explained below.

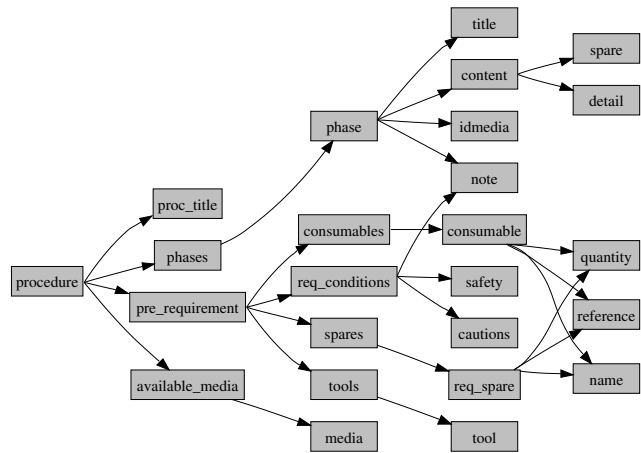

Figure 8. XML markups system for maintenance procedures

5.2. Augmented 3D models for maintenance

The 3D models we use are the virtual counterparts or the real device we want to maintain (see figure 7). We choose to import our models using the VRML97 standard [22] since it is a widely spread standard for 3d objects that most of modelers and CAD softwares can import or export, even if it tends to be replaced by its XML successor : X3D [22]. For further development, the migration from VRML to X3D should not be a problem since X3D maintains the same scene graph and nodes. It also provides ways to add interactivity to 3D models for animating maintenance activities such as disassembling. And finally, it allows to create new nodes (known as PROTOs) to fulfill our specific needs. Our models were directly exported from the ones used during the design phase of the devices to maintain. However, due to the lack of computing power of the tablet-PC we had to reduce the complexity of the CAD models. This was achieved partly automatically and partly manually until we could reach a good compromise between graphical complexity and rendering speed.

An other important change of the original models was to bring structure to the virtual model in order to insert assembly/disassembly animations.

5.2.1 From the procedure to the animations

In order to enhance our virtual model with suitable maintenance augmentations, we had to study several maintenance procedures and find out the commonly performed actions, and therefore synthesize these actions in our virtual model by the mean of animations.

In order to explain the aim of this task, here is an excerpt of

one of the maintenance procedure we used in AMRA, concerning one of the maintenance operation to perform on an electrical transformer:

-
- B1 ...
- B2 Disconnect the electrical connections on the 'A' side as follows:
- 10 Remove the two self-lock nuts (14), bolts (1) and four washers (2) and disconnect the cable (13) from the LV mount on the transformer. Discard the self-lock nuts (14) and bolts (1).
 - 20 Remove the self-lock nut (4) and the washer (5) and disconnect the cable (7) from the stud (3). Discard the self-lock nut (4).
- B3 ...
-

One can see that the basic maintenance operations described by this excerpt consist in unscrewing nuts and removing the covers/cables/connectors maintained by these nuts. Therefore, we can assume that most of the unscrewing or removing actions are very similar to each other. So, a quite simple idea was to design new VRML Nodes (also known as prototypes) whose fields and events would reflect the various features of assembly/disassembly tasks simulation such as unscrewing and removing animation, or object's fading (for a temporary X-ray look through covers).

Moreover, these prototypes should be generic enough to act on any parts of the virtual model, so they could be used just as regular VRML grouping nodes which could contain any kind of geometry (and more generally, any kind of nodes). And finally, we should be able to link these prototypes instances together in order to create sequential or concurrent animations

5.2.2 New nodes design for augmenting reality

Our prototypes should provide visual simulations of maintenance operations to the operator by animating parts of the virtual model. But animations alone are not enough, they should always be supported by a visual hint enhancing the symbolic action to be performed. For instance, unscrewing actions are enhanced by a rotating arrow, and removing is enhanced by a direction arrow. These visual hints intentionally wears bright colors (in our case a kind of fluorescent green).

We will now focus on the development of the "Unscrewer" prototype. As the other developed prototypes are applying the same philosophy.

This prototype is used when we have to unscrew and remove a mechanical part. Geometry of these parts are contained in the children *exposedField*, allowing us to unscrew any kind of shape or group of shapes. The complete architecture of

the Unscrewer proto is also shown in figure 9. Here are the different steps performed by the Unscrewer :

- The unscrewer is triggered by receiving an *SFTime* event routed on the "startTime" *eventIn*. Animations duration in seconds is specified by the *unscrewTime exposedField*, and the *removePercent field* defines the percentage of this duration dedicated to withdrawal,
- First the mechanical part is unscrewed by a number of rounds (*nbRounds field*) with a specified thread (*stepSize field*) which allow partial or complete unscrewing. Unscrewing is enhanced by a rotating visual hint (*hinturl1 exposedField*),
- Then the mechanical part is moved away at a specified distance (*removeDist field*). Withdrawal is enhanced by a still direction arrow (*hinturl2 exposedField*),
- At the end of each step, the corresponding visual hints appear and disappear,
- When all animations are finished the Unscrewer emits a new *SFTime* event through the *stopTime eventOut* which could be used to start any of the developed prototypes in order to create linked animations,

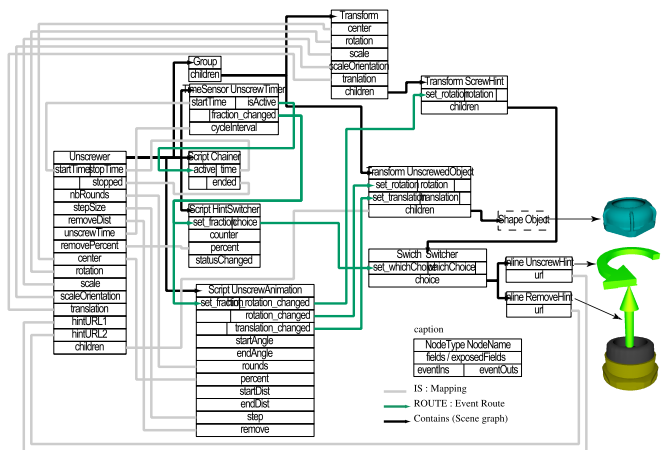

Figure 9. Unscrewer proto architecture

5.2.3 Augmenting maintenance procedure steps

Procedures steps are instantiated in the virtual model by linking instances of the different prototypes together as explained earlier. Figure 10 presents an excerpt of the Scene graph and routes graph associated to a substep of the maintenance procedure: 6 bolt should be unscrewed before removing a box cover. The animation sequence is using routes between *stopTime* of previous nodes and *startTime* of next nodes:

1. First bolt is unscrewed and the material associated to all box covers (contained in "Box Cover 1") is faded so we could temporarily see through the box covers,
2. Then the second bolt is unscrewed,
3. And so on with the third bolt,
4. Then the three last bolts are unscrewed simultaneously,
5. And finally the box cover is moved away,
6. When withdrawal is achieved the material of the box covers is unfaded.

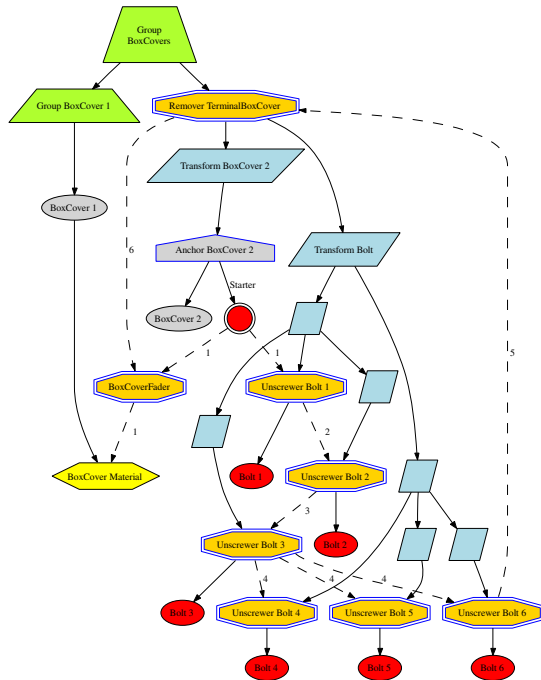

Figure 10. Scene graph (plain) and route graph (dashed) of a procedure step simulation

5.2.4 Multimedia engine

The multimedia engine allows to bring a contextual help to each step of the procedure by using one or several available media, such as photos, videos and 3D animated models which could be registered on top of the video stream coming from the camera.

To achieve this, such an engine had to implement several features and use several Application Programming Interfaces (API). Our engine, written in C++, allows us to parse XML procedures using built-in XML parser of the QT library, which is also able to load and display several images formats. The use of Open Inventor API was fairly indicated to parse and display X3D/VRML content describing

3D models. And finally, to execute javascript code introduced to animate 3D models, we use the NJS library, one of the former runtime cores interpreting Javascript in Netscape browsers.

More media could be taken into account, as the multimedia engine uses a plugin system allowing one media manager per type of medium. Such plugins are registered by the multimedia engine during application setup.

Our engine is implementing all the options needed to handle several media which could be controlled through the man machine interface detailed in the next section.

6. Man Machine Interface

6.1. Description

The Man Machine Interface (MMI), is organized around an area used to display both images and graphic assistance. As presented on figure 11, the virtual model could be displayed on top of the video stream.

The top of the MMI is dedicated to the maintenance procedure. It contains an area allowing the operator to choose the maintenance procedure to apply to the element identified by the visual registration system. The chosen procedure is displayed below the graphic area and can be checked step by step.

Video display can be frozen which can be useful for the operator to keep a steady display allowing him to put the tablet-PC down on a table.

The notification area is used to display AMRA system information such as connections to the database or to the video server.

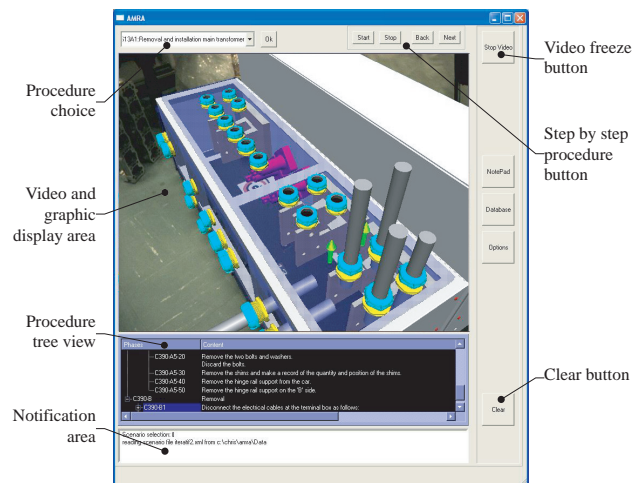

Figure 11. AMRA Man Machine Interface

6.2. Manipulating 3D models

Several modes of interaction with the 3D models are provided to the operator. The most passive way is performed by switching from one step to another of the procedure. The 3D models will be animated when the maintenance step is requiring it. The operator can also directly interact with the 3D models by starting animations at will (registered onto video stream or not), and virtually move freely around the 3D model to see the geometry of the mechanical part he has to maintain.

In the case of a 3D model registered on top of the video stream, we can give technical specifications of a part just by selecting it in the real image. Such a selection gives us a point on the image but also intersects the virtual model beneath, allowing us to retrieve the name and IDs of the corresponding elements in the virtual model.

A few images of the capabilities of our 3D model system are exposed in figure 12.

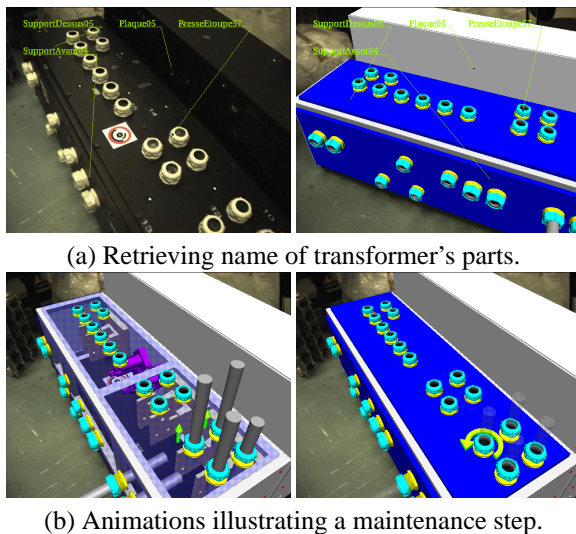

(a) Retrieving name of transformer's parts.

(b) Animations illustrating a maintenance step.

Figure 12. Some 3D model manipulation capabilities.

6.3. An early subjective evaluation

We proceeded to a two parts evaluation: a subjective questionnaire has been developed in order to test utility and usability of AMRA by field operators and an expert analysis has been carried out in order to reveal usability problems. The analysis is based on [3] and is focusing on: visual rendering quality, comfort of use, intelligibility of the meaning of the animation, comprehension of the animations in superimposition with the environment, benefits of augmented reality for the application, interaction, usability of AMRA.

The answers of the overall 28 questions are marked on a scale of 7 items ranked from bad to excellent. The questionnaire was ended by an interview in order to define the principal hits and negative aspects of the prototype.

Even if only one operator, considered as representative of maintenance operators, participated to the evaluation, the global judgment of AMRA is positive. The results of the ergonomic expertise, showed that the two expertises converge on the main drawbacks of AMRA:

- The lack of spatial indications can impair the use of AMRA in larger environments. The prototype supposes that the user is positioned at the right place at the right time to visualize the area of interest. If not, the user must be oriented graphically or orally toward this area,
- The end of the animations is sometimes difficult to perceive. An indicator of the beginning and end of a sequence must be provided,
- The weight of the tablet-PC, tolerable for the evaluations, is too heavy for everyday use. The use of smaller devices such as pocket PC should be recommended,
- The stylus pen is not adapted to manipulation in maintenance environment.

The conclusions of the evaluation are positive, despite some MMI limitations that can be easily solved. AMRA is easy to handle, and its architecture related to a maintenance database can provide an interesting tool for maintenance applications. The functionalities of AMRA are interesting for maintenance application, even though the technological realization must be more mature.

7. Conclusion

In this project, we have designed a video see-through AR system for operators training and assistance in train maintenance tasks.

An electrical transformer and its maintenance procedure provided, by the final user (ALSTOM) of the system, have been used as a test bench.

The first evaluation of this system shows that it can really be helpful for maintenance operators, as it provides, in a very intuitive manner, an easy and contextual access to technical manuals, replacing the extremely cumbersome paper documentation.

Some limitations like the weight of the hardware should be solved in a near future. Besides, we have laid the foundations for further research and development in AR system devoted to industrial applications.

Acknowledgments

This work was supported by French Ministry of Research (see: <http://www.telecom.gouv.fr/rntl/AAP2001/-Fiches.Resume/AMRA.htm>). The interdisciplinary consortium of partners include ALSTOM (Industrial) as final user, ActiCM (startup) as a sensors integrator, CEA (Atomic Energy Agency) and LSC (Research Lab) as main actors of this project.

We thank all the members of our companies/labs who provided helpful insights for this project : engineers (especially Fabien Dory) as well as maintenance operators. And finally, we would like to “special thank” Christine Mégard who supported this project all the way through.

References

- [1] A. Ansar and K. Daniilidis. Linear pose estimation from points or lines. *IEEE Transactions on Pattern Analysis and Machine Intelligence*, 25(5):578–589, 2003.
- [2] Arvika. Arvika, augmented reality for development, production and servicing. Available at “<http://www.arvika.de>”, 1999.
- [3] C. Bach and D. Scapin. Recommendations ergonomiques pour l’inspection d’environnements virtuels. EUREKA-COMEDIA project report. Technical report, INRIA Rocquencourt, France., 2003.
- [4] G. Barattoff, A. Neubeck, and H. Regenbrecht. Interactive multi-marker calibration for augmented reality applications. In *Proceedings of 2002 IEEE / ACM International Symposium on Mixed and Augmented Reality (ISMAR 2002)*, pages 107–116, 2002.
- [5] M. Billinghurst and H. Kato. Collaborative augmented reality. *Communications of the ACM*, 45(7):64–70, 2002.
- [6] J. Bruce, T. Balch, and M. Veloso. Fast and inexpensive color image segmentation for interactive robots. In *Proceedings of the 2000 IEEE/RSJ International Conference on Intelligent Robots and Systems (IROS ’00)*, volume 3, pages 2061 – 2066, October 2000.
- [7] T. Caudell and D. Mizell. Augmented reality: an application of heads-up display technology to manual manufacturing processes. In *Proceedings of the Twenty-Fifth Hawaii International Conference on System Sciences*, volume 2, pages 659–669, January, 7-10 1992.
- [8] F. Chang, C. Chen, and C. Lu. A linear-time component-labeling algorithm using contour tracing technique. *Computer Vision and Image Understanding*, 93(2):206–220, February 2004.
- [9] D. F. Dementhon and L. S. Davis. Model-based object pose in 25 lines of code. *Int. J. Comput. Vision*, 15(1-2):123–141, 1995.
- [10] T. Drummond and R. Cipolla. Real-time visual tracking of complex structures. *IEEE Transactions on Pattern Analysis and Machine Intelligence*, 15(1):932–946, July 2002.
- [11] S. Feiner, B. MacIntyre, and D. Seligmann. Knowledge-based augmented reality. *Commun. ACM*, 36(7):52–62, July 1993.
- [12] M. A. Fischler and R. C. Bolles. Random sample consensus: a paradigm for model fitting with applications to image analysis and automated cartography. *Commun. ACM*, 24(6):381–395, 1981.
- [13] F. Gaspard, S. Naudet, E. Noifalaise, and P. Sayd. Cibles codées et procédé de photogrammétrie utilisant de telles cibles. *Patent*, (PCT/fr/03/50101), 2002.
- [14] G. Klinker, O. Creighton, A. H. Dutoit, R. Kobylinski, C. Vilsmeier, and B. Brugge. Augmented maintenance of powerplants: a prototyping case study of a mobile ar system. In *IEEE and ACM International Symposium on Augmented Reality (ISAR’01)*, pages 124–133, New York, October, 29-30 2001.
- [15] E. Marchand, P. Boutheymy, F. Chaumette, and V. Moreau. Robust real-time visual tracking using a 2d-3d model-based approach. In *IEEE International Conference on Computer Vision (ICCV)*, volume 1, pages 262–268. IEEE, September 1999.
- [16] D. Reiners, D. Stricker, G. Klinker, and S. Muller. Augmented reality for construction task: Doorlock assembly. In *Proceedings 1st International Workshop on Augmented Reality (IWAR’98)*, pages 31–46, 1998.
- [17] J. Rekimoto and Y. Ayatsuka. Cybercode: designing augmented reality environments with visual tags. In *DARE ’00: Proceedings of DARE 2000 on Designing augmented reality environments*, pages 1–10. ACM Press, 2000.
- [18] B. Schwald and B. de Laval. An augmented reality system for training and assistance to maintenance in the industrial context. In *Proc. 11th International Conference in Central Europe on Computer Graphics, Visualization and Computer Vision ’2003 (WSCG)*, 2003.
- [19] US Navy. *IETM. Interactive Electronic Technical Manuals.*, 2000. available at “www.ietm.net”.
- [20] L. Vacchetti, V. Lepetit, and P. Fua. Stable real-time 3d tracking using online and offline information. *IEEE Trans. Pattern Analysis and Machine Intelligence*, 26(10):1385–1391, 2004.
- [21] C. Ventura. Why switch from paper to electronic manuals. In *DOCPROCS ’88: Proceedings of the ACM Conference on Document Processing Systems*, pages 111–116, 1988.
- [22] Web3D Consortium. *X3D and Related Specifications*. available at “www.web3d.org/x3d/specifications/”.
- [23] A. Webster, S. Feiner, B. MacIntyre, W. Massie, and T. Kruger. Augmented reality in architectural construction, inspection, and renovation. In *Proceedings of the Third ASCE Congress for Computing in Civil Engineering*, pages 913–919, Anaheim, June 1996.
- [24] X. Zhang, S. Fronz, and N. Navab. Visual marker detection and decoding in ar systems: A comparative study. In *Proceedings of 2002 IEEE / ACM International Symposium on Mixed and Augmented Reality (ISMAR 2002)*, pages 97–106, 2002.