



Detection and monitoring of high stress concentration zones induced by coal mining using numerical and microseismic method

Gloria Senfaute, Marwan Al Heib, Jean-Pierre Josien, J.-F. Noirel

► To cite this version:

Gloria Senfaute, Marwan Al Heib, Jean-Pierre Josien, J.-F. Noirel. Detection and monitoring of high stress concentration zones induced by coal mining using numerical and microseismic method. 5. International Symposium on "Rockbursts and seismicity in mines", Sep 2001, Sandton, South Africa. <ineris-00972231>

HAL Id: ineris-00972231

<https://hal-ineris.ccsd.cnrs.fr/ineris-00972231>

Submitted on 3 Apr 2014

HAL is a multi-disciplinary open access archive for the deposit and dissemination of scientific research documents, whether they are published or not. The documents may come from teaching and research institutions in France or abroad, or from public or private research centers.

L'archive ouverte pluridisciplinaire **HAL**, est destinée au dépôt et à la diffusion de documents scientifiques de niveau recherche, publiés ou non, émanant des établissements d'enseignement et de recherche français ou étrangers, des laboratoires publics ou privés.

Detection and monitoring of high stress concentration zones induced by coal mining using numerical and microseismic methods

G. Senfaute¹, M. Al-Heib¹, J.P. Josien¹, J.F. Noirel²

¹Institut National de l'Environnement Industriel et des Risques (INERIS) – Laboratoire Environnement Géomécanique et Ouvrages (LAEGO) –Ecole des Mines, 54042 Nancy, France

Tel : 03 83 58 41 75

Fax : 03 83 53 38 49

e-mail : senfaute@mines.u-nancy.fr

²Houillères du Bassin de Lorraine (HBL), 57802, Freyming Merleback, France

Tel : 03 87 83 96 69

Fax : 03 87 83 96 21

Synopsis

Zones of high stress concentration induced by coal mining at a depth of 1250 meters in the Lorraine Collieries are detected and monitored using a combination of numerical and microseismic methods. Changes in the stress state induced by coal mining are estimated by means of numerical simulations. The areas of high stress concentration are located and monitored by local microseismic network. The study of microseismic activity recorded during mining made it possible to localise the zones of high stress concentration and validate the calculations done by numerical modelling. The results of this study hold out interesting prospects for using a combination of numerical modelling and microseismic monitoring for detecting, locating and monitoring of the zones prone to rockbursts.

Keywords: microseismic network, numerical modelling, high stress concentration, rockbursts.

1. Introduction

Since the middle of the 19th century the Houillères du Bassin de Lorraine collieries have been extracting the biggest coal deposits in eastern France near the Franco-German border. The geology of the coalfield is extremely complex, in that it is affected by two faulted anticlines (Merleback and Simon) separated by a syncline with highly asymmetric edges (Marienau). This series is overlaid unevenly by the Vosge sandstone formation of a thickness varying between 200 and 300 meters according to location

(Figure 1). In the zone investigated, the seams worked lie in two clusters: lower and upper of soft coal.

Mining operations modify the equilibrium state of the rock mass. In particular, it leads to a new distribution of stresses, according to the rheological and mechanical behaviour of the structure, and this process is the cause of substantial microseismic activity^{1,2}. Some of this microseismic activity is associated with dynamic phenomena^{3,4,5}. The effects of these phenomena are felt mainly in the vicinity of the coalface and can cause significant damage in the workings, such as the collapse of roadways, violent failure of pillars, or coalbursts at the seam. Research has been done to define a methodology for predicting high stress concentration zones based upon large scale numerical modelling^{6,7}. In the present study, numerical modelling was combined with microseismic monitoring for detecting and locating the high stress concentration zones induced by the coal mining. It was carried out during the mining of the Irma seam at a depth of 1250 meters in the collieries of the Lorraine basin (France).

2. Description of the site

The Irma coal seam is worked using the longwall caving method. The width of the working face is 290 meters and the total length 1700 meters. The thickness of the seam is from 3 to 4 meters and it slopes at 20°. The working of this face involves 4 different configurations (Figure 2):

- configuration 1: the working face is 535 meters long and is located 180 meters below the old workings of the Louise seam;

- configuration 2: the working face passes through a barrier pillar 195 meters wide, known as the Louise barrier pillar;
- configuration 3: after passing through the Louise barrier pillar, for 390 meters the working face is 180 meters below old workings at the Louise panel and alongside old workings at another adjacent face (the Irma 1140 panel);
- configuration 4: the working face is alongside the old workings at an adjacent face (the Irma 1140 panel) for 580 meters.

3. Numerical modelling

The zones of high stress concentration are estimated by numerical modelling using the Suit3D computer code⁸ based on the boundary element method⁹. Suit3D is a numerical code developed to calculate induced stresses and displacements due to mining operations for tabular mines (coal mines, gold mines, etc.). The code uses the displacement discontinuity method. The advantage of Suit3D is its capacity to model group of seams close to each other; to generate mesh for any form of exploitation area and to calculate different energy parameters. The Suit3D code is able to incorporate in the calculations all the panels or seams that influence a particular sector, without limitation. The numerical modelling process at the scale of the Irma panel embraces all the panels worked in the sector (4 seams). Modelling was done in a number of phases corresponding to the different configurations in which the panels were worked (e.g. Figure 2).

The first series of numerical modelling operations sought to identify the high stress concentration zones existing before the Irma panel was worked. It revealed two such

zones: one corresponds to the area of the Louise barrier pillar (zone1) and the other to an area of older adjacent worked panels: zone 2 (Figure 3a). In these areas, the normal stress concentration was about 1.2 times the initial stress. The second series of numerical modelling operations was intended to determine the changes in the zones of high stress concentration once work on the Irma panel had begun. It showed that the arrival of the working face in these areas that were already overstressed caused an extension in the overstressed zone and a substantial increase in the value of the stress. This was of the order of 1.7 and 1.9 times the initial stress (Figure 3b).

4. Local microseismic monitoring network

In order to locate and monitor the high stress concentration zones identified by the numerical modelling process, a local microseismic monitoring network was installed in the vicinity of the workings at the Irma panel. The network consisted of 16 sensors of the vertical geophone type installed in the roofs of the roadways (Figure 4). The geophones have a specific frequency of 14 Hz. The signals are transmitted via telephone pairs to a central data input and processing unit at the surface. Data acquisition employs a computer with a sampling frequency of 3 kHz. As soon as an event is recorded, automatic processing takes place. In this way the location, energy and magnitude of the event are automatically calculated.

5. Analysis of microseismic activity

5.1 Location of events

Six blast were fired in order to determine the propagation velocity of the seismic waves appropriate to precise location of the seismic epicentres in the zone of study. Interpretation of this series of blast gave a seismic wave propagation velocity of the order of 4700 m/s. The accuracy of the location of the events using this velocity model is of the order of 20 meters. During working of panel, a total of 60,375 microseismic events were recorded, with a maximum magnitude of the order of 3. The events were located close to the working face, both in front and behind. The small seismic events, of magnitude below 1.5 (98 percent of the population) were evident throughout the workings. However the strongest events, of magnitude 1.5 or above (2 per cent of the population) appeared and were located in two zones: the zone of high stress concentration in the barrier pillar (zone 1) and the zone affected by stresses from the old adjacent workings (zone 2).

5.2 Seismic energy

The seismic energy of each event is determined using the following equation:

$$E = 4\pi R^2 \rho c \int_{t_1}^{t_2} V^2(t) dt$$

Where ρ is the density of the medium, R is the hypocentral distance; $V(t)$ is the ground velocity and c is the group velocity of the P and S phases. This method is valid when the seismic wave is radiated spherically and symmetrically. The quality factor (Q) is not taken into account. The attenuation was estimated as not significant considering the short distances source-geophones and the recorded wavelengths. However, for the energy computation we consider the geometry effect. The calculation is done for each

geophone recording a valid signal and then averaged over that number of geophones. Accordingly the seismic energy is estimated at the source of the event.

The correlation between the seismic energy and the cumulative advance of the workings demonstrates the different seismic patterns associated with the extraction of the panel. Four seismic patterns were observed. Figures 5 and 6 show the different seismic patterns observed throughout the working of the face:

Pattern 1: This seismic pattern appears after the face has advanced through 50 meters and is associated with the caving of the roof. This pattern shows that the seismic energy released increased as a linear function of the advance of the face for the first 500 meters of working, and is associated with small events of magnitude below 1.5.

Pattern 2: A change in the seismic pattern takes place once the working face arrives beneath the Louise barrier pillar. This new pattern is characterised by a considerable increase in the seismic energy released and is associated with the appearance of strong seismic events, of magnitude 1.5 or more. These events add to the small seismic events that are present during the first seismic pattern.

Pattern 3: A third seismic pattern appears about 25 meters after the working face has moved on from the barrier pillar. It is characterised by a substantial fall in the seismic energy released and is associated only with seismic events of low magnitude. This pattern is perturbed by the appearance of a few strong events. However the strong events are located behind the face and beneath the barrier pillar.

Pattern 4: A change in pattern appears when the working face moves on from the zone located 180 meters underneath old workings. This seismic pattern is characterised by a substantial increase in the seismic energy released and is associated with the appearance of strong seismic events.

6. Correlation between microseismic activity and high stress concentration zones

The numerical simulations showed two high stress concentration zones before working of the Irma panel, and an increase in stress concentration when the working face arrived in these areas. The location of high stress concentration zones, as estimated by numerical modelling, is confirmed by the microseismic activity recorded during working of the face. Analysis of the seismic energy released as a function of the advance of the face shows a strong change in the seismic pattern in the zone of the barrier pillar (zone 1) and the zone affected by stresses from the old adjacent workings (zone 2); Figure 5. These changes are associated with the appearance of strong seismic events. All the strong seismic events are located in the zones of high stress concentration identified by numerical modelling (Figure 7). The researches¹ showed that in the Witwatersrand gold mines the position of seismic epicentres coincided with the zones where the changes in stress induced by mining were maxima.

The small seismic events of magnitude below 1.5 that appeared after the commencement of caving are present throughout the working and are grouped in a

cluster. This cluster of events is localised in the vicinity of the face, both in front and behind, and advances with the working face. This population of low magnitude events is associated with the ruptures created during caving of the roof and the microcracking of the coal in front of the face^{9,10}. The strong seismic events, localised solely in the zones of high stress concentration identified by numerical modelling are associated with the opening or slipping of pre-existing cracks in this zone and/or with the creation of new failures.

7. Conclusions

The control of the behaviour of the rockmass under difficult conditions of mining necessitated the introduction of a methodology based upon large scale numerical modelling and microseismic monitoring.

The numerical simulations were able to identify the high stress concentration zones induced by the working faces at a depth of 1250 meters. The location of this high stress zones was confirmed by the location of the microseismic epicentres and analysis of the seismic energy released. The changes in seismic pattern and the location of the events of high magnitude were correlated with the zones where the changes in stress estimated by numerical modelling were highest. The results of this study open interesting prospects for using a combination of numerical modelling and microseismic monitoring as a means of detecting, locating and monitoring of the zones prone to rockbursts.

8. Bibliography

1. McGarr A., Spottiswoode M., Gay N. Relationship of mine tremors to induced stresses and to rock properties in the focal region. *Bulletin of the Seismological Society of America*. Vol. 4, 1975. Pp. 981-993.
2. Kaneko K., Sugawara K., Obara Y. Rock stress and microseismicity in a coal burts district. *Rockbursts and Seismicity in Mines*. Fairhurst (ed.), Balkema, Rotterdam.1990.pp 183-188.
3. Ben Slimane K., Besson J.C., Mandereau G., Chambon C. La surveillance sismique : un outil d'aide à la planification des chantiers sujets aux phénomènes dynamiques. 3^{ème} Colloque Polono-Français, Wroclaw. *Studio Geotechnica et Mechanica* Vol XI, N° 1, 1990. pp 51-68.
4. Senfaute G., Bigarre P. Josien J.P., Mathieu E. Real-time microsismic monitoring, Automatic wave processing and multilayerd velocity model for accurate event location. *Rock Mechanics in Petroleum Engineering, EUROCK*. ed. Balkema, Delf/Netherlands. 1994 pp. 631 – 638.
5. Senfaute G. Microseismic Monitoring of Underground Coal Mining at the Provence Coal Mines. Thesis (Ph.D.) defended at the French National Engineering Institute of Lorraine (INPL). 1995. 321 pages.
6. Al-Heib M.,Piguet J.P., Noirel J.F., Josien J.P., Linkov A. La planification des travaux miniers assistée par des modèles prévisionnels des états de contrainte dans les massifs rocheux.. 11ème colloque Franco-polonais en Mécanique des Roches. 1996.
7. Josien J.P., Derrien Y. The prevision of rockbursts in Gardanne Colliery. 26 Conf. Int. Des Recherches sur la sécurité dans les Mines de Katowice. Pologne.1995.

8. Al-Heib M., Derrien Y. Apport de la modelisation numérique à la maîtrise du comportement des terrains. Congres de l'Industrie Mineral. Montpellier (France). 1988.
9. Linkov A., Zoubkov V., Al Heib M. Computer aided analysis of stressed state and rockburst hazard in veins and coal seams influenced by faults. SAREST 97. 1st southern african rock engineering symposium proceedings. Johannesburg, South Africa. Editors : RG Gürtunca, TO Hagan. 1997.
10. Senfaute G., Chambon C., Bigarre P, Guise Y., Josien J.P. Spatial Distribution of Mining Tremors and the Relations to Rockburst Hazard. Journal of Pure and Applied Geophysics. Birkhäuser Verlag, Basel. Vol 150, 1997. Pp. 451- 459.
11. Syrek B., Kijaro C. Energy and frequency distribution of mining tremors and theirs relations to rockbursts hazard in the wujec Coal Mine, Poland. Acta Geophy. Pol. 36.1988.

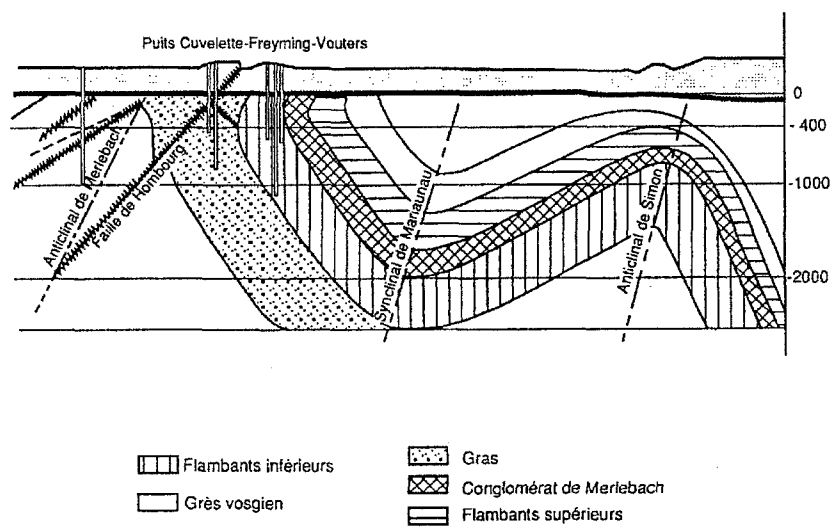

Figure 1: Geological section of the Lorraine Collieries

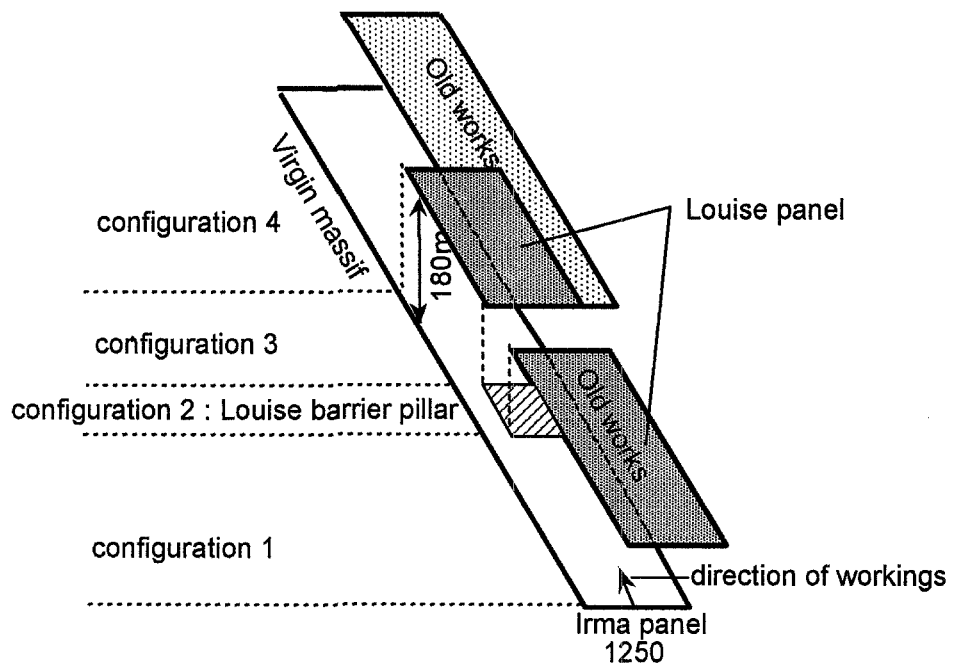

Figure 2: Working configuration of the Irma panel

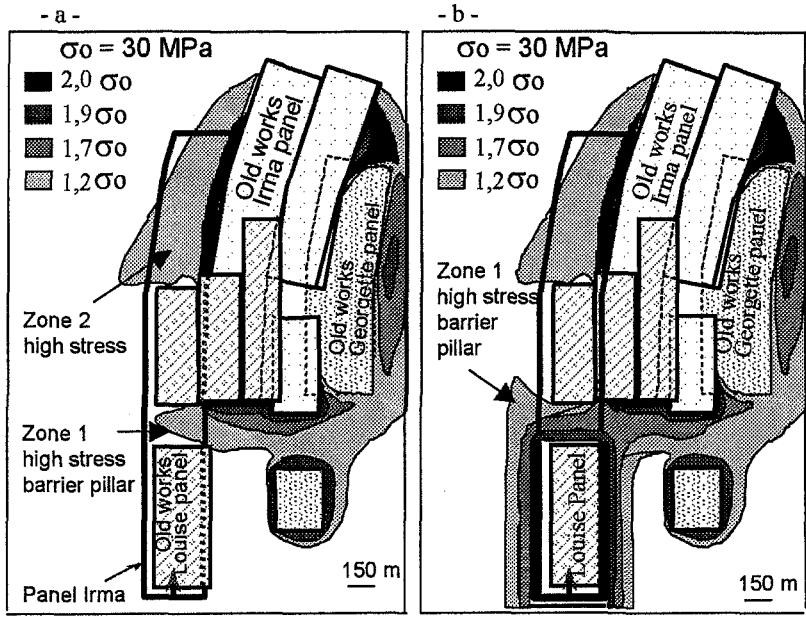

Figure 3: High stress concentration zones estimated by numerical modelling: a) zones 1 and 2 showing high stress zones before any mining operations had taken place. b) Evolution of the high stress zones after 630 meters advance (the working face being level of the pillar) the stress in the pillar zone increased.

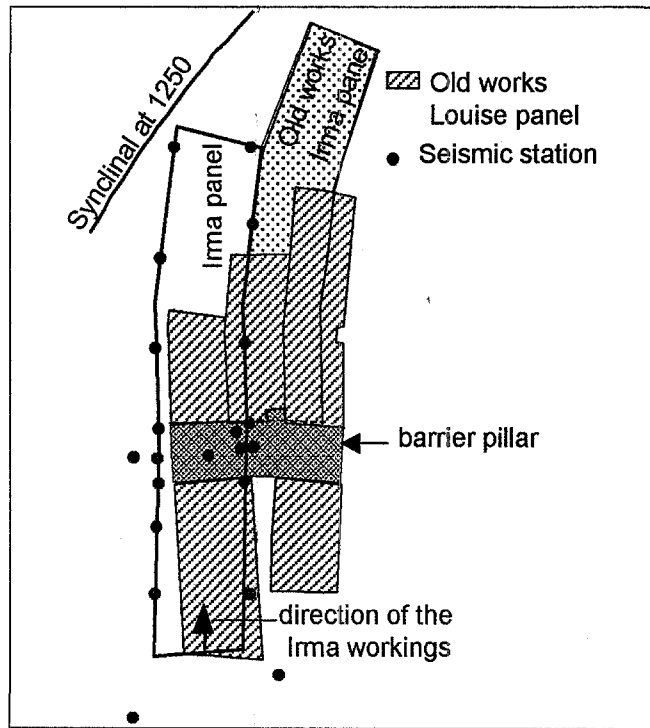

Figure 4: Configuration of the microseismic network installed during working of the Irma panel.

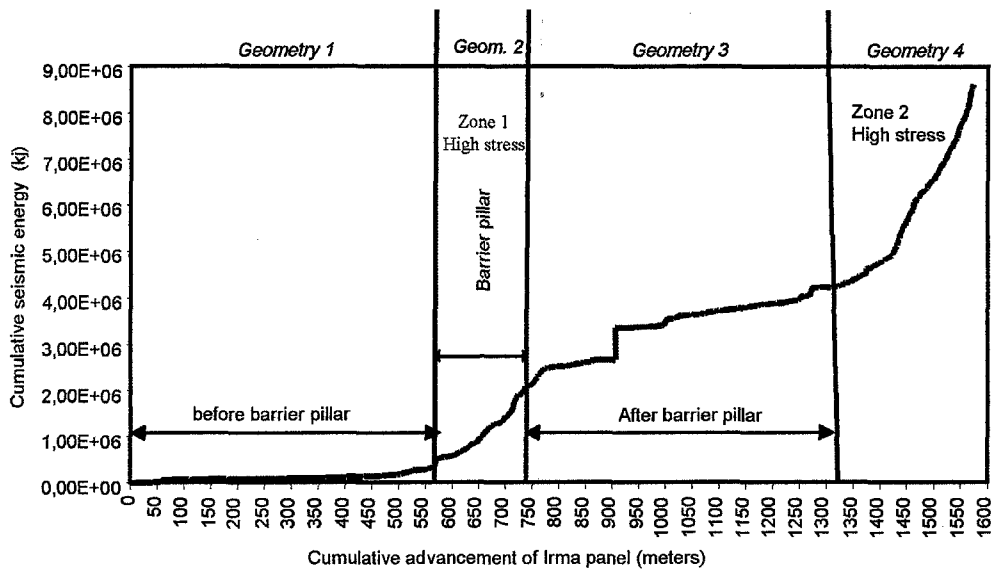

Figure 5: Correlation between seismic energy and the cumulative advance of the Irma panel

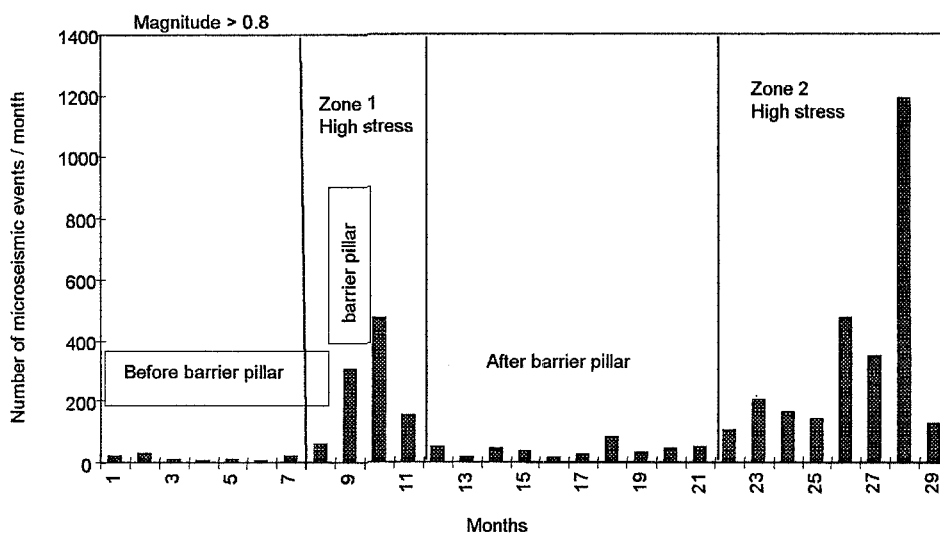
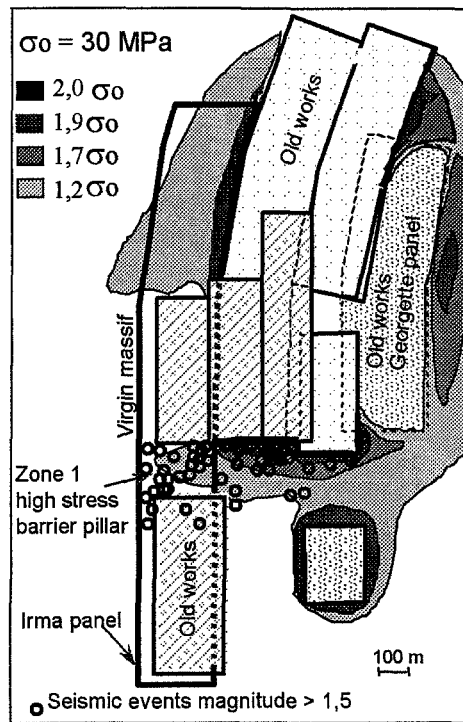

Figure 6: Number of seismic events of magnitude higher or equal to 0.8 and correlation with the different working configurations at Irma panel.



34 375 seismic events ($0 < ML < 3$)
 210 seismic events ($ML > 1,5$)

Figure 7: Location of microseismic events of magnitude higher to 1.5 recorded during the first 600 meters of working of the Irma panel (the working face was located in the barrier pillar zone) and location of high stress concentration zones identified by numerical modelling.