



Hardware Article

Automated tangential-flow diafiltration device

Arne Lügen^a, Maïke Bruckhaus^a, Udo Kosfeld^b, Meike Emondts^c,
Matthias Wessling^{a,c,*}

^a RWTH Aachen University, AVT.CVT – Chair of Chemical Process Engineering, Forckenbeckstraße, 51, 52074 Aachen, Germany

^b RWTH Aachen University, AVT.BioVT – Chair of Biochemical Engineering, Forckenbeckstraße, 51, 52074 Aachen, Germany

^c DWI – Leibniz Institute for Interactive Materials, Forckenbeckstr. 50, 52074 Aachen, Germany



ARTICLE INFO

Article history:

Keywords:

Cross-flow filtration

Colloid

Soft matter

Microgel

Purification

Unit operation

Arduino microcontroller

ABSTRACT

Tangential flow filtration (TFF) is a chemical unit operation used to purify and concentrate liquid suspensions of colloids, proteins, or cells. The solution flows tangentially across a membrane, such that a selective part of the fluid permeates the membrane while the filtrated matter is retained, increasing its concentration. TFF is a mild mechanical purification method that does not interact chemically with the filtrate. It is applied in sensitive separation tasks in protein chemistry, microbiology, or immunology. It is a fast alternative for dialysis applications, also applicable in the field of colloid purification. However, the costs of automated lab-scale devices (30,000 €) and the consumable membrane modules (100–600 €) make TFF currently hardly accessible for lab-scale polymer researchers. Therefore, we built a low-cost TFF system (2400 €) partly automated by an Arduino microcontroller and optimized for diafiltration buffer exchange and concentration processes in soft matter colloid research. We use medical hemodialysis membrane modules that only cost a share (20–50 €) of alternative TFF modules, and we demonstrate the functionality of the system for an exemplary colloidal microgel purification process.

© 2021 The Author(s). Published by Elsevier Ltd. This is an open access article under the CC BY-NC-ND license (<http://creativecommons.org/licenses/by-nc-nd/4.0/>).

1. Hardware in context

Ultrafiltration membranes are porous filters used to separate and concentrate particles in liquid suspensions by flushing them through the porous structure. The solvent and smaller molecules permeate the membrane while larger particles are retained by size and charge exclusion and accumulate on the feed side of the membrane. In tangential flow filtration (TFF), the feed suspension is tangentially flushed across the membrane. The solvent and smaller molecules permeate the porous membrane, while the small pores retain larger particles. These larger particles are concentrated and leave the membrane separately in the retentate. Accordingly, TFF systems are either used to separate larger particles, such as colloids, proteins, or cells from smaller ones, or to exchange the suspension buffer. The separation task's driving force is the transmembrane pressure from the feed to permeate side, which regulates the share of fluid permeating the membrane [1,2]. Therefore, TFF systems separate suspensions based on mechanical forces without chemical interaction. Thus, TFF is attractive for fragile and delicate purification tasks in the fields of pharmacy [3] and protein chemistry [4], as well as for large-scale purification in microbiology [5] or water treatment [6].

* Corresponding author at: RWTH Aachen University, AVT.CVT – Chair of Chemical Process Engineering, Forckenbeckstraße, 51, 52074 Aachen, Germany.
E-mail address: manuscripts.cvt@avt.rwth-aachen.de (M. Wessling).

Specifications table:

Hardware name	Automated tangential-flow diafiltration device
Subject area	<ul style="list-style-type: none"> • Tangential flow filtration • Chemical engineering • Biochemistry • Polymer chemistry • Downstream processing • Concentration • Purification
Hardware type	Lab-scale chemical engineering unit operation system
Open source license	Creative Commons Attribution-ShareAlike 4.0 International License (CC BY-SA 4.0)
Cost of hardware	2400 Euro
Source file repository	https://doi.org/10.17605/OSF.IO/TWB3J

TFF unit operation systems consist of a sample beaker, a permeate beaker, a feed pump, a membrane module, and a back pressure valve. The feed pump transports the sample inside the membrane module and creates a transmembrane pressure. The membrane-permeating share of the fluid flows into the permeate beaker. The remaining retentate is pressure released by the back-pressure valve and circulates back into the sample beaker. Accordingly, the sample loses volume and concentrates. In diafiltration, this sample volume loss is substituted by the new buffer. Systems without automatic process control are commercially available from different manufacturers for 4000–8000 €. Automated systems monitor pressures and flow-rates using pressure sensors and balances to control the transmembrane pressure and to exchange buffer for diafiltration automatically. Simple automated systems cost around 20000–30000 € and can also be expanded with various sensors to monitor the filtration process. Exemplary manufacturers for such lab scale systems are Merck Millipore, Pall Corporation, Repligen Corporation, or Sartorius AG.

The core part of the TFF process is the membrane module. The membrane defines the separation task by selectively retaining certain particles or molecules by size or charge exclusion. The retained matter concentrates on the feed side and accumulates on the surface and in the membrane's inner pore structure in a filter cake. After filtration, cleaning procedures are applied to remove the accumulated matter and increase performance. Nevertheless, a share of the matter generally remains inside the pore structure. Subsequently, if contamination is not acceptable, membranes can be reused for the same product but need to be exchanged for different ones. TFF membranes and modules are subject to plenty of patents about membrane materials, flow-management, and module design continuously being filed until today [7–10]. Consequently, each manufacturer offers slightly different membranes and modules. The two widespread membrane materials are polyethersulfone (PES) and regenerated cellulose (RC). The membrane modules are either stacked flat-sheet membranes or bundles of hollow fibers. Both materials are available in all kind of pore sizes for ultrafiltration and microfiltration applications. Depending on the effective membrane area, ready to use lab scale membrane modules are commercially available for prices of 100–700 €. This price is reasonable if reused for a certain product but rarely affordable if used as a single-use product in lab-scale purification tasks as often applied in research and development.

A more prominent application for PES membranes is blood purification by hemodialysis. This membrane application uses hollow fiber PES membranes to purify human blood on kidney failure diseases [11] with worldwide more than 2 million patients receiving the treatment several times a week [12]. Blood purification modules are single-use and commercially available as hollow fiber module with different effective membrane areas reaching from 0.2 m² to 2.5 m². Additionally, these modules are available with different molecular weight cut-offs in the range of 10–300 kDa [13]. Due to efficient mass production, the costs for one module is 20–60 €. These low cost membrane modules were recently applied for single pass tangential flow filtration for antibody purification and proved to be well suited for ultrafiltration applications [14].

Microgels are soft polymeric colloids that gained major attention in research in the last decade with possible applications in drug delivery and surface functionalization [15]. In lab-scale, microgels from various polymers are synthesized by precipitation polymerization in a batch or plug flow reactor [16]. Both methods are easily up scaleable and suitable for large scale production. However, the synthesis brew contains linear pre-polymers, surfactants, and other residuals that need to be removed in a purification step. In lab-scale, purification is performed either by dialysis using bath dialysis tubes or ultracentrifugation [17]. Both purification methods take a long time, extensive manual work, and are not suitable for a larger production. Tangential flow ultrafiltration is expected to be the promising purification procedure for upscaling microgel fabrication [15,18]. Microgel filtration was already experimentally studied in terms of its fouling characteristics [19,20] and its filter-cake motions [21], as well as modeled by the group of Nägele [22,23]. However, purification of microgels using membrane filtration was not studied in terms of its functionality and productivity.

In this work, we built an automated tangential-flow ultrafiltration device customized for fast and cheap diafiltration-based microgel purification. We use diaphragm pumps and a manual back pressure valve for setting up the filtration. Additionally, we use an ultrasonic sensor as a level indicator in the sample beaker, such that an Arduino microcontroller can automatically regulate the diafiltration with buffer exchange. We suggest low-cost blood dialyzers as membrane modules and

confirm the functionality of the process by purifying Poly-N-vinylcaprolactam (pVCL) microgels and analyzing the efficiency of the process using nuclear magnetic resonance (NMR) measurements.

2. Hardware description

The design of the device combines a robust filtration unit with low-cost automation for diafiltration. In the process (Fig. 1), we use diaphragm pumps with solvent-resistant PVDF/ETFE pump head for the feed pump (KNF-NF1.100) and a PP/ETFE pump head for the water pump (KNF-NF1.60). These pumps have moderate shear stress, a low risk of leakage, and can generate high pressures up to 6 bar. Simultaneously, they cost significantly less than comparable peristaltic pumps, which are often used in commercial TFF systems. For smooth filtration and pressure readout, a pulsation damper is added to the feed stream (KNF-Pulsationsdämpfer FDP 1.10). The filtration unit also includes a stainless steel diaphragm based backpressure valve (Swagelok) on the retentate side of the membrane, which enables a robust and precise regulation of the transmembrane pressure in the range of 0–1.7 bar.

The core part of the filtration device is the membrane module that is commercially used as a medical blood dialyzer. In our 200 ml - 500 ml batch microgel application, we chose membrane modules with an effective membrane area of 0.2 m² and 0.6 m² and high-flux membranes (Baxter) with a molecule weight cut off (MWCO) of 30 kDa [11]. One module costs approx. 50 €, which is approx. 10 % of a comparable commercial TFF membrane module. The membranes used for hemodialysis and TFF are fabricated with the same polymer in a similar process. The reason for the significant price difference is the mass production of the hemodialysis membranes and modules. Compared to traditional microgel purification using batch dialysis tubes, the price of the single-use tubes is similar to the cost of the membrane modules used in this process.

These mechanical fluid-contacting components are all connected using 4 mm outer diameter polyurethane tubing. These components result in a feed-retentate cycle hold-up volume excluding the membrane module of 43 ml, while the membrane module adds another 17 ml or 52 ml for the Polyflux 2H or 6H respectively. Estimating an average transmembrane pressure of 0.4 bar, the feed pump can operate flow rates in the range of 0–1100 ml/min. For our exemplary filtration with a Polyflux 6H membrane module we achieve permeate fluxes at 0.4 bar of 175 ml/min.

An Arduino microcontroller controls the electrical system (Fig. 2). It communicates with the operator via two buttons and a display to initialize the operation mode and the settings. The microcontroller displays the feed pressure from the electric pressure sensor, the sample beaker volume, and the operation time during operation. The feed pump control and the diafiltration settings are set by the operator using the control buttons. The diafiltration is controlled using a low-cost contactless ultrasonic level indicator installed in the 3D-printed lid of the feed baker. In running operation, the solvent permeates the membranes, such that the microgel concentration increases and the sample volume reduces. The ultrasonic level indicator measures this volume change in the sample beaker. It regulates it by controlling the water pump in iterative steps substituting the solvent with pure water from the water tank. Three safety measures are installed. The whole system is stopped automatically if one of the three cases occurs. In the first case, the float switch indicates that the waste tank is full. In the second, the electric pressure sensor exceeds a maximum pressure, and in the third, the water level in the sample beaker does not rise during water pump operation. This last case indicates a leakage somewhere in the system. The material costs for the automation are about 70 € for the microcontroller and circuit board and 5 € for the ultrasonic sensor. The electric pressure

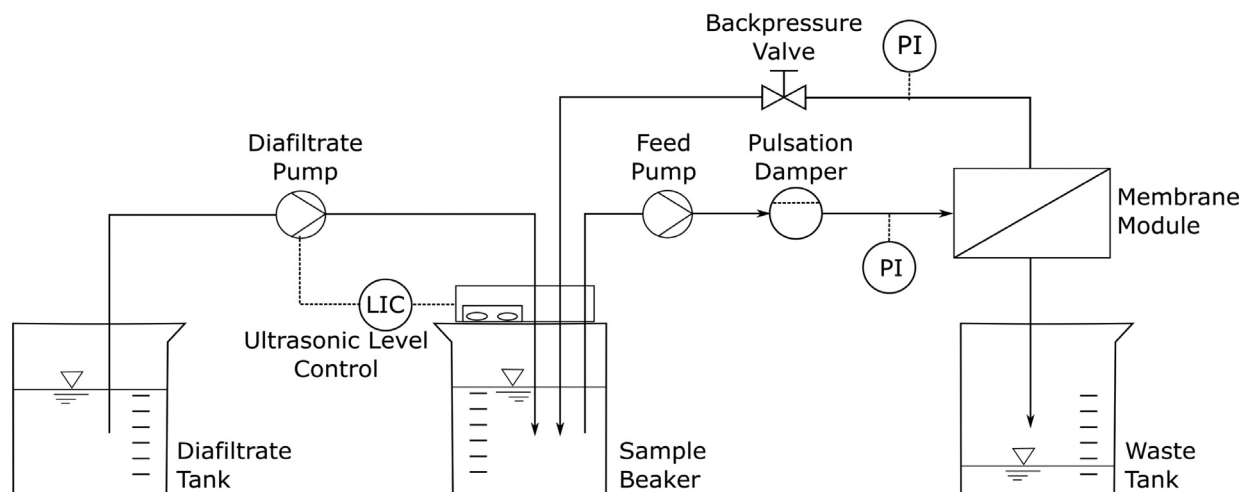

Fig. 1. Piping and instrument drawing of the filtration process.

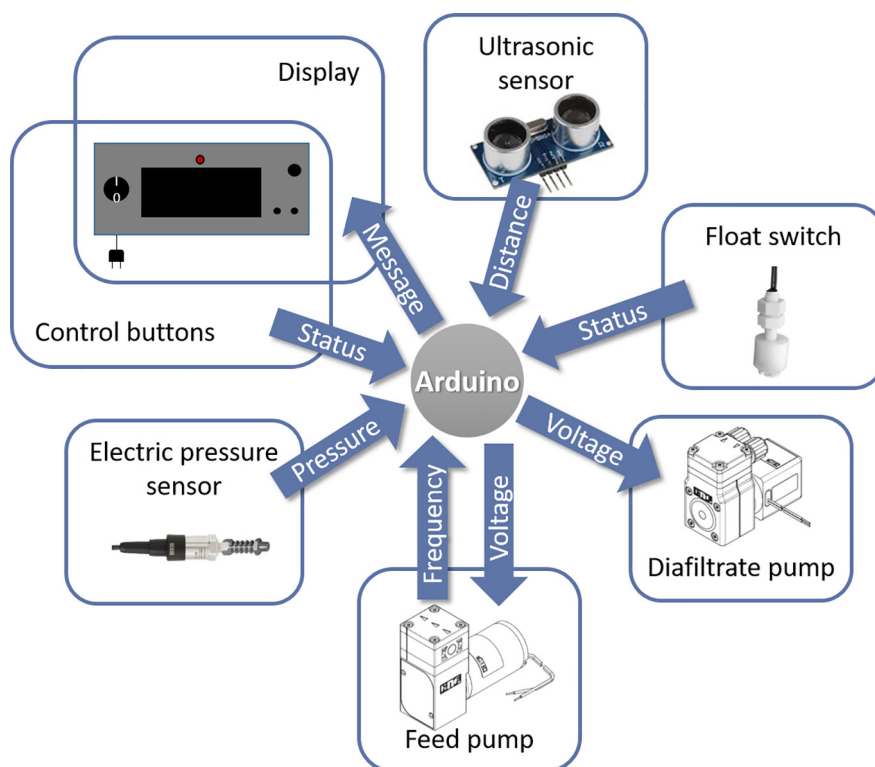

Fig. 2. Electrical components communicating via the Arduino microcontroller.

sensor (327 €) and the float switch (3 €) in the waste tank are integrated as emergency sensors but are not essential for the system's operation.

With a total material price of 2400 €, the device is a low-cost alternative for cross-flow diafiltration applications and simplifies daily lab routine by automation. The reduced costs for investment and consumables allow technology usage, especially in academic research, with the necessity for high flexibility and limited budget. **Possible other applications** of interest are colloid and polymer purification, biochemical protein purification, or microbiological buffer exchange in biotechnological applications.

- *Colloid and polymer purification:* The device separates the product from synthesis residuals such as monomers, linear pre-polymers or low molecular weight side products in the same efficiency as traditional dialysis. It holds the advantage of being faster with less manual work.
- *Biochemical protein purification:* Membrane filtration is a mild mechanical purification step and is therefore well suitable for protein purification. Depending on the synthesis volume, the filtration device can easily be adapted by changing the membrane module and the sample beaker.
- *Microbiological buffer exchange in biotechnology:* Similar to protein purification, buffer exchange for cells and bacteria also require mild conditions. Therefore, diafiltration with low transmembrane pressure is ideally suited for buffer exchange. The diaphragm feed pump installed in the device can be regulated to small flow rates to reduce shear stress.

3. Design files summary

3.1. Mechanical components

The filtration device is assembled on an aluminum profile cage (ITEM GmbH, Profil 5 20 × 20 cm) where all devices and different customized component holder are attached (see Fig. 3 or Filtration_device_assembly.stp). The 3D-printed *electric housing* consists of two parts containing the electrical components, including the circuit board with the Arduino microcontroller, the display, and the control buttons. The *valve holder* is a bent 2 mm steel sheet as holder for the *backpressure valve*. The valve must be assembled upright to ensure stable operation by eliminating bubble deposition inside the valve (see Fig. 3). The *plate top* is a PVC sheet that is holding the analog pressure indicator. The *membrane module holder* is a 3D-

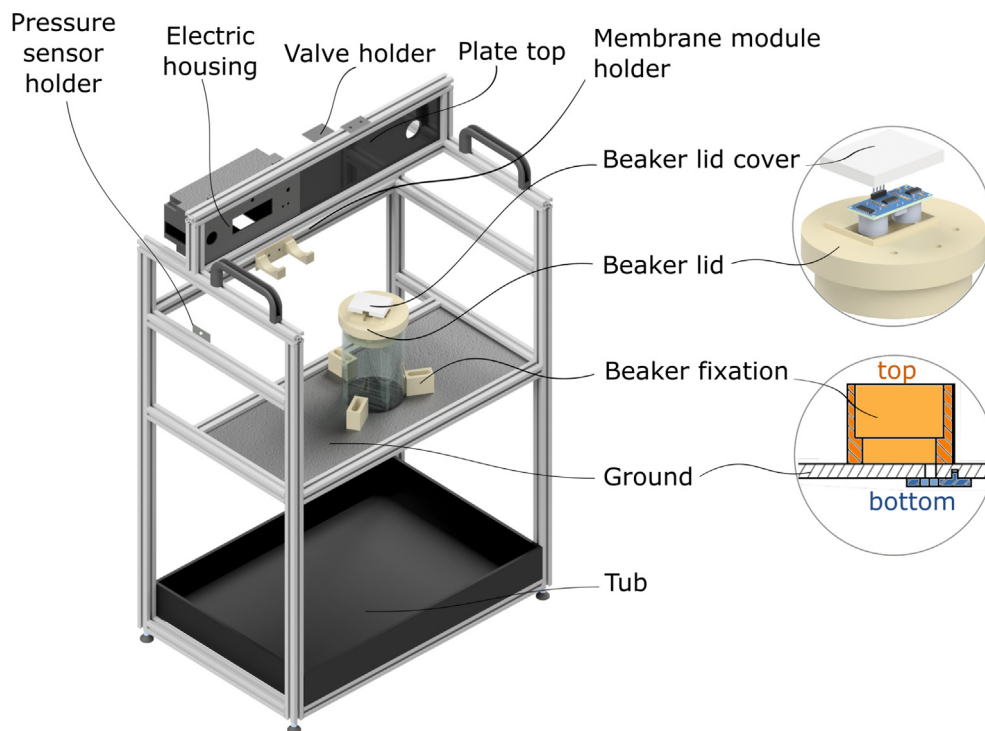

Fig. 3. Rendering of the aluminum cage including all CAD design file items.

printed tray for holding the membrane module in operation. The sample beaker is covered with a *beaker lid* that simultaneously holds the ultrasonic sensor and the three tube connections for feed, retentate, and water. The ultrasonic sensor is additionally covered with the *beaker lid cover* as splash protection. The beaker is fixated using three 3D-printed *beaker fixations* each consisting of a top and bottom part. A screw connects both parts, while the bottom part holds and fixates a screw nut, and the top is movable, enabling adjustments to the beaker diameter. The *ground* is a PVC plate where the *beaker fixations*, the pumps and the damper are positioned (see Fig. 3). The bottom *tub* is made of 1 mm steel sheet and serves as a plate for the water- and waste tank and additionally as spill collection. The *tub* can be pulled out to the front to facilitate the tank exchange. The final mechanical component is the **membrane connection**. This component is not directly built in the device but used as a connector for directly linking the feed and retentate tube to replace the membrane module in the flushing step. See operation instructions (Section 6) for a detailed description.

3.2. Electrical components

The electronic control system of the device is based on an Arduino Nano controller (Fig. 4). It is operated with two buttons and one rotary push encoder and displays one 20×4 LCD display and one LED. The components connected to the controller are two pumps, one ultrasonic sensor, one electric pressure sensor, one float switch and one buzzer (see Fig. 2). The electrical circuit (Fig. 4) is supplied with a 24 Volt plug in power supply preventing any high voltage in the system. A step-down converter supplies the Arduino and the operational amplifier.

The signal of the **pressure sensor** is connected to the A3-pin of the Arduino (0–3.3 V) using a trimmer. The electric pressure sensor signal in the range of 4–20 mA is transferred to the 10-bit Arduino working range of 0–3.3 V, which results at a maximum pressure 2.5 bar in 930 steps with a minimum increment of 2.7 mbar. We use a 2-cable pressure sensor, but the circuit board also allows using a 3-cable sensor with output signals of 0–10 V or 0–20 mA. A second equivalent optional sensor input is added to Pin A2, which is not shown in Fig. 4, but can be found on the complete PCB in the online repository.

The **water pump** can be turned on and off by the D9 pin, and an onboard LED shows its operation. The **feed pump** is regulated by the Arduino D10 pin, such that its pump volume rate can be controlled. Therefore the signal is transferred in an impedance converter with adjustable gain to the pump control voltage of 5 V. Additionally, the rotation speed is back-transferred to the Arduino A1 pin but not used in our software. Similar to the water pump, an onboard LED shines when the pump is running.

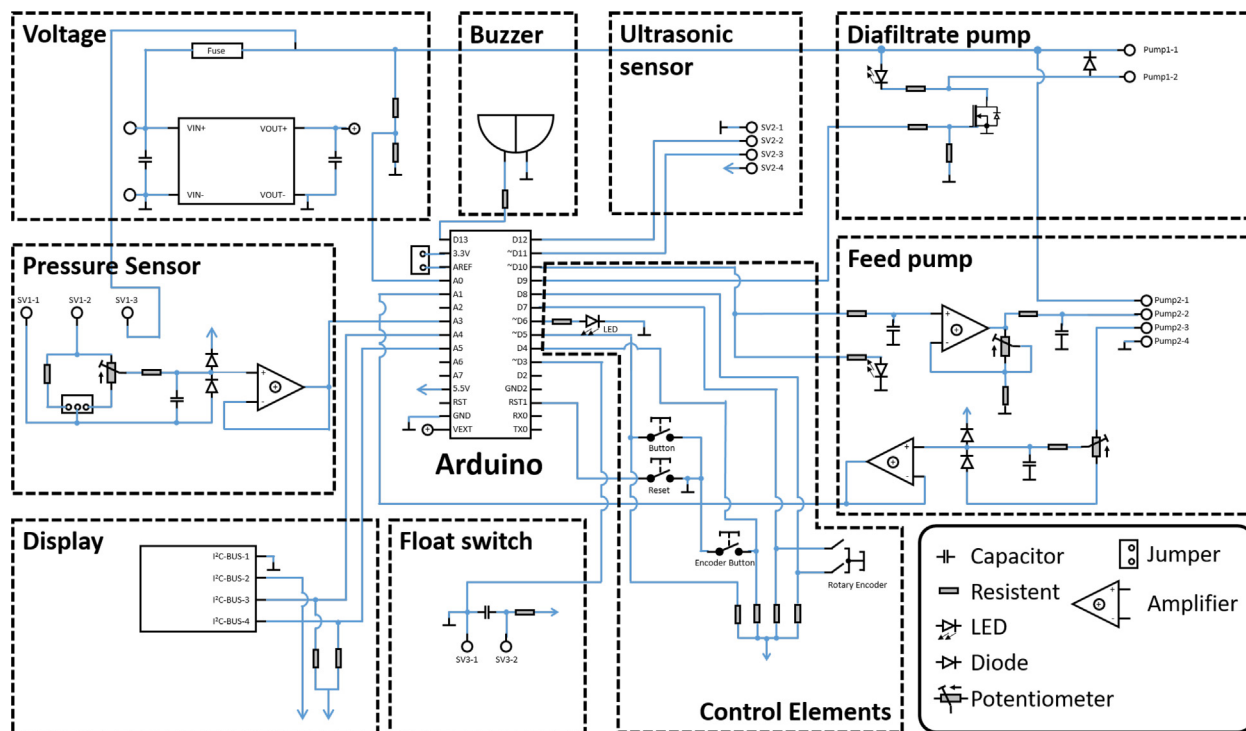

Fig. 4. Electric circuit diagram.

The **ultrasonic sensor** gives the distance from the sensor to the liquid surface in the sample beaker. Using the maximum distance of an empty beaker from calibration, the sample volume is calculated. The **display** is connected via an I2C bus, the **float switch** and the **buzzer** are regularly connected to the Arduino.

3.3. Arduino nano software

The software for running the device is available for an Arduino Nano microcontroller and has four cases shown in Fig. 5. The cases represent the main menu, the settings menu, the manual operation mode, and the error case. The software is available in the [online repository](#). Find a detailed description of the GUI and the software in Section 6.

The software includes an empirical calibration of the electric pressure sensor, which was performed by applying a digital pressure controller (Elveflow OB1+). For other pressure sensors the calibration might be adjusted by changing the corresponding formula in the code (void getPressure line 1129). [Table 1](#).

4. Bill of materials

The Bill of materials in [Table 2](#) only shows a reduced list, including the main components and collections of the smaller components. A complete bill can be found in the online repository. The primary device costs result from the pumps, the back-pressure valve, and the electric pressure sensor.

5. Build instructions

5.1. Electrical control system

For building the electrical control system of the filtration device, a circuit board is ordered and all electrical compounds are attached to the board (see Fig. 4 and the design files of the PCB – PCB_code.brd/ PCB_code.sch/ PCB1/ PCB2). The circuit board is screwed to the 3D-printed electric housing. The two buttons, the rotary push encoder, the LCD display, and the LED are directly connected to the electric housing's respective openings and later assembled to the aluminum cage in one piece.

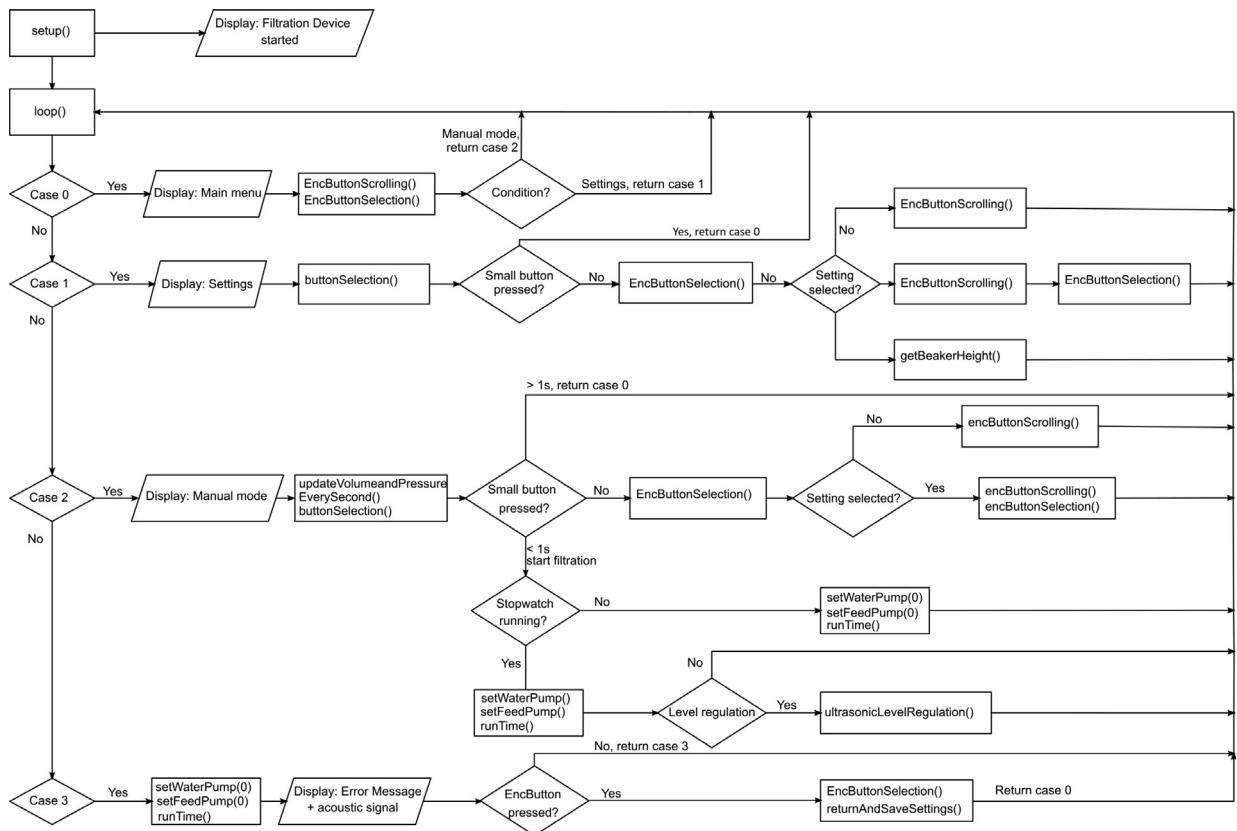

Fig. 5. Simplified software flow-chart showing the main functions of the software. The main loop with 4 cases: main menu (case 0), settings menu where all settings can be set (the settings are not included in the flow chart) (case 1), manual operation mode to control and run the device (case 2), stop pumps in the error case (case 3). The software is available in the [online repository](#).

5.2. Mechanical device fabrication

The mechanical part of the filtration device is assembled as a tabletop device with all components connected to an aluminum cage. The aluminum cage is fabricated by first cutting the 3 m long aluminum profiles (Company: ITEM) to six different lengths (x , y , z , $TopX$, $TopY$, $TopZ$) and assembled as shown in Fig. 6. During assembly the *ground plate* and the *plate top* need to be inserted directly into the furrow of the aluminum profile as shown in Fig. 3.

Afterward, all other mechanical components (pressure sensor holder, electric housing, valve holder, membrane module holder, and beaker fixation) are assembled as shown in Fig. 3. Then, the electric pressure sensor (with *pipe clamp 25 mm*), the back-pressure valve (with valve holder), the membrane module holder, and the assembled circuit board (inside the electric housing) are attached to the cage as shown in Fig. 7 and Fig. 8. The exact positions are not fixed and can be adapted to the purpose.

The water pump, the feed pump, the pulsation damper, and the beaker fixation are screwed onto the ground plate. Therefore, holes need to be drilled at the respective position. The pumps are additionally damped using rubbery dampers (Reichelt SMP 415 A15), one above and one underneath the ground plate (compare with Fig. 8 - pumps) to minimize pulsation transfer to the device. The beaker fixation is connected by one screw and can be adapted by approx. 1 cm to the beaker diameter. A close up of the assembly is shown in Fig. 3 and in Fig. 8 for the component beaker fixation bottom.

The ultrasonic sensor is put in the beaker lid and covered with the beaker lid cover. It holds in place without additional fixation. The float switch is included into the screw cap of the waste tanks by drilling a hole into the cap as seen in Fig. 8 - float switch. The pumps and the other electric sensors (Pressure sensor, ultrasonic sensor, float switch) are afterward connected to the circuit board inside the electric housing.

The loose components, i.e., the tub, the water and waste tank, the sample beaker, and the beaker lid are put into position, and the 4 mm tubing is connected to all components. We chose transparent, green, and blue tubing to distinguish between high pressure tubing (feed), low pressure tubing (retentate), and the non-contaminated water cycle, respectively. The tubing is connected to all components using Landefeld IQS connectors with the respective threads. For connecting the membrane module, we glued the tubing into the membrane module connectors using a 2 component epoxy glue (UHU Schnellfest). The

Table 1

Design file table listing all self built design files including 3D-printed parts, technical drawings of metal parts, PCB files, PCB drawings and the Arduino software. All files are located in the [online repository](#). 3D-printed components are named by their fabrication technology: fused filament fabrication (FFF) or polyjet 3D-printing (Polyjet)

Design file name	File type	Open source license
Filtration_device_assembly.stp	STP CAD file	CC BY-SA 4.0
FFF_Electric_housing.ipt	Autodesk Inventor CAD file	CC BY-SA 4.0
FFF_Electric_housing_cover.stl	STL	CC BY-SA 4.0
FFF_Electric_housing_holder.stl	STL	CC BY-SA 4.0
FFF_Beaker_lid_cover.ipt	Autodesk Inventor CAD file	CC BY-SA 4.0
FFF_Beaker_lid_cover.stl	STL	CC BY-SA 4.0
FFF_Beaker_lid.ipt	Autodesk Inventor CAD file	CC BY-SA 4.0
FFF_Beaker_lid.stl	STL	CC BY-SA 4.0
FFF_Beaker_fixation_top.ipt	Autodesk Inventor CAD file	CC BY-SA 4.0
FFF_Beaker_fixation_top.stl	STL	CC BY-SA 4.0
FFF_Beaker_fixation_bottom.ipt	Autodesk Inventor CAD file	CC BY-SA 4.0
FFF_Beaker_fixation_bottom.stl	STL	CC BY-SA 4.0
FFF_Membrane_module_holder.ipt	Autodesk Inventor CAD file	CC BY-SA 4.0
FFF_Membrane_module_holder.stl	STL	CC BY-SA 4.0
Polyjet_Membrane_connection.ipt	Autodesk Inventor CAD file	CC BY-SA 4.0
Polyjet_Membrane_connection.stl	STL	CC BY-SA 4.0
Workshop_Tub.ipt	Autodesk Inventor CAD file	CC BY-SA 4.0
Workshop_Tub.pdf	PDF technical drawing	CC BY-SA 4.0
Workshop_Valve_holder.ipt	Autodesk Inventor CAD file	CC BY-SA 4.0
Workshop_Valve_holder.pdf	PDF technical drawing	CC BY-SA 4.0
Workshop_Plate_top.ipt	Autodesk Inventor CAD file	CC BY-SA 4.0
Workshop_Plate_top.pdf	PDF technical drawing	CC BY-SA 4.0
Workshop_Pressuresensor_holder.ipt	Autodesk Inventor CAD file	CC BY-SA 4.0
Workshop_Pressuresensor_holder.pdf	PDF technical drawing	CC BY-SA 4.0
Workshop_Ground.ipt	Autodesk Inventor CAD file	CC BY-SA 4.0
Workshop_Ground.pdf	PDF technical drawing	CC BY-SA 4.0
PCB_code.brd	EAGLE Circuit Board File	CC BY-SA 4.0
PCB_code.sch	EAGLE Schematics File	CC BY-SA 4.0
PCB1.jpg	JPG	CC BY-SA 4.0
PCB2.png	PNG	CC BY-SA 4.0
FiltrationDevice.ino	INO arduino file	CC BY-SA 4.0

permeate waste tubing is connected to one shell side of the membrane module, a stopcock is attached, and the tube is inserted into the waste tank by drilling a hole into the cap next to the float switch. The second permeate outlet of the membrane module is closed using a cap. Find images of the details in [Fig. 8](#).

Table 2

Reduced *bill of materials* including the main components and collections of the smaller components. The detailed list of all single components is available in the entire bill of materials in the [online repository](#).

Designator	Component	Number	Cost/EUR	Store	Material type
KNF NF 1.100 IP30 24 V Feed pump	Feed pump	1	577.51	KNF neuberger	Composite
KNF NF 1.60 KPDC water pump	water pump	1	215.15	KNF neuberger	Composite
KNF FPD 1.10 TTZ D1.6	Feed pulsation damper	1	183.02	KNF neuberger	polymer
Pressure transmitter WIKA S20 2.5 bar	Electric pressure sensor	1	481.25	Landefeld	metal
Manometer WIKA Typ 111.12 1.6 bar	Analoge pressure transmitter	1	10.23	Landefeld	Composite
Swagelok Valve KPR1DFC412A20000	Backpressure valve	1	440.11	Swagelok	Composite
Float Switch	Waste container float switch	1	11.20	Reichelt	Composite
Ultrasonic sensor	Ultrasonic sensor for level indic.	1	5.00	Reichelt	Composite
Glas beaker 600 ml d = 90 mm	Sample beaker	1	12.72	VWR	other
Vibration damper	Damper for pumps	16	1.07	Reichelt	Polymer
PE Container 5 l	Waste & water container	2	9.37	Landefeld	Polymer
Membrane connection (polyjet)	Polyjet_Membrane_connection	1	9.66	Stratasys	Polymer
3D-printed parts FFF	collection (see detailed table)	1	14.32	Formfutura	Polymer
Polyflux dialyzer	Membrane module	1	50.00	Baxter	Polymer
Collections:					
ITEM aluminium profiles	Aluminum cage housing	1	171.49	ITEM	Metal
Tubes, connectors	see detailed table	1	100.01	Landefeld	Polymer
Electrical circuit components	Electric circuit and microcontroller	1	69.94	Eckstein/Reichelt	Composite
PVC Plates	Ground plate, Top plate	1	6.59	stock	Polymer
Steel Plates	Valve holder, Pressuresensor holder, Tub	1	0.41	stock	Metal

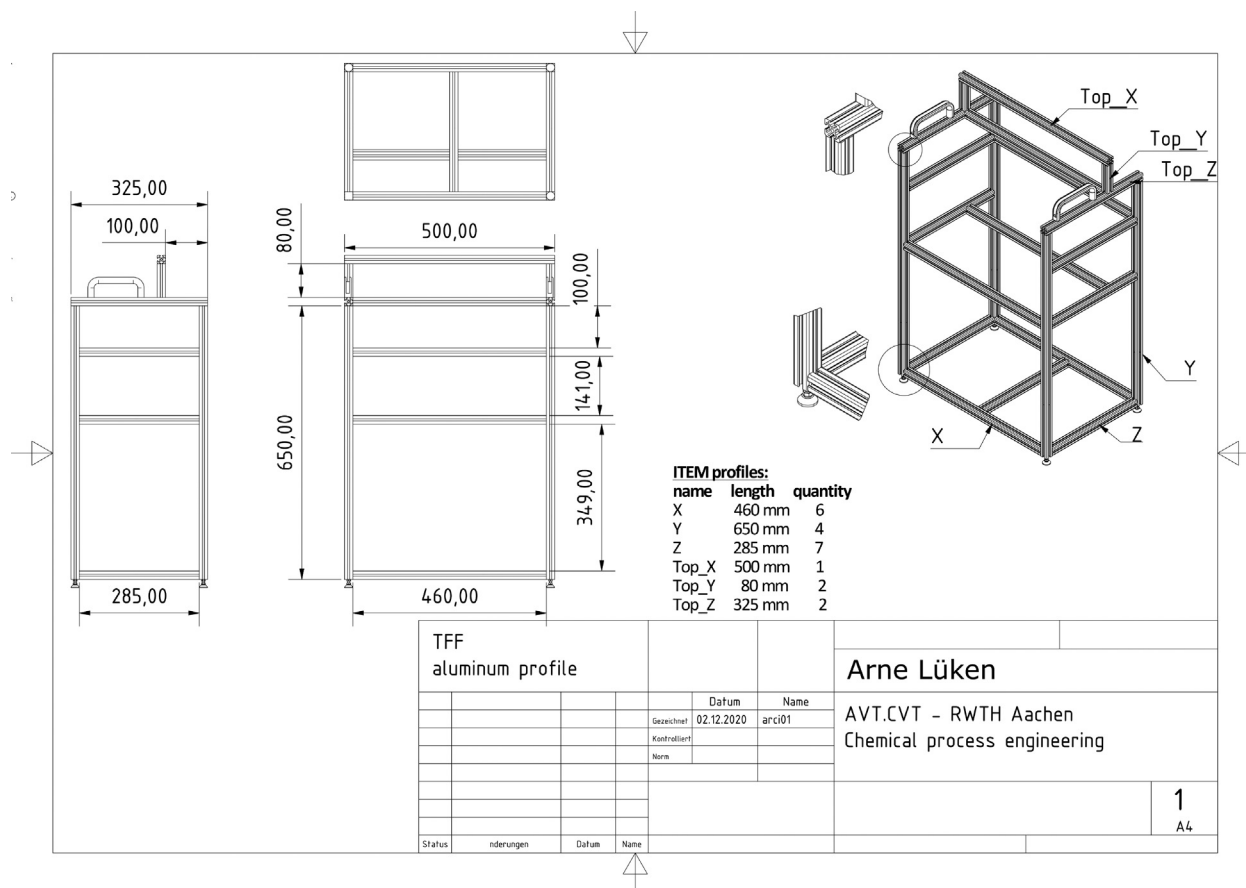

Fig. 6. CAD-drawing of the aluminum cage assembly. Find the high quality image in the [online repository](#).

6. Operation instructions

Table 3 shows a descriptive summary of the functions of the graphical user interface including descriptions of all settings. An exemplary operation instruction for microgel purification via diafiltration is shown in Table 4. The procedure includes the following steps:

- During device **preparation** the membrane module is installed, the microgel solution is filled in the sample beaker, the water tank is filled, and the waste tank is emptied (if necessary).
- **Dilution** needs to be performed if the sample volume is smaller than 100 ml. Operation volumes from 200–400 ml are suggested.
- During **diafiltration** the sample flows tangentially along the membrane, while the transmembrane pressure drives a share of the solvent and smaller molecules through the membrane. Additionally, it refills the sample beaker with pure water, such that the sample volume stays constant. This filtration step is performed until the solution is sufficiently purified. In our example of a 200 ml microgel solution (see Section 7), this took approximately 2 l of permeate and 15 min of filtration using a Baxter Polyflux 6H hemodialysis membrane module. For a 200 ml batch microgel purification, we recommend a minimum of 3 liters of solvent exchange.
- After the filtration step, the solution is **concentrated** to the desired sample volume.
- The **flushing** step is essential to decrease colloidal microgel loss in the membrane module. Microgels accumulate on the membrane surface as a filter cake. Higher permeation rates increase filter cake thickness. As the membrane area of the membrane modules is comparably large (0.2 m² for the 2H module or 0.6 m² for the 6H module), it can be a significant microgels loss in the filter cake, certainly for small sample volumes. In this flushing step, we remove the filter cake from the membrane by suppressing permeation by closing the permeate stopcock and removing the cake by tangential cross-flow flushing. This method was proven in a previous study [21]. Flushing times of 5 min with a maximum feed flow rate are recommended.

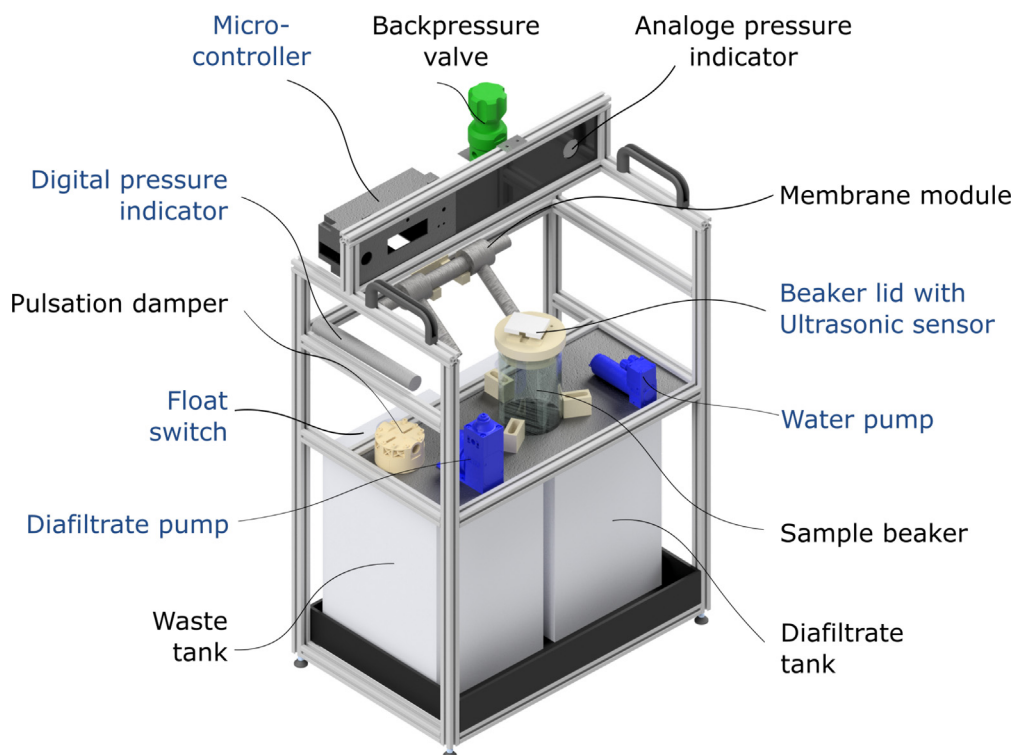

Fig. 7. CAD-drawing of the filtration device assembly with all assembled components without tubing.

- Finally, the microgel solution is removed from the system by pulling the feed tubing out of the sample beaker, such that the pump empties the tubing by pumping air. The sample beaker is then exchanged with a beaker of cleaning agent (10 g/l Edisonite solution), which is subsequently flushed through all components to clean the internal surfaces. Therefore, the short-cut connector is replacing the membrane module such that the membrane might be reused for the same sample. This procedure is repeated with water to remove the cleaning agent. The system is finally stored in dry state.

As operation instruction we additionally recorded a 7 min long operation instruction video, that can be accessed via the [online repository](#).

We distinguish between electrical and mechanical hazards. The system is operated with a commercial power supply with a maximum voltage of 24 V, such that all voltages are lower than 24 V and no electrical hazard occurs. Potential mechanical hazards result from the pressurized parts between the feed pump and the back-pressure valve, including the tubing, the IQS connections, and the membrane module. As pressurized volume is only liquid volume, an explosion is non-problematic, but splashing solutions might occur at leakages. Therefore, appropriate personal protective equipment, including goggles and lab coats, should be worn during operation. Device damages are secured by a software regulated maximum pressure error. This error automatically stops pumps and throws an alert if the feed pressure exceeds 2 bar. Finally, the risk of a fluid spill is prevented by another software error: The system is automatically stopped when the water level in the sample beaker does not rise during the water pump operation. This behavior indicates either an empty water tank or a leakage somewhere in the system, where fluid might be spilled.

7. Validation and characterization

For validating the system, we performed a purification of N-Vinylcaprolactam (VCL) microgels. We analyzed the sample solution's composition by measuring the ¹H-nuclear magnetic resonance (NMR) of samples taken during the filtration process. As described in Section 1, microgels require an extensive purification step after synthesis to remove undesired side products and residuals. Those molecules are significantly smaller than the desired microgels and can be removed using ultrafiltration.

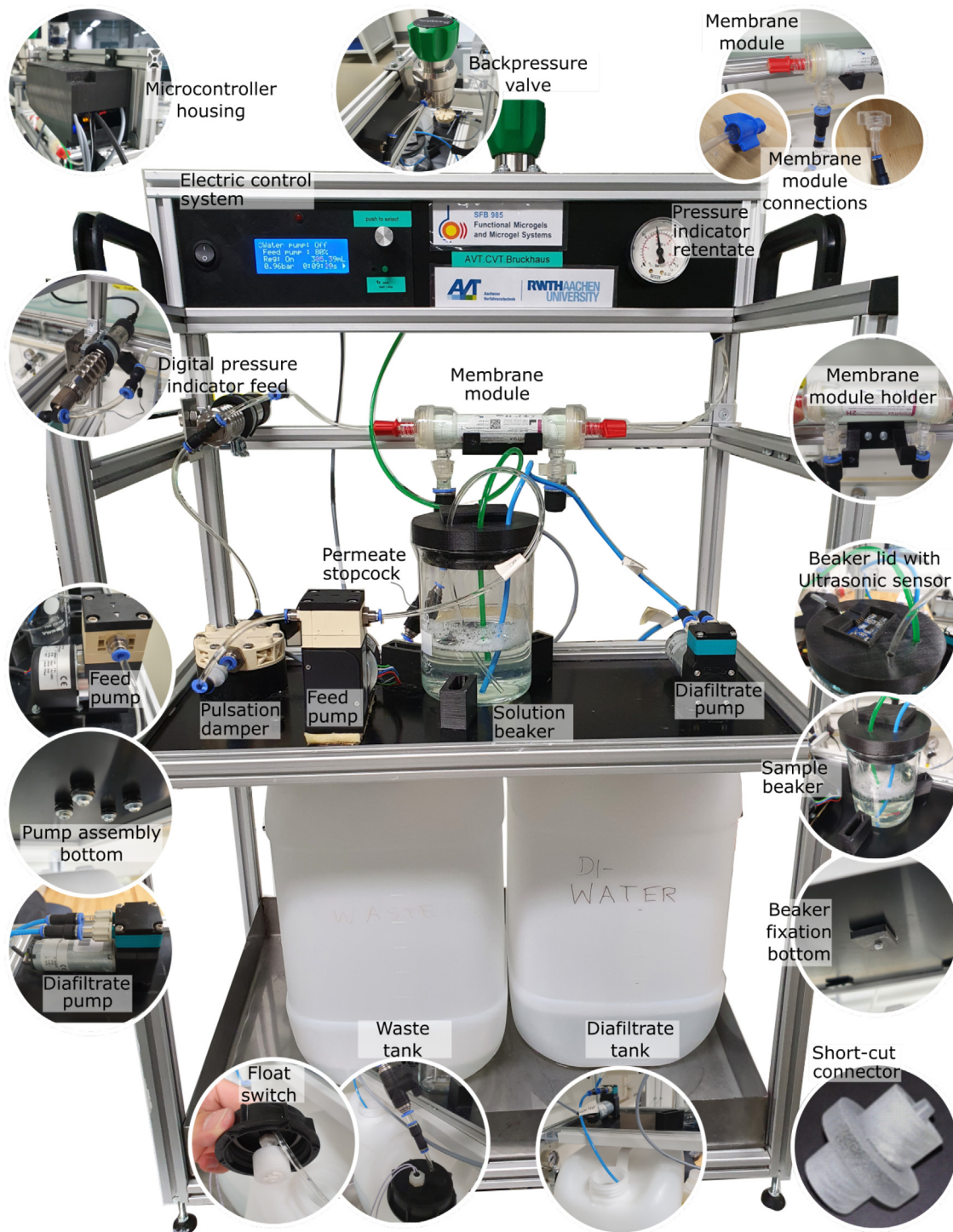

Fig. 8. Image of the filtration device with assembly close-ups of all components.

7.1. Experimental

p-VCL microgels were synthesized using a continuous tube-reactor as described by Wolff et al. [16]. In short, 14.76 g distilled and re-crystallization VCL (98 % Sigma Aldrich) was mixed in 1 L aqueous solution with 0.402 g Cross-linker N,N' -

Table 3
GUI of the electric control system including a description of all settings.

Settings	Water pump	This value sets the initial state of the water pump when opening the operation mode. (ON/OFF)
◊Water Pump : Off	Feed pump	This value sets the initial state of the feed pump when opening the operation mode. (0–100%)
◊Feed Pump : 50%	Level regulation	Initial state of Level regulation when opening operation mode (ON/OFF). Level regulation performs diafiltration and keeps the liquid level constant over time by controls the water pump.
◊Lvl-reg. : Off	Include volume	Considers the additional amount of water in the tubing during level regulation mode.
◊Incl. Volume: Off	Set volume	Sets the additional amount of water in the tubing.
◊Set Volume : 0mL	Max pressure	Sets the maximum pressure value.
◊Max Pressure: 2bar	Diameter	Manual adjustment of beaker diameter.
◊Diameter : 85mm	Height	Manual adjustment of the beaker height.
◊Height : 110mm	Measure Height	Automatic beaker height measurement that is used for volume calculation. It measures height of empty beaker (empty beaker necessary)
◊Measure Height		
Operation mode	Water pump	State of the water pump (ON/OFF)
◊Water Pump: Off	Feed Pump	Power of the feed pump (0–100%)
◊Feed Pump : 50%	Level regulation	Level regulation = diafiltration (ON/OFF)
◊Reg: Off 423.72mL	xx.xx mL	Level indicator (liquid volume in solution beaker)
◊0.0bar 0:00:00s	x.x bar	Feed side pressure
	x:xx:xx s	Filtration time since start. Reset by going to main menu.
	> 	Start/pause indicator of the process (push small button to start and pause)

Table 4
Exemplary operation instruction for microgel purification via diafiltration.

Preparation		Empty waste tank. Refill diafiltrate tank to minimum of 4 L with DI-Water. Install membrane module between feed and retentate connection. Connect permeate connection /-stopcock to shell side. Connect the cap to the other shell side connection. Fill microgel solution in solution beaker and cover with lid. Submerge feed, retentate and diafiltrate tubing in beaker.
Dilution Only necessary for small sample volumes	Water pump ON Feed Pump 0% Level Regulation OFF	Start the device. Dilute sample by pumping diafiltrate in the solution beaker. Run device until you reach a liquid level of 200-400 mL.
Diafiltration Purification of Sample	Water pump ON/OFF Feed Pump 50% Level Regulation ON	Open the permeate stopcock. Adjust the back-pressure valve during operation to $p = 0.8 - 1$ bar. Solvent is exchanged with fresh DI-water Operate until min. 3 liters of DI-water is exchanged.
Concentration	Water pump OFF Feed Pump 50% Level Regulation OFF	Remain permeate stopcock open. Operate device until required concentration is achieved.
Flushing End of purification	Water pump OFF Feed Pump 100% Level Regulation OFF	Close permeate stopcock. Filter cake removal by cross-flow flushing. Slight foaming can occur. Flush tubing with air by taking feed tube out of solution.
Cleaning	Water pump OFF Feed Pump 100% Level Regulation OFF	Exchange membrane module with short-cut connector. Exchange microgel solution with 400ml of 10g/L Edisonide solution. Run device until solution tank is emptied. Repeat cleaning procedure with DI-water.

methylenebis(acrylamide) (BIS) (99 %, Sigma–Aldrich) and 0.222 g surfactant hexadecyltrimethylammonium bromide (CTAB) (≥ 97 %, Merck). 0.883 g Initiator 2,2-azobis(2-methylpropanimidine) dihydrochloride (AMPA) (97 %, Sigma–Aldrich) was dissolved in an second 50 ml aqueous solution. The two solutions were fed continuously into the tubular reactor using a syringe pump (Harvard PHD ULTRA) for the 50 ml solution and a gear pump (Ismatec MCP-Z) for the 1000 ml solution. The two solutions were mixed in a static mixer before entering the reactor. The reactor was heated to 70° C, and the reaction time is set to 300 s by controlling the pumps' flowrates. The synthesis brew is directly used for the filtration process without previous purification.

Filtration is performed using 200 ml of the synthesis brew as sample volume. The filtration device is equipped with a Baxter Polyflux 6H dialyzer membrane module with a membrane area of 0.6 m² and operated with a feed pump rate of 100 % at a feed pressure of 0.4 bar resulting in an average permeate flow rate of 0.175 L/min. The filtration process was performed for 1 h, resulting in a total permeate volume of 10.5 L. During the filtration process, eight samples were taken from the sample beaker at different times to get a temporal resolution of the concentration of linear pre-polymers in the sample.

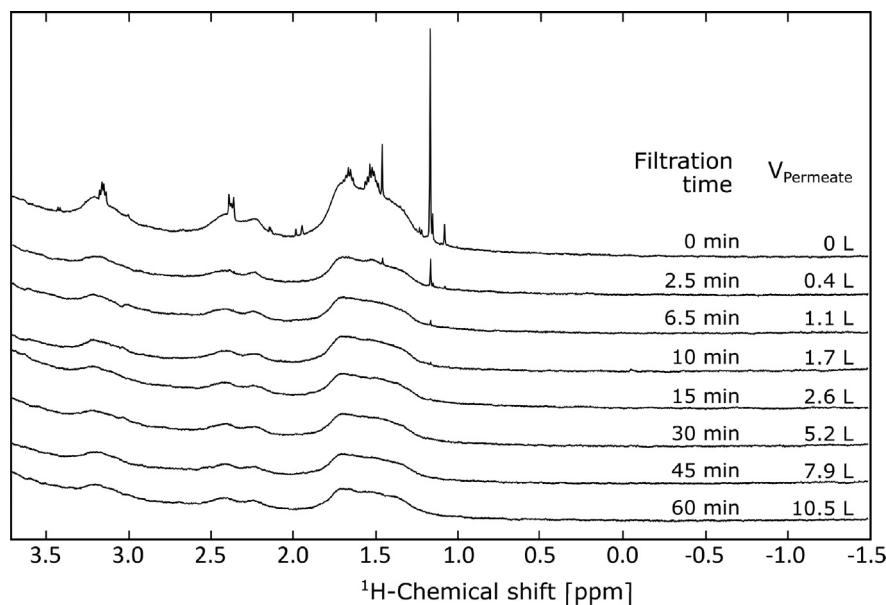

Fig. 9. NMR data of the microgel solution samples during the filtration at different filtration times and the respective permeate volumes.

The samples were analyzed using **NMR**. All samples were measured on a Bruker Avance III 400 spectrometer operating at ^1H frequency of 400.17 MHz. One ml of each sample taken during the filtration is mixed with 20 vol.% of deuterium oxide (D_2O) (99.9 %, Sigma–Aldrich).

7.2. Results and discussion

Fig. 9 shows the NMR data from different filtration times. The microgels show broad peaks due to the slow molecular motion that leads to dipolar broadening. The narrow peaks can be assigned to small molecules (linear chains, other organic residues) that should be removed during filtration. After 15 min of filtration and an exchanged permeate volume of 2.6 liters, the narrow peaks disappeared, confirming that a purification occurred. The permeate volume linearly depends on the membrane area in the respective module, such that the Baxter 2H membrane module with 0.2 m^2 of membrane area will take triple time for the same outcome.

During the process, microgels accumulate inside the module on the membrane surface as monolayer and filter cake. We remove a share of these microgels in the post purification cross-flow flushing step. However, due to irregular flows between the hollow fibers, it is not expected to clean the whole membrane area. Accordingly, in this system, we have a microgel loss inside the membrane module. This microgel-loss is evaluated by performing another experiment filtrating a purified 200 ml pVCL solution with a concentration of 2.7 g/L. After 20 min of diafiltration using a Baxter 6H module, we reached a concentration of 1.6 g/L. Thus, we lost approximately a total mass of 0.22 g microgels on a membrane area of 0.6 m^2 . This loss mainly affects small sample volumes with small concentrations because it only correlates to the membrane area and not to the sample concentration and sample volume. The membrane module should be selected appropriately for the filtration task.

8. Summary

The ultrafiltration device presented here opens the technology of tangential-flow diafiltration to polymer science research labs by reducing investment and operational costs. The technology outstands the existing state of the art purification technologies like dialysis or ultracentrifugation in terms of costs, time, and manual effort. The system is designed for simple operation using a graphical user interface and broad applicability in the lab. Depending on the application, the device costs can be further reduced by choosing cheaper pumps (e.g. less solvent resistant materials) and leaving out the electric pressure sensor. Skipping the pulsation damper is not recommended, as it will result in inaccurate pressure readout and high pressure-peaks that might damage the membranes.

Declaration of Competing Interest

The authors declare that they have no known competing financial interests or personal relationships that could have appeared to influence the work reported in this paper.

Acknowledgements

The authors wish to acknowledge support via the Deutsche Forschungsgemeinschaft through the collaborative research center SFB 985 “Functional microgels and microgel systems”. Part of the work was performed at the Center for Chemical Polymer Technology CPT, which is supported by the EU and the federal state of North Rhine-Westphalia (Grant No. EFRE 30 00 883 02). M.W. acknowledges DFG funding through the Gottfried Wilhelm Leibniz Award 2019 (WE 4678/12–1). The authors thank the mechanical workshop at AVT and Alexander Schrade and for supporting the assembly and maintenance of the filtration device.

References

- [1] Richard W. Baker. *Membrane technology and applications*. J. Wiley, Chichester and New York, 2nd ed. edition, 2004..
- [2] Robert Rautenbach, Thomas Melin, *Membranverfahren*, Springer, Berlin, Germany, 2004.
- [3] Teresa Musumeci, Antonio Leonardi, Angela Bonaccorso, Rosario Pignatello, Giovanni Puglisi, *Tangential flow filtration technique: An overview on nanomedicine applications*, *Pharmaceut. Nanotechnol.* 6 (1) (2018) 48–60.
- [4] Arunima Saxena, Bijay P. Tripathi, Mahendra Kumar, Vinod K. Shahi, *Membrane-based techniques for the separation and purification of proteins: an overview*, *Adv. Colloid Interface Sci.* 145 (1–2) (2009) 1–22.
- [5] Frederike Carstensen, Andreas Apel, Matthias Wessling, *In situ product recovery: Submerged membranes vs. external loop membranes*, *J. Membr. Sci.* 394–395 (2012) 1–36.
- [6] T. Wintgens, T. Melin, A. Schäfer, S. Khan, M. Muston, D. Bixio, C. Thoeue, *The role of membrane processes in municipal wastewater reclamation and reuse*, *Desalination* 178 (1–3) (2005) 1–11.
- [7] Yoshinobu Tanaka, Koichi Ogawa, and Minoru Hioka. *Plate type fluid treatment apparatus*. United States Patent, -(4,310,416), 1982..
- [8] Bernhard Diel. *Device and assembly for crossflow filtration*. United States Patent, -(US 6,929,743 B2), 2005..
- [9] Martin Morrissey and Dennis Wong. *Disposable tangential flow filtration liner with sensor mount*. United States Patent, -(US 8,454,822 B2), 2013..
- [10] Martin Leuthold, Ulrich Grummert, and Peter Schmidt. *Crossflow filtration unit for continuous diafiltration*. United States Patent, -(US 2019/ 0030486 A1), 2019.
- [11] Claudio Ronco, Carlo Crepaldi, Alessandra Brendolan, Luisa Bragantini, Vincent d'Intini, Paola Inguaggiato, Monica Bonello, Bernd Krause, Reinhold Deppisch, Herman Goehl, Andrea Scabardi, *Evolution of synthetic membranes for blood purification: the case of the Polyflux family*, *Nephrology Dialysis Transplantation* 18 Suppl 7: vii10–20, <https://doi.org/10.1093/ndt/gfg1073>.
- [12] William G. Couser, Giuseppe Remuzzi, Shanthi Mendis, Marcello Tonelli, *The contribution of chronic kidney disease to the global burden of major noncommunicable diseases*, *Kidney Int.* 80 (12) (2011) 1258–1270.
- [13] Adriana Boschetti-de Fierro, Manuel Voigt, Markus Storr, Bernd Krause, *Extended characterization of a new class of membranes for blood purification: the high cut-off membranes*, *Int. J. Artif. Organs* 36 (7) (2013) 455–463.
- [14] Christopher J. Yehl, Andrew L. Zydney, *Single-use, single-pass tangential flow filtration using low-cost hollow fiber modules*, *J. Membr. Sci.* 595 (3) (2020) 117517.
- [15] Felix A. Plamper, Walter Richtering, *Functional microgels and microgel systems*, *Accounts Chem. Res.* 50 (2) (2017) 131–140.
- [16] Hanna J.M. Wolff, Michael Kather, Hans Breisig, Walter Richtering, Andrij Pich, Matthias Wessling, *From batch to continuous precipitation polymerization of thermoresponsive microgels*, *ACS Appl. Mater. Interfaces* 10 (29) (2018) 24799–24806.
- [17] Tharwat F. Tadros, *Microgel Suspensions: Fundamentals and Applications*, Wiley-VCH, Weinheim, 2011.
- [18] Joanna B. Thorne, George J. Vine, Martin J. Snowden, *Microgel applications and commercial considerations*, *Colloid Polym. Sci.* 289 (5–6) (2011) 625–646.
- [19] M. Wiese, O. Nir, D. Wypyssek, L. Pokern, M. Wessling, *Fouling minimization at membranes having a 3d surface topology with microgels as soft model colloids*, *J. Membr. Sci.* (2018).
- [20] Oded Nir, Tony Trieu, Sebastian Bannwarth, Matthias Wessling, *Microfiltration of deformable microgels*, *Soft matter* 12 (31) (2016) 6512–6517.
- [21] Arne Lüken, John Linkhorst, Robin Fröhlingsdorf, Laura Lippert, Dirk Rommel, Laura de Laporte, Matthias Wessling, *Unravelling colloid filter cake motions in membrane cleaning procedures*, *Sci. Rep.* 10 (1) (2020).
- [22] Rafael Roa, Emiliy K. Zholkovskiy, Gerhard Nägele, *Ultrafiltration modeling of non-ionic microgels*, *Soft Matter* 11 (20) (2015) 4106–4122.
- [23] Gun Woo Park and Gerhard Nägele, *Modeling cross-flow ultrafiltration of permeable particle dispersions*, *J. Chem. Phys.* 153 (20) (2020) 204110.