

Henry Ford Health

Henry Ford Health Scholarly Commons

Otolaryngology Meeting Abstracts

Otolaryngology - Head and Neck Surgery

10-1-2021

Assessing Oral Intake Outcomes in Head and Neck Cancer Patients Treated with Definitive Radiation with or Without Chemotherapy

Ricardo Engel

Henry Ford Health, rengel1@hfhs.org

Patrick Etta

Henry Ford Health, petta1@hfhs.org

Talha Gahzi

Amy M. Williams

Henry Ford Health, AWilli50@hfhs.org

Suhael R. Momin

Henry Ford Health, smomin1@hfhs.org

See next page for additional authors

Follow this and additional works at: https://scholarlycommons.henryford.com/otolaryngology_mtgabstracts

Recommended Citation

Engel R, Etta P, Gahzi T, Williams A, Tam S, Momin S, Chang S, Ghanem T, Walker D, Siddiqui F, Ali H, Wu V, Sheqwara J, and Carlson M. Assessing Oral Intake Outcomes in Head and Neck Cancer Patients Treated with Definitive Radiation with or Without Chemotherapy. *American Journal of Clinical Oncology-Cancer Clinical Trials* 2021; 44(10):S81-S81.

This Conference Proceeding is brought to you for free and open access by the Otolaryngology - Head and Neck Surgery at Henry Ford Health Scholarly Commons. It has been accepted for inclusion in Otolaryngology Meeting Abstracts by an authorized administrator of Henry Ford Health Scholarly Commons.

Authors

Ricardo Engel, Patrick Etta, Talha Gahzi, Amy M. Williams, Suhael R. Momin, Steven S. Chang, Tamer Ghanem, Diana Walker, Farzan Siddiqui, Haythem Y. Ali, Vivian Wu, Jawad Z. Sheqwara, and Megan Carlson

Proceedings of the American Radium Society®'s 103rd Annual Meeting

ORAL ABSTRACTS

(OA01) Interleukin-15 Rescues Radiation Related Lymphopenia and Improves Tumor Control Outcomes in Pancreatic Cancer

Bhanu Prasad Venkatesulu, MD¹, Cheng Cheng-En Hsieh, MD², Byung Kyu Kim, PhD², Keith L. Sanders, BS², Amrisha Sharma, PhD², Pankaj Kumar Singh, PhD³, Sunil Krishnan, MD⁴; ¹Loyola University Chicago, ²MD Anderson Cancer Centre, ³Mayo Clinic, Jacksonville, ⁴Mayo Clinic, Jacksonville

Background: There have been recent reports on the association between radiation related lymphopenia and survival outcomes in solid tumors. Depletion of the circulating lymphocytes during the course of radiation has been reported to cause inferior overall survival outcomes in gliomas, head and neck squamous cell carcinoma, nasopharyngeal cancer, lung cancer, esophagus, hepatocellular carcinoma, pancreatic cancer as well as cervical cancer. The radiation dose to the circulating lymphocyte population when the lymphocytes traverse the radiation portal as well as unintended dose to primary and secondary lymphoid organs were postulated as the reasons for the lymphocyte depletion. This RT related lymphocyte depletion not only mitigates the beneficial effect of RT but as well as reduces the effectiveness of T cell based immunotherapeutic agents like checkpoint inhibitors and adoptive T cell transfer.

Objectives: 1. To understand the alterations in the lymphocyte and cytokine kinetics in peripheral blood samples of patients with locally advanced pancreatic cancer who underwent definitive chemoradiation as part of a prospective phase 2 trial 2. Create radiation related lymphopenia murine pancreatic cancer models 3. Devise rescue agents of radiation related lymphopenia and assess if tumor control outcomes are improved with enhancing lymphocyte population 4. Assess which subgroup of lymphocyte populations are responsible for improvement in tumor control outcomes.

Methods: We analyzed the severity of lymphopenia, mean splenic dose, lymphocyte subpopulations (CD3, CD45, CD4, CD8, PD-1, Foxp3, Ki-67, CTLA-4 and the level of cytokines (IL-2, IL-6, IL-10, IL-7, IL-15, and TNF-alpha) in a cohort of 20 pancreatic cancer patients undergoing conventional 50.4 Gy in 28 fractions intensity modulated radiation therapy (IMRT) for locally advanced pancreatic (LPAC) as part of a phase 2 clinical trial. Based on our clinical findings, we also designed a model of radiation induced lymphopenia through splenic irradiation in mice and assessed the lymphocyte subpopulation dynamics in peripheral blood and its impact on murine xenograft pancreatic tumors. We also devised potential rescue strategies to see if T lymphocyte homeostatic cytokines Interleukin-15 (IL-15) 7.5 ug for 7 days and Interleukin-7 (IL-7) 10 ug for 7 days supplemented to mice that had radiation related lymphopenia could have its lymphopenia rescued and the tumor outcomes could improve. In addition, we tested the efficacy of IL-15 super agonist which has a longer half-life than IL-15 as lymphorepletion agent and its impact on primary tumor as well as secondary non-irradiated tumor in murine pancreatic cancer models.

Results: Twenty patients with locally advanced pancreatic cancer were enrolled as part of a single arm phase 2 clinical trial. All patients received 50.4 Gy in 28 fractions of IMRT with concurrent daily capecitabine and weekly nab-paclitaxel on days 1, 8, 15, 22, and 29 for a total duration of 5-6 weeks. The mean splenic dose for severe lymphopenia (grade 3, 4) was 4.92 Gy compared with 1.52 Gy in mild lymphopenia arm (grade 1, 2). The following cytokines IL-2, IL-6, IL-7, IL-15 and TNF-alpha were analyzed and homeostatic T cell cytokines IL-7, IL-15 fail to increase in patients with severe lymphopenia compared with elevation of IL-7 in patients with mild lymphopenia. Analyses of the frequencies of T cells from the peripheral blood shows that the patients who had higher mean splenic doses (4.92 Gy) compared with lower splenic doses (1.52 Gy) had significant depletion (P value < 0.05) of CD3+ T cells (17.30% vs 40.80%), CD4+ T cells (11.87% vs 27.88%), CD8+ T cells (0.16% vs 0.52%) at week 1; CD3+ T cells (19.28% vs 29.84%), CD4+ T cells (13.87% vs 27.86%), CD8+ T cells (0.23% vs 0.98%) at week 5. We tested IL-7 and IL-15 in C57BL6 murine pancreatic cancer models. The tumors were irradiated to a dose of 10 Gy in 5 fractions over 5 days and the spleen was irradiated to 5 Gy in 5 fractions over 5 days with Philips 250 Kv orthovoltage irradiator. Splenic irradiation compromises the tumor control outcomes provided by radiation. IL-15 was administered intra-peritoneally 24 hours post radiation 7.5 ug per day for 7 days IP and IL-7 was administered intra-peritoneally 24 hours post radiation 10 ug per day for 7 days. Treatment with IL-15 induced complete primary tumor regression in 75% of the treatment group whereas IL-7 did not induce complete primary tumor regression in any mice. IL-15 increased cytotoxic CD8 T cell and natural killer cell infiltration into tumors and peripheral blood. IL-15 rescued the lymphopenia induced by radiation by increasing the circulating lymphocyte populations as well as by enhancing lymphocyte infiltration into the tumor as well as the residential lymphocytes in the spleen. IL-15 super agonist which has a longer half-life and ease of administration was tested. IL-15 super agonist 4 ug per mice was administered 24 hours after radiation delivery for 2 doses one week apart. IL-15 super agonist supplementation in lymphodepleted mice enhances the tumor control at the primary site as well as the secondary non-irradiated ascopal site.

Conclusions: Our results show that lymphopenia is a common accompaniment of pancreatic cancer treatment with radiation being the prime contributor and lymphopenia correlates with suboptimal tumor control outcomes. The mean splenic dose correlates with the severity of lymphopenia and the main lymphocyte subpopulations that are depleted are CD3, CD4, CD8 lymphocyte populations. Though IL-7 supplementation rescued CD4 counts, the reconstitution did not have a tangible effect on the tumor control outcomes in murine pancreatic cancer models. These results add further strength to the notion that CD8 T cells play an important role in immunological cell death of pancreatic tumor and the reconstitution of the CD8 cells with IL-15 not only increases the lymphocyte count but improves tumor control outcomes. Our experiments provide impetus for design of clinical trials for use of IL-15 or IL-15 super agonist as an adjuvant therapy to rescue T cells and to further augment the benefit of radiation in pancreatic cancer (Figs. 1-3).

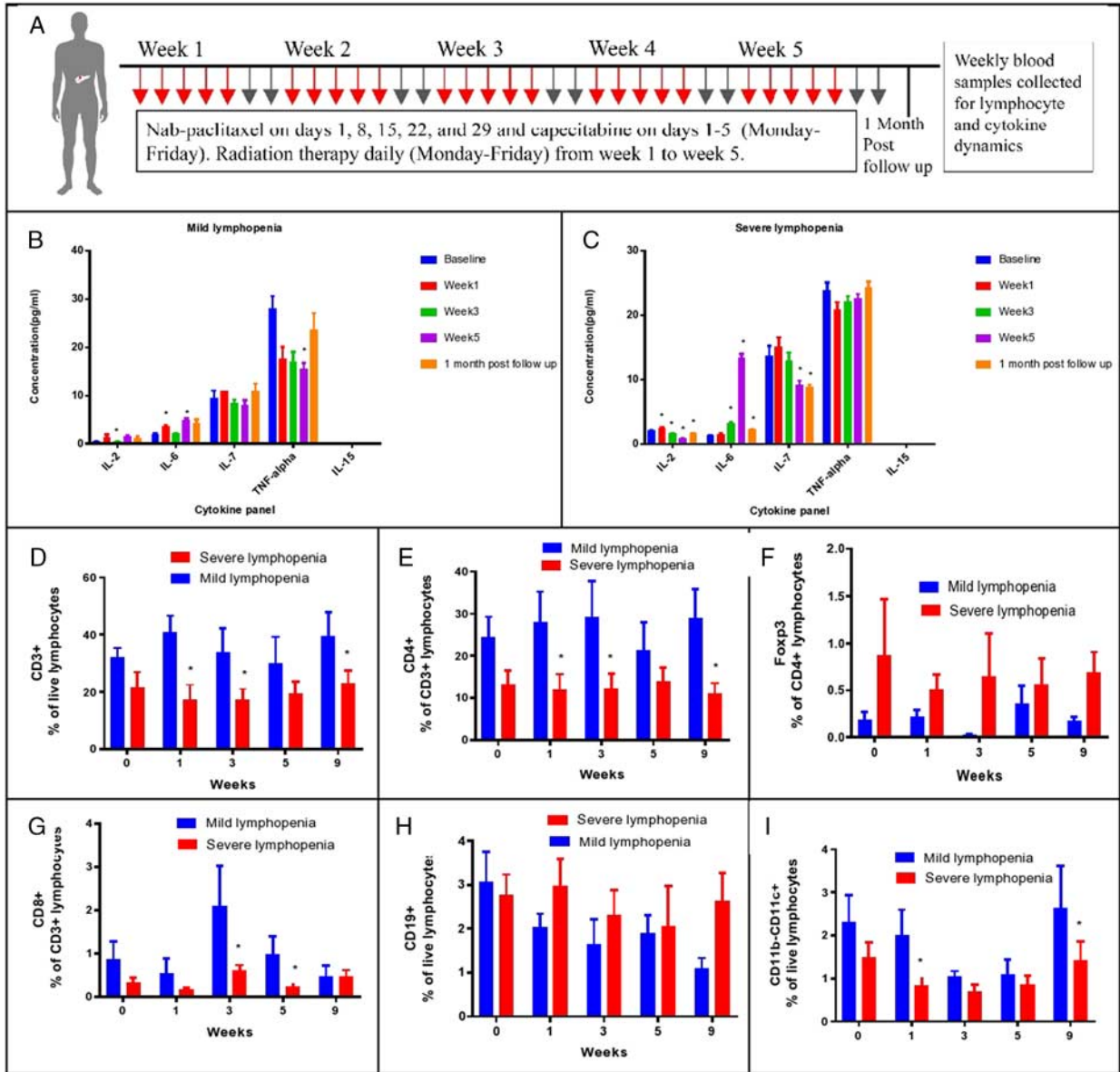

FIGURE 1. Radiation of 50.4 Gray in 28 fractions given over 5.5 weeks in combination with capecitabine 825 mg/m² (Monday to Friday) and nab-paclitaxel IV over 30 minutes on days 1, 8, 15, 22, and 29 in locally advanced pancreatic cancer leads to lymphopenia and causes distinct alterations in the cytokine levels in peripheral blood at baseline, week 1, week 3, week 5 and follow up after completion of one month of treatment. (A) Illustrative summary of the design of the phase I clinical trial. The figures show the cytokine levels IL-2, IL-6, IL-7, IL-15, TNF-alpha in mild lymphopenia group (B) and severe lymphopenia group (C), percentage of CD3+ T cells (D), percentage of CD4+ T cells (E), percentage of FOXP3+ cells (F), percentage of CD8+ T cells (G), percentage of CD19+ cells (H), percentage of CD11b-11C+ cells (I). Data are represented as means ± SEM (n=20 patients). Statistical significance was assessed by unpaired T test; *, P < 0.05; **, P < 0.005; ***, P < 0.0005; ns-not significant.

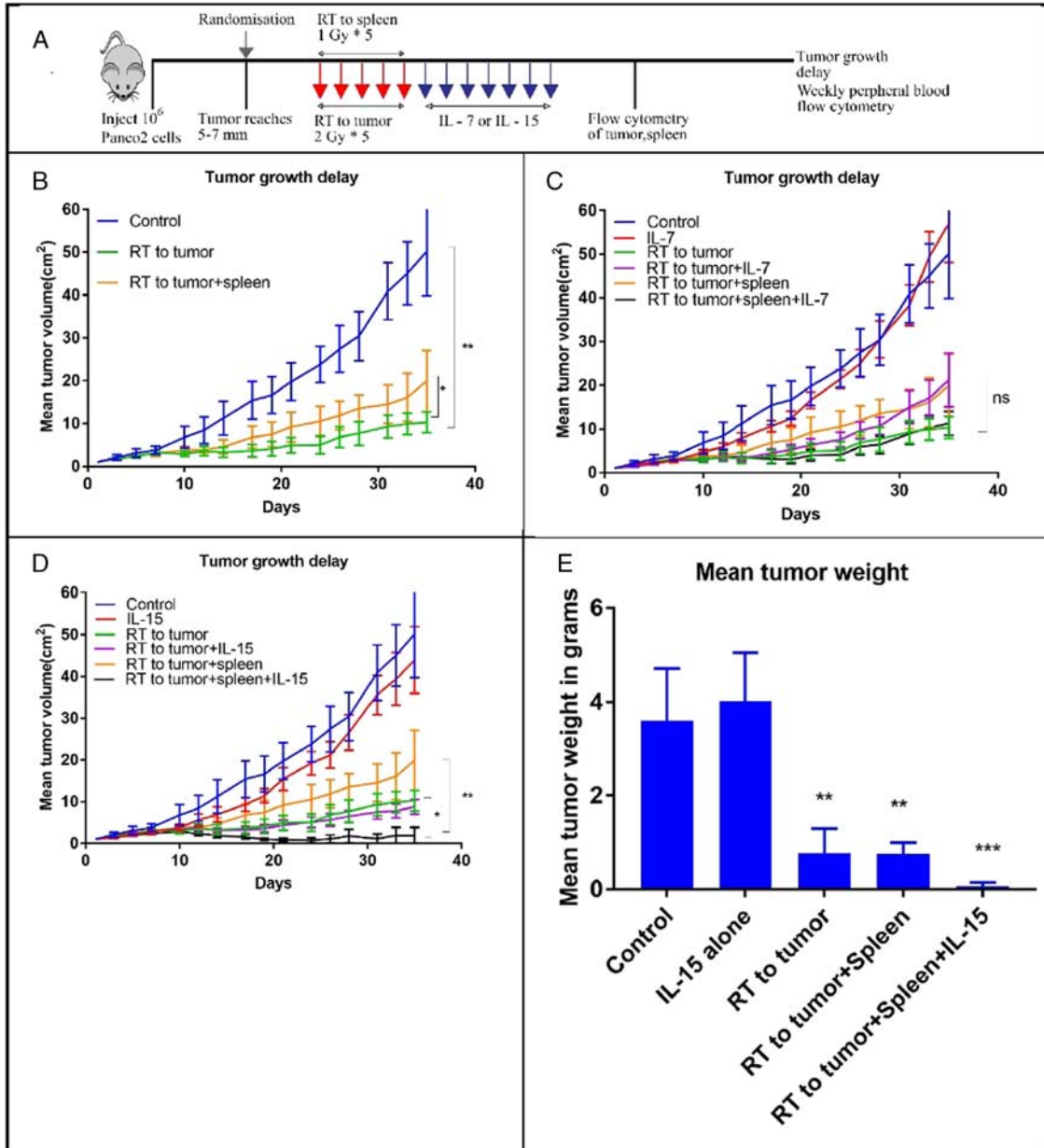

FIGURE 2. Interleukin-15 rescues radiation induced lymphopenia and enhances tumor control outcomes in murine Pancreatic cancer xenograft models. (A) Experimental schema (B) shows the tumor growth delay curves when spleen is irradiated (C) shows that Interleukin-7 doesn't improve tumor control outcomes (D) shows that IL-15 rescues the inferior tumor control that occurs with incidental splenic radiation (E) shows mean tumor weights. Unpaired T test with Welch's correction was used to assess significance between the tumor growth delay groups; *, $P < 0.05$; **, $P < 0.005$; ***, $P < 0.0005$; ns-not significant. (Each group had mice $n = 8-10$ per group).

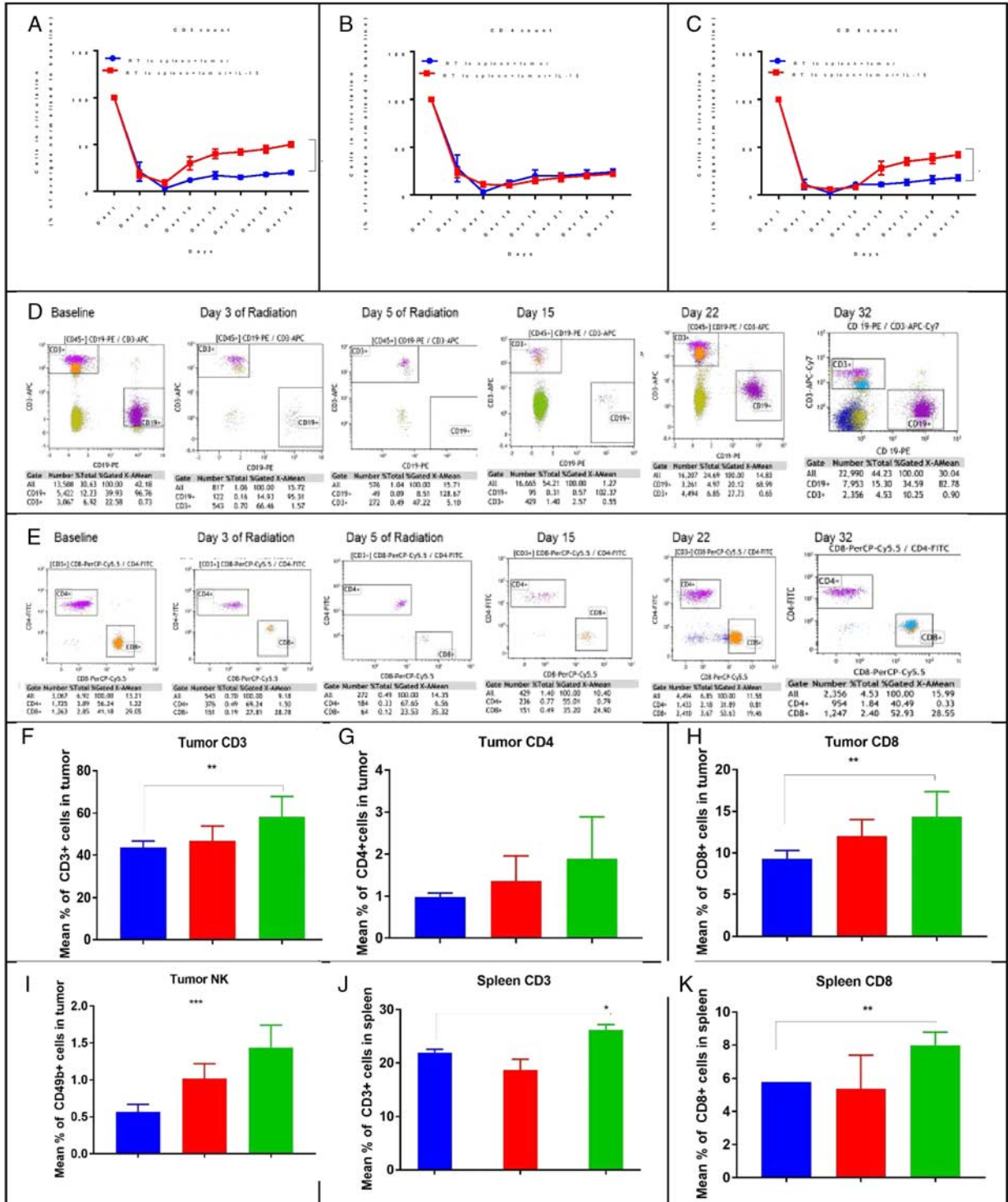

FIGURE 3. Serial assessment of the peripheral blood lymphocyte subpopulations in mice bearing Panco2 xenograft tumor models in right thigh show that Interleukin-15 (A) and (C) increases circulating CD3+ T cells and CD8+ T cells with no impact on (B) CD4+ T cells. (D) representative flow cytometry figures that show alterations in CD3 and CD19 populations during the course of radiation from day 1-to day 5 and after IL-15 rescue from day 6 to day 13 and follow up till day 32. (E) representative flow cytometry figures that show alterations in CD8 and CD4 populations during the course of radiation from day 1-to day 5 and after IL-15 rescue from day 6 to day 13 and follow up till day 32. Tumors and spleen were harvested on day 15 and the isolated tumor infiltrating lymphocytes and splenocytes were characterized by flow cytometry. The figures show percentage of CD3+ T cells in tumor (F), percentage of CD4+ T cells in tumor (G), percentage of CD8+ T cells in tumor (H), percentage of NK cells in tumor (I), percentage of CD3+ T cells in spleen (J), percentage of CD8+ T cells in spleen (K). Data are represented as means ± SEM (n = 6-8 mice/group) statistical significance was assessed by unpaired T test; *, P < 0.05; **, P < 0.005; ***, P < 0.0005; ns-not significant.

(OA02) Long-term Pathologic and Survival Outcomes with Chemotherapy and Stereotactic Body Radiotherapy in Localized Pancreatic Adenocarcinoma

Colin Hill¹, Shuchi Sehgal, BS², Jeffrey Meyer, MS, MD¹, Joseph Herman, MD³, Amol Narang, MD¹; ¹Johns Hopkins University School of Medicine, Department of Radiation Oncology and Molecular Radiation Sciences, ²Philadelphia College of Osteopathic Medicine, ³Northwell Health

Background: Borderline resectable (BRPC) or locally advanced pancreatic cancer (LAPC) patients are at high risk of margin positive resection. Neoadjuvant stereotactic body radiation therapy (SBRT) may help increase the proportion of patients that are surgically explored and resected with negative margins. We report long-term outcomes of BRPC/LAPC patients after neoadjuvant CT (nCT) followed by 5-fraction SBRT (nCT-SBRT) with a high proportion of patients receiving multi-agent (MA)-CT and surgically explored.

Objectives: Consecutive BRPC/LAPC patients diagnosed from 2011-2019 who underwent resection following nCT-SBRT were retrospectively reviewed to determine survival outcomes, pathological endpoints, and patterns of failure.

Methods: One-sided and two-sided T-Test was used to compare covariates of interest with P -value ≤ 0.05 . Pathological endpoints and patterns of failure are descriptively reported, and Kaplan-Meier method was used to analyze survival outcomes.

Results: Of 274 patients, 156 patients (57%) were BRPC and 118 patients (43%) were LAPC. The median follow-up was 25.3 months (range: 6.6–88.4) from diagnosis and 18.9 months (1.5–81.9) from SBRT. The median age at diagnosis was 65.3 years of age (range: 39.7–84.1 y) and the tumor was more frequently located in the head/neck/uncinate regions ($n=192$, 71%). For nCT, FOLFIRINOX (FFX) was administered in 203 patients (74%) and gemcitabine and nab-paclitaxel (GnP) was utilized in 91 patients (33%). 29 patients (11%) received a different regimen which included single agent gemcitabine, a combination of gemcitabine, docetaxel, capecitabine, or gemcitabine and cisplatin. 45 patients (16%) received more than 1 line of CT before SBRT. The median total duration of nCT was 4.2 months (range: 0.5–18.0). SBRT median dose was 33 Gy (range: 25–40). At baseline, median cancer antigen (CA) 19-9 was 192.6 U/mL (range: 0–14,004.2) with 63% of cases ≥ 90 U/mL, but after neoadjuvant chemotherapy, the median CA 19-9 was 41.3 U/mL (range: 0–3264.0) with only 28% of cases ≥ 90 U/mL. In 31% of patients, the CA 19-9 reduction was greater than 80%. After SBRT, 250 patients (91%) were surgically explored, and 226 patients (83%) were surgically resected. In resected patients with available pathology, 190 (91.3%) had negative margins, 137 (61%) were node-negative, and 17 (8%) had a pathological complete response (pCR). Of the 156 BRPC patients, 112 (72%) were explored with 104 (67%) completing a resection and 98 (94%) were margin-negative. Of the 118 LAPC patients, 138 (89%) were surgically explored with 122 (78%) completing a resection and 110 (90%) were margin-negative. In all resected patients, vascular reconstruction was required in 84 cases (37%) with LAPC patients more frequently requiring reconstruction ($n=47$, 41%) compared with BRPC patients ($n=37$, 24%). Only 81 patients (30%) received adjuvant chemotherapy. The median overall survival (OS) for all patients from SBRT was 24.4 months (mo) and 30.7 mo from diagnosis. The median OS from SBRT for BRPC (23.3 mo) and LAPC (26.17 mo) from SBRT were similar ($P=0.743$). The 1- and 2-year probability for OS from SBRT was 75.2% (95% CI: 70.0–80.4%) and 50.9% (95% CI: 44.7–57.1%). The 1- and 2-year probability for OS from diagnosis was 93.7% (95% CI 90.8–96.6%) and 59.9% (95% CI: 54.0–66.0%). Patients who were taken to surgery had a significantly better median survival if they were resected at 28.0 mo vs. 10.0 months for those explored (HR 3.14, $P<0.001$) and vs. 10.1 mo (HR 3.35, $P<0.001$) for those aborted. When comparing covariates in patients surviving longer ($n=82$, 30%) or less than 36 mo ($n=192$, 70%) after diagnosis, there was a significant difference in duration of neoadjuvant chemotherapy (median: 4.9 vs. 4.0 mo, $P=0.005$), successful resection (96% vs 77%, $P<0.001$), pCR (13% vs. 10%, $P=0.015$), and node-negative status (76% vs. 52%, $P<0.001$). From SBRT, the 3-year OS probability for resected patients was 44.8% (95% CI: 37.7–51.9%) versus 9.0% (95% CI: 0.0–18.3%) in non-resected patients. From SBRT, the median

progression-free survival was 11.4 mo, local (LPFS) was 24.8 mo, and distant metastasis-free survival (DMFS) was 13.32 mo. The most common pattern of first failure was distant in 100 patients (47%) followed by synchronous in 57 (27%) and local in 45 (21%) patients. In BRPC patients, local failure occurred first in 15 (7%), distant in 43 (20%), and synchronous in 31 (15%) whereas in LAPC patients, local failure was first in 30 (14%), distant in 57 (27%), and synchronous in 26 (12%). Margin-negative patients had better LPFS with median LPFS of 36.4 mo versus 16 mo in margin-positive patients (HR 0.51, $P=0.029$).

Conclusions: In a large cohort of BRPC/LAPC patients treated at a single high-volume institution with SBRT following multi-agent chemotherapy, a high proportion of patients underwent successful resection of their cancer ($>80\%$), of which a high proportion of resections were margin negative ($>90\%$). Patients who underwent resection experienced significantly improved median and long-term survival. Despite aggressive local therapy with SBRT and resection, local failure remained not insignificant, highlighting opportunity to continue to refine radiation therapy for this disease.

(OA03) Detection of Minimal Residual Disease in Localized Bladder Cancer Patients Based on Single Nucleotide Variants and Copy Number Alterations in Urine Tumor DNA

Kevin Chen, BS¹, Pradeep Chauhan, PhD¹, Ramandeep Babbra, MD¹, Wenjia Feng, MS¹, Jeffrey Szymanski, MD, PhD², Peter Harris, PhD¹, Katherine Dienstbach, MPH³, Andrew Atkocius, BS³, Lenon Maguire, BS³, Faridi Qaium, BS¹, Yi Huang, MS¹, Brian Baumann, MD¹, Li Ding, PhD⁴, Dengfeng Cao, MD⁵, Melissa Reimers, MD³, Eric Kim, MD⁶, Vivek Arora, MD, PhD³, Zachary Smith, MD⁶, Aadel Chaudhuri, MD, PhD²; ¹Department of Radiation Oncology, Washington University School of Medicine in St. Louis, ²Washington University School of Medicine in St. Louis, ³Department of Medicine, Washington University School of Medicine in St. Louis, ⁴McDonnell Genome Institute, Washington University School of Medicine in St. Louis, ⁵Department of Pathology and Immunology, Washington University School of Medicine in St. Louis, ⁶Department of Surgery, Washington University School of Medicine in St. Louis

Background: Standard-of-care for treating muscle-invasive bladder cancer involves radical cystectomy, which is a morbid procedure. Nonoperative treatment with chemoradiation is the alternative but requires frequent invasive monitoring to assess for response and recurrence.

Objectives: We sought to develop a noninvasive liquid biopsy approach by detecting single nucleotide variants (SNVs) and copy number alterations (CNAs) in urine tumor DNA (utDNA) obtained

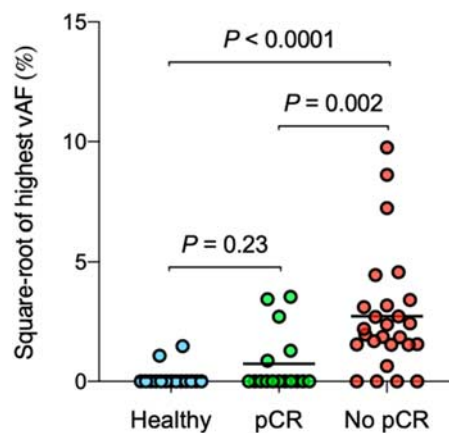

FIGURE 1. Scatterplot of highest utDNA variant allele fraction (vAF), shown as the square-root value, among non-silent, duplex-supported driver mutations detected in the urine of localized bladder cancer patients (pCR vs. no pCR) and healthy adults. P values were calculated using Mann-Whitney U test with an α of 0.017 after Bonferroni correction.

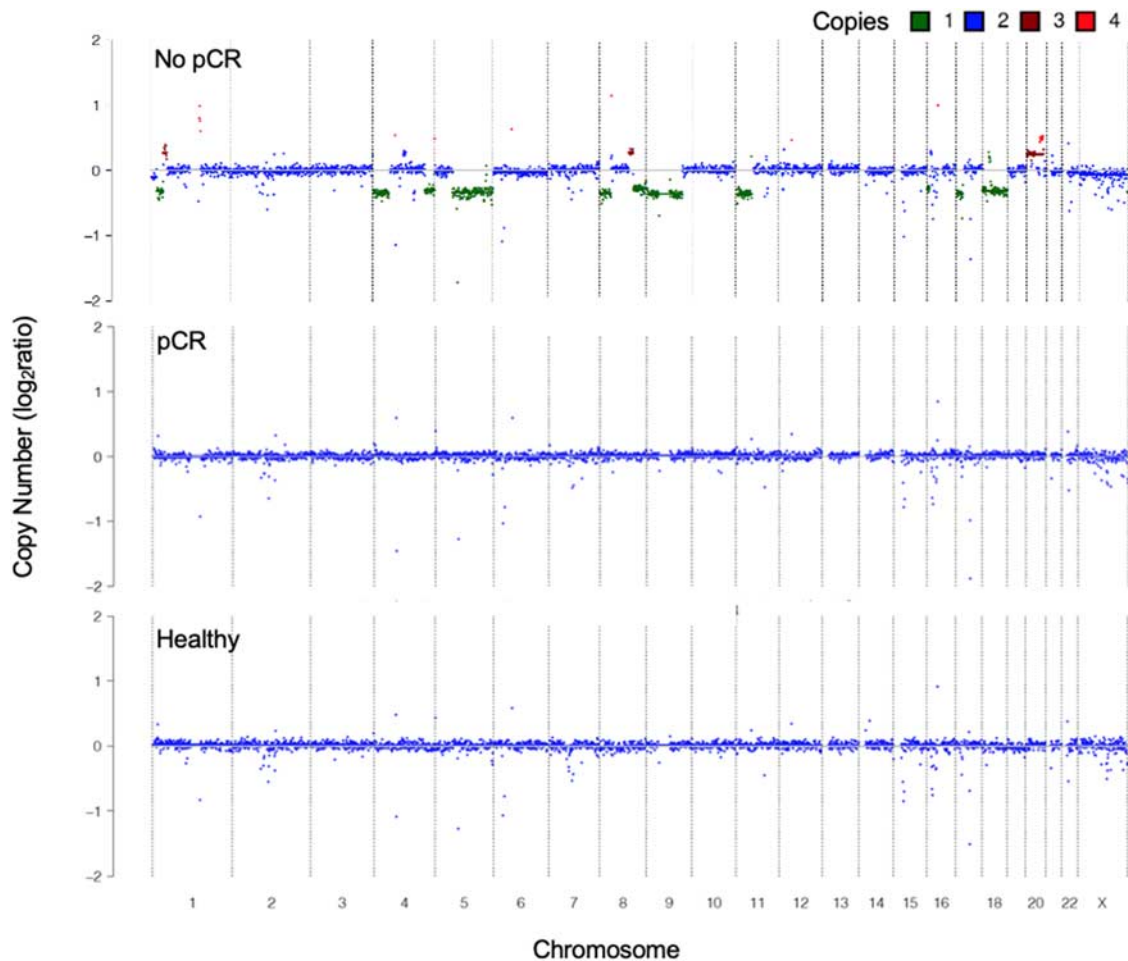

FIGURE 2. Representative genome-wide comparisons of copy number alterations among a patient with no pCR, a patient with pCR, and a healthy adult. Y-axis indicates \log_2 copy number ratio. Color legend also indicates genomic locus-specific copy number levels.

pre-operatively from localized bladder cancer patients. These results were correlated with pathologic complete response (pCR) assessed by surgery.

Methods: We acquired urine samples from 42 localized bladder cancer patients with an indication for radical cystectomy, often following neoadjuvant chemotherapy. SNV-calling with Cancer Personalized Profiling by deep Sequencing (CAPP-Seq) was performed without tumor mutational knowledge using a 145 kb panel of 49 consensus driver genes. For each patient, we identified the non-silent, duplex-supported driver mutation with the highest variant allele fraction (vAF) after removing germline variants. Minimal residual disease (MRD) detection was defined using the optimal threshold of highest vAF that classified patients with residual disease in their cystectomy specimens (no pCR) against 15 healthy adults. Accuracy of pCR prediction based on MRD was assessed by applying leave-one-out cross-validation to a logistic regression controlling for age and sex. Low-pass whole genome sequencing (LP-WGS) was performed on a subset of urine samples to correlate pCR with genome-wide CNAs.

Results: The median difference in highest vAF between patients with no pCR ($n=26$) and those who achieved pCR ($n=16$) was 4.3% (4.3% vs. 0%; $P=0.002$), while there was no median difference between pCR and healthy adults (0% vs 0%, $P=0.23$) (Fig. 1). Using highest vAF to define MRD and predict pCR in a logistic regression, 81% of cases in our cohort were correctly classified by cross-validation with 81% sensitivity and 81% specificity. Positive MRD correlated with worse progression-free survival (HR=7.4; $P=0.03$) with a median follow-up time of 183 days. Median utDNA fractions derived from genome-wide CNAs in patients who achieved pCR ($n=4$) were also significantly

lower than those with no pCR ($n=4$) by 12% (1% vs. 13%; $P=0.03$) but not significantly different compared with four healthy adults (1% vs 0%; $P=0.43$). Representative genome-wide comparisons among two patients and a healthy adult are shown in Figure 2.

Conclusions: utDNA analysis of MRD in localized bladder cancer patients significantly predicted pCR in the cystectomy specimen with 81% sensitivity and 81% specificity. Patients who achieved pCR also demonstrated genomic copy number stability similar to healthy adults, while those with no pCR did not. In the future, this work could pave the way toward more precise and noninvasive response assessment in bladder-sparing chemoradiation patients.

(OA04) Benchmarking Outcomes After Ablative Radiotherapy for Molecularly Characterized Unresectable Intrahepatic Cholangiocarcinoma

Brian De, MD¹, Ibrahim Abu-Gheida, MD¹, Aashini Patel, BS¹, Sylvia Ng, MD PhD MSc¹, Mohamed Zaid, MD¹, Connor Thunshelle, BA¹, Dalia Elganainy, MD¹, Milind Javle, MD¹, Kanwal Raghav, MD MBBS¹, Sunyoung Lee, MD¹, Jean-Nicolas Vauthey, MD¹, Ching-Wei Tzeng, MD¹, Hop Tran Cao, MD¹, Ethan Ludmir, MD¹, Bruce Minsky, MD¹, Grace Smith, MD MPH¹, Emma Holliday, MD¹, Cullen Tani-guchi, MD PhD², Albert Koong, MD, PhD¹, Prajnan Das, MD MS MPH², Eugene Koay, MD PhD²; ¹MD Anderson Cancer Center, ²MD Anderson

Background: We previously showed that ablative radiotherapy (A-RT) with biologically effective dose (BED10) ≥ 80.5 Gy is associated with

TABLE 1. Time-to-event Outcomes of Patients Stratified by the Most Commonly Mutated Genes

Mutation status	Outcomes [95% CI] at 1 year following RT			
	OS	LC	Intrahepatic DMFS	Extrahepatic DMFS
IDH1 mutant (n=27)	67% [45-82%]	65% [45-80%]	22% [10-38%]	61% [39-78%]
TP53 mutant (n=24)	52% [27-71%]	61% [35-79%]	6% [1-25%]	35% [11-61%]
ARID1A mutant (n=24)	69% [43-85%]	72% [45-87%]	30% [12-50%]	59% [27-80%]
FGFR2 mutant/fusion (n=15)	92% [54-99%]	92% [57-99%]	16% [3-39%]	48% [16-74%]
All patients (n=114)	73% [65-80%]	81% [72-87%]	35% [27-43%]	60% [50-69%]

longer survival for patients with unresectable intrahepatic cholangiocarcinoma (ICC). Despite recent large-scale sequencing efforts in ICC, RT outcomes based on genetic alterations have not been described.

Objectives: To identify clinical and pathologic characteristics associated with disease control and survival after RT for ICC, and to benchmark RT outcomes based on commonly mutated genes.

Methods: We reviewed records of 156 consecutive patients (54% female) treated with A-RT for unresectable ICC from 2008-2020. For 114 patients (73%), next generation sequencing using solid tumor tissue and/or cell-free DNA provided molecular profiles. The Kaplan-Meier method was used to estimate overall survival (OS), local control (LC), and both intrahepatic and extrahepatic distant metastasis-free survival (DMFS). Univariable Cox analysis was used to determine associations with outcomes. Median age at RT was 66 years (range, 31-89 y). Median number of liver tumors was 1 (range, 1-5) and 51% had satellitosis. Median tumor size was 7.3 cm (range, 2.2-18.2). American Joint Committee on Cancer 8th Edition stages were I, II, III, and IV in 12%, 22%, 38%, and 29%, respectively. Portal vein thrombus (PVT) was present in 10%. Systemic therapy before, concurrently with, and after RT were delivered to 81%, 63%, and 58%, respectively. RT technique was photon in 73% and proton in 27%. RT median dose was 67.5 Gy (range, 58.05-100) in a median 15 fractions (range, 10-28) for a median BED10 of 98 Gy (range, 81-144 Gy).

Results: Median [95% confidence interval] follow-up was 50 [37-92] months from diagnosis and 35 [29-62] months from RT. Median OS was 32 [29-37] months after diagnosis and 21 [17-25] months after RT. One-year OS, LC, and intrahepatic DMFS were 73% [65-80%], 81% [72-87%], and 35% [27-43%]. Among 111 (71%) patients with M0 disease at RT, 1-year extrahepatic DMFS was 60% [50-69%]. Most common mutations were in IDH1 (24%), TP53 (21%), ARID1A (21%), FGFR2 (13%), BAP1 (12%), IDH2 (12%), and PIK3CA (11%). Sixteen (14%) patients had no somatic mutations identified. Outcomes stratified by the most commonly mutated genes are shown in Table 1. On univariable analysis, factors commonly associated with death were worse performance status, higher CA 19-9 levels, male sex, metastatic disease, PVT, satellitosis, D90% to gross tumor volume, and IDH1 mutation. Factors associated with progression included satellitosis, PVT, higher CA 19-9 levels, and IDH1 and TP53 mutations. Significant results for time-to-event endpoints are shown in Table 2.

Conclusions: IDH1 mutations may be associated with poorer disease control and survival for patients with ICC receiving A-RT. However, favorable outcomes with A-RT were observed regardless of molecular profile. Further investigation into the prognostic value and therapeutic implications of individual mutations and combinations thereof is warranted.

TABLE 2. Univariable Cox Analysis of Factors Associated With Time-to-event Outcomes

Attribute	OS		LC		Intrahepatic DMFS		Extrahepatic DMFS	
	HR	P-value	HR	P-value	HR	P-value	HR	P-value
Male sex	1.53	0.041	1.46	0.286	0.87	0.447	0.95	0.833
Performance status	1.47	0.027	1.05	0.871	1.24	0.154	1.39	0.073
Tumor size	1.12	0.317	1.004	0.926	1.07	0.008	1.02	0.605
T-stage	1.04	0.144	1.44	0.040	1.19	0.103	1.32	0.025
M1 disease at RT	2.26	<0.001	1.84	0.108	1.86	0.003	Not applicable	
CA 19-9	1.00008	<0.001	1.0001	0.522	1.00005	0.001	1.0004	0.004
PVT	2.62	0.002	0.82	0.791	1.98	0.018	2.82	0.020
Satellitosis	1.54	0.037	2.65	0.007	1.45	0.045	1.39	0.149
Lymphovascular invasion	1.41	0.506	3.40	0.046	1.13	0.812	1.20	0.719
D90% to gross tumor volume	0.97	0.027	0.9999	0.997	0.98	0.137	0.96	0.008
IDH1 mutation	1.70	0.046	2.33	0.046	1.82	0.020	1.55	0.169
TP53 mutation	1.68	0.088	2.27	0.053	1.96	0.012	1.65	0.163
ARID1A mutation	1.51	0.148	1.64	0.267	1.41	0.193	1.31	0.436
FGFR2 mutation/fusion	0.57	0.150	0.17	0.084	1.07	0.819	0.91	0.826

(OA05) Economic Evaluation of Total Neoadjuvant Therapy in Rectal Cancer: Short-course Radiation Therapy vs. Long-course Chemoradiation

Re-I Chin, MD¹, Ebum Otegbeye, MD¹, Kylie Kang, MD², Su-Hsin Chang, PhD¹, Scott McHenry, MD¹, Amit Roy, MD³, Shahed Badiyan, MD¹, William Chapman Jr, MD¹, Sean Glasgow, MD¹, Lauren Henke, MD, MSCI⁴, Steven Hunt, MD¹, Katrina Pedersen, MD¹, Pamela Samson, MD, MPH⁵, Matthew Silveira, MD¹, Benjamin Tan, MD¹, Paul Wise, MD¹, Matthew Mutch, MD¹, Hyun Kim, MD¹; ¹Washington University School of Medicine, ²Department of Radiation Oncology, Washington University School of Medicine in St. Louis, ³Washington University in St. Louis, ⁴henke.lauren@wustl.edu

Background: Distant recurrence risk is high in patients treated for locally advanced rectal cancer (LARC). Total neoadjuvant therapy (TNT) with either short-course radiation therapy (SC-TNT) or long-course chemoradiation (LC-TNT) has been proposed to lower this risk, but the economic implications of these two approaches are unknown.

Objectives: To evaluate the cost-effectiveness of SC-TNT vs. LC-TNT in conjunction with total mesorectal excision for patients with resectable LARC.

Methods: A decision analytic model with a 5-year time horizon was constructed. Markov modeling was used to model disease progression and patient survival after treatment in 3-month cycles. Data on probabilities and utilities were extracted from the literature. Costs were evaluated from Medicare payer's perspective in 2020 US dollars (2020\$). Sensitivity analyses were performed for key variables. Quality-adjusted life-years (QALYs) and total costs (2020\$) were computed and discounted at 3% annually. Cost-effectiveness was evaluated using the net-monetary benefit (NMB), QALYs × willingness-to-pay per QALY (WTP) - total costs, where WTP was set at \$50,000.

Results: Over the 5-year horizon, QALYs accrued were 2.20 for SC-TNT and 2.35 for LC-TNT. The total cost was \$44,010 for SC-TNT and \$53,463 for LC-TNT. The NMB was \$66,134 for SC-TNT versus \$64,165 for LC-TNT. The sensitivity analyses using WTP at \$100,000 and \$150,000 demonstrated the same conclusion.

Conclusions: SC-TNT is an economically preferred treatment strategy with a greater net-monetary benefit compared with LC-TNT.

(OA06) The Benefit of Whole Pelvis Radiation Therapy in Patients with High-Risk Prostate Cancer Relative to the Risk of Nodal Metastases in a Multi-Institutional Cohort

Luca Valle, MD¹, Michael Xiang, MD, PhD², Amar Kishan, MD², Tahmineh Romero, MS², Jessica Wong³, Bradley Stish, MD⁴, Daniel Spratt, MD⁵, Avinash Pilar, MD⁶, Jay Ciezki, MD⁷, Trude Wedde, MD⁸, Gregory Merrick, MD⁹, Richard Stock, MD¹⁰, Brian Moran, MD¹¹, Phuoc Tran, MD¹², Rafael Martinez-Monge, MD¹³, Daniel Krauss, MD¹⁴, Ashley Ross, MD, PhD¹⁵, Derya Tilki, MD¹⁶, Jonathan Tward, MD, PhD¹⁷, Brian Davis, MD, PhD¹⁸, Michael Steinberg, MD²; ¹University of California, Los Angeles, ²UCLA, ³Fox Chase Cancer Center, ⁴Mayo Clinic Rochester, ⁵University of Michigan Department of Radiation Oncology, ⁶Princess Margaret Hospital, ⁷Cleveland Clinic, ⁸iMaria Sklodowska-Curie Memorial Cancer Center, ⁹Wheeling Jesuit University, ¹⁰Icahn School of Medicine at Mount Sinai, ¹¹Prostate Cancer Foundation of Chicago, ¹²Johns Hopkins University School of Medicine, ¹³University of Navarra, ¹⁴Oakland University William Beaumont School of Medicine, ¹⁵Northwestern University Feinberg School of Medicine, ¹⁶University Hospital Hamburg-Eppendorf, ¹⁷Huntsman Cancer Institute at the University of Utah, ¹⁸Mayo Clinic

Background: The optimal selection of men with prostate cancer for whole-pelvis radiation (WPRT) is controversial, although emerging data suggest a benefit in very high-risk patients.

Objectives: We evaluated the benefit of WPRT in a large, contemporary, prostate-specific antigen (PSA) screen-detected multi-institutional cohort of high-risk patients, stratified by risk of nodal upstaging on prostate-specific membrane antigen (PSMA) PET/CT.

Methods: The multi-institutional cohort comprised 1,863 patients treated at 15 tertiary referral centers between 1995-2018 with high- and very high-risk prostate cancer treated with definitive radiotherapy, with or without androgen deprivation therapy (ADT). Patients were stratified by risk of pelvic nodal upstaging by PSMA PET/CT ($\leq 25\%$ vs $> 25\%$) using a nomogram built using logistic regression on four variables: initial PSA, biopsy Gleason grade group, percent positive cores, and clinical T category. Time-to-event outcomes were compared using Gray's test (for biochemical recurrence [BCR], distant metastasis [DM], prostate cancer-specific mortality [PCSM]) and the log-rank test (for OS), allowing for competing risks and censoring. Multivariable analyses were performed using Fine-Gray regression (for BCR, DM, PCSM) and Cox regression (for OS) controlling for patient age, initial PSA, clinical T stage, Gleason grade group, percent positive cores, brachytherapy boost, and ADT.

Results: 69% (1,287/1,863) of patients in the high-risk multi-institutional cohort received WPRT. Median follow-up was 6.1 years. On unadjusted analysis, WPRT was associated with significantly higher 8-year freedom from BCR versus no WPRT in patients at high (71% vs 58%, $P=0.007$) and low risk (84% vs 78%, $P=0.02$) of pelvic nodal upstaging; there were no differences in DM, PCSM, or OS. After adjustment for clinical features and brachytherapy, the BCR benefit of WPRT persisted in high but not in low nodal risk patients. However, after additionally adjusting for ADT, the benefit of WPRT disappeared from all groups. This finding was unchanged in subgroup and interaction analyses according to the status of brachytherapy or ADT.

Conclusions: For PSA screen-detected patients without upfront PSMA screening, the value of WPRT requires further study. Individualized and shared decision making is crucial (Figs. 1–3).

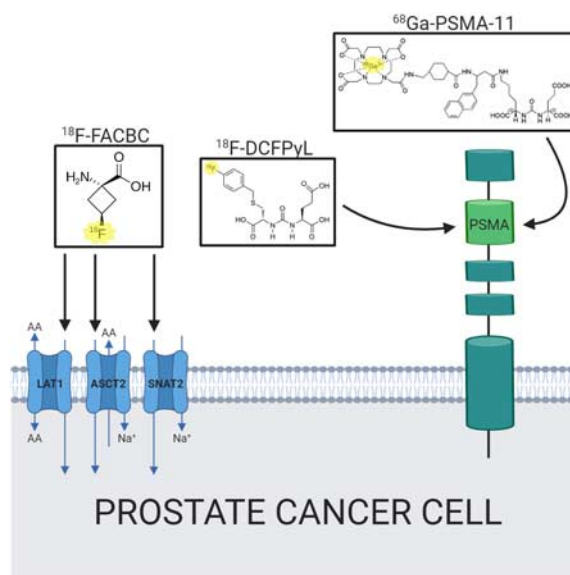

FIGURE 1. Chemical Structures and Binding Sites for Molecular PET-Tracers. The molecular structures for the three evaluated PET tracers are shown above, along with their relevant binding sites for prostate cancer imaging. 18F-FACBC is a fluorinated synthetic amino acid analog that is transported into prostate cancer cells by amino acid transporters that are upregulated in prostate cancer. 18F-DCFPyL and 68Ga-PSMA-11 are both radiolabeled ligands that bind to the extracellular component of the prostate specific membrane antigen (PSMA) transmembrane glycoprotein, which is overexpressed in prostate cancer cells. Graphic created with Bio-Render.com.

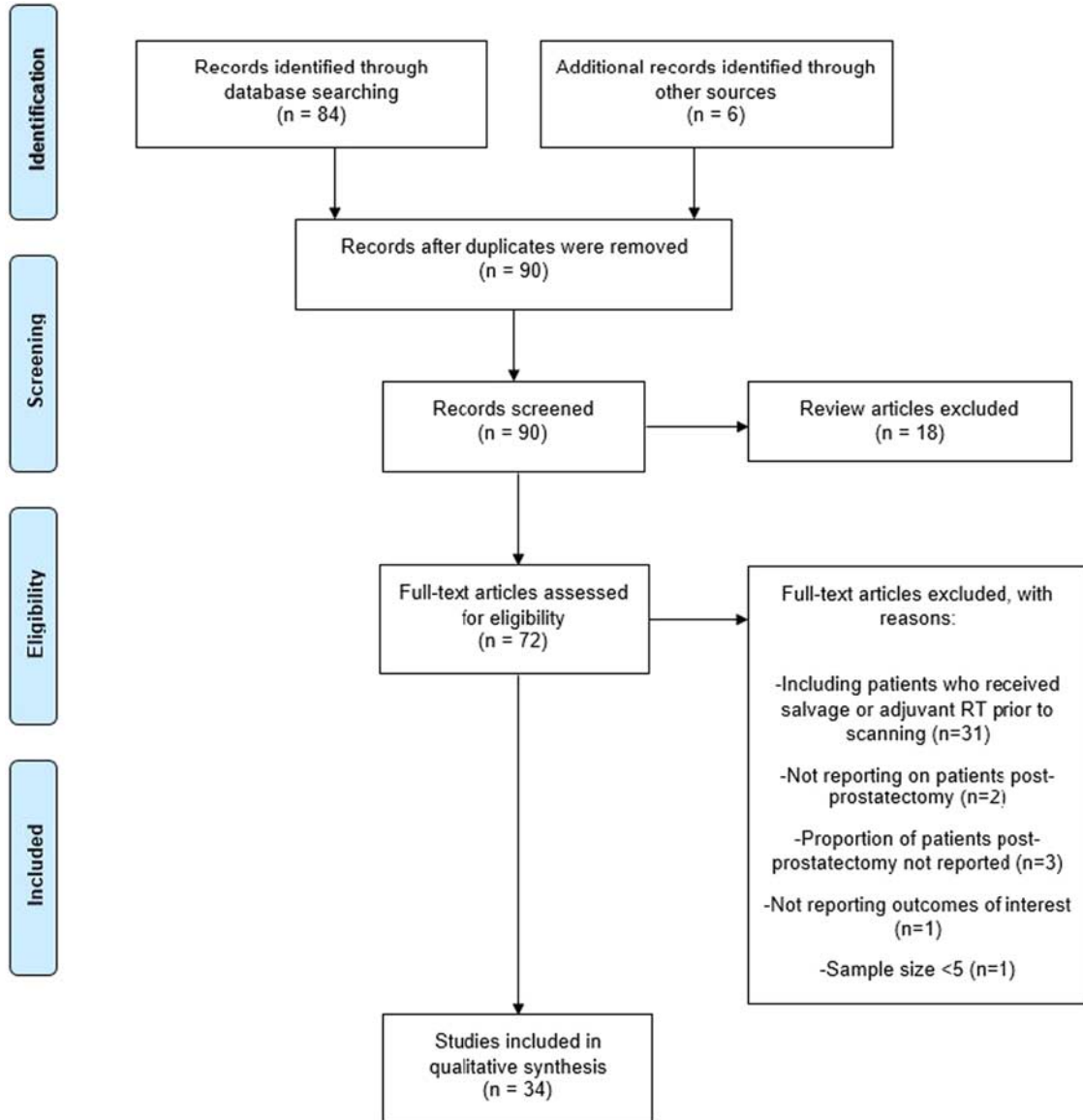

FIGURE 2. PRISMA Diagram. PRISMA diagram depicting studies included in our systematic review.

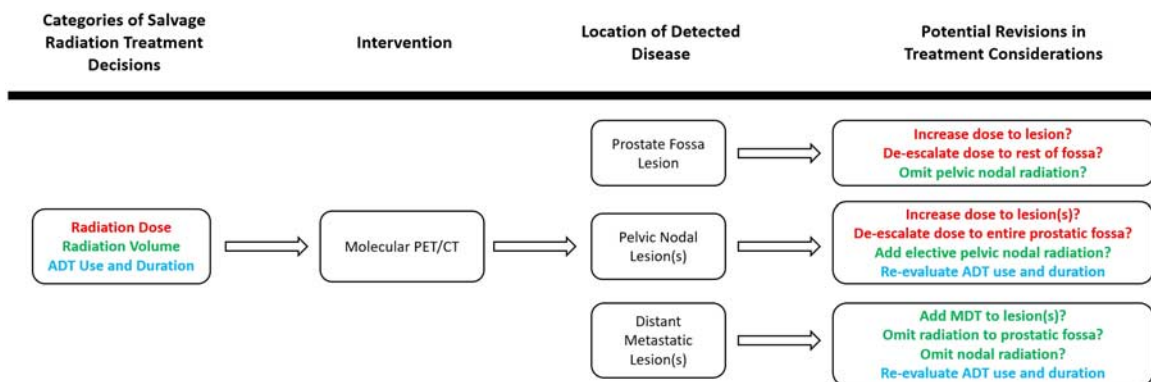

FIGURE 3. Potential Management Changes Resulting from Molecular PET Findings. Schematic of potential changes to radiation dose (Red), radiation volume (green), or ADT use and duration (blue) as findings from molecular PET/CT are incorporated into patient management. Potential revisions in treatment considerations are organized by anatomic region of PET-detected disease.

(OA07) Radiosensitivity, Microenvironment Inflammation, and Mutational Frequency of Non-Small Cell Lung Cancer Metastases Across Host Tissue Types

Austin Sim, MD, JD¹, Prithvi Shetty, BS², Eric Welsh, PhD³, Jamie Teer, PhD³, Steven Eschrich, PhD³, James Mule, PhD⁴, Javier Torres-Roca, MD¹, Kamran Ahmed, MD¹, G. Daniel Grass, MD, PhD¹; ¹Department of Radiation Oncology, H. Lee Moffitt Cancer Center & Research Institute, ²University of South Florida Morsani College of Medicine, ³Department of Biostatistics and Bioinformatics, H. Lee Moffitt Cancer Center & Research Institute, ⁴Department of Immunology, H. Lee Moffitt Cancer Center & Research Institute

Background: Therapies for non-small cell lung cancer (NSCLC) metastases are minimally personalized, especially if a targetable mutation is lacking. Additionally, the influence of the metastasis host tissue type is unknown.

Objectives: To explore differences in radiosensitivity, tumor microenvironment inflammation (TMI), and mutational frequency (MF) among NSCLC metastases by host tissue.

Methods: Metastatic NSCLC samples across 6 tissues (adrenal, bone, brain, liver, lymph node [LN], soft tissue [ST]) underwent microarray gene expression profiling. A previously described signature was used to estimate radiosensitivity (scale 0-1), known as the radiosensitivity index (RSI). Higher RSI values are associated with greater radioresistance (cutpoint 0.375). An additional 12-gene chemokine signature (12CK) was used to estimate the magnitude of TMI, where a higher score indicates greater inflammation. A subset of samples (n = 24) additionally underwent targeted exome sequencing of 1,327 known cancer-associated genes. The number of somatic mutations (MF) was calculated and filtered for known germline/silent mutations and artifacts for enrichment. Differences across these metrics were compared across tissue types using the Kruskal-Wallis H test. RSI, 12CK, and MF were then correlated using Spearman's rho.

Results: From 1998 to 2011, 154 metastatic samples were identified from unique patients. Median age at diagnosis was 62 (range 36-82). With a median follow-up of 168.3 months (95%CI 146.3-190.3), median survival was 28.5 months (95%CI 24.0-33.0). Median values for RSI, 12CK, and MB were 0.420 (interquartile range [IQR] 0.319-0.491), 7.58 (IQR 6.28-8.92), and 90 (IQR 80.5-111), respectively. Significant differences existed among tissues for both RSI ($P < 0.001$) and 12CK ($P < 0.001$), but not for MF ($P = 0.442$). After Bonferroni correction, RSI pairwise comparisons were significant for LN-Brain ($P = 0.006$), Adrenal-Brain ($P = 0.020$), and ST-Brain ($P = 0.021$). 12CK pairwise comparisons remained significant for Liver-LN ($P = 0.026$), Liver-Adrenal ($P = 0.026$), Brain-ST ($P = 0.003$), Brain-LN ($P < 0.001$), Brain-Adrenal ($P < 0.001$). Significant correlation between RSI and 12CK was noted ($\rho = -0.420$, $P < 0.001$). However, no significant correlation was found between MF and RSI or 12CK. No significant differences were found for RSI or 12CK when stratified by presence of ALK, EGFR, or KRAS mutations.

Conclusions: In this novel composite gene expression analysis of NSCLC metastases, adrenal and LN metastases appear relatively radiosensitive, while brain and liver metastases appear resistant, warranting dose escalation. The concomitant low TMI scores of brain, liver, and bone metastases may refine patient selection for immunotherapy. More inflamed metastases appear to be more radiosensitive, except for in bone. Better elucidation of the effects of host tissue on the tumor microenvironment may provide the opportunity for further treatment personalization through therapy selection and sequencing (Table 1).

(OA08) Pulmonary Function Test Results of a Multi-institutional Phase II Clinical Trial for 4DCT-ventilation Functional Avoidance Thoracic Radiotherapy

Brian Kavanagh¹, Yevgeniy Vinogradskiy²; ¹University of Colorado, ²Thomas Jefferson University

Background: A novel form of lung function imaging has been proposed that uses 4DCT data along with image processing techniques to generate 4DCT-based ventilation images (4DCT-ventilation). 4DCT-ventilation-based functional avoidance radiotherapy proposes to reduce dose to functional portions of the lung (as measured by 4DCT-ventilation) with the hypothesis that reduced doses to functional lung will lead to reduced rates of pulmonary toxicity.

Objectives: A phase II, multi-center, prospective study was initiated to evaluate 4DCT-ventilation functional avoidance radiotherapy. As part of the study, pulmonary function tests (PFTs) were collected at baseline and 3 months post radiotherapy. We report on a secondary trial endpoint of PFT changes; specifically changes in Diffusing capacity for carbon monoxide (DLCO), which have been shown to predict for clinical pulmonary toxicity (Guerra et al. IJROBP, 2012) are reported.

Methods: Lung cancer patients receiving curative intent radiotherapy (prescription doses of 45-75 Gy) and planned curative intent chemotherapy were accrued from 2 institutions. Each patient's 4DCT images along with image processing techniques (Guerrero et al, PMB, 2006) were used to generate 4DCT-ventilation maps. Using favorable arc geometry and optimization techniques the 4DCT-ventilation images were used to generate functional avoidance plans. The functional avoidance plans aimed to reduce doses to functional portions of the lung while delivering the prescribed tumor dose and respecting tolerances of organs-at-risk. Standard PFTs were acquired at baseline and 3 months post radiotherapy (median 3.4 mo, range 2.4-8.3 mo). We report on changes in DLCO as a percentage of predicted level (determined by sex, height, and weight).

Results: 50 patients enrolled on the study with pre and post-treatment PFTs were evaluable for the current analysis. The majority (74%) of study patient's had stage III disease. The median prescription dose was 60 Gy (range 45-66 Gy) delivered in 30 fractions (range 15-33 fractions). Median DLCO values at baseline were 62% (range 32-100%) and 52% (27-106%) post chemo-radiation for a median difference of 10% (range -50% to +44%).

TABLE 1. Radiosensitivity Index Scores, 12-Chemokine Scores, and Mutational Frequencies by Tissue

	n	RSI	IQR	12CK	IQR	n	MB	IQR
Adrenal	16	0.341	0.17	9.15	1.82	3	91	-
Bone	6	0.390	0.26	6.27	2.62	-	-	-
Brain	82	0.447	0.14	6.68	2.02	19	83	24
Liver	7	0.429	0.22	5.92	3.67	-	-	-
LN	20	0.325	0.16	9.47	1.99	-	-	-
ST	23	0.363	0.17	8.18	2.49	2	108	-
p		<0.001		<0.001			0.442	

Number of samples, median values, and interquartile range of Radiosensitivity Index scores, 12-Chemokine scores, and mutational frequencies of metastatic samples stratified by host tissue type. RSI: Radiosensitivity Index, 12CK: 12-Chemokine score, MF: mutational frequency, IQR: interquartile range.

Conclusions: DLCO changes from pre- to post-treatment have been shown to be a predictor of pulmonary toxicity. For patients treated with standard thoracic chemo-radiation, DLCO values decrease by 20% on average (Guerra et al, JROBP, 2012). Our results indicate DLCO reductions of 10% with functional avoidance, providing evidence that functional avoidance results in improved preservation of clinically significant pulmonary function when compared with standard thoracic radiotherapy.

(OA09) The Influence of Dosimetric Parameters on Quality of Life for Early Stage Non-small Cell Lung Cancer Patients Treated with Stereotactic Body Radiation Therapy

Suneetha Devpura, PhD¹, Aharon Feldman, MD¹, Samuel Rusu, MSc¹, Stephen Brown, PhD¹, Andrew Cook, MD², Avielle Movsas, MD¹, Zhen Sun, MSc¹, Sean Vance, MD¹, Michael Simoff, MD¹, Munther Ajlouni, MD¹, M. Salim Siddiqui, MD, PhD¹, Benjamin Movsas, MD², Indrin Chetty, PhD¹; ¹Henry Ford Cancer Institute, HFHS, ²Department of Radiation Oncology, Henry Ford Cancer Institute

Background: Lung stereotactic body radiotherapy (SBRT) has become a standard treatment option for early stage non-small cell lung cancer (NSCLC) patients who are medically inoperable. The influence of radiation dose/volume parameters on quality of life is not known. Our hypothesis is that clinically meaningful declines in quality of life over time will be associated with increased radiation lung dose/volume parameters. **Objectives:** To investigate clinical toxicity and quality of life (QOL) outcomes of stage I NSCLC patients after SBRT as a function of radiation dose/volume parameters.

Methods: In this IRB-approved study, 55 stage I NSCLC patients who received SBRT (12 Gy x 4) and completed QOL forms were analyzed. Clinical symptoms and QOL were measured at baseline and at 3, 6, 12, 18, 24, and 36 months post-SBRT. Clinical toxicity was graded using the common terminology criteria for adverse effects (CTCAE v4.0). Quality of life was followed using the validated Functional Assessment of Cancer Therapy-Trial Outcome Index (FACT-TOI) instrument. Dosimetric parameters, including the mean lung radiation dose (MLD), and the volume of normal lung receiving > 5, 10, 13 or 20 Gy (V5, V10, V13, and V20) were measured from the radiation treatment plan. Student's t-test and Pearson correlation analyses were used to examine the relationships between radiation lung metrics and clinically meaningful changes in QOL and/or clinical toxicities. Kaplan-Meier method was used to estimate rates of local control (LC), disease free survival (DFS), and overall survival (OS). **Results:** With a median follow-up of 24 months, the 3 year LC, DFS, and OS were 93%, 65% and 84%, respectively, with 5.5% grade 3 toxicity and no grade 4 or 5 toxicities. Clinically meaningful declines in patient reported QOL (FACT-TOI, lung cancer subscale, physical well-being, and/or functional well-being) post-treatment significantly correlated with increased dosimetric parameters, such as V10, V13, and V20.

Conclusions: While lung SBRT is associated with excellent LC and minimal clinical toxicity for early stage NSCLC, clinically meaningful declines in QOL significantly correlated with increasing lung dose/volume parameters. This suggests that further improvements in the techniques of lung SBRT have the potential to further enhance patients' QOL following this treatment.

(OA10) Feasibility and Phase I/II Trial of Preoperative Proton Beam Radiotherapy with Concurrent Chemotherapy for Resectable Stage IIIA Non-Small Cell Lung Cancer

Nikhil Yegya-Raman, MD¹, Charles Simone, MD, FACRO², Shwetha Manjunath, MD¹, Jacob Shabason, MD, MTR¹, Abigail Berman, MD, MSCE¹, Vivek Verma, MD³, Lee Xu, MS¹, Keith Cengel, MD, PhD¹, William Levin, MD¹, John Christodouleas, MD, MPH¹, Roger Cohen, MD¹, Corey Langer, MD¹, Charu Aggarwal, MD, MPH¹, Joshua Baumli, MD¹, Taine Pechet, MD¹, Sunil Singhal, MD¹, John Kucharczuk, MD¹, Ramesh Rengan, MD, PhD⁴, Steven Feigenberg, MD¹; ¹University of Pennsylvania, ²New York Proton Center, ³University of Texas M.D. Anderson Cancer Center, Department of Radiation Oncology, ⁴University of Washington

Background: Neoadjuvant chemoradiotherapy (CRT) followed by surgical resection represents one treatment approach for patients with locally advanced non-small cell lung cancer (LA-NSCLC). Benefits in

progression-free survival with trimodality therapy have been offset by significant treatment-related morbidity, necessitating strategies to enhance the safety of this approach. Due to its characteristic Bragg peak, proton beam therapy (PBT) can potentially minimize dose to normal structures while facilitating full or escalated doses to target volumes.

Objectives: To assess feasibility (first portion), followed by maximum tolerated dose (MTD) and pathologic complete response (pCR) (phase I/II portion), of a trimodality approach with PBT.

Methods: Patients with NSCLC (potentially resectable stage IIIA or superior sulcus tumors) were enrolled on this prospective trial (NCT01076231). Patients received neoadjuvant concurrent CRT with PBT, followed by restaging and surgical resection. For each patient, both a PBT plan and a photon therapy (IMRT) clinical backup plan were generated. The starting radiotherapy dose level was 50.4 Gy (feasibility phase), followed by sequential dose escalation to 59.4 Gy and 66.6 Gy in 1.8 Gy daily fractions to determine MTD based on dose-limiting toxicity. Primary outcomes were feasibility, MTD, and pCR. Additional outcomes included post-operative toxicity, late toxicity, progression-free survival (PFS), and overall survival (OS).

Results: From 2011-2018, 21 patients were enrolled, of whom 19 underwent surgical resection and were included in the final analysis. The trial was closed early before reaching MTD due to poor accrual. Median age was 64 years. Radiotherapy doses were 50.4 Gy (n = 13, 68%) and 59.4 Gy (n = 6, 32%). Concurrent chemotherapy consisted of cisplatin/etoposide (n = 15, 79%), carboplatin/paclitaxel (n = 3, 16%), and carboplatin/pemetrexed (n = 1, 5%). Most patients (n = 16, 84%) underwent lobectomy. Primary endpoint of feasibility was met, as no patient received photon therapy for >30% of their total treatment, all patients completed treatment within 10 days of planned completion date, no treatment breaks > 5 days were required, and no patient experienced an acute grade 3+ non-hematologic toxicity from PBT. pCR occurred in 5 patients (26%), including 2/13 patients (15%) who received 50.4 Gy and 3/6 patients (50%) who received 59.4 Gy (P = 0.26). Nodal pCR occurred in 8/18 patients (44%) who were clinically node positive. There were no post-operative grade 4-5 toxicities or deaths within 30 days. One patient (5%) experienced late grade 4 toxicity (aspiration). Median follow-up was 85.7 months (95% CI 38.6-105 mo). Median PFS was 22.3 months and median OS was 40.7 months.

Conclusions: The first prospective report of neoadjuvant CRT with PBT for LA-NSCLC demonstrated this approach as feasible, with an acceptable toxicity profile and favorable nodal pCR and survival rates.

(OA11) Sustained Lung Cancer Radiotherapy Quality Improvement in a Statewide Collaborative Radiation Oncology Quality Consortium

Shruti Jolly, MD¹, Melissa Mietzel, MS¹, Peter Paximadis, MD², James Hayman, MD, MBA¹, Robert Dess, MD¹, Reshma Jagsi, MD, DPhil¹, Kent Griffith, MS¹, Jean Moran, PhD¹, Lori Pierce, MD¹, Matthew Schipper, PhD¹, Martha Matuszak, PhD¹; ¹University of Michigan, ²Spectrum Health

Background: Advancements in imaging and radiation therapy delivery have made it possible to provide more targeted treatment with less toxicity. With improved precision, the quality parameters required to deliver high level radiation become even more important. In 2011, a statewide collaborative quality initiative (CQI) was created focused on lung and breast cancer patients (later expanded to other select patient populations) to establish and disseminate best practice guidelines that enable radiation oncology practitioners to optimize the delivery of cost-effective care. Using an incentive participation program, various quality measures and targets were utilized to drive improvements.

Objectives: To report the impact of a statewide CQI on the quality of lung cancer radiotherapy delivered.

Methods: Using educational forums, in-person as well as virtual meetings, and establishment of a lung cancer specific working group, four time-limited measures for lung cancer radiation therapy quality improvement have been developed over the course of the CQI. These measures focused on 1] evaluation of lung tumor motion management, 2] tumor volume (GTV/ITV) definition as defined by the consortium, 3] TG-263 nomenclature compliance for heart and lungs, and 4] cardiac

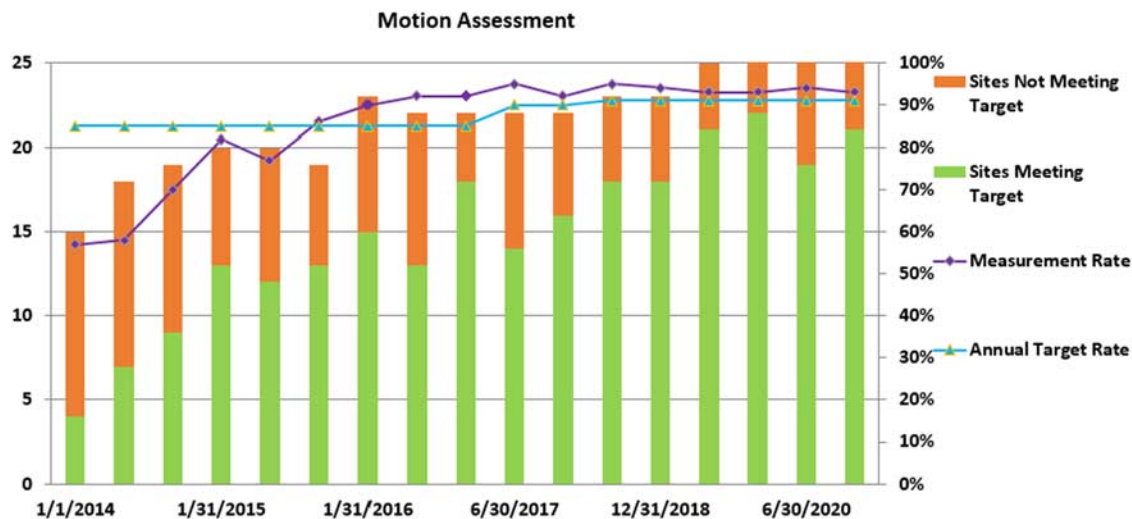

FIGURE 1. Change in lung motion assessment measure over time.

dose reduction (mean heart dose <20 Gy while keeping target coverage >95%). The rate of compliance of these measures was evaluated before initiation of the measure and then annually. When consistent improvement in the measure is noted, it is no longer tied to the incentive participation program. Additional quality measures have been adopted over time.

Results: To date, 3846 lung cancer patients from 27 radiation treatment centers (academic and community practices) and over 125 members participate in the collaborative by enrolling patients to this prospective observational database. Adoption of lung motion assessment increased from 57% to 93%. Even after removal of the incentive component of this measure in 2018, the rate of compliance did not decrease. See figure below. Target volume contouring per guidelines increased from 83% to 96%. The current rate of implementation of nomenclature standardization per TG-263 is 98%. The cardiac dose reduction and tumor coverage measure increased from 44% to 85%.

Conclusions: Across a statewide consortium, we have seen a substantial improvement in lung cancer delivery and treatment. The long term clinical impact of these improvements are being assessed by collection of cardiac and pulmonary toxicity outcomes (Fig. 1).

Background: Limited stage small cell lung cancer (LS-SCLC) is generally treated with local radiation or surgery and chemotherapy. Since systemic therapy does not adequately cross the blood-brain barrier, brain metastases are common and prophylactic cranial irradiation (PCI) has been utilized to reduce the risk of brain metastases. Multiple meta-analyses of prospective trials and retrospective reviews demonstrated the utility of PCI in patients with LS-SCLC who responded to upfront treatment (Aupérin et al NEJM 1999 and Meert et al BMC Cancer 2001). However, all available prospective data includes patients treated before 1998 before widespread MRI screening for brain metastases. The utility of PCI in patients with LS-SCLC in the modern era of widespread MRI screening has not yet been examined in published prospective trials and recent retrospective analyses have demonstrated conflicting data.

Objectives: To retrospectively analyze the impact of prophylactic cranial irradiation (PCI) on survival and intracranial progression in patients with limited stage small cell lung cancer (LS-SCLC) in the modern era of widespread MRI brain screening.

Methods: Patients with LS-SCLC treated within our network between 2009-2020 who responded to initial therapy were stratified by receipt of PCI and stage of disease. Propensity score match analysis was performed for stage II-III patients. Overall survival (OS) and neurologic survival (NS) were defined as time to death and presumed death due to uncontrolled intracranial disease, respectively. Brain metastasis free-survival (BMFS) and symptomatic brain metastasis free-survival (SBMFS) were defined as freedom from intracranial progression and symptomatic intracranial progression, respectively. The effect of PCI on these outcomes was assessed using Kaplan-Meier and Cox-proportional hazards models.

Results: 243 (69.6%) of 349 patients received PCI. On multivariate analysis (MVA) in the propensity matched stage II-III cohort, PCI was a

(OA12) Utility of Prophylactic Cranial Irradiation for Limited Stage Small Cell Lung Cancer in the Modern Era with Magnetic Resonance Imaging Surveillance

Siddharth Ghanta¹, Andrew Keller, MD², Joshua Rodríguez-López, MD³, Ankur Patel, MD², Sushil Beriwal, MD, MBA²; ¹University of Pittsburgh School of Medicine, ²UPMC Hillman Cancer Center, ³Department of Radiation Oncology, UPMC Hillman Cancer Center, University of Pittsburgh School of Medicine

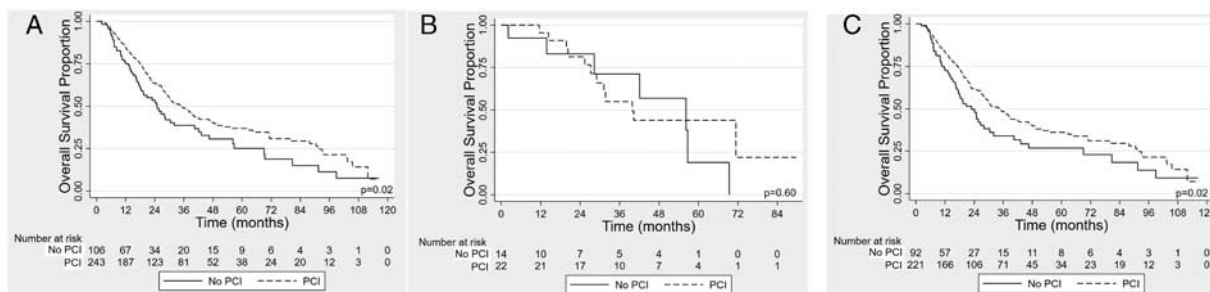

FIGURE 1. Kaplan-Meier plots of Overall Survival in entire cohort (1A), stage I cohorts (1B), and stage II-III cohorts (1C), stratified by use of PCI.

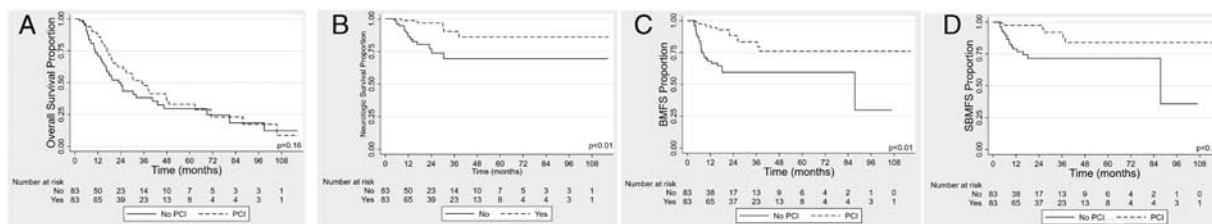

FIGURE 2. Kaplan-Meier plots of Overall Survival (2A), Neurologic Survival (2B), Brain Metastasis Free-Survival (2C), and Symptomatic Brain Metastasis-Free Survival (2D) within the propensity matched stage II-II cohort, stratified by use of PCI.

significant predictor of improved NS (HR: 0.23, 95% CI: 0.08-0.65; $P=0.01$), BMFS (HR: 0.25, 95% CI: 0.12-0.51; $P<0.01$) and SBMFS (HR: 0.21, 95% CI: 0.08-0.55; $P<0.01$), but not improved OS. 2-year NS estimates within the propensity matched cohort were 96.8% (95% CI: 87.6-99.2%) with PCI and 77.2% (95% CI: 63.0-86.4%) without PCI and 1- and 2-year estimates of incidence of brain metastases were 3.9% (95% CI: 1.3-11.7%) and 11.7% (95% CI: 5.6-23.5%) in the PCI group and 31.6% (95% CI: 22.1-43.9%) and 40.4% (95% CI: 29.2-54.0%) in the no PCI group, respectively.

Conclusions: In the modern era of MRI screening, PCI was associated with reduced incidence of intracranial progression in patients with stage II-III LS-SCLC who respond to initial therapy. This, importantly, translated to a decreased risk of neurologic death within our propensity matched cohort, without significant improvement in overall survival (Figs. 1 and 2).

(OA13) Phase II Trial Evaluating Efficacy of a Fitbit Program for Improving the Health of Endometrial Cancer Survivors

Elham Rahimy, MD¹, Melissa Usoz, BS², Rie von Eyben, MS¹, Dyllann Fujimoto, BS³, Darla Watanabe, RN¹, Amer Karam, MD¹, Arati Jairam-Thodla, NP¹, Margaret Mills, NP¹, Oliver Dorigo, MD PhD¹, Elisabeth Diver, MD¹, Nelson Teng, MD PhD¹, Diana English, MD⁴, Elizabeth Kidd, MD¹; ¹Stanford University, ²Duke University School of Medicine, ³University of California, Irvine, School of Medicine, ⁴University of South Florida

Background: Endometrial cancer has a strong association with obesity and low physical activity. Despite the favorable prognosis of early stage disease, mortality from cardiovascular disease in this patient demographic is high.

Objectives: We aimed to evaluate the efficacy of a Fitbit program to improve physical activity in endometrial cancer survivors.

Methods: Eligible patients were diagnosed with stage IA-IIIa endometrioid endometrial adenocarcinoma, at least three months out from treatment, and English- or Spanish-speaking. All participants received a Fitbit Alta and initial exercise consultation and were randomized to receive reminders/goal-setting counseling via telephone or electronic

methods (email/text). Communication was every two weeks for two months, then once during months four and five. Average daily steps were assessed weekly for nine months. BMI and quality of life were assessed at baseline and at three, six, and nine months follow-up. Changes in activity and health/quality of life metrics were evaluated with repeated measures models. Quality of life was evaluated with the FACT-G questionnaire which consists of four domains (physical, social, emotional, and functional well-being), each measured on a 24-28 point scale.

Results: The 46 analyzable patients demonstrated a baseline of 5,641 median daily average steps. Average steps increased by 22% at 6 months but decreased to baseline by nine months. Baseline activity level (daily steps and walks per week) was the greatest predictor of activity level. Only the telephone intervention participants demonstrated increased activity level at several timepoints, although not maintained by nine months (Fig. 1). BMI was unchanged. There was mild improvement in physical and social well-being in those with low baseline well-being ($P=0.009$ and 0.014 , respectively), regardless of intervention group. Emotional well-being correlated with step count ($P=0.005$).

Conclusions: Activity level was low and mildly improved on the Fitbit program with the telephone intervention, but effects did not persist by study completion. The program had the greatest impact on a select group of telephone intervention patients with high baseline walking frequency and low baseline step count. Others may require more intense intervention to promote more robust/persistent lifestyle changes.

(OA14) Survival Outcomes and Patterns of Recurrence After Adjuvant Vaginal Cuff Brachytherapy and Chemotherapy in Early-Stage Uterine Serous Carcinoma

Andrew Cook, MD¹, Ahmed Ghanem, MD PhD², Miriana Hijaz, MD², Charlotte Burmeister, MS³, Mohamed Elshaikh, MD²; ¹Department of Radiation Oncology, Henry Ford Cancer Institute, ²Henry Ford Cancer Institute, ³Henry Ford Health System

Background: Uterine serous carcinoma (USC) is a relatively rare histology that portends a poor prognosis. The optimal adjuvant therapy for early-stage USC remains controversial; however, adjuvant vaginal cuff brachytherapy (VB) and chemotherapy is a commonly utilized strategy.

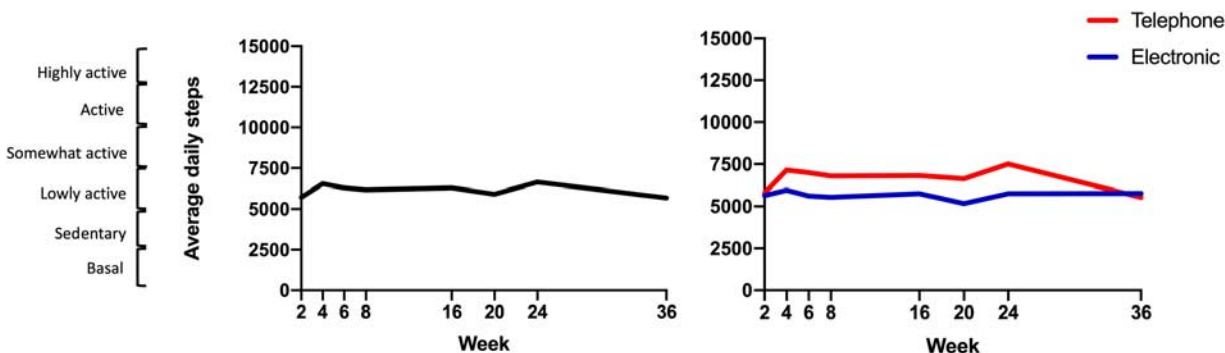

FIGURE 1. Trends in daily steps overall and by intervention group. Average daily steps during the study for the whole cohort (left) and stratified by intervention groups (right). Predicted mean trend lines are shown in bold. Tudor-Locke classification of steps is shown along the y-axis.

Objectives: We sought to characterize predictors of survival endpoints and determine recurrence patterns in women with early-stage USC who received adjuvant VB and chemotherapy.

Methods: We queried our prospectively maintained database for patients with 2009 FIGO stages I-II USC who underwent adequate surgical staging at our institution and received adjuvant chemotherapy with carboplatin and paclitaxel along with VB. We excluded women with synchronous malignancies. Overall survival (OS), disease-specific survival (DSS), and recurrence-free survival (RFS) were assessed by Kaplan-Meier and log-rank tests. Univariate (UVA) and multivariate analyses (MVA) were performed to identify statistically significant predictors of survival endpoints. Variables with $P < 0.1$ on UVA were included in a MVA and any variable with $P < 0.05$ was considered statistically significant.

Results: We identified 77 women who met our inclusion criteria who underwent surgical staging between 1991 and 2018. The median follow-up time was 36 months (range 6-125). The median age was 66 years. Of the cohort, 70% were FIGO stage IA, 17% were stage IB, and 13% were stage II. The median number of dissected lymph nodes (LN) was 22. There were 10 women (13%) diagnosed with a recurrence with a median time to recurrence of 12.0 months. The main site of initial recurrence was distant in seven patients (70%) with the remaining recurrences being pelvic/para-aortic. The 5-year RFS for patients who experienced a distant recurrence was 87% (95% Confidence Interval [CI] 0.75-0.94). For the entire cohort, 5-year OS, DSS, and RFS were 83% (95% CI 0.68-0.91), 92% (95% CI 0.78-0.97), and 83% (95% CI 0.71-0.91), respectively. The sole predictor of 5-year OS on UVA was receipt of omentectomy ($P = 0.09$). The predictors of 5-year DSS on UVA were presence of positive peritoneal cytology ($P = 0.03$), number of LN examined (Hazard Ratio [HR] 1.10, 95% CI 1.00-1.21, $P = 0.05$), and number of para-aortic LN examined (HR 1.16 [95% CI 1.01-1.32], $P = 0.03$). The sole independent predictor of DSS was the presence of positive peritoneal cytology (HR 0.03 [95% CI 0.00-0.72], $P = 0.03$). Predictors of five-year RFS on UVA were robotic vs open surgery technique ($P = 0.06$), presence of positive peritoneal cytology ($P = 0.01$), percent myometrial invasion (HR 5.59 [95% CI 0.84-37.46], $P = 0.08$), and presence of lymphovascular space invasion (LVSI) ($P = 0.05$).

Conclusions: Five-year survival outcomes were promising in this cohort of women with early-stage USC treated with adjuvant chemotherapy and VB; however, this study shows that the predominant pattern of relapse in this population is distant, suggesting the need to optimize systemic therapy. Possible predictors of worse outcomes include positive peritoneal cytology, deep myometrial invasion, and presence of LVSI. Multi-institutional pooled analyses are warranted to confirm our study results.

(OA15) A Report on the Unique Secondary Malignancy Risk Profiles for Uterine Cancer Patients Stratified by Treatment Received: A SEER Database Study Spanning 40 Years

Ryan Kraus, MD¹, Matthew Parsons, MD¹, Christopher Weil, MD¹, Johnathan Chipman, PhD², Gita Suneja, MD¹, Lindsay Burt, MD¹, Melissa Brackmann, MD³, David Gaffney, MD/PhD⁴; ¹University of Utah Huntsman Cancer Institute, ²University of Utah, ³University of Utah Huntsman Cancer Institute TRIAL, ⁴Huntsman Cancer Institute at the University of Utah

Background: As treatment outcomes for uterine cancer improve, the late side effects of treatment gain increasing importance.

Objectives: With this in mind, we sought to characterize the risk of secondary malignancies (SM) in patients with uterine cancer based on treatment modality rendered.

Methods: Patients diagnosed with uterine cancer between 1975 and 2016 were identified using the National Cancer Institute's Surveillance, Epidemiology and End Results Program database. Standardized incidence ratios (defined as observed-to-expected [O/E] relative to the endemic population), which account for patient years at risk, and absolute excess risk of SM were assessed and quantified based on treatment received. Given the standard removal of the ovaries and cervix at the time of uterine cancer surgical staging, we did not include malignancies of these sites in our analysis; nor did we include non-melanoma skin cancers.

Results: We identified 117,283 patients with uterine cancer accounting for 1,323,710 patient years at risk. In this population, 33,566 were treated

with radiotherapy (RT) and 11,019 were treated with chemotherapy (CT). 17,062 SM were observed in 14,744 (13%) patients which was similar to endemic rates (O/E 1.01, CI 1-1.03). Uterine cancer patients had higher rates of colon, rectal, breast, vaginal, vulvar, bladder, renal, and thyroid cancer compared with endemic rates (all $P < 0.05$). Bladder cancer was identified as a late occurring SM with significantly higher rates (O/E 1.94) occurring >20 years after diagnosis. There was an increased rate of SM in patients treated with CT (O/E 1.27, CI 1.18-1.37), as well as RT (O/E 1.16, CI 1.13-1.19). There was no significant difference in the rate of SM between these two types of treatment. However, each form of treatment was associated with a unique risk profile of SM. When compared with patients who received no therapy, patients treated with CT had higher rates of SM of the colon, lung/mediastinum, bladder, thyroid, and leukemia while treatment with RT was associated with a higher rate of SM of the colon, bone/joint, soft tissue, vulva, bladder, Non-Hodgkin lymphoma, and leukemia (all $P < 0.05$). When evaluating the timing of SM, patients treated with CT had significantly higher rates of secondary leukemia (O/E 2.70, CI 1.69-4.09) within the first five years of therapy than patients treated with no therapy (O/E 0.92, CI 0.76-1.11) or RT (O/E 1.22, CI 0.89-1.62). When stratifying the associated site specific SM risk of different RT modalities, we found there was a numerically higher rate of any SM in patients treated with larger volumes or higher doses of RT: brachytherapy (BT) 9.6% (O/E 1.11, CI 1.03-1.20), external beam radiotherapy (EBRT) 16.6% (O/E 1.14, CI 1.10-1.18), or combined EBRT and BT 17.9% (O/E 1.23, CI 1.17-1.29).

Conclusions: In the largest population of uterine cancer patients reported to date, we found that chemotherapy and RT were each associated with a unique profile of SM risks. This information may help facilitate targeted SM screenings in uterine cancer patients based on the treatment received.

(OA16) Limited Time Penalty for Improved Dosimetry: Simplified Needle Insertion in Combined Tandem and Ovoid + Interstitial Cases with Custom Templates

Thomas Niedermayr, PhD¹, Elizabeth Kidd, MD¹; ¹Stanford University

Background: In cervical brachytherapy the addition of interstitial (IS) needles to intra-cavitary (IC) applicators can significantly enhance dosimetry by improving target coverage without increasing normal tissues doses. Accurate placement of interstitial needles requires significant skill, time and imaging guidance proficiency, thereby limiting the benefits to a subset of practitioners and patients. Available commercial solutions lead to unsatisfactory needle locations for optimized dosimetry.

Objectives: We developed supplemental templates that attach to the tandem applicator and guide needles to optimized positions for different tumor topologies. This TARGIT (Tandem Anchored Radially Guiding Interstitial Template, patent 63/124,784) is 3D printed from sterilizable and biocompatible materials. We compared the dosimetry between tandem and ovoid (TO) implants with no needles (NN), freehand needles (FH) or using TARGIT guided needles (TN) as well as the associated procedure length.

Methods: From Feb 2017-Jan 2021, 302 implants from 70 patients (4-5 implants per patient) were treated with TO only (n=133), combined TO/IS using either free-hand needles (n=101) or TARGIT (Fig. 1) guided needles (n=68). Interstitial needles were inserted to a pre-defined depth using the pre-procedure MRI and/or from previous fractions. Varian TO Fletcher titanium applicators were inserted with either no, freehand, or TARGIT-guided needles. Post implant CT was used for planning along with MR for clinical target volume (CTV) contouring. CTV, normal tissue metrics and procedure times were compared between three groups: NN, FN or TN.

Results: The average CTV volume for the NN, FN, TN groups was 24.0 cc, 39.5 cc and 28.5 cc. The mean CTV V100% for the NN-FN-TN groups was 87.2%, 84.1% and 90.2% whereas the combined external beam + HDR normal tissue mean EQD2 doses were 79.9 Gy, 81.0 Gy and 82.0 Gy (Bladder); 62.3 Gy, 63.9 Gy and 64.7 Gy (Rectum); 66.3 Gy, 66.0 Gy and 68.2 Gy (Bowel). The difference between the FN and TN groups was significant for the V100% ($P < 0.00003$) but not for any OAR doses ($P > 0.13$), which shows the benefit of TARGIT-guided needles in improving the CTV coverage while preserving normal tissue sparing. This improvement between FN and TN groups is

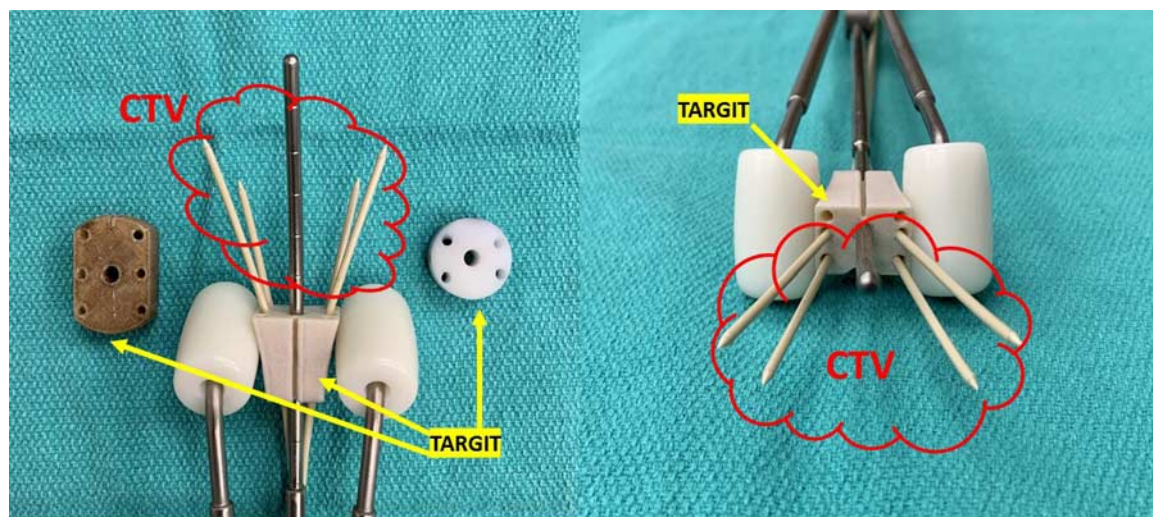

FIGURE 1. TARGIT templates with needles directed sideways towards hard-to-reach regions of the tumor.

maintained for CTV volumes larger than 25cc with V100% of 83.7% and 89.9% ($P < 0.0006$) while having a significant ($P = 0.07$) dose difference only for the bladder, increasing from 81.6 Gy to 84.8 Gy), still below the 85 Gy limit. The mean procedure time for the NN-FN-TN groups was 21 min (range, 7-58), 25 min (10-62) and 29 min (10-56), which in the TN group includes a non-negligible ultrasound imaging component for design feedback purposes.

Conclusions: The addition of TARGIT-guided needles improves CTV coverage while maintaining normal tissue sparing, in particular for CTV larger than 25cc. The simplified and optimized needle positioning with TARGIT offers an effective, economical and time-efficient solution.

(OA17) Is Substantial Lymphovascular Space Invasion Prognostic for Clinical Outcomes in Type II Endometrial Cancer?

Sushil Beriwal, MD, MBA¹, Phillip Pifer, MD, PhD², Sruthi Jaishankar², Rohit Bhargava, MD³, Andrew Keller, MD¹, Hima Bindu Musunuru, MD², Ankur Patel, MD¹, Paniti Sukumvanich, MD⁴, Madeleine Courtney-Brooks, MD⁴, Michelle Boisen, MD⁴, Jessica Berger, MD⁴, Sarah Taylor, MD⁴, Alexander Olawaiye, MD⁴, Jamie Lesnock, MD⁴, Robert Edwards, MD⁴, John Vargo, MD²; ¹UPMC Hillman Cancer Center, ²Department of Radiation Oncology, Hillman Cancer Center, University of Pittsburgh Medical Center, ³Department of Pathology, Magee-Women's Hospital, University of Pittsburgh Medical Center, ⁴Department of Gynecologic Oncology, Magee-Women's Hospital, University of Pittsburgh Medical Center

Background: Analysis of PORTEC 1&2 demonstrated substantial lymphovascular space invasion (LVSI) compared with none or focal LVSI was predictive for pelvic recurrence, distant metastasis, and overall survival (OS) in Type I endometrial cancer (Bosse T, et al Eur J Cancer, 2015). Subsequently, substantial LVSI has been associated with lymph node (LN) involvement in this histologic subtype (Pifer PM, et al Gyn Onc 2020). Although LVSI has been associated with worse outcomes in Type II (clear cell and serous) endometrial cancer, the effect of substantial LVSI has not been investigated.

Objectives: We aimed to quantify the relationship of substantial LVSI on Type II endometrial cancer histologic subtypes and to correlate extent of LVSI with LN involvement, loco-regional disease-free survival (LRDFS), distant metastasis-free survival (DMFS) and OS.

Methods: A retrospective review was conducted on patients with Type II endometrial cancer (serous and/or clear cell histology with or without endometrioid component) who underwent surgical staging from July 2017 to December 2019. Patients were excluded if they received neoadjuvant therapy or had synchronous cancers. χ^2 was used to assess the correlation between the extent of LVSI and clinical/pathological factors. For univariate and multivariable analysis, LVSI was defined as none/focal versus

substantial. Binary logistic regression was used for univariate analysis. For the multivariate analysis with forward conditional selection, all variables with $P < 0.05$ on univariate analysis were entered into the model. LRDFS, DMFS and OS were analyzed using the Kaplan-Meier method.

Results: After surgical staging, 79 patients with Type II endometrial carcinomas were identified (41 pure serous histology, 11 pure clear cell histology and the remainder being of mixed histology). No LVSI was present in 48.1%, focal LVSI was present in 15.2%, and substantial LVSI was present in 36.7% of samples. In patients with LN evaluation (72 out of 79), lymph nodes were involved in 0.0% without LVSI, 20.0% with focal LVSI, and 60.0% with substantial LVSI ($P < 0.001$). On univariate analysis, myometrial invasion $> 50\%$ (OR 33.8, 95% CI 6.6-171.7), tumor size > 3.6 cm (OR 10.5, 95% CI 2.91-37.83), and substantial LVSI versus none/focal LVSI (OR 10.5, 95% CI 2.91-37.83) were significant predictors for LN involvement. On multivariable analysis, myometrial invasion $> 50\%$ and substantial LVSI versus none/focal LVSI remained significant predictors of LN involvement ($P = 0.002$ and $P = 0.002$). With a median follow-up of 22.2 months, the 2-year LRDFS, DMFS, and OS was 91.5% vs 71.4% ($P = 0.01$), 90.2% vs 63.8% ($P = 0.005$), and 95.4% vs 72.3% ($P = 0.072$) for none/focal versus substantial LVSI.

Conclusions: Incidence of substantial LVSI is higher in Type 2 endometrial pathologies compared with Type I disease. Substantial LVSI is associated with higher risk of LN involvement and worse clinical outcomes in Type II endometrial cancer.

(OA18) Creation of Appropriate Use Criteria for Management of Uterine Clear Cell and Serous Carcinomas

Tracy Sherertz, MD¹, Catheryn Yashar, MD², Anuja Jhingran, MD³, Andrew Wahl, MD⁴, Mohamed Elshaiikh, MD⁵, Robert Coleman, MD³, Matthew Biagioli, MD⁶, Elizabeth Kidd, MD⁷, David Gaffney, MD/PhD⁸, Matthew Harkenrider, MD⁹, Aradhana Venkatesan, MD³, Shruti Jolly, MD¹⁰, Lorraine Portelance, MD¹¹, Karen Heskett, MSI¹², William Small, MD, FACRO, FACR, FASTRO¹³; ¹Kaiser Permanente Washington, ²UCSD, ³MD Anderson Cancer Center, ⁴University of Nebraska Medical Center, ⁵Henry Ford Cancer Institute, ⁶Advent Health, ⁷Stanford University, ⁸Huntsman Cancer Institute at the University of Utah, ⁹Loyola University Chicago, ¹⁰University of Michigan Department of Radiation Oncology, ¹¹University of Miami Health System, ¹²University of California San Diego, ¹³Loyola University Chicago, Stritch School of Medicine, Cardinal Bernardin Cancer Center

Background: Uterine serous carcinomas (USC) and uterine clear cell carcinomas (UCCC) represent a subset of endometrial cancers that have a high propensity for peritoneal, lymphatic and distant spread, tend to be more advanced at presentation, and carry a higher risk of recurrence and death compared with most estrogen-mediated endometrioid

carcinomas. Both USC and UCCC have typically been pooled into studies that include other high-risk uterine cancers, but neither histology has been exclusively studied in large prospective clinical trials. Thus, the optimal treatment paradigm for each individual histology remains somewhat undefined, especially in early stage disease limited to the uterus. Adjuvant treatment options include chemotherapy, vaginal cuff brachytherapy (VBT) and pelvic +/- para-aortic external beam radiotherapy (EBRT), or both, with multimodality therapy typically considered for these aggressive tumors.

Objectives: We sought to rate the appropriateness of treatment procedures for a variety of USC and UCCC cases by a multidisciplinary expert panel including gynecological oncologists and radiation oncologists with expertise in the treatment of uterine cancer.

Methods: An extensive and updated analysis of current medical literature from peer-reviewed journals was conducted from 1/1/1996-1/28/2020 using the Preferred Reporting Items for Systematic Reviews and Meta-analyses (PRISMA) guidelines to search the PubMed, Embase and Web of Science databases to retrieve a comprehensive set of relevant articles. We developed strategies using subject and combinations of keywords search terms. We reviewed the bibliographies of full articles for a comprehensive survey, and relevant studies were included. The literature was reviewed for quality of study design, cohort size, selection bias, variability of evaluation of participants in regard to time from exposure, and methods of assessments. In addition, two significant studies published in 12/20 and 2/21 were selectively included during writing of the manuscript. A well-established consensus methodology (modified Delphi) was used to rate the appropriateness of treatment procedures by the expert panel.

Results: The panel recommends strongly vaginal cuff brachytherapy (VBT) alone or systemic therapy + VBT as adjuvant treatment for a non-invasive surgically staged FIGO stage IA UCCC or USC. The panel recommends strongly that adjuvant chemotherapy and radiation therapy is usually appropriate for a typical case of FIGO stage IB UCS and UCCC; an exception is the option for pelvic EBRT alone for a surgically staged IB UCCC with minimal risk features. The panel recommends strongly that tumor volume-directed radiation treatment is usually appropriate in the adjuvant setting of patients with advanced stage USC or UCCC. IMRT is the recommended treatment technique when EBRT is recommended. For patients who undergo pelvic and para-aortic lymph node sampling and are pN0, the panel recommends strongly omitting the para-aortics from the external beam field, while there was some disagreement on whether to target para-aortic lymph nodes when the pelvic lymph nodes are known to be involved yet the para-aortic sampling was negative. The panel strongly recommends against the routine use of adjuvant WART outside of a clinical trial setting.

Conclusions: Due to the rarity of uterine clear cell and serous carcinomas, there is a paucity of prospective trials focusing exclusively on management of these aggressive histologies and hence there is no standard consensus for treatment strategy in patients with uterine clear cell and serous carcinoma. Given the aggressive nature of these malignancies, and until further research determines the most appropriate adjuvant therapy, it may be reasonable to counsel patients about combined modality treatment with systemic chemotherapy and RT. Further prospective studies or multi-institutional retrospective studies are warranted to determine optimal sequencing of therapy and appropriate management of patients based on their unique risk factors.

(OA19) An Open-Label, Phase II, Multicenter, Single-Arm Study of Induction and Concurrent Vismodegib Combined with Curative-Intent Radiation Therapy for Locally Advanced Basal Cell Carcinoma

Sue Yom, MD, PhD, MAS¹, Sarah Arron, MD, PhD¹, Alan Ho, MD, PhD², Alain Algazi, MD¹, Lara Dunn, MD², C. Jillian Tsai, MD, PhD, MS², Audrey Humphries, BS¹, Carter Hultman, BS³, Roy Grekin, MD³, P. Daniel Knott, MD³, Christopher Barker, MD²; ¹University of California, San Francisco, ²Memorial Sloan Kettering Cancer Center, ³UCSF

Background: Vismodegib is effective for basal cell carcinoma (BCC) that cannot be removed with surgery. Its feasibility and efficacy combined with definitive-intent radiation therapy (RT) have not been previously established. This phase II, multicenter clinical trial assessed the disease response and toxicity resulting from a combined-modality

course of vismodegib 150 mg daily before and concurrent with curative-intent RT to 66-70 Gy.

Objectives: To assess the primary endpoint of local-regional control (LRC) rate at 12 months from completion of the protocol as well as the secondary endpoints of rates of adverse events (AEs), overall response rate (ORR), and rates of progression-free survival (PFS) and overall survival (OS).

Methods: Eligible patients were required to have inoperable BCC due to surgical futility, functional morbidity or medical contraindication. Ineligibility criteria included prior RT overlapping planned RT, presence of distant metastasis, Gorlin syndrome, administration of any competing therapies, or malignancy or HIV with life expectancy of <1 year such that the patient would not complete the trial endpoint. Patients received 12-14 weeks of vismodegib followed by 6.5-7 weeks of RT with concurrent vismodegib. The primary endpoint of LRC rate at 12 months from end of treatment (EOT) was defined as no evidence of progression within the RT volume. A sample size of 24 yielded 81% power to detect an increase in LRC from 60% to 80%, assuming a directional level of significance of 0.10 based upon a one-sample exact binomial test. Secondary endpoints were AEs, ORR, PFS, and OS.

Results: 24 patients, including 18 men and 6 women having a median age of 68 years (range, 50-98), were enrolled. During induction, 1 patient withdrew consent due to travel and 4 discontinued vismodegib due to AEs. 1 discontinued vismodegib during RT due to AEs. 1 expired just after EOT from pre-existing aortic aneurysm. Thus 17/24 patients were evaluable for the primary endpoint. During the study, 1 patient had grade 4 eye disorder, and 9 (38%) patients had grade 3 AEs including hyponatremia (13%), oral mucositis (8%), gastrointestinal (8%) or dermatologic (8%) disorder, liver function (4%), anemia (4%), and hypertension (4%). 19 (79.2%) patients had grade 2 AEs including dermatitis (33%), dysgeusia (33%), myalgia (25%), fatigue (21%), oral mucositis (21%), and weight loss (17%). At end-of-induction, the ORR among 19 evaluable patients was 74%, while at 3 months post-EOT, among 17 evaluable it was 88%. At 12 months post-EOT, all 17 were alive with LRC. For all 24 patients, the median followup was 33 months (range, 0-62), and the estimated 3-year PFS and OS were 82% (95% CI, 59-93%) and 91% (95% CI, 68-98%), respectively. Among 17 evaluable patients, the median followup was 31 months (range, 16-62), and the 3-year PFS and OS were 88% (95% CI, 61-97%) and 100%, respectively. No patient developed distant metastasis.

Conclusions: Vismodegib-RT was efficacious with an expected toxicity profile. The potential advantages of this strategy are wound healing and contracture of subclinical disease before RT as well as radiosensitization during RT. Concurrent vismodegib did not affect completion of definitive-intent RT. This is the first clinical trial reporting a novel strategy of combining targeted therapy with RT for unresectable, locally advanced BCC.

(OA20) Predictors of Pathologic Lymph Node Positivity in Clinically Node Negative Oral Cavity Cancer Patients

Eric Anderson, MD¹, Michael Luu, MPH¹, Diana Lu, MD¹, Eric Chung, MD¹, Christopher Gay, MD¹, Kevin Scher, MD¹, Alain Mita, MD¹, Jon Mallen-St. Clair, MD¹, Allen Ho, MD¹, Zachary Zumsteg, MD¹; ¹Cedars-Sinai Medical Center

Background: Most patients undergoing surgery for clinically node-negative (cN0) oral cavity cancer (OCC) require elective neck dissection (END) based on randomized controlled trials showing improved survival with END versus observation. Prior retrospective studies have suggested that primary tumor depth of invasion (DOI) is the dominant predictor of occult lymph node involvement and can be used to select patients for omission of END. However, these studies primarily focused on oral tongue cancers, and it is unclear if the importance of DOI is applicable to other oral cavity cancers. Moreover, the independent predictive value of DOI in comparison with other correlated factors like T-stage, grade, and lymphovascular invasion is not well established.

Objectives: We sought to systematically examine predictors of pN+ for cN0 oral cavity cancers of various sites.

Methods: Patients with cN0 oral cavity cancers with at least 2 mm DOI diagnosed from 2010-2015 and undergoing primary surgery were identified in the National Cancer Data Base. Patients with missing pathologic variable data were excluded. Multivariable logistic regression was performed to assess predictors of pN+.

Results: 5060 cN0 patients met inclusion criteria, including 1127 (22.3%) pN+ patients. pN+ rates varied by OCC subsites (oral tongue: 25.6%; floor of mouth: 19.4%; other sites: 19.3%). In multivariable logistic regression, the presence of lymphovascular invasion (LVI) was the strongest predictor of pN+ (odds ratio [OR] = 4.28, 95% confidence interval [CI] 3.34-5.44, $P < 0.001$). Histologic grade also strongly predicted pN+ (high- vs. low-grade: OR 3.18, 95% CI 2.24-4.55, $P < 0.001$; intermediate- vs. low-grade: OR 2.20, 95% CI 1.64-2.98, $P < 0.001$). Other predictors of pN+ were higher pT-stage and oral tongue primary site. DOI was not a predictor of pN+ among the full cohort of OCC patients. However, DOI did independently correlate with pN+ in the oral tongue subgroup (≥ 20 mm, OR 2.04, 95% CI 1.08-3.82, $P = 0.027$; 10-19.99 mm, OR 1.67, 95% CI 1.10-2.57, $P = 0.018$), although LVI and grade remained the strongest predictors of pN+ in this anatomic site.

Conclusions: LVI and histologic grade are the strongest predictors of pN+ among patients with cN0 OCC. DOI predicts pN+ in patients with oral tongue cancer, but not for patients with OCCs of other anatomic subsites. Even for oral tongue cancer, DOI was found to be a weaker predictor than LVI or histologic grade. These factors should be given greater consideration when determining which patients require END.

(OA21) 5-Year Longitudinal Analysis of Patient-Reported Outcomes and Cosmesis in a Randomized Trial of Conventionally Fractionated versus Hypofractionated Whole-Breast Irradiation

Benjamin Smith, MD¹, Julius Weng, MD², Xiudong Lei, PhD², Pamela Schlembach, MD², Elizabeth Bloom, MD², Simona Shaitelman, MD,

Med³, Isidora Arzu, MD, PhD², Daniel Buchholz, MD⁴, Gregory Chronowski, MD², Tomas Dvorak, MD⁴, Emily Grade, MD⁵, Karen Hoffman, MD, MPH², George Perkins, MD, MBA⁶, Valerie Reed, MD², Shalin Shah, MD², Michael Stauder, MD², Eric Strom, MD², Welela Tereffe, MD², Wendy Woodward, MD PhD¹, Gabriel Hortobagyi, MD², Kelly Hunt, MD², Thomas Buchholz, MD⁷; ¹University of Texas MD Anderson Cancer Center, ²MD Anderson Cancer Center, ³Department of Radiation Oncology, The University of Texas MD Anderson Cancer Center, ⁴Orlando Health UF Health Cancer Center, ⁵Banner MD Anderson Cancer Center, ⁶smoulder@mdanderson.org, ⁷Scipps MD Anderson Cancer Center

Background: Whole-breast irradiation (WBI) is well-tolerated by the majority of women with early breast cancer, however, a significant minority experience persistent treatment-related toxicity and suboptimal cosmetic results. There is little data on clinically relevant predictors of patient- and physician-reported outcomes after WBI plus a boost, and whether unique subsets of patients experience better outcomes after hypofractionation compared with conventional fractionation.

Objectives: To characterize longitudinal PROs and cosmesis obtained in a prospective, randomized trial comparing conventionally fractionated (CF) vs hypofractionated (HF) WBI plus boost.

Methods: From 2011 to 2014, women age ≥ 40 years with Tis-T2, N0-N1a, M0 breast cancer who underwent lumpectomy with negative margins were randomized to CF-WBI (50 Gy/25 fractions plus boost) vs HF-WBI (42.56 Gy/16 fractions plus boost). At baseline (pre-radiation), 6 months, and yearly thereafter through 5 years, PROs included the Breast Cancer Treatment Outcome Scale (BCTOS), Functional Assessment of Cancer Therapy-Breast (FACT-B), and Body Image

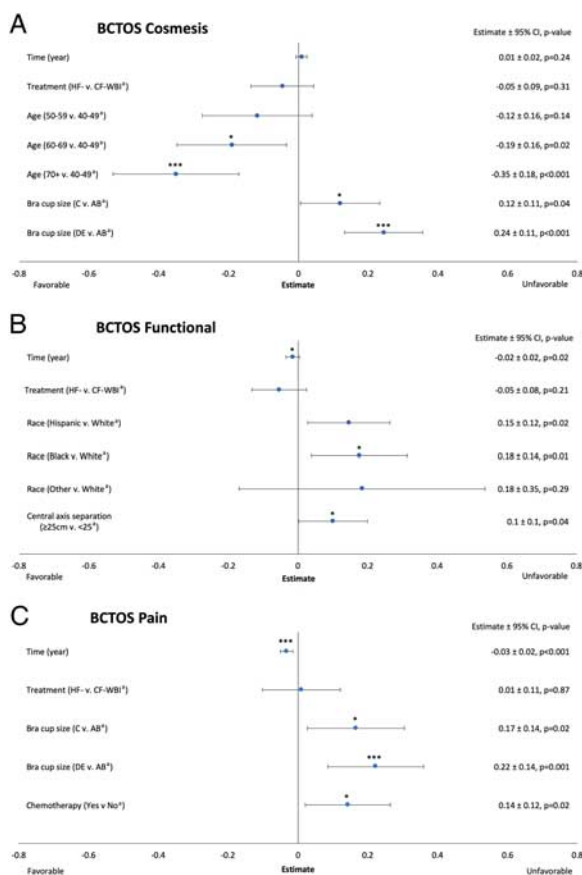

FIGURE 1. BCTOS longitudinal multivariable mixed-effects growth curve models. A lower score indicates a better outcome. A indicates referent group, * indicates P -value < 0.05 , *** indicates P value < 0.001 , 95% CI=95% confidence interval, HF = hypofractionated, CF = conventionally fractionated, WBI = whole-breast irradiation.

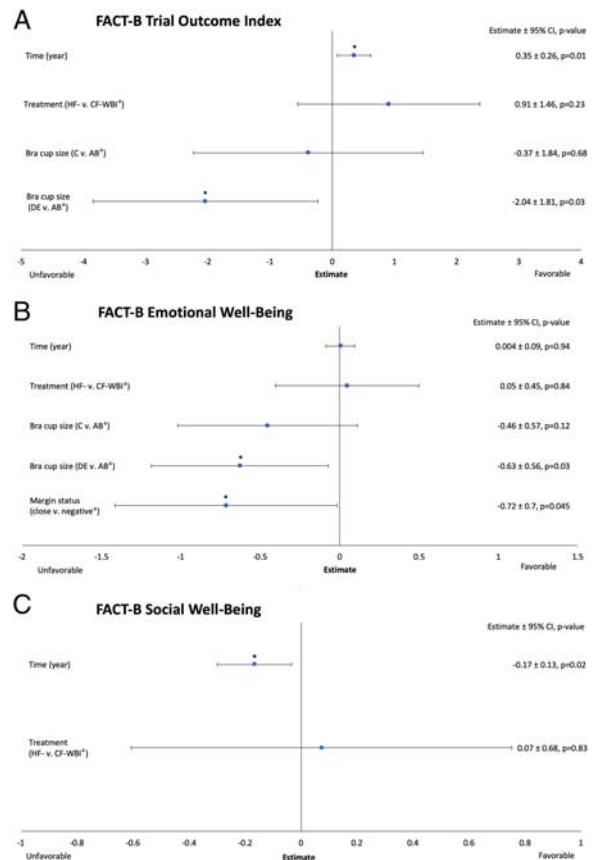

FIGURE 2. FACT-B longitudinal multivariable mixed-effects growth curve models. A higher score indicates a better outcome. A indicates referent group, * indicates P -value < 0.05 , *** indicates P value < 0.001 , 95% CI=95% confidence interval, HF = hypofractionated, CF = conventionally fractionated, WBI = whole-breast irradiation.

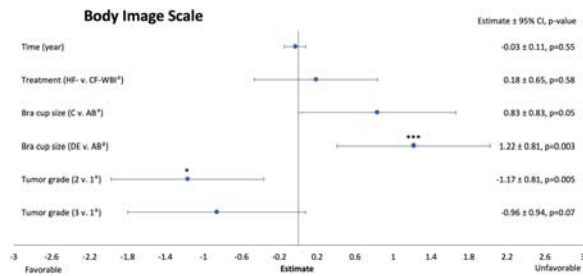

FIGURE 3. Body Image Scale (BIS) longitudinal multivariable mixed-effects growth curve model. A lower score indicates a better outcome. a indicates referent group, * indicates P -value < 0.05, ** indicates P value < 0.01, *** indicates P value < 0.001, 95% CI = 95% confidence interval, HF = hypofractionated, CF = conventionally fractionated, WBI = whole-breast irradiation.

Scale; cosmesis was reported by the treating physician using Radiation Therapy Oncology Group cosmesis. Multivariable mixed effects growth curve models evaluated associations of treatment arm and patient factors with outcomes and tested for relevant interactions with treatment arm.

Results: A total of 287 patients were randomized, completing a total of 14,801 PRO assessments. Median age was 60 years, median follow up was 48.3 months, 37% had bra cup size $\geq D$, 44% were obese, and 30% received chemotherapy. Patient, tumor, and treatment characteristics were well-balanced between the two treatment arms. Through 5 years, there were no significant differences in PROs or cosmesis by treatment arm. Bra cup size $\geq D$ was associated with worse BCTOS cosmesis ($P < 0.001$), BCTOS pain ($P = 0.001$), FACT-B Trial Outcome Index ($P = 0.03$), FACT-B Emotional Well-Being ($P = 0.03$), and Body Image Scale ($P = 0.003$). Chemotherapy receipt was associated with worse BCTOS pain ($P = 0.02$). Physician-rated cosmesis was worse in patients who were overweight ($P = 0.02$) or obese ($P < 0.001$), relative to those with a normal weight. No patient subsets experienced better PROs or cosmesis with CF-WBI.

Conclusions: Both CF-WBI and HF-WBI confer similar longitudinal PROs and physician-rated cosmesis through five years follow up, with no relevant subsets that fared better with CF-WBI. The associations of large breast size and obesity with adverse outcomes across multiple domains highlights the opportunity to engage at-risk patients in lifestyle intervention strategies, as well as consideration of alternative radiation treatment regimens, such as partial breast irradiation (Figs. 1–3).

(OA22) Surgical Drain Fluid Liquid Biopsy Analysis of Locoregional Residual Disease After Surgery in HPV+ Oropharyngeal Cancer for Adjuvant Radiotherapy Risk Stratification

Noah Earland, BS¹, Ricardo Ramirez, MD², Peter Harris, PhD³, Sophie Gerndt, MD², Jeffrey Szymanski, MD, PhD⁴, Benjamin Wahle, MD², Katherine Chang, MD², Jose Zevallos, M.D., MPH, FACS², Aadel Chaudhuri, MD, PhD⁴; ¹Washington University in St. Louis School of Medicine, ²Washington University School of Medicine, ³Department of Radiation Oncology, Washington University School of Medicine in St. Louis, ⁴Washington University School of Medicine in St. Louis

Background: In the current era of treatment de-intensification for HPV + oropharyngeal squamous cell carcinoma (OPSCC), we urgently need to improve adjuvant treatment risk stratification after surgery.

Objectives: We present a novel, objective, proximal, and quantifiable biomarker of locoregional residual disease (LRD): surgical drain fluid (SDF). We hypothesize that elevated HPV viral load in SDF correlates directly with high-risk surgical pathology and can help risk-stratify adjuvant chemo/radiotherapy.

Methods: Eighty-four SDF neck dissection specimens were collected postoperatively at 24 hours from 58 HPV+ OPSCC patients. We measured SDF blood content using the NanoDrop Oxy-hemoglobin method. Limit of detection (LOD) of Taqman quantitative PCR (qPCR)

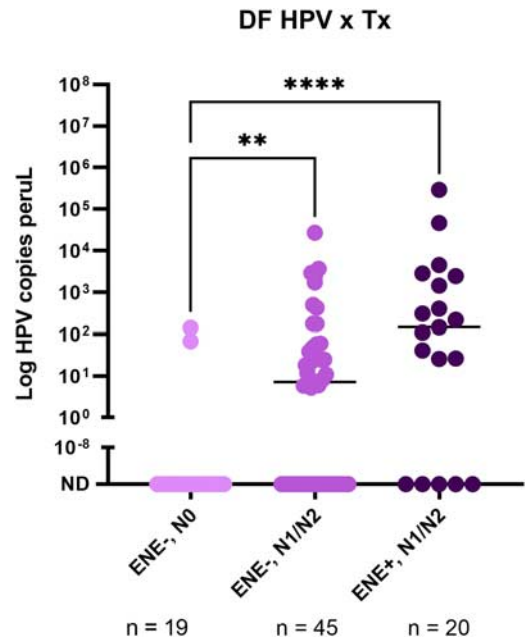

FIGURE 1. HPV levels in postoperative surgical drain fluid versus surgical pathology. All 84 SDF samples were categorized according to the local pathological diagnosis of the neck from which they were extracted; ENE+ N1 or N2, ENE- N1 or N2, and N0. ENE+ N1/N2 had the significantly highest HPV levels in SDF (median 145 copies/uL), followed by ENE- N1/N2 (median 7 copies/uL), and lastly, the N0 necks (median ND). ND = not detected.

was compared with digital droplet PCR (ddPCR) by analyzing 10-fold dilutions of the HPV16 E6T2aE7 plasmid. HPV copies/uL in DNA eluted from SDF were then compared with pathological features (ENE, number of positive nodes). HPV detection was also performed in paired plasma samples from 25 node+ patients. Statistical analyses included Wilcoxon, Kruskal-Wallis, Fisher's exact testing, and Spearman correlation. AJCC 8th edition was used for staging.

Results: LOD was 5 HPV copies using Taqman qPCR with 24 replicates and >95% confidence. This was similar to the LOD attained by ddPCR, so we used Taqman qPCR for further analyses. Hemoglobin concentration had no correlation to HPV levels ($\rho = -0.07$, $P = 0.53$). The proportion of N1-N2 necks with HPV levels above LOD was 6-fold higher than N0 necks ($P < 0.0001$; Fig. 1). Furthermore, median HPV copies were 20-fold higher in ENE+ N1-N2 compared with ENE- N1-N2 necks ($P = 0.015$; Fig. 1). These data suggest that post-operative SDF HPV detection levels reflect invasive nodal disease and serve as a proxy for LRD. As adjuvant therapy escalation occurs in patients with higher-risk disease, stratifying SDF by eventual adjuvant therapy type—radiation alone (XRT), chemoradiation (CRT), or none (No Tx)—revealed that median HPV load was higher in CRT and XRT than in No Tx ($P = 0.044$; Fig. 2). Strikingly, 15 (33%) patients treated with XRT or CRT had undetectable HPV in their SDF, suggesting these patients could potentially have safely undergone treatment de-escalation. Also, 3 of 18 (17%) patients treated with adjuvant CRT with detectable HPV in SDF experienced suspicious or confirmed recurrence, suggesting they could have potentially benefited from further or orthogonal treatment escalation (i.e. immunotherapy). Lastly, only 4 (16%) post-operative paired plasma samples had detectable HPV, implying inferior sensitivity for detecting LRD compared with SDF.

Conclusions: Postoperative qPCR of SDF enables LRD detection in HPV+ OPSCC. SDF is highly enriched for HPV compared with plasma and correlates significantly with aggressive pathologic features (nodal stage, ENE) and adjuvant treatment escalation. If confirmed, post-operative SDF analysis could someday aid traditional pathology to personalize adjuvant therapy for surgically treated HPV+ OPSCC.

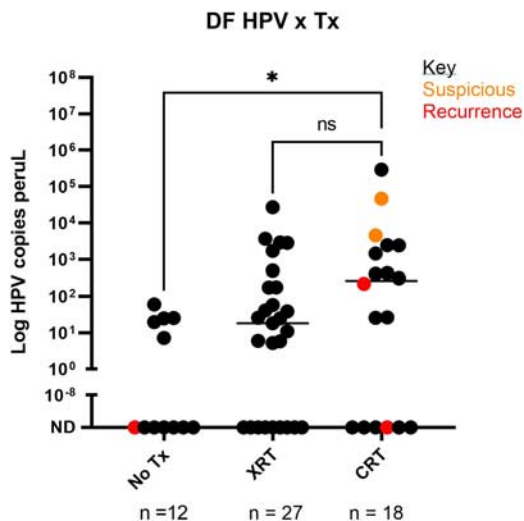

FIGURE 2. HPV levels in postoperative surgical drain fluid by adjuvant treatment type. SDF was collected postoperatively (the SDF with the higher HPV copies was used for patients with bilateral neck dissections). There was a non-significant elevation in SDF HPV levels from patients who went on to receive chemoradiation therapy (CRT) compared with only radiation therapy (XRT) (median 263 vs. 18 copies/uL; $P=0.56$). SDF from patients in the CRT group was significantly enriched for HPV compared with no treatment (No Tx) (median 263 copies/uL vs. ND; $P=0.026$). The single patient that recurred in the No Tx group was deemed to be high-risk but declined adjuvant radiotherapy. ND = not detected.

(OA23) DNA Damage Response Inhibitors Potentiate Immunogenic Cell Death and Radiotherapy in Merkel Cell Carcinoma

Peter Goff, MD, PhD¹, Rashmi Bhakuni, PhD¹, Thomas Pulliam¹, Ramesh Rengan, MD, PhD¹, Paul Nghiem, MD, PhD¹; ¹University of Washington

Background: Metastatic cancer with primary or acquired resistance to immune checkpoint inhibitors requires novel management strategies. Merkel cell carcinoma (MCC) is immunogenic with the highest response rate to PD-1 pathway blockade among solid tumors such that approximately 50% of patients with advanced MCC attain durable disease control. Cell cycle checkpoint and DNA damage response (DDR) proteins, including ATR, ATM & DNA-PK, have been recognized as promising therapeutic targets for decades. However, it is only recently described in preclinical studies that targeting the DDR may stimulate anti-tumor immunity and augment existing immunotherapies. Importantly, specific and potent DRR inhibitors (DDRi) are in early-phase clinical investigation. The rapid growth of MCC is driven by deregulation of early cell cycle components (e.g. p53 & Rb inactivation paired with Myc protein upregulation), suggesting high replication stress and susceptibility to DDRi or DNA damaging agents. MCC tumors are particularly radiosensitive. The mechanisms governing how DDRi may interact with radiation to promote antitumor immunity are not well understood; however, they may potentiate immunogenic cell death (ICD) to recruit and activate antigen presenting cells.

Objectives: We assessed if several classes of DDRi, alone or in combination with radiation, potentiated ICD and quantified their potencies as radiosensitizers in MCC cell lines. These preclinical studies are an early test of our hypothesis that DDRi could play a role in the treatment of PD-1 pathway blockade-refractory MCC.

Methods: Representative Merkel cell polyomavirus positive (VP) and negative (VN) MCC cell lines were treated with various doses of single fraction radiation (0, 2, 4, 8, 16 Gray; 160 kV x-rays) +/- inhibitors of ATR, ATM or DNA-PK (ATRi, ATMi and DNA-PKi). Cells were assessed for viability and hallmarks of ICD including extracellular ATP

release (luciferase assay) and HSP70 secretion (ELISA) at 1 - 5 days post-treatment.

Results: Inhibitors of ATR, ATM and DNA-PK are all effective radiosensitizers of MCC, and DNA-PKi proved the most potent with an enhancement ratio of ~5-fold compared with ~2-fold or less for ATMi or ATRi across cell lines. ATRi and ATMi induced extracellular release of ATP or HSP70 alone or in combination with low dose radiation (2 - 4 Gy) more effectively than when combined with radiation doses of ≥ 8 Gy in VP and VN cell lines. DNA-PKi, however, had limited ability to potentiate these ICD markers alone and, in fact, abrogated extracellular ATP release compared with radiation alone in a VP cell line.

Conclusions: Either alone or in combination with low-dose radiation (1 fraction of 2-4 Gy), ATRi and ATMi more effectively induced canonical markers of ICD in MCC cell lines compared with DNA-PKi. DNA-PKi was superior as a radiosensitizer; however, it apparently enhanced a non-immunogenic mechanism of cell death. Elucidating the cell death pathways induced by radiation and DDRi in MCC is underway. Understanding why relatively lower radiation doses appear more immunogenic when combined with ATRi and ATMi is of particular interest. Given its inherent immunogenicity, cell cycle checkpoint deficiencies and radiosensitivity, MCC is relevant for the preclinical and clinical evaluation of DDRi as novel agents to overcome PD-1 pathway blockade resistance.

(OA24) What Is Reasonably Achievable? Evaluation of Left Breast Mean Heart Dose Distributions to Improve the Peer Review Process

Amit Sood, MD¹, Rachel Hackett, CMD, RTT¹, Mark Farrugia, MD, PhD¹, Varun Chowdhry, MD¹; ¹Roswell Park Comprehensive Cancer Center

Background: To improve the peer review process, our Radiation Oncology department defined disease site specific dose constraints for organs at risk (OARs) based on QUANTEC and national protocols. However, there is opportunity to improve on these existing dose constraints.

Objectives: For patients undergoing radiotherapy to the left breast, our departmental mean heart dose constraint is 3 Gy. However, in our experience this constraint is achievable in virtually all circumstances. To improve the process of peer review, we wanted to understand the distribution of mean heart dose (MHD) for patients treated at our center to identify plans that are potential outliers.

Methods: We retrospectively reviewed aggregate data from peer reviewed treatment plans for patients treated at our center from 2019 to 2020 utilizing Radiologica software (Radiologica LLC, St. Louis, MO). We analyzed MHD in patients being treated with hypofractionated radiotherapy (HFx, 40 Gy/15fx) +/- boost for left whole breast as well as patients treated with conventional fractionated radiotherapy (CFx, 50 Gy/25fx) in patients undergoing regional nodal irradiation (RNI) +/- boost. All patients underwent deep inspiratory breath hold (DIBH).

Results: A total of 191 patients were identified, including 162 in the HFx group and 29 in the CFx group. Using a student's t-test, the use of a boost did not impact the mean heart dose ($P=0.44$). In both the HFx and CFx group, there were no patients who exceeded 3 Gy MHD. In the HFx group, MHD was 0.82 Gy (95% CI, 0.37 - 1.72), and there were 7/162 (4.3%) of cases identified with the MHD exceeding two-standard deviations (> 1.72 Gy). In the CFx group, MHD was 1.46 Gy (95% CI 0.34-2.58), and there were 0/29 (0%) of cases identified with mean heart dose exceeding two-standard deviations (> 2.58 Gy).

Conclusions: For patients undergoing radiotherapy for left sided breast cancer, a MHD of 3 Gy is not helpful to stratify cases that need more detailed peer review. Based on our results, we recommend an additional physician and dosimetrist review of contours and treatment plan where mean heart dose falls two standard deviations outside the mean (> 1.72 Gy). This standard will serve for a future quality improvement project. Understanding the distribution of doses to a particular OAR can be helpful in identifying plans that could benefit from more careful peer review. This process can be used for other OARs and disease sites.

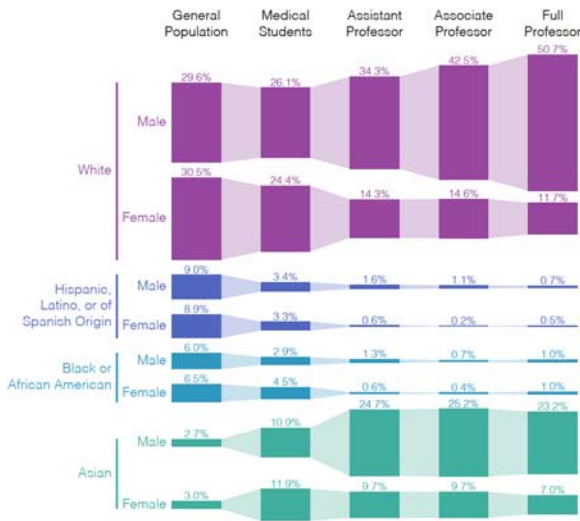

FIGURE 1. Proportion of each race/ethnicity and sex for radiation oncology pipeline in 2019.

(OA25) Intersection of Race or Ethnicity and Sex on Senior Faculty Representation in Radiation Oncology: Mixed Changes from 2000 to 2019

James Janopaul-Naylor, MD¹, Lauren Beck², Sanford Roberts, MD³, Jeffrey Switchenko, PhD, MS¹, Mylin Torres, MD¹; ¹Winship Cancer Institute at Emory University, ²University of Pennsylvania, ³University of Pennsylvania Department of Surgery

Background: Radiation Oncology (RO) is a small, specialized field of medicine traditionally included in Radiology (R) Departments until the 1980s. Given work hours primarily confined to the business week with few emergencies, the opportunity to care for cancer patients, and favorable compensation, RO is a potentially attractive career. Advantages of a diverse physician workforce include higher patient satisfaction, patient compliance with physician recommendations, and increased participation of under-represented minority (URM) patients in clinical research (Cooper-Patrick et al, JAMA 1999; Branson et al, Am J Surg 2007). However, data from 2000 to 2020 indicate that URM and female representation in RO continues to be poor, with the field having less diversity than in medical schools and even other oncology specialties (Chapman et al IJROBP 2013; Deville et al, IJROBP 2020).

Objectives: The goal of this study was to determine the proportion of women and URMs senior faculty over the last two decades in RO relative to other departments. We compared RO to Internal Medicine (IM), General Surgery (GS) and R given the large number of physicians in IM and GS and the historical relationship RO has with R.

Methods: AAMC data were used to determine the proportion of women and URMs in senior faculty positions (Full or Associate Professors) in RO relative to IM, GS, and R. Comparisons were assessed using the Cochran-Armitage trend test and multivariable linear regression models using SAS.

Results: From 2000 to 2019, the proportion of women and Asian male senior faculty increased among RO, IM, GS, and R Departments ($P < 0.001$). The proportion of senior faculty who were women increased faster in RO than GS or R ($P < 0.001$) but slower than in IM ($P < 0.001$). While the proportion of senior faculty that were non-White increased fastest in RO (1.00% per year, $P < 0.001$), this change in representation was largely due to the increase in Asian males. The increase in proportion of non-white/non-Asian faculty who became senior faculty over time was significantly lower in RO (0.04% per year) than in GS (0.16% per year, $P < 0.001$), IM (0.24% per year, $P < 0.001$) or R (0.12% per year, $P < 0.001$). The proportion of Black male senior faculty in RO decreased 70% (Fig. 1) since 2000, while remaining stable in other departments. Full, Associate, or Assistant Professors who identified as American Indians, Alaskan Natives, Native Hawaiians, or

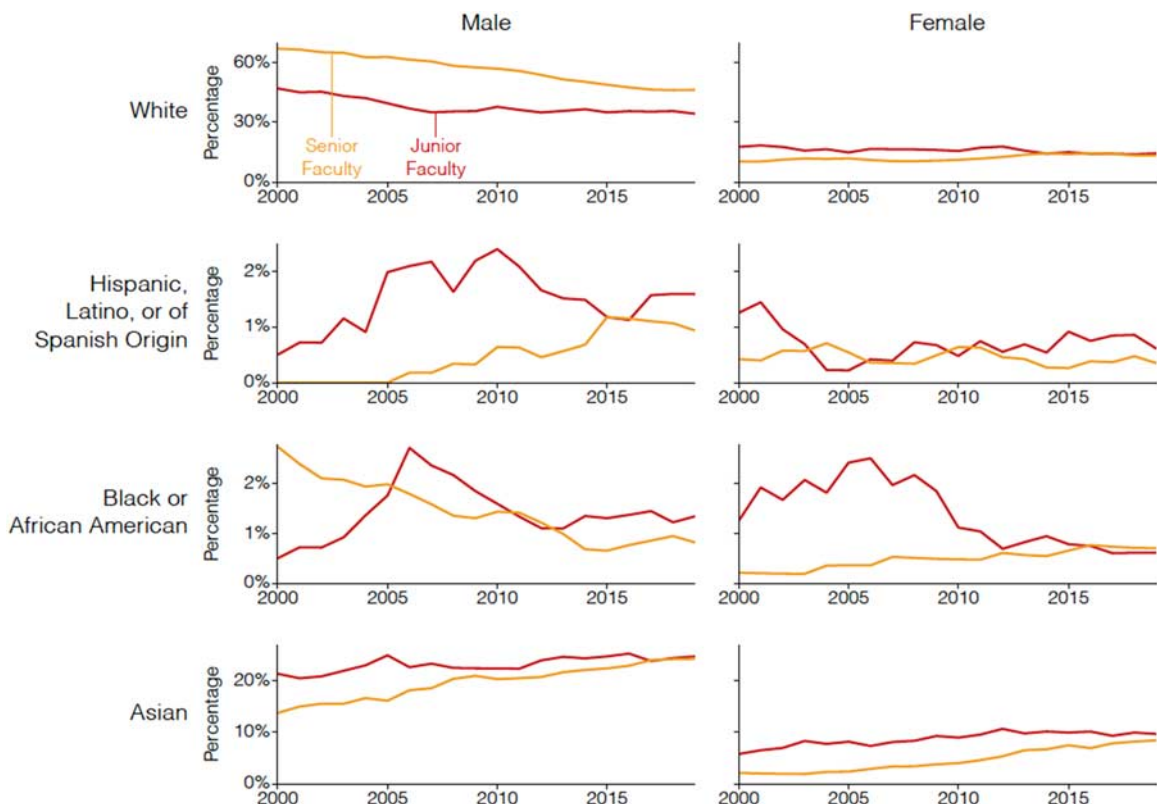

FIGURE 2. Proportion of each race/ethnicity and sex for professors in radiation oncology from 2000 to 2019.

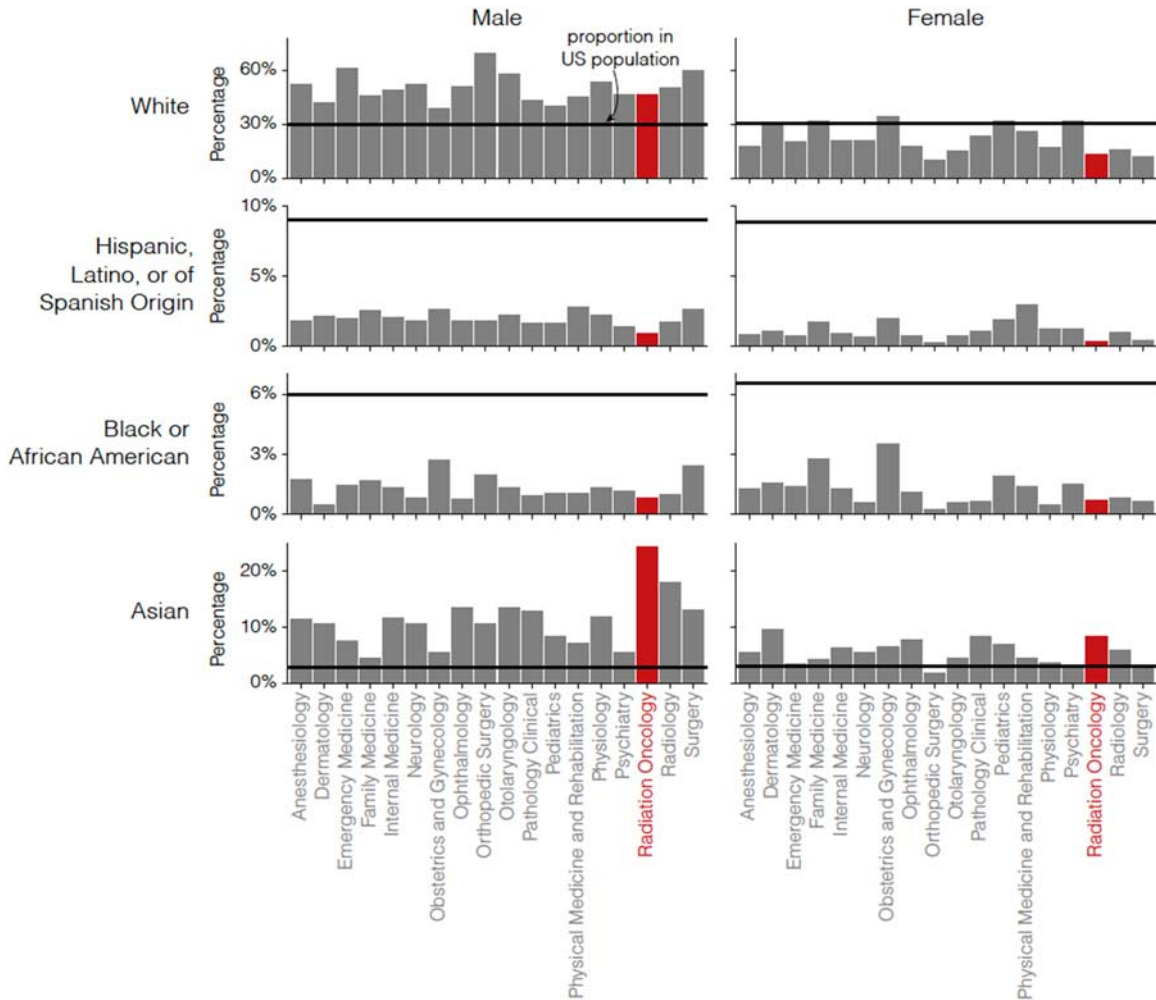

FIGURE 3. Proportion of each race/ethnicity and sex for full professors in all departments in 2019.

other Pacific Islanders decreased 20% in RO, while increasing in IM, GS, and R from 2000-2019. Among all clinical departments, RO was among lowest in representation of White or Hispanic women and Hispanic men in senior faculty positions.

Conclusions: Our findings indicate that sex and URM disparities in RO are large and improving at slower rate than in IM, GS, and R. Emphasis on improving these gaps in representation is needed in our field to address the needs of our diverse patient population and reflect the increasing diversity of medical students (Figs. 2 and 3).

(OA26) Epigenetic Methylation of Immune Synapse Genes in Primary and Metastatic Melanoma Tumors

Matthew Mills, MD¹, Anders Berglund, PhD², Ryan Putney, PhD², Imene Hamaidi, PhD², James Mule, PhD³, Sungjune Kim, MD PhD²; ¹H. Lee Moffitt Cancer Center and Research Institute, Department of Radiation Oncology, ²H. Lee Moffitt Cancer Center and Research Institute, ³Department of Immunology, H. Lee Moffitt Cancer Center & Research Institute

Background: Tumor cells often express immune synapse proteins to evade the immune system, which are frequently regulated by epigenetic mechanisms. Our prior work (Berglund, A., JCI, 2020, 10.1172/JCI131234) demonstrated that the methylation status of immune synapse genes in multiple tumor types was associated with functional T cell recruitment and associated with survival.

Objectives: To assess whether the methylation status of immune synapse genes predicts response to immunotherapy in metastatic melanoma.

Methods: A principal component analysis (PCA) of differentially methylated immune synapse genes in 8,186 solid tumors and 745 normal adjacent tissues from TCGA database was performed. Subsequently, the dysregulated methylation pattern of immune synapse genes was validated in two independent cohorts (GSE120878 and GSE86355 datasets). Lastly, the capacity of PC1 to predict response to immunotherapy in melanoma was investigated. Pearson’s, Spearman’s and t-SNE correlation statistics, and the 2-sided Student’s t tests were performed as appropriate. The

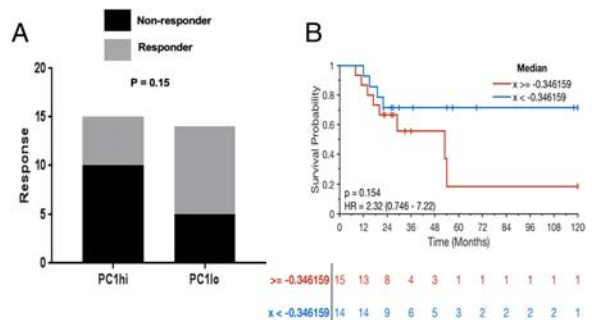

FIGURE 1. A demonstrates response to immunotherapy by PC1 status. B is a Kaplan Meier curve of overall survival stratified by PC1 status.

Kaplan-Meier method was utilized for overall survival (OS), with log-rank testing to identify associated with methylation status.

Results: The PCA has revealed two main components: PC1 and PC2. PC1 was mainly driven by co-stimulatory genes (i.e. CD40), frequently hypermethylated in tumor in comparison with normal adjacent tissue. Conversely, PC2 was characterized by immune checkpoint genes (i.e. HHLA2), which are often hypomethylated in melanoma. Such dysregulated methylation was validated in the independent cohorts, GSE120878 and GSE863, as costimulatory genes were hypermethylated and immune checkpoint genes were hypomethylated in melanoma compared with nevi. Importantly, a pilot analysis of a melanoma patient cohort who were treated with immunotherapy (N=29) demonstrated a trend for superior response to immunotherapy (P=0.15) and survival (HR 2.32, P=0.15) in patients with low PC1, which is characterized by relative hypomethylation of co-stimulatory genes.

Conclusions: The selective hypomethylation of immune checkpoint genes and hypermethylation of co-stimulatory genes by melanoma represents a crucial epigenetic mechanism of immune evasion, and the relative methylation levels of these genes may predict response to immunotherapy and survival (Fig. 1).

(OA27) Circulating Tumor Cells, Isolated Using the Graphene Oxide Microfluidic Chip, Predict Shorter Progression Free Survival in Stage III Non-Small Cell Lung Cancer Patients

Emma Purcell¹, Zeqi Niu¹, Shruti Jolly, MD², Sunitha Nagrath, PhD¹; ¹University of Michigan, ²University of Michigan Department of Radiation Oncology

Background: Stage III non-small cell lung cancer (NSCLC) patients commonly undergo radiation therapy, with imaging scans being the standard of care for determining disease progression both during and after radiation. Imaging technologies only detect progression after it has occurred, which may be well after tumor growth or disease progression has begun. We suggest that the molecular characterization of circulating tumor cells (CTCs) found in the bloodstream can identify or predict disease progression before it is currently diagnosable.

Objectives: The objective of this work is to determine whether CTC metrics, including the number of CTCs, change in the number of CTCs during treatment, and PD-L1 expression on CTCs, can be used as a blood-based biomarker to predict patient outcomes in stage III NSCLC.

Methods: Blood from 26 stage III NSCLC patients was processed for CTC isolation and analysis using the graphene oxide (GO) microfluidic chip. The GO chip isolates CTCs using immunoaffinity capture, taking advantage of EPCAM, EGFR, and CD133 expression on CTCs for specific isolation. CTCs were quantified by protein expression at six timepoints as being DAPI+/CK+, CD45- cells with two subpopulations

defined as PD-L1+/- CTCs. The number of CTCs, percent change in the number of CTCs, and the number of PD-L1+ CTCs were correlated to clinical metrics including progression free survival (PFS) time. The primary endpoint was disease progression, either locoregional, distant, or death.

Results: CTCs were present in 100% of patients (n=26/26), and at 93% of timepoints (n=102/110). The number of CTCs decreased significantly from pre-treatment to mid-radiation (P=0.02), after radiation (P=0.04), and mid-immunotherapy (P=0.02) timepoints. By calculating the percent decrease in CTCs from pre-treatment to mid-radiation therapy, it was found that patients who had a large decrease in CTCs had sustained stability. Conversely, patients who had an increase in CTCs during radiation therapy were likely to have progression. Patients were split in two even groups, defined by a 75% change in CTCs between pre-treatment and mid-radiation. A decrease in CTCs of less than 75% precluded a significantly shorter PFS time, 7 months vs 21 months average monitoring time with no progression (P=0.005), Fig. 1A. Secondly, the number of PD-L1+ CTCs were quantified and found to decrease from pre-treatment to the first week of radiation therapy (P=0.045). It was found that the three patients who had progression while receiving anti-PD-L1 immunotherapy had a quantity of PD-L1+ CTCs greater than the median at all time points. Survival analysis shows that having > 50% PD-L1+ CTCs at pre-treatment potentially predicts a shorter PFS, Fig. 1B.

Conclusions: CTCs isolated using the GO chip are a potential blood-based biomarker to predict patient outcomes in stage III NSCLC undergoing chemoradiation. Increase in the number of CTCs during radiation treatment and the percent of PD-L1+ CTCs at pre-treatment may indicate shorter PFS time.

(OA28) Biological Guided Carbon-ion Microporous Radiation to Tumor Hypoxia Area Triggers Robust Abscopal Effects as Open Field Radiation

Jiade Lu, MD¹, Qingting Huang, MSc¹, Yun Sun, PhD¹, Lin Kong, MD¹, Weiwei Wang, MSc¹, Lien-Chun Lin, MSc¹, Yangle Huang, PhD², Jing Yang, MD¹, Xiaodong Wu, PhD¹; ¹Shanghai Proton and Heavy Ion Center, ²Fudan University Shanghai Cancer Center

Background: Recently, a growing number of studies focus on partial tumor irradiation to induce the stronger non-target effects. However, the value of partial volume carbon ion radiotherapy (CIRT) targeting hypoxic region of a tumor under imaging guidance as well as its effect of inducing radiation induced abscopal effects (RIAEs) have not been well investigated.

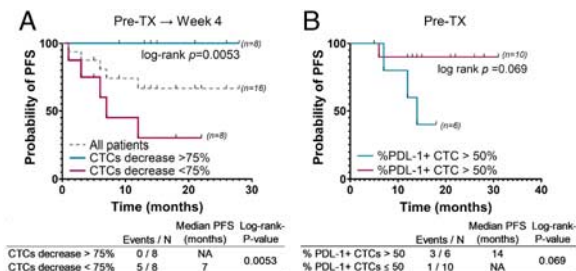

FIGURE 1. A, PFS curve for percent decrease in CTCs between pre-treatment and mid-radiation. B, PFS curve for percent PD-L1+ CTCs at pre-treatment.

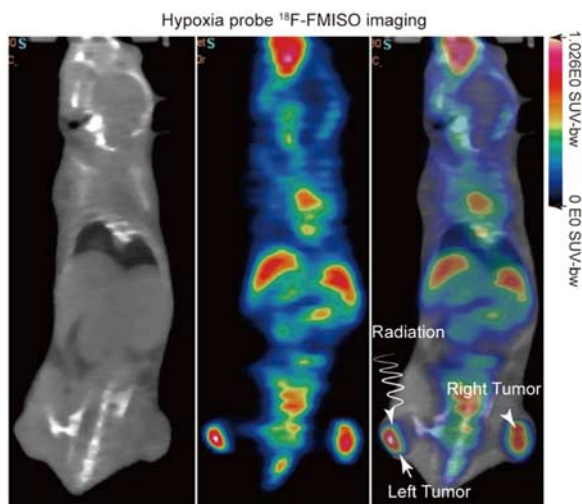

FIGURE 1. 18F-FMISO PET/CT imaging was performed before irradiation treatment for evaluating the hypoxia status of tumors.

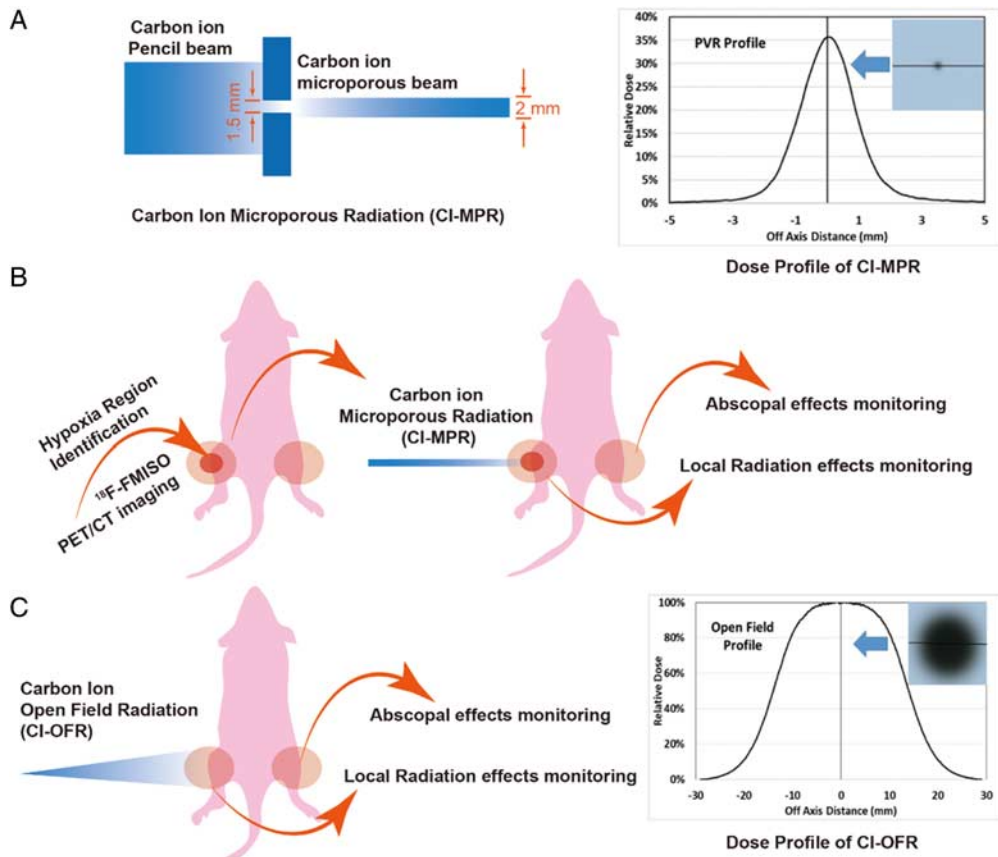

FIGURE 2. Mouse irradiation and dose profile. (A and B) The radiation area and dose profile of CI-MPR group. (C) The radiation area and dose profile of CI-OFR group.

Objectives: To investigate the differences in abscopal effects induced by CIRT to the entire tumor versus partial volume CIRT using the newly developed Carbon Ion Microporous Radiation (CI-MPR) guided by ¹⁸F-FMISO PET/CT targeting the tumor hypoxia region.

Methods: We developed a technique of CI-MPR, guided by ¹⁸F-FMISO PET/CT, for partial volume irradiation targeting the hypoxia area of a tumor and investigated its capability of inducing abscopal effects. Tumor-bearing mice were inoculated subcutaneously with breast cancer 4T1 cells into the flanks of both hind legs of mouse. Mice were assigned to three groups: Group 1: control group with no treatment; Group 2: carbon ion open field radiation (CI-OFR) group targeting the entire tumor; And Group 3: partial volume carbon ion

microporous radiation (CI-MPR group) targeting the hypoxia region. And the tumors on the left hind legs of mice were irradiated with single fraction of 20 Gy of CIRT in Groups 2 and 3.

Results: Mice treated with CI-MPR or CI-OFR showed that significant growth delay on both the irradiated and unirradiated of tumor as compared with the control groups. Tumor regression of left tumor irradiated with CI-OFR was more prominent as compared with the tumor treated with CI-MPR; however, the regression of the unirradiated tumor in both CI-MPR and CI-OFR group was similar.

Conclusions: Biological-guided CIRT using the newly developed microporous technique targeting tumor hypoxia region could induce robust abscopal effects similar to CIRT covering the entire tumor (Figs. 1–3).

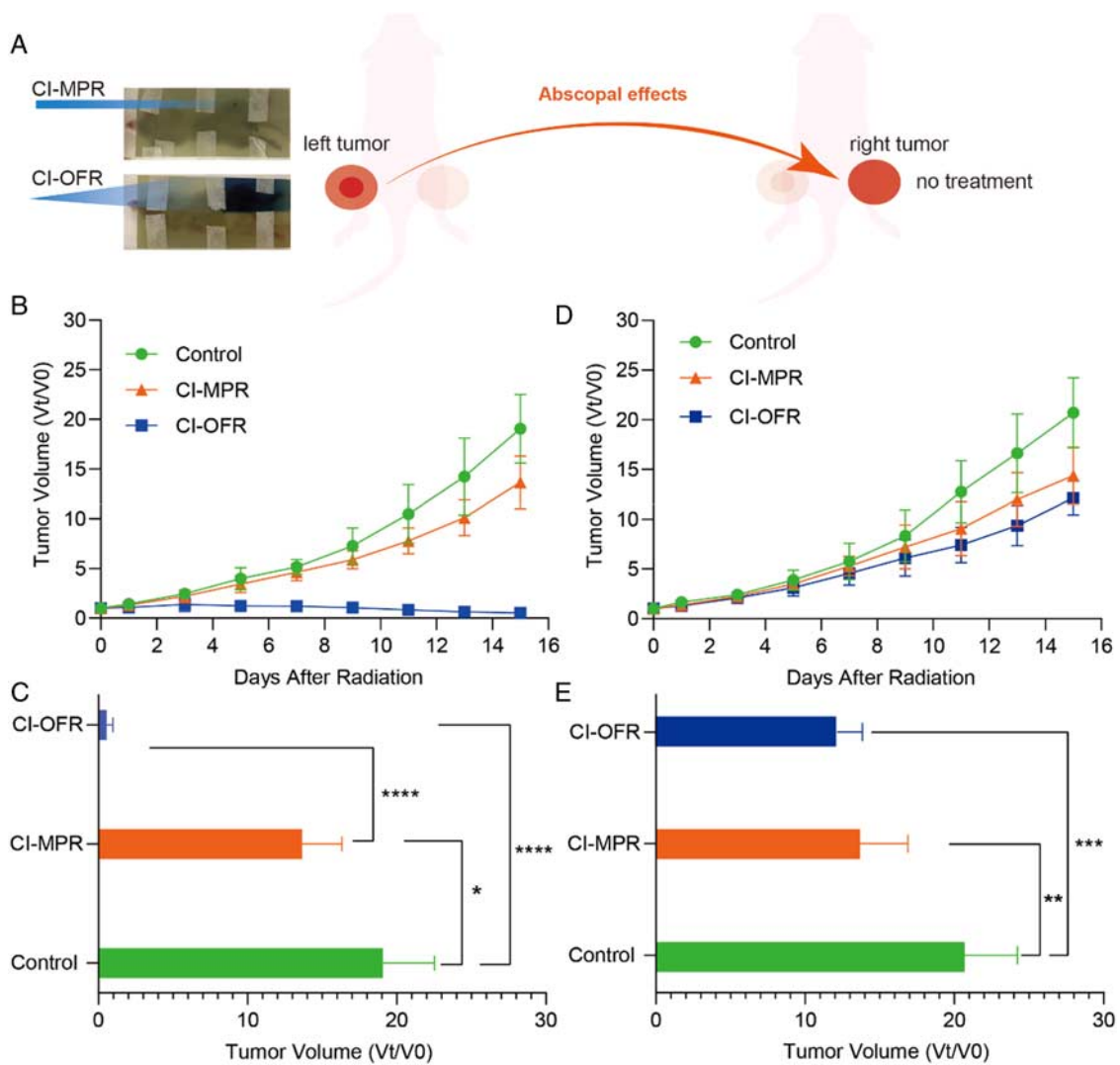

FIGURE 3. The response after irradiation on EBT3 film and evaluation of tumor volume change of the irradiated and unirradiated tumors. (A) The response and one vertex of irradiation could be noted in CI-OFr and CI-MPR group on the EBT3 film, respectively. (B) Tumor volume change on left side (irradiated) during the observation. (C) Tumor volume change on right side (unirradiated) during observation. (D) Quantitative analysis of irradiated tumor (left side) volume change on day 15. (E) Quantitative analysis of unirradiated tumor (right side) volume change on day 15. Each bar represents the standard error, and $P < 0.05, 0.01, 0.001, 0.0001$ are indicated by *, **, ***, ****.

(OA29) The Genomic and Transcriptomic Landscape of Radiation-induced Lymphomas in p53 Deficient Mouse Models

Yun Li, MD PhD¹, Erik Fredlund, PhD², Kyle Halliwill, PhD³, Cassandra Adams, PhD³, Kuang-Yu Jen, PhD⁴, Allan Balmain, PhD, FRS³, ¹University of California San Francisco, ²Karolinska Institute, ³UCSF, ⁴UC Davis

Background: Large-scale sequencing studies have revolutionized our understanding of cancer genomes, revealing a catalogue of somatically-acquired cancer-driving mutations that are the focus of cancer therapeutics. However, the impact of inherited germline variants has not been well-studied in radiation (RT) induced cancers. Deficiency of the tumor-suppressor gene TP53 is known to play a central role in radiation induced T-cell lymphomas. Previous studies have shown that some driver mutations exclusively or preferentially occur on one parental allele, indicating the strong effects of inherited polymorphisms in shaping tumor genomes.

Objectives: We hypothesize that p53-status will impact the biological pathways that underlie the development of radiation-induced lymphomas. The goal of this study was to define the genome wide mutation patterns in radiation induced lymphomas using a well characterized mouse model of radiation-induced T cell lymphoma, as well as to identify possible therapeutic opportunities for radiation induced malignancies.

Methods: We exposed a well characterized genetically heterogeneous mouse model of T cell lymphoma (129/SvImJ x M. spretus backcross) that are either germline p53+/- or p53-/- to a single dose of 4 Gy total body gamma RT. We performed both whole exome sequencing (WES) and microarray expression analysis on a subset of 32 lymphomas. Standard pipelines including BWA/PICARD/GATK/MuTect/PinDel/CNVKit and R packages affy/limma were used. In silico analysis of human cancer mutations were derived from COSMIC, TCGA, cBioPortal and published T-ALL sequencing studies.

Results: All animals developed aggressive lymphomas <12 months after RT. The p53^{-/-} animals had shorter tumor latencies (107±/36 d) compared with p53^{+/+} mice (222±/57 d, $P=2.36 \times 10^{-10}$, log-rank test), and had 2-fold the point mutations compared with lymphomas from p53^{+/+} mice (8 vs 4 mutations; $P=0.03$, Wilcoxon test). Recurrent p53-dependent and/or strain-specific point and structural mutations were identified at loci with known human homologs eg Notch1, Pten, and Ikzf1. Point mutations in the E1 ubiquitin activating enzyme Uba1 were exclusively seen in lymphomas from p53^{-/-} mice. These mutations map to the ubiquitin-activating and E2 interacting domains of Uba1, suggesting that the disruption of the ubiquitin pathway is a driver of RT-induced lymphomas.

Conclusions: Our data demonstrate the profound influence of both germline strain-specific polymorphisms and the timing of p53 loss on the overall pathways to tumorigenesis, as well as on selection of specific mutations in potential drug target genes, such as Uba1.

(OA30) Racial Differences in Treatments and Toxicity in Non-Small Cell Lung Cancer Patients Treated with Thoracic Radiation Therapy

Anna Laucis, MD, MPhil¹, Kimberly Hochstedler, MS¹, Matthew Schipper, PhD², Peter Paximadis, MD³, Thomas Boike, MD⁴, Derek Bergsma, MD⁵, Benjamin Movsas, MD⁶, Munther Ajlouni, MD⁷, Annette Kretzler, MD⁸, Daniel Spratt, MD¹, Robert Dess, MD², Melissa Mietzel, MS², Michael Dominello, DO⁹, Martha Matuszak, PhD², Reshma Jaggi, MD, DPhil², James Hayman, MD, MBA², Lori Pierce, MD, FASCO, FASTRO¹, Shruti Jolly, MD¹; ¹University of Michigan Department of Radiation Oncology, ²University of Michigan, ³Lakeland Radiation Oncology, ⁴21st Century Oncology, ⁵Department of Radiation Oncology at Mercy Health Saint Mary's, ⁶Department of Radiation Oncology, Henry Ford Cancer Institute, ⁷Henry Ford Cancer Institute, HFHS, ⁸Department of Radiation Oncology at Henry Ford Hospital, ⁹Wayne State University

Background: Racial disparities are of particular concern for lung cancer patients given historical differences in surgery rates for African-American lung cancer patients that resulted in lower overall survival and higher recurrence rates compared with rates in White patients.

Objectives: The overall objective of this study was to examine racial differences in thoracic radiation therapy (RT) treatments and toxicities in a large cohort of patients from a multi-institutional consortium database of non-small cell lung cancer (NSCLC) patients.

Methods: A large multi-institutional statewide prospectively collected patient-level database of locally advanced (stage II or III) NSCLC patients who received thoracic RT from March 2012 to November 2019 was analyzed to assess the associations between race and treatment and toxicity variables. Race (White or African-American) was defined by patient self-report or if not available then by the electronic medical record system classification. Race categories other than White or African-American comprised a small minority of patients and were excluded from this analysis. Patient-reported toxicity was determined by validated tools including the Functional Assessment of Cancer Therapy–Lung (FACT-L) quality of life instrument. Provider-reported toxicity was determined by the Common Terminology Criteria for Adverse Events (CTCAE) version 4.0. Uni-variable and multi-variable regression models were then fitted to assess relationships between primary outcomes by race and indicators of high-quality treatment and secondary analysis of symptoms. Spearman rank correlation coefficients were calculated between provider reported toxicity and similar patient reported outcomes for each race category.

Results: A total of 1441 patients from 24 institutions with mean age of 68 years (range 38–94) were evaluated; 226 patients were African-American, of whom 61% were treated at three facilities. Race was not significantly associated with RT treatment approach, use of concurrent chemotherapy, or the dose to the planning target volume (PTV) or organs at risk including the heart and lungs. However, there was increased patient-reported general pain in African-American patients (compared with White patients) at several time points including pre-RT (22% vs 15%), $P=0.02$ and at the end of RT (30% vs 17%),

$P=0.001$). African-American patients were significantly less likely to have provider-reported grade 2+ radiation pneumonitis (odds ratio (OR) 0.36, $P=0.03$), despite similar levels of patient-reported respiratory toxicities such as cough and shortness of breath and even after controlling for known patient and treatment-related factors. Correlation coefficients between provider- and patient-reported toxicities were generally similar across race categories.

Conclusions: In this large multi-institutional observational study, we reassuringly found no evidence of differences in radiation treatment or chemotherapy approaches by race, in contrast to historical differences by race in surgical care that led to worse survival and outcomes in minority race patients. However, we did unexpectedly find that African-American race was associated with lower odds of provider-reported grade 2+ radiation pneumonitis despite similar patient-reported toxicities of shortness of breath and cough. There are several possibilities for this finding including that pneumonitis is a multifactorial diagnosis that relies on clinical as well as radiologic information and clinical information alone may be insufficient. The Spearman correlation analysis also revealed stronger correlations between patient- and provider-reported toxicities in White patients compared with African-American patients, particularly for trouble swallowing/esophagitis. These findings together for pneumonitis and esophagitis discouragingly suggest possible under-recognition of symptoms in black patients. Further investigation is now warranted to better understand how these findings impact the care of racially diverse lung cancer patients.

(OA31) Tapping into the Power of Crowd Innovation to Develop an Artificial Intelligence Tool for Pancreatic Radiotherapy

Karl Bush, PhD, MCCPM¹, Diego Toesca, MD¹, Richel Baclay, MD¹, Daniel Chang, MD¹; ¹Stanford University

Background: Crowd innovation is the process of inviting a large, worldwide community of highly proficient software developers, generally not working in the healthcare industry, to rapidly produce a large number of high-quality, and often novel, algorithmic solutions to a posed problem. Crowd innovation is most often implemented in a contest format, in which the programmer contestants compete for cash prizes to produce the highest scoring solution to the problem. This study offers a pivotal exploration into the power and potential of crowd innovation for radiation oncology and radiology software automation.

Objectives: In this work, we determine the efficacy of using the non-traditional approach of crowd innovation, to rapidly develop a diverse set of machine learning based algorithms for automatic pancreatic tumor segmentation. The objective for the study was to probe the quality that expert programmers from outside healthcare could achieve in automated segmentation, and determine whether the approach could rival traditional frameworks of graduate student/post-doctoral fellow algorithm development. The endpoint for the segmentation was for use in a pancreatic cancer management solution, both in prediction of pancreatic tumor surgical resectability, and in target delineation for radiation therapy.

Methods: We conducted a 10-week, prize based, competition open to Topcoder, Inc. community contestants (total prize money of \$30,000). Contestants were provided a training dataset containing 120 CT scans and contour data for pancreatic tumors and surrounding vessels (superior mesenteric artery, celiac axis/common hepatic artery, and superior mesenteric vein/portal vein), and competed in building algorithms to auto-segment a validation dataset containing 60 CT scans with no contours. An F-score metric was used to rank the contestants' algorithms using a separate, unrevealed dataset of 62 patients. F-score calculations included both the tumor and vessel contours, but with vessels weighted 7-times lower than the tumor. Contestants were offered a \$3,000 prize bonus for algorithms exceeding an F-score of 0.7 to encourage quality algorithms beyond simply winning prize money.

Results: 167 contestants registered for the competition, across 34 countries, and submitted a total of 337 algorithms. The winning solution (average F-score = 0.72) implemented a 3D-UNet model in a 3D semantic segmentation approach, which was found to be accurate in tumor and vessel delineation. All other winning algorithms used 2D model approaches. Top 5 algorithm performance was strongly

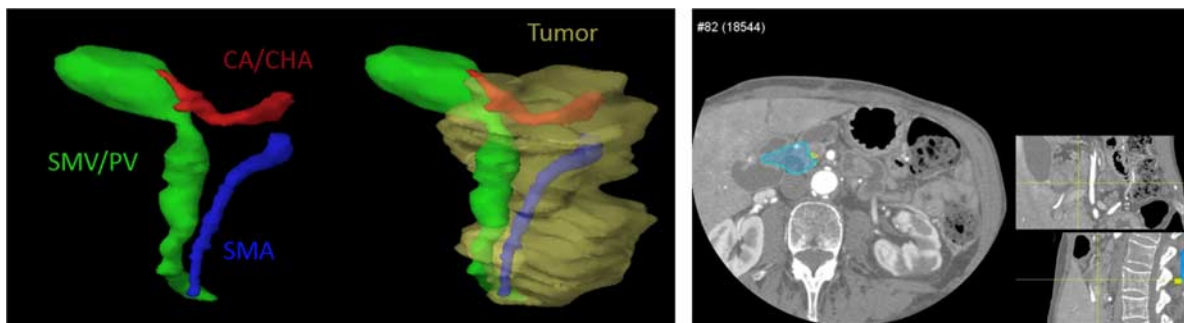

FIGURE 1. 3D (left) and axial (right) views of an auto-segmented pancreatic tumor and surrounding vessels.

TABLE 1. Precision and Recall Scores for Tumor and Vessels for Top 5 Contestants' Algorithms

	Tumor		CA_CHA		PV_SMV		SMA	
	Precision	Recall	Precision	Recall	Precision	Recall	Precision	Recall
lxastro0	0.807	0.651	0.832	0.825	0.888	0.784	0.845	0.839
selim_sef	0.73	0.716	0.716	0.875	0.796	0.859	0.735	0.862
cannab	0.739	0.626	0.725	0.895	0.791	0.803	0.756	0.887
ipraznik	0.723	0.626	0.803	0.835	0.872	0.855	0.83	0.879
Psyho	0.736	0.613	0.815	0.801	0.835	0.775	0.813	0.844

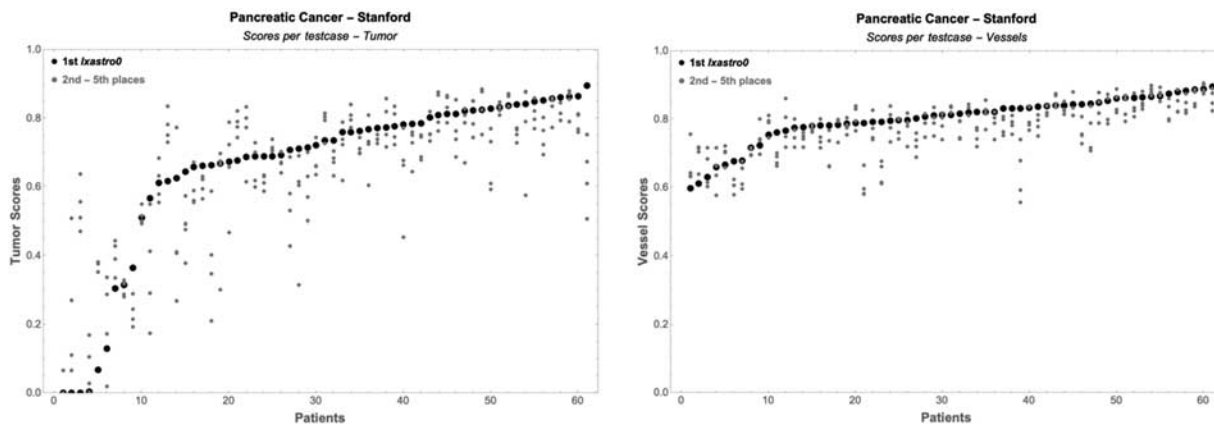

FIGURE 2. Tumor contour F-scores (left) and vessel contour F-scores (right), ordered in increasing order, for the 62 patient scoring dataset.

correlated by patient. In 82% of patient cases, all top 5 algorithms succeeded in achieving an F-score > 0.6. The top 5 scoring solutions provided useful auto-segmentation capabilities for pancreatic tumors and surrounding vessels, and have been integrated into a model for predicting pancreatic tumor resection success before surgery.

Conclusions: The use of crowd innovation for healthcare challenges has seen limited use, but offers great potential for rapid development of high quality segmentation algorithms with reasonable financial commitments (Figs. 1, 2 and Table 1).

(OA32) Immune Cell Infiltrates in Low Grade Glioma and Impact of Immunological Microenvironment Affecting Tumor Biology and Oncologic Outcome

Anupam Rishi, MD¹, Homan Mohammadi, MD², Daniela Martir, MS³, Eric Welsh, PhD⁴, Timothy Robinson, MD, PhD⁵, Daniel Oliver, MD²,

Steven Eschrich, PhD², Javier Torres-Roca, MD¹, Hsiang-Hsuan Michael Yu, MD², G. Daniel Grass, MD, PhD¹, Kamran Ahmed, MD¹; ¹Department of Radiation Oncology, H. Lee Moffitt Cancer Center & Research Institute, ²H. Lee Moffitt Cancer Center & Research Institute, ³Ponce Health Sciences University, ⁴Department of Biostatistics and Bioinformatics, H. Lee Moffitt Cancer Center & Research Institute, ⁵H. Lee Moffitt Cancer Center and Research Institute, Department of Radiation Oncology

Background: Prediction of response to immune therapies relates to the presence, distribution, and activation of immune cell infiltrates (ICI). Little is known about the immune contexture of low-grade glioma (LGG), and how ICI may predict the outcome. CIBERSORT provides an estimate of ICI via a gene expression deconvolution algorithm.

Objectives: In this novel study, we analyzed the presence of ICI, and the neutrophil-to-lymphocyte (NLR) and platelet-to-lymphocyte (PLR) ratios with respect to outcomes in LGGs.

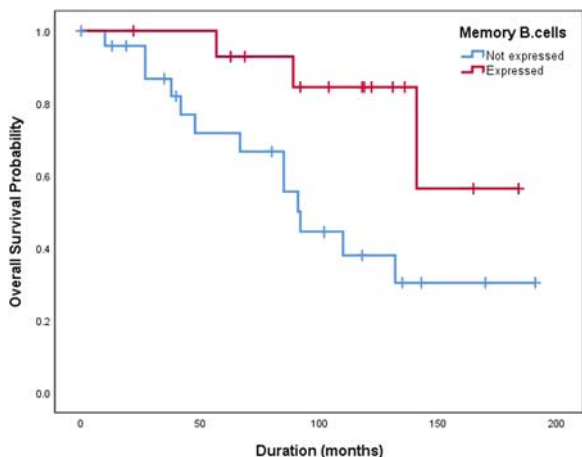

FIGURE 1. The Kaplan–Meier curve shows the overall survival is significantly higher with the presence of memory B-cells (10-year OS 84.4% vs 38%, HR 3.9, 95% CI 1.1-13.6, $P=0.02$; log-rank).

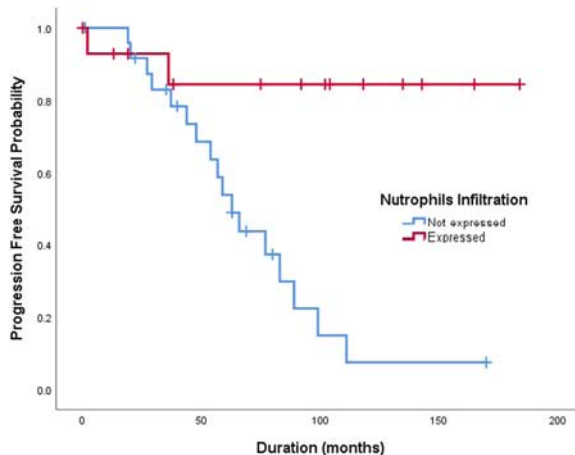

FIGURE 3. The Kaplan–Meier curve shows the progression-free survival is significantly worse with the presence of neutrophils (10-year OS 7.5% vs 84.4%, HR 7.9, 95% CI 1.8–35.1; $P=0.002$; log-rank).

Methods: From an IRB-approved institutional tissue biorepository, we identified patients treated between 2004–2012, with LGG who underwent excision and had complete gene expression profiling. Gene expression levels were assessed by Affymetrix Hu-RSTA assays. For ICI, the presence and high expression dichotomized by median were used to assess relationships with overall survival (OS) and progression-free survival (PFS). For NLR, 2.4 was used based on published data in primary GBM. Time-to-event analyses were performed with Kaplan-Meier estimates and compared via log-rank test. Associations of factors and outcomes were explored using Cox regression.

Results: A total of 41 LGG patients were identified, with a median age of 36.5 years (range, 18-65 y) and 43.9% (18 patients) females. All patients were either grade 2 astrocytoma, 16 (39%) patients or oligodendroglioma/oligo-astrocytoma, 25 (61%) patients. All patients underwent surgery, with gross total excision (GTR) achieved in 19 (46.3%), and sub-total excision (STR) in 22 (53.7%) patients. Ten (24.4%) patients received adjuvant radiation therapy. The frontal lobe was the most common primary site in 27 (65.8%) patients. Median OS and PFS from date of surgery were

141 months (95% confidence interval (CI) 94.2–187.8 mo) and 83 months (95% CI 47.4–118.6 mo), respectively. 5- and 10-year OS was 64.2 and 35.1%, respectively. Among ICI, the presence of memory B-cells significantly improved OS (10-year OS 84.4% vs 38%, hazard ratio (HR) 3.9, 95% CI 1.1-13.6; $P=0.02$). In addition, the presence of neutrophils adversely affected PFS (10-year OS 7.5% vs 84.4%, HR 7.9, 95% CI 1.8–35.1; $P=0.002$). No other ICI subtypes affected OS or PFS significantly. Patients with pre-surgery NLR > 2.4 had significantly worse OS (10-year OS 30.4% vs 66.7%, $P=0.05$). PLR did not affect OS or PFS.

Conclusions: LGGs have a distinct immunological microenvironment and ICIs may play a pivotal role in tumor biology affecting progression and survival. The knowledge of ICI and NLR may serve as a unique risk-stratification and guide clinical decisions (Figs. 1–3).

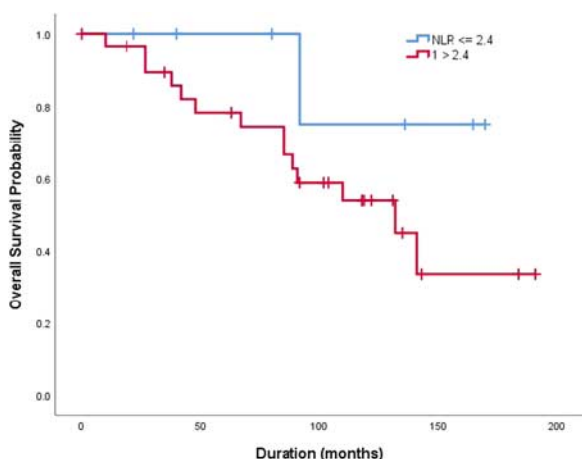

FIGURE 2. The Kaplan–Meier curve shows the overall survival is significantly higher with pre-surgery NLR ≤ 2.4 (10-year OS 30.4% vs 66.7%, $P=0.05$; log-rank).

(OA33) Response to Whole-Lung Low-Dose Radiation Therapy (LD-RT) Predicts Freedom from Intubation in Patients Receiving Dexamethasone And/or Remdesivir for COVID-19-Related Pneumonia

Clayton Hess, MD MPH¹, Tony Eng, MD¹, Tahseen Nasti, PhD¹, Vishal Dhere, MD¹, Troy Kleber, BS², Jeffrey Switchenko, PhD, MS³, Brent Weinberg, MD⁴, Nadine Rouphael, MD¹, Sibao Tian, MD¹, Soumon Rudra, MD¹, Luisa Taverna, (student)¹, Alvaro Perez, (student)¹, Rafi Ahmed, PhD¹, Mohammad Khan, MD, PhD²; ¹Emory University, ²Department of Radiation Oncology, Winship Cancer Institute of Emory University, ³Winship Cancer Institute at Emory University, ⁴Emory University Hospital

Background: Low-dose radiation is a known focal anti-inflammatory treatment for various benign conditions. Phase I/II clinical trials have explored whole-lung low-dose radiotherapy (LD-RT) as a potential treatment for patients with COVID-19-related pneumonia. Initial findings require reproduction. Concomitant LD-RT administration with existing therapies requires safety evaluation.

Objectives: To explore the safety and efficacy of LD-RT in patients receiving concurrent dexamethasone and/or remdesivir. To get investigate the predictive value of 3-day lab value response of C-reactive protein levels following LD-RT on 28-day intubation and recovery rates.

Methods: Patients with COVID-19-related pneumonia receiving dexamethasone and/or remdesivir were treated with 1.5 Gy whole-lung LD-RT, followed for 28 days or until hospital discharge, and compared with controls blindly matched by age, comorbidity, and disease severity. Eligible patients were hospitalized, SARS-CoV-2 positive, had radiographic consolidations, and required supplemental oxygen.

Endpoints included safety, clinical recovery, intubation, radiographic changes, and biomarker response.

Results: 40 total patients were available for analysis. 20 patients receiving concurrent dexamethasone and/or remdesivir were treated with whole-lung LD-RT between Jun 11 and Dec 7, 2020 and were compared with 20 matched controls. Following LD-RT, freedom from intubation improved from 68% in controls to 86% ($P=0.09$). Predictive inflammatory and cardiac markers rapidly fell following LD-RT, including C-reactive protein (CRP) ($P=0.02$) and creatine kinase (CK) ($P < 0.01$), indicative of reduced cascading inflammation and cardiac injury. Eighty percent of LD-RT patients experienced rapid decline in CRP within 3 days and were classified as LD-RT responders. Intubation-free survival was 100% following LD-RT when the CRP responded, vs 66% in matched controls ($P=0.01$). Oxygenation requirements were lower following LD-RT among CRP responders compared with matched controls: 32% lower per individual ($P=0.03$) and 56% lower for the cohort ($P=0.06$). No patient whose CRP declined following LD-RT died or required intubation.

Conclusions: A cohort of patients with COVID-19-related pneumonia treated with LD-RT demonstrated superior freedom from intubation compared with matched controls, especially LD-RT responders ($P=0.01$). LD-RT appears safe to deliver with concurrent drugs. LD-RT lowered CRP and CK biomarkers. CRP response predicted favorable outcome. Optimal timing for LD-RT after oxygen dependence but before intubation may extinguish immunopathology before systemic spread. Confirmatory clinical trials are warranted. Clinical Trial Registration: NCT04366791.

(OA34) A Pilot Study to Assess the Combination of High-Dose Conformal Radiation Therapy and Pembrolizumab in Modulating Local and Systemic T-cell Responses in Advanced Malignancies

Christopher Luminais, MD¹, Alexander Mathew¹, Kimberly A. Bullock, PhD¹, Gina R. Petroni, PhD¹, Richard J. Price, PhD¹, Timothy N.J Bullock, PhD¹, James Lamer, MD¹; ¹University of Virginia

Background: Although there has been tremendous interest in the use of high-dose conformal radiation therapy (HDCRT) to enhance immunotherapy (IO), the optimal sequencing of IO and HDCRT is unknown both in terms of local control and distant (abscopal) responses.

Objectives: To use repeated tissue biopsies to estimate the effect of different sequencing orders of IO and HDCRT and to describe the immunologic effects.

Methods: This was a Phase I, prospective, randomized trial. Twenty-one patients with metastatic solid malignancies who were eligible for HDCRT (24 Gy in 3 fractions) and pembrolizumab (200 mg) were randomized to 3 arms: Arm A, concurrent HDCRT (day 1 start) and pembrolizumab (days 1, 43, 64, and 85); Arm B, pembrolizumab first (days 1, 43, 64, and 85) followed by HDCRT (day 22 start); Arm C HDCRT first (day 1 start) followed by pembrolizumab (days 22, 43, 64, and 85). Patients underwent biopsy of the treated lesion pre-treatment and post-treatment on days 22 and 43. The primary endpoint was local CD8+ T cell and FoxP3+ T regulatory cell (Treg) counts. Post hoc, RNA sequencing of biopsy specimens was performed followed by bioinformatics analyses, including differential gene expression, gene set enrichment analysis, cell type deconvolution, and TCR analysis.

Results: Primary malignancies treated included: breast (6), colon (5), salivary (2), sinus (1), esophagus (1), leiomyosarcoma (1), melanoma

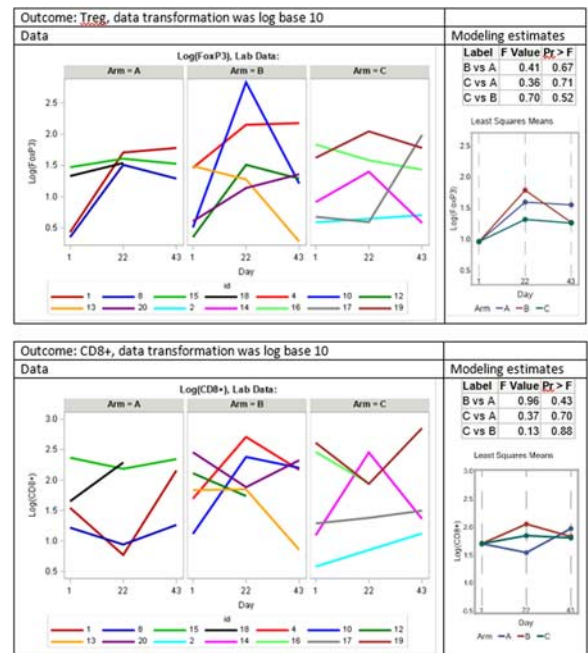

FIGURE 1. CD8+ T cell and FoxP3+ T regulatory cell (Treg) counts on pre and post treatment tumor biopsies.

(1), pancreatic (1), thyroid (1), larynx (1), and testicular (1). Repeated measure modeling was used to assess the CD8+ T cell and Treg counts. No pattern for CD8+ T cell and Treg counts was observed within or between arms (Fig. 1). Transcripts associated with DNA damage, including DDB2, were upregulated 3 weeks after HDCRT in nearly all patients in all arms (Fig. 2A). Upregulation of immune regulatory transcripts consistent with activation of an adaptive immune response, such as IL17D, were only observed when pembrolizumab was administered concomitant with or before HDCRT (Fig. 2B). Gene sets associated with T-cell activation were significantly enriched after pembrolizumab, with attenuation after HDCRT (Fig. 2C). Conversely, leukocyte deconvolution revealed that HDCRT increased the proportion of intratumoral M2 macrophage signatures, whereas pembrolizumab decreased it (Fig. 2D).

Conclusions: Surprisingly, the timing of IO and HDRT did not result in a consistent CD8+ T cell or Treg pattern within or between arms. This could be a result of testing within a heterogeneous population with advanced disease. RNA-sequencing revealed that while order of therapy administration did not impact the ability of HDCRT to induce DNA damage transcripts, it may influence pembrolizumab's propensity to activate anti-tumor immune mechanisms. Further, HDCRT acutely induced M2 macrophage signatures regardless of treatment arm. Together, these results underscore the importance of understanding the immunological consequences of HDCRT and their influence on immunotherapy.

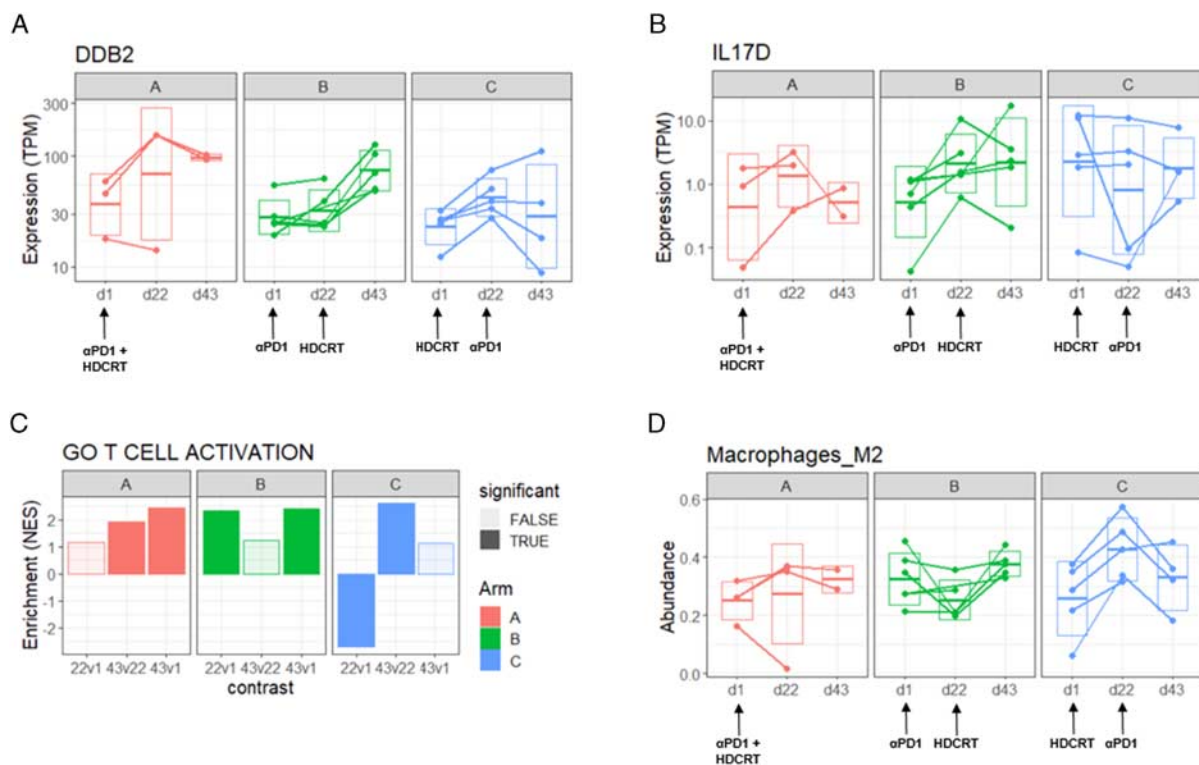

FIGURE 2. RNA sequencing results: A, DDB2 expression; B, IL17D expression; C, T-cell activation associated get set enrichment; D, intratumoral M2 macrophage signatures.

(OA35) Should Immune System Sparing Dose Constraints Be Integrated into the QUANTEC Guidelines?

Bhanu Prasad Venkatesulu, MD¹, Prashanth Giridhar, MD², Rituraj Upadhyay, MD³, Amrith Sharma, PhD⁴, Hagar Elghazawy, MD⁵, Thiraviyam Elumalai, MD⁶, Supriya Mallick, MD⁷, Cheng Cheng-En Hsieh, MD⁴, ¹Loyola University Chicago, ²All India Institute of medical sciences, ³The University of Texas MD Anderson Cancer Center, ⁴MD Anderson Cancer Centre, ⁵Ain Shams University, ⁶Christie, ⁷National cancer institute

Background: Multiple reports have shown that radiation delivery for tumors in close proximity to lymphoid organs such as bone marrow, spleen or unintended radiation to circulating pool of lymphocytes traversing organs such as heart and lung is known to deplete the circulating lymphocyte populations. This radiation-related lymphopenia is known to cause inferior tumor control outcomes which translate into inferior overall survival outcomes in high-grade gliomas, head and neck tumors, lung cancer, pancreatic cancer, hepatocellular carcinoma, and Gynecological malignancies. Currently, there are no standardized dose constraints that are available to limit the dose to the resident and circulating lymphocyte populations. This is much more pertinent in the current immunotherapy era wherein ongoing clinical trials are trying to optimally time and sequence radiation and immunotherapy combinations for potentially synergistic and or additive effects.

Objectives: Collate the radiation-related dosimetric parameters that predict the incidence of severe lymphopenia in solid tumors

Methods: We did a systematic review of PubMed, Cochrane Central, and Embase in accordance with the PRISMA statement and pooled the dosimetric parameters that have been related to radiation-related lymphopenia and can be used to limit the incidence of lymphopenia.

Results: 633 abstracts were shortlisted for abstract screenings and 35 articles fulfilled the inclusion criteria. The CNS dose constraints that were most pertinent to spare the circulating lymphocytes in the brain were Whole Brain mean dose <31 Gy, Whole-brain Dmin <2 Gy V10 <68%, hypothalamus Dmax <56 Gy, and V25 < 56% were significant predictors of no severe lymphopenia (SL). The thoracic dose constraints were effective dose to immune cells (EDIC) (based on mean

lung and mean heart dose) the range of <4.0, 4.0-6.5, 6.5-9.5, and >9.5 Gy translated into 2-year OS rates of 72, 52, 49, and 15% for locally advanced non-small-cell lung cancer. Mean lung dose of <12 Gy, lung V5 <45%, and mean heart dose of <5.2 Gy heart V5 <38%, mean thoracic dose <5 Gy, V20 of thoracic vertebra <26% were predictors of no SL. In Esophagus cancer mean body dose exposure strong predictor for G4 nadir-Odds ratio 1.22 per Gray, increase of 1 Gy in mean splenic dose (MSD) predicted a 2.9% decrease in nadir absolute lymphocyte count (ALC), Heart V15 < 73%, T-spine V5 < 72%, Body V10 < 18%, Lung V5 < 50%, and Aorta V5 < 93% were strong predictors of no grade 4 lymphopenia, the 2year OS rates were 66.7%, 42.7%, and 16.7% for EDIC <2 Gy, 2-4 Gy and >4 Gy. In gastric cancer mean splenic dose (MSD) ≥ 35 Gy poor prognostic factor for OS and recurrence-free survival. In pancreatic cancer, dosimetric parameters of spleen such as V10(32.6 vs 16%); V15(23.2 vs 9.5%), and V20 (15.4 vs 4.6%), 1-Gy increase in MSD increased the odds of grade 3 lymphopenia by 18.6%. In liver cancer, MSD, V5, V25, and V30 of the spleen for the Min ALC were 227.72 cGy, 17.84, 0.98, and 0.42%, respectively. In rectal cancer, Pelvic bone marrow (PBM) volume receiving at least 30 Gy (V30) was significantly associated with lymphopenia. In Gynecological malignancies, bone marrow V10 > 85% was associated with higher odds of developing lymphopenia, risk of SL was associated with bone marrow V40 > 599cc.

Conclusions: This systematic review is a preliminary attempt to provide dose constraints to spare the immune system during radiation delivery. The aforementioned dose constraints require prospective validation in clinical trials to better spare the immune system and augment the efficacy of radiation.

(OA36) Primary Intraocular Lymphoma: Outcomes and Toxicity After Radiation Therapy

Chelsea Pinnix, MD, PhD¹, Ethan Damron, BS², Jillian Gunther, MD, PhD¹, Penny Fang, MD¹, Susan Wu, MD¹, Bouthaina Dabaja, MD¹, Sattva Neelapu, MD¹, Loretta Nastoupil, MD¹, Sairah Ahmed, MD¹, Paolo Strati, MD¹, Jason Westin, MD¹, Luis Fayad, MD¹,

Raphael Steiner, MD¹, Ranjit Nair, MD¹, Dan Gombos, MD¹, Nathan Fowler, MD¹; ¹MD Anderson Cancer Center, ²McGovern Medical School at UTHealth

Background: Primary intraocular lymphoma (PIOL) is an aggressive, rare hematologic malignancy comprised of large B-cells primarily involving the retina and vitreous. Radiation therapy (RT) is occasionally excluded over fears regarding toxicity.

Objectives: We sought to examine the outcomes and toxicity associated with RT for PIOL patients (pts).

Methods: We reviewed the charts of 26 PIOL pts treated between 2003-2020 at our institution. We included pts without additional sites of CNS involvement that received ocular RT as part of their treatment.

Results: The median age at diagnosis was 69.5 years (range: 48-90); 21 pts (81%) were female. The most common presenting symptoms (> 1 possible) were blurred vision (n = 19, 75%), floaters (n = 15, 59%), and/or vision loss (n = 12, 46%). Ophthalmologic examination revealed suspicious vitreous cells (n = 23, 88%) and/or retinal/choroidal infiltrate (n = 9, 35%). Eighteen pts (69%) had bilateral ocular involvement. In all pts, gross disease was limited to the eyes. All pts underwent lumbar puncture (LP) to rule out CNS disease; 14 pts had LP flow analysis completed. In 3 pts (12%), CSF cytology revealed rare, atypical lymphoid cells, but follow-up MRI studies were unremarkable. Twenty-two pts (85%) received a median of 5 (1-6) cycles of systemic chemotherapy before RT. Seventeen pts (65%) were treated with rituximab (R), methotrexate (Mtx), procarbazine (P), and vincristine. Two pts (8%) received single agent Mtx, 2 pts (8%) received Mtx and R, and 1 pt (4%) received Mtx and P. Before RT, 3 pts (12%) received intravitreal Mtx and 3 pts (12%) received intrathecal Mtx. Ten pts (38%) had chemotherapy abbreviated due to toxicity. Nine pts (35%) received consolidative cytarabine chemotherapy after RT and 6 pts (23%) underwent autologous bone marrow transplant. All pts received ocular RT, with 24 pts (92%) receiving treatment bilaterally, to a median dose of 36 Gy in 20 fractions (range 28.5-39.6 Gy in 15-24 fractions). The median follow up time was 41.8 months (95% CI 19.7-83) from start of RT. Three pts (12%) relapsed in the eyes at a median of 4 months (1-42) post-RT. Eleven pts (42%) developed relapsed lymphoma in the brain at a median of 31 months (5-53) post-RT. The median progression free survival and overall survival was 24.1 (95% CI 4.9-36.3) and 42.5 (95% CI 3.3-75.8) months from start of RT, respectively.

Thirteen patients (50%) had cataracts removed before RT; 13 pts (50%) developed post-RT cataracts. Twenty pts (77%) had dry eyes that persisted > 3 months after RT. No pt developed optic neuropathy following RT. Five pts (19%) developed keratopathy. One pt (4%) developed retinopathy post-RT, and 1 pt (4%) had preexisting diabetic retinopathy worsened by RT. No patient developed blindness after therapy.

Conclusions: In this single-center review of combined treatment modality therapy for PIOL, severe visual complications were uncommon. Additional therapies to prevent distant CNS relapses are warranted.

(OA37) Low-Dose Radiotherapy for Low Grade Non-Hodgkin Lymphoma of the Orbit

Christopher Wright, MD¹, Jonathan Baron, BS¹, Daniel Lee, BS¹, Maribel Carpenter¹, Cesar Briceno, MD², Elise Chong, MD³, Amit Maity, MD PhD¹, John Plastaras, MD PhD¹, Ima Paydar, MD¹; ¹Department of Radiation Oncology, University of Pennsylvania, ²Department of Ophthalmology, University of Pennsylvania, ³Department of Medicine, Hematology/Oncology Division, University of Pennsylvania

Background: Orbital low grade non-Hodgkin Lymphomas (LGNHLs) are the most common tumor of the ocular adnexa. Marginal zone lymphoma (MZL) followed by follicular lymphoma (FL) are the most commonly represented histologies. Low-dose radiotherapy (LDRT), previously defined as 2 Gy x 2 fractions, for orbital LGNHLs has resulted in response rates exceeding 90% (Fasola, et al IJROBP 2013). Additional data, however, suggests lower doses are associated with inferior response rates (Desai, et al Blood 2017). Radiotherapy (RT) is a proven treatment modality for this entity, but no prior data exists comparing response rates following LDRT to moderate-dose RT (MDRT, RT dose > 4 Gy).

Objectives: Herein, we compare overall response rates (ORR) and complete response (CR) rates for patients with orbital LGNHLs treated with LDRT vs MDRT.

Methods: We retrospectively reviewed 38 consecutive courses of RT across 36 patients treated for LGNHL of the orbit at a single institution. Bilateral disease was present in 15 patients. Nine patients had advanced

Response Rates Following LDRT vs MDRT for Orbital LGNHL

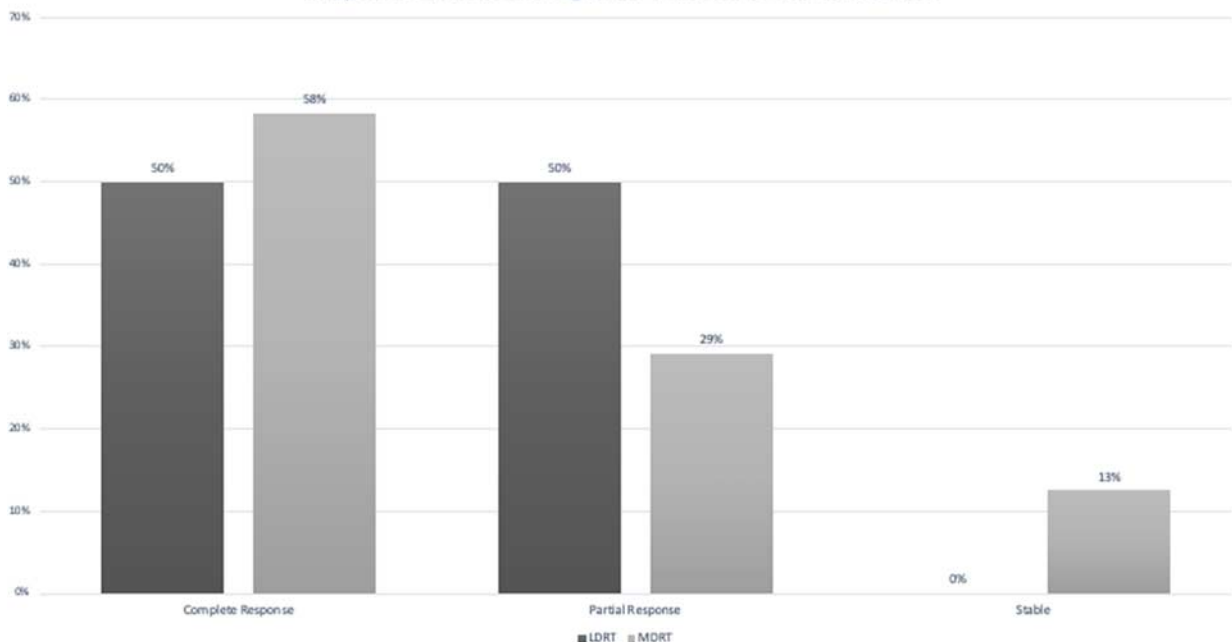

FIGURE 1. Rates of complete response, partial response and stable disease following radiotherapy by low-dose radiotherapy and moderate-dose radiotherapy groups.

TABLE 1. Characteristics Associated with Complete Response versus Partial or Worse Response to RT Using a Univariate Logistic Regression Analysis

Characteristics associated with complete response versus partial or worse response to RT		
Variable	OR (95% CI)	p-value
Age at RT (continuous)	0.99 (0.95-1.03)	0.580
Limited vs Advanced Stage		
Limited	Reference	
Advanced	1.16 (0.25-5.29)	0.847
Year of RT (continuous)	0.98 (0.80-1.20)	0.856
RT before or after 2016 (most sig. cutoff)		
Before 2016	Reference	
2016 or After	1.96 (0.52-7.41)	0.319
Lymphoma Histology		
Marginal Zone Lymphoma	Reference	
Follicular Lymphoma	1.43 (0.32-6.49)	0.642
Mantle Cell Lymphoma	0.20 (0.02-2.17)	0.188
Bilateral Orbit Involvement		
Yes	Reference	
No	0.22 (0.05-0.95)	0.042
Max Tumor Dimension (continuous)	0.96 (0.87-1.05)	0.369
Max Tumor Dimension (cutoff around mean)		
≤24 mm	Reference	
>24 mm	1.07 (0.59-5.91)	0.937
Elevated LDH		
Yes	Reference	
No	0.78 (0.15-4.07)	0.768
Unknown	0.15 (0.01-2.05)	0.155
LDRT vs MDRT		
MDRT	Reference	
LDRT	0.51 (0.13-2.08)	0.348
Concurrent/Sequential Rituximab		
Yes	Reference	
No	1.67 (0.31-8.93)	0.551

stage disease or secondary orbital lymphoma following systemic dissemination. Represented indolent histologies included MZL (20 patients), FL (11 patients), and mantle cell lymphoma (MCL, 5 patients). ORR were recorded according to Deauville or RECIST criteria with a response characterized as a complete response (CR) or partial response. Univariate Cox regression analysis was performed for characteristics associated with the studied outcomes.

Results: LDRT was delivered for 14 courses and MDRT for 24 courses. The median MDRT dose was 24 Gy (range 21-36 Gy in 1.5-2 Gy fractions). Concurrent or sequential Rituximab was used in 8 patients. Advanced stage (odds ratio (OR) 7, $P=0.021$) and year of RT ≥ 2016 (OR 24, $P=0.008$) were associated with increased use of LDRT. For the LDRT group, ORR and CR were 100% and 50%, respectively, compared with 87.5% and 58.3%, respectively, for the MDRT group. No evaluated characteristics, including the use of LDRT, were significantly associated with inferior ORR. Unilateral orbital involvement was associated with inferior CR rates (OR 0.22, $P=0.042$) compared with bilateral orbital involvement.

Conclusions: RT for LGNHL of the orbit is an effective treatment modality with ORR exceeding 90%. Due to the exquisite radio-sensitivity of orbital LGNHL, LDRT produces similar response rates as compared with more protracted RT courses. Present data suggests that LDRT should be considered for patients with orbital LGNHL; however, further studies with larger patient numbers are warranted to show significant associations (Fig. 1 and Table 1).

(OA38) Rayos Contra Cancer Connects Volunteers and Clinics to Impact Radiotherapy Together

Benjamin Li, MD, MBA¹, David Martinez, MD², Gustavo Sarria, MD³, Fei Yang, BA⁴, Raymond Carter, BA⁵, Serguei Castaneda, MD⁶, Oluwadamilola Oladeru, MD, MA⁷, Daniel Wakefield, MD, MPH⁸, Soha Ahmed, MD, MBA⁹, Shada Wadi-Ramahi, PhD¹⁰, Maria Caicedo, MD¹¹, Anuja Jhingran, MD¹², Adam Shulman, MS¹³, Apolo Salgado, MD¹⁴, Layth Mula-Hussain, MD¹⁵, Dante Roa, PhD¹⁶; ¹Rayos Contra Cancer, UCSF, ²Rayos Contra Cancer, Oncosalud AUNA, ³Rayos Contra Cancer, University Medical Hospital Bonn, ⁴Rayos Contra Cancer, Vanderbilt University Medical Center, ⁵Rayos Contra Cancer, St. Jude Children’s Research Hospital, ⁶Rayos Contra Cancer, Thomas Jefferson University, ⁷Rayos Contra Cancer, Massachusetts General Hospital, ⁸Rayos Contra Cancer, University of Tennessee Health Science Center; Harvard T.H. Chan School of Public Health, ⁹Rayos Contra Cancer, Aswan University, ¹⁰University of Pittsburgh Medical Center, ¹¹Rayos Contra Cancer, Instituto Nacional de Cancerologia, ¹²MD Anderson Cancer Center, ¹³Rayos Contra Cancer, Sarah Cannon Cancer Center, ¹⁴Rayos Contra Cancer, Instituto Nacional del Cancer, ¹⁵Rayos Contra Cancer, The Ottawa Hospital Cancer Centre, ¹⁶Rayos Contra Cancer, University of California Irvine

Background: Rayos Contra Cancer (RCC) is a 501(c)(3) non-profit organization whose mission is to create sustainable access to timely, high-quality, and affordable radiation treatment for cancer in limited-resource settings globally. RCC has a clinic-centric approach and focuses on education and training programs in areas where support is otherwise scarce for radiation therapy.

Objectives: Demonstrate the potential of coordinated education and training to reach and improve radiation oncology team confidence, knowledge, and competence in clinics globally.

Methods: From 2019 to 2021, RCC created, administered, and measured 9 longitudinal curriculum programs to clinics with functional medical equipment but gaps in education and training. Each curriculum focused on purely practical aspects of the clinic-wide transition to new radiotherapy techniques. RCC used the Project ECHO (Extension for Community Health Outcomes) telehealth model with professional peer-to-peer support and synchronous group learning in underserved communities via teleconferencing. Each curriculum consisted of live 1-hour sessions given 1-2 times per week over 3-4 months. Programs used multi-institutional collaboration, involved medical professional, trainee, and student volunteers, and incorporated cloud-based

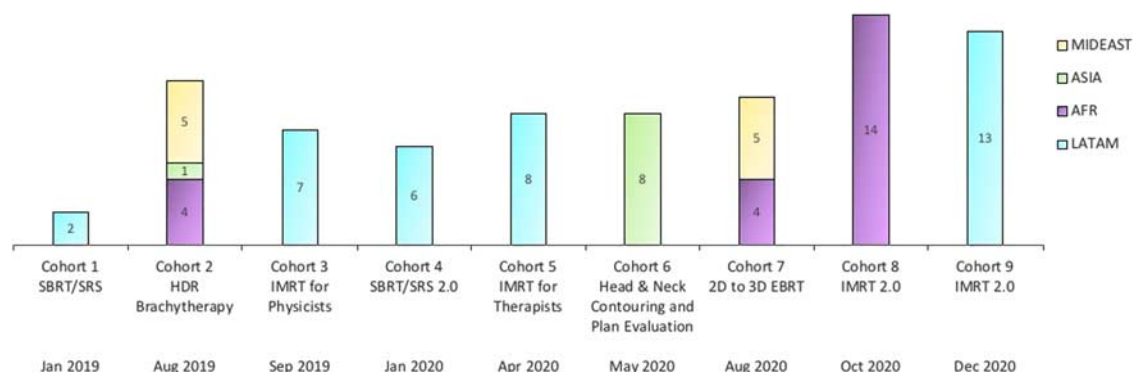

FIGURE 1. Number of clinics trained from 2019–2021, by region.

TABLE 1. Training Program Sessions, Participants, and Patient Impact

Curriculum	Sessions	Countries	Participating Clinicians	MPs and MP Residents	ROs and RO Residents	RTTs	Other	Not recorded	Patient Lives Impacted Per Year
SBRT/SRS	12	1	83	12	15	15	16	25	4,551
IMRT	8	2	19	13	2	1	0	3	1,210
HDR Brachy	19	9	53	27	4	2	5	15	4,316
SBRT/SRS 2.0	15	2	213	24	96	44	5	44	12,200
IMRT for RTTs	14	4	101	5	1	52	8	35	3,000
H&N CPE	14	1	48	0	40	0	0	8	2,392
2D to 3D EBRT	26	5	196	41	100	41	15	0	9,325
IMRT 2.0 English	29	9	142	55	52	18	6	11	10,978
IMRT 2.0 Spanish	28	10	205	63	88	37	22	0	27,045
TOTAL	165	43	1060	240	398	210	77	141	75,017

SBRT = Stereotactic Body Radiotherapy

SRS = Stereotactic Radiosurgery

HDR = High Dose Rate

IMRT = Intensity Modulated Radiotherapy

H&N CPE = Head and Neck Contouring and Plan Evaluation

EBRT = External Beam Radiotherapy

MP = Medical Physicists

RO = Radiation Oncologists

RTTs = Radiation Therapists

technology. We measured participation, costs, and educational outcomes and gathered facility operation details to estimate patient impact.

Results: 43 countries, 77 clinics, and 1,060 clinicians participated in 9 training cohorts. Clinicians included 398 (37.5%) radiation oncologists and residents, 240 (22.6%) medical physicists and physics trainees, 210 (19.8%) radiation therapists, 77 (7.3%) other, and 141 (13.3%) not recorded. A total 165 sessions were delivered by 9 education teams comprised of 82 radiation oncology professionals, 28 residents or physics graduate students, 35 medical or pre-medical students, and 76 on-site clinic coordinators. Educators included 37 (43.5%) medical physicists, 30 (35.3%) radiation oncologists, 15 (17.6%) radiation therapists, 3 (3.5%) dosimetrists. Notably, 28 (37.8%) of 74 US-based educators were originally from outside the US. RCC's 3-year expenses totaled \$43,273. The USD market value of all programs combined was \$3,176,000, and RCC charged \$0. Paired measurements of pre- vs. post-curriculum clinician confidence, knowledge, and competence significantly improved across multiple practical domains. Based on treatment facility data, the estimated clinical benefit to date is 75,017 patient lives impacted per year.

Conclusions: Based on 3 years of experience, each volunteer educator has the potential to impact approximately 1,000 patient lives per year through participation in RCC education and training. Participating clinics in RCC programs showed improved confidence, knowledge, and competence. With low-cost coordination at the volunteer student through resident level, we show a vehicle to improve radiotherapy globally (Fig. 1 and Table 1).

(OA39) 18F-Fluciclovine PET/CT to Distinguish Radiation Necrosis from Tumor Progression in Brain Metastases Treated with Stereotactic Radiosurgery: A Prospective Pilot Study

Timothy Smile, MD¹, Martin Tom, MD², Frank DiFilippo, PhD¹, Stephen Jones, MD, PhD¹, John Suh, MD³, Erin Murphy, MD¹, Jennifer Yu, MD, PhD¹, Alireza Mohammadi, MD¹, Gene Barnett, MD,

MBA¹, Steve Huang, MD¹, Guiyun Wu, MD¹, Nancy Obuchowski, PhD¹, Manmeet Ahluwalia, MD¹, David Peereboom, MD¹, Glen Stevens, DO, PhD¹, Robin Davis¹, Megan Firman¹, Samuel Chao, MD¹; ¹Cleveland Clinic, ²Miami Cancer Institute, Baptist Health South Florida, ³Department of Radiation Oncology, Taussig Cancer Institute, Cleveland Clinic

Background: 18F-Fluciclovine PET/CT is a widely available FDA-approved amino acid radiotracer for evaluation of suspected prostate cancer recurrence.

Objectives: To determine if 18F-fluciclovine PET/CT has utility in distinguishing tumor progression (TP) from radiation necrosis (RN) among patients with brain metastases having undergone prior stereotactic radiosurgery (SRS).

Methods: The primary objective is to estimate the accuracy of 18F-fluciclovine PET/CT in distinguishing RN from TP. We enrolled adult subjects with brain metastases who underwent prior SRS and presented with a follow up MRI brain (with DSC MR perfusion) which was equivocal for RN versus TP. Based on equivocal MRI before PET, subjects were divided into pre-PET subgroups of equivocal with suspicion for TP or RN, or truly equivocal, by the study neuroradiologist. Within 30 days of equivocal MRI brain, subjects underwent 18F-fluciclovine PET/CT on a Siemens Biograph mCT scanner following a 10 mCi bolus dose immediately before PET. PET data were collected in list mode for 25 mins post-injection and were reconstructed as a static image of data 10-25 mins post-injection, and as a dynamic series of four 5-min frames between 5-25 mins post-injection. Quantitative metrics for each lesion were documented including SUV max, SUV mean, SUV peak, and normal brain SUV mean. Lesion to normal brain ratios were calculated. The reference standard was clinical follow up with MRI brain (with DSC MR perfusion) every 2-4 months until multi-disciplinary consensus (or tissue confirmation) for diagnosis of RN versus TP.

Results: From 7/2019-9/2020, 14 of 16 planned subjects enrolled and underwent 18F-fluciclovine PET/CT for evaluation of 19 brain lesions. Primary histology was NSCLC in 6, breast in 4, melanoma in 3, and

TABLE 1. NSCLC: non-small cell lung carcinoma, RN: radionecrosis, TP: tumor progression, E: equivocal, Dx: diagnosis, SUV: standardized uptake value

Primary	Location	Suspicion	Final Dx	SUVmax	SUVmean	SUVpeak	Normal brain SUVmean
Breast	Left centrum semiovale	RN	RN	2.180	1.160	1.060	0.275
NSCLC	Left parietal	RN	RN	2.510	1.490	1.110	0.188
Melanoma	Right mesial temporal	RN	RN	2.720	1.500	1.780	0.298
Endometrial	Left frontoparietal	RN	RN	3.176	1.6	1.503	0.1971
NSCLC	Left Frontal	RN	RN	3.280	1.860	1.980	0.435
Melanoma	Left parietal	RN	RN	3.470	2.050	2.000	0.274
NSCLC	Right parietal	TP	RN	3.770	2.280	2.320	0.324
NSCLC	Right parietal	RN	RN	4.46	2.46	2.66	0.435
NSCLC	Right cerebellum	RN	RN	5.500	3.330	3.320	0.188
NSCLC	right frontoparietal	RN	TP	4.338	2.37	2.282	0.2172
Breast	Right cerebellum	E	TP	8.780	4.480	4.450	0.347
Breast	Left paracentral lobule	TP	TP	12.100	7.370	2.560	0.279

endometrial in 1. Among all 19 imaged lesions, ranges of quantitative metrics were: SUV max, 2.18-12.1; SUV mean, 1.16-7.37; SUV peak, 1.06-4.45; normal brain SUV mean, 0.19-0.44; SUV max/normal ratio, 7.5-45.4; SUV mean/normal ratio, 4.2-26.3; and SUV peak/normal ratio, 3.9-26.4. Follow up was completed for 10 patients as described in the Table. No adverse events have been reported.

Conclusions: In this population, 18F-fluciclovine PET/CT produces a wide range of lesion quantitative metric values and low uptake in the normal brain. Ongoing follow up is required, however, preliminary results are promising and suggest 18F-fluciclovine PET/CT may be able to accurately distinguish RN from TP. Final results of this pilot study are expected within a year. Phase II and III studies are under development (Table 1).

(OA40) Multi-institutional Validation of Recursive Partitioning Analysis for Overall Survival in Patients Undergoing Spine Radiosurgery for Spine Metastasis

Jonathan Hanan, BA¹, Samuel Chao, MD², Arjun Sahgal, MD³, Wei Wei, MS², Mikki Campbell, MHE³, Chandana Reddy, MS⁴, Lilyana Angelov, MD⁵, John Suh, MD⁶, Anthony Magnelli, MS⁶, Salim Balik, PhD⁶, Ping Xia, PhD⁶, Kailin Yang, MD, PhD⁶, Alireza Mohammadi, MD², Ehsan Balagamwala, MD⁶; ¹Case Western Reserve University School of Medicine, ²Cleveland Clinic, ³Department of Radiation Oncology, Sunnybrook Odette Cancer Centre, University of Toronto, ⁴Department of Radiation Oncology, Taussig Cancer Institute, Cleveland Clinic, Cleveland, OH, ⁵Department of Neurosurgery, Cleveland Clinic, ⁶Department of Radiation Oncology, Taussig Cancer Institute, Cleveland Clinic

Background: The recently developed recursive partitioning analysis (RPA) classification system for overall survival (OS) in patients undergoing spine stereotactic radiosurgery (sRS) yielded three distinct prognostic groups for patients with spine metastasis. We sought to externally validate this RPA with a larger patient cohort using a multi-institutional dataset.

Objectives: Validate the recursive partitioning analysis (RPA) for spine stereotactic radiosurgery (sRS).

Methods: 444 patients were utilized to develop the recently published sRS RPA predictive of OS in patients with spine metastases. The RPA identified three prognostic classes: RPA Class 1 was defined as KPS > 70 and controlled systemic disease (n = 142); RPA Class 2 was defined as KPS > 70 with uncontrolled systemic disease or KPS ≤ 70, age ≥ 54 and absence of visceral metastases (n = 207); RPA Class 3 was defined as KPS ≤ 70 and age < 54 years or KPS ≤ 70, age ≥ 54 years, and presence of visceral metastases (n = 95). Data from a large tertiary care center was utilized to validate this RPA. A total of 221 patients (467 spinal segments)

were in the validation cohort and divided based on their RPA classes. Kaplan-Meier method was used to estimate OS and log-rank test was used to compare OS between RPA classes.

Results: In the validation cohort (221 patients), the median OS was 19.9 months and the median follow-up was 36 months (range, 0.1-70.8 mo). The majority (85%) of patients received 24 Gy (range, 20-35 Gy) in 2 fx (range, 2-10). Forty-three (19.5%) patients were in RPA Class 1, 165 (74.7%) patients in RPA Class 2 and 13 (5.9%) patients in RPA Class 3. The median OS in the validation cohort based on RPA Class was 54 months for Class 1, 15.8 months for Class 2 and 6.8 months for Class 3. Patients in RPA Class 1 had a significantly better OS compared with those in Class 2 and Class 3 of the validation cohort ($P < 0.01$). The difference in OS between RPA Class 2 and Class 3 was not statistically significant due to small number of patients in RPA Class 3.

Conclusions: The external dataset validated the spine sRS RPA for RPA Classes 1 and 2. RPA Class 3 was not validated successfully, which was likely due to small patient numbers. Based on our validation, upfront spine SRS is strongly supported for patients in RPA Class 1. Additionally, either upfront spine SRS or conventional radiotherapy is supported for RPA Class 2 patients. Patients in RPA Class 3 would benefit most from upfront conventional radiotherapy. Given successful validation, this RPA will be utilized as enrollment criteria for an upcoming investigator-initiated trial.

(OA41) Concurrent versus Sequential Stereotactic Radiosurgery and Immune Checkpoint Inhibition in Brain Metastases: An International Cooperative Group Study

Eric Lehrer, MD, MS¹, Jason Gurewitz, BA², Timothy Malouff, MD³, Kenneth Bernstein, MS², Douglas Kondziolka, MD², Brianna Jones, MD¹, Phillip Bonney, MD⁴, Samir Patel, MD⁵, Joshua Palmer, MD⁶, Kareem Fakhoury, MD⁷, Chad G. Rusthoven, MD⁷, David Mathieu, MD⁸, Christopher Deibert, MD⁹, Piero Picozzi, MD¹⁰, Cheng-chia Lee, MD, PhD¹¹, Sonam Sharma, MD¹, Ajay Niranjani, MD¹², L. Dade Lunsford, MD¹², Jason Sheehan, MD, PhD¹³, Manmeet Ahluwalia, MD, MBA¹⁴, Daniel Trifiletti, MD¹⁵; ¹Icahn School of Medicine at Mount Sinai, ²NYU Langone Medical Center, ³Mayo Clinic, ⁴University of Southern California, ⁵University of Alberta, ⁶The Ohio State University Wexner Medical Center, ⁷University of Colorado School of Medicine, ⁸Université de Sherbrooke, Centre de recherche du CHUS, ⁹Emory University, ¹⁰IRCCS Humanitas Research Hospital, ¹¹Taipei Veteran General Hospital, ¹²University of Pittsburgh, ¹³University of Virginia, ¹⁴Miami Cancer Institute, ¹⁵Department of Radiation Oncology, Mayo Clinic, Jacksonville, FL, USA

Background: Multiple single institution retrospective analyses have suggested that concurrent administration (within 4 wk) of stereotactic

radiosurgery (SRS) and immune checkpoint inhibitors (ICI) is associated with improved overall survival (OS) when compared with sequential administration (more than 4 wk) in patients with brain metastases (BrM). However, there are limited data analyzing the risk of developing radiation necrosis (RN) and OS by timing of therapy.

Objectives: To evaluate the risk of development of RN and OS in patients with BrM treated with SRS/ICI.

Methods: The International Radiosurgery Research Foundation approved the analysis. Logistic and Cox regression models were used to identify covariates associated with the development of RN and OS. The Kaplan-Meier method and log-rank test were used to compare OS at 1- and 2-years post SRS. Patients with < 3-months of follow up were excluded.

Results: There were 546 patients (223 melanoma/287 NSCLC/36 RCC) across 10 institutions with 2,880 BrM. Median follow-up was 15.5 months, median age was 66 years (interquartile range [IQR]: 56-72 y). Median Karnofsky Performance Status (KPS) was 90. Median margin dose was 20 Gy (IQR: 18-20 Gy) in 1 fraction. The mean total BrM volume was 3.59cc, and mean V12 Gy was 8.33cc. Active extracranial disease was present in 78.0% at time of SRS. There were 65 patients (11.9%) who experienced RN (46.2% Grade 1, 40.0% Grade 2; 12.3% Grade 3; 1.5% Grade 4). On multivariate analysis, the number of SRS courses (Odds Ratio [OR]: 2.59, 95% confidence interval [CI]: 1.72-4.00; $P < 0.001$), total volume of treated BrM (OR: 1.09; 95% CI: 1.03-1.15; $P < 0.001$), melanoma histology (OR: 2.79; 95% CI: 1.39-5.68; $P = 0.004$), RCC histology (OR: 3.96; 95% CI: 1.23-11.44; $P = 0.01$), receipt of previous intracranial radiation therapy (RT) before SRS (OR: 8.88; 95% CI: 2.96-26.34; $P < 0.001$) were associated with the development of RN. When compared with anti-PD-1 monotherapy, anti-CTLA-4+anti-PD-L1 therapy (OR: 0.22, 95% CI: 0.07-0.57; $P = 0.004$) was associated with a lower likelihood of developing RN. Concurrent over sequential therapy ($P = 0.26$) and V12 ($P = 0.49$) were not significant. On multivariate analysis, female sex (Hazard Ratio [HR]: 0.62; 95% CI: 0.48-0.82; $P < 0.001$) and KPS (HR: 0.97; 95% CI: 0.96-0.99; $P < 0.001$) were prognostic for OS. Concurrent versus sequential therapy ($P = 0.55$), melanoma histology ($P = 0.20$), and RCC histology ($P = 0.21$) were not significant. The OS at 1-year was 74.1% vs. 76.4% and at 2-years was 56.3% vs. 53.8% for the concurrent and sequential groups, respectively ($P = 0.69$).

Conclusions: The risk of RN remains low at approximately 12% in patients treated with ICI/SRS, and 6.5% of patients develop symptomatic RN. This risk is significantly increased when patients undergo multiple SRS courses, have received prior cranial RT, and harbor more radioresistant tumor histologies (melanoma and RCC). Concurrent immunotherapy does not appear to increase this risk.

(OA42) Proton Radiation Therapy for Pediatric Chordomas

Myrsini Ioakeim-Ioannidou¹, Daniel Kim, MD MBA¹, Andrzej Niemierko, PhD¹, Paul Caruso, MD¹, David ebb, MD¹, Yen-lin chen, MD¹, Thomas DeLaney, MD¹, Shannon MacDonald, MD¹; ¹Massachusetts General Hospital

Background: Chordomas are rare primary bone tumors that arise from ectopic remnants of the embryonic notochord with an overall incidence of 0.08 per 100,000 in general population. Pediatric chordomas are very rare and comprise 5% of all chordoma cases. The most common location of pediatric chordomas is the base of the skull (BOS) followed by the mobile spine and the sacrum. Treatment for chordomas generally involves high-dose proton radiation therapy (PRT) with or without surgical resection.

Objectives: We report outcomes for pediatric patients with BOS and spinal chordomas treated with PRT.

Methods: Between 1981 and 2019, 236 pediatric patients with BOS (n = 194) or spinal (n=42) chordomas were treated with PRT or combined proton/photon approach (comboRT) at a single institution. The primary endpoints were overall survival (OS) and progression free survival (PFS). Cox proportional hazards regression and Kaplan Meier estimates were used for survival analyses.

Results: A total of 133 female and 103 male patients were identified. Median age at diagnosis was 10.9 years (range, 0.8-21 y) and 13.1 years

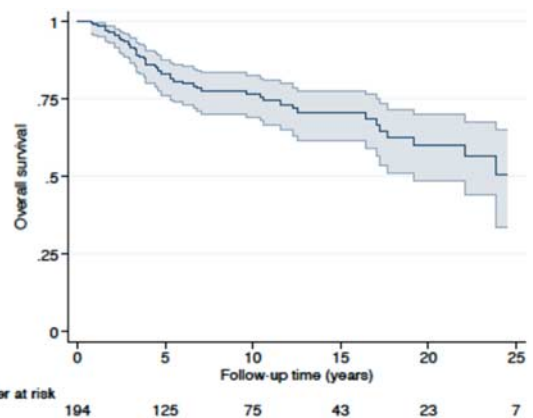

FIGURE 1. Kaplan-Meier survival curves for overall survival for skull base pediatric chordomas.

(range, 3.6-21 y) in the BOS and spinal cohort, respectively. The majority of the patients (n = 154) were diagnosed with conventional chordoma, 57 with a chondroid subtype, 13 with atypical/cellular, and 12 with poorly-differentiated chordoma. All patients underwent surgical resection (range, 1-8). 54 patients underwent gross total resection, 171 patients underwent STR while 11 patients had biopsy only. 23 patients received pre-RT chemotherapy. 62 patients developed progressive disease before the delivery of RT. Median total dose was 76 Gy (RBE) (range, 39.7-83.3 Gy) delivered in 1.2 - 2.2 Gy (RBE) fractions (1.2 Gy for BID). The median maximum dose to the brainstem was 65.7 Gy (RBE) (range, 40.8 - 80). The median maximum dose to the spinal cord was 63 Gy (RBE) (range, 30.6-68.5 Gy). At a median follow-up of 8.7 years (range, 0.6-35.6) from the date of diagnosis 68 patients recurred (42 local, 18 distant and 8 iatrogenic). The 5- and 10-year OS rates for BOS chordomas were 83% and 77%, respectively. The 5- and 10-year OS rates for spinal chordomas were 77% and 66%, respectively. The 5- and 10-year PFS rates in the BOS cohort were 75% and 71%, respectively. The 5- and 10-year PFS rates in the spinal cohort were 66% and 62%, respectively. RT was well tolerated, with most acute side effects limited to moderate erythema, otitis media and cervical dysphagia. Late toxicities included 5 cases of radiation myelitis, 4 cases of brainstem injury, 4 cases of temporal lobe injury and single case each of moyamoya disease, Lhermitte's syndrome, and esophageal stricture. 3 patients developed secondary radiation related malignancies.

Conclusions: This is the largest cohort of pediatric chordomas in the literature to date. High dose PRT following surgical resection is an effective treatment with a high rate of disease control and minimal late toxicity (Figs. 1 and 2).

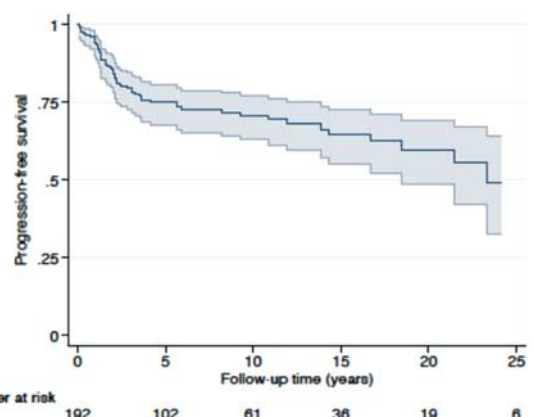

FIGURE 2. Kaplan-Meier survival curves for progression-free survival for skull base pediatric chordomas.

(OA43) Risk Factors for the Development of Leptomeningeal Disease and Outcomes Following Stereotactic Radiation for Patients with Breast Cancer Brain Metastases

Matthew Mills, MD¹, Chetna Thawani, BS², Nicholas Figura, MD¹, Daniel Oliver, MD³, Timothy Robinson, MD, PhD¹, Hsiang-Hsuan Michael Yu, MD³, Peter Forsyth, MD³, Kamran Ahmed, MD⁴; ¹H. Lee Moffitt Cancer Center and Research Institute, Department of Radiation Oncology, ²USF Morsani College of Medicine, ³H. Lee Moffitt Cancer Center & Research Institute, ⁴Department of Radiation Oncology, H. Lee Moffitt Cancer Center & Research Institute

Background: As the prognosis for patients with breast cancer brain metastases (BCBM) improves due to significant improvements in systemic therapy, the number of patients at risk for leptomeningeal disease (LMD) has increased. While local therapies such as surgical resection and stereotactic radiation (SRT) are known risk factors for LMD, the identification of patients with BCBM most at risk for LMD remains unclear.

Objectives: To identify the risk factors for the development of LMD in patients with BCBM after SRT.

Methods: This is a retrospective review of 181 patients who underwent SRT to 664 BCBM from 2004 to 2019. The Kaplan-Meier method was used to calculate time to LMD from SRT and overall survival (OS) from the diagnosis of LMD, with log-rank testing to identify significant correlations with patient and treatment characteristics. Univariate analysis (UVA) was completed with the Cox proportional hazards model.

Results: Median follow up from SRT was 11.4 months. Of the 181 patients, 60 (33%) had HR+/HER2- subtype, 30 (17%) had HR-/HER2+ subtype, 47 (26%) had HR+/HER2+ subtype, and 44 (24%) had HR-/HER2- subtype. The median interval of initial breast cancer diagnosis to brain metastasis disease was 52 months (range: 0-321). Of the 664 BCBMs, 534 (80%) received single fraction stereotactic radiosurgery (SRS) with a median dose of 21 Gy (range 12-24 Gy), and 130 (20%) received fractionated stereotactic radiation therapy (FSRT), with a median dose of 25 Gy (range: 12.5-35 Gy) delivered in 3 to 5 fractions. There were 68 cases (10%) of SRT to a postoperative cavity. Of the 181 patients, 24 (13%) developed LMD at a median of 18 months (1-57) from BCBM diagnosis and a median of 6.6 months (0.6-29) from SRT. Twelve and 24-month rates of LMD were 14% and 21%, respectively. Patients who were diagnosed with BCBM ≤ 52 months after original breast cancer (BC) diagnosis had a significantly greater risk of LMD (12 mo LMD 21% vs 7%, P=0.026). There was a trend toward significance for patients with extracranial systemic metastasis for greater risk of LMD (12 mo LMD 26.8% vs 10.9%, P=0.055) After diagnosis of LMD, 6 and 12-month rates of OS were 35% and 18%, respectively. An interval between SRT and LMD diagnosis ≤ 6 months was the only identified variable prognostic for inferior OS (6-month OS 0% vs 47%, P<0.001).

Conclusions: The risk of LMD for patients with BCBM after SRT remains relatively low, though patients with a short interval from BC diagnosis to BCBM diagnosis are at high risk of LMD. While the prognosis for patients with LMD is dismal, OS is particularly poor for those who develop LMD soon after SRT.

(OA44) Impact of Peri-operative Radiotherapy on Localized Sarcomas with TP53 Alterations: Retrospective Pooled Analysis of Two Precision Medicine Trials

Elise Nassif¹, Edouard Auclin², Rastilav Bahleda³, Charles Honore³, Olivier Mir³, Sarah Dumont³, Benoit Mery⁴, Khalil Hodroj⁴, Mehdi Brahmi⁴, Olivier Tredan⁴, Isabelle Ray-Coquard⁴, Jean-Yves Blay⁴, Christophe Massard³, Axel Le Cesne³, Amelle Dufresne⁴, Antonin Levy³, Cecile Le Pechoux³, Ritsuko Komaki⁵; ¹MD Anderson Cancer Center, ²APHP, ³Gustave Roussy, ⁴Leon Berard, ⁵Baylor College of Medicine

Background: Sarcomas are rare diseases with a dismal prognosis. We have previously reported an unfavorable prognostic impact of TP53 mutations on disease-free survival (DFS) in sarcomas and an increased objective response rate to chemotherapy.

Objectives: We sought to characterize the impact of peri-operative radiation therapy (RT) in sarcomas with TP53 alterations. Our objectives were type of first relapse (local versus metastatic) and DFS according to peri-operative RT administration and TP53 status.

Methods: MOSCATO and ProfILER trials were precision oncology trials in advanced pan-histology tumors. Genomic molecular profiling was done by targeted next-generation sequencing and comparative genomic hybridization array. This is an ad hoc analysis of sarcoma patients included in these trials. Molecular data from patients was associated to their clinical data in localized standard-of-care treatment using the national prospective French Sarcoma Group database. Homozygous deletions and mutations of TP53 were retained as significant alterations. For comparison of categorical variables, Fisher's exact test was used. For comparison of DFS, univariate Cox models were used.

Results: A total of 155 sarcomas, including 123 soft-tissue sarcomas (STS), were initially localized and surgically resected, amongst which 46 leiomyosarcomas (30%), 14 undifferentiated pleomorphic sarcomas (9%) and 15 liposarcomas (10%). STS were grade 1, 2 and 3 in 19%, 34% and 47% of patients, respectively. TP53 status was determined on primary tumor and metastasis in 77 cases each (50%, 1 not available). Peri-operative RT was administered in 61 patients (39%). TP53 alterations were found in 40 sarcomas, including 35 STS, and were treated with peri-operative RT in 18 cases, including 16 STS patients. Irrespective of RT, first recurrence was metastatic in 37 and local in 3 of the TP53 altered tumors, whereas it was metastatic in 81 and local in 31 cases of TP53 wild-type (WT) sarcomas (P=0.01; Table 1). In STS subgroup, there was only one local relapse and 34 metastatic relapses in the TP53 altered tumors (P=0.01). There were 13% (N=8/61) local recurrences in patients receiving RT versus 28% (N=26/94) without RT (P=0.027). In TP53 altered sarcomas, there was one (6%, N=1/18) and two (9%, N=2/22) local relapses with or without RT, respectively (P=1; Table 1). In TP53 WT sarcomas, there was 16% (N=7/36) and 33% (N=24/72) of local relapses, with or without RT (P=0.04). In TP53 altered STS, the only local recurrence was in a patient without peri-operative RT. In TP53 altered sarcomas, median DFS with or without peri-operative radiotherapy was 10 and 14 months (P=0.5) and DFS rate at 12 months was 72% (95%CI=54-96) and 41% (95%CI=25-68) with or without RT, respectively. In TP53 WT tumors, median DFS with or without peri-operative RT was 17 months in both groups (Fig. 1).

Conclusions: In our retrospective cohort, TP53 alterations are associated with metastatic relapse, which warrants further validation. We are recording the pathological response to radiotherapy, in sarcomas who underwent pre-operative radiation therapy, which will be available for presentation at ARS.

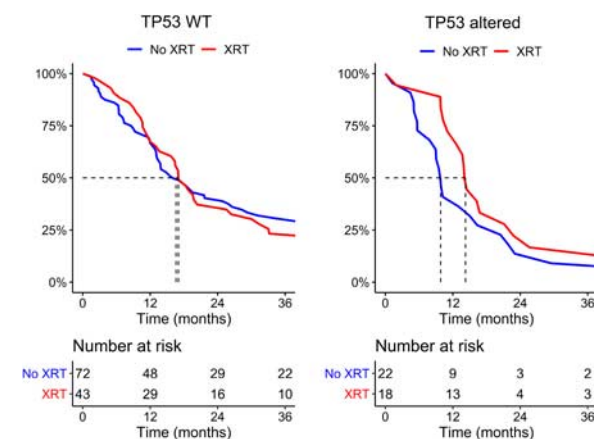

FIGURE 1. Disease-free survival according to TP53 status and peri-operative radiotherapy administration. XRT = Radiotherapy; WT = Wild-Type.

TABLE 1. Type of Relapse According to TP53 Alterations, Treatment Modalities and Major Clinic-Pathological Characteristics at Diagnosis

Characteristic	All patients				TP53 altered			TP53 Wild-Type			
	None, N = 3	Local, N = 34	Metastatic, N = 118	p-value	Local, N = 3	Metastatic, N = 37	p-value	None, N = 3	Local, N = 31	Metastatic, N = 81	p-value
TP53 altered	0	3 (8.8%)	37 (31%)	0.012							
Peri-operative Radiotherapy	0	8 (24%)	53 (45%)	0.027	1 (33%)	17 (46%)	>0.9	0	7 (23%)	36 (44%)	0.04
Peri-operative anthracyclines	1 (33%)	9 (26%)	49 (42%)	0.2	2 (67%)	13 (36%)	0.5	1 (33%)	7 (23%)	36 (44%)	0.091
Resection margin	Unknown	0	0	1	0	1	0.2				0.014
	R0	3 (100%)	9 (29%)	59 (56%)	1 (33%)	19 (63%)		3 (100%)	8 (29%)	40 (53%)	
	R1	0	10 (32%)	28 (27%)	2 (67%)	5 (17%)		0	8 (29%)	23 (31%)	
	R2	0	12 (39%)	18 (17%)	0	6 (20%)		0	12 (43%)	12 (16%)	
	Unknown	0	3	13	0	7		0	3	6	
Localization							0.012				0.087
	Extremities	1 (33%)	10 (29%)	39 (33%)	0	6 (17%)		1 (33%)	10 (32%)	33 (41%)	
	Abdominal	2 (67%)	4 (12%)	16 (14%)	0	9 (25%)		2 (67%)	4 (13%)	7 (8.6%)	
	Retroperitoneal	0	4 (12%)	15 (13%)	0	5 (14%)		0	4 (13%)	10 (12%)	
	Uterus	0	1 (2.9%)	23 (20%)	0	8 (22%)		0	1 (3.2%)	15 (19%)	
	Head and Neck	0	7 (21%)	6 (5.1%)	2 (67%)	1 (2.8%)		0	5 (16%)	5 (6.2%)	
	Thorax	0	8 (24%)	18 (15%)	1 (33%)	7 (19%)		0	7 (23%)	11 (14%)	
	Unknown	0	0	1	0	1					
Grade				0.087			0.6				0.2
	1	1 (100%)	8 (33%)	14 (15%)	0	2 (6.9%)		1 (100%)	8 (36%)	12 (19%)	
	2	0	7 (29%)	32 (34%)	1 (50%)	8 (28%)		0	6 (27%)	24 (38%)	
	3	0	9 (38%)	47 (51%)	1 (50%)	19 (66%)		0	8 (36%)	28 (44%)	
	Unknown	2	10	25	1	8		2	9	17	
Histotype							0.2				
	Leiomyosarcoma	1 (33%)	3 (8.8%)	42 (36%)	1 (33%)	20 (54%)		1 (33%)	2 (6.5%)	22 (27%)	
	Liposarcoma	0	5 (15%)	10 (8.5%)	0	4 (11%)		0	5 (16%)	6 (7.4%)	
	Undifferentiated Pleomorphic Sarcoma	0	1 (2.9%)	13 (11%)	0	5 (14%)		0	1 (3.2%)	8 (9.9%)	
	Rhabdomyosarcoma	2 (67%)	0	10 (8.5%)	0	1 (2.7%)		2 (67%)	0	9 (11%)	
	Endometrial stromal sarcoma	0	1 (2.9%)	7 (5.9%)	0	1 (2.7%)		0	1 (3.2%)	6 (7.4%)	
	Synovial Sarcoma	0	1 (2.9%)	2 (1.7%)	0	0		0	1 (3.2%)	2 (2.5%)	
	Primitive neuro-ectodermic tumor	0	3 (8.8%)	9 (7.6%)	1 (33%)	3 (8.1%)		0	2 (6.5%)	6 (7.4%)	
	Osteosarcoma	0	7 (21%)	5 (4.2%)	1 (33%)	0		0	6 (19%)	5 (6.2%)	
	Chondrosarcoma	0	4 (12%)	3 (2.5%)	0	0		0	4 (13%)	3 (3.7%)	
	Other	0	9 (26%)	17 (14%)	0	3 (8.1%)		0	9 (29%)	14 (17%)	
Size				0.7			0.2				0.8
	<5cm	1 (33%)	9 (33%)	27 (27%)	2 (67%)	6 (21%)		1 (33%)	7 (29%)	21 (30%)	
	5-10cm	2 (67%)	10 (37%)	35 (35%)	1 (33%)	11 (38%)		2 (67%)	9 (38%)	24 (34%)	
	>10cm	0	8 (30%)	37 (37%)	0	12 (41%)		0	8 (33%)	25 (36%)	
	Unknown	0	7	19	0	8		0	7	11	

(OA-01JIT) Prognostic Value of Baseline Metabolic Tumor Volume in Intermediate-Risk Hodgkin Lymphoma After Chemo-radiation Therapy: FDG PET Parameter Analysis in a Subgroup from COG AHOD0031

Sarah Milgrom, MD¹, Jihyun Kim, MD², Alin Chirindel, MD³, Jongho Kim, MD PhD³, Qinglin Pei, PhD⁴, Lu Chen, PhD⁵, Allen Buxton, MS⁶, Sandy Kessel, BA⁶, Jeffrey Leal, BA³, Kathleen McCarten, MD⁷, Bradford Hoppe, MD⁸, Suzanne Wolden, MD⁹, Cindy Schwartz, MD¹⁰, Debra Friedman, MD¹¹, Kara Kelly, MD¹², Steve Cho, MD¹³. ¹University of Colorado, ²University of Wisconsin School of Medicine and Public Health, ³Johns Hopkins University, ⁴Children's Oncology Group, Statistics and Data Center, Department of Biostatistics, University of Florida, ⁵University of Florida, ⁶Children's Oncology Group, Statistics and Data Center, ⁷IROC, ⁸Mayo Clinic Florida, ⁹Memorial Sloan Kettering Cancer Center, ¹⁰Medical College of Wisconsin, ¹¹Vanderbilt University, ¹²Pediatric Oncology, Roswell Park Comprehensive Cancer Center, ¹³Department of Radiology, University of Wisconsin School of Medicine and Public Health

Background: Positron emission tomography (PET)-based measures of baseline total-body tumor burden may improve risk stratification in pediatric and adolescent patients with intermediate-risk Hodgkin lymphoma (HL).

Objectives: To assess for an association of metabolic tumor volume (MTV) and total lesion glycolysis (TLG) with event-free survival (EFS) To define which thresholds, used to define the MTV and TLG, are the most prognostic.

Methods: Evaluable patients were identified from a cohort treated homogeneously with the same combined modality regimen on the multi-center, prospective Children's Oncology Group AHOD0031 study. Eligible patients had high-quality baseline PET scans. MTV and TLG were each measured based on 15 thresholds for every patient. Univariate and multivariable Cox regression and Kaplan-Meier survival analyses assessed for an association of MTV and TLG with EFS.

Results: From the AHOD0031 cohort (n = 1,712), 86 patients were identified who i) were treated with 4 cycles of ABVE-PC chemotherapy followed by involved field radiotherapy and ii) had a baseline PET scan that was amenable to quantitative analysis. Based on univariate Cox regression analysis, 6 PET-derived parameters were significantly associated with EFS. For each of these, Kaplan-Meier analyses and the log-rank test were used to compare patients with highest tumor burden (i.e. highest 15%) to the remainder of the cohort. EFS was significantly associated with all 6 PET parameters (all P < 0.029). In a multivariable model controlling for important covariates including disease bulk and response to chemotherapy, MTV2BP (MTV defined by the threshold of 2 * blood pool SUVmean) was significantly associated with EFS (P = 0.012).

Conclusions: Multiple baseline PET-derived volumetric parameters were associated with EFS. MTV2BP was highly associated with EFS when controlling for disease bulk and response to chemotherapy. These two factors, bulky disease and early response to chemotherapy, are used in current trials to guide risk-adapted treatment. Thus, baseline PET measures of metabolic tumor burden may provide additional prognostic information and improve risk stratification for individualized treatment regimens in intermediate-risk HL.

POSTER ABSTRACTS

(P001) Human-Induced Pluripotent Stem Cell Derived Cerebral Organoids as a Model of Normal Brain Tissue Response to Proton Radiation

Lawrence Bronk, PhD¹, Julianna Bronk, MD, PhD², Sanjay Singh, PhD¹, Xiaochun Wang, PhD¹, Dadi Jiang, PhD¹, Fada Guan, PhD¹, Albert Koong, MD, PhD¹, Radhe Mohan, PhD¹, Frederick Lang, MD¹, David Grosshans, MD, PhD³; ¹MD Anderson Cancer Center, ²University of Texas MD Anderson Cancer Center, ³The University of Texas MD Anderson Cancer Center

Background: Treatment-related sequelae following cranial irradiation have life changing impacts for patients and their caregivers. Characterization of the basic response of human brain tissue to irradiation is challenging due to a lack of representative preclinical models. However, due to advances in stem cell biology, neuroscience, and tissue engineering, the direct study of human brain tissue in vitro is becoming possible. **Objectives:** Cerebral organoids (COs), a novel human brain tissue model system, have previously been applied to study neurological disease and disorders including Zika and COVID-19 virus exposure and autism spectrum disorder. However, COs have not been translated into the field of neuro-oncology to study of the sequelae of oncologic treatment effects. We aim to establish a CO model to study the radio-response of normal human brain tissue.

Methods: COs were grown using human induced pluripotent stem cells and a modified Lancaster protocol (1,2), irradiated using protons to 0, 2, 5, and 9 Gy and prepared for immunostaining at 2-days post-irradiation. To examine the effect of irradiation on the neural stem cell (NSC) population, sections were stained for SOX2 and Ki-67 expression denoting NSCs and proliferation respectively. Slides were imaged and scored using the CellProfiler software package. LDH release was quantified over time as a marker of cell damage.

Results: The percentage of proliferating NSCs 2-days post-irradiation was found to be reduced for proton irradiated COs ($23.7 \pm 5.2\%$ ($P=0.14$), $17.8 \pm 6.5\%$ ($P=0.02$), and $20.9 \pm 2.1\%$ ($P=0.05$) at 2, 5, and 9 Gy-RBE respectively) compared with control ($33.0 \pm 5.5\%$). At 2-days post irradiation to 2 Gy, increased apoptotic markers, cleaved caspase-3 and cleaved PARP, were found. LDH release increased when assayed at timepoints of 2, 4, and 6-days post proton irradiation to 9 Gy and decreased towards baseline on day 9 and 11.

Conclusions: The loss of proliferating NSCs, upregulation of apoptosis, and time dependent acute LDH release demonstrate the early effects of proton radiation in a model of human brain tissue. Our initial results indicate COs will be a valuable model to study the effects of radiation therapy and immediate next steps will focus on defining the predominant mechanisms of and therapeutic interventions to mitigate proton radiation mediated brain tissue damage.

(P002) Measuring and Molecularly Defining Intra-Tumoral Hypoxia in High-Risk Sarcoma

David Shultz, MD, PhD¹, Jennifer Dorsey, BS², Patrick Veit-Haibach, MD², Rebecca Gladly, MD, PhD², Harley Chan, PhD², Jay Wunder, MD²; ¹Princess Margaret Cancer Centre, ²University of Toronto

Background: Tumor hypoxia is associated with poor outcomes in soft tissue sarcoma (STS) through mechanisms that are not fully understood. We are currently conducting a clinical trial of high-risk STS in which we are measuring hypoxia with FAZA-PET/MRI and pimonidazole (PIMO) uptake detected through immunohistochemistry (IHC).

Objectives: To investigate hypoxia-specific epigenetic profiles, we plan to isolate PIMO+ and PIMO- tumor cells from surgically resected tumors and then assess DNA methylation in these populations using an array-based approach. To generate preliminary data and establish the techniques required to evaluate clinical samples, we prepared methylated DNA from two primary cell lines (ST148 and ST548) generated from patients with high-risk STS (undifferentiated pleomorphic sarcoma).

Methods: Cells were grown in a hypoxic or normoxic chamber for 72 hours. Bisulfite converted DNA was prepared and analyzed using an 850K methylation site array. All computational analyses were performed in R. We used DMRforPairs to compare median methylation values in a

pairwise fashion. Regions with median differences in M values (dM) > 0.5 in at least one pairwise comparison were considered relevant.

Results: In ST148 and ST548, 93, and 27 relevant regions were identified, respectively. Within each cell line, several of the identified regions were within putative regulatory elements of the same gene. For example, in STS148, 5 of 93 identified regions were within or adjacent to SH3YL1, which has previously been identified as a hypoxia-repressed gene. Several of the same hypoxia associated genes were identified in both cell lines (e.g. SLC6A13, DIP2C, KDM5A, and CBWD1).

Conclusions: Our initial results demonstrate proof of principle that hypoxia-regulated gene expression in high risk STS is likely associated with changes in DNA methylation. This approach offers a method for identifying potential mechanisms by tumor hypoxia contributes to treatment failure. We are currently seeking to replicate this analysis ex vivo tumor samples.

(P003) Biological Effects of Pre-treatment Low Dose Radiation on Peri-tumoral and Tumoral Tissues Involved with Squamous Cell Skin Cancer

James Welsh, MS, MD¹, Jaime Barumen, MD², Richard Blankenbecler, PhD³, Colin Donahoe³, Linda Ritchie³, Valeria Barrón-Palma, PhD⁴, Eligia Juárez-Torres, PhD⁴, Frank Melendez, MD⁵, Bhanu Venkatesulu, MD⁶; ¹Hines VA, ²General Hospital of Mexico, ³BioGenome Therapeutics, ⁴Hospital General de México, ⁵Universidad Nacional Autónoma de México, ⁶Loyola University/Hines VA

Background: Low dose radiation (LDR) may have paradoxically beneficial effects via an adaptive response. This adaptive response can mitigate against the potential adverse effects of high-dose radiation therapy and chemotherapy. In a human clinical trial of radiation therapy for skin cancer plus pre-treatment low dose irradiation, we aimed to identify molecular characteristics of the adaptive response in terms of microRNA expression profiles.

Objectives: A human clinical trial (n=8) was conducted to determine the biological effects of integrating low dose radiation (LDR, 0.1 Gy) into standard radiotherapy (2 Gy fractions) over the first two weeks of radiation treatment for epidermoid skin cancers with the specific aim of determining adaptive responses. In this study we aimed to: 1. identify the molecular details (in miRNAs) behind the adaptive response and 2. To integrate the LDR adaptive response into clinical practice.

Methods: RNA was obtained from skin biopsies and processed for genetic expression using Affymetrix Human gene chips Clarion-D (138K genes). The aim was to determine how low dose radiation modifies genetic expression in both healthy and tumor tissue. To determine this, a human clinical trial (n=8) was conducted to ascertain the biological effects of integrating 0.1 Gy of LDR into standard radiotherapy (2 Gy fractions) over the first two weeks of radiotherapy for squamous cell skin cancers. Biopsy samples were collected and total RNA preparation (100 ng), labeled cRNA synthesis, hybridization, scanning, and image analysis were performed. Changes in biological response were measured using Affymetrix microarrays. Pathway analysis was performed using the Affymetrix Transcriptome Analysis Console software and the Wikipaths database.

Results: The differences in gene expression in healthy tissue due to LDR exposure were low (325 genes, mostly downregulated). The 20 most important biological processes that were affected include Senescence and Autophagy in Cancer, and Genotoxicity Pathway (both downregulated). The differences in gene expression in malignant tissue following LDR exposure were significantly more pronounced (5,651 genes, mostly upregulated). The 20 most important biological processes affected are shown in Figures 5 and 6 and Tables 4-6, and include Allograft rejection pathway in skin cancer (upregulated).

Conclusions: Low doses of radiation (0.1 Gy) have a narrow effect on gene expression when administered to healthy peritumoral tissues. Downregulated genes predominate, and DNA repair mechanisms are stimulated by the first low dose to this healthy tissue. In contrast, a pronounced effect on gene expression was induced by LDR delivered to malignant tissue. Upregulated genes predominate and are linked to anti-tumor immune response, especially Allograft rejection. This antitumor immune rejection response is more noticeable after the first low-dose session than after the second week, possibly due to immune cell depletion induced by the intervening high dose fractions. Also, after the second

administration of LDR, inflammatory and oxidative stress processes and tumor growth predominate, the latter perhaps as a tumor reaction to overcome radiotherapy-induced damage via accelerated re-population.

(P004) Pattern and Timing of Recurrence in Node-positive Breast Cancer Patients After Trimodality Therapy: Opportunity for Improved Oligometastases Detection and Salvage Local Therapy

Rojine Ariani, MS¹, Lindsay Hwang, MD², Jason Ye, MD¹; ¹Keck School of Medicine of USC, ²University of Southern California

Background: Patients with node-positive breast cancer (BC) experience high rates of metastatic recurrence in distant sites even after completion of trimodality therapy with surgery, systemic therapy and radiation (RT). There is growing evidence that early detection and treatment of oligometastatic disease (≤ 5 lesions) with aggressive local therapies such as stereotactic body radiotherapy (SBRT) may improve survival, but national guidelines have yet to offer any recommendation for routine screening imaging for distant metastatic disease in breast cancer patients without clinical signs or symptoms.

Objectives: A single-institution retrospective review of high-risk BC patients treated with curative-intent trimodality therapy was performed to describe rates, patterns, and extent of recurrence as well as imaging modalities used in initial detection, to identify effective surveillance imaging strategies for prompt detection of asymptomatic oligometastases that may benefit from SBRT before progression to diffuse metastatic disease.

Methods: Ninety-four node-positive BC patients treated at a safety-net hospital between 2008-2019 were identified through the institution cancer registry, of which 21 developed recurrence as reported in the institution electronic medical records. These patients were divided into subgroups of oligometastatic disease (10 patients) or diffusely metastatic disease (11 patients).

Results: The median recurrence-free survival (RFS) following RT in the oligometastatic and diffusely metastatic subgroups was 18 months and 36 months, respectively. Adjuvant chemotherapy was significantly associated with improved RFS and high-grade disease trended towards an association with improved RFS on univariable analysis, but only adjuvant chemotherapy maintained significance on multivariable analysis. Following RT, the median overall survival (OS) for the oligometastatic subgroup was not reached. The median OS for the diffusely metastatic cohort was 57 months. Four oligometastatic patients progressed to diffusely metastatic disease in a median of 17 months, with a median survival of 57 months following progression. All patients who recurred had distant metastatic disease on initial detection, most commonly in bone (14 patients). Recurrences were most frequently first detected by CT body imaging (11 patients).



Conclusions: Recurrent disease, limited or diffuse, was detected in 22% of node-positive breast cancer patients within a median time of ≤ 36 months following RT. Patients with limited oligometastatic disease had overall improved survival compared with those with diffusely metastatic disease. All recurrences involved distant sites and were most commonly detected by CT imaging. This study highlights the need for improved surveillance imaging strategies in high-risk node-positive breast cancer patients to allow for the timely detection of asymptomatic oligometastatic disease while still amenable to aggressive local salvage therapy before diffuse progression.

(P006) Proton Therapy for the Treatment of Men with Breast Cancer

Julie Bradley, MD¹, Jayden Curry, BS², Raymond Mailhot Vega, MD, MPH², Xiaoying Liang, PhD², Nancy Mendenhall, MD²; ¹University of Florida Department of Radiation Oncology, ²University of Florida

Background: While breast cancer treatment for men involves multimodality therapy including radiotherapy (RT), few men have received proton therapy (PT) for breast cancer. One case report exists in the literature (1), yet an NCCDB review of male breast cancer found 13/4070 men were treated with PT between 2004 and 2014 (2). Men have a higher baseline risk of cardiac toxicity and there is an established correlation between heart dose and cardiac toxicity, supporting the use of PT in men.

TABLE 1. Radiation Characteristics

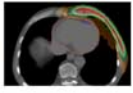
	Patient A	Patient B	Patient C
Proton delivery	PS	PBS	PBS
Dose GyRBE/# fractions	50/25	50/25	42.4/16
Boost	none	none	electron scar boost
Boost Dose Gy/fraction	—	—	7.95/3
Ipsilateral chest wall D95	96%	97%	92%
Regional lymph nodes D95	97%	95%	98%
Mean heart dose; V5	0 Gy; 0%	1 Gy; 4.5%	0.17 Gy; 0.9%
Lung dose	V5 15%, V20 10%	V5 46%, V20 20%	V4 55%, V16 31%
Dose distribution			

Key: PS, passive scatter; PBS, pencil beam scanning

Objectives: To provide a descriptive analysis of PT in men with breast cancer.

Methods: Men who received PT for localized breast cancer between 2012 and 2020 were identified from a prospective database. Toxicities were prospectively recorded using CTCAE v4.0.

Results: Three patients were identified: 1 Black and 2 white. All had ER+ PR+ Her2neu- disease and received adjuvant endocrine therapy. None had positive genetic testing. All patients received PT to the left chest wall and comprehensive regional lymphatics. Acute toxicity consisted of 1 patient with grade 2 dermatitis and fatigue; no grade 3+ toxicity. Table 1 provides PT details. Patient A was 75 years old at diagnosis with diabetes, hypertension, prior myocardial infarction with cardiac stents, and atrial fibrillation with a pacemaker. After work-up for a palpable retroareolar mass, he underwent mastectomy and sentinel lymph node biopsy (SLNB), with grade 2 invasive ductal carcinoma (IDC), positive lymphovascular space invasion (LVSI), pT2 N1a(sn). At 3.8 years after PT, there was no evidence of disease, with the only toxicity of grade 1 telangiectasia. With comorbidities of DVT and hypertension, Patient B was 60 years old when diagnosed with bilateral retroareolar breast cancer. He underwent bilateral mastectomies and SLNB with left grade 1 IDC, pT2 N1mi(sn) and right pTis N0(sn). At 13 months of follow-up, he had no evidence of disease and no toxicity. Patient C was a healthy 80-year-old with clinical T2 N1 M0 disease. After 4 months of neoadjuvant tamoxifen, he underwent left modified radical mastectomy, with grade 2 IDC, LVSI positive, with a 0.1-cm posterior margin. He had 18/20 nodes positive, ypT1cN3a. Grade 2 lymphedema developed postoperatively, before PT. He received 6 cycles of adjuvant paclitaxel and cyclophosphamide. Anastrozole was started after completion of PT. Two months later, a subcarinal node that was mildly enlarged at diagnosis but biopsy-negative increased in size and FDG avidity. Systemic therapy changed to palbociclib and letrozole. He remained under radiographic surveillance with no in-field recurrence or other distant disease progression 6 months after PT.

Conclusions: In a small case series for a rare diagnosis, PT to the chest wall and regional lymphatics including internal mammary nodes resulted in low cardiac exposure, high local-regional disease control, and minimal toxicity. PT should be considered for treatment of men with breast cancer to achieve cardiac sparing.

References:

- Giap BQ, Giap F, Einck JP, et al. A case study: proton therapy for male breast cancer with previous irradiation. *Int J Part Ther*. 2016; 2:579–583.
- Yadav S, Karam D, Bin Riaz I, et al. Male breast cancer in the United States: treatment patterns and prognostic factors in the 21st century. *Cancer*. 2020;126:26–36.

(P007) Radiation Treatment for Breast Cancer in Women 40 Years Old and Younger: Demographics, Outcomes, and Toxicity

Julie Bradley, MD¹, Jayden Curry, BS², Christopher Morris, MS², Nancy Mendenhall, MD²; ¹University of Florida Department of Radiation Oncology, ²University of Florida

Background: Women diagnosed with breast cancer at a young age face unique challenges, including early menopause, reproductive and sexual health issues, and altered physical appearance and functional status (1). In addition, young age is a known adverse prognostic factor for breast cancer (2).

Objectives: This analysis evaluates a cohort of women age ≤ 40 treated with radiotherapy (RT) for breast cancer at a single institution.

Methods: From a prospective database, patients with breast cancer treated at the University of Florida with radiotherapy between October 2010 and July 2019 were identified. Disease control was assessed using the Kaplan-Meier product limit method. The log-rank test assessed statistical significance between strata of prognostic factors. Toxicity was recorded using CTCAE v4.0.

Results: Thirty-seven women were identified, 65% with left-sided breast cancer, and 2 diagnosed during pregnancy. Two patients were treated for a local-regional recurrence, having failed after initial management without RT. Median age was 36 years (range, 23–40). Median follow-up was 3.8 years (range, 1.2–10.1). Thirty percent of patients were Black and 54% white. Cardiac risk factors included 49% with hypertension and 8% with diabetes. Median BMI was 30.3 (range, 15.4–52.3). Genetic testing was positive for a pathological mutation in 8% and for a variance of unknown significance in 19%. Most patients had stage I or II disease (76%). One patient had oligometastatic stage IV disease treated with curative intent. Moreover, 78% had invasive, 59% high-grade, and 22% triple-negative disease. Over half of the patients had breast-conserving surgery (54%). Of those with mastectomy, 56% had reconstruction. Furthermore, 59% received chemotherapy and 65% endocrine therapy; 41% underwent neoadjuvant systemic therapy. Median radiation dose 55.4 Gy (range, 50–70). The 3-year local-regional control, progression-free survival, and overall survival were 88%, 86%, and 94% respectively. On UVA, no variables were associated with local-regional control. Progression-free survival was higher for patients with N0 vs N+ disease (91% vs 73%, $P=0.04$). Inferior overall survival was associated with the presence of lymphovascular invasion and triple-negative disease ($P=0.04$ and $P=0.03$). There was a trend for worse progression-free and overall survival for black women ($P=0.07$ and 0.08). Grade 1 lymphedema was the most common toxicity (35%). Four patients developed pulmonary embolism after RT, 2 had progressive heart failure, and 1 developed fat necrosis requiring surgery. Three patients had pregnancies after treatment for breast cancer, 1 of which resulted in an incomplete abortion complicated by hypovolemic shock.

Conclusions: Despite the young age of women in this cohort, overall disease control was high. However, early recurrences developed in a subset of patients and were associated with node-positive disease, lymphovascular invasion, and a trend towards Black race. The rate of pulmonary embolism was higher than expected and further examination of toxicity will provide a better understanding of potential exacerbating factors and preventative measures.

References:

- Black KZ, Eng E, Schaal JC, et al. The other side of through: young breast cancer survivors' spectrum of sexual and reproductive health needs. *Q Health Res.* 2020;30:2019–2032.
- Love RR, Duc NB, Dinh NV, et al. Young age as an adverse prognostic factor in premenopausal women with operable breast cancer. *Clin Breast Cancer.* 2002;2:294–298.

(P008) Clinical and Toxicity Outcomes in Re-Irradiation for Recurrent Breast Cancer

Kelsey Corrigan, MD, MPH¹, Samantha Buszek, MD¹, Karen Hoffman, MD, MPH¹, Simona Shaitelman, MD, MED², George Perkins, MD, MBA³, Benjamin Smith, MD⁴, Eric Strom, MD¹, Welela Tereffe, MD¹, Wendy Woodward, MD PhD⁴, Michael Stauder, MD¹; ¹MD Anderson Cancer Center, ²Department of Radiation Oncology, The University of Texas MD Anderson Cancer Center, ³smoulder@mdanderson.org, ⁴University of Texas MD Anderson Cancer Center

Background: Locoregional recurrence (LRR) of breast cancer in patients with prior radiotherapy (RT) to the breast or chest wall is a therapeutic dilemma. Typically, patients receive systemic therapy

and surgery for treatment of their recurrence, but the role of re-irradiation (re-RT) is debated. Up to half of patients who receive re-RT experience acute toxicities, with many also having significant long-term toxicities. Limited data exists examining the clinical and toxicity outcomes in breast cancer patients with LRR who require re-RT.

Objectives: We investigated the clinical efficacy and toxicity outcomes of women with breast cancer requiring re-irradiation for LRR.

Methods: We identified breast cancer patients with LRR who were treated with re-RT between 2014 and 2020 at our institution. Demographic and clinical variables were extracted from the medical record. Toxicity and treatment-related factors were compared between patients using χ^2 testing. Overall survival (OS) was evaluated using the Kaplan-Meier method.

Results: 54 breast cancer patients with LRR were analyzed. Median [interquartile range (IQR)] age was 58 [49–65] years. A majority were ER-positive (63%), Her2-negative (85%), and high grade (57%). The most common site of recurrence was the breast (48%), followed by: chest wall (37%), soft tissue/bone (7%), skin (6%), regional lymph nodes (LN) (4%). 43 (80%) patients had resection of their recurrence. 50 (93%) patients received 2D (electron)/3D RT and 4 (7%) patients received advanced radiation techniques ([ARTTs]: IMRT, VMAT). The median [IQR] total re-RT dose and fractionation was 60 [50–62] Gy and 2 [1.9–2] Gy/fraction. 36 (67%) patients received a radiation boost. 20 (37%) patients experienced acute grade 2+ toxicities. The most common acute toxicity was dermatitis (37 patients, 69%). Other toxicities included hyperpigmentation (26 patients, 48%) and breast pain (15 patients, 28%). Patients receiving a total re-RT dose ≥ 50 Gy were more likely to experience any toxicity (81% vs. 36%, $P<0.01$). Presence of any acute toxicity was not associated with use of 2D/3D RT versus ARTTs (72% vs. 75%, $P=0.89$). Patients with LN recurrence had worse 5-year OS (50%) compared with the other sites of recurrence (chest wall, 78%; breast, 94%; skin, 100%; soft tissue/bone, 100%). There was no difference in median OS in patients receiving surgery (74 vs. 79 mo, $P=0.34$), radiation boost (79 vs. 76 mo, $P=0.27$), or ARTTs (89 vs. 79 mo, $P=0.90$) for treatment of their recurrence.

Conclusions: Re-RT is efficacious for control of LRR in breast cancer, however more data are needed to determine the safety of using higher total re-RT doses. Toxicity outcomes were similar between patients receiving 2D/3D RT and ARTTs. Additional follow-up and analysis are necessary to evaluate long-term survival outcomes and toxicities in these patients.

(P009) Magnetic Resonance Guided Accelerated Partial Breast Irradiation - Single Institution Experience Using ViewRay Technology

Jadranka Dragovic, MD¹, Kate Aldridge, RTT, CMD², Anthony Doemer³; ¹Henry Ford Health System, ²Henry Ford Hospital, ³Henry Ford Cancer Institute

Background: In the recent years PBI has emerged as an alternative to WBI. This results in less normal tissue irradiated, less morbidity and late complications, greater patient convenience. The comparative efficacy and toxicity profiles of PBI compared with WBI have shown similar ipsilateral breast tumor recurrence rates and reduced acute toxicities. With the advent of dedicated magnetic resonance-guided radiation therapy systems such as the MR-Linac there is potential for further improvement in the delivery of PBI and increased safety. We present our experience of MR-guided PBI in early-stage breast cancer (08/2017 -01/2021) and compare to patients treated with brachytherapy (1/2010 - 8/2015).

Objectives: 1) Assess the efficacy and toxicity of adjuvant PBI using MR-GRT in early-stage breast cancer. 2) Compare to outcomes of HDR brachytherapy patients 3) Determine situations where online adaptive RT may be beneficial.

Methods: Fifty patients treated with PBI (MR-GRT) and 29 treated with HDR brachytherapy (Contoura) were evaluated. Criteria for PBI included: unifocal tumors.

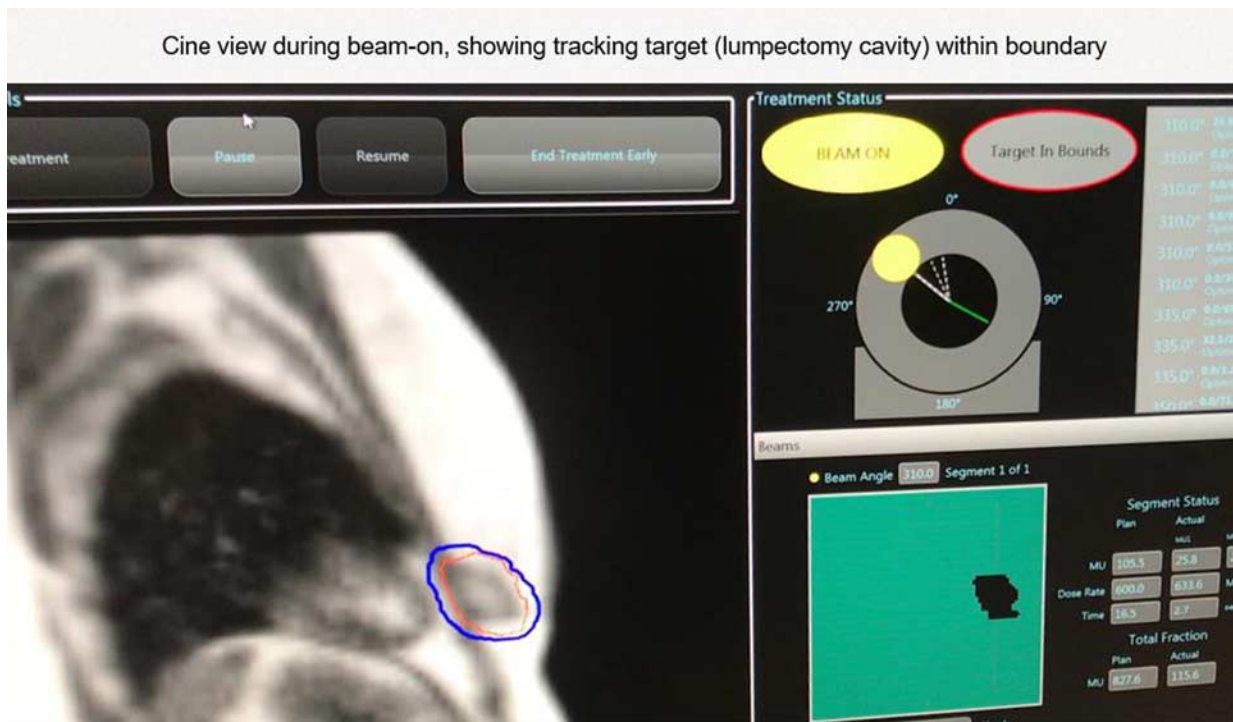

Results: Acute reactions were minimal with skin reactions mild to none and limited to the lumpectomy site (RTOG score 0-1). Late effects were localized mild skin hyper-pigmentation. One patient had a rib fracture. There are no recurrences to date, with a median follow up of 12 months. None of the patients qualified for online adaptive planning, but end-inhale breath hold was utilized for left-sided tumors for cardiac sparing. In the brachytherapy group one had a local recurrence (at 3 y) and 12/29 had significant persistent seroma/thickening/retraction at the treated site.

Conclusions: PBI using MR-guided radiation therapy is a feasible, well tolerated regimen for early-stage breast cancer with a favorable acute and late toxicity profile and excellent cosmetic result. The follow-up is presently too short for recurrence evaluation, but so far no relapses were seen at a median follow up of 12 months. When compared with brachytherapy the acute and late morbidity are significantly lower and the cosmetic result superior.

(P010) Predictors of Radiation Dermatitis and Esophagitis in Early Stage Breast Cancer Patients Receiving Adjuvant Whole Breast Radiation Therapy

Stephen Dzul, MD PhD¹, Seongho Kim, PhD², Hyejeong Jang, BS², Michael Dominello, DO¹, James Ninia, MS¹; ¹Wayne State University, ²Karmanos Cancer Institute

Background: Breast conserving surgery followed by adjuvant whole breast radiation therapy is standard of care in the management of early stage breast cancer. Radiation dermatitis is one of the most common toxicities associated with whole breast radiation therapy and is frequently treated with topical ointments and NSAIDS.

Objectives: This study investigates clinical factors associated with increased incidence of Grade 2+ radiation dermatitis in patients undergoing adjuvant whole breast radiation.

Methods: An institutional database was developed to include all patients with a history of breast cancer or DCIS undergoing adjuvant whole breast radiotherapy at a single institution from 2013-2019.

Records were reviewed to identify patient’s age, BMI, radiation dose and fractionation, prone vs supine position, inclusion of boost, and inclusion of regional nodal irradiation. Radiation treatment plans were reviewed to identify breast size, and volume of breast receiving > 105% and > 107% prescription dose (V105%, V107%). Medical records were reviewed to identify which patients experienced at least patchy moist desquamation (silvadene prescription was used a surrogate for this toxicity) during or immediately following their course of radiotherapy. Univariable and multivariable logistic regression analyses were performed to identify correlations between patient factors associated with incidence of dermatitis and esophagitis.

Results: 370 patients were included in the final analysis. 43% of patients were obese and 15% were morbidly obese. 42% of patients received hypofractionated radiation treatment. 35% of patients were treated with an additional supraclavicular field (SCF) to include regional lymph nodes. 22% of patients were treated in prone position. Grade 2+ dermatitis was diagnosed in 39% of patients. On univariable analysis, obese and morbidly obese patients were more likely to develop dermatitis (Obese: OR 1.65, *P* = .032, Morbidly Obese: OR 4.28, *P* < 0.001). On multivariable analysis, larger breast volume (OR

TABLE 1. Logistic Regression Analyses of Patient Features Associating With Incidence of Dermatitis

		Univariable		Multivariable		
		Event/N	OR (95% CI)	P value	OR (95% CI)	P value
BMI	<30	46/156	Ref.		Ref.	
	[30,40)	68/166	1.65 (1.04-2.63)	0.032	0.74 (0.42-1.30)	0.303
	≥40	31/48	4.28 (2.20-8.57)	<0.001	0.81 (0.33-1.98)	0.647
Fractionation	Conv.	104/216	Ref.		Ref.	
	Hypofrac.	41/154	0.39 (0.25-0.61)	<0.001	0.50 (0.27-0.92)	0.027
Position	Supine	119/288	Ref.		Ref.	
	Prone	26/82	0.67 (0.39-1.11)	0.118	0.42 (0.21-0.84)	0.013
Supraclav Field	No	82/239	Ref.		Ref.	
	Yes	63/131	1.77 (1.15-2.73)	0.01	0.94 (0.49-1.83)	0.866
Breast Volume	V105%	145/370	2.32 (1.82-3.02)	<0.001	2.75 (1.96-3.96)	<0.001
	V107%	145/370	1.41 (1.10-1.95)	0.004	1.19 (0.86-1.75)	0.329

2.75, $P < .001$) was associated with increased incidence of dermatitis while prone position (OR 0.42, $P = .013$) and hypofractionated radiotherapy was associated with decreased incidence of dermatitis (OR 0.50, $P = .027$). V107% and presence of a SCF had a positive correlation and age had a negative correlation with dermatitis on univariable analysis but these correlations were not present on multivariable analysis. Addition of a boost to the lumpectomy cavity did not affect the rate of dermatitis.

Conclusions: Radiation dermatitis is a common toxicity observed in patients undergoing adjuvant breast radiation therapy. Large breast volume was associated with a higher rate of dermatitis while prone position and hypofractionated radiation reduced rates of dermatitis. Addition of lumpectomy cavity boost did not increase the incidence of dermatitis. Hypofractionated, prone radiotherapy with or without boost likely decreases the risk of grade 2+ dermatitis, particularly for women with large breast volumes (Table 1).

(P011) Impact of Surgery Type and Radiation Fractionation on Outcomes in Node-Negative Metaplastic Breast Cancer

Yufei Liu, MD PhD¹, Puneet Singh, MD¹, Stacy Moulder, MD¹, Wendy Woodward, MD PhD¹, Simona Shaitelman, MD, MEd², George Perkins, MD, MBA³, Anthony Lucci, MD¹, Lavinia Middleton, MD¹, Benjamin Smith, MD¹, Melissa Mitchell, MD PhD¹; ¹University of Texas MD Anderson Cancer Center, ²Department of Radiation Oncology, The University of Texas MD Anderson Cancer Center, ³smoulder@mdanderson.org

Background: Metaplastic breast cancer is a rare aggressive subtype with poor outcomes and early recurrences. As practice patterns shift toward hypofractionation in early stage breast cancer patients worldwide, we sought to assess local therapy use in node negative metaplastic breast cancer in a single institution and associated oncologic outcomes.

Objectives: 1. Assess the clinical outcomes of patients with metaplastic breast treated with surgery with or without adjuvant radiation at our institution. 2. Assess whether metaplastic breast cancer can be effectively treated with hypofractionation.

Methods: After IRB approval, we retrospectively reviewed the charts of metaplastic patients treated between January 2014 and January 2020 at our institution, a timeframe with increased utilization of hypofractionation. Patients with non-inflammatory, non-metastatic breast cancer with known radiation status were included in the analysis. All patients were node negative clinically and pathologically. Data were collected on chemotherapy use, radiation use, surgery type, tumor subtype, tumor stage, recurrences and deaths. Kaplan-Meier estimates of 2 year recurrence and survival were performed in SPSS 24.

Results: A total of 50 metaplastic patients were identified who met the inclusion criteria, with a median follow-up time of 26 months from diagnosis. Median age was 58, range 24-84. Seventy-two percent of patients were White. Seventy-six percent of tumors were triple negative, 18% hormone positive, and 6% Her2 positive. Most patients received chemotherapy, 82%, with 51% of these receiving it neoadjuvantly. Table 1 shows actuarial 2 year local recurrence, any recurrence and

overall survival by local therapy subtype. To date, all local recurrences captured had developed within 20 months of diagnosis; median time to local recurrence was 11 months. The minimum follow-up was 16 months in patients treated with lumpectomy and hypofractionation. Clinical stage was T1 20%, T2 62%, T3 12% and T4b 6%. All T4b patients received mastectomy and radiation. Patients selected for mastectomy alone were more likely to be early stage cT1/2 (100%), compared with patients receiving mastectomy and radiation cT1/2 (45%). Staging for lumpectomy patients receiving hypofractionation were cT1 33%, cT2 67%, as compared with lumpectomy with conventional fractionation cT1 18%, cT2 76%, cT3 6%. All hypofractionation patients were hormone negative, one was Her2 positive.

Conclusions: While limited by low numbers, this analysis suggests that hypofractionation should be further studied in early stage metaplastic breast cancer. Continued review of outcomes with larger patient numbers is needed. Patients with higher stage disease have poorer outcome, despite aggressive local therapy with mastectomy and radiation.

(P012) Prospective Pilot Study of Radiation Dermatitis Among Patients with Breast Cancer Evaluated Using Deep Machine Learning

Sung Jun Ma, MD¹, Shawn Matott, PhD¹, Robert DeLeon, PhD¹, Simon Fung-Kee-Fung, MD¹, Saif Aljabab, MD¹; ¹Roswell Park Comprehensive Cancer Center

Background: Patients and clinical studies often rely on experienced radiation oncologists to evaluate the severity of radiation dermatitis (RD). However, available grading tools are heterogeneous and subjective. In recent years, deep machine learning (DML) algorithms have emerged in diagnosing various skin disorders.

Objectives: In this prospective feasibility pilot study, we explore the ability of DML to detect RD in breast patients and correctly describe the skin findings and grading using the Common Terminology Criteria for Adverse Events (CTCAE v5.0).

Methods: Our institutional review board approved this study. Videos of bilateral breasts were obtained weekly during radiation and up to one-month post-treatment. Video recordings were split into frames and binned by a radiation oncologist. Two separate convolutional neural network models were developed. One model classified frames by skin findings and the other by CTCAE grade 0 to 4. Skin findings included: normal skin, irradiated healing skin, faint erythema/hyperpigmentation, brisk erythema/hyperpigmentation, dry desquamation, moist desquamation, moist desquamation with bleeding, skin ulceration, and skin necrosis. Images were divided into 80% training set and 20% validation set.

Results: A total of 12 women were enrolled (8 White and 4 African American) between June 2020 and October 2020. A total of 4,530 images were collected and binned into normal skin (n = 2,624), irradiated healing skin (n = 317), faint erythema/hyperpigmentation (n = 867) and brisk erythema/hyperpigmentation (n = 577). Desquamation classes were aggregated (n = 145) due to their small sample size for this initial analysis. No skin ulceration or necrosis was observed. For our first model to classify skin findings, overall accuracy for the model was 84%. The model distinguished normal skin from any grade of radiation dermatitis or post-radiation skin with an accuracy of 95%. However, given small sample sizes of images with radiation dermatitis, the model's accuracy ranged from 57% to 74% for differentiating among recently irradiated skin, faint or brisk erythema or hyperpigmentation, and desquamation. For our second model to grade using CTCAE v5.0, images were binned into grade 0 (n = 1,844), grade 1 (n = 801), and grade 2 (n = 301). Grade 3 images were excluded for analysis given its limited sample size. No grade 4 or 5 toxicities were observed. Overall accuracy was 82%. The model identified grade 0, 1, and 2 correctly with the accuracy of 87%, 74%, and 74%, respectively. The model was more accurate on White patients with an overall accuracy of 85%, compared with that of 75% on African American patients.

Conclusions: Our prospective pilot study demonstrates that using both of our DML models to identify radiation dermatitis is feasible. We are now planning to accelerate data collection to increase all classes' sample sizes to further internally and externally validate our model.

TABLE 1. Outcomes of Metaplastic Breast Cancer Patients Treated With Lumpectomy or Mastectomy With or Without Radiation

	Number patients	2 yr local recurrence (%) Log-rank p=0.204	2 yr any recurrence (%) Log rank p=0.485	2 yr survival (%) Log-rank p=0.13
Mastectomy with radiation	11	18	49	67
Mastectomy alone	12	11	27	90
Lumpectomy with conventional RT	17	23	35	93
Lumpectomy with hypofractionation	6	0	20	100
Lumpectomy alone	4	50	50	50

(P013) Five Day Accelerated Partial Breast Irradiation (APBI) Using Stereotactic Body Radiation Therapy (SBRT) in Stage 0-II Breast Cancer: A Report of 186 Patients with up to 3 Year Follow-up

Rufus Mark, MD¹, Valerie Gorman, MD¹, Steven McCullough, PhD¹; ¹Baylor Scott & White Medical Center

Background: Randomized trials in selected early stage breast cancer patients with up to 10 year follow-up have proven that Accelerated Partial Breast Irradiation (APBI) given via High Dose Rate (HDR) implant bid in 5 days is equivalent to whole breast External Radiation Therapy (XRT) given qd in 5-6 weeks in regard to breast tumor local recurrence (LR) [1-2]. However, complications with APBI implant in a Medicare database review have been significant, with 3.95% of women requiring Mastectomy, 16.2% developing infections, and another 16.3% experiencing non-infection complications including rib fractures, fat necrosis, and breast pain [3]. Recently APBI using non-invasive Intensity Modulated Radiation Therapy (IMRT) or Stereotactic Body Radiation Therapy (SBRT) given qd in 5 fractions has been shown in another randomized trial with 10 year follow-up to be equivalent to qd XRT in 6 weeks, with respect to LR [4]. IMRT/SBRT was superior in regard to acute effects, late effects, and cosmesis.

Objectives: In the randomized clinical trial of APBI IMRT/SBRT, the Clinical Target Volume (CTV) was defined by the injection of individual fiducial markers bordering the surgical cavity. At our institution, we have used the Biozorb fiducial system to localize the CTV for SBRT. We sought to confirm the APBI SBRT/IMRT results with a simpler fiducial system.

Methods: Between 2017 and 2020, 186 patients have undergone SBRT targeted to a Biozorb defined CTV with the walls of the surgical cavity sewn to the Biozorb device. Eligible patients were older than age 40, had tumor sizes < 3 cm, negative surgical margins, and negative sentinel node dissections. SBRT dose was 30 Gy given in 5 fractions. Dose Constraints were as follows: V-30 Gy < 105%, Ipsilateral Breast V-15 Gy < 50%, Ipsilateral Lung V-10 Gy < 20%, Contralateral Lung V-5 Gy < 10%, Heart V-3 Gy < 20%, Contralateral Breast Dmax < 2 Gy and Skin Dmax < 27 Gy. The Planning Target Volume (PTV) ranged from 27 to 355 cc with a median of 80 cc. PTV = CTV + 1-2 cm.

Results: Follow-up ranged from 1-36 months with a median of 18 months. LR has been 0% (0/186). There have been no biozorb related infections, reactions, or rejections. There have been no cases of radiation induced seromas, skin reactions, or soft tissue necrosis. Four patients, 2.2% (4/186) developed pain around the Biozorb site. Three cases were resolved within 2 days on a 2 week course of steroids. One patient required 3 courses, with the last being 1 month. Cosmetic results as rated by the Surgeon, Radiation Oncologist, and Nurse, were rated excellent in 98.9% (184/186) of cases.

Conclusions: Non-invasive APBI with SBRT given qd over 5 days targeted to Biozorb has resulted in LR, complications, and cosmetic results which compare favorably to invasive APBI given bid with HDR implant. At last follow-up, there have been no LR, skin reactions, or complications. Cosmesis has been excellent in 98.9% of patients.

(P014) Predictors of Metastatic Breast Cancer Presentation in a Vulnerable Patient Population

Mary McGunigal, MD¹, Rhea Bhatt, BS², Nima Aghdam, MD³; ¹Georgetown University Hospital, ²Georgetown University, ³Beth Israel Deaconess Medical Center

Background: Socially disadvantaged populations in the United States experience worse outcomes compared with the general population when diagnosed with breast cancer. One potentially vulnerable population includes patients under age 65 that qualify for Medicare due to debilitation. This group includes patients who have received social security disability insurance for at least 2 years and those who have been diagnosed with end-stage renal disease or amyotrophic lateral sclerosis; current literature suggests this population experiences worse oncologic outcomes.

Objectives: Our study goal was to utilize the National Cancer Database (NCDB) and perform analyses to determine what factors among patients under the age of 65 who qualify for Medicare predict for a higher likelihood of presenting with stage IV breast cancer.

Methods: The NCDB was queried for breast cancer patients diagnosed from 2004-2014 who were below the age of 65 and qualified for Medicare. Patients were excluded if they presented with noninvasive disease or if their AJCC stage was unknown. Patients were excluded if any social determinants (race, income quartiles, Charlson-Deyo comorbidity score, travel distance) or hospital factors (facility type, facility location) were unknown. Pearson χ^2 test was used to identify associations between categorical variables and stage. Univariate analysis of sociodemographic factors was performed. Statistically significant factors were included in a multinomial logistic regression model to determine independent covariates associated with stage IV presentation.

Results: 56,964 patients met study criteria. Based on *P* values (*P* < 0.05) and strength of odds ratios, the following variables were included in the final model: race, income, comorbidity score, travel distance, facility type, and facility location. All covariates except facility location and distance were significant predictors of metastatic disease presentation. Race was a significant predictor, with white patients less likely to have stage IV presentation (OR 0.73, *P* < 0.001) compared with black patients. Individuals earning < \$38,000 annually were significantly more likely to present at stage IV (OR 1.15, *P* < 0.001). Patients who traveled shorter distances to treatment facility had non-significantly higher odds of presenting at stage IV (OR 1.37, *P* = 0.608). Higher comorbidity score was a significant predictor of Stage IV disease at presentation.

Conclusions: Multiple sociodemographic factors were powerful predictors of a stage IV breast cancer presentation in this select population of patients under 65 years old who qualify for Medicare due to debilitation. A deeper understanding of these factors can help identify patients at high risk of a metastatic cancer presentation to provide screening and preventative services at an earlier stage in this vulnerable population.

(P015) Ductal Carcinoma in Situ (DCIS) of the Breast: Impact of Age, Grade, and Receptor Status on Survival

Mary Nittala, DrPH¹, Satyaseelan Packianathan, MD, PhD², Gary Shultz, DO³, Eswar Mundra, MD³, William Woods, MSN, NPC³, Maria Smith, MSN, NPC³, Barbara Craft, MD³, Srinivasan Vijayakumar, MD, MPH³; ¹The University of Mississippi Medical Center, ²University of Mississippi Medical Center, ³University of Mississippi Medical Center

Background: Ductal carcinoma in situ (DCIS) women who underwent surgery (lumpectomy/mastectomy) are at risk for recurrence within the breast; adjuvant radiotherapy (RT) often reduces the risk for recurrence. We decided to investigate the factors that improves the overall survival (OS) and loco-regional control (LRC) in DCIS women patients at an academic medical center to help tailor treatment decisions.

Objectives: The objective of this study was to evaluate LRC and OS rates of DCIS women patients treated with surgery ± RT and hormonal modulation.

Methods: This is a retrospective analysis of 44 DCIS patients treated between 2007 and 2017 at an academic state institution. All of them underwent lumpectomy and/or mastectomy (surgery) followed by adjuvant irradiation to a median total dose of 50 Gy (range 40.5–50.4 Gy). For all 44 DCIS patients, LRC and OS were estimated using the Kaplan-Meier method. The significance of survival variables were analyzed using the Cox univariate and multivariate proportional hazards model. A *P*-value of less than 0.05 was considered statistically significant. The SPSS 24.0 software was used for data analysis.

Results: The baseline characteristics of all 44 DCIS patients were documented over a median follow-up of 70 months (range 5–147 mo). Patients were stratified into three age groups (< 50 y (3) vs. 50- 70 y (31) vs. > 70 y (10); median age of 64 y; range 46–80 y). Overall, 34.1% of DCIS diagnoses were low grade, 29.5% intermediate grade, and 36.4% were high grade. Older women were more likely to develop low grade DCIS than the younger women. Following surgery, 50% of

TABLE 1. Baseline Characteristics of DCIS Patients

Table 1 - Baseline Characteristics of UMMC DCIS Patients (n= 44)					
	≤ 50 yrs (n= 3) 6.8%	50 - 70 yrs (n = 31) 70.5%	> 70 yrs (n=10) 22.7%	All Patients (n= 44) 100 %	p-Value
Ethnicity					
Caucasians	0 (0.0%)	9 (29.0%)	5 (50.0%)	14 (31.8%)	0.491
African Americans	3 (100.0%)	21 (67.7%)	5 (50.0%)	29 (65.9%)	
Others	0 (0.0%)	1 (3.2%)	0 (0.0%)	1 (2.3%)	
BMI					
Normal	0 (0.0%)	3 (9.7%)	1 (10.0%)	4 (9.1%)	0.155
Overweight	0 (0.0%)	7 (22.6%)	6 (60.0%)	13 (29.5%)	
Obese	1 (33.3%)	14 (45.2%)	2 (20.0%)	17 (38.6%)	
Morbidity	2 (66.7%)	7 (22.6%)	1 (10.0%)	10 (22.7%)	
DCIS Grade					
Low grade	1 (33.3%)	11 (35.5%)	3 (30.0%)	15 (34.1%)	0.998
Intermediate grade	1 (33.3%)	9 (29.0%)	3 (30.0%)	13 (29.5%)	
High grade	1 (33.3%)	11 (35.5%)	4 (40.0%)	16 (36.4%)	
ER status					
Positive	2 (66.7%)	27 (87.1%)	10 (100.0%)	39 (88.6%)	0.248
Negative	1 (33.3%)	4 (12.9%)	0 (0.0%)	5 (11.4%)	
PR status					
Positive	2 (66.7%)	25 (80.6%)	8 (80.0%)	35 (79.5%)	0.848
Negative	1 (33.3%)	6 (19.4%)	2 (20.0%)	9 (20.5%)	
HER2 status					
Positive	1 (33.3%)	1 (3.2%)	0 (0.0%)	2 (4.5%)	0.091
Negative	0 (0.0%)	8 (25.8%)	1 (10.0%)	9 (20.5%)	
Unknown	2 (66.7%)	22 (71.0%)	9 (90.0%)	33 (75.0%)	
Margins					
Positive	1 (33.3%)	10 (32.3%)	5 (50.0%)	16 (36.4%)	0.792
Negative	2 (66.7%)	16 (51.6%)	4 (40.0%)	22 (50.0%)	
Unknown	0 (0.0%)	5 (16.1%)	1 (10.0%)	6 (13.6%)	
Surgery					
Lumpectomy	2 (66.7%)	28 (90.3%)	10 (100.0%)	40 (90.9%)	0.207
Mastectomy	1 (33.3%)	3 (9.7%)	0 (0.0%)	4 (9.1%)	
SLN Biopsy					
Yes	1 (33.3%)	11 (35.5%)	1 (10.0%)	13 (29.5%)	0.304
No	2 (66.7%)	20 (64.5%)	9 (90.0%)	31 (70.5%)	
RT dose					
50 Gy/ 25 Fx	3 (100.0%)	25 (80.6%)	6 (60.0%)	34 (77.3%)	0.249
40.5 Gy/ 15 Fx	0 (0.0%)	6 (19.4%)	4 (40.0%)	10 (22.7%)	
LumpBoost					
Yes	1 (33.3%)	17 (54.8%)	2 (20.0%)	20 (45.5%)	0.143
No	2 (66.7%)	14 (45.2%)	8 (80.0%)	24 (54.5%)	
Boost dose					
10 Gy					
16 Gy					
Tamoxifen Usage					
Yes	3 (100.0%)	13 (41.9%)	2 (20.0%)	18 (40.9%)	0.046
No	0 (0.0%)	18 (58.1%)	8 (80.0%)	26 (59.1%)	
Locoregional Recurrence					
Yes	0 (0.0%)	2 (6.7%)	0 (0.0%)	2 (4.7%)	0.635
No	3 (100%)	28 (93.3%)	10 (100.0%)	41 (95.3%)	
Distant Metastasis					
Yes	0 (0.0%)	2 (6.7%)	0 (0.0%)	2 (4.7%)	0.635
No	3 (100%)	28 (93.3%)	10 (100.0%)	41 (95.3%)	

TABLE 2. Univariable & Multivariable Cox Regression for Overall Survival

	Univariable		Multivariable	
		p value		p value
Age				
≤ 50 years	1		1	
50-70 years	71.2 (5.05-1003)	0.002	6.56 (1.29-33.29)	0.023
≥ 70 years	0.46 (0.12-1.74)	0.256	0.58 (0.26-1.26)	0.170
Ethnicity				
Caucasians	1		1	
African Americans	0.00 (0.00-0.00)	0.001	0.01 (0.00-0.36)	0.011
Others	0.00 (0.00-0.00)	0.001	0.01 (0.00-0.36)	0.011
BMI				
Normal	1		-	-
Overweight	0.32 (0.04-2.29)	0.258	-	-
Obese	0.66 (0.18-2.45)	0.540	-	-
Morbidity	0.63 (0.17-2.30)	0.492	-	-
DCIS Grade				
Low grade	1		-	-
Intermediate grade	0.34 (0.07-1.72)	0.197	-	-
High grade	1.09 (0.20-5.73)	0.916	-	-
ER status				
Negative	1		1	
Positive	45.16 (1.71 - 11.92)	0.023	15.60 (2.13-114.04)	0.007
PR status				
Negative	1		-	-
Positive	1.78 (0.51-6.19)	0.363	-	-
HER2 status				
Positive	1		1	
Negative	0.94 (0.012-71.534)	0.978	0.83 (0.05-12.86)	0.897
Unknown	122.86 (5.13-2941.04)	0.003	7.78 (1.43-42.23)	0.017
Margins				
Positive	1		-	-
Negative	0.56 (0.12-2.45)	0.442	-	-
Unknown	1.08 (0.23-4.99)	0.918	-	-
Surgery				
Lumpectomy	1		1	
Mastectomy	88.21 (3.04-2554.73)	0.009	2.63 (0.35-19.36)	0.341
SLN Biopsy				
Yes	1		-	-
No	1.95 (0.22-16.93)	0.545	-	-
RT dose				
40.5 Gy/ 15 Fx	1		-	-
50 Gy/ 25 Fx	0.47 (0.15-1.49)	0.204	-	-
LumpBoost				
Yes	1		-	-
No	2.75 (0.46-16.34)	0.264	-	-
Boost dose				
10 Gy	1		-	-
16 Gy				
Tamoxifen Usage				
Yes	1		-	-
No	0.66 (0.15-2.76)	0.572	-	-

patients had negative tumor margins; ER was positive in 88.6% and PR positive in 79.5%. Ninety percent of patients had a lumpectomy and 40.9% used Tamoxifen. The five-year rates for LRC, and OS were 69 vs. 50% ($P=0.030$) and 33.7 vs. 70.8 vs. 60% ($P=0.041$), respectively. On Cox multivariate analysis, younger age [< 50 y] ($P=0.023$), African-American ethnicity ($P=0.011$), and ER positivity ($P=0.007$) were associated with a statistically improved significant OS. **Conclusions:** Outcomes in patients diagnosed with DCIS of the breast appears dependent upon age, ethnicity, and ER receptor status; this information may potentially help tailor treatment decisions in these patients (Tables 1, 2 and Fig. 1).

(P016) Dosimetric and Acute Toxicity Analysis with Hypofractionated Regional Nodal Irradiation for Breast Cancer

Adam Richman, MD¹, Michael Schad, BS¹, Emilia Diego, MD², Priscilla McAuliffe, MD, PhD², Ronald Johnson, MD², Jennifer Steiman, MD², Donald Keenan, MD, PhD², Joanna Lee, MD², John Vargo, MD³, Sushil Beriwal, MD, MBA, FABS, FASTRO¹; ¹Department of Radiation Oncology, UPMC Hillman Cancer Center, ²Department of Breast Surgical Oncology, UPMC Hillman Cancer Center, ³Department of Radiation Oncology, Hillman Cancer Center, University of Pittsburgh Medical Center

Background: Hypofractionated regional nodal irradiation (RNI) breast radiotherapy has been shown to be effective and safe in clinical trials. However, there is limited dosimetric analysis available with this regimen to see which factors predict for pneumonitis. The ongoing RT-CHARM study limits the percentage of ipsilateral of lung volume that receives ≥ 18 Gy (V18) to 35-40% [1].

Objectives: To evaluate the rates of acute pneumonitis in women treated with hypofractionated RNI at our institution and to identify dosimetric factors predictive for pneumonitis.

Methods: We performed a retrospective review of all breast cancer patients treated with hypofractionated RNI defined as the undissected axilla and supraclavicular region +/- intramammary nodes following either lumpectomy or mastectomy at our institution from 9/2018 to 8/2020. The primary endpoints were acute and chronic symptomatic pneumonitis. Secondary endpoints included acute and chronic skin toxicity. The Kaplan-Meier method was used to estimate event-time probabilities for the primary endpoints. Predictors of symptomatic pneumonitis were analyzed using log rank tests between groups. P -values <0.05 were considered significant.

Results: 126 patients qualified with a median follow up of 11.1 months (interquartile range [IQR] 8.17-18.23). Median age was 72 years (IQR 66-78) and 88.9% of patients had node-positive disease. Overall, 56.3% of patients received whole breast RT and 43.7% of patients received chest wall RT. 100 patients (79%) received 40.05 Gy in 15 fractions and 23 patients (18%) received 42.56 Gy in 16 fractions. Surgical bed boost was given to 92.1% of patients. The median ipsilateral lung maximum dose (Dmax) was 41.57 Gy (IQR 40.61-42.61) and mean dose (Dmean) was 9.78 Gy (IQR 8.39-11.48). Ipsilateral lung V5 was 40.73% (IQR 35.17-46.30), V10 was 27.40% (IQR 22.59-32.35), and V20 was 20.63% (IQR 16.72-25.74). Contralateral lung median Dmax and Dmean were 2.79 Gy (IQR 1.68-5.24) and 0.20 Gy (IQR 0.16-0.25), respectively. Mean heart Dmax was 13.71 Gy (standard deviation [SD] 0.93), mean Dmean was 4.23 Gy (SD 2.97), and median V20 was 0.00% (IQR 0.00-0.00). For acute radiation dermatitis, the rate of grade 2 toxicity was 30.4% for lumpectomy and 42.6% for mastectomy and the rate of grade 3 toxicity was 7.2% for lumpectomy and 1.9% for mastectomy. There was no grade 4+ acute radiation dermatitis. Acute grade 2 pneumonitis was seen in one patient (0.8%) and no patients developed acute grade 3+ or chronic grade 2+ pneumonitis. Of the patients that underwent a post-radiation therapy chest CT (n=38, 30.4%), 68.4% had radiographic evidence of grade 1 pneumonitis.

Conclusions: The overall incidence of acute symptomatic pneumonitis in patients treated with hypofractionated RNI is very low. V20 $< 26\%$ appears to be safe to limit symptomatic pneumonitis. No clinical or dosimetric factors were predictive for symptomatic pneumonitis.

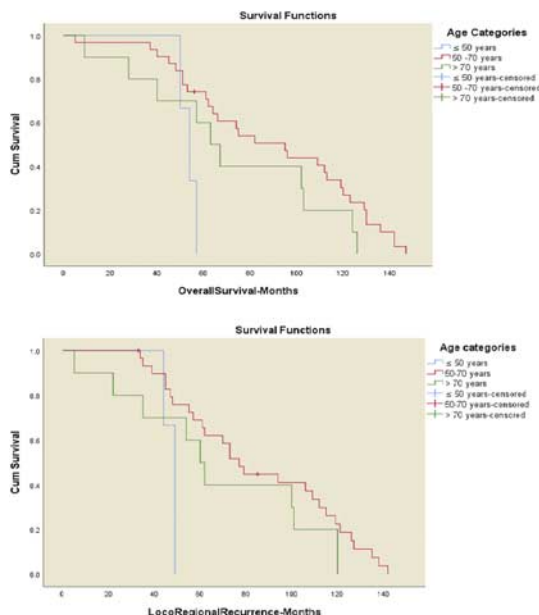

FIGURE 1. Overall survival and loco regional control of DCIS patients categorized by age group.

(P017) Comparison of Skin Toxicity and Outcomes for Three and Four Week Hypofractionated Whole Breast Irradiation Regimens

Juliana Runnels, MD¹, Juliana Runnels, MD¹, Alexander Rose, BS¹, Ben Liem, MD², David Lee, MD, PhD², Thomas Schroeder, MD²; ¹University of New Mexico School of Medicine, ²Section of Radiation Oncology, Division of Hematology-Oncology, Department of Internal Medicine, and University of New Mexico Comprehensive Cancer Center, University of New Mexico School of Medicine

Background: Multiple randomized trials have shown that whole breast radiation therapy delivered in fewer, larger fractions is safe and effective. This recent evidence supports hypofractionation, but the optimal dose-fractionation schedule remains controversial. At our institution, physicians use either a 4-week course (42.56 Gy/16Fx, 10 Gy/4Fx sequential boost) or a 3-week course (48 Gy/40 Gy/15Fx, concomitant boost). Half our physicians perceived an increase in acute skin toxicity with the 3-week regimen. The other half did not. Patients are referred to the next available physician, similar to a randomization. A retrospective review of these patients may provide a comparison with fewer selection biases inherent in retrospective studies.

Objectives: Acute skin toxicity is a common symptomatic side effects of breast irradiation. We sought to compare the incidence of acute skin toxicity in patients treated with 3 versus 4 weeks of radiation therapy for breast cancer.

Methods: An IRB-approved retrospective review identified 342 patients treated with hypofractionated radiation therapy from 2013 to 2020. 195 treated with the 4-week regimen and 147 with a 3-week regimen. Primary endpoint was acute skin toxicity assessed by: CTCAE v4.0 physician-scored toxicity during weekly visits, use of topical silver sulfadiazine, and patient recollection of skin toxicity (assessed by telephone survey done as part of the study). Secondary endpoints were patient-reported cosmesis by BCTOS, overall survival, and local recurrence-free survival. Log-rank tests were used to compare grade ≥ 2 skin toxicity between arms. Fischer’s exact test were used for comparing toxicities between the two groups and two-sided *P* values were reported.

Results: Median follow-up was 26 months (3-93 mo). Overall grade ≥ 2 CTCAE weekly assessed acute skin toxicity was 30% (33% 3-week vs. 27% 4-week; *P*=NS). Topical silver sulfadiazine use was 39% 3-week vs. 35% 4-week, *P*=.NS. Recollection of acute skin toxicity on telephone survey was 77% 3-week vs. 69% 4-week, *P*=.008. 206 (60%) responded to the telephone survey at time of data collection. This also noted the 3-week course was more likely to report peak skin

toxicity after completion of RT (38% vs 18%, *P*=.005). BMI > 30 was more common in the 4-week group than the 3-week group (48% vs 29%, *P*=0.007). BCTOS showed no difference between the groups in cosmesis, function, pain (1.55 vs. 1.63, 1.24 vs. 1.21, 1.51 vs. 1.42, *P*=NS). There was no difference in overall or local recurrence free survival (97.9% vs 95.9%, 98.9% vs 97.4%, *P*=NS). 3% (10 of 342) patients had died, 1% (3) from breast cancer, 1% (3) from non-breast second cancer, and 1% (4) due to other causes.

Conclusions: In this comparison of two popular hypofractionation regimens, we observed comparable physician-reported acute skin toxicity, cosmesis, and disease control outcomes. Limitations to this study include the possibility of measurement bias and selection bias. The 3-week group reported more peak skin toxicity after completion of treatment, this could be associated with under-reporting of skin CTCAE weekly assessment on the 3-week regimen. A higher number of patients with greater BMI was present in the 4-week regimen. Both could skew results in favor of the 3-week regimen. Across treatment arms, there was a higher incidence of silver sulfadiazine prescribed than physician-recorded acute toxicity. Though the treatments compared in this analysis varied by a short time interval, hypofractionation could make treatment more convenient and accessible for many patients. Additional comparative analyses that incorporate patient-reported outcome measures are encouraged to determine the most safe and effective treatment for individuals.

(P018) Wrong Number: The Inappropriate Use of an Age Cutoff Heuristic to Allocate Adjuvant Therapy for High-risk, Early-stage Breast Cancer Patients Following Breast Conserving Surgery

Wesley Talcott, MD, MBA¹, Daylian Cain, PhD, MBA², Daniel Yang, MD¹, Sarah Mougalian, MD¹, Suzanne Evans, MD MPH³; ¹Yale School of Medicine, ²Yale School of Management, ³Yale New Haven Health/Smilow Cancer Center

Background: Patient age is a continuous variable that should be incorporated into oncologic decision making. However, providers under time pressure have been shown to process age by dividing patients into “older” vs “younger” categorical subgroups. Use of this cognitive shortcut (“age cutoff heuristic”) simplifies incorporation of patient age into treatment decisions but may lead to inappropriate treatment allocation around the age cutoff used for dichotomization.

Objectives: We hypothesized the existence of an age cutoff heuristic leading to non-evidence-based adjuvant treatment allocation among

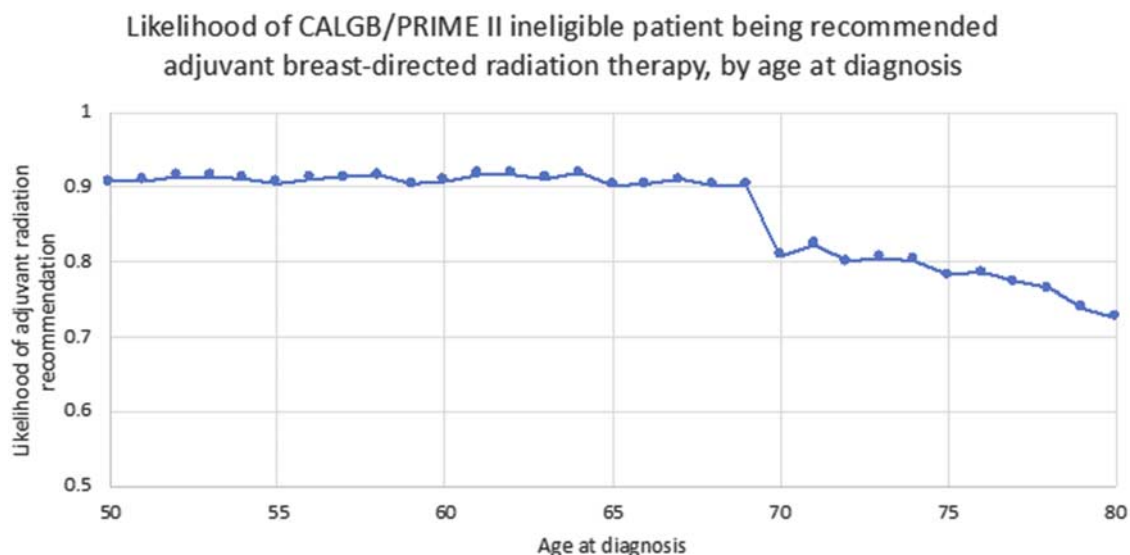

FIGURE 1. Likelihood of a CALGB/PRIME ineligible patient being recommended adjuvant breast-directed radiation therapy following breast conserving surgery demonstrating early stage breast cancer with high-risk features, by age at diagnosis. Likelihood of being recommended adjuvant radiation therapy declines sharply for patients aged 69 versus age 70.

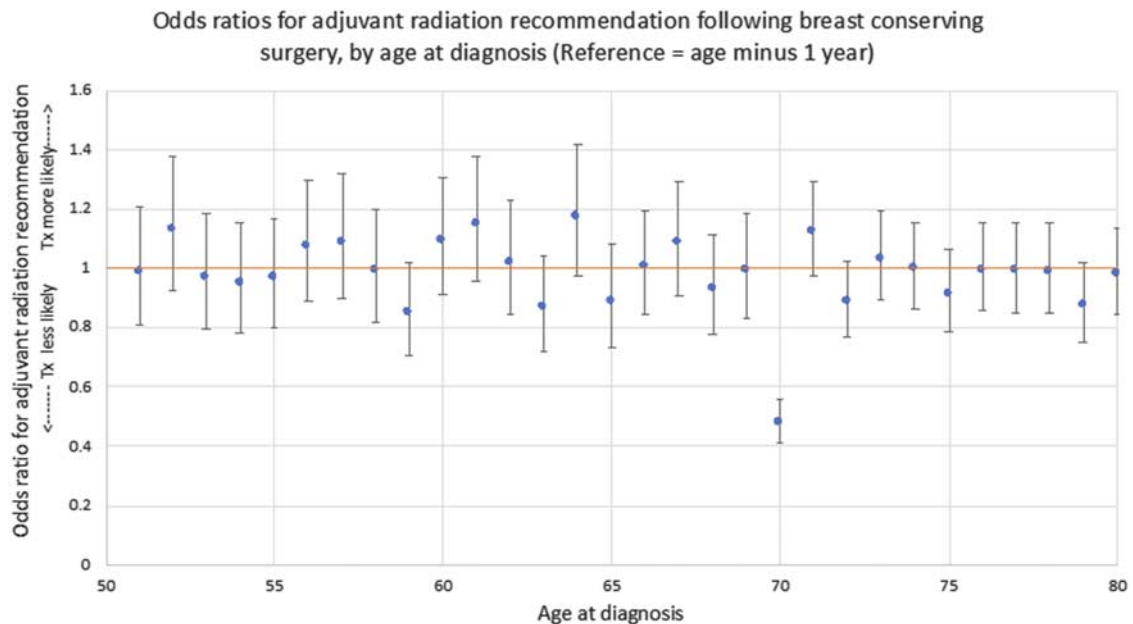

FIGURE 2. Forest plot of odds ratios for being recommended adjuvant radiation therapy. Each point represents a multivariable regression including the subset of patients with the corresponding age at diagnosis as well as the patients aged 1 year younger at diagnosis. The OR and 99% CI representing the association between each year-over-year age increase and likelihood of radiation recommendation are plotted. In this MVA age 70 at diagnosis was independently associated with significantly reduced odds of being recommended adjuvant radiation versus age 69 at diagnosis. No other year-over-year age increase was independently associated with likelihood of being recommended radiation.

high-risk, early-stage breast cancer patients based on a patient's age being ≥ 70 , and characterized recommendation of adjuvant therapy in this population.

Methods: We used the National Cancer Data Base to identify women aged 50-80 years with pT1-2 node-negative breast carcinoma diagnosed 2004-2017, who underwent lumpectomy. Among these, we identified 162,111 patients with CALGB 9343/PRIME II-ineligible features other than age (estrogen receptor negative, endocrine therapy not planned, final margins positive, or size > 3 cm)(cohort 1), and 394,946 hormone receptor positive (HR+) patients with tumors > 5 mm (cohort 2). Multivariable logistic regressions (MVA) with odds ratios (OR) and 99% confidence intervals (CI) were performed for "year-over-year" age pairings, from patients aged 50 and 51 up to patients aged 79 and 80 at diagnosis. Age at diagnosis, along with 21 additional disease and patient factors potentially associated with treatment decisions, were included in these MVA. Age was treated as a categorical variable in these MVA to determine if any single year-over-year age difference was independently associated with a difference in likelihood of adjuvant therapy recommendation.

Results: Overall, 87.3% of patients with CALGB 9343/PRIME II ineligible breast cancer were recommended adjuvant radiation therapy ($n = 140,513$) and 92.3% of HR+ patients with tumor size > 5 mm were recommended adjuvant endocrine therapy ($n = 364,048$). Among cohort 1, rate of adjuvant radiation recommendation decreased sharply at age 70, from 90-92% between the ages of 50 to 69, declining to 81% for those aged 70 (Fig. 1). Regressions for each year-over-year age pair showed year-over-year age difference was only an independent predictor adjuvant radiation recommendation at age 70 vs 69 (OR 0.47, CI 0.40-0.55, $P < 0.001$) (Fig. 2). For cohort 2, rates of endocrine therapy recommendation showed a smaller absolute decline at age 70, but year-over-year age difference was again only a predictor of endocrine therapy recommendation at age 70 vs 69 (OR 0.86, CI 0.76-0.97, $P = 0.001$).

Conclusions: We observed a sharp and unique step-off in adjuvant therapy recommendation between ages 69 and 70. This suggests use of an age cut off heuristic to process patient age in this population as a categorical, binary variable. This is a previously undescribed

phenomenon in high-risk, early-stage breast cancer, and a practice with concerning implications for evidence-based care allocation.

(P019) Patient Reported Outcomes Version of the Common Terminology Criteria for Adverse Events and CTCAE in Breast Cancer Patients Receiving Radiation Therapy: Single-center Prospective Registry Experience

Cameron Thorpe, MD¹, Todd DeWees, PhD¹, Michael Golafshar, MS¹, Ronik Bhangoo, MD¹, Tamara Vern-Gross, DO¹, Lisa McGee, MD¹, William Wong, MD², Michele Halyard, MD¹, Sameer Keole, MD², Carlos Vargas, MD²; ¹Mayo Clinic, ²Mayo Clinic Arizona

Background: Adverse events during cancer treatment are recorded by providers using the US National Cancer Institute's (NCI) Common Terminology Criteria for Adverse Events (CTCAE). However, symptomatic adverse events are often underreported by physicians and do not fully represent the full scope of the impact that cancer treatment has on patients

Objectives: We sought to investigate the relationship between PRO-CTCAE and CTCAE for breast cancer (BC) patients undergoing radiation therapy (RT) from a prospective registry for a large, single-institution.

Methods: From a prospectively maintained registry, all patients treated with RT for BC with curative intent from November, 2015 to June, 2019 at our institution were eligible for this analysis. To be included patients were required to have at least one PRO-CTCAE survey. PRO-CTCAE questionnaires were administered at baseline, end-of-treatment, 3, 6, 12 months, then annually. Correlation between CTCAE and PRO-CTCAE was measured using Pearson's correlation coefficient (r) and univariate Logistic regression was utilized to measure the clinical magnitude of that correlation.

Results: Three-hundred and thirty-one (331) patients were included for analysis. Patient and tumor characteristics included: 82% ER(+), 77% PR(+), 10% HER2(+), and 66% ECOG 0. Treatment characteristics included: median dose 40.05 Gy (range, 40-50.4 Gy), 75% underwent lumpectomy, 39% received chemotherapy, 85% treated with photon,

15% treated with proton beam therapy, and 40% received a boost (median 10 Gy, range 5.4–14 Gy). “Moderate” or worse PRO-CTCAE correlated with CTCAE grade ≥ 2 ($r=0.35$, $P<0.0001$). “Severe” or worse PRO-CTCAE correlated with CTCAE grade ≥ 3 ($r=0.19$, $P<0.001$). Furthermore, “Moderate” or worse PRO-CTCAE was predictive of developing CTCAE grade ≥ 3 (OR = 3.25, 95% CI [0.95–11.2], $P=0.06$).

Conclusions: PRO-CTCAE and CTCAE offer complimentary information and both should be reported in cancer trials. In this cohort of breast cancer patients, “Moderate” or worse PRO-CTCAE predicted for development of CTCAE grade ≥ 3 . Patients who report “Moderate” or worse PRO-CTCAE should be monitored closely for development of toxicities. Future studies in breast cancer should report on both PRO-CTCAE and CTCAE to better understand how patients tolerate treatment.

(P020) Patterns of Care and Utilization of Radiation for Women with High Grade Ductal Carcinoma in Situ: A National Cancer Database Analysis

Irina Youssef, MD¹, Benjamin Silver, MD¹, Jared Pasetky, MD¹, Fleure Gallant, MD², David Schreiber, MD¹; ¹SUNY Downstate Health Sciences University, ²Maimonides Cancer Center

Background: Ductal carcinoma in situ (DCIS) currently comprises 25% of newly diagnosed breast cancers, and this rate continues to rise with improvements in screening. While prospective studies have demonstrated a reasonably low risk of recurrence in “good-risk” patients with lumpectomy without radiation, EOCG 5194 showed the risk of developing ipsilateral breast events in patients with high-nuclear grade DCIS, who received lumpectomy alone, increased without plateau.

Objectives: The purpose of this study was to retrospectively review the National Cancer Database (NCDB) to assess patterns of care in patients with high-grade DCIS treated with lumpectomy with or without radiation.

Methods: The National Cancer Database (NCDB) was queried to identify women treated with lumpectomy for high grade DCIS of the breast from 2004–2016. Data regarding age, tumor size, endocrine therapy use, ER receptor status, margin status, race, insurance type and distance from the treatment center were collected. Radiation fractionation was collected and categorized as hypofractionation, standard fractionation, and other, if the fraction size could not be clearly ascertained. Clinical and patient-related factors were compared between patients who received radiation and no radiation. Frequency distributions between categorical variables were compared using the χ^2 test. Multivariable logistic regression was used to identify co-variables associated with the use of radiation.

Results: A total of 16,100 patients met the eligibility criteria. Of those, 10,378 (65%) received adjuvant radiation. On multivariable regression, patients who received radiation were more likely to be ER- (OR 1.68, 95% CI 1.54–1.83, $P<0.001$), and have tumor size of 1cm or larger (OR 1.23, 95% CI 1.13–1.33, $P<0.001$). Those less likely to receive radiation included great-circle distance of > 20 miles (OR 0.80, 95% CI 0.71–0.91, $p0.005$), distance > 30 miles (OR 0.54, 95% CI 0.48–0.60, $P<0.001$), and age > 65 years (OR 0.68, 95% CI 0.60–0.78, $P<0.005$). There were no differences in radiation utilization based on the year of diagnosis. Fractionation technique was categorized as standard or hypofractionated in 64.3% of patients. Of those, the use of hypofractionation increased from 1% in 2004 to 9.2% by 2010 and to 51.7% by 2016.

Conclusions: There appears to be an underutilization of radiation therapy for women with high grade DCIS, particularly those who live > 20 miles from a treatment facility. Prospective evaluation of ultra-hypofractionated regimens and/or intra-operative regimens in DCIS patients is warranted and may improve utilization of adjuvant RT.

(P021) Clinical Factors Associated with Local Control or Radiation Necrosis for Patients Undergoing Single Fraction SRS

Gregory Alexander, MD¹, Jill Remick, MD², Emily Kowalski, MD¹, Kai Sun, MS³, Stewart Becker, Physicist¹, Naru Lamichhane, PhD¹,

Howard Eisenberg, MD¹, Graeme Woodworth, MD¹, William Regine, MD¹, Mark Mishra, MD¹; ¹University of Maryland, ²Emory, ³University of Maryland School of Medicine Department of Epidemiology and Public Health

Background: Single-fraction stereotactic radiosurgery (SF-SRS) for the treatment of brain metastases can be delivered with either a Gamma-Knife platform (GK-SRS) or with a frameless linear accelerator (LA-SRS). These techniques vary based on patterns of prescribing, patient setup and radiation delivery but the effect of these differences on clinical outcomes is unknown.

Objectives: We seek to examine clinical factors associated with radiation necrosis and local failure in patients undergoing single fraction SRS in patients with metastatic brain cancer.

Methods: Patients treated for metastatic brain cancer treated with SF-SRS from 2014–2020 were retrospectively reviewed and clinical outcomes were recorded on a per lesion basis. Covariates between groups were compared using a χ^2 analysis for dichotomous variables and t-test for continuous variables. Median follow up was calculated using the reverse Kaplan Meier (KM) method. Primary endpoints of local control (LC) and symptomatic radiation necrosis (RN) were estimated using the KM method with salvage WBRT used as a censoring event. Outcome estimates were compared using the log-rank test. Multivariate analysis (MVA) and Cox proportional hazards modeling were used for statistical analyses. Propensity score (PS) adjustments were used to reduce the effects confounding variables. Further subset analyses of lesions treated with GK-SRS and LA-SRS were performed.

Results: Overall, 119 patients with 287 lesions were included for analysis which included 57 patients (127 lesions) treated with LA-SRS compared with 62 patients (160 lesions) treated with GK-SRS. In terms of lesion size, there was no statistically significant differences in percentage of lesions > 2 cm treated with GK-SRS vs LA-SRS (14.17% vs 8.75%; $P = 0.147$). For the entire cohort the median follow-up was 11 months (15.2 mo GK-SRS vs 7.9 mo LA-SRS) with median OS 15.9 months (16.2 mo GK-SRS vs 12.3 mo LA-SRS). On both multivariate and univariate analysis, there was no statistically significant differences between GK-SRS and LA-SRS for local failure or in risk of radiation necrosis analysis (multivariate adjusted P -value = 0.44). Tumor size (> 2 cm vs ≤ 2 cm) was predictive of both risk of radiation necrosis and local failure. Subset analysis of lesions treated with LA-SRS did not find the addition of PTV margin or timing of MRI used for treatment planning to be associated with clinical outcomes. Subset analysis of lesions treated with GK-SRS found that the first quartile of dose rate was associated with increased risk of radiation necrosis, ($P=0.0001$), but lesion characteristics were imbalanced between groups.

Conclusions: In our retrospective cohort, we found no statistically significant differences in the incidence of symptomatic radiation necrosis or local control in patients treated with GK-SRS when compared with LA-SRS. Other clinical variables may be important and require consideration. Further study with well-matched prospective cohorts is required to validate these results.

(P022) Stereotactic Radiosurgery in Patients with Trigeminal Neuralgia and Diabetes Mellitus: A Retrospective Review

Jack Allen, Undergraduate Student¹, Nathan Munson, MD¹, Michael Ray, MD, PhD¹, Shanelli Fernando, MD¹; ¹ThedaCare Regional Cancer Center, Appleton, Wisconsin

Background: Trigeminal Neuralgia (TN) is a neurological disorder characterized by intense unilateral pain in the face following a stimulus. TN treatments predominantly consists of stereotactic radiosurgery (SRS), microvascular decompression, or percutaneous rhizotomy. Type 2 diabetes (T2D) is a disease that affects many patients with TN, and may have an impact on TN treatment.

Objectives: The objective of the current retrospective review is to examine variances in treatment outcomes using SRS for TN in patients with T2D and in the absence of T2D.

Methods: Clinical data from 34 consecutive TN patients (2007–2013) was collected following treatment with SRS in our department. Patients were allocated to T2D ($n = 13$) and T2D absent groups (DA) ($n = 21$).

Diabetic status was defined as hemoglobin A1C (HbA1C) > 6.5% or fasting blood glucose levels (FBGL) > 130 mg/dL. HbA1c results were available for 11 patients within the T2D group. The remaining two T2D patients had FBGL > 130 mg/dL in three consecutive visits. The patient age was DA = 65.0 ± 16.3 and T2D = 70.5 ± 14.3. The DA group consisted of 14 females and 7 males, while the T2D group consisted of 9 females and 4 males. Before SRS, pain levels were determined using the Barrow Neurological Institute (BNI) Pain Intensity Score. Treatment outcomes were measured using the BNI score one-week post operation and one year following SRS. The differential in BNI score following the operation was then analyzed using a two sample t test for difference in mean.

Results: Before SRS the DA group had a BNI score of 4.80 ± 0.4, the T2D group had a BNI score of 4.84 ± 0.37. One week following treatment the scores were DA = 1.92 ± 1.26 and T2D = 2.10 ± 1.51. One year after SRS the results were DA = 2.41 ± 1.51 and T2D = 1.58 ± 1.40. Comparison of the starting BNI score and the BNI score at the one-week post SRS visit of the DA group to the T2D group did not yield a significant difference in BNI score ($P = 0.9066$). Comparison of the DA group BNI score before SRS and BNI score one-year post operation to the T2D group yields a significant mean difference ($P = 0.0121$). The DA group experienced a 1.417 greater BNI pain reduction (95% CI: 2.499, 0.3347) as compared with the T2D BNI score at the 1-year mark.

Conclusions: This exploratory study suggests a relationship between decreased treatment efficacy of SRS one year following the operation and T2D in TN patients. Further studies are needed to examine a possible decrease in treatment efficacy for T2D patients with TN for treatments such as microvascular decompression or percutaneous rhizotomy.

(P023) Radiotherapy for Management of Brain Metastases from Thyroid Cancer: A National Cancer Database Study

Erik Blomain, MD¹, Michael Binkley, MD¹, Duc Giao, Visiting Student¹, Thomas Churilla, MD², Scott Soltys, MD¹, Erqi Pollom, MD¹; ¹Stanford University, ²Northeast Radiation Oncology Center, Geisinger Commonwealth School of Medicine

Background: Brain metastasis is a rare presentation of thyroid cancer and there is a paucity of data regarding management. Although stereotactic radiosurgery (SRS) is a standard of care for patients across many histologies, the current NCCN guidelines do not support a universal role for this modality in thyroid cancer. Alternatives to SRS include whole brain radiotherapy (WBRT) and best supportive care; however, current practice patterns regarding the relative use of these modalities remains largely undefined.

Objectives: In that context, the present study queried the National Cancer Database to look at practice patterns and outcomes in patients with brain metastases from thyroid cancer with a goal of informing management.

Methods: The Participant User File (PUF) for Thyroid Cancer was obtained from the NCDB in accordance with all institutional and organizational regulations. The data was formatted using SAS and

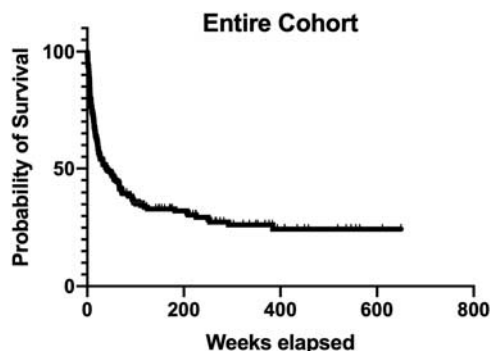

FIGURE 1. Overall Survival.

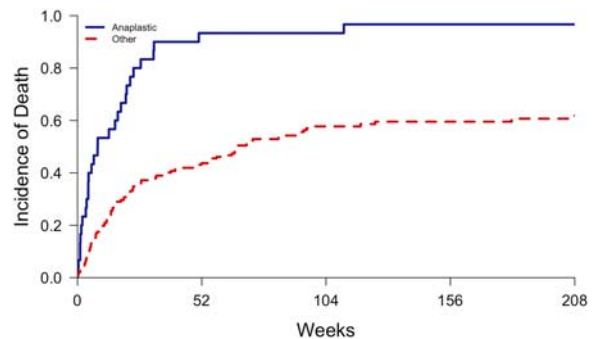

FIGURE 2. Cumulative incidence of death: anaplastic versus differentiated thyroid cancer.

analyzed in R studio and Graphpad Prism. The PUF was screened by patients who presented with brain metastases and/or who received brain-directed radiotherapy. Kaplan–Meier analysis was performed for overall survival, as was multivariable regression analysis. Descriptive statistics were collected regarding patient demographics and treatment information.

Results: Overall, we identified a cohort of 289 patients. Median age was 63 years old (range 19–90 years old) and 56.1% were female. 68.5% of patients were white, 13.8% were black and 11.1% were latino (several other races were represented <5%). 16.6% received SRS, 55.0% received other brain-directed radiotherapy, and 28.4% received no brain-directed RT. Histologic breakdown was as follows: Papillary 45.7%, Anaplastic 15.2%, Other 10.7%, Medullary 10.0%, Follicular 9.7% and Unknown 8.7%. In terms of practice patterns, there appeared to be a trend towards decreasing use of non-SRS brain radiotherapy, although this is potentially confounded by missing data from recently-treated patients. Median follow up was 213.2 weeks, and median overall survival was 40.9 weeks. On multivariable analysis, treatment modality (SRS versus other brain RT versus no brain RT) was not significant in terms of OS (hazard ratio 1.09, $P = 0.55$); however, anaplastic histology was significantly associated with worse overall survival (hazard ratio 3.5, $P = 0.00000005$), and anaplastic patients' median overall survival was 8.4 weeks.

Conclusions: Brain metastases from thyroid cancer portend a poor prognosis (< 1 year median in our study), particularly for patients with anaplastic histology. The decision to treat with radiotherapy and the type of radiotherapy utilized did not appear to affect overall survival, consistent with other retrospective and prospective data in brain metastases from other histologies. Of note, our case number was rather limited, potentially due to the relatively rare nature of this metastatic presentation. Despite this limitation, the present study represents to our knowledge the largest dataset to date of thyroid cancer brain metastases treated with radiotherapy. Within the limitations inherent to NCDB studies, our data suggest clinical equipoise in the management of these patients (Figs. 1 and 2).

(P024) Intracranial Response to Combination BRAF and MEK Inhibitor Therapy in Patients with Metastatic Melanoma

Caressa Hui, MD¹, Yufan (Fred) Wu, MD¹, Kevin Liu, BS², Navjot Sandhu, BS¹, Erik Blomain, MD¹, Michael Binkley, MD¹, Melanie Gephart, MD, MAS¹, Steven Chang, MD¹, Gordon Li, MD¹, Sunil Reddy, MD¹, Iris Gibbs, MD¹, Scott Soltys, MD¹, Erqi Pollom, MD¹; ¹Stanford University, ²Carnegie Mellon University

Background: Combination BRAF+MEK inhibitor therapy is now widely used in the treatment of metastatic melanoma. However, data for intracranial response to these drugs are limited.

Objectives: We aimed to evaluate the intracranial efficacy of BRAF +MEK inhibitors in patients with BRAF-mutant melanoma with brain metastases and to determine patterns of failure of these new agents to inform optimal integration of local intracranial therapy.

Methods: We identified patients with BRAF-mutant melanoma with metastasis to the brain with at least one untreated brain metastasis (BM) at the time of initiation of BRAF+MEK inhibitors at our institution from 2006 to 2020. We obtained per-patient and per-lesion data on demographics, treatment, and outcomes. Cumulative incidence of local (LF), distant intracranial (DF) and extracranial failure (EF) were calculated with competing risk analysis with death as a competing risk, and censored at the last brain MRI follow up. LF was calculated on a per-lesion basis while DF and EF were calculated on a per-patient basis. DF was defined as any new intracranial lesions. Overall survival (OS) was analyzed using Kaplan-Meier. Logistic regression was used to identify predictors for LF.

Results: We identified 10 patients with 63 untreated BM. Median age was 50.5 years old. Median sum of the diameters of the 5 largest untreated BM per patient was 20 mm (interquartile range 15-39 mm) and median diameter for all measurable lesions was 4 mm. Median follow up time was 9.0 months (range 1.4 mo-46.2 mo). Median OS was 13.6 months. The 1-year cumulative incidence of LF, EF and DF were 17.1%, 71.4%, and 88.6%, respectively. Median time to LF, DF, and EF from start of BRAF+MEK inhibitors was 9.0 months, 4.7 months and 7.0 months, respectively. Larger size of the BM was associated with LF (odds ratio 1.13 per 1 mm increase in diameter, 95% confidence interval 1.019 to 1.308, $P < 0.02$). 6 patients (60%) experienced significant toxicities with BRAF+MEK inhibitors, with 1 patient switching to another BRAF plus MEK inhibitor, 4 patients requiring treatment breaks or decreased dose, and 1 patient stopping therapy. 2 (20%) patients eventually received stereotactic radiosurgery, and 2 (20%) received whole-brain radiotherapy for intracranial progression.

Conclusions: Although patients with BRAF-mutant melanoma with BM had fair LC on BRAF+MEK inhibitors, the competing risk of death, distant intracranial and extracranial progression were high. Patients with larger BM may benefit from local therapy.

(P025) Treatment Fractionation and Lymphopenia in Patients Receiving Radiation for Glioblastoma: Could Hypofractionation Reduce Toxicity?

Sean Koerner, MD, MS¹, Joshua Rodríguez-López, MD², Zaid Siddiqui, MD¹, John Flickinger, MD, FACP¹, ¹UPMC Hillman Cancer Center, ²Department of Radiation Oncology, UPMC Hillman Cancer Center, University of Pittsburgh School of Medicine

Background: Prognosis in patients with glioblastoma (GBM) is impacted by their ability to receive temozolomide (TMZ), both concurrently with radiation therapy (RT) and in the adjuvant setting. Lymphopenia is a common side effect of TMZ therapy, and post-RT lymphopenia may inhibit adjuvant TMZ treatment and therefore decrease survival.

Objectives: We sought to assess the impact of RT fractionation on lymphopenia.

Methods: We identified patients treated with external beam radiation therapy (EBRT) for GBM from at our institution from 2012 through 2017. Treatment data, including fractions delivered, total dose, radiation technique, site of primary tumor, and age at diagnosis, was extracted from our treatment electronic medical record (EMR). Laboratory data from our hospital EMR was retrospectively assessed, and individual patient lymphopenia during treatment and in the month following radiation therapy was recorded by the Common Terminology Criteria for Adverse Events (CTCAE), version 5.0, and collated with treatment data. We defined grade 2 lymphopenia (WBC < 0.8) as sufficient to impact TMZ administration, and hypofractionated treatment as ≤ 15 fractions. Wilcoxon signed-rank test was performed to assess for a correlation between number of fractions delivered and development of lymphopenia.

Results: 472 patients with RT treatment data were assessed for qualifying laboratory data, and 340 patients had sufficient laboratory data for assessment of lymphopenia according to our criteria. Median age was 65, and 57.9% of patients received a conventionally fractionated course, with 42.1% receiving hypofractionated treatment and the majority (91.3%) receiving concurrent TMZ. Patients who did not receive concurrent TMZ were either medically ineligible before RT

initiation or declined chemotherapy. A total of 7 patients developed grade ≥ 2 lymphopenia, an incidence of 2.03%; four, two, and one were categorized as grade 2, 3, and 4, respectively. All patients who developed RT-associated lymphopenia were in the conventionally fractionated cohort, and the correlation between fractions received and increased CTCAE lymphopenia grade was significant ($P < 0.001$).

Conclusions: Increased fractionation of RT is correlated with increased incidence and CTCAE grade of lymphopenia. Hypofractionation may reduce the likelihood of developing lymphopenia and impact patient prognosis through capacity to receive adjuvant temozolomide therapy.

(P026) Definitive Radiation Therapy for Chordoma: A Systematic Review

Nicholas Gravbrot¹, Riley McDougall¹, Baldassarre Stea, MD PhD²; ¹University of Arizona College of Medicine - Tucson, ²Banner/University of Arizona/Dept. Radiation Oncology

Background: Chordomas are rare, slow-growing malignancies arising from remnants of the primitive notochord. En bloc resection is not often achieved due to local invasion, and systemic adjuvant treatments are of limited benefit. High rates of local recurrence and poor long-term prognoses are common after primary surgery alone. Traditionally, the role of radiotherapy (RT) is postoperatively after partial resection, but definitive high-dose RT has recently been explored as an alternative.

Objectives: To review the literature on definitive RT in chordoma treatment.

Methods: Following the Preferred Reporting items for Systematic Reviews and Meta-Analyses guidelines, a systematic review was conducted. Four databases were queried: PubMed, ScienceDirect, Embase, and Cochrane. Studies included original research articles in peer-reviewed journals with patients undergoing definitive RT for biopsy-proven chordoma. Case reports, conference papers/abstracts, protocols, and book chapters were excluded.

Results: Twenty studies were included for analysis. Follow-up durations ranged from 1-5 years. Many series reported pooled data, combining chondrosarcoma and other pathologies, adjuvant or salvage RT, and combination or multiple monotherapies (e.g. proton or carbon ion or photon); as such, abstraction by pathology, disease state, or modality was not possible. 543 patients were included: 363 sacral, 117 skull base, 23 mobile spine, and 40 location undisclosed. Carbon ion monotherapy in 196 patients (all sacral), proton in 65 (48 sacral, 10 skull, 2 spine, 5 undisclosed), and photon in 14 (7 skull, 2 spine, 5 undisclosed). The rest of patients (n=268) either received combination therapy (proton/carbon, photon/proton) with cumulative doses reported in Gy adjusted for RBE of protons and carbon ions or were part of series with pooled monotherapy results. Most patients received 60-78.3 Gy. The mean 5-year local control (LC), overall survival (OS), progression-free survival (PFS) were 78.9% (range 46.0-89.0%), 78.9% (44.0-100.0%), and 90.9% (80-100%), respectively. For studies with shorter follow-up, 3-year LC, OS, and PFS were 82.5% (53.0-92.0%), 88.9% (67.0-96.0%), and 79% (72.0-89.6%), respectively. Results were similar regardless of location or RT modality. Most studies used CTCAE to note toxicities. Early grade 3-4 toxicities were seen in 42 patients and delayed grade 3-4 toxicities in 48; no grade 5 toxicities were reported. Toxicities included acute dermatitis (4.6%), acute neuropathies (1.3%), chronic radiation dermatitis (6.1%), and chronic neuropathies (1.7%).

Conclusions: Although en bloc gross total resection has been advocated as the standard of care for chordomas, this is rarely possible and commonly fraught with complications. Definitive treatment of biopsy-proven chordomas with high-dose, charged particle RT appears to be reasonably effective, offering comparable tumor control rates to those of upfront surgical debulking with acceptable toxicity.

(P027) American Radium Society Appropriate Use Criteria for the Management of Brain Metastases in EGFR-mutated Non-Small Cell Lung Cancer

Seema Nagpal, MD¹, Veronica Chiang, MD², Michael Milano, MD, PhD³, Scott Soltys, MD¹, Manmeet Ahluwalia, MD, MBA⁴, Samuel Chao, MD⁵, Amit Garg, MD⁶, Melanie Gephart, MD, MAS¹, Lia

Halasz, MD⁷, Siavash Jabbari, MD⁸, Jonathan Knisely, MD⁹, Simon Lo, MB, ChB, FACR, FASTRO⁷, Joshua Palmer, MD¹⁰, Arjun Sahgal, MD¹¹, Martin Tom, MD¹², Tony Wang, MD¹³, Eric Chang, MD¹⁴; ¹Stanford University, ²Yale University, ³University of Rochester, ⁴Miami Cancer Institute, ⁵Cleveland Clinic, ⁶MD Anderson Cancer Center, ⁷University of Washington, ⁸Laurel Amtower Neuro-Oncology Center and Cancer Institute at Sharp Healthcare, ⁹Weill Cornell Medicine, ¹⁰The Ohio State University Wexner Medical Center, ¹¹Department of Radiation Oncology, Sunnybrook Odette Cancer Centre, University of Toronto, ¹²Miami Cancer Institute, Baptist Health South Florida, ¹³Columbia University, ¹⁴University of Southern California Keck School of Medicine

Background: Epidermal growth factor receptor (EGFR) mutated non-small cell lung cancer (NSCLC) can be treated with a number of small molecule tyrosine kinase inhibitors (TKIs) that have central nervous system (CNS) penetration. How the evolving role of TKIs in the treatment of NSCLC impacts decision making for stereotactic radiosurgery (SRS) and whole brain radiation therapy (WBRT) for brain metastases (BrMs) is of particular interest.

Objectives: The ARS Appropriate Use Criteria group for brain malignancies sought to review the literature on EGFR-targeted systemic therapy for the treatment of BrMs.

Methods: The panel developed 3 key questions (KQs) to help guide the literature search and selection of studies: A) Can radiation therapy (SRS or WBRT) be deferred in patients receiving a potentially CNS-active TKI? B) If radiation therapy is recommended (SRS or WBRT), should it be given together with TKI or in sequence? C) At time of CNS progression on TKI, should RT be deferred if another CNS-penetrating TKI is available? The search results were screened by article type and relevance to the key questions. Selected articles were then assigned an evidence grade by 2 reviewers according to the Evidence Table Development guidelines of the ACR-ARS.

Results: The initial search yielded 738 articles, from which 40 articles were selected. The expert panel developed 8 model cases, with up to 5 sub-variants each, addressing the KQs and relevant clinical questions that were not easily addressed by articles in the literature search. The panel elected to design a case variant for leptomeningeal disease as well as a case using hypothetical future therapies with varying CNS penetration, degree and duration of response. Management options ranged from deferring any form of radiation therapy through multiple lines of therapy to using SRS or WBRT in combination with TKIs in the upfront setting. The panel will vote on the appropriateness using a 9-point scale, with 1-3, 4-6 and 7-9 corresponding to not appropriate,

may be appropriate, and usually appropriate (respectively). Agreement vs. disagreement of panelist will be determined by the number of outliers. We will present these results.

Conclusions: The development of multiple brain-penetrant drugs for the treatment of metastatic cancers has given patients and physicians an increasing number of treatment options for brain metastases, including the deferral of WBRT or SRS. We did not identify definitive studies dictating the sequence of therapy for CNS-penetrant drugs and radiation. Until such studies are designed and completed, the ARS-AUC committee hopes these cases will help guide clinicians through increasingly complex decision making.

(P028) An Analysis of Facebook Groups for Patients with CNS Tumors

Ryan O’Keefe, BA¹, Molly Murphy, Student², Annabelle Huffman, Student², Andrea Matienzo Carrillo, Student², Lauren St. John, Student², William Hornyak, Student², Christine Hill-Kayser, MD¹; ¹University of Pennsylvania, ²College of the Holy Cross

Background: The utilization of social media is a common method for cancer patients and caregivers to share stories, provide support, and disseminate information. Numerous studies have raised concerns about the quality of information shared amongst cancer-focused social media groups and have called for providers to serve as moderators (Gage-Bouchard E et al J. Cancer Educ 2018; Petukhova T, et al Dermato Online J. 2020). Other work investigated the content and quality of social media posts related to glioblastoma on YouTube, Facebook, Twitter, and Instagram. (Bird C, et al Cureus 2020; ReFaey K, et al J Clin Neuro 2018). YouTube is the largest source of information and tends to focus on surgery and patient experiences, whereas Facebook is most used for patient-to-patient support. To date, there has not been a thorough evaluation of Facebook groups available for common CNS tumors beyond glioblastoma.

Objectives: This study investigated the presence of Facebook groups related to common central nervous system (CNS) tumors on Facebook to better understand available resources for patients, their intended purposes, and potential opportunities for provider involvement.

Methods: On August 9, 2020, the terms “glioblastoma” (GBM), “astrocytoma” (ACM), “meningioma” (MGM), and “oligodendroglioma” (ODM) were searched on facebook.com under the “Groups” tab. All groups from the search were manually pulled and coded. Groups were included for final analysis if they were in English, related to the tumor-type, had > 2 posts per week, and membership

TABLE 1. CNS Tumor Facebook Group Selection, Features, and Purpose

Inclusion/Exclusion Criteria	Astrocytoma		Glioblastoma		Meningioma		Oligodendroglioma		Total	
	Total Groups Identified	92		95		72		34		293
In English	92	100%	88	93%	70	97%	30	88%	280	96%
Related to Disease	86	93%	87	92%	43	60%	29	85%	245	84%
> 10 Members	78	85%	81	85%	35	49%	15	44%	209	71%
> 2 posts/week	17	18%	39	41%	10	14%	4	12%	70	24%
Final # Groups for Analysis	17	24%	39	56%	10	14%	4	6%	70	24%
Group Stats										
Avg # of Members	1,008	-	1,864	-	2,142	-	1,204	-	-	-
Avg # Annual Posts	488	-	940	-	6,511	-	832	-	-	-
# Private	5	29%	24	62%	8	80%	4	100%	41	59%
# With Rules for Posting	2	12%	15	38%	3	30%	2	50%	22	31%
Category										
Sharing Stories and Support	4	24%	21	54%	7	70%	1	25%	33	47%
Individual Journey	11	65%	12	31%	1	10%	0	0%	24	34%
Research and Clinical Trials	0	0%	3	8%	0	0%	0	0%	3	4%
Fundraising or Advertising	0	0%	1	3%	1	10%	0	0%	2	3%
General Info and Awareness	2	12%	2	5%	1	10%	3	75%	8	11%

> 10 people. Data points of interest were extracted from each page's "About" tab between August 10-22, 2020.

Results: 292 Facebook groups were found using the search terms, 70 met inclusion criteria (Table 1). GBM-related groups were most common and MGM-related groups had the largest average membership size with the most average annual posts (Table 1). 41 (58.6%) were private groups, and 22 (31.4%) had rules regarding posting content. Most groups were created for the purpose of sharing support and stories or to describe an individual's journey with their disease (Table 1). Astrocytoma-related groups were predominantly created to describe an individual's journey, with 9 of 11 being pediatric patients. Groups created to share general information about the disease, to discuss research or clinical trials, or to fundraise were less common.

Conclusions: MGM-related groups on FB had the most activity, possibly due to its high prevalence amongst CNS tumors and longer life expectancy. Most groups identified were not currently active. In line with previous work, groups focused on individual journeys and support were most common. There were few public groups focused on sharing general information or discussing research, potentially limiting the opportunities for providers to contribute. Future work should explore the content of discussion in such groups, and the desire for, and effects of, physician involvement.

(P029) Outcomes of Adults Treated with Brain Hypofractionated Stereotactic Radiosurgery in an Established CNS Multidisciplinary Clinic for Radiation Oncology and Neurosurgery

Wencesley Paez, MD¹, Samantha Bowen, BA², Rohi Gheewala, BS³, Brandon Lucke-Wold, MD, PhD⁴, Jeremy Ciporen, MD², Timur Mitin, MD, PhD¹; ¹Department of Radiation Medicine, Oregon Health & Science University, ²Department of Neurological Surgery, Oregon Health & Science University, ³School of Medicine, Oregon Health & Science University, ⁴Department of Neurosurgery, University of Florida

Background: Our multidisciplinary central nervous system (CNS) clinic provides synchronous consultation and follow-up visits with a neurosurgeon and a radiation oncologist at a community hospital center. Hypofractionated stereotactic radiosurgery (hfSRS) is commonly used for management of primary and secondary malignant disease in the brain. A significant challenge in the follow-up of patients treated with hfSRS to brain lesions is to distinguish pseudoprogression (PP) from tumor recurrence (TR) for which treatment and prognosis are different.

Objectives: To determine the rate of tumor control (TC), pseudoprogression (PP) and tumor recurrence (TR) among adult patients with brain primary and secondary malignant disease treated at a multidisciplinary CNS community hospital center clinic with hfSRS.

Methods: We conducted an IRB-approved retrospective review of treatment outcomes for consecutive patients treated with hfSRS for brain tumors between June 2017 and December 2019. Post-treatment

imaging and/or histology when available were reviewed for assessment of treatment response.

Results: Forty-six brain lesions in 18 consecutive patients were treated with hfSRS over a period of 30 months. The rate of tumor control with no evidence of progression or pseudoprogression was 67% (31 out of 46 lesions). Among the remaining 15 lesions, TR was determined in eight lesions for an overall rate of TR of 17% (8 out of 46 lesions). Six lesions (13%) were determined to represent PP. Table 1 summarizes management and outcomes among patients with progressing lesions after hfSRS.

Conclusions: Adult patients with brain primary and secondary malignant disease evaluated and treated in our multidisciplinary CNS clinic have a high rate of disease control in line with previously published results from large academic institutions and multi-institutional clinical trials. The integrated evaluation and management of radiographic progression after hfSRS allows for a nuanced multidisciplinary interpretation of radiographic and clinical findings. Thereby, reducing unnecessary clinical visits, tests, procedures and leading to improved clinical care through prompt systemic, surgical and radiation treatment modalities that minimizes re-treatment of PP and avoids undertreatment of TR.

(P030) American Radium Society's Appropriate Use Criteria on Postoperative Management of Lower Grade Gliomas

Martin Tom, MD¹, Michael Milano, MD, PhD², Scott Soltys, MD³, Arjun Sahgal, MD⁴, Jonathan Knisely, MD⁵, Veronica Chiang, MD⁶, Seema Nagpal, MD³, Simon Lo, MB, ChB, FACR, FASTRO⁷, Samuel Chao, MD⁸, Siavash Jabbari, MD⁹, Tony Wang, MD¹⁰, Joshua Palmer, MD¹¹, Melanie Gephart, MD, MAS³, Amit Garg, MD¹², Manmeet Ahluwalia, MD, MBA¹³, Lia Halasz, MD⁷, Eric Chang, MD¹⁴; ¹Miami Cancer Institute, Baptist Health South Florida, ²University of Rochester, ³Stanford University, ⁴Department of Radiation Oncology, Sunnybrook Odette Cancer Centre, University of Toronto, ⁵Weill Cornell Medicine, ⁶Yale University, ⁷University of Washington, ⁸Cleveland Clinic, ⁹Laurel Amtower Neuro-Oncology Center and Cancer Institute at Sharp Healthcare, ¹⁰Columbia University, ¹¹The Ohio State University Wexner Medical Center, ¹²MD Anderson Cancer Center, ¹³Miami Cancer Institute, ¹⁴University of Southern California Keck School of Medicine

Background: "Lower grade gliomas" refer to WHO grade 2 and 3 gliomas. Their optimal postoperative management remains controversial, especially in light of contemporary prognostic and predictive molecular characteristics which were not available during the design of earlier clinical trials.

Objectives: The American Radium Society (ARS) Appropriate Use Criteria Brain Malignancy Committee sought to develop consensus guidelines for the postoperative management of lower grade gliomas.

Methods: The committee developed 4 key questions regarding: 1) Timing of postoperative therapy (i.e. adjuvant vs. salvage approaches);

TABLE 1. Management and Outcomes Among Patients (n = 8) With Clinical Evidence of Progression After Brain hfSRS

	Histology	Treatment*	Outcomes
Local Recurrence (8)	Oligodendroglioma (1)	A+S	Progressed
	Metastatic NSCLC (1)	C+S	Decreased tumor size
	Metastatic Breast (6)	Gamma knife radiation	Decreased tumor size
Radiation Necrosis (5)	Oligodendroglioma (1)	C+R+A+Tumor treating fields	Decreased tumor size
	Metastatic NSCLC (1)	C+S	Decreased tumor size
	Metastatic NSCLC (2)	C+S+A	Decreased tumor size
	Metastatic SCLC (1)	C	No new growth
Likely Necrosis	Metastatic SCLC (1)	Repeat Imaging	No new growth
Unknown	Metastatic Breast (1)	S+R	Stable

Brain lesions (n = 15) with radiographic evidence of progression after brain hfSRS. *Avastin (A), Steroids (S), Redo-craniotomy (C), Re-irradiation (R).

2) Monotherapy vs. combined modality therapy (i.e. postoperative radiotherapy [RT] vs. chemotherapy vs. chemoradiotherapy); 3) Type of chemotherapy used in conjunction with radiotherapy (i.e. procarbazine, lomustine, and vincristine [PCV] vs. temozolomide [TMZ]); and 4) Radiotherapy dose. The panel systematically reviewed the literature according to the Preferred Reporting Items for Systematic Reviews and Meta-Analyses guidelines, and voted accordingly on the appropriateness of various management options for representative case variants.

Results: The search identified 6,244 studies, of which 38 were included after screening and in-depth review. The committee designed 6 case variants, each consisting of 1-2 subvariants, with emphasis on patient age, patient performance, patient symptomatology, tumor size, tumor location, tumor grade, tumor molecular classification, and extent of resection. Management options included initial observation, adjuvant monotherapy (RT, PCV, or TMZ), adjuvant combined modality therapy (RT with PCV or RT with various combinations of TMZ), various RT doses, and proton therapy. After two rounds of voting, disagreement remained for some treatment options within the case variants. The committee recommended a third round of voting for these scenarios.

Conclusions: Multiple postoperative management options are available for lower grade gliomas, which are heavily influenced by molecular classification and other clinical characteristics. Until recently completed and ongoing clinical trials using updated molecular classification are published, the ARS Brain Malignancy Committee endeavors for this Appropriate Use Criteria document to aid decision making for clinicians. Final voting is underway and will be followed shortly by the consensus guideline.

(P031) Patterns of Care and Treatment Disparities in the Management of Benign Central Nervous System Meningioma

Felicia Lew, DVM¹, Christopher Weil, MD², Calvin Rock, MD², Ryan Kraus, MD², Donald Cannon, MD², Randy Jensen, MD PhD², Lindsay Burt, MD²; ¹Elson S Floyd College of Medicine, ²University of Utah Huntsman Cancer Institute

Background: Observation/active surveillance, surgery and radiotherapy (RT) are all standard of care treatment options in the management of benign central nervous system (CNS) meningioma.

Objectives: In this analysis, we sought to describe the patterns of care in the management of benign CNS meningioma and identify temporal and sociodemographic trends in the utilization of surgery and radiotherapy, including the use of stereotactic radiosurgery (SRS) compared with external beam radiotherapy (EBRT).

Methods: We queried the National Cancer Database (NCDB) to identify all patients with benign meningioma of the CNS diagnosed from 2004 to 2017. Clinical characteristics, demographic information and treatment approaches were analyzed using standard T and χ^2 tests. Predictors of receipt of any treatment and radiotherapy technique were identified with univariable and multivariable logistic regression modeling.

Results: We identified 252,258 patients diagnosed with benign CNS meningioma between 2004 and 2017, of which 133,008 (53%) received no treatment and 119,250 (47%) received either surgery, RT or both. Of the patients who received treatment, 98,611 (83%) had surgery only, 14,556 (12%) received RT and 6,077 (5%) had surgery and RT. Of the patients who received RT, 61% received single- or multi-fraction SRS and 39% received fractionated EBRT. On multivariable analysis, patients were more likely to be observed if they were diagnosed from 2009-2012 (Odds ratio [OR] 0.66, 95% Confidence Interval 0.65-0.68) and 2013-2017 (OR 0.57, 0.55-0.58), had no insurance (OR 0.60, 0.57-0.63), Medicaid (OR 0.71, 0.68-0.74), Medicare (OR 0.50, 0.48-0.51), or a Charlson co-morbidity score of 3+ (0.75, 0.71-0.79). Those more likely to receive treatment were Asian (OR 1.2, 1.1-1.3) or Hispanic-White ethnicity (1.1, 1.03-1.1), from the geographic West (OR 1.2, 1.2-1.3), or treated at an academic/research institution (OR 3.4, 3.24-3.56). Black patients were more likely to receive RT than Whites (OR 1.2, 1.1-1.2) and less likely to receive surgery (OR 0.96, 0.93-0.98). Blacks and Hispanic-Whites were more likely to receive EBRT than SRS compared with Non-Hispanic Whites (OR 1.3, 1.2-1.4, and OR 1.5, 1.3-1.7, respectively). Black patients were also less likely to receive both surgery and RT compared with Whites (OR 0.71, 0.68-0.73), while patients treated at academic/research institutions compared with community hospitals were more likely to receive both (OR 5.8, 4.9-6.4).

Conclusions: Active surveillance as a treatment strategy for CNS meningiomas has been increasing over the past decade, however there are noticeable disparities in which patients receive treatment. At risk populations, including the uninsured and minorities, are less likely to receive treatment and less likely to receive less toxic treatments like SRS. Further evaluation is warranted to address the underlying cause of the inequities.

(P032) Impact of Prior Y90 Dosimetry on Toxicity and Outcomes Following Stereotactic Body Radiation Therapy for Hepatocellular Carcinoma

Shauna Campbell, DO¹, Aditya Juloori, MD², Timothy Smile, MD¹, Danielle LaHurd, PhD¹, Naichang Yu, PhD¹, Neil Woody, MD¹, Kevin Stephans, MD¹; ¹Cleveland Clinic, ²University of Chicago

Background: Stereotactic body radiation therapy (SBRT) is the only non-invasive local therapy for the treatment of hepatocellular carcinoma (HCC) and is often utilized following transarterial embolization. There is a paucity of data reporting safety and outcomes of patients (pts) receiving SBRT after yttrium-90 (Y90).

Objectives: We sought to evaluate the impact of Y90 and SBRT composite plan dosimetry on toxicity and outcomes of HCC pts.

Methods: An IRB-approved registry of 260 liver SBRT pts was used. Pts included in analysis received Y90 before SBRT and had post-Y90 PET imaging (measuring Bremsstrahlung component of Y90). Volume of ablated liver was estimated using the sharp edge of PET gradient and the SBRT volume receiving at least 30 Gy (V30). Characteristics between groups were compared using χ^2 and independent t-test. Clinical, imaging, and laboratory follow up are reported.

Results: Twenty eight pts with median follow up of 14 m (4.6-49.6) were included. Pts received 1 (N=15), 2 (N=10), or 3 (N=3) prior Y90 treatments, to a median volume of 286 cm³ (21-1512) a median 4.4 m (1.1-82.9) before SBRT. SBRT dose ranged from 24-50 Gy in 3-5 fractions with a median PTV of 117 cm³ (26-857). Y90 and V30 overlap ranged from 0-577 cm³ with a median of 80 cm³. Treatment intent was definitive in 23 pts, to downstage within transplant criteria in 4 pts, and as a bridge to transplant in 1 pt. Baseline Child-Pugh (CP) score was A, B, and C in 23, 3, 2 pts, respectively. At a median 9 m (1.5-46.4) after SBRT local control was 93%. Liver, nodal, and distant failure had an incidence of 11%, 3.6%, and 11%, respectively. Change in CP score was analyzed at 1-2 m and 3 m post SBRT. Twenty six patients had at least 1 calculable time point. Change in CP class from A to B was seen in 6 pts (26%), of which two recovered back to CP A by 3 m. The 3 CP B pts did not change class, and the 2 CP C pts received successful liver transplants 2-3 m after SBRT downstaging. Factors associated with an increase in CP score within 3 m of SBRT include SBRT mean liver dose ($P=0.001$), SBRT V30 ($P=0.049$), and <1200 cm³ of un-ablated liver ($P=0.003$). Volume of liver treated by Y90 and time between Y90 and SBRT was not associated with an increase in CP score within 3 m of SBRT. Non-hematologic toxicity include 2 acute biliary stricture (grade 2&3), 1 late biliary stricture (grade 2), 1 late chest wall pain (grade 1), and 1 late grade 2 radiographic myonecrosis. One CP A pt died 4 weeks after SBRT of cardiopulmonary comorbidities.

Conclusions: Time between Y90 and SBRT, volume of liver exposed to prior Y90, and overlap between V30 and Y90 volumes do not appear to adversely impact CP score within 3 m of SBRT. Dosimetric properties including mean liver dose, V30, and un-ablated liver volume <1200 cm³ are associated with an increase in CP score within 3 m of SBRT. Pts with HCC previously treated with Y90 appear to tolerate SBRT well with no clinically significant change in CP score, minimal toxicity, and excellent local control.

(P033) Causes of Death Among Unresectable Non-metastatic Pancreas Cancer Patients Receiving MR-guided SABR

Michael Chuong, MD¹, Roberto Herrera, BS¹, Matthew Hall, MD, MBA¹, Rupesh Kotecha, MD¹, Antonio Ucar, MD², Fernando De Zarraga, MD¹, Santiago Aparo, MD¹, Sarah Joseph, MD¹, Kathryn

Mittauer, PhD¹, Alonso Gutierrez, PhD, MBA¹, Diane Alvarez, MSc¹, Tino Romaguera, DSc¹, James McCullough, DMP¹, Horacio Asbun, MD¹, Ramon Jimenez, MD¹, Raj Narayanan, MD¹, John Bryant, MD², Minesh Mehta, MD FASTRO⁴, Adeel Kaiser, MD¹; ¹Miami Cancer Institute, ²Miami Cancer Institute, ³Moffitt Cancer Center, ⁴Department of Radiation Oncology, Baptist Health South Florida

Background: Nearly all patients with pancreas cancer (Pca) eventually die from progressive disease. It has been shown in autopsy studies that while distant metastases (DM) are a common cause of death from Pca, locoregional (LR) progression may be directly responsible for up to one-third of Pca-related deaths. Magnetic resonance image (MRI)-guided stereotactic ablative body radiation therapy (SABR) is a novel treatment strategy that may improve long-term locoregional control (LRC) and survival (OS) through significant dose intensification.

Objectives: The objective of this study was to describe causes of death in Pca in patients treated with MRI-guided SABR.

Methods: 50 patients with initially non-metastatic adenocarcinoma of the pancreas treated at a single institution on a 0.35T-MR Linac from 2018-2020 were evaluated. Patients had locally-advanced (82%), borderline resectable (8%), or medically inoperable disease (10%). Induction chemotherapy (CT) was routine (94%), usually FOLFIRINOX (58%) or gemcitabine/nab-paclitaxel (26%). Median prescribed dose was 50 Gy (range 40-50) in 5 fractions; median biologically effective dose (BED10) was 100 Gy10. Elective nodal irradiation (ENI) started in early 2019, including a margin around the celiac axis and SMA. Post-SABR therapy included Whipple procedure (14%), irreversible electroporation (10%), and/or CT (52%).

Results: Median follow-up was 18 months (range 7-39 mo) from diagnosis. 24 (48%) patients developed DM; the liver (50%), peritoneum (41.7%), and lung (29.2%) were the most common sites. 27 patients (54%) were dead at time of analysis. Median LRC, DM free survival, and OS were 32, 23, and 21 months, respectively. Causes of death were hepatic failure from DM (14.8%), peritoneal carcinomatosis causing bowel obstruction/large volume ascites (14.8%), unknown (11.1%), abdominal vasculature insufficiency/bleeding not from LRF (11.1%), cholangitis possibly from LRF (7.4%), cachexia/malnutrition (7.4%), head trauma from fall (7.4%), respiratory failure from DM (3.7%), ischemic colitis from LRF (3.7%), GI bleed from LRF (3.7%), intra-abdominal abscess not from LRF (3.7%), pneumonia without DM (3.7%), sepsis (3.7%), and brain metastasis (3.7%).

Conclusions: This is the first comprehensive analysis of causes of death in Pca patients receiving MR-guided SABR. Despite routine induction CT, the predominant cause of death was from progressive liver/peritoneal metastases. Our data suggest that ablative radiation dose may reduce the probability of death potentially from LRF (14.8%) and thereby increase long-term OS compared with historical outcomes using chemotherapy alone or non-ablative doses. Nearly all who died from LRF were treated within the first 6 months of starting our MR-guided SABR program and did not receive ENI; further investigation is needed to better understand whether this or other treatment factors influence the probability of death from LRF and OS.

(P034) Intraoperative Radiation After Pelvic Short Course Radiotherapy for Patients with Locally Advanced Rectal Adenocarcinoma with Involved or Threatened Circumferential Resection Margin

Emma Holliday, MD¹, Zooha Kahn, BS², Michael Rooney, MD³, Prajnan Das, MD MS MPH⁴, George Chang, MD³, Oliver Peacock, MD³, Gabriel Sawakuchi, PhD³, Ethan Ludmir, MD¹, Eugene Koay, MD PhD⁴, Grace Smith, MD MPH¹, Cullen Taniguchi, MD PhD⁴, Bruce Minsky, MD¹, Albert Koong, MD, PhD¹; ¹MD Anderson Cancer Center, ²University of Texas Rio Grande Valley School of Medicine, ³University of Texas MD Anderson Cancer Center, ⁴MD Anderson

Background: Recent trials have shown short course radiotherapy (SCRT) delivered as a component of total neoadjuvant therapy can improve disease-free and overall survival for patients with high risk locally advanced rectal cancer (LARC). However, patients with tumors that involve or threaten the circumferential resection margin (CRM) still have a high risk of local recurrence. Intraoperative radiotherapy (IORT)

enables delivery of additional radiation to the margin of concern at the time of surgery and may help to mitigate local recurrent risk.

Objectives: Our objectives were to evaluate outcomes for patients with LARC who received IORT after SCRT-based neoadjuvant therapy and analyzed radiation toxicity, operative complications and disease control.

Methods: Patients with LARC who were treated with preoperative SCRT and IORT were identified. All patients had a preoperative magnetic resonance imaging exam showing a threatened (<2 mm) or involved CRM. SCRT consistent of 25 Gray in five fractions and was delivered as part of a multimodality preoperative regimen. IORT dose ranged from 10-15 Gy and was delivered with high dose rate (HDR) brachytherapy. Patient charts were reviewed and information regarding demographics, tumor staging, treatment details, radiation toxicities, post-operative complications and oncologic outcomes were recorded.

Results: A total of 10 patients with LARC were identified who received SCRT-based neoadjuvant treatment and IORT. Seven patients had involved CRM (<1 mm), and three had threatened CRM (1-2 mm). Four patients received SCRT followed by consolidative chemotherapy and six received SCRT sandwiched between induction and consolidative chemotherapy. Five patients experienced G2+ toxicity during the time-period spanning the start of SCRT to six weeks after SCRT completion. Five patients underwent low anterior resection, one underwent abdominoperineal resection and four underwent pelvic exenteration. No patient had a pathologic complete response, but two patients had minimal residual disease with a tumor regression grade of 1 and <10% viable tumor. Six patients had negative surgical margins (>2 mm); one patient had a close margin of 2 mm, and three patients had involved radial margins (R1). The median [IQR] length of hospitalization after surgery was 11 [7-14] days, three patients required readmission and two patients required reoperation due to complications including anastomotic leak and abscess. With a median follow up of 19.5 months, no patient developed a pelvic recurrence. Six patients developed distant recurrences; three were in the lung, two were in the liver and one was in the peritoneum. One patient died with distant recurrence 18 months after treatment.

Conclusions: The use of IORT after SCRT-based neoadjuvant therapy is safe and feasible. In our series of 10 high risk patients, none developed pelvic recurrences. Further data are needed to determine whether the addition of intraoperative radiation improves local recurrence rates over preoperative radiation alone.

(P035) Predictive Accuracy of Digital Rectal Exam Following Chemoradiation in Rectal Cancer

Moataz El-Ghamry, MD¹, Garrett Jensen, MD², Tyson Amundsen, MD¹; ¹Baylor Scott and White, ²Baylor Scott & White

Background: Watch and wait (W&W) after complete or major response to neoadjuvant chemoradiotherapy (CRT) has been proposed as an alternative to radical resection in early stage rectal cancer. The utility of assessing response by magnetic resonance imaging (MRI) is an area of controversy. The accuracy of digital rectal examination (DRE) in predicting pathologic response has seldom been investigated. **Objectives:** We conducted a retrospective analysis to assess the predictive accuracy of MRI and DRE following neoadjuvant CRT with regard to pathologic complete response (CR).

Methods: From 2015-2020, 28 patients were retrospectively identified that met our studies inclusion criteria. Each was treated with neoadjuvant CRT followed by surgery for rectal cancer. Each had a palpable lesion assessed by DRE before and after CRT, followed by surgery, was performed by a senior radiation oncologist.

Results: Clinical T stage of patients was T2, 3 and 4 in 11, 79 and 11%, respectively. Clinical N stage of patients was N0, 1, and 2 in 36, 50, and 7%, respectively. Surgical procedure performed was low anterior resection, abdominal perineal resection, or transanal excision in 10 (35%), 12 (43%), and 6 (21%), respectively. Pathology demonstrated a CR in 8 (29%) patients. Median RT dose was 5400 cGy (range 4140-5400 cGy). Correlation between DRE and pathological response was significant ($P=0.0019$). In 11 (39%) patients with a CR on DRE, pathology showed CR in 7 (64%) patients, and a partial response with <1 cm of residual tumor in 2 (18%) patients. Correlation between MRI and pathological response was not significant ($P=0.2805$). In 5 (19%) patients with a CR on MRI,

pathology showed CR in 3 (60%) patients. Of 4 patients with a CR on both MRI and DRE, 3 (75%) had a pathological CR.

Conclusions: A DRE performed by an experienced physician before and after CRT has higher accuracy than MRI in detecting CR. DRE, in addition to MRI, may help better identify patients with rectal cancer who are candidates for a W&W approach.

(P036) Magnetic Resonance-guided Adaptive Radiation Therapy for Treatment of Locally-recurrent Pancreatic Adenocarcinoma

Kylie Kang, MD¹, John Lattin, BS², Joshua Schiff, MD³, Olga Green, PhD³, Alex Price, MS³, Deshan Yang, PhD³, William Hawkins, MD³, Ryan Fields, MD³, Pamela Samson, MD, MPH¹, Shahed Badiyan, MD³, Lauren Henke, MD, MSCI⁴, Hyun Kim, MD³; ¹Department of Radiation Oncology, Washington University School of Medicine in St. Louis, ²St. Louis University School of Medicine, ³Washington University School of Medicine, ⁴henke.lauren@wustl.edu

Background: There are limited treatment options for locally recurrent pancreatic adenocarcinoma, especially after prior resection or radiation therapy. The use of magnetic resonance (MR)-guided adaptive radiation therapy (MRgART) has been reported for the treatment of inoperable pancreatic adenocarcinoma, but there is a paucity of data on its application in locally recurrent cases.

Objectives: We aim to report on our institutional experience with MRgART for treatment of locally-recurrent pancreatic adenocarcinoma. **Methods:** Eighteen patients with locally recurrent pancreatic adenocarcinoma were treated at our institution between 2015-2019 with MRgART. Demographic and treatment-related characteristics were collected from the institutional electronic medical record and treatment planning system. Kaplan-Meier with log-rank analysis was conducted, with statistical significance defined as $P < .05$.

Results: Median time from diagnosis to first local failure (LF) was 17.8 months (range: 6.4 - 56.6 mo). Six patients had definitive fractionated chemoradiation before their local recurrence to a median dose of 52.2 Gy (range: 45 - 55 Gy). Salvage MRgART was delivered to a median of 50 Gy (BED10 = 100 Gy; range: 50 - 67.5 Gy) for radiation-naïve patients and a median of 32.5 Gy (BED10 = 53.6 Gy; range: 25 - 50 Gy) for those who had received prior radiation; two patients did not receive salvage MRgART at first LF (had salvage chemotherapy alone) but underwent MRgART at subsequent progression. Aside from one salvage regimen of 67.5 Gy over 15 fractions, all patients received salvage MRgART over five fractions. Median planning target volume (PTV) was 132.6 cc (range: 16.2 - 292.3 cc). The most common organs at risk requiring adaptation were small bowel and stomach, with 67% of cases requiring adaptation for every fraction. Median overall survival from time of diagnosis was 34.7 months; median survival after salvage MRgART was 8.7 months. One- and three-year local control rates were both 66%, and one- and three-year overall survival rates were 78% and 18%, respectively. There was no association between local control post-MRgART or overall survival and PTV, BED10, or receipt of salvage chemotherapy.

Conclusions: Locally recurrent pancreatic adenocarcinoma can be treated with MRgART with acceptable local control rates, even in cases of prior definitive chemoradiation. MRgART was utilized for every fraction in the majority of cases and allowed for plan adjustments to meet luminal OAR constraints.

(P037) Stereotactic MRI-guided Adaptive Radiation Therapy for Non-metastatic Pancreatic Cancer; Outcomes and Toxicity Analysis for Patients Treated in an Underserved Urban Center

Celina Kirsch, PAC¹, Eric Schaff, MD², Parag Parikh, MD², Benjamin Movsas, MD³, Farzan Siddiqui, MD, PhD, CPE³, David Kwon, MD², Pin Li, PhD², Gazala Khan, MD², Rupen Shah, MD²; ¹Henry Ford Cancer Institute, ²Henry Ford Health System, ³Department of Radiation Oncology, Henry Ford Cancer Institute

Background: Stereotactic MRI-guided Adaptive Radiation Therapy (SMART) is an emerging technology for treatment of pancreatic cancer patients. Initial results show favorable survival and toxicity. However,

data is still sparse overall, and especially in underserved patient populations. The purpose of this study is to review SMART outcomes at our underserved urban academic cancer.

Objectives: Stereotactic MRI-guided Adaptive Radiation Therapy (SMART) is an emerging technology for treatment of pancreatic cancer patients. Initial results show favorable survival and toxicity. However, data is still sparse overall, and especially in underserved patient populations. The purpose of this study is to review SMART outcomes at our underserved urban academic cancer.

Methods: In this IRB approved retrospective chart review we reviewed 98 patients with non-metastatic pancreatic cancer, who completed SMART between November 2018-January 2021. All 98 patients were treated with 50 Gy in 5 daily fractions with adaptive technique as deemed appropriate by treating radiation oncologist. The primary endpoints were overall survival (OS), progression free survival (PFS), and both acute and late grade 3+ GI toxicity. OS, PFS, locoregional control and distant control were estimated by Kaplan-Meier method and compared using log-rank test. The effect of clinical features on OS was assessed using univariate and multivariate Cox proportional hazard models. OS and PFS were calculated from completion of radiation. Grade 3+ GI toxicity probably or definitively related to radiation was recorded. All incidences of GI bleeding, regardless of attribution, were also recorded.

Results: Median follow up was 20.9 months from time of diagnosis and 14 months from radiation. 21 (21%) patients were borderline resectable, 42 (43%) locally advanced, 22 (22%) medically inoperable and 13 (13%) resectable. Neoadjuvant chemotherapy was given to 86 (88%) patients with a median of 3.5 months of chemotherapy (range 1-12), leaving 11 (12%) patients who did not have systemic chemotherapy. Median overall survival from radiation for the whole group was 15.7 months, and 1-year OS was 58%. There was a statistically significant worsening of overall survival from diagnosis between ECOG 2+ and ECOG 0/1 patients (HR 1.94, 1.05-3.57). 27 (27%) patients went on to have surgical resection with 23 (82%) having R0 resection, and 3 (11%) have an R1 resection. Improved OS was seen in patients with surgical resection (HR 0.06, 0.02-0.23). Acute grade 3+ GI toxicity from radiation was seen in 4 (4%) patients and late toxicity from radiation was seen in 6 (6%) patients. GI bleeding was seen in 16 (16%) patients, 10 (62%) of which were on anticoagulation at the time of GI bleed and 5 (19%) of which had surgery. Portal vein complications occurred with 7 (7%) having portal vein thrombosis and 6 (6%) portal vein stenosis.

Conclusions: SMART showed durable responses in pancreatic cancer patients with an acceptable toxicity profile. Attention needs to be paid to the moderate incident of GI bleeding, however further work is necessary to determine if bleeding was due to radiation, surgery, or disease progression. Surgical resection as well as performance status of ECOG 0-1 were associated with improved overall survival. Further follow up will be necessary to determine further durability of treatment response and long-term survival in these patients.

(P038) Outcomes of MR-guided Stereotactic Body Radiotherapy (SBRT) or yttrium-90 Transarterial Radioembolization for Hepatocellular Carcinoma Treated at an Urban Liver Transplant Center

Evan Liang, MD¹, Garret Greer, MD¹, Charlotte Burmeister, MS¹, Peter Massa, MD¹, Jadranka Dragovic, MD¹, Parag Parikh, MD¹; ¹Henry Ford Health System

Background: There are overlapping indications for both stereotactic body radiotherapy (SBRT) and yttrium-90 (Y90) trans-arterial radioembolization as locoregional treatments for hepatocellular cancer, though most centers preferentially use one modality over the other. MR-guided radiation allows both effective on-table localization and integrated motion management as compared with many traditional linear accelerators, allowing SBRT to be done more easily. Y90 radioembolization has been a well-established modality to deliver highly conformal dose due to the localization of the microspheres to the vascular supply of a tumor. We looked at patient characteristics and treatment outcomes for patients receiving MR-guided SBRT or Y90 at an urban transplant center.

Objectives: To compare patient characteristics and treatment outcomes of MR-guided SBRT with Y90 transarterial radioembolization in a liver transplant center.

Methods: This retrospective single-institution study analyzed patients with HCC treated with SBRT or Y90 from August 2017 to September 2020. To select a patient population eligible for either treatment modality, any Y90 procedures for lesions > 10 cm or for treatment volumes > 1000 cc were omitted from the cohort. A total of 239 patients were included in the analysis, receiving a total of 98 courses of SBRT and 187 courses of Y90 treatment. Local control (LC), freedom from liver progression (FFLP), and overall survival (OS) rates were measured from treatment completion date to death date or last follow-up. All outcomes were censored at time of loss to follow-up; LC and FFLP were censored at time of liver transplant if applicable. Cox regression models were used for survival, with significant factors on the univariate analysis further analyzed with a multivariate model.

Results: Median time to follow-up was 11 months (0-44 mo). The mean size of lesions treated with SBRT were smaller than those treated with Y90 (2.7 cm vs 4.3 cm, $P < 0.01$). The groups of patients differed in liver disease characteristics, with SBRT patients having fewer Child-Pugh A disease (62% vs 80%, $P < 0.01$), more having received locoregional treatments to the liver in the past (81% vs 35%, $P < 0.01$), and more disease in previously treated liver (57% vs 25%, $P < 0.01$). Dose of radiation for SBRT was 45-50 Gy administered in 5 fractions; dose of Y90 radiation to tumor was prescribed to a median of 235.2 Gy (range 55.8-512.3 Gy). There was a higher rate of one year LC in the SBRT cohort (77% vs 57%, $P < 0.01$), while median FFLP (9 mo vs 8 mo, $P = NS$) and median OS were not significantly different (24 mo vs 21 mo, $P = NS$). Multivariate analysis revealed size of largest lesion ($P < 0.01$) was correlated with decreased local control; a 1 cm increase in tumor size was associated with a 25% increased risk of local failure. Subsequent transplant ($P < 0.01$) was the remaining significant factor. Treatment modality did not remain an independent predictor of LC. Predictors of OS in multivariate analysis included age ($P = 0.01$), prior liver treatments (HR 2.86, $P < 0.01$), size of largest lesion ($P < 0.01$), Child-Pugh stage ($P < 0.01$), portal vein thrombosis (HR 1.6, $P = 0.04$), and subsequent liver transplant (HR 0.08, $P < 0.01$).

Conclusions: These findings support the effectiveness of both MR-guided SBRT and Y90 transarterial radioembolization in locoregional management of HCC at a single institution despite clear differences in the patient cohorts. Though survival outcomes were comparable, local control differences favored the cohort treated by SBRT, in large part due to differences in tumor size. This data supports further investigation in a randomized study between SBRT and Y90.

Health Morsani College of Medicine, ²Department of Medical Oncology, H. Lee Moffitt Cancer Center & Research Institute, ³Department of Radiation Oncology, H. Lee Moffitt Cancer Center & Research Institute, ⁴Department of Surgical Oncology, H. Lee Moffitt Cancer Center and Research Institute

Background: In the concurrent chemoradiation (CRT) setting, maximum standard uptake value (SUVmax) on PET/CT has been less prognostically predictive than other metabolic parameters. The CALGB 80803 trial evaluated SUVmax response as a surrogate marker to guide treatment decisions in the induction chemotherapy (IC) setting. As the SUVmax only measures the most metabolically active voxels of tumor, it overlooks volumetric change.

Objectives: To determine if integrating metabolic tumor volume (MTV) and Total Lesion Glycolysis (TLG) into post-IC assessment better predict treatment response before concurrent chemoradiation (CRT).

Methods: We identified sequential clinical stage III and IV (by virtue of non-regional adenopathy) EC patients treated with Folinic acid, Fluorouracil, and Oxaliplatin (FOLFOX) IC with pre and post IC PET/CT performed at our institution before CRT to 50.4 Gy. SUVmax was evaluated on these scans to assess response. As per the CALGB trial, those with SUVmax decline of $\geq 35\%$ in the primary tumor were classified as responders while those $< 35\%$ were non-responders. Analysis of initial and post IC scans manually imported into Mirada software was performed to identify additional metabolic parameters at different thresholds including the TLG and MTV.

Results: Between 2017 and 2019, we identified 15 patients, 11 males (73.3%) and 4 females (26.7%), treated with induction FOLFOX (median age 67 and median initial stage III). The majority of tumors were adenocarcinomas (80%, $n = 12$) and in the distal esophagus/gastroesophageal junction (73.3%, $n = 11$). Responders showed the greatest difference in TLG compared with MTV at all thresholds (21.7% difference in median TLG reduction at variable, 18.8% at 2.5, and 24.5% at 4.0, compared with 27% difference in median MTV reduction at variable, 22.9% at 2.5, and 24.7% at 4.0), with all those initial TLG > 260 exhibiting response. The median reduction in SUVmax was 42.0% (Range: -7.1-92.5%, Interquartile Range: 28.2-73.2%). With a median follow up of 2.5 years (range 1.97-3.96 y) 10 (66.7%) patients remain alive at this time with a crude median survival of 2.42 (range 1.97-3.96) years, while 5 (33.3%) patients are deceased with a crude median survival of 1.60 (range 0.59-2.45) years from diagnosis. 8 (53.3%) patients have remained free of progression, recurrence, or metastasis and one (6.7%) patient experienced recurrence but was successfully treated. Survivors had a median TLG reduction of 98.3% at variable threshold, 90.1% at 2.5, and 96.6% at 4.0.

Conclusions: TLG parameters may be used for additional prognostic value in the locally advanced EC setting to determine extent of tumor response to IC. Further prospective study of additional metabolic parameters on pre and post IC imaging is warranted (Figs. 1 and 2).

(P039) Induction Chemotherapy for Locally Advanced Esophageal Cancer: Can Additional PET/CT Parameters Influence Patient Selection?

Jordan McDonald, BS¹, Rutika Mehta, MD, MPH², Anupam Rishi, MD³, Austin Sim, MD, JD³, Kutjim Latifi, PhD³, Jessica Frakes, MD³, Jose Pimiento, MD⁴, Jacques Fontaine, MD⁴, Sarah Hoffe, MD³; ¹USF

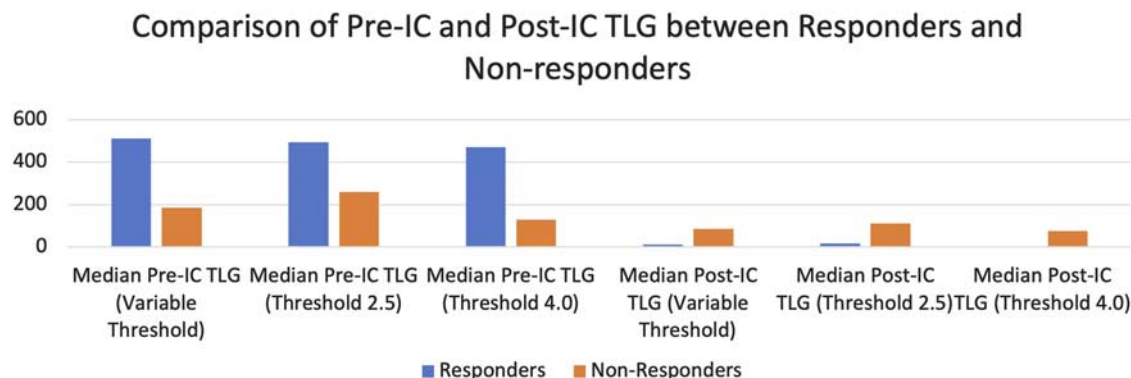

FIGURE 1. Larger change in median pre and post IC TLG values among responders vs. non-responders at all thresholds.

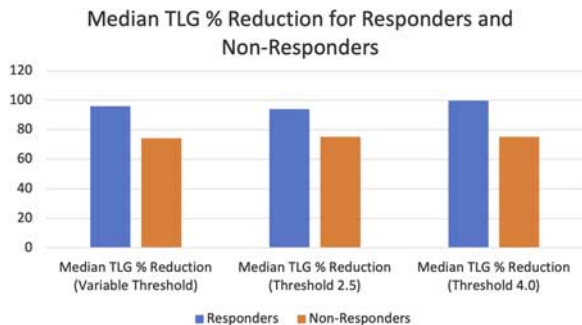

FIGURE 2. Percent reduction in TLG is increased in responders vs. non-responders at all thresholds.

(P040) Validation of the Neoadjuvant Rectal Cancer (NAR) Scores for Prognostication Following Total Neoadjuvant Therapy (TNT) for Locally Advanced Rectal Cancer

April Metzger, MD¹, Stephen Abel, DO¹, Alexander Kirichenko, MD, PhD¹, James McCormick, DO¹, Dulabh Monga, MD¹, Rodney Wegner, MD¹; ¹Allegheny Health Network

Background: The neoadjuvant rectal cancer (NAR) score is a prognostic tool for locally advanced rectal cancer treated with total neoadjuvant therapy (Valentini V, et. al. J Clin Oncol 2011). It has been previously validated as an endpoint that predicts survival more accurately than pathologic complete response (pCR) (Raissouni S, et. al. J Clin Oncol 2014) and is the primary endpoint of the ongoing NRG-GI002 Phase II trial. The score uses the variables of clinical tumor stage, pathologic tumor stage, and pathologic nodal stage which are commonly available, furthering its utility in the clinical setting.

Objectives: Using the National Cancer Database (NCDB) we aimed to validate the NAR score’s ability to predict survival in a large hospital based dataset.

Methods: We queried the NCDB from 2004-2014 to identify all stage II and III rectal cancer patients that received total neoadjuvant therapy (TNT) followed by surgical resection. Selection for patients receiving TNT included receipt of preoperative multi-agent chemotherapy and radiation. Patients were excluded if they had non-adenocarcinoma histology, unknown clinical or pathologic staging, less than 6 months of follow up, and positive margins. Overall survival (OS) was calculated using Kaplan-Meier curves evaluating NAR score and pCR separately. A multivariable Cox proportional hazards model was used to identify factors associated with survival. Multivariate regression was used to evaluate characteristics associated with a favorable (< 15) NAR score.

Results: Our final patient cohort yielded 209 patients for analysis with a median age of 62. The median follow up time was 43.8 months (Range: 7.1–135.3 mo). Factors associated with worse survival included age > 62 years old (P=0.046), lower income (P=0.03), and unfavorable (≥ 15) NAR score (P=0.04). Comorbid score, CEA level, race, lymphovascular invasion, perineural invasion, and insurance status did not predict for survival. On multivariate regression, tumors with perineural invasion and a higher comorbidity score (> 1) were less likely to have a favorable NAR response (P=0.0093 and P=0.0117). Of note, pCR was not associated with improved survival (P=0.0949).

Conclusions: This NCDB analysis further validates the utility of the NAR score as a prognostic tool in patients receiving TNT for locally advanced rectal cancer. Tumors with perineural invasion and patients with a higher comorbidity score had worse NAR scores.

$$NAR = \frac{[5 pN - 3(cT - pT) + 12]^2}{9.61}$$

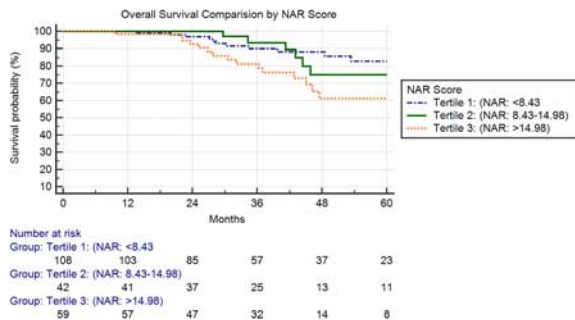

(P041) The Implications of Treatment Delays in Adjuvant Therapy for Resected Cholangiocarcinoma Patients

Matthew Parsons, MD¹, Shane Lloyd, MD², Skyler Johnson, MD³, Courtney Scaife, MD¹, Robin Kim, MD², Rebecca Kim, MD MPH², Heloisa Soares, MD PhD², Ignacio Garrido-Laguna, MD PhD², Randa Tao, MD³; ¹University of Utah Huntsman Cancer Institute, ²University of Utah, Huntsman Cancer Institute, ³Huntsman Cancer Institute at the University of Utah

Background: The role of timing of adjuvant therapy in the setting of CCA has not yet been studied. The BILCAP study initially required patients to start adjuvant therapy within 8 weeks of surgery, however the protocol was later adjusted to allow initiation within 12 weeks and later extended again to 16 weeks. The SWOG trial required enrollment

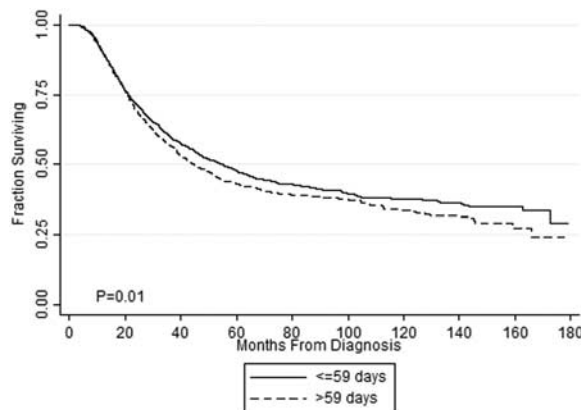

FIGURE 1. Fifteen-year overall survival for patients who were treated before and after various time points. Data are shown for patients treated before and after 59 days (the median).

TABLE 1. Predictors of Initiation of Adjuvant Therapy Within the First Half of Patients (≤ 59 d) Assessed by Multivariable Analysis

	Odds Ratio	Standard Error	z-score	P>z	95% Confidence Interval	
Treatment Modality						
Radiation alone	Reference					
Chemotherapy alone	0.64	0.08	-3.38	<0.01	0.50	0.83
Chemoradiation	0.58	0.07	-4.23	<0.01	0.45	0.74
Insurance Status						
Private Insurance	Reference					
No Insurance	1.20	0.17	1.28	0.20	0.91	1.58
Medicaid	1.16	0.11	1.53	0.13	0.96	1.40
Medicare	1.05	0.07	0.67	0.50	0.92	1.19
Tumor Size						
2 cm or Less	Reference					
2.1 cm to 5 cm	0.95	0.05	-0.97	0.33	0.86	1.05
5cm or greater	0.76	0.06	-3.22	<0.01	0.65	0.90
Unknown	0.86	0.07	-1.95	0.05	0.73	1.00
Race						
White	Reference					
Black	1.20	0.10	2.15	0.03	1.02	1.42
Hispanic	1.23	0.11	2.37	0.02	1.04	1.46
Other	0.99	0.09	-0.13	0.90	0.82	1.19
Age						
≤ 65 years	Reference					
>65 years	1.23	0.08	3.21	<0.01	1.08	1.40

within 8 weeks. However, the impact of these time points has not been formally analyzed. With the emergence of COVID-19 delaying therapy for a number of oncology patients, we set out to evaluate factors associated with delays in the initiation of adjuvant therapy for CCA as well as the impact of these delays on survival outcomes.

Objectives: To understand factors associated with timing of adjuvant therapy for cholangiocarcinoma and the impact of delays on overall survival (OS).

Methods: Data from the National Cancer Database (NCDB) for patients with non-metastatic bile duct cancer from 2004 to 2015 were analyzed. Patients were included only if they underwent surgery and adjuvant chemotherapy and/or radiotherapy (RT). Patients who underwent neoadjuvant therapy or palliative treatments were excluded. Pearson’s χ^2 test and multivariate logistic regression analyses were used to assess the distribution of demographic, clinical, and treatment factors. After propensity-score matching with inverse probability of treatment weighting, OS was compared between patients initiating therapy past various time points using Kaplan Meier analyses and doubly-robust estimation with multivariate Cox proportional hazards modeling.

Results: In total, 7,733 of 17,363 (45%) patients underwent adjuvant treatment. The median time to initiation of adjuvant therapy was 59 days (interquartile range 45-78 d). Age over 65, black and Hispanic race, and treatment with RT alone were among the factors associated with later initiation of adjuvant treatment (Table 1). Patients with larger tumors and high grade disease were more likely to initiate treatment early. After propensity score weighting, there was an OS decrement to initiation of treatment beyond the median of 59 days after surgery (Fig. 1).

Conclusions: We identified patient and disease characteristics that are related to the timing of adjuvant therapy in patients with biliary cancers. Troublingly, there are racial disparities associated with the timely initiation of adjuvant therapy. There was an OS decrement associated with delays beyond the median time point of 59 days. This finding may be especially relevant given the treatment delays seen as a result of COVID-19.

(P042) Surgery After Neoadjuvant Stereotactic MRI Guided Adaptive Radiation in Pancreatic Cancer: Multi-institutional Toxicity and Survival Outcomes

Eric Schaff, MD¹, Celina Kirsch, PAC¹, Parag Parikh, MD¹, Michael Chuong, MD², Roberto Herrera, BS², Horacio Asbun, MD², Ramon Jimenez, MD², Farzan Siddiqui, MD, PhD, CPE³, Gazala Khan, MD¹, Santiago Aparo, MD², Fernando De Zarraga, MD², Antonio Ucar, MD⁴, Rupen Shah, MD¹, Pin Li, PhD¹, Benjamin Movsas, MD³, David

Kwon, MD¹; ¹Henry Ford Health System, ²Miami Cancer Institute, ³Department of Radiation Oncology, Henry Ford Cancer Institute, ⁴Miami Cancer Institute

Background: Favorable toxicity and survival outcomes after dose escalated stereotactic MR guided adaptive radiation therapy (SMART) have been recently published for locally advanced (LA) and borderline resectable (BR) pancreatic cancer. Perioperative morbidity and mortality are not well understood after ablative radiation therapy, which may temper enthusiasm for offering surgery.

Objectives: The purpose of this study was to investigate survival and toxicity in resected pancreas cancer patients after neoadjuvant ablative SMART.

Methods: In this IRB approved analysis, we retrospectively reviewed 33 consecutive patients with resectable, BR, and LA pancreatic cancer based on NCCN 2.2021 staging criteria who were treated at 2 institutions from 2017-2020 with neoadjuvant SMART 50 Gy in 5 fractions on a 0.35T MR Linac and later underwent definitive surgical resection. Overall survival (OS) and locoregional control (LRC) were evaluated by Kaplan-Meier method.

Results: Median follow up was 22.4 months from diagnosis and 17.8 months from last day of RT. Most had BR (55%), otherwise initially resectable (33%) or LA (12%) pancreatic cancer. Median duration of induction chemotherapy was 3.5 (SD 1.6) months with most common regimens being FOLFIRINOX (74%), gemcitabine/abraxane (24%) and FOLFOX (3%). Performance status was ECOG 0, 1, 2 in 16 (48.5%), 12 (36.4%), and 5 (15.2%), respectively. Whipple was performed in 27 (82%) of patients, distal pancreatectomy in 4 (12%), and total pancreatectomy in 2 (6%). The median duration from SMART completion to surgery was 6.9 weeks (4.7-44.1). R0 resections were achieved in 28 (84.8%) of patients with the rest being R1, all in BR patients. Vascular resection/reconstruction was performed of the portal vein (PV) in 8 (24.2%) patients, SMV in 4 (12%), SMA in 1 (3%), and common hepatic artery in 2 (6%). Vascular resection/reconstruction was performed in all LA patients. Median OS, 1-year OS, and 2-year OS from diagnosis were 29.6 months, 93.8%, 81.5%, respectively. Median OS from RT was not yet reached; 1-year OS was 90.9%. LRC at 1 and 2 years was 97% and 93%, respectively. Radiation related acute and late grade 3+ gastrointestinal toxicity was seen in 2 (6%) and 2 (6%) patients. Post-op mortality at 30 and 90 days was seen 2 (6%) and 3 (9%) of patients with 1 death from GI bleed attributed to surgery and 1 death from hepatic ischemia related to PV resection.

Conclusions: To the best of our knowledge, this is the first report suggesting that surgery for pancreas cancer after dose escalated 5-fraction SMART is feasible. Further clarification is needed with respect to ideal patient selection and timing for surgery, the safety of arterial versus venous resection/reconstruction, and histopathologic response after delivery of ablative versus non-ablative radiation dose.

(P043) Executive Summary of the American Radium Society™ (ARS) Appropriate Use Criteria (AUC) for Locoregional Gastric Adenocarcinoma: Systematic Review and Guidelines

Leila Tchelebi, MD¹, Rachit Kumar, MD², Navesh Sharma, DO, PhD³, Christopher Anker, MD⁴, Joseph Herman, MD⁵, Karyn Goodman, MD⁶, William Jones, MD⁷, Nelson Yee, MD³, Madappa Kundranda, MD, PhD², Timothy Kennedy, MD, MBA⁸, Percy Lee, MD⁹, Suzanne Russo, MD¹⁰, William Small, MD, FACRO, FACR, FASTRO¹¹, Warren Suh, MD¹², Salma Jabbar, MD⁸; ¹PennState Health, ²Banner MD Anderson Cancer Center, ³Penn State Health, ⁴University of Vermont, ⁵Northwell Health, ⁶Icahn School of Medicine Mount Sinai, ⁷University of Texas Health Science Center at San Antonio, ⁸Rutgers Cancer Institute of New Jersey, Robert Wood Johnson Medical School, Rutgers University, ⁹University of Texas MD Anderson Cancer Center, ¹⁰Case Western Reserve University School of Medicine and University Hospitals, ¹¹Loyola University Chicago, Stritch School of Medicine, Cardinal Bernardin Cancer Center, ¹²University of California at Los Angeles, Ridley-Tree Cancer Center

Background: Gastric cancer is a leading cause of cancer mortality worldwide. Most patients present with locally advanced or advanced disease for which multi-modal therapy is often indicated.

Objectives: To systematically evaluate data regarding the use of neoadjuvant, peri-operative, surgical and adjuvant treatment options in patients with operable or inoperable gastric cancer and to develop Appropriate Use Criteria (AUC) recommended by a panel of gastrointestinal oncology experts convened by the American Radium Society (ARS). In particular, the role for radiation therapy in the management of these patients was specifically addressed.

Methods: Preferred Reporting Items for Systematic reviews and Meta-Analyses (PRISMA) methodology was used to develop an extensive analysis of peer-reviewed phase 2/2R/3 trials as well as meta-analyses found within the Ovid Medline database between 2010 to 2020. These studies were used to inform the expert panel, which then rated the appropriateness of various treatments in 5 broadly representative clinical scenarios through a well-established consensus methodology (modified Delphi).

Results: For patients with medically operable locally advanced gastric cancer, the strongest recommendation was for peri-operative chemotherapy based on high quality data. Acceptable alternatives included surgery followed by either chemotherapy or concurrent chemoradiotherapy (CRT). For patients with upfront resection of stage I-III gastric cancer (no neoadjuvant therapy), the group strongly recommended adjuvant therapy with either chemotherapy alone or CRT, based on high quality data. For patients with locally advanced disease who received pre-operative chemotherapy without tumor regression, the group strongly recommended postoperative chemotherapy or post-operative CRT. Finally, for medically inoperable gastric cancer patients, there was moderate consensus recommending definitive concurrent CRT. In cases when the group endorsed radiation therapy, the suggested radiation doses and target volumes varied based on the clinical scenario. The most agreed upon dose/fractionation schedule was 45-46 Gray in 25-26 fractions for adjuvant radiation and 50-50.4 Gray in 25-28 fractions for definitive radiation.

Conclusions: Patients with gastric cancer are at high risk of both locoregional and distant relapse (49%) after surgery alone. The addition of chemotherapy and/or radiation, either in the neoadjuvant, adjuvant, or perioperative setting, result in improved survival rates for patients. For inoperable patients, definitive CRT is a reasonable treatment option, though largely palliative. Radiation planning for gastric cancer requires multiple detailed considerations including primary tumor location within the stomach and the location of draining, regional lymph nodes.

(P044) Sarcopenia and Abdominal Fat Distribution Are Prognostic for Overall Survival in Patients with Unresectable Pancreatic Cancer Undergoing Stereotactic Body Radiotherapy

Yufan (Fred) Wu, MD¹, Chika Nwachukwu, MD, PhD², Diego Toesca, MD¹, Yufei Liu, MD PhD³, Amanda Koong¹, Rie von Eyben, MS¹, Albert Koong, MD, PhD⁴, Daniel Chang, MD¹; ¹Stanford University, ²UT Southwestern Medical Center, ³University of Texas MD Anderson Cancer Center, ⁴MD Anderson

Background: Various measures of body composition have been shown to have predictive value on clinical outcomes in cancer. Sarcopenia and abdominal fat distribution (specifically the amount of visceral fat relative to subcutaneous fat) are two such measures which can be easily assessed via computed tomography (CT) scan and have been shown to be negatively correlated with survival outcomes in gastrointestinal malignancies.

Objectives: The purpose of this study is to evaluate the prognostic value of sarcopenia as well as the distribution between visceral fat and subcutaneous fat on overall survival (OS) in patients with unresectable pancreatic cancer (PC) undergoing stereotactic body radiotherapy (SBRT).

Methods: A retrospective analysis was conducted of all patients treated with definitive SBRT for unresectable PC between 2001 and 2015 at our institution. Data from pretreatment abdominal CT scans, patient/tumor characteristics, and outcomes were collected. Sarcopenia was quantified by measuring the total psoas area and total muscle area at a single axial CT slice at the mid-third lumbar vertebral body. Abdominal fat distribution was assessed at the same CT slice using visceral fat area (VFA) and subcutaneous fat area (SFA). These CT structures were

TABLE 1. Patient and Treatment Characteristics

Patient characteristic (unit)	Value
Age at diagnosis (years, standard deviation)	68.1 (12.4)
Sex (n)	
Female	94 (48%)
Male	102 (52%)
Resectability (n)	
Unresectable	157 (80%)
Medically inoperable	23 (12%)
Borderline resectable	14 (7%)
Decline	2 (1%)
KPS (n)	
50-60	8 (4%)
70-80	74 (38%)
90-100	94 (48%)
Unknown	20 (10%)
Sarcopenic patients (n)	147 (75%)
Elevated VFA patients (n)	85 (43%)
Body mass index (n)	
Underweight, <18.5 kg/m ²	10 (5%)
Normal, 18.5-24.9 kg/m ²	96 (49%)
Overweight/Obese, ≥25 kg/m ²	90 (46%)
Albumin (g/dL, standard deviation)	3.34 (0.56)
Radiation dose & fractionation (n)	
25 Gy in 1 fraction	88 (45%)
25-33 Gy in 5 fractions	84 (43%)
35-45 Gy in 5 fractions	24 (12%)
Chemotherapy received? (n)	
Yes	167 (85%)
No	29 (15%)

automatically generated using predefined ranges of Hounsfield units. Sarcopenia and increased fat distribution were defined based on previously published thresholds. OS was estimated via the Kaplan-Meier method.

Results: A total of 196 patients were identified, with a median follow-up of 12.9 months (patient characteristics in Table 1). 75% of patients were sarcopenic, and this group was significantly older than non-sarcopenic patients. 43% of patients had elevated VFA, and this was associated with female sex. Sarcopenia on its own did not correlate with OS, but in patients with body mass index ≥ 25, sarcopenic patients had worse median OS than non-sarcopenic patients (13 vs. 17 mo, $P=0.01$). This was similarly true in the subgroup of male patients (11 vs. 24 mo, $P=0.03$), but not in females. Regarding fat distribution, patients with a VFA:SFA ratio > 1.2 had significantly worse median OS than those with a VFA:SFA ratio < 1.2 (10 vs. 14 mo, $P=0.003$). This association held true in the male subgroup (10 vs. 13 mo, $P=0.006$), but interestingly, a VFA:SFA ratio > 1.2 was associated with better median OS in females (15 vs. 14 mo, $P=0.047$). Multi-variable analysis revealed that low serum albumin and not receiving chemotherapy were independent predictors of worse OS.

Conclusions: This is the largest study to date that investigates the relationship between measures of body composition with survival outcomes in unresectable PC patients undergoing SBRT. Sarcopenia was found to be correlated with worse OS in overweight/obese patients as well as in males. A high VFA:SFA ratio was also associated with inferior OS. Both prognostic factors are assessable via CT scan which can help to guide management in the future without requiring invasive procedures.

(P045) PSA: Declining Utilization of Brachytherapy for the Treatment of Prostate Cancer

Lauren Andring, MD¹, Todd A Pezzi, MD, MBA², Chad Tang, MD¹, Gary Walker, MD³; ¹UT MD Anderson Cancer Center, ²MD Anderson Cancer Center, ³Banner Health

Background: Despite a growing body of literature demonstrating expanding indications for the use of brachytherapy, multiple prior studies have shown that over time rates of brachytherapy utilization have been decreasing.

Objectives: To analyze rates of brachytherapy use for prostate cancer over time and evaluate patient characteristics, demographics and factors predictive for its utilization.

Methods: Data was retrospectively analyzed from the National Cancer Database (NCDB) for patients with localized prostate cancer treated between 2010 and 2015. Patients were included if they had biopsy confirmed localized adenocarcinoma of the prostate, were treated with radiation as definitive local therapy, and were at least 18 years old. Utilization rates of external beam radiation (EBRT), brachytherapy (BT) and combination (EBRT + BT) were evaluated over time. Univariable (UVA) and backwards elimination multivariable (MVA) analysis were performed to determine characteristics predictive for brachytherapy use.

Results: We analyzed 178,837 patients with localized adenocarcinoma of the prostate treated between 2010 and 2015 with radiation therapy. During the period from 2010-2015, the use of EBRT increased from 67% to 78%, BT (both monotherapy and combination with EBRT) decreased from 33% to 22%, BT monotherapy decreased from 25% to 16% and EBRT + BT decreased from 8% to 6%. Age > 70, government funded insurance or lack of insurance, intermediate or high-risk disease and treatment at an academic center were associated with significantly lower utilization of brachytherapy (all $P < 0.001$), while higher median county income was associated with increased use ($P = 0.02$). On MVA patient age, insurance provider, treatment facility, and NCCN risk category were independent predictors for brachytherapy utilization (Table 1). Notably, on both UVA and MVA brachytherapy practice decreased with increasing year of diagnosis (OR 0.881, 95% CI 0.853-0.910, $P < 0.001$).

Conclusions: Rates of brachytherapy utilization for the treatment of prostate cancer continue to decrease over time. Treatment at an academic center was associated with reduced likelihood of brachytherapy use. This has significant implications for the training of future radiation oncology residents/fellows and direct consequences for both our patients and healthcare expenditure.

(P046) Does the Addition of Brachytherapy And/or Androgen Deprivation Therapy to External Beam Radiotherapy Correlate with Improved Survival in Men with Unfavorable Intermediate-risk Prostate Cancer?

Neal Andruska, MD PhD¹, Temitope Agabalugun, BS¹, Benjamin Fischer-Valuck, MD², Randall Brennenman, MD PhD¹, Yi Huang, MS¹, Hiram Gay, MD¹, Jeff Michalski, MD, MBA¹, Ruben Carmona, MD MStat³, Brian Baumann, MD¹; ¹Department of Radiation Oncology, Washington University School of Medicine in St. Louis, ²Department of Radiation Oncology, Emory University School of Medicine, ³Department of Radiation Oncology, University of Miami School of Medicine

Background: External beam radiotherapy (EBRT) ± brachytherapy boost (BT) ± androgen deprivation therapy (ADT) is currently recommended for men with unfavorable intermediate-risk prostate cancer (UIR-PCa). However, the ideal radiotherapy regimen for UIR-PCa is not well-defined since clinical trials have rarely addressed treatment decisions in this cohort, with most trials grouping UIR patients with either favorable intermediate-risk or high-risk disease. Three clinical trials have shown that adding BT to EBRT improves biochemical progression-free survival but did not report differences in metastatic-free survival, cancer-specific survival, or overall survival. Given that higher-risk patients were included and likely derived the most benefit from intensifying treatment, it remains unclear whether men with UIR-PCa derived the same benefit from a BT boost.

Objectives: The addition of BT to EBRT+ADT in UIR-PCa has a radiobiologic advantage, permitting further dose escalation beyond doses that can be delivered routinely with EBRT. We therefore hypothesized that EBRT+BT±ADT would be associated with improved overall survival (OS) relative to EBRT±ADT in men with UIR-PCa.

Methods: 32,246 men diagnosed between 2004-2015 with UIR-PCa treated with EBRT±ADT (≥ 72 Gy in 1.8-2.0 Gy per fraction) or EBRT+BT (40-50.4 Gy EBRT, followed by HDR-BT or LDR-BT) were identified in the National Cancer Database (NCDB). Patients with a Charlson-Deyo comorbidity index (CDCI) score > 1, who received systemic therapy other than ADT, or missing key information were excluded. Inverse propensity of treatment-weighted (IPTW) multivariable analysis (MVA) using Cox regression modeling was used to compare OS hazard ratios. Covariables included age, race, ethnicity, year of diagnosis, CDCI score, insurance status, educational and socioeconomic metrics, treatment at an academic center, PSA as diagnosis, Gleason score, clinical T-stage, and receipt of ADT.

Results: Patients were stratified into four treatment groups: (i) EBRT (n = 13,265), (ii) EBRT+ADT (n = 13,123), (iii) EBRT+BT (n = 3,440), (iv) EBRT+ADT+BT (n = 2,418). Propensity-weighted MVA showed the following. EBRT+ADT correlated with improved OS relative to

TABLE 1. Multivariable Logistic Regression Model for Brachytherapy Treatment

Factors	OR	95% CI	p-value
Year of diagnosis			
n	1	Reference	<0.001
n+1	0.887	0.858-0.918	
Age at diagnosis			
≤70	1	Reference	<0.001
>70	0.673	0.656-0.691	
Insurance			
Private	1	Reference	
No insurance	0.460	0.415-0.510	<0.001
Medicaid	0.549	0.512-0.589	<0.001
Medicare	0.777	0.758-0.797	<0.001
Other government	0.698	0.662-0.736	<0.001
Facility Type			
Community Program	1	Reference	
Comprehensive Community	1.165	1.123-1.209	<0.001
Academic	0.847	0.814-0.881	<0.001
Integrated Network	1.222	1.165-1.281	<0.001
NCCN risk			
Low	1	Reference	
Intermediate	0.490	0.477-0.503	<0.001
High	0.232	0.225-0.239	<0.001

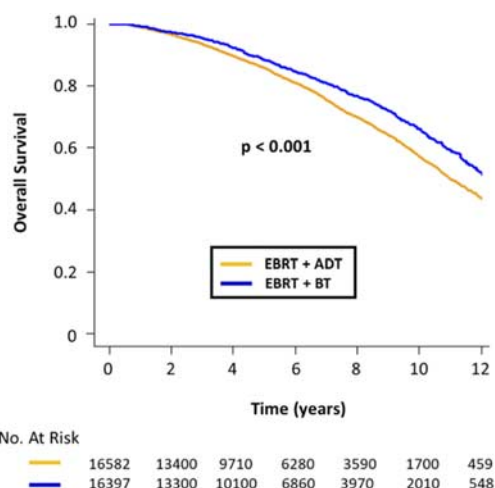

FIGURE 1. Propensity weighted Kaplan-Meier curve stratified by EBRT+ADT versus EBRT+BT without ADT. P value represent P-log rank.

EBRT alone (Hazard Ratio (HR): 0.92, [95% Confidence Interval: 0.87-0.98], $P = .005$). Compared with EBRT+ADT, EBRT+BT (HR: 0.77 [0.69-0.85], $P = 3 \times 10^{-7}$) and EBRT+BT+ADT (HR: 0.75 [0.67-0.83], $P = 6 \times 10^{-8}$) were both associated with improved OS. Relative to EBRT+BT, EBRT+BT+ADT was not associated with improved OS (HR: 0.99 [0.87-1.11], $P = .82$). 10-year OS for the EBRT+ADT versus EBRT+BT without ADT was 55% and 70%, respectively ($P < 0.0001$) (Fig. 1).

Conclusions: The addition of brachytherapy to EBRT correlated with reduced mortality in men with UIR-PCa. While ADT+EBRT was associated with better OS relative to EBRT, EBRT+BT+ADT resulted in comparable survival to EBRT+BT, suggesting that omitting ADT with EBRT+BT may be an option for men who want to avoid ADT.

(P047) A Prospective Study of MR-guided Focal Salvage HDR Brachytherapy for Radiorecurrent Prostate Cancer: Updated Results of 30 Patients

Hans Chung, MD¹, Mark Corkum, MD¹, Andrew Loblaw, MD¹, Chia-Lin Tseng, MD¹, Ananth Ravi, PhD¹, Melanie Davidson, PhD¹, Matt Wronski, MD¹, Masoom Haider, MD², Gerard Morton, MD¹; ¹Sunnybrook Odette Cancer Centre, ²University of Toronto

Background: Salvage therapies for localized radiorecurrent prostate cancer often carry significant short- and long-term morbidity. Focal salvage high dose rate (HDR) brachytherapy is an appealing treatment technique which delivers an ablative dose of radiotherapy to the portion of the prostate containing recurrent disease; however, limited prospective data is available.

Objectives: We sought to explore the toxicities, health related quality of life and efficacy of focal salvage HDR brachytherapy after previous definitive radiotherapy.

Methods: Patients with locally recurrent prostate cancer after previous external beam radiotherapy (EBRT) and/or brachytherapy were enrolled on a prospective clinical trial. Patients received MRI-guided, ultrasound-based focal HDR brachytherapy delivered over two fractions of 13.5 Gy delivered 1-2 weeks apart. Adjuvant androgen deprivation therapy (ADT) was not used. Toxicity was measured using CTCAE v4. Posttreatment response was evaluated using MRI 1-2 years after salvage. Biochemical failure was defined as PSA nadir + 2 ng/mL.

Results: Thirty patients were treated between November 2012 and September 2019. Median follow-up was 35 months (range: 13–92 mo). Fifteen patients were initially treated with EBRT, 3 with low dose rate (LDR) brachytherapy monotherapy, 1 with EBRT and LDR brachytherapy boost, 2 with EBRT and HDR brachytherapy boost, and 9 with HDR brachytherapy as monotherapy (all 19 Gy in a single fraction). Median clinical target volume (CTV) at time of salvage was 5.22 mL (range: 2.18–15.71 mL), corresponding to a median of 20.0% of the prostate volume (range: 8.8–39.2%). Median PSA at salvage was 4.46 ng/mL (range: 0.99–11.63 ng/mL). The median CTV V100 was 96.5% (range: 90.5–99.5%), and median CTV D90 was 15.1 Gy per fraction (range: 13.6–18.1 Gy). Seventeen patients experienced subsequent biochemical failure, and 9 have received ADT and/or further local salvage. No patients have died from prostate cancer. Median time to biochemical failure was 41.5 months, and median time to ADT/salvage therapy was 70.6 months. The three-year biochemical failure-free event rate was 61.8% (95% CI 44.0–86.6%), and three-year ADT/salvage therapy-free event rate was 86.0% (95% CI 74.1–99.8%). No acute grade ≥ 3 GU/GI toxicity was observed. One late grade 3 GU toxicity

event occurred, cystitis at 42 months post treatment, which did not persist on follow-up. No late grade ≥ 3 GI toxicity was seen. Of the 28 patients who had a post-treatment MRI, 26 had evidence of a local treatment response.

Conclusions: In our updated results, we found focal salvage HDR brachytherapy is well tolerated with a favorable side effect profile and 3-year biochemical control rates in line with other salvage therapies for radiorecurrent prostate cancer. While early MRI response at the treated site is common, this does not preclude subsequent biochemical failure.

(P048) Comparative in Silico Analysis of Intensity Modulated Scanning Beam Proton Therapy (IMPT) and Volumetric Modulated Arc Photon Radiotherapy (VMAT) for the Post-Operative Treatment of Prostate Cancer

Ian Cruickshank, BS RT(T)¹, Hao Chen, PhD², Aditya Halthore, MD², Heng Li, PhD³, Curtland Deville, MD²; ¹Howard University College of Medicine, ²Department of Radiation Oncology and Molecular Radiation Sciences, The Johns Hopkins Hospital, ³Johns Hopkins University

Background: Limited data exists regarding the dosimetric techniques and potential advantages of modern scanning beam proton therapy relative to conventional photon therapy modalities for prostate cancer patients in the post-operative setting.

Objectives: Our purpose was to evaluate the dosimetric differences in IMPT versus IMRT for the post-operative treatment of prostate cancer.

Methods: The 3DCT data of 7 consecutive, post-prostatectomy patients treated at our institution with adjuvant or salvage IMPT in 2020 were used to generate VMAT and IMPT plans using 3 different beam arrangements: 2-field (opposed laterals), 3-field (opposed laterals inferiorly matched to posterior beam superiorly), and 4-field (opposed laterals inferiorly matched superiorly to 2 posterior oblique beams). Prescription was 50 Gy in 2 Gy fractions delivered to elective pelvic nodal regions (i.e., whole pelvis) and 20 Gy in 2 Gy fractions delivered to the prostate bed for a total dose of 70 Gy in 35 fractions. PT doses are reported in Gy (RBE)=1.1 Gy. Dose goals for target and relevant organs at risk (OAR), as well as dose-volume histogram parameters were assessed. The paired 2-sided Wilcoxon signed-rank test was used to compare the 4-field IMPT versus VMAT plans, with $P < 0.05$ indicating statistical significance.

Results: CTV coverage met pre-specified dose goals for all plans with 99% of CTVs receiving $\geq 100\%$ of the prescription doses. The 2-, 3-, and 4-field IMPT plans showed similar doses to the bladder and bladder minus CTV (bladderless-CTV), while the 4-field IMPT plan showed the lowest mean and low to intermediate doses to the bowel cavity and rectum. For example, mean bowel cavity V15 and V45 for the 2-, 3-, and 4-field IMPT plans were respectively 549.2 \pm 282.6 cc and 110.7 \pm 39.8 cc, 303.0 \pm 102.0 cc and 92.7 \pm 32.6 cc, and 263.4 \pm 97.3 cc and 90.6 \pm 40.6 cc. Mean rectum V50 and V60 for the 2-, 3-, and 4-field IMPT plans were 26.8 \pm 8.9% and 18.7 \pm 7.4%, 28.9 \pm 10.5% and 19.5 \pm 8.0%, 24.3 \pm 4.8% and 16.7 \pm 4.1% respectively. When comparing the 4-field IMPT and VMAT plans, the rectal, bowel, and bladder parameters in Table 1 differed significantly.

Conclusions: The 4-field IMPT beam arrangement showed the greatest reductions in dose to the bowel cavity and rectum compared with VMAT and the 2- and 3-field IMPT arrangements. These data can inform the future clinical management and delivery of proton therapy for prostate cancer in the post-prostatectomy setting (Fig. 1).

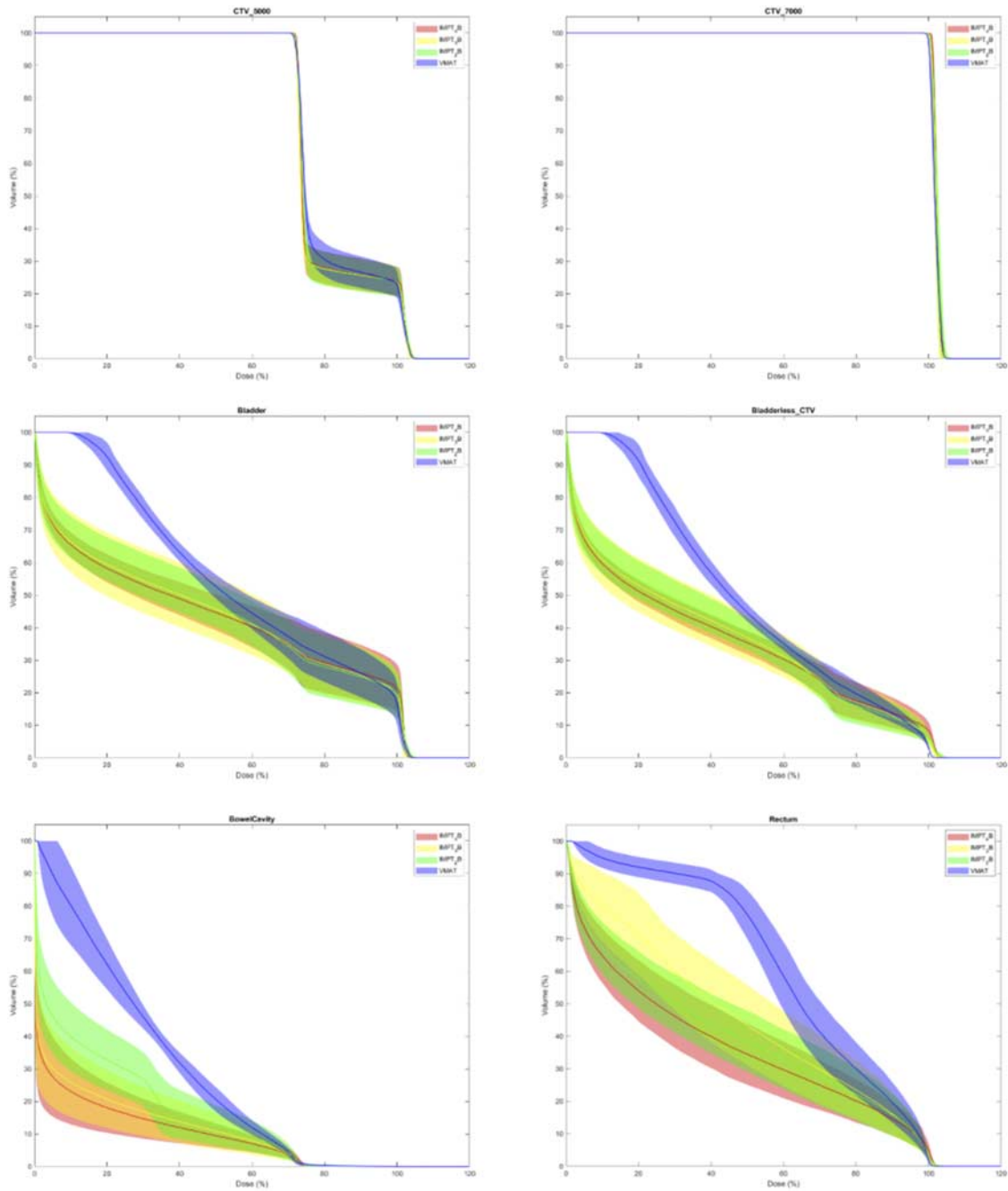

FIGURE 1. Dose volume histogram comparison of 2-, 3-, and 4-field IMPT and IMRT for the clinical target volumes and organs at risk including bladder, bladder minus CTV (bladderless-CTV), and bowel cavity.

TABLE 1. Comparison of VMAT IMRT and 4-field IMPT Target Coverage and OAR Constraints

Structure	Dose Goal	VMAT	4-field IMPT	P value
CTV_7000	V _{68.6Gy} > 99%	100.0%±0.0%	100.0%±0.0%	1
	V _{70Gy} > 99%	99.2%±0.4%	99.8%±0.4%	0.9948
CTV_5000	V _{49Gy} > 98%	100.0%±0.0%	100.0%±0.0%	0.8395
	V _{50Gy} > 98%	99.4%±0.5%	99.8%±0.4%	0.9725
	D _{min} > 45Gy	4904.5±35.2	4975.1±51.2	0.9975
Rectum	D _{max} < 103%	101.9%±0.2%	102.2%±0.5%	0.9452
	V _{103%} < 0.5cc	0.0±0.0	0.0±0.1	0.863
	V _{70Gy} < 10%	4.2%±1.6%	4.0%±2.0%	0.3742
	V _{60Gy} < 20%	28.3%±8.5%	16.7%±4.1%	0.0007
	V _{50Gy} < 30%	45.3%±12.4%	24.3%±4.8%	0.0008
	V _{40Gy} < 40%	71.6%±11.1%	34.2%±8.3%	0.0006
	D _{max} < 105%	102.3%±0.4%	104.0%±0.8%	0.999
Bladderless_CTV	V _{70Gy} < 15%	4.9%±1.2%	8.1%±3.2%	0.9958
	V _{65Gy} < 20%	13.8%±3.1%	12.5%±3.6%	0.0574
	V _{50Gy} < 35%	27.9%±5.1%	22.6%±4.1%	0.0033
	V _{45Gy} < 40%	34.0%±4.4%	27.5%±3.6%	0.0022
Bladder	V _{70Gy} < 35%	18.3%±6.5%	21.2%±7.8%	0.996
	V _{65Gy} < 50%	26.1%±7.6%	25.0%±7.7%	0.0553
Femoral Head_RT	D _{max} < 53Gy	4621.7±331.4	4053.4±340.9	0.0035
	V _{50Gy} < 1%	0.0%±0.0%	0.0%±0.0%	0.0973
	V _{45Gy} < 5%	0.1%±0.2%	0.0%±0.0%	0.0604
Femoral Head_LT	V _{37Gy} < 50%	2.7%±2.5%	0.4%±0.7%	0.0273
	D _{max} < 53Gy	4660.5±255.5	3985.2±288.4	0.0011
	V _{50Gy} < 1%	0.0%±0.0%	0.0%±0.0%	0.156
Sigmoid	V _{45Gy} < 5%	0.2%±0.2%	0.0%±0.0%	0.0434
	V _{37Gy} < 50%	2.8%±1.7%	0.3%±0.4%	0.0057
	D _{max} < 66Gy	5701.9±806.0	5629.6±517.9	0.2995
Bowel Cavity	V _{60Gy} < 5-10 cc	1.9±3.5	1.5±2.6	0.1295
	V _{55Gy} < 20 cc	4.4±7.3	2.2±3.8	0.0755
	V _{45Gy} < 195 cc	162.1±80.4	90.6±40.6	0.0023
	V _{15Gy} < 830 cc	1061.1±526.0	263.4±97.3	0.0015
Penile Bulb	D _{mean} < 52.5Gy	2025.2±216.3	1744.7±636.6	0.0926
Body	D _{max} < 107%	106.3%±0.6%	105.4%±0.8%	0.0043

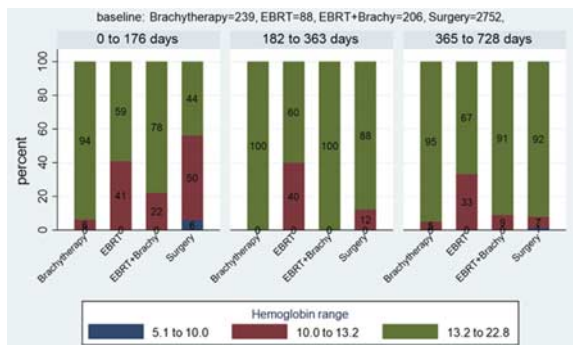

FIGURE 1. Proportional change of hemoglobin over time by treatment group. For patients with normal hemoglobin (> 13.2) before treatment, the graph displays the proportion of patients that developed mild to severe anemia at three distinct post-treatment time bins.

Results: 3285 men were included in the analysis. Treatment regimens among these patients consisted of 239 treated with brachytherapy alone, 88 treated with EBRT, 206 treated with EBRT/brachytherapy, and 2752 treated with surgical resection. Up to 6 months following treatment, 41% of men treated with EBRT developed mild anemia, compared with 22, 6, and 50% for EBRT/brachytherapy, brachytherapy alone, and surgery, respectively. An additional 6% of men treated with surgery developed moderate/severe anemia in this time frame. Between 6 and 12 months following treatment, 40% of patients treated with EBRT had mild anemia, compared with 0% for both EBRT/brachytherapy and brachytherapy alone and 12% for surgical patients. Between 12 and 24 months, 33% of patients treated with EBRT had anemia, compared with 9, 5, and 7% for EBRT/brachytherapy, brachytherapy, and surgery, respectively. When considering ADT use, patients treated with EBRT/ADT had more episodes of anemia than trimodality therapy at all time points (50 vs. 21% at 0-6 months, 56 vs. 0% at 6-12 months, and 33 vs. 13% at 12-24 mo).

Conclusions: EBRT was associated with more and longer duration anemia compared with either brachytherapy or combined brachytherapy and EBRT, suggesting brachytherapy boost reduces the risk of anemia. Anemia is a common occurrence after surgery in the perioperative period, but then is unlikely to persist. Further studies are required to determine if there is a dosimetric correlation for these observations (Fig. 1 and Table 1).

(P049) Comparing the Impact of External Beam Radiotherapy, Brachytherapy, and Surgery on the Development of Anemia and Subsequent Temporal Recovery in Patients Treated for Localized Prostate Cancer

Jordan Fenlon, MD¹, Krystal Straessler, PhD¹, Jonathan Tward, MD, PhD¹, ¹Huntsman Cancer Institute at the University of Utah

Background: Studies that explore pelvic radiotherapy’s effect on anemia predate intensity-modulated radiation therapy and have not tracked the temporal recovery of Hemoglobin (Hgb) levels.

Objectives: The present study explores the impact of external beam radiotherapy (EBRT), brachytherapy, and surgical treatments on Hgb levels and subsequent temporal recovery.

Methods: Patients diagnosed with localized prostate cancer after the year 2008 who had normal pretreatment Hgb levels (> = 13.2 g/dL) were identified in a prospectively maintained institutional outcomes database. Patients were stratified by treatment modality (brachytherapy, external beam radiation [EBRT], combined brachytherapy and EBRT, or surgery). The proportion of patients who became mildly (Hgb 10–13.2 g/dL) or moderately/severely (Hgb <10 g/dL) anemic was evaluated at time bins of 0-6 months, 6-12 months, and 12 - 24 months. For patients with multiple Hgb levels in a time bin, the average value was used. Patients were censored at the initiation of any additional cancer therapies.

TABLE 1. Number of Patients With Evaluable Hemoglobin by Treatment Group

Number of Patients With Evaluable Hemoglobin at Each Post-Treatment Time Bin By Treatment Group			
	0-6 Months	6-12 Months	12-24 Months
Brachytherapy	16	17	20
EBRT	22	20	15
EBRT + Brachy	18	13	11
Surgery	608	65	75

For patients with normal pre-treatment hemoglobin (> 13.2), the number of patients with evaluable hemoglobin by treatment group in each distinct post-treatment time bin is displayed.

(P050) Androgen Deprivation Therapy and Radiotherapy Practice Patterns for Unfavorable Intermediate Risk Prostate Cancer

Shaakir Hasan, D.O.¹, Stanislav Lazarev, MD², Madhur Garg, MD³, Keyur Mehta, MD³, Robert Press, MD¹, Arpit Chhabra, MD¹, J Isabelle Choi, MD¹, Charles Simone, MD, FACRO¹, Daniel Gorovets, MD⁴; ¹New York Proton Center, ²Mount Sinai, ³Montefiore, ⁴Memorial Sloan Kettering Cancer Center

Background: Per National Comprehensive Cancer Network (NCCN) guidelines, the nonsurgical treatment algorithm for unfavorable intermediate risk (UIR) prostate cancer (PC) includes external beam radiotherapy (EBRT) with short-course androgen deprivation therapy (ADT), or EBRT with brachytherapy (BT) with or without ADT. The current practice patterns and patient selection criteria in this setting are unclear. **Objectives:** Using the National Cancer Database (NCDB), radiation treatment patterns for UIR PC were evaluated.

Methods: Clinical and demographic characteristics associated with each treatment were assessed via multivariable binomial regression analysis, expressed as odds ratios (OR) with 95% confidence intervals.

Results: There were 68,283 eligible men with a median age of 70 years treated with radiotherapy between the years 2004-2015 and who met the NCCN criteria for UIR PC. The most common treatment was EBRT + ADT (38.0%), then EBRT alone (32.2%), BT alone (9.7%), EBRT + BT (8.4%), EBRT + BT + ADT (7.1%), and BT + ADT (4.7%). ADT utilization decreased over time, from 58% in 2004 to 49% in 2015, as did BT utilization, from 39% in 2004 to 22% in 2015 ($P < 0.001$). Patients were classified as UIR because of Gleason 4+3 disease (60.5%), Gleason 3+4 with PSA between 10-20 (18.5%), clinical T2b or T2c (17.5%), or 50% or more cores positive (3.5%). On multivariable analysis, Gleason 4+3 (HR = 1.45, 1.39-1.50), high volume disease (OR = 1.53, 1.59-1.72), stage T2b/T2c (OR = 1.66, 1.59-1.72), PSA between 10-20 (OR = 1.86, 1.79-1.93), older age (OR = 1.004, 1.001-1.006), treatment at a non-academic center (OR = 1.37, 1.28-1.44), Black patients (OR = 1.11, 1.06-1.17), Hispanic patients (OR = 1.17, 1.09-1.28), lower income areas (OR = 1.12, 1.05-1.19), rural areas (OR = 1.18, 1.09-1.27), treatment before 2008 (OR = 1.41, 1.35-1.48), and EBRT (vs BT or combination) (OR = 1.81, 1.75-1.88) were all associated with increased ADT use. Gleason 4+3 (HR = 0.94, 0.89-0.98), T2b/T2c (OR = 0.91, 0.87-0.95), PSA between 10-20 (OR = 0.73, 0.70-0.76), older age (OR = 0.96, 0.957-0.963), Hispanic patients (OR = 0.71, 0.64-0.78), Black patients (OR = 0.84, 0.79-0.88), non-rural areas (OR = 0.74, 0.68-0.81) treatments after 2007 (OR = 0.68, 0.65-0.71) were each independently associated with decreased BT utilization. Lower PSA (OR = 1.28), Gleason 3+4 (OR = 1.17), and treatment at academic centers (OR = 1.92) were independent predictors of hypofractionation (all $P < .05$) The two non-surgical NCCN-recommended treatments for UIR PC, EBRT+ADT and EBRT+BT, were analyzed in a separate subset. Independent correlates of EBRT+BT include Gleason 3+4 (OR = 1.28, 1.19-1.38), low volume disease (OR = 1.32, 1.18-1.46), T1c/T2a (OR = 1.21, 1.12-1.31), PSA under 10

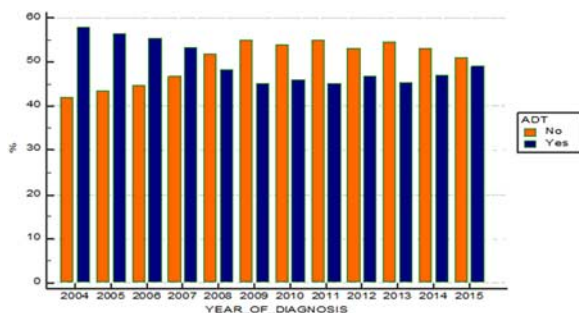

FIGURE 2. ADT use by year.

(OR = 2.22, 2.06-2.39), younger age (1.06, 1.055-1.065), non-Hispanic (OR = 1.55, 1.30-1.85), and white patients (OR = 1.40, 1.27-1.53).

Conclusions: Only approximately half of UIR PC patients treated with radiotherapy between 2004-2015 adhered to the current NCCN recommendations, with a trend away from ADT and BT in more recent years. Older patients with more aggressive UIR criteria were more likely to receive ADT and less likely to receive BT (Figs. 1 and 2).

(P051) Was There a Differential Delay in Urologic Oncology Diagnoses Due to the COVID 19 Pandemic?

Kevin Healey, Medical Student 1st year¹, Mitchell Finkelstein, High School Student², Miriam Williams, CAO¹, Steven Finkelstein, MD, DABR, FACRO²; ¹AUI, ²FCA / US Oncology Network

Background: In community urology, a delay in performing routine screening evaluation and treatment procedures secondary to the COVID-19 pandemic delayed the number of urological oncology patient seeking care according to data from Medicare and United States insurers. Thus, it is unclear if this delay influenced urologic oncology and non-oncology equally.

Objectives: Our hypothesis is that there may be a differential delay in urologic oncology diagnoses due to the COVID 19 Pandemic.

Methods: This is a retrospective review of prospectively collected data; new patients referred to a large multispecialty community urology organization before COVID 19 (quarter 2 April-June 2019) were compared with during COVID 19 (quarter 2 April-June 2020). Data was obtained using electronic medical records for completeness. Urology disease data were recorded and compared.

Results: As compared with previous year quarter 2, there was an overall decrease in new patient referrals to a large multispecialty urology organization. With respect to urologic oncology and urologic non-oncology, there was a significant decrease in new patient visits. With respect to urologic oncology, prostate, bladder, and testicular were significantly affected; diagnostic procedures related to workup were decreased accordingly. Lastly, referrals to radiation oncology for prostate, bladder, and testicular were impacted negatively with a differential delay by disease subsite.

Conclusions: The data suggest a differential delay in urologic oncology diagnoses due to the COVID 19 pandemic in some large community urology organizations. Data over time will assess these changes across 2021.

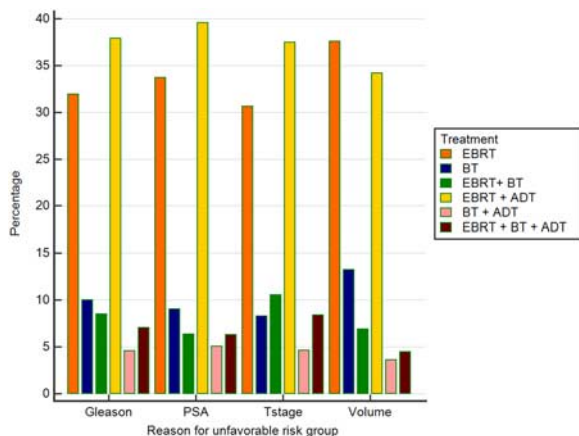

FIGURE 1. Type of treatment partitioned by risk factor.

(P052) Radiotherapy Does Not Increase the Frequency of Revision of Perineal Urethrostomy in Penile Cancer: A 20-year International Multicenter Experience

Peter Johnstone, MD, FACR, FASTRO¹, Hielke-Martijn de Vries, na², Juan Chipollini, Assistant Professor³, Franklin Boyd⁴, Fernando Korkeas, MD, PhD⁵, Maarten Albersen⁶, Eduard Roussel, Department of Urology⁶, James Jiang, MD⁷, Viraj Master, MD PhD FACS⁸, Oscar Brouwer, Netherlands Cancer Institute², Philippe Spiess, MD, MS, FACS¹; ¹Moffitt Cancer Center, ²Netherlands cancer institute, ³The University of Arizona, ⁴University of South Florida Morsani College of

Medicine, ⁵ABC Medical School, ⁶University Hospitals Leuven, ⁷Emory University School of Medicine, ⁸Emory University

Background: Perineal urethrostomy (PU) is the definitive form of urinary diversion in patients with locally advanced or anatomically unfavorable penile cancer (PeCa) requiring total penectomy. Prior studies would suggest PU failure rates in up to 30% of cases, although this has been infrequently reported in patients with cancer.

Objectives: Because of lack of clinical evidence, radiotherapy (RT) is seldom recommended for pN1/pN2 PeCa lesions but may be used for extra-nodal (pN3) disease. We previously described a large, multi-institutional experience of PU for PeCa with respect to complications, and now describe the role of perioperative RT in the process.

Methods: In our cohort, 299 patients from seven international centers in Belgium, Brazil, China, Netherlands, UK and the United States underwent PU for urinary diversion for PeCa between 2000 and 2019. Median patient age was 67 years and median follow-up was 24 months. Demographic and clinicopathologic characteristics were reviewed. Six patients received pre-operative RT; five of them with chemotherapy. 43 received RT post-operatively, 28 (65%) with chemotherapy.

Results: 75 patients (25%) developed a 30-day post-operative complication with a single postoperative death. Wound infection (49%) and dehiscence (19%) were most common. Over 65% (n=50) of complications were minor (Clavien-Dindo Grade I and II). Only adjuvant chemoradiation was significantly associated with post-operative complication (OR: 2.39, 95%CI 1.09-5.24). Urethral stenosis occurred in 12% (n=36) of cases. Almost 80% occurred in the first year (median 5.7 m; IQR 3.1-12 m). Twenty-seven patients underwent surgical revision and 9 were treated conservatively. Pre-operative or adjuvant therapy was not significantly related to subsequent PU stenosis.

Conclusions: When RT is delivered for PeCa it is usually to the pre-pubic fat, groin and lateral pelvis, and not to the course of the PU. Given the large number of patients and diverse circumstances and eras involved, it appears that post-operative RT may be delivered without significant increase in the risk of stenosis and surgical revision. We acknowledge limitations of this retrospective study and its implicit selection bias. However, our follow-up is sufficient for perioperative complications and early stenosis rates contributing to revision.

(P053) Outcomes of Axumin PET/CT-detected Prostate Cancer Nodal Recurrences: A Single Institution Experience

Andrew Keller, MD¹, Ankur Patel, MD¹, Leonard Appleman, MD, PhD¹, David Friedland, MD¹, Roby Thomas, MD¹, Adam Olson, MD²; ¹UPMC Hillman Cancer Center, ²Department of Radiation Oncology, UPMC Hillman Cancer Center, University of Pittsburgh School of Medicine

Background: Nodal recurrence from prostate cancer is an emerging disease state that represents a therapeutic dilemma for oncologists. The advent of advanced PET imaging modalities offers greater sensitivity to detect oligometastatic disease in this patient cohort and renders radiation therapy, such as stereotactic body radiation therapy (SBRT) or Intensity Modulated Radiation Therapy (IMRT), an attractive alternative to androgen deprivation therapy alone.

Objectives: Whether addition of local therapy confers long-term biochemical control is uncertain. We evaluated outcomes of prostate cancer patients with recurrent nodal disease detected by Axumin PET/CT.

Methods: A retrospective analysis of 23 patients with prostate adenocarcinoma nodal recurrences detected by Axumin PET/CT scan treated with SBRT, EBRT, or ADT alone from 2017-2018 was performed. Median patient age was 67 (range 49-83). Initial definitive treatment consisted of radical prostatectomy for 14 patients and RT +/- ADT for 9 patients. Median PSA at time of Axumin PET/CT scan was 5.5 ng/mL (range 0.7-39.0 ng/mL). 11 patients underwent SBRT, 6 patients underwent IMRT with simultaneous or sequential boost to gross nodal disease, and 8 patients underwent ADT alone. 7 of 17 patients treated with RT received ADT at time of RT. SBRT was to a total dose of 35-50 Gy in 5 fractions. IMRT was to a dose of 45-72 Gy in 25-40 fractions targeting pelvic nodes plus/minus prostatic fossa or PA nodal region, with boost to gross disease. Local control of treated disease following RT, biochemical control, ADT-free interval, freedom from new sites of disease, and overall survival, were calculated from date of

Axumin utilizing the Kaplan-Meier estimator. Biochemical control was defined as the time until sustained PSA rise >0.2 ng/mL above PSA at time of Axumin PET/CT scan. Log-rank test was utilized for univariate analysis.

Results: Median follow-up was 27 months. Median overall survival was not reached, with all patients surviving until last follow-up. Median biochemical control was 32.0 mos (95% CI 20.7-43.3 mos). For patients not receiving ADT at time of RT, median ADT-free interval was 16.0 mos (95% CI 4.0-28.0 mos). Follow-up imaging was available in 18 patients. Of patients receiving RT, 2-year local control of treated disease was 100%. Median freedom from new sites of disease was 27 mos (95% CI 16.7-37.3 mos), with 7 patients developing additional sites of disease, including 5 cases of additional nodal-only failure. Of the 18 patients with follow-up imaging, 10 (56%) had no evidence of radiographic progression. There were no cases of grade 3+ toxicity following RT. On univariate analysis, Gleason score, time from initial definitive management to Axumin PET/CT, and addition of RT were not statistically significant predictors of biochemical control or freedom from additional sites of disease.

Conclusions: RT in the form of SBRT or IMRT are well-tolerated, effective local treatment for patients with recurrent nodal disease secondary to prostate cancer. Prognostic factors associated with long-term biochemical control remain unclear and require a larger sample size to detect.

(P054) Improvements in Rectal Dosimetry Using Rectal Hydrogel Spacer in Patients with Prostate Cancer Undergoing HDR Brachytherapy

Charles Lee¹, Iavor Veltchev¹, Mengying Deng¹, Rebecca Shulman, MD¹, Teh Lin¹, Robert Price¹, Mark Hallman¹, Eric Horwitz¹, Jessica Wong¹; ¹Fox Chase Cancer Center

Background: High-dose-rate brachytherapy (HDR-BT) is highly effective in the definitive and salvage treatment of prostate cancer. Acute grade 2+ rectal toxicity may occur from 5% of prostate cancer patients treated with HDR-BT monotherapy to over 20% of patients in the salvage or re-irradiation setting. Recently, polyethylene glycol-based rectal hydrogel spacers (RHS) have been increasingly used to create separation between the rectum and prostate. Studies investigating its use in the external beam radiotherapy (EBRT) setting demonstrate improved dosimetry and reduced rectal mucosal injury. However, sparse data exist investigating its use with HDR-BT. This is the first study investigating the dosimetric effect of RHS placement on patients undergoing HDR-BT by utilizing a novel replanning technique.

Objectives: Rectal V75% (rV75) is directly correlated with acute rectal toxicity. We aim to demonstrate improvement in rV75 in patients with RHS undergoing HDR-BT by comparing plans in the same patients. Secondary objective is to quantify changes in prostate (target volume) coverage in plans with and without RHS.

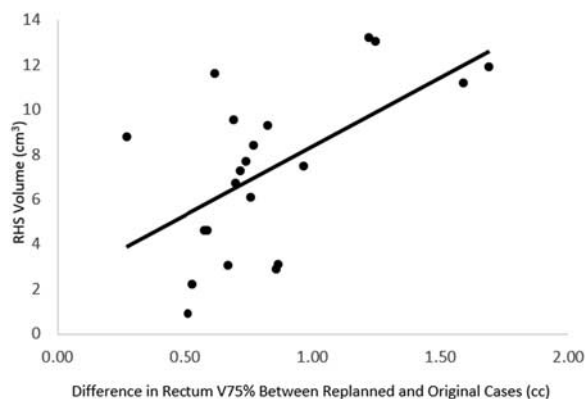

FIGURE 1. Correlation of change in rectal V75% and RHS volume.

Methods: A prospective institutional database was queried for patients undergoing HDR-BT with RHS in place from January 2020–November 2020 for either definitive, adjuvant, or salvage treatment of prostate cancer. A novel replanning technique was used, negating the RHS volume and using the negated contours as a surrogate for the rectum. New plans were generated for each patient using this technique, with the goal of at least 95% prostate coverage. Wilcoxon signed rank tests and Spearman correlation were used to assess dosimetric differences between original treatment plans and regenerated plans for correlations between separation and volume.

Results: Twenty-one HDR-BT procedures were performed in 12 patients. Five had HDR-BT monotherapy (2700 cGy in 2 fractions), 4 patients received salvage HDR-BT (2400 cGy in 2 fractions), and 3 patients received HDR-BT boost (1500 cGy in 1 fraction following EBRT 4600 cGy in 23 fractions). Median RHS volume was 7.44 cm³ (IQR: 4.59-9.56 cm³). Rectal dosimetric parameters were significantly worse in regenerated plans compared with original plans. However, all 21 regenerated plans were clinically acceptable based on institutional criteria. In the original treatment plans, rV75 was 0.0 cm³ in all cases; in regenerated plans, median rectum V75% (rV75*) was 0.74cm³ (IQR: 0.62-0.87 cm³), *P* < 0.001. Spearman correlation of the difference between rV75* vs rV75 (Δ rV75) was found to be significantly correlated with RHS volume ($\rho = 0.52$, *P* = 0.016, Fig. 1), prostate volume ($\rho = 0.51$, *P* = 0.018), and radiation dose ($\rho = 0.46$, *P* = 0.035). Median prostate V100% in original cases was 98.56% (IQR: 98.06-99.08) and was 96.07% in replanned cases (IQR: 95.06-97.30), *P* < 0.001. There were no significant differences between median prostate V150% and V200%.

Conclusions: RHS significantly reduces rectum V75% in patients undergoing HDR-BT. Larger RHS volumes inserted appear correlated with larger magnitude of rectum V75% reduction. RHS should be considered for all patients, especially those undergoing combination or salvage treatment, to limit rectal toxicity. Reduction in prostate V100% in replanned cases likely underestimates actual attainable prostate V100% in patients undergoing HDR-BT without RHS.

(P055) Dose Differentiated HDR Prostate Brachytherapy – a Feasibility Assessment of MRI Guided Dose Escalation to Dominant Intraprostatic Lesions

Christopher Luminais, MD¹, David Cousins, MD¹, Hamidezra Nourzadeh, PhD¹, Eric Aliotta, PhD¹, Bruce Libby, PhD¹, Timothy Showalter, MD¹; ¹University of Virginia

Background: Prostate brachytherapy is routinely performed with TRUS or CT based planning. Neither modality can delineate dominant intraprostatic lesions (DILs). Prostate MRIs performed during workup can identify high risk DILs. DILs are known to be a high risk locations for local recurrence and there is clinic interest in dose escalating DILs. MRI registration at the time of brachytherapy allows DIL delineation and dose escalation.

Objectives: This retrospective study assesses the maximum achievable dose escalation to DILs while respecting OAR objectives.

Methods: Our institution offers combination HDR prostate brachytherapy (15 Gy in 1 fx) + pelvic EBRT (45 Gy in 25 fx) to patients with unfavorable intermediate or high risk prostate cancer. We identified 24 patients treated with combination therapy from 2013–2016 who had an available pre-treatment prostate MRI with 1-3 visualized DILs. Each patient’s MRI was rigidly co-registered to the intra-procedure TRUS and used to contour any visible DILs. DIL contours were transferred to the TRUS based planning system. Original TRUS based prostate and OAR volumes were not altered. Original treatment plans were

experimentally re-optimized to dose escalate the DILs. Dosimetric indices from the original and the reoptimized plans were compared using a two-tailed paired T-test. Each reoptimized plan was deemed acceptable if it achieved all of the following criteria: prostate D90 > 100%, prostate V100 > 90%, urethra D10 < 118%, rectum V80 < 0.5 cc, bladder D1cc < 75%, or if it did not exceed OAR doses of the original plan.

Results: All reoptimized plans met the acceptability criteria. Achieved dosimetry is reported in Table 1. Mean DIL D90 was significantly increased from 134% on the original plans to 154% on the re-optimized plans. Mean urethra D10 and mean bladder D1cc were significantly reduced from 123% to 117% and 72% to 65%, respectively. Mean rectum V80 did not change significantly. Prostate D90 and V100 were reduced from 106% to 102% and 93% to 91%, respectively. Decreased prostate coverage was considered acceptable as D90 > 100% and V100 > 90% were achieved. We estimate that image registration and DIL dose escalation would increase procedure time by 15 minutes using standard treatment planning software.

Conclusions: Using MRI for delineation of DILs, we were able to reoptimize HDR brachytherapy plans to dose escalate DILs to a mean D90 of > 150% while maintaining favorable prostate coverage and OAR doses. Based on this finding, we estimate that a goal DIL D90 dose of > 150% (or 22.5 Gy) is an aggressive but achievable goal while meeting OAR dose constraints. We will use this analysis to inform an upcoming prospective clinical trial of MRI guided prostate HDR brachytherapy at our center.

(P056) Early Toxicity Outcomes for Initial Implementation of Cs-131 Seeds for Low-dose-rate Prostate Brachytherapy

David Marshall, MD, MS¹, Shauna McVorrnan, MD², Bradley DePaoli, MD², Bethany Broekhoven, MS², Elizabeth Hilliard, MS³, Hong Li, PhD²; ¹Department of Radiation Oncology, Medical University of South Carolina / Hollings Cancer Center, ²Medical University of South Carolina, ³SUNY Upstate Medical University

Background: Low dose rate (LDR) prostate brachytherapy is an attractive definitive treatment option for localized prostate cancer with equivalent oncologic outcomes compared with external beam radiation therapy (EBRT) and radical prostatectomy (RP) with the benefit of being a convenient outpatient minimally invasive procedure. As the utility of LDR brachytherapy has been established, the focus has shifted to improving the side effect profile while maintaining oncologic outcomes. Most data in this sphere were gathered using I-125 and Pd-103 seeds, but since Cs-131 was introduced in 2004, several institutions have adopted its use with the hypothesis that its shorter half-life and slightly higher average energy would produce dosimetric advantages that may improve outcomes and decrease duration or severity of side effects.

Objectives: To report acute toxicity outcomes with the first 50 patients treated with Cs-131 LDR brachytherapy at our institution, compared with our experience with I-125 and Pd-103.

Methods: An IRB-approved retrospective chart review was performed on the first 50 patients treated with Cs-131 LDR brachytherapy for localized prostate cancer at our institution. Patients receiving either a full or partial implant were included; these patients were treated to doses of 100 Gy and 80 Gy prostate minimal peripheral dose, respectively. Patients receiving partial implants generally received 45 Gy external beam radiotherapy starting 6-8 weeks after implant. These data were compared with cohorts of the last 50 patients treated with I-125 brachytherapy and the last 50 patients treated with Pd-103 brachytherapy to standard doses. Data regarding AUA prostate symptom score, Sexual Health Index for Men (SHIM), and RTOG GI toxicity score were assessed pretreatment and at 1-month and 7-month time points. Demographic and clinical data were also collected. Descriptive statistics were used to summarize variables. A linear mixed model was used to compare means and to identify variables as prognostic for acute toxicity (*P* ≤ 0.05).

Results: The mean AUA score at 1-month post-treatment was significantly higher for patients treated with Cs-131 (*P* < 0.001) but declined rapidly and was equivalent to the scores seen with I-125 and Pd-103 at 7 months. A similar trend was seen with the mean RTOG GI

TABLE 1. Original Plan and MRI Reoptimized Dosimetry

	Original plan (mean)	MRI reoptimized plan (mean)	p-value (T-test)
DIL D90	134.2%	154.6%	<.0001
Prostate D90	106.8%	102.1%	<.005
Prostate V100	93.5%	91.5%	0.003
Urethra D10	123.9%	117.6%	<.0001
Rectum V80	0.55cc	0.46cc	0.27
Bladder D1cc	72.03 %	65.67%	0.01

toxicity score. The mean SHIM score at 1-month post-treatment was significantly lower ($P < 0.001$) with Cs-131, but this also improved by 7 months to be equivalent to those seen with I-125 and Pd-103, respectively. On multivariate analysis, the type of isotope used did not predict the AUA, SHIM, or RTOG toxicity score grade or the need for a catheter post brachytherapy.

Conclusions: In patients treated in our initial experience with Cs-131 LDR prostate brachytherapy, acute GU, GI, and sexual side effects peaked higher but decreased faster compared with patients treated with I-125 or Pd-103 isotopes. The isotope used did not predict for AUA, SHIM, or RTOG toxicity score or the need for a catheter post brachytherapy.

(P057) Disparities in Radiation Therapy Access for Prostate Cancer in the United States

Shearwood McClelland III, MD¹, Ulysses Gardner, MBA, RTT², Curtiland Deville, MD³; ¹Department of Radiation Oncology, Indiana University School of Medicine, ²Wright State University Boonshoft School of Medicine, ³Department of Radiation Oncology and Molecular Radiation Sciences, The Johns Hopkins Hospital

Background: Major advances in the role of radiation oncology for treating prostate cancer increases the importance of equity in access to radiation therapy (RT). In 2016, the first comprehensive investigation examining the pervasiveness of health disparities in RT access found that the most prominently studied organ site was prostate.

Objectives: As disparities research has continued to dramatically increase, we sought to assess the evolution of RT access disparities in prostate cancer since that initial investigation.

Methods: A comprehensive literature search was undertaken in June 2020 using the PubMed database (www.pubmed.gov) and the query [prostate AND (radiation OR proton) AND (disparities OR “socio-economic status” OR “health services research” OR inequity OR race [Title])] from 2017-2020. Studies were excluded which were not based in the United States, did not examine health inequities, did not examine RT, or did not examine prostate cancer.

Results: Forty-four of 184 studies found met inclusion criteria. Health disparities were most prominently reported by race (35 studies) followed by insurance status (12 studies), age (6 studies), socioeconomic status (8 studies), geographic location (9 studies), and practice characteristics (6 studies).

Conclusions: Health disparities in access to radiation therapy for prostate cancer remain substantial despite significant advancements in radiation oncology. Access to radiation therapy for prostate cancer is most likely multifactorial; several considerations must be included when assessing systems to decrease existing inequalities. High-level evidence research focusing on reducing disparities is needed and highly anticipated to improve health and survival outcomes for all patients with prostate cancer.

(P058) Association of Second-Generation Antiandrogens with Depression in Prostate Cancer

Kevin Nead, MD, MPhil¹, Malgorzata Nowakowska, BS², Xiudong Lei, PhD¹, Mackenzie Wehner, MD, MPhil¹, Paul Corn, MD¹, Sharon Giordano, MD¹; ¹MD Anderson Cancer Center, ²Baylor College of Medicine

Background: Previous studies have shown a consistent link between hormone therapy (HT) to treat prostate cancer, such as androgen deprivation therapy (ADT), and depression risk (Dinh KT, et al JCO 2016; Nead KT, et al Urol Oncol 2017). However, the association between second-generation antiandrogens (AAs) and depression is unknown.

Objectives: To test the hypothesis that second-generation AAs carry an increased risk of depression, including compared with traditional forms of HT.

Methods: This retrospective cohort study analyzed Surveillance, Epidemiology, and End Results (SEER)-Medicare and Texas Cancer Registry (TCR)-Medicare data from 2011-2015, with a follow-up period of 2 years after diagnosis. Data were analyzed from February to May 2021. Of 210,804 patients diagnosed with prostate cancer in 2011-2015, we identified 30,069 patients with primary prostate cancer diagnosed at

age > 66 years without a second cancer in 12 months. We included patients with continuous Medicare Parts A, B, and D coverage. We excluded individuals who received any form of HT before prostate cancer diagnosis and those previously diagnosed with depression. The following treatment groups were compared: (1) no HT group, (2) traditional HT group (HT without second-generation AA exposure), and (3) second-generation AA group. We implemented time-varying exposure multi-variable Cox proportional hazards models to determine the association of ADT use with depression using the inverse probability treatment weighted (IPTW) method.

Results: Of 30,069 patients, 17,710 (59%) received no HT, 11,311 (38%) received traditional-HT only, and 1,048 (3%) received a second-generation AA. The cumulative incidence of depression at 2 years was highest among second-generation AA users; 13.7% versus 7.2% and 4.8% in the traditional-HT only and no-HT groups, respectively; $P < 0.001$. Multivariable Cox proportional hazards analysis showed that the second-generation AA group had an increased risk of depression compared with the no-HT group (HR = 2.16, 95%CI 1.81-2.59; $P < 0.001$) and the traditional-HT group (HR = 2.26, 95%CI 1.88-2.73; $P < 0.001$), including with stratification by localized (HR = 2.73, 95% CI 2.19-3.42; $P < 0.001$) and regional/distant disease (HR = 2.56, 95% CI 1.81-3.61; $P < 0.001$).

Conclusions: Patients with prostate cancer who received a second-generation AA had a large and clinically significant absolute increased risk of depression compared with patients who received traditional HT alone or no HT.

(P059) Short-Term ADT and Dose-Escalated IMRT in Patients with Intermediate-Risk Prostate Cancer: Benefit or Caution?

Arthur Hung, MD¹, Carl Post, MD¹, Jenna Kahn, MD¹, Claire Turina, BS¹, Tomasz Beer, MD, FACP¹; ¹Oregon Health & Sciences University

Background: In the era of dose-escalated prostate radiation therapy (RT), the use of androgen deprivation therapy (ADT) is undefined for intermediate-risk prostate cancer (IR). Randomized data demonstrates an improvement in biochemical control without an associated improvement in overall survival. Yet there is also growing concern of the risk of ADT to be detrimental to quality of life and increase cardiac events.

Objectives: This single-institution retrospective analysis aimed to evaluate outcomes of IR prostate cancer patients treated with RT with or without concurrent/adjuvant short-term ADT.

Methods: Data was collected from 559 consecutive patients treated with dose-escalated IMRT with daily IGRT for newly diagnosed prostate cancer from December 2002–March 2016. IMRT prescription was 78 Gy / 39 fractions or 70 Gy / 28 fractions. Biochemical recurrence-free survival (BCRFS), distant metastasis-free survival (DMFS), prostate cancer-specific survival (PCSS), and overall survival (OS) were calculated using Kaplan-Meier methodology. We focused our results on the patients with favorable (FIR) or unfavorable intermediate-risk (UIR) prostate cancer.

TABLE 2. Clinical Characteristics of the IR Population

Characteristic	Intermediate-risk RT without ADT (N=166)	Intermediate-risk RT with ADT (N=94)	p value
Age (years)	66.9	67.3	0.49
CV Medications (N)	2.4	2.3	0.65
CCI	4.9	5.0	0.38
Pre-treatment PSA (ng/mL)	7.6	10.4	< 0.001
Clinical T Stage			< 0.001
cT1c – T2a	135 (81.3%)	58 (61.7%)	
cT2b – T2c	31 (18.7%)	36 (38.3%)	
Grade Group			<0.001
1 (GS 3+3)	11 (6.6%)	4 (4.3%)	
2 (GS 3+4)	129 (77.7%)	44 (46.8%)	
3 (GS 4+3)	26 (15.7%)	46 (48.9%)	
Risk Group			< 0.001
Favorable IR	74 (44.5%)	5 (5.3%)	
Unfavorable IR	92 (55.4%)	89 (94.7%)	
RT Fraction Size			0.002
2 Gy per fraction	45 (27.1%)	10 (10.6%)	
2.5 Gy per fraction	121 (72.9%)	84 (89.4%)	

CV, Cardiovascular; CCI, Charlson Comorbidity Index; PSA, Prostate Specific Antigen; GS, Gleason Score; IR, Intermediate-Risk; RT, Radiation Therapy; Gy, Grey; ADT, Androgen Deprivation Therapy

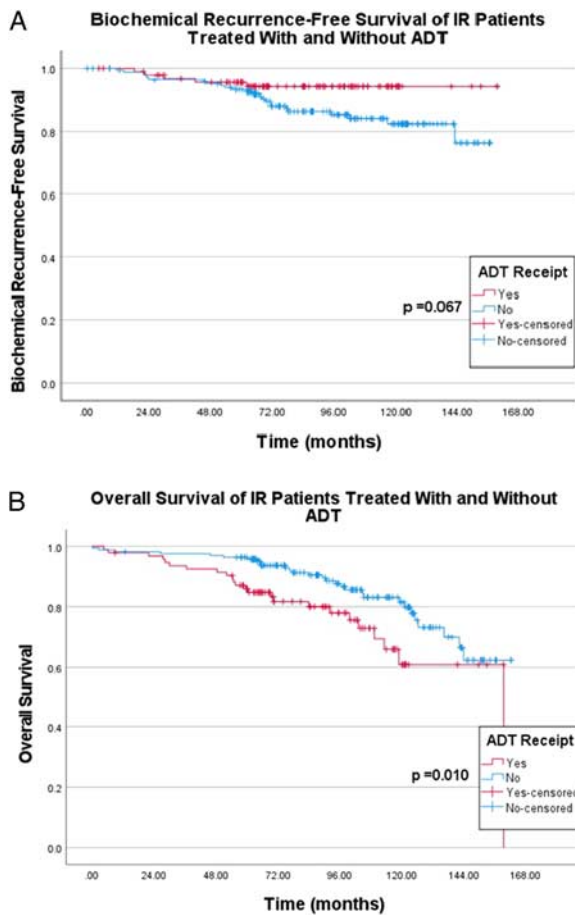

FIGURE 1. A, BCRFS for IR patients treated with and without ADT. B, OS for IR patients treated with and without ADT.

Results: With a median follow-up of 93 months, 260 patients had IR, of which 69.6% (N = 181) had UIR disease, 78.8% (N = 205) were treated with moderately hypofractionated RT to 70 Gy in 28 fractions, and 36.2% (N = 94) received ADT, 89 UIR and 5 FIR, with median ADT duration of 6 months (range, 3-30; 90% received 6 mo). 7-yr BCRFS was 94.1% vs. 86.2%, $P = 0.067$, for ADT and no ADT respectively, and no difference in DMFS or PCSS was observed. ADT was associated with significantly worse 7-yr OS (80.0% vs. 91.3%, $P = 0.010$). When stratified by age, patients <70 years who received ADT had even worse 7-yr OS (93.4% vs. 77.3%, $P = 0.002$), whereas those ≥ 70 years had similar OS ($P = 0.918$). Analysis of the UIR cohort alone, showed similar results; 7-yr BCRFS and 7-yr OS in patients who received ADT versus no ADT were 93.7% vs. 85.9% ($P = 0.093$), and 79.0% vs. 90.6% ($P = 0.019$), respectively.

Conclusions: In our 15-year experience treating IR prostate cancer with dose-escalated IMRT with daily IGRT, short-term concurrent ADT was associated with a statistically significant worse OS as well as non-statistically significant improvement in BCRFS. Additional studies are needed to determine if ADT is beneficial or detrimental for patients with IR prostate cancer treated with dose-escalated radiation (Table 2 and Fig. 1).

(P060) Second Pelvic Cancers (SPCs) Following Radiotherapy for Localized Prostate Cancer: Analysis of Systematic Reviews/Meta-analysis (S/M), SEER Data and Randomized Clinical Trials (RCTs)

Mack Roach, MD¹, Stella Ling, MD¹, Yun Li, MD, PhD¹, ANN LAZAR, PHD²; ¹UCSF, ²UCSF Helen Diller Family Comprehensive Cancer Center

TABLE 1. Second Pelvic Cancers following Radiotherapy for Localized Prostate Cancer: Systematic Reviews/Meta-analysis, SEER Data and Randomized Clinical Trials

First Au. (yr)	No. of studies/pts	RP Control?	Conclusions
Murray (2014)	47/>74,000	yes/GP	Estimated risk ~ 0.5% (1/220) but ~1.4% (1/70) beyond 10 yrs
Jin (2014)	4/647,857	GP	Increased risk > 10 yrs (SIR=1.45)
Lee (2016)	16/NS	yes	RT of prostate cancer had no effect on rectal cancer incidence with the possible exception of a subset treated with EBRT
Wallis (2016)	21/ NS	Yes (n=13); No (n=8)	HR=1.67-1.79, all 3 sites. Highest absolute risk 3.8%,4.2% and 1.2% and lowest 0.1%,0.3% and 0.3% (bladder, colorectal, rectal cancers respectively).
Rombouts (2018)	23/719,823	NS	RR = 1.36 for rectal ca., absolute incidence 0.48% vs 0.41% RT vs no-RT
Zhu (2018)	16/NS	Yes / NS	OR=1.64 and 1.33 for rectal, colon ca. respectively

SIR=Standard incidence rate; GP=general population; NS=not specified; OR=odds ratio; EBRT=external beam radiotherapy.

Second cancers after radiotherapy: Systematic Reviews and SEER Data.

Background: Radiation Oncologist are frequently confronted with questions concerning the risk of SPCs (rectal, colon and or bladder) following the use of definitive external beam radiotherapy (EBRT) in men with localized prostate cancer. Several systematic reviews/meta-analyses (S/M), retrospective studies, and data from a limited number of randomized trials have attempted to shed light on this question. Of note, data from Johns Hopkin’s revealed that men undergoing a radical prostatectomy (RP) had a standardized mortality ratio (SMR)=0.43 (95% CI:0.29-0.57) for subsequent cancers of the colon, rectum, anus and 0.47 (95% CI:0.22-0.73) for subsequent bladder cancer (BC), compared with men in the general population (GP) (Eifler et al. J of Urol, 2012). This observation suggests that studies using post radical prostatectomy (RP) patients as a control for estimating the risk of SPCs after RT may be associated with substantial bias.

Objectives: To determine whether: (1) the literature is in agreement with the estimated risk of SPCs; (2) whether the S/M published to date are likely to be biased by using a RP control group; (3) whether the evidence from RT vs No RT from RCTs supports the magnitude of the risk of SPCs.

Methods: A review of S/M and selected retrospective studies was performed using the search terms “second cancers”, “systematic reviews” and “radiotherapy treatment” and “prostate Cancer”, for the years 2001-2021. In addition, relevant papers identified in the S/Ms, and papers identified through the search (n = 225) were screened by two authors (MR, SL). Twenty-four papers were identified and selected for this analysis, with the most common reason for exclusion being case reports, review articles, modeling dosimetric only analysis, another cancer site or “other”. Six of these papers were characterized as S/M and 15 used Surveillance Epidemiology End Results (SEER) data. Two RCTs involving systemic therapy +/- RT (n = 2) were reviewed for data concerning the risk of SPCs.

Results: Table 1 summarizes the results of the six S/M reported (2014–2018). The standardized incidence rates (SIR), odds ratio (OR), and RR > 1 ranging from 1.33 to 1.79 with the vast majority of studies using post RP patients as the control group. The SEER based studies selected for this analysis, generally resulted in similar estimates of the risk of SPCs. Neither the S/M nor SEER based analyses acknowledged the RP vs RT selection biases, although some performed “propensity matching” and some tested bias (e.g. Ottawa-Newcastle scale). No statistically significant increased risk of second cancers was found involving the rectum or colon for either RCT but a 2% higher risk of bladder cancer was noted beyond 10 years in Scandinavian Prostate Cancer Groups-7 trial.

Conclusions: Based on the available data from S/Ms and population-based studies there appears to be a relatively low but increased risk of SPCs. Given the selection bias associated with the use of RP patients as the major RT comparison group in most of these studies, the actual risk of SPCs is likely to be substantially lower than the estimates reported.

(P061) Non-adaptive MR-guided Radiotherapy for Prostate SBRT: Less Time, Equal Results

Maria Sandoval, MD¹, Kujtim Latifi, PhD¹, G. Daniel Grass, MD, PhD², Javier Torres-Roca, MD², Stephen Rosenberg, MD MS¹, Kosj

Yamoah, MD PhD¹, Peter Johnstone, MD, FACR, FASTRO¹; ¹Moffitt Cancer Center, ²Department of Radiation Oncology, H. Lee Moffitt Cancer Center & Research Institute

Background: The use of stereotactic body radiation therapy (SBRT) is widely utilized for treatment of localized prostate cancer. Magnetic resonance guided radiotherapy (MRgRT) was introduced in 2014 and has recently been implemented in SBRT for prostate cancer, as it provides opportunity for smaller margins and adaptive daily planning. Currently, both publications of MRgRT for prostate SBRT describe European clinical experiences (Alongi, et al *Rad Oncol* 2020; Bruynzeel, et al *Int J Radiat. Oncol. Biol. Phys* 2019), which utilized adaptive planning. However, adaptive planning adds significantly to the time required for daily treatment.

Objectives: Since prostate SBRT has demonstrated acceptable toxicity for several years, we did not consider daily adaptation critical to the process of prostate SBRT. After Institutional Review Board approval, we analyzed and now report our experience using MRgRT without adaptation.

Methods: Between September 25, 2019 and December 21, 2020, 36 consecutive patients were treated with MRgRT prostate SBRT at our center. One patient had Gleason Grade Group (GG) 1, 23 patients had GG 2 and 12 had GG 3 prostate cancer. Nine patients (25%) received adjuvant leuprolide for a median of 4.5 months (range 4–6 m). Our clinical pathway allows for a maximum prostate gland volume of 60cc; median prostate volume of this cohort was 35.0 cc (range 17–58.4 cc). Median pre-treatment PSA was 6.30 (range 2.55–16.77). Each patient was treated with 36.25 Gy delivered in five fractions over 2 weeks with urethral sparing to a maximal dose of 35 Gy. Target volumes included the prostate gland and proximal seminal vesicles with a 3 mm margin.

Results: Median follow-up as of March 15, 2021 was 288 days (range 60–523). At a median of 33 days after completion of SBRT (range 19–102), all patients had first follow-up data available. The median PSA at first visit was 2.75 (range 0.02–9.00) with a median AUA symptom score of 10 (range 1–24). Second follow-up data are available for 31 (86%) patients at a median of 132 days after completion of SBRT (range 77–267). At second follow-up, the median PSA was 1.83 (range 0.02–5.40) with a median AUA symptom score of 6 (range 1–33). Twelve (33.3%) patients had third follow-up data with a median of 294 days (range 141–370) after SBRT. The median PSA was 1.14 (range 0.14–4.61) with an AUA score 8.5 (1–22) at the third follow-up. The most common toxicity was grade 2 urethritis, managed in all cases by tamsulosin. One patient developed grade 2 tenesmus relieved by topical steroids.

Conclusions: By avoiding the extra time required for plan adaptation, MRgRT without daily adaptation allows for successful prostate SBRT with manageable toxicity. We continue to reserve our limited adaptive treatment slots for preoperative pancreatic and ultra-central lung SBRT patients, which require time intensive respiratory gating and adaptive planning.

(P062) Early Results of Patient Reported Quality-of-life After Moderately Hypofractionated Intensity Modulated Proton Therapy Targeting the Prostate and the Regional Pelvic Lymph Nodes for Prostate Cancer

William Wong, MD¹, David Hillman, MS², Carlos Vargas, MD¹, Jean Claude Rwigema, MD¹, Thomas Daniels, MD³, Sameer Keole, MD¹, Bradley Stish, MD², Thomas Pisansky, MD², Richard Choo, MD²; ¹Mayo Clinic Arizona, ²Mayo Clinic Rochester, ³New York University

Background: High-risk prostate cancer (PCa) has an increased risk of occult pelvic nodal metastasis and inclusion of pelvic lymph nodes (PLN) in the clinical target volumes can be considered. Proton therapy has a dosimetric advantage over photons by reducing the integral dose to normal tissues in a large pelvic field, potentially lowering treatment toxicity and improving patient-reported quality-of-life (PRQL).

Objectives: To report early changes in patient reported PRQL using the 26-item Expanded Prostate Index Composite (EPIC-26) questionnaire in a prospective study of moderately hypofractionated intensity modulated PT (H-IMPT) targeting the prostate, seminal vesicles (SV) and PLN concurrently.

Methods: 56 patients (pts) with high-risk or unfavorable intermediate-risk PCa were enrolled. H-IMPT consisted of 45 Gy (RBE 1.1) to PLN and 67.5 Gy (RBE 1.1) to prostate and SV concurrently in 25 daily fractions. All pts received androgen deprivation therapy. PRQL was assessed by the urinary incontinence (UI), urinary irritative/obstructive symptoms (UO) and bowel function (BF) domains of EPIC-26. Mean changes in domain scores were analyzed from baseline, at end of H-IMPT and 3 months thereafter. A clinically meaningful change was defined as a score change >50% of the baseline standard deviation.

Results: 55 pts completed the planned H-IMPT. Median follow-up was 25 months. 62% and 2% experienced acute CTCAE grade 1 and 2 gastrointestinal (GI) adverse events (AE), respectively. 65% and 35% had acute CTCAE grade 1 and 2 genitourinary (GU) AE, respectively. There was no acute grade ≥ 3 GI or GU AE. The mean scores of UO, UI and BF at baseline were 84.6, 91.1 and 95.3, respectively. All three scores declined at the end of H-IMPT (mean score change from baseline: -13.4, -2.74 and -13.7, respectively). The decline in UO and BF scores were both statistically significant and clinically meaningful, while the decline in UI score was not clinically meaningful. At the end of H-IMPT, clinically meaningful decline in UO, UI and BF scores occurred in 54%, 25% and 73% of the pts, respectively. At 3 months after H-IMPT, most acute GI and GU AE resolved, while all 3 PRQL scores improved compared with baseline (mean score change from baseline: 0.64, -0.41 and -6.18, respectively). Fewer pts had clinically meaningful decline in UO, UI and BF scores at 3 months (18%, 20% and 43.9%, respectively) and there was no significant reduction in the mean UO and UI scores compared with baseline. Although mean BF score improved at 3 months compared with the end of H-IMPT, it remained lower than the baseline, and the reduction was clinically meaningful.

Conclusions: This prospective study of H-IMPT targeting both PLN and the prostate/SV showed a decline of UO, UI and BF domains of PRQL in the early post-treatment phase. UO and UI scores improved at 3 months and were similar to the baseline. However, BF score remained lower at 3 months and the decline was clinically meaningful. Follow-up is continuing to assess the late changes in PRQL.

(P063) Factors Affecting Perioperative Length of Stay for Surgically Guided Interstitial Brachytherapy for Gynecologic Malignancies

James Cantrell¹, Gabriel Vidal¹, Pawan Acharya², Patrick Newbury¹, Erich Schnell¹, Sara Vesely², Laura Holman³, Spencer Thompson¹; ¹Department of Radiation Oncology/Stephenson Cancer Center/OUHSC, ²Department of Biostatistics and Epidemiology/OUHSC, ³Department of Gynecologic Oncology/Stephenson Cancer Center/OUHSC

Background: Interstitial brachytherapy (IB) utilizes trans-perineal placement of needle-catheters to deliver a conformal radiation dose, and is used in the treatment of bulky tumors or sites of recurrence not well-covered with traditional intracavitary devices. Historically, the application of IB was without the aid of direct visualization or image guidance, and was associated with significant complication rates. Currently, needle placement is performed under image guidance (ultrasound) or direct visualization (laparoscopy or laparotomy) to improve safety and target coverage. Surgical guidance also allows for creation of an ommental shield providing protection to the organs at risk (OARs) from radiation or mechanical injury from the needles.

Objectives: The goal of this study is to explore factors affecting perioperative length of stay (LOS) in patients treated with surgically-guided IB (SGIB) for locally advanced primary or recurrent gynecological cancer.

Methods: Patients undergoing SGIB between 2010-20 were identified, and both Low Dose Rate (LDR) and High Dose Rate (HDR) cases were included. We used the Kaplan-Meier method with log-rank test for overall survival (OS) and χ^2 test to assess the univariate association between LOS and background characteristics. Survival duration was defined as the time from end of brachytherapy to death or last contact.

Results: A total of 38 patients were treated with SGIB. Mean follow up time was 2.56 years (range 0.1-9.27 y). Patient, disease and treatment characteristics are summarized in Table 1. In the HDR cohort, mean

TABLE 1. Patient, Disease, and Treatment Characteristics

Patient Characteristics	N = 38	%
Age in years (IQR)		
Median(IQR)	67.0(57.0-71.0)	-
Vital status		
Deceased	10	26.3
Living	28	73.7
Race		
Asian American	1	2.6
Asian	1	2.6
Hispanic	1	2.6
Native American	1	2.6
White	34	89.5
Performance Status		
ECOG 0	10	26.3
ECOG 1	20	52.6
ECOG 2	4	10.5
ECOG 3	1	2.6
missing	3	7.9
Pre-Brachytherapy Patient reported QOL		
Low(<=0.8)	9	23.7
High(>0.8)	14	36.8
Missing	15	39.5
Primary site		
Cervix	13	34.2
Vagina	12	31.6
Endometrium	10	26.3
Vulva	2	5.3
Ovary	1	2.6
Histology		
Squamous Cell	21	55.3
Adenocarcinoma	15	39.5
Clear Cell Carcinoma	1	2.6
Serous	1	2.6
Cystadenocarcinoma	1	2.6
Stage		
Stage I	15	39.5
Stage II	10	26.3
Stage III	10	26.3
Stage IV	3	7.9

TABLE 1. (continued)

Tumor Size		
T1	18	47.4
T2	14	36.8
T3	3	7.9
T4	3	7.9
Disease State		
Definitive/Adjuvant	20	52.6
Recurrence	18	47.4
Chemotherapy Concurrent w/ EBRT (Y/N)		
Yes	26	68.4
No	12	31.6
EBRT Dose(cGy)		
Median(IQR)	4500(4500-4860)	-
Mean(std)	4697(414)	-
Brachytherapy Dose (cGy)		
Median(IQR)	3000(3000- 3000)	-
Mean(std)	2882(357)	-
Laparotomy or Laparoscopy		
Laparoscopy	11	28.9
Laparotomy	27	71.1
Omental Bolster (Yes/No)		
Yes	35	92.1
No	3	7.9
Brachytherapy Type		
HDR	26	68.4
LDR	12	31.6
Number of Needles		
Overall	16.0(14.0-19.0)	-
HDR	16.0(13.0-19.0)	-
LDR	17.0(14.0-20.0)	-
Number Seeds/Dwell Positions		
Overall	128.0(98.0-212.0)	-
HDR	151.5(98.0-212.0)	-
LDR	115.0(95.5-182.0)	-
Length of hospital stay(days)		
Median(IQR)	5(4.0-7.0)	-
Mean(std)	5.45(1.9)	-
Length of hospital stay		
Expected	25	65.8
Longer than Expected	13	34.2

LOS for those receiving laparoscopy was 4.63 days versus 5.61 days for laparotomy ($P=0.017$). In the LDR cohort, mean LOS for those receiving laparoscopy was 3 days versus 6.67 days for those receiving laparotomy ($P=0.001$). A cut-off was determined to account for inherent differences in the radiation delivery times between LDR and HDR, e.g., any LDR case with LOS greater than or equal to 5 or any HDR case with a LOS greater than 6 days was considered longer than expected. Univariate analysis was performed using brachytherapy type, T-stage, age, performance status, pre-treatment patient reported QOL, primary or recurrent disease, use of chemotherapy, number of needles placed, and surgical approach to identify factors associated with a longer than expected LOS. Only surgical approach was significant for longer than expected LOS, with 0% (0/11) of the laparoscopy group versus 48% (12/27) of the laparotomy group in the “Longer than Expected” category. OS was not statistically different between the expected and longer than expected LOS groups (Fig. 1).

Conclusions: Surgical approach was the only significant factor affecting LOS on univariate analysis. Unsurprisingly, laparoscopic approach was associated with shorter LOS regardless of brachytherapy type (LDR or HDR). LOS was not associated with a decrease in OS. Further study is warranted to fully explore the potential role of laparoscopy in SGIB.

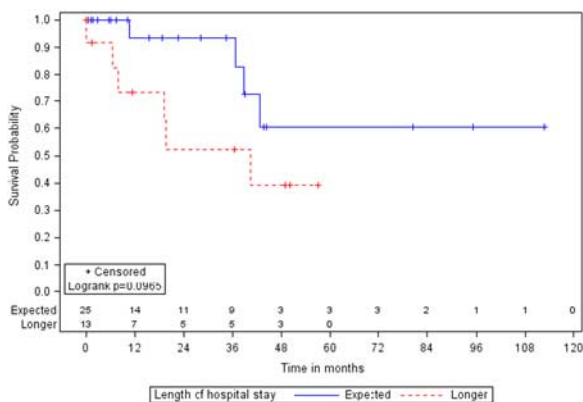

FIGURE 1. Overall survival comparison grouped by LOS.

(P064) Characteristics and Early Outcomes of the First 100 Patients with Cervical Cancer at the National Cancer Center of Cambodia

Jacob Gardner¹, Rath Beauta, MD², Poly Bunpa, MD², Mora Mel, MD², Vannat Ath², Sarameth Thou, MD², Tracy Sherertz, MD³; ¹Case Western Reserve University School of Medicine, ²National Cancer Center, Calmette Hospital, ³Kaiser Permanente Washington

Background: Cervical cancer is the most common cancer reported among women in Cambodia, with an estimated 1500 new cases and 800 deaths annually. The history of cancer care in Cambodia is unfortunately dominated by the Khmer Rouge period from the mid-1970s until the end of the 1990s, during which upwards of 25% of the population was killed. Another casualty was the country's healthcare infrastructure; hospitals were abandoned, equipment was destroyed, and healthcare professionals were persecuted. On January 15th, 2018, Cambodia opened their first dedicated cancer hospital - the National Cancer Center (NCC) - at Calmette Hospital in Phnom Penh to provide modern multidisciplinary cancer care to Cambodian citizens and advanced oncology training for Cambodian health care professionals.

Objectives: We sought to gather descriptive statistics on the demographic, diagnostic, treatment, and outcome data of the first 100 patients with cervical cancer under care at the NCC.

Methods: The medical records of the first 100 patients with cervical cancer treated at the NCC were reviewed for demographic, diagnostic, treatment, and outcome data. Data was drawn from archived paper records and from electronic records on the ARIA Oncology Information System. Descriptive statistics of each metric were calculated in Excel, and included frequency, range, mean and median.

Results: Median age was 55 years. 40% of patients lived in Phnom Penh. 23% of patients presented with stage I disease, 35% with stage II disease, 20% with stage III disease, and 14% with stage IV disease. 42% of patients were treated with definitive surgery, 89% received systemic chemotherapy, 96% received external beam radiation therapy, and 73% received brachytherapy. Of the patients who received chemotherapy, 49.44% were treated concurrently with radiation therapy. For those patients who received definitive-intent radiotherapy, the median cumulative dose (EQD2) from external beam and brachytherapy was as follows: HRCTV D90: 90.8 Gy, bladder maximum 2cc: 77.45 Gy, and rectal maximum 2cc: 69.95 Gy. The median overall treatment time was 148 days. The median follow-up period was 402 days. For the 25 patients for whom follow-up data has been collected, the frequency of acute toxicity - assessed at each patient's last follow-up - was as follows: 25 (100%) had Grade 1 bladder toxicity; 21 (84%) had Grade 1 rectal toxicity; & 4 (16%) had Grade 2 rectal toxicity. For the 14 patients with at least 1 year follow-up, 13 (93%) were alive without recurrence at 12 months.

Conclusions: The opening of the NCC is a watershed moment for improving access to cancer care in Cambodia. The data presented here illustrate future challenges for care and hope for improving outcomes for patients with cervical cancer in Cambodia. This early sample serves as an initial step toward gaining a better understanding of the patient population in Cambodia, and also highlights a need to continue outcomes-based review as the NCC broadens its scope and capacity to provide care to its patients.

(P065) Human Papillomavirus Infection Among Cambodian Patients with Cervical Cancer

Jacob Gardner¹, Rath Beauta, MD², Michel Pluot, MD³, Sarameth Thou, MD², Aun Korn, MD³, Jae Jung, PhD⁴, Tracy Sherertz, MD⁵; ¹Case Western Reserve University School of Medicine, ²National Cancer Center, Calmette Hospital, ³Calmette Hospital, ⁴Lerner Research Institute, Cleveland Clinic Foundation, ⁵Kaiser Permanente Washington

Background: Cervical cancer is the most common cancer reported among women in Cambodia, with an estimated 1500 new cases and 800 deaths annually. Cervical cancer can be prevented by vaccination against its primary causative agent: human papillomavirus (HPV). Cambodia has yet to implement a nationwide HPV vaccination campaign, in large part because it remains unknown which subtypes of HPV pose the greatest oncogenic threat to the Cambodian population. Dozens

of oncogenic HPV subtypes have been identified around the world, and the prevalence and distribution of these various subtypes can vary drastically across geographic regions. It is therefore important to better understand the prevalence of various oncogenic HPV subtypes among Cambodian patients who develop cervical cancer so that the most effective vaccination policy can be developed.

Objectives: 1). To determine which subtypes of HPV are represented in a survey of 100 patients with biopsy-proven cervical cancer at Calmette Hospital in Phnom Penh, Cambodia. 2). To help inform HPV vaccination policy in Cambodia.

Methods: HPV DNA is isolated from the cervical tumor biopsies of 100 patients from Calmette Hospital in Phnom Penh, Cambodia after histological confirmation of cervical squamous cell carcinoma or adenocarcinoma. Fifty samples comprise the "retrospective" cohort, collected from the archives of Calmette's Pathology Department. Fifty additional samples comprise the "prospective" cohort, collected from new patients presenting to Calmette for evaluation and diagnosis of cervical cancer. A microtome is used to section 10, 10µm-thick curls from paraffin blocks containing each patient's biopsy tissue. Commercially available kits are used to deparaffinize the tissue samples and extract and isolate the HPV DNA. A polymerase chain reaction bead-based assay is used to amplify and genotype the viral DNA and identify which subtypes are present in each tissue sample. For each HPV subtype detected, the prevalence among the study population is calculated.

Results: This study is still being carried out and has not produced any results yet. We hypothesize that the HPV subtype prevalence distribution among patients with cervical cancer in Cambodia will be similar to that of patients in Cambodia's neighbor countries Thailand and Vietnam, where such information is already known from prior studies.

Conclusions: The results of this study will be submitted to Cambodia's Ministry of Health for consideration in the development of their HPV vaccination policy.

(P066) Incorporation of Vaginal Brachytherapy to External Beam Radiotherapy in Adjuvant Therapy for High-Risk Early-Stage Cervical Cancer: A Comparative Study

Shahil Mehta, MD, MPH¹, Boniface Yarabe, BA¹, Omar Ragab, MD², David Nusbaum, MD³, Muneaki Shimada, MD⁴, Laurie Brunette, MD¹, Lynda Roman, MD¹, Koji Matsuo, MD, PhD¹; ¹University of Southern California, ²University of Southern California Keck School of Medicine, ³University of Chicago Medicine, ⁴Tohoku University, School of Medicine

Background: For most patients with early stage T1-2 cervical cancer, treatment options include surgical intervention with a hysterectomy or concurrent chemotherapy and external beam radiotherapy (EBRT) followed by a vaginal brachytherapy (VBT) boost. Following hysterectomy there is a role for adjuvant radiation therapy in patients with intermediate risk factors of lympho-vascular space invasion (LVSI), stromal invasion, and large tumor size. Concurrent chemotherapy and EBRT also benefit patients with the high risk factors of positive pelvic nodes, positive surgical margins and/or positive parametria. The role of VBT boost for patients with high risk factors is unclear. The National Comprehensive Cancer Network (NCCN) clinical practice guidelines suggest that it may be most helpful for those with close or positive margins, although the paucity of evidence is noted. Overall the literature does not provide a clear answer as to whether adjuvant EBRT with VBT boost provides additional benefit to high risk early stage cervical cancer patients. The objective of the current study was to examine trends, characteristics, and outcomes of additional VBT after EBRT for high-risk early-stage cervical cancer in the United States.

Objectives: To examine trends, characteristics, and outcomes related to addition of vaginal brachytherapy (VBT) to external beam radiotherapy (EBRT) for adjuvant radiotherapy in high-risk early-stage cervical cancer.

Methods: This comparative study is a retrospective observational analysis of the National Cancer Institute's Surveillance, Epidemiology, and End Results (SEER) Program. Surgically-treated women with stage T1-2 cervical cancer who had high-risk factors (nodal metastasis and/or

parametrial invasion) and received adjuvant radiotherapy from 2000-2018 were examined. Propensity score inverse probability of treatment weighting was used to assess the survival estimates for addition of VBT use.

Results: Among 2,470 women with high-risk factors receiving EBRT, 760 (30.8%) had additional VBT. During the study period, there was an increasing trend of VBT use from 27.4% to 36.1% ($P < 0.001$). In a multivariable analysis, year of diagnosis and high-risk tumor factors: parametrial involvement, large tumor size, and use of chemotherapy remained independent characteristics associated with VBT use (all, $P < 0.05$). In propensity score weighted models, VBT use with EBRT and EBRT alone had comparable overall survival (OS) (5-year rates 73.8% versus 77.4%, hazard ratio 1.07, 95% confidence interval 0.92-1.25). Non-significant association was also observed in squamous vs non-squamous tumors, young vs old age, low vs high lymph node ratio, chemotherapy use, and simple or radical hysterectomy (all, $P > 0.05$). Lastly, the addition of VBT was not associated with cervical cancer-specific survival (subdistribution hazard ratio 1.15, 95% confidence interval 0.94-1.41, $P = 0.170$).

Conclusions: Utilization of VBT with EBRT for adjuvant radiotherapy in high-risk early stage cervical cancer is increasing in the United States. Addition of VBT is associated with neither overall survival nor cancer specific survival.

(P067) Clinical and FDG-PET Tumor Characteristics Associated with Early Versus Late Distant Metastasis Following Curative Chemoradiation of Cervical Cancer

Suvidya Lakshmi Pachigolla, BSE¹, Alexander Lin, MD/PhD², Leslie Massad, MD¹, Premal Thaker, MD¹, David Mutch, MD¹, Matthew Powel, MD¹, Farrokh Dehdashti, MD¹, Barry A SIEGEL SIEGEL, MD³, Julie Schwarz, MD/PhD¹, Stephanie Markovina, MD/PhD¹, Perry Grigsby, MD¹; ¹Washington University in St. Louis, ²Washington University in Saint Louis, ³Washington University

Background: Distant failure is the predominant pattern of failure for locally advanced cervical cancer treated with modern image-guided radiation therapy (Tan et al IJROBP 2019). Distant recurrence can be

apparent as early as 3 months after completion of therapy (Schwarz et al IJROBP 2012), which may signal an aggressive tumor biology. Identification of factors associated with early distant metastasis could help select patients most likely to benefit from adjuvant systemic therapy.

Objectives: To determine risk factors associated with early vs late distant recurrence in cervical cancer following definitive chemoradiation.

Methods: We included patients treated at an academic medical center with FIGO Stage IB-IVA cervical cancer staged with FDG-PET who completed curative chemoradiation therapy with brachytherapy, with a minimum of 3 months follow-up and restaging FDG-PET. Patients who subsequently developed biopsy-proven distant metastasis were categorized to have earliest (3-6 mo), early (6-24 mo) or late (>24 mo) recurrence following completion of therapy. Fisher's exact test and Mann-Whitney U test were computed for categorical and continuous variables, respectively. Logistic regression was used to calculate odds ratios (ORs) with 95% confidence intervals (CI). Kaplan-Meier analysis demonstrated differences in the timing of distant only vs concurrent distant + local failure.

Results: Of 574 patients treated with curative chemoradiation, 143 (25%) developed distant metastasis: 45 (31.5%) earliest, 65 (45.5%) early, and 33 (23%) late. Among these three groups, there were no significant differences in age, race, FIGO 2009 stage, metabolic tumor volume, SUVmax, treatment length, or baseline/end-of-treatment squamous cell carcinoma antigen (SCCA) levels. New areas of FDG-uptake on 3-month post-treatment scan predicted the development of distant metastasis within 6 months in 86% of cases and 100% of cases by 2 years out from treatment. Compared with patients with late distant metastasis, patients with earliest and early distant recurrences were more likely to have PET-positive lymph nodes at diagnosis. Neither pre-treatment nor end-of-treatment variables were significantly different comparing the earliest vs early groups, so these patients were combined for comparison with the late group. Patients with distant metastasis within 2 years of radiation were more likely to have PET-positive lymph nodes at diagnosis (OR: 3.0, 95% CI 1.4-6.9, $P = 0.006$). There were 39 (27.3%) patients who also experienced local recurrence concurrently with their distant metastasis. Figure 1 shows that patients with early distant metastasis were more likely to have concurrent local failure than patients with late distant metastasis.

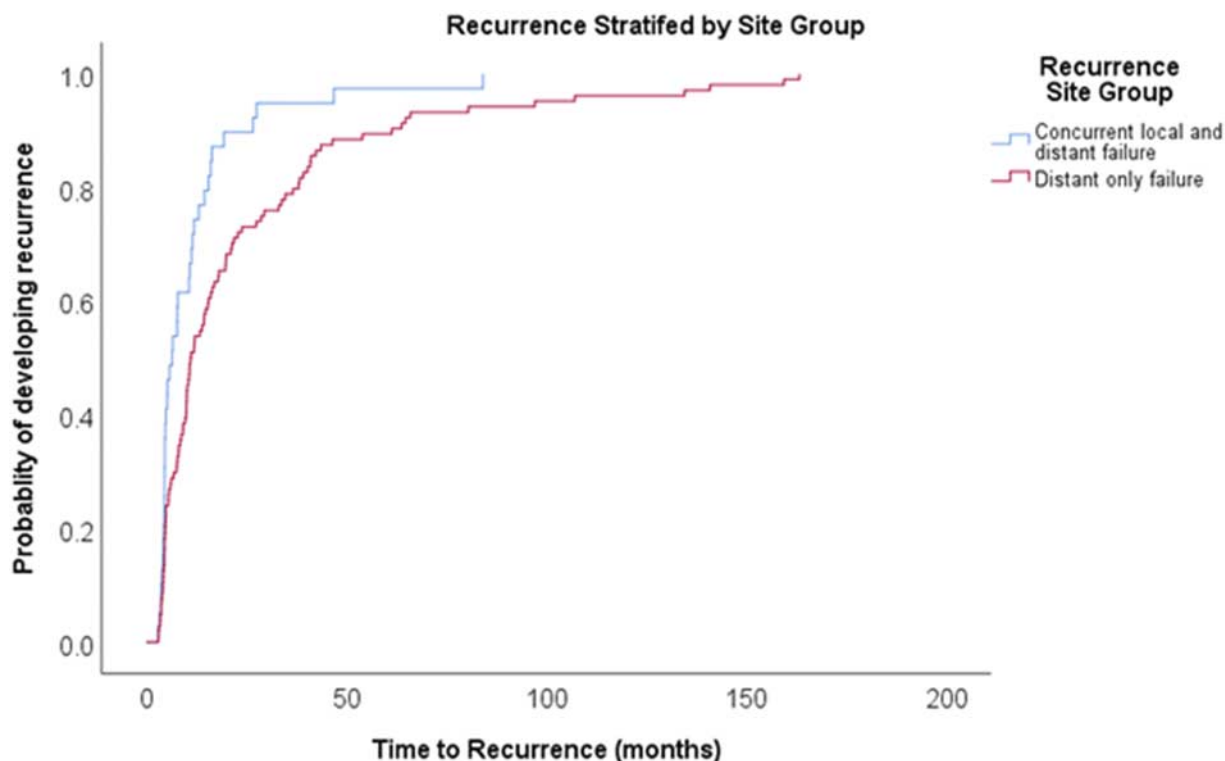

FIGURE 1. Kaplan-Meier curve showing time to recurrence stratified by distant alone recurrence vs. concurrent local and distant failure.

TABLE 1. Patient, Tumor, and Treatment Characteristics

	Earliest (3-6 months) N = 45 (31.5%)	Early (7-24 months) N = 65 (45.5%)	Late (\geq 24 months) N = 33 (23%)	p-value
Age	50 (23 – 85)	49 (31 – 85)	47 (27 – 77)	0.64
Race				0.72
Caucasian	31 (33.7%)	42 (45.7%)	19 (20.7%)	
African American	13 (26.5%)	22 (44.9%)	14 (28.6%)	
Hispanic	1 (50%)	1 (50%)	0 (0%)	
Histology				0.57
Squamous	37 (30.1%)	58 (47.2%)	28 (22.8%)	
Non-squamous	8 (40%)	7 (35%)	5 (25%)	
FIGO 2009 Stage				0.84
IB1	2 (28.6%)	4 (57.1%)	1 (14.3%)	
IB2	9 (32.1%)	12 (42.9%)	7 (25%)	
IIA1	0 (0%)	0 (0%)	1 (100%)	
IIB	17 (33.3%)	20 (39.2%)	14 (27.5%)	
IIIA	1 (25%)	2 (50%)	1 (25%)	
IIIB	14 (30.4%)	23 (50%)	9 (19.6%)	
IVA	2 (33.3%)	4 (66.7%)	0 (0%)	
FIGO 2009 Stage				0.38
I-II	28 (32.2%)	36 (41.4%)	23 (26.4%)	
III - IV	17 (30.4%)	29 (51.8%)	10 (17.9%)	
Median Metabolic Tumor Volume (mL)*	57.8 (3.13 – 398.3)	35.2 (2.7 – 248.3)	42.1 (3.9 – 150)	0.15
Cervix SUV max*	13.9 (6 – 38)	14.1 (4.8 – 50.4)	12.3(5.1 – 50.4)	0.27
PET Pelvic Lymph Nodes				0.03
None	7 (16.7%)	19 (45.2%)	16 (38.1%)	
Pelvic	23 (35.4%)	29 (44.6%)	13 (20%)	
Pelvic and Para-aortic	15 (41.7%)	17 (47.2%)	4 (11.1%)	
PET Lymph Nodes				0.007
Negative	7 (16.7%)	19 (45.2%)	16 (38.1%)	
Positive	38 (37.6%)	46 (45.5%)	17 (16.8%)	
Brachytherapy				0.22
LDR	6 (37.5%)	4 (25%)	6 (37.5%)	
HDR	39 (31.2%)	59 (47.2%)	27 (21.6%)	
None	0 (0%)	2 (100%)	0 (0%)	
EBRT Planning				0.026
2D	16 (25.8%)	25 (40.3%)	21 (33.9%)	
IMRT	29 (35.8%)	40 (49.4%)	12 (14.8%)	
Median Treatment Days	49 (39 – 101)	51 (41 – 97)	50 (41 – 78)	0.41
SCCA at Diagnosis*	2.1 (0 – 43.3)	2.4 (0 – 87.8)	3.4 (0-32.9)	0.89
Delta SCCA*	1.2 (-8.3 – 32.9)	1.4 (-1.6 – 86.50)	4.8 (-1.5 – 32.9)	0.63
SCCA at RT comp*	1.1 (0 – 21.6)	1 (0 – 3.6)	0 (0 – 1.5)	0.14
Follow up FDG-PET				<0.001
No abnormal uptake	1 (1.3%)	47 (60.3%)	30 (38.5%)	
Persistent uptake only	2 (12.5%)	11(68.8%)	3 (18.8%)	
New uptake	42 (85.7%)	7 (14.3%)	0 (0%)	

*Number of Cases Missing Data: Metabolic Tumor Volume–49; Cervix SUV Max–27; SCCA at Diagnosis–78; Delta SCCA–90; SCCA at RT Completion–90

Conclusions: Lymph node metastasis at time of diagnosis was the only distinguishing risk factor for earliest/early vs. late distant metastasis. The biological mechanisms that trigger late metastasis deserve further exploration (Table 1).

(P068) Clinical and FDG-PET Tumor Characteristics Associated with Early versus Late Distant Metastasis Following Curative Chemoradiation of Cervical Cancer

Alexander Lin, MD, PhD¹, Suvidya Lakshmi Pachigolla, BSE², Leslie Massad, MD², Premal Thaker, MD², David Mutch, MD², Matthew Powel, MD², Farrokh Dehdashti, MD², Barry A Siegel Siegel, MD³, Julie Schwarz, MD, PhD², Stephanie Markovina, MD, PhD², Perry Grigsby, MD²; ¹Washington University in Saint Louis, ²Washington University in St. Louis, ³Washington University

Background: Distant failure is the predominant pattern of failure for locally advanced cervical cancer treated with modern image-guided radiation therapy (Tan et al IJROBP 2019). Distant recurrence can be apparent as early as 3 months after completion of therapy (Schwarz et al IJROBP 2012), which may signal an aggressive tumor biology. Identification of factors associated with early distant metastasis could help select patients most likely to benefit from adjuvant systemic therapy.

Objectives: To determine risk factors associated with early vs late distant recurrence in cervical cancer following definitive chemoradiation.

Methods: We included patients treated at an academic medical center with FIGO Stage IB-IVA cervical cancer staged with FDG-PET who completed curative chemoradiation therapy with brachytherapy, with a minimum of 3 months follow-up and restaging FDG-PET. Patients who subsequently developed biopsy-proven distant metastasis were

categorized to have earliest (3-6 mo), early (6-24 mo) or late (> 24 mo) recurrence following completion of therapy. Fisher's exact test and Mann-Whitney U test were computed for categorical and continuous variables, respectively. Logistic regression was used to calculate odds ratios (ORs) with 95% confidence intervals (CI). Kaplan-Meier analysis demonstrated differences in the timing of distant only vs concurrent distant + local failure.

Results: Of 574 patients treated with curative chemoradiation, 143 (25%) developed distant metastasis: 45 (31.5%) earliest, 65 (45.5%) early, and 33 (23%) late. Among these three groups, there were no significant differences in age, race, FIGO 2009 stage, metabolic tumor volume, SUVmax, treatment length, or baseline/end-of-treatment squamous cell carcinoma antigen (SCCA) levels. New areas of FDG-uptake on 3-month post-treatment scan predicted the development of distant metastasis within 6 months in 86% of cases and 100% of cases by 2 years out from treatment. Compared with patients with late distant metastasis, patients with earliest and early distant recurrences were more likely to have PET-positive lymph nodes at diagnosis. Neither pre-treatment nor end-of treatment variables were significantly different comparing the earliest vs early groups, so these patients were combined for comparison with the late group. Patients with distant metastasis within 2 years of radiation were more likely to have PET-positive lymph nodes at diagnosis (OR: 3.0, 95% CI 1.4–6.9, $P=0.006$). There were 39 (27.3%) patients who also experienced local recurrence concurrently with their distant metastasis. Figure 1 shows that patients with early distant metastasis were more likely to have concurrent local failure than patients with late distant metastasis.

Conclusions: Lymph node metastasis at time of diagnosis was the only distinguishing risk factor for earliest/early vs. late distant metastasis. The biological mechanisms that trigger late metastasis deserve further exploration (Table 1).

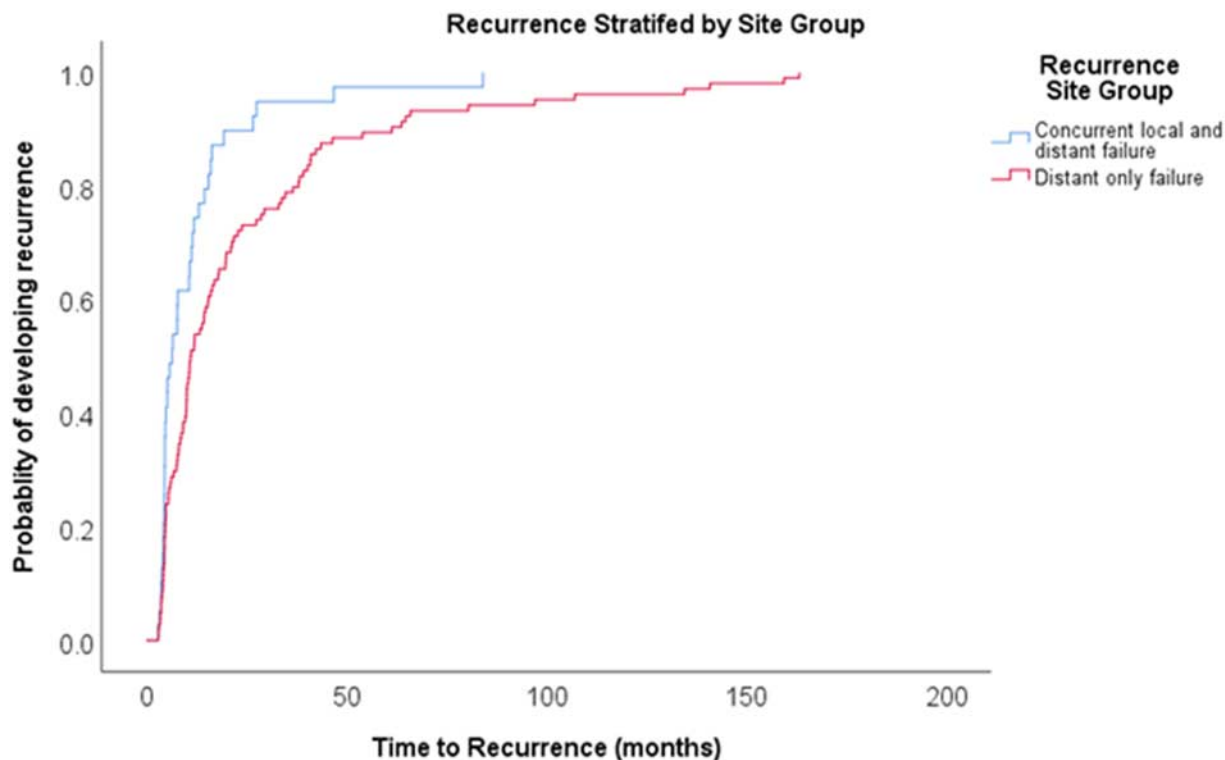

FIGURE 1. Kaplan-Meier curve showing time to recurrence stratified by distant alone recurrence vs. concurrent local and distant failure.

TABLE 1. Patient, Tumor, and Treatment Characteristics

	Earliest (3-6 months) N = 45 (31.5%)	Early (7-24 months) N = 65 (45.5%)	Late (\geq 24 months) N = 33 (23%)	p-value
Age	50 (23 – 85)	49 (31 – 85)	47 (27 – 77)	0.64
Race				0.72
Caucasian	31 (33.7%)	42 (45.7%)	19 (20.7%)	
African American	13 (26.5%)	22 (44.9%)	14 (28.6%)	
Hispanic	1 (50%)	1 (50%)	0 (0%)	
Histology				0.57
Squamous	37 (30.1%)	58 (47.2%)	28 (22.8%)	
Non-squamous	8 (40%)	7 (35%)	5 (25%)	
FIGO 2009 Stage				0.84
IB1	2 (28.6%)	4 (57.1%)	1 (14.3%)	
IB2	9 (32.1%)	12 (42.9%)	7 (25%)	
IIA1	0 (0%)	0 (0%)	1 (100%)	
IIB	17 (33.3%)	20 (39.2%)	14 (27.5%)	
IIIA	1 (25%)	2 (50%)	1 (25%)	
IIIB	14 (30.4%)	23 (50%)	9 (19.6%)	
IVA	2 (33.3%)	4 (66.7%)	0 (0%)	
FIGO 2009 Stage				0.38
I-II	28 (32.2%)	36 (41.4%)	23 (26.4%)	
III - IV	17 (30.4%)	29 (51.8%)	10 (17.9%)	
Median Metabolic Tumor Volume (mL)*	57.8 (3.13 – 398.3)	35.2 (2.7 – 248.3)	42.1 (3.9 – 150)	0.15
Cervix SUV max*	13.9 (6 – 38)	14.1 (4.8 – 50.4)	12.3(5.1 – 50.4)	0.27
PET Pelvic Lymph Nodes				0.03
None	7 (16.7%)	19 (45.2%)	16 (38.1%)	
Pelvic	23 (35.4%)	29 (44.6%)	13 (20%)	
Pelvic and Para-aortic	15 (41.7%)	17 (47.2%)	4 (11.1%)	
PET Lymph Nodes				0.007
Negative	7 (16.7%)	19 (45.2%)	16 (38.1%)	
Positive	38 (37.6%)	46 (45.5%)	17 (16.8%)	
Brachytherapy				0.22
LDR	6 (37.5%)	4 (25%)	6 (37.5%)	
HDR	39 (31.2%)	59 (47.2%)	27 (21.6%)	
None	0 (0%)	2 (100%)	0 (0%)	
EBRT Planning				0.026
2D	16 (25.8%)	25 (40.3%)	21 (33.9%)	
IMRT	29 (35.8%)	40 (49.4%)	12 (14.8%)	
Median Treatment Days	49 (39 – 101)	51 (41 – 97)	50 (41 – 78)	0.41
SCCA at Diagnosis*	2.1 (0 – 43.3)	2.4 (0 – 87.8)	3.4 (0-32.9)	0.89
Delta SCCA*	1.2 (-8.3 – 32.9)	1.4 (-1.6 – 86.50)	4.8 (-1.5 – 32.9)	0.63
SCCA at RT comp*	1.1 (0 – 21.6)	1 (0 – 3.6)	0 (0 – 1.5)	0.14
Follow up FDG-PET				<0.001
No abnormal uptake	1 (1.3%)	47 (60.3%)	30 (38.5%)	
Persistent uptake only	2 (12.5%)	11(68.8%)	3 (18.8%)	
New uptake	42 (85.7%)	7 (14.3%)	0 (0%)	

*Number of Cases Missing Data: Metabolic Tumor Volume–49; Cervix SUV Max–27; SCCA at Diagnosis–78; Delta SCCA–90; SCCA at RT Completion–90.

(P069) Clinical Outcomes and Dosimetric Data for Patients with Gynecologic Malignancies: A Comparison Between a Proton and Photon Matched Cohort

Ariel Pollock, MD¹, Hunter Risher, MS², Kai Sun, MS³, Ishan Oza⁴, Kimberly Marter, CMD¹, David Alicia, CMD¹, Gautam Rao, MD⁵, Dana Roque, MD⁵, Elizabeth Nichols, MD⁶, Pranshu Mohindra, MD, MBBS⁷; ¹Department of Radiation Oncology, University of Maryland Medical Center, ²University of Maryland School of Medicine, ³University of Maryland School of Medicine Department of Epidemiology and Public Health, ⁴University of Maryland College Park, ⁵Division of Gynecologic Oncology, University of Maryland School of Medicine, ⁶Department of Radiation Oncology, University of School of Medicine, ⁷Department of Radiation Oncology, University of Maryland School of Medicine

Background: Radiation (RT) for treatment of gynecologic (gyn) malignancies confers a risk of gastrointestinal (GI), genitourinary (GU), and hematologic (heme) toxicity. Proton therapy (PT) may confer superior dosimetric sparing of bowel, bladder and marrow than volumetric arc therapy (VMAT), though supporting clinical data is lacking. **Objectives:** In this IRB-approved retrospective matched-pair analysis, we analyzed clinical outcomes and dosimetric differences between intensity modulated proton therapy (IMPT) and VMAT when treating gyn patients.

Methods: Patients with gyn malignancies treated with definitive or adjuvant whole-pelvic (± para-aortic) IMPT and VMAT between 2014-2020 were analyzed. Patients with prior in-field RT were excluded. IMPT patients were matched 1:2 with a VMAT cohort (based on receipt/timing of chemotherapy (ChT), RT field, and receipt of surgery). The Kaplan-Meier (KM) method was used to estimate overall survival (OS). A conditional logistic regression was performed to

compare incidence of grade 2+ and grade 3+ toxicity. A t-test analysis was performed to compare mean dosimetric parameters.

Results: The cohort included 28 patients treated with IMPT and 51 treated with VMAT (total N = 79). Sites included uterus (n = 52), cervix (n = 16), vagina (n = 3), vulva (n = 5) and ovary (n = 3). Median initial dose for IMPT and VMAT was 50.4 and 45 Gy, respectively. Overall, 43% of patients received adjuvant RT, 75% received ChT of which 38% was concurrent. With a median follow up of 23 months, the 1-year OS was 92% (95% CI 82-100%) and 88% (9% CI 80-96%) for IMPT and VMAT cohort, respectively, P=0.6. The differences in incidence of any grade 2+ acute toxicity (n=9, 32% vs n=18, 35%), any grade 3+ acute toxicity (n=2, 7% vs n=10, 20%), any grade 2+ late toxicity (n=6, 21% vs n=10, 20%) and GI/GU grade 3+ late toxicity (n=1, 4% vs n=4, 8%) between IMPT and VMAT were not statistically significant. All acute grade 3+ toxicity in proton cohort were heme while acute grade 3+ photon toxicities included heme, small bowel obstruction (SBO) and diarrhea. Late GI/GU grade 3+ toxicity in proton cohort were RT enteritis in one patient versus SBO (2 patients) and fistula (2 patients) in VMAT cohort. Upon dosimetric comparison, bone marrow V10 Gy (P < 0.001) and V20 Gy (P < 0.001), small bowel V15 Gy (P < 0.001) and V45 Gy (P < 0.001) were lower with IMPT but rectum V40 Gy was lower with VMAT (P = 0.03). No significant differences were seen in bone marrow V40 Gy and bladder V40 Gy.

Conclusions: This initial clinical report of gyn cancer patients treated with IMPT demonstrates excellent tolerance and efficacy with possible signal of acute (marrow) and late (GI/GU) toxicity reduction with IMPT, corroborated by dosimetric superiority of IMPT in reducing marrow and small bowel dose. This hypothesis generating data supports need for an appropriately powered prospective trial to test utility of IMPT (Fig. 1).

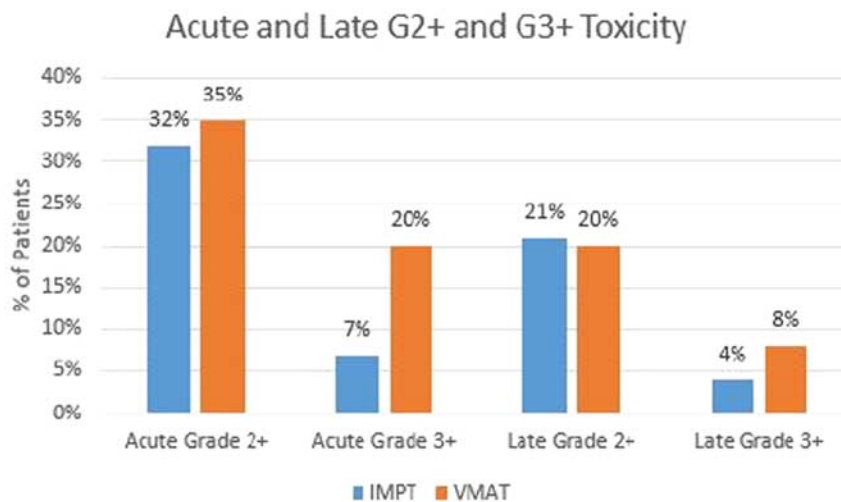

Acute Toxicity	IMPT n=28 (%)	VMAT n= 51(%)	HR	p-value
Grade 2+ GI	5 (18%)	4 (8%)	1.55	0.42
Grade 2+ GU	1 (4%)	6 (11%)	0.32	0.29
Grade 2+ Heme	3 (10%)	12 (24%)	0.44	0.22
Grade 3+ GI	0	2 (4%)	0	0.99
Grade 3+ GU	0	1 (2%)	0	0.99
Grade 3+ Heme	2 (7%)	8 (16%)	0.56	0.45
Any grade 2+	9 (32%)	18 (35%)	0.83	0.7
Any grade 3+	2 (7%)	10 (20%)	0.44	0.28

FIGURE 1. Acute and late grade 2+ and grade 3+ toxicity.

(P070) Patterns of Care and Outcomes of Radiotherapy And/or Hormone Therapy in Medically Inoperable Endometrial Adenocarcinoma

Leonid Reshko, MD¹, Jeremy Gaskins, PhD², Alyssa Farley, BS², Abbas Rattani, MD², Grant McKenzie, MD², Scott Silva, MD, PhD¹; ¹Department of Radiation Oncology/University of Louisville, ²University of Louisville

Background: Medically inoperable endometrioid adenocarcinoma of the endometrium is a challenging clinical entity as definitive surgery with risk-adaptive adjuvant therapy is the standard of care (Abu-Rustum, et al NCCN 2021 and Colombo, et al Int J of Gyn Cancer 2016). It is unknown whether definitive radiotherapy (RT) and/or hormone therapy (HT) provide the optimal oncologic outcomes due to the absence of randomized data (Schwarz, et al Brachytherapy 2015; Kupelian, et al IJROBP 1993; Podzielinski, et al Gynecologic Oncology 2012; Nikolopoulos, et al Obstet Gynecol Sci 2020, Macchia, et al Oncology Letters 2016).

Objectives: The goal of this study is to evaluate the patterns of care and efficacy of RT and/or HT in the treatment of medically inoperable endometrial adenocarcinoma.

Methods: We performed a query of the National Cancer Database (NCDB) of patients with medically inoperable endometrioid adenocarcinoma of the endometrium diagnosed between 2004 and 2016. Included in this analysis were patients in which definitive surgery was not performed because it was contraindicated due to patient comorbidities. Additionally, patients were only included if they received either RT, HT or both; did not receive chemotherapy; were neither stage 0 nor 4; were treated within 4 months of diagnosis and had a follow-up time of at least 4 months. A Cox model was constructed to evaluate

TABLE 2. Cox Proportional Hazards Analysis of Factors that Affect Survival

	Adj HR	95% CI	P-values
Treatment			0.0296
RT only	Reference		
HT only	1.25	1.02 1.54	0.0322
RT+HT	1.48	1.00 2.19	0.0524
Age			< .0001
25-59	Reference		
60-69	1.72	1.31 2.25	< .0001
70+	3.01	2.32 3.90	< .0001
Charlson/Deyo comorbidity score			0.0004
Absent	Reference		
Present	1.33	1.14 1.56	0.0004
Insurance Status			0.0453
Private Insurance	Reference		
Not Insured	1.37	0.74 2.52	0.3202
Govt	1.36	1.06 1.74	0.0162
Distance to Facility			0.0957
Less than 15 miles	Reference		
Between 15 and 50 miles	1.11	0.92 1.33	0.2627
50 or greater miles	0.83	0.64 1.08	0.1573
Treatment Facility Volume			0.0634
Lowest Third	Reference		
Middle Third	0.81	0.67 0.99	0.0423
Largest Third	0.81	0.66 0.99	0.0430
Grade			< .0001
1	Reference		
2	1.11	0.91 1.34	0.2962
3	2.09	1.61 2.71	< .0001
Unknown	1.34	1.06 1.69	0.0150

TABLE 1. Multinomial Logistic Regression Model of Factors that Affect Hormone Therapy, Radiotherapy or Combination of Hormone Therapy and Radiotherapy Utilization

	p-value	HT-only vs RT-only				RT+HT vs RT-only			
		OR	LCI	UCI	p-value	OR	LCI	UCI	p-value
Age	0.0031								
25-59		Reference				Reference			
60-69		0.75	0.51	1.10	0.1404	2.27	0.84	6.09	0.1047
70+		0.54	0.38	0.77	0.0006	1.26	0.47	3.34	0.6437
Charlson/Deyo comorbidity scor	0.1296								
Absent		Reference				Reference			
Present		0.73	0.54	0.99	0.0440	0.92	0.47	1.80	0.8086
Diagnosis Year	0.0048								
2004-2006		Reference				Reference			
2007-2009		1.77	1.00	3.12	0.0500	1.67	0.51	5.50	0.3972
2010-2012		2.22	1.27	3.86	0.0050	1.57	0.47	5.21	0.4599
2013-2015		2.86	1.68	4.88	0.0001	1.76	0.55	5.64	0.3409
Facility Case Volume	0.0574								
Lower Third		Reference				Reference			
Middle Third		1.36	0.94	1.96	0.1055	0.63	0.25	1.53	0.3053
Upper Third		1.60	1.11	2.33	0.0125	1.33	0.62	2.84	0.4679
Grade	< .0001								
1		Reference				Reference			
2		0.60	0.41	0.86	0.0055	1.05	0.48	2.30	0.9090
3		0.08	0.03	0.27	< .0001	0.65	0.18	2.33	0.5059
Unknown		0.88	0.60	1.29	0.5083	1.07	0.41	2.78	0.8899
Urban/Rural area	0.0102								
Metro		Reference				Reference			
Urban		0.63	0.42	0.94	0.0231	1.17	0.53	2.57	0.7039
Rural		0.25	0.07	0.85	0.0272	0.00	0.00	Inf	0.9864
Unknown		3.20	1.38	7.40	0.0065	4.77	1.21	18.83	0.0258

survival after controlling for confounding variables. A multinomial logistic regression model was used to assess predictors of RT and/or HT use.

Results: A total of 1,063 patients were included in this cohort. Patients who received RT compared with HT were more likely to be older, be diagnosed in earlier years, have government-issued insurance, be treated at a lower-case volume center, have high-grade disease, have serious medical comorbidities and live outside of metro areas as shown in Table 1. Unadjusted 5-yr survival was 43.2% in patients receiving HT compared with 37.3% in patients receiving RT. However, on multivariate analysis, patients who received HT had worse overall survival compared with patients who received RT (adjusted hazard ratio (aHR) 1.25; 95% CI 1.02–1.54; $P=0.0322$). Only 38 patients received both RT and HT compared with 275 who received HT alone and 750 treated with RT alone. There was borderline evidence that the combination of RT and HT did worse than RT alone (aHR 1.48; 95% CI 1.00–2.19; $P=0.0524$). Other factors associated with worse survival were older age, presence of serious medical comorbidities, government-issued insurance, treatment at a lower-case volume center and high-grade histology as shown in Table 2.

Conclusions: We identified factors associated with the receipt of RT and/or HT in medically inoperable endometrial cancer patients. The receipt of RT appears to correlate with superior survival than treatment with HT alone when accounting for confounding variables. There was an insufficient number of patients treated with a combination of RT and HT to draw a conclusion regarding the efficacy of this regimen.

(P071) Robotically Assisted Intra-Operative Radiation Therapy

Houman Vaghefi, MD, PhD¹, Pamela Stone, MD¹, James Wheeler, MD, PhD¹, John Lowden, DABR², Samantha Korda, DABR², Irina Sparks, MD², Grace Darnell, NP²; ¹Goshen Cancer Center, ²Goshen Center for Cancer Care

Background: Robotic surgery is one of the standards of care in the surgical management of gynecologic malignancy. One of the goals of an oncologic resection is to achieve negative margins. However, in some instances an R0 resection is not achieved, which could lead to increased local failure. Local control could be achieved by adjuvant radiotherapy, commonly delivered with external beam radiotherapy. Intra-operative Radiotherapy (IORT) is a technique where a single intraoperative dose of radiation is delivered to the target. In robotic resection IORT is usually not considered due to small port sites that can

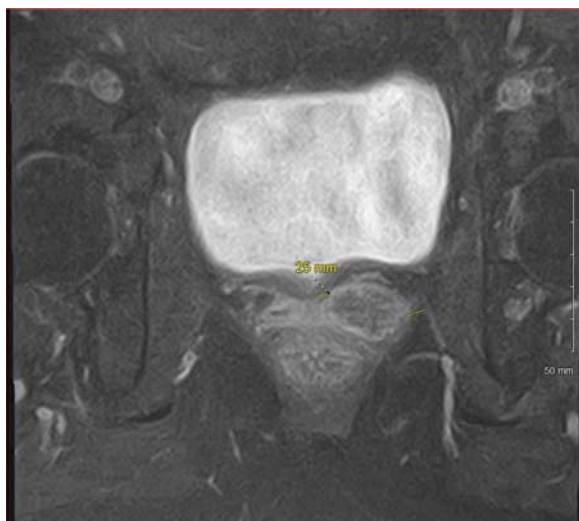

FIGURE 1. MRI Axial T1 post-contrast image of the mass adjacent to the vaginal cuff.



FIGURE 2. Intra-operative photo representing the IORT catheter, introduced through the vagina, secured by the robotic arm, while the bladder is tethered away out of the radiation field.

preclude the IORT applicator. However, transvaginal approach allows adequate and safe physical space to deliver IORT.

Objectives: We describe the first published report of robotic surgery using a transvaginal approach to safely deliver balloon based IORT.

Methods: 75-year-old female with a nebulous past medical history significant for a gynecologic malignancy, treated with TAH/BSO in 1994 and radiation therapy. She presented with vaginal pain and drainage. Physical exam showed a mass in the fornix, extending to the vaginal cuff. Pelvic MRI revealed a 2.8 cm pelvic mass adjacent to the vaginal cuff (Fig. 1). PET/CT showed no metastasis. She underwent a robotically assisted radical upper vaginectomy, bilateral pelvic node mapping and sampling, and bilateral pelvic node dissection. Intra-operatively, it became apparent that the resection of the tumor resulted in the dissection to the left levator ani muscle over the rectum without entry into the rectal mucosa. All margins were marked, and tissue was sent for rapid frozen section and were noted to be positive for tumor. Therefore, a decision was made to deliver IORT. The target adjacent to the rectum was estimated to be superficial and within the adequate range of the 50KvP source. A 3-4 cm XOFT (TM) catheter was selected and filled to 30mL. The IORT catheter was introduced with a transvaginal approach after removal of the specimen. The catheter was docked through the opened vaginectomy site and secured for IORT. The bladder and the right ureter were tethered away from the radiation field by the robot. Trendelenburg position ensured that the bowel was moved out of the radiation field and 10 Gy was delivered (Fig. 2). The patient had no apparent complications and was discharged in post-operative day 1.

Results: Pathology showed G2, moderately differentiated invasive squamous cell carcinoma with the tumor originating at the vaginal cuff and extending deeply into the paravaginal tissue, positive for LVI and PNI. The deep margin was positive, with 14 negative nodes. She was staged to have a rpT2bN0 squamous cell carcinoma.

Conclusions: For select patients who have undergone prior radiation therapy and whose imaging studies indicate a high risk for encountering positive margins at the time of salvage surgery, IORT may be a feasible treatment option using the XOFT balloon applicator even in conjunction with robotic surgery.

(P072) Vulvar Recurrence and Survival in Patients Undergoing Adjuvant Radiation for High-Risk Vulvar Cancer

Alison Yoder, MD, MPH¹, David Lakomy, BA², Kelsey Corrigan, MD, MPD¹, Anuja Jhingran, MD¹, Ann H. Klopp, MD, PhD³, Melissa Joyner, MD, MBA⁴, Lauren Colbert, MD, MSCR¹, Patricia Eifel, MD¹, Lillie Lin, MD¹; ¹MD Anderson Cancer Center, ²Dartmouth College Geisel School of Medicine, ³The University of Texas MD Anderson Cancer Center, ⁴M.D. Anderson Cancer Center

Background: Vulvar cancer is rare and primarily treated with surgical resection. Adjuvant radiation therapy (RT) is recommended for patients with close or positive margins or positive nodal disease.

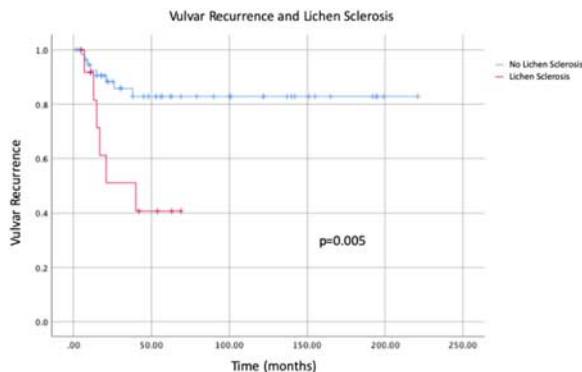

FIGURE 1. Lichen sclerosis and vulvar recurrence. Kaplan-Meier curve comparing vulvar recurrence in patients going through adjuvant radiation for vulvar carcinoma with and without lichen sclerosis, log-rank $P=0.005$.

Objectives: We evaluated demographic, clinical, and treatment variables that might be associated with vulvar recurrence (VR) in patients with vulvar cancer treated with postoperative RT with or without chemotherapy.

Methods: After obtaining IRB approval, we retrospectively reviewed the records of 69 vulvar cancer patients who were treated at our institution with vulvar resection followed by RT between 1999 and 2019. The median total dose of RT to the vulva was 54 Gy (range 40-64) in 25 (20-33) fractions, with median RT duration of 39 days (27-53). RT boost was given to the vulva in the majority of cases with close or positive margins, median dose of 6 Gy (0-20). All time variables were calculated from the start of RT. Variables associated with VR were analyzed using cox proportional hazard model. The median follow-up duration was 53 months.

Results: Most patients were White ($n=46/69$, 67%) and the majority ($n=60$, 87%) had squamous cell carcinomas. Thirteen patients (18.6%) had a history of lichen sclerosis (LS) diagnosed either before their cancer diagnosis or at time of surgical resection. Most patients had only one prior surgical resection before RT ($n=44$, 64%), though 22 (32%) had two prior resections and 3 (4%) underwent 3 total resections before RT. Fourteen patients had VR after receiving adjuvant RT; median time of 15 months. Patients with positive margins (HR 0.66, $P=0.50$), non-squamous histopathology (HR 0.51, $P=0.52$), or who required >1 surgery (HR 1.20, $P=0.73$) were not at an increased risk of VR. Patients with positive lymph nodes and those with LS were more likely to have VR (HR 8.7, $P=0.04$; HR 4.1, $P=0.01$, respectively). Of the 14 patients with VR, 6 (43%) had LS. Patients with LS were more likely to be older (mean age 71 vs 59, $P=0.1$). Of the 25 patients who had multiple prior resections, 13 (52%) had re-excisions for positive

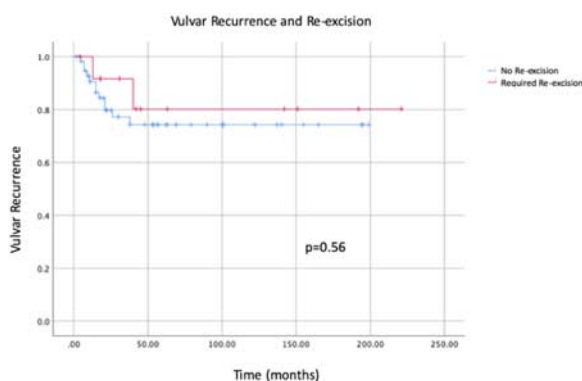

FIGURE 2. Vulvar recurrence and re-excision. Kaplan-Meier curve comparing vulvar recurrence in patients that required re-excision for positive margins compared with those that did not receive re-excision, log-rank $P=0.056$.

margins while 12 (48%) were treated for recurrence after prior definitive surgery. In the 13 patients who required re-excision, 8 had negative margins after re-excision. Margin status after re-excision was not associated with VR (HR 1.48, $P=0.78$). The risk of VR was not increased if patients required re-excision compared with all other patients (HR 0.64, $P=0.56$). Patients were not at an increased risk of VR if they were recurrent at time of presentation (HR 1.87, $P=0.29$). At last contact, 48 patients (70%) had no evidence of disease, 13 (19%) had disease, and 8 (12%) had unknown disease status. Eight patients in this cohort died of disease.

Conclusions: Re-excision to achieve negative margins or delivery of additional boost dose to areas of close or positive margins appear to be effective strategies to reduce the risk of VR. The presence of lichen sclerosis is a strong predictor of vulvar relapse and may warrant investigation as an indication for treatment intensification (Figs. 1 and 2).

(P073) Two-year Patient-Reported Outcomes After Ipsilateral IMRT for T1-2 N2b Squamous Cell Carcinoma of the Tonsils

Chike Abana, MD, PhD¹, Adam Garden, MD¹, Andrew Frankart, MD², Natalie Geier, MD³, Houda Bahig, MDCM, PhD⁴, Gary Gunn, MD¹, Abdallah S.R. Mohamed, MD¹, Vinita Takiar, MD, PhD², Jack Phan, MD, PhD¹; ¹The University of Texas M.D. Anderson Cancer Center, ²University of Cincinnati, ³The Christ Hospital, ⁴University of Montreal Hospital Center

Background: Although unilateral neck irradiation is frequently implemented in patients with well-lateralized stage T1-2 HPV+ tonsillar squamous cell carcinoma (SCC) to minimize toxicity, its role in patients with N2b (AJCC-7 staging) nodal disease remains controversial. We have separately reported on contralateral nodal recurrence risk in patients with N2b disease receiving unilateral neck radiation. The patient reported outcomes (PRO) in these patients have not been previously reported.

Objectives: To evaluate the quality of life PRO profile in patients with AJCC 7th edition T1-2 N2b tonsillar squamous cell carcinoma treated with unilateral neck radiation.

Methods: The PROs of 44 AJCC-7 T1-2 N2b tonsillar squamous cell carcinoma (SCC) patients from two academic institutions treated with definitive, ipsilateral intensity modulation radiation therapy (IMRT) with or without systemic therapy were reviewed retrospectively. PROs were completed using either the MD Anderson Symptom Inventory-Head and Neck module (MDASI-HN) at the first institution, or the European Organization for Research and Treatment of Cancer Quality of Life Questionnaire Head and Neck Module 35 (EORTC QLQ-H&N35) at the second institution. The primary endpoint was the head and neck-related PROs at 2 years after completion of radiation.

Results: Twenty-eight of 30 and 4 of 14 patients from the first and second institutions, respectively, met the primary endpoint and were further analyzed. Of these, 34.4% received radiation alone without systemic therapy and 93.7% received ipsilateral-only neck IMRT. The most common head and neck-related PRO was dry mouth at the first and second institutions (64.2% and 100%, respectively); the least common was difficulty with voice or speech at the both institutions (14% and 0%, respectively). There were also no reports of mouth pain or soreness, trouble with teeth, opening mouth, or swallowing liquid/pureed food at the second institution. The overall symptom severity for all PRO categories in both modules were in the mild range, with the highest mean score reported for dry mouth: 2.54 out of 10 on MDASI-HN for the first institution and 2.5 out of 4 on EORTC QLQ-H&N35 for the second institution. The rest of the mean scores for the first institution were < 1.5, while the remainder for the second institution were ≤ 2. The locoregional control and overall survival after a median follow-up of 4.5 years were each 100%.

Conclusions: We assessed the 2-year PROs for ipsilaterally radiated tonsillar SCC from 2 institutions using either MDASI-HN or EORTC QLQ-H&N35, and most reported mild symptom burden. These findings suggest that ipsilateral-only IMRT is well tolerated in patients with AJCC-7 N2b disease and can be safely employed as a de-escalation strategy.

(P074) Association Between Radiation Dose to Adjacent Organs at Risk and Acute Patient Reported Outcome During Radiation Treatment for Head and Neck Cancers

Mona Arbab, MD¹, Yu-Hui Chen, PhD², Roy Tishler, MD², Jason Glass², Jo Ann Fugazotto², Joseph Killoran, PhD³, Rosh Sethi, MD², Eleni Rettig, MD³, Donald Annino, MD³, Laura Goguen, MD³, Ravindra Uppaluri, MD², Carolyn Hsu², Elaine Burke³, Glenn Hanna, MD², Jochen Lorch, MD², Robert Haddad, MD², Danielle Margalit, MD², Jonathan Schoenfeld, MD²; ¹Indiana University, ²Dana Farber Cancer Institute, ³Brigham and Women's Hospital

Background: Anticipating patient-reported side effects during radiation therapy (RT) based on RT dose to Organs At Risk (OARs) may promote focused patient-centered management during RT.

Objectives: We studied the association between dose to OARs and patient reported outcomes (PRO) measured during head and neck RT.

Methods: We performed a retrospective evaluation of the association between dose to OARs and PROs obtained weekly during treatment in head and neck cancer patients receiving definitive or postoperative radiation treatment with at least three prospectively-acquired PRO surveys.

Results: Between 2015-2018, 169 patients had definitive (61%) or postoperative (39%) intensity modulated radiation therapy (IMRT) for Head & Neck (H&N) cancer and completed at least 3 PRO surveys during RT. The majority of patients had oropharyngeal SCC (50%). We identified associations between patient reports of: "Difficulty swallowing/chewing" and increased mean RT dose to the oral cavity, larynx and pharyngeal constrictor muscles (PCM) ($P=0.0005$, $P=0.02$ and $P=0.046$ respectively); "choking/coughing" and larynx mean dose ($P=0.003$); "problems with mucus in mouth and throat" and oral cavity, parotid and PCM mean dose ($P<0.001$, 0.002 , 0.04 respectively); "difficulty with voice/speech" and oral cavity, parotid and larynx mean dose ($P=0.03$, 0.03 and 0.02); and "dry mouth" and oral cavity and PCM mean dose ($P=0.0002$, 0.02). There were no associations between PROs and T-classification, smoking and whether RT was delivered definitively or in the adjuvant setting.

Conclusions: Increased OAR dose to oral cavity, larynx, PCM and parotids are associated with increased severity of patient-reported symptoms including difficulty swallowing/chewing, choking/coughing, problem with mucus in mouth and throat, difficulty with voice/speech and dry mouth. Evaluating dose to OARs can assist in anticipating patient-reported side effects of therapy and promote patient-specific acute management.

(P075) Who Really Receives Single Modality Therapy? Oropharynx Cancer

Nina Burbure, MD¹, Mengying Deng¹, Elizabeth Handorf, PhD¹, John Ridge, MD PhD¹, Christopher Yao, MD¹, Jessica Bauman, MD¹, Anshu Giri, MD¹, Jeffrey Liu, MD¹, Thomas Galloway, MD¹; ¹Fox Chase Cancer Center

Background: Either radiation (RT) or transoral surgery + neck dissection promise the potential of single modality curative therapy for appropriately selected oropharynx cancer patients. How many patients are actually managed with single modality therapy is unknown.

Objectives: We queried the National Cancer Database (NCDB) to determine what proportion of early stage oropharynx cancer patients receive single modality therapy and to identify factors associated with multi-modality therapy in this group of patients.

Methods: We identified 4678 patients treated curatively for early stage (7th ed cT1-T2, cN0-N1) oropharyngeal squamous cell carcinoma between 2010-2016. For those treated with primary surgery, the odds ratio (OR) of requiring adjuvant therapy was determined using logistic regression and adjusting for age, sex, race, comorbidity score, insurance status, facility type, diagnosis year, disease subsite, clinical T and N category and HPV status. Multinomial logistic regression was used to determine the association between covariates and specific adjuvant therapies (chemoradiation [CRT] or RT alone). For the primary RT group, surgery within 20 weeks of RT completion was considered multi-modality.

TABLE 1. Odds Ratio of Receiving Adjuvant Therapy After Surgery for Several Variables

Variable	OR for adjuvant	95% CI	P value
T2 (vs T1)	1.68	1.41-1.99	<0.0001
N1 (vs N0)	4.87	4.06-5.83	<0.0001
Base of tongue (vs tonsil)	0.75	0.61-0.92	0.0049
Academic center (vs community)	0.53	0.33-0.84	<0.0001

Results: A majority of patients were managed with primary surgery (2554/4678, 55%). Patients managed with surgery were younger (mean age 61 vs 66 y old) with smaller primaries (T1: 51% v 31%, $P= <0.0001$). HPV status was known in 2910 patients, of which 63% had HPV positive tumors. Surgery within 20 weeks of definitive radiation was rare (13/2124, 0.6%). By contrast 51% of surgical patients received adjuvant therapy and nearly half (46%) of these patients received adjuvant CRT (24% of all surgical patients). Factors associated with increased likelihood of adjuvant therapy include treatment at a community center (versus academic), tonsil subsite, T2 stage designation and N1 stage designation. The odds ratios of requiring adjuvant therapy (vs no adjuvant therapy) for these variables are tabulated. For adjuvant CRT specifically, the OR was increased significantly for clinical N1 disease (8.37, $P= <0.0001$). In the group with known HPV status, the OR for requiring adjuvant therapy was increased for HPV positive tumors (1.39, $P=0.0076$).

Conclusions: A majority of early stage oropharynx cancer patients who undergo transoral surgery receive adjuvant therapy, while <1% of similarly staged patients require adjuvant surgery following RT. More advanced disease is associated with a higher odds ratio for adjuvant therapy after surgery (Table 1).

(P076) Prospective Evaluation of Oral Cavity Dosimetric Parameters as Predictors of Quality of Life Outcomes in Patients Undergoing Chemoradiation for Locally Advanced Oropharyngeal Squamous Cell Carcinoma

Andrew Cook, MD¹, Ankit Modh, MD², Haythem Ali, MD³, Jawad Sheqwar, MD³, Steven Chang, MD⁴, Tamer Ghanem, MD, PhD⁴, Suhail Momin, MD⁴, Vivian Wu, MD⁴, Samantha Tam, MD, MPH⁴, Xiaoxia Han, PhD⁵, Lamis Fakhoury, BA⁶, Benjamin Movsas, MD¹, Farzan Siddiqui, MD, PhD, CPE¹; ¹Department of Radiation Oncology, Henry Ford Cancer Institute, ²Department of Radiation Oncology, Carle Cancer Institute, ³Department of Hematology/Oncology, Henry Ford Cancer Institute, ⁴Department of Otolaryngology, Henry Ford Cancer Institute, ⁵Department of Public Health Sciences, Henry Ford Cancer Institute, ⁶Henry Ford Cancer Institute

Background: Concurrent chemoradiation (chemoRT) for oropharyngeal squamous cell carcinoma (OPSCC) has improved survival; however, this intensive treatment comes at the expense of increased toxicity and worse quality of life (QOL). Data from a prospective randomized trial was used to assess the impact of oral cavity (OC) dose on QOL outcomes.

Objectives: Based off this prospective data, we would like to report on the association between OC dose and quality of life outcomes.

Methods: All patients (n=56) had AJCC 7th ed stage III-IV OPSCC and underwent concurrent chemoRT. RT dose was 70 Gy in 35 fractions using a VMAT technique. To assess QOL, patients completed the Patient-Reported Oral Mucositis Symptom (PROMS) scale at baseline, weekly during treatment, and at 6-week follow-up (higher scores indicate worse QOL). The OC was contoured using consensus guidelines (Brouwer, et al Radiother Oncol 2015). For dosimetric data, we collected OC max and mean doses (Gy) and volume (%) receiving x Gy (Vx) in 10 Gy increments. PROMS scores at week 7 (end of treatment) and follow-up timepoints were used for analysis. In addition to the total PROMS score, we analyzed question 1 individually (PROMS1-mouth pain) and questions 4, 5, 6, and 9 combined (PROMS4569-difficulty

eating and swallowing). PROMS scores were dichotomized at the median to create two comparison groups, and dosimetric differences were assessed using Wilcoxon-rank sum tests ($P < 0.05$ considered significant).

Results: At the week 7 endpoint, there were no differences noted in OC doses when the total PROMS score was dichotomized at the median. For PROMS1, there were significant dosimetric differences noted in OC mean dose (56.8 Gy vs 62.2 Gy, $P = 0.04$) and V50 (64.7% vs 81.5%, $P = 0.05$) in the low and high score arms, respectively. Additionally, differences in OC V40 (84.8% vs 92.7%, $P = 0.08$), V60 (48.6% vs 71.2%, $P = 0.05$), and V70 (28.4% vs 40.4%, $P = 0.06$) trended towards significance in the low and high score arms, respectively. For PROMS4569, there were no significant differences noted in the dosimetric parameters. At follow-up examining total PROMS score, there was a significant difference in OC V70 (25.6% vs 38.2%, $P = 0.05$) in the low and high score arms, respectively. Additionally, OC V60 (47.8% vs 61.1%, $P = 0.09$) trended towards significance in the low and high score arms, respectively. For PROMS1 at follow-up, there were no significant differences noted in the dosimetric parameters. There were also no significant findings for PROMS4569 at follow-up; however, OC V70 (27% vs 38.2%, $P = 0.09$) trended towards significance in the low and high score arms, respectively.

Conclusions: We found that patients who had worse QOL scores at the end of treatment, especially related to mouth pain, had significantly higher OC mean and V50 dosimetric parameters. Additionally, higher OC V60 and V70 parameters may predict for longer term detriment to QOL. These variables should be optimized during treatment planning to improve outcomes.

(P077) 18FDG Positron Emission Tomography Mining for Metabolic Imaging Biomarkers of Radiation-induced Xerostomia in Patients with Oropharyngeal Cancer

Clifton Fuller, MD, PhD¹, Hesham Elhalawani, MD, MSc², Carlos Cardenas, PhD¹, Stefania Volpe, MD³, Souptik Barua, PhD³, Sonja Stieb, MD³, Calvin Rock, MD³, Timothy Lin, MD³, Pei Yang, MD³, Haijun Wu, MD³, Jhankruti Zaveri, BS³, Baher Elgohari, MD³, Lamiaa Abdallah, MD³, Amit Jethanandani, MD³, Abdallah S.R. Mohamed, MD⁴, Laurence E. Court, PhD¹, Katherine Hutcheson, PhD³, Gary Gunn, MD⁴, David Rosenthal, MD¹, Steven Frank, MD¹, Adam Garden, MD⁴, Arvind Rao, PhD⁵; ¹MD Anderson Cancer Center, ²Brigham and Women's Hospital/Dana-Farber Cancer Institute, ³University of Texas MD Anderson Cancer Center, ⁴The University of Texas M.D. Anderson Cancer Center, ⁵University of Michigan

Background: Head and neck cancers radiotherapy (RT) is associated with inevitable injury to parotid glands and subsequent xerostomia.

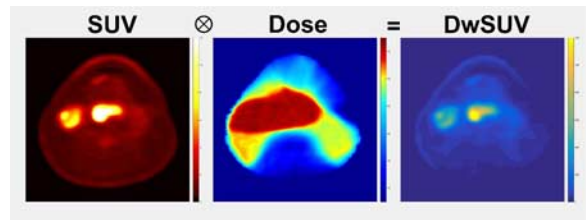

FIGURE 2. Illustration of dose-weighted SUV computation.

Objectives: We investigated the utility of SUV derived from 18FDG-PET to develop metabolic imaging biomarkers (MIBs) of RT-related parotid injury.

Methods: Data for oropharyngeal cancer (OPC) patients treated with RT at our institution between 2005-2015 with available planning computed tomography (CT), dose grid, pre- & first post-RT 18FDG-PET-CT scans, and physician-reported xerostomia assessment at 3-6 months post-RT (Xero 3-6 mo) per CTCAE, was retrieved, following an IRB approval. A CT-CT deformable image co-registration followed by voxel-by-voxel resampling of pre- & post-RT 18FDG activity and dose grid were performed. Ipsilateral (Ipsi) and contralateral (contra) parotid glands were sub-segmented based on the received dose in 5 Gy increments, i.e. 0-5 Gy, 5-10 Gy sub-volumes, etc. Median and dose-weighted SUV were extracted from whole parotid volumes and sub-volumes on pre- & post-RT PET scans, using in-house code that runs on MATLAB. Wilcoxon signed-rank and Kruskal-Wallis tests were used to test differences pre- and post-RT.

Results: 432 parotid glands, belonging to 108 OPC patients treated with RT, were sub-segmented & analyzed. Xero 3-6 mo was reported as: non-severe (78.7%) and severe (21.3%). SUV-median values were significantly reduced post-RT, irrespective of laterality ($P = 0.02$). A similar pattern was observed in parotid sub-volumes, especially ipsi parotid gland sub-volumes receiving doses 10-50 Gy ($P < 0.05$). Kruskal-Wallis test showed a significantly higher mean RT dose in the contra parotid in the patients with more severe Xero 3-6 mo ($P = 0.03$). Multiple logistic regression showed a combined clinical-dosimetric-metabolic imaging model could predict the severity of Xero 3-6 mo; AUC = 0.78 (95%CI: 0.66-0.85; $P < 0.0001$).

Conclusions: We sought to quantify pre- and post-RT 18FDG-PET metrics of parotid glands in patients with OPC. Temporal dynamics of PET-derived metrics can potentially serve as MIBs of RT-related xerostomia in concert with clinical and dosimetric variables (Figs. 1-3).

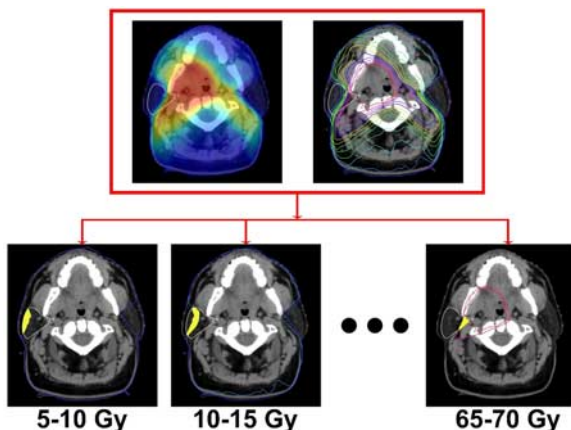

FIGURE 1. Parotid dose sub-volume generation.

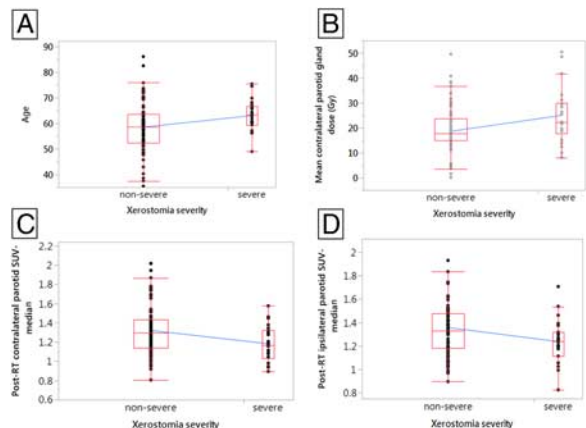

FIGURE 3. Correlation between severity of post-radiotherapy xerostomia and (A) Age; (B) Mean contralateral parotid gland dose (Gy); (C) Post-radiotherapy contralateral parotid gland SUV-median; and (D) Post-radiotherapy ipsilateral parotid gland SUV-median.

(P078) Assessing Oral Intake Outcomes in Head and Neck Cancer Patients Treated with Definitive Radiation with or Without Chemotherapy

Ricardo Engel, BS¹, Patrick Etta, BS¹, Talha Gahzi, BS², Amy Williams, PhD³, Samantha Tam, MD, MPH⁴, Suhail Momin, MD⁴, Steven Chang, MD⁴, Tamer Ghanem, MD, PhD⁴, Diana Walker, MA⁵, Farzan Siddiqui, MD, PhD, CPE⁶, Haythem Ali, MD⁷, Vivian Wu, MD⁴, Jawad Sheqware, MD⁷, Megan Carlson, MS⁸; ¹Wayne State University School of Medicine, ²Michigan State Univ College of Human Medicine, ³Department of Otolaryngology-Head and Neck Surgery, Henry Ford Hospital, ⁴Department of Otolaryngology, Henry Ford Cancer Institute, ⁵Speech Language Pathology and Otolaryngology, Henry Ford Health System, ⁶Department of Radiation Oncology, Henry Ford Cancer Institute, ⁷Department of Hematology/Oncology, Henry Ford Cancer Institute, ⁸Speech-Language Pathology, Henry Ford Health System

Background: Head and neck cancer treatment modalities can significantly impact functional outcomes of patients, especially oral intake (Brizel, et al N Engl J Med 1998; Kamal, et al Support Care Cancer 2019). Radiation therapy in particular has been associated with post-treatment xerostomia and dysphagia (Adelstein, et al J Clin Oncol 2003; Hutcheson, et al Cancer 2013) which can affect quality of life and impair weight gain, contributing to worse long-term outcomes (Paya-kachat, et al Head Neck, 2013). Early speech-language pathology intervention has shown to be effective in improving these functional outcomes in this population (Greco, et al Int J Radiat Oncol Biol Phys 2018).

Objectives: The purpose of this study is to evaluate oral intake outcomes of patients undergoing definitive radiation therapy with or without chemotherapy for head and neck squamous cell carcinoma.

Methods: A cohort of patients with stage III or IV squamous cell carcinoma of the oropharynx, larynx, and hypopharynx treated with definitive radiation therapy with or without chemotherapy were extracted from system database. Patients with evidence of distant metastases were excluded. Swallow function was assessed both pre- and post-treatment (within four months of treatment initiation or conclusion) with the Functional Oral Intake Scale (FOIS) (Crary et al, Arch Phys Med Rehabil, 2005) as measured by a Speech-Language Pathologist (SLP) involved in the patient's care. Body mass index (BMI) was evaluated within four months of treatment initiation and one year after treatment completion. The use of enteral feeding at one-year post-treatment was also assessed. Data was analyzed with descriptive statistical methods, Wilcoxon sign rank tests, and χ^2 tests.

TABLE 1. Description of Baseline Population

Characteristic	Mean, STD	N	%
Age		61.6 (+/-9.0)	
Gender	M	126	82.9
	F	26	17.1
Race	White	104	68.4
	Black	36	23.7
	Other	12	7.9
Insurance	PPO	53	34.9
	Medicare	48	31.6
	Medicaid	14	9.21
	Other/Unknown	371	24.3
CCI	0	67	44.1
	1	39	25.7
	>=2	46	30.3
T	1	29	19.1
	2	41	27.0
	3	41	27.0
	4	41	27.0
N	0	17	11.2
	1	30	19.7
	2	99	65.1
	3	6	4.0
Smoking	Never	42	27.6
	Former	58	38.2
	Current use	51	33.6
	Unknown	1	0.7
Site	Oropharynx	115	75.7
	Larynx	30	19.7
	Hypopharynx	7	4.6
Treatment	Radiation alone	13	8.6
	Chemoradiation	139	91.5

TABLE 2. Swallowing Outcomes and BMI

Characteristics	Pre (N, %)	Post	p-value
FOIS	1	5 (5.7)	<0.001 (Wilcoxon sign rank test)
	2	16 (18.4)	
	3	12 (13.8)	
	4	9 (10.3)	
	5	17 (19.5)	
	6	14 (11.3)	
	7	12 (13.8)	
BMI	Median, range	23.7 (15.6 to 52.1)	0.001 (t-test)

Results: The sample included 152 patients. Table 1 highlights patient baseline characteristics, tumor location, and treatment. FOIS scores decreased from pre-treatment to post-treatment, with 75% of patients having a FOIS of 7 at pre-treatment compared with only 13.8% at the post-treatment time point (Table 1). Median BMI also decreased from pre-treatment to one-year post-treatment (Table 2). At one-year post-treatment, 23.7% patients (n = 33) required enteral feeding.

Conclusions: Definitive radiation therapy with or without chemotherapy in the treatment of head and neck cancer is associated with impaired oral intake. Treatment is also associated with decreases in BMI and longer use of enteral feeding, which may reflect sequelae of impaired oral intake. These factors have a negative impact on quality of life and can lead to long-term morbidity. Integrative treatment plans would therefore benefit from speech-language pathology interventions throughout the treatment process.

(P079) Single Fraction Radiotherapy as Postoperative Treatment (SF-PORT) for Resected, Stage I/II Merkel Cell Carcinoma

Peter Goff, MD, PhD¹, Stephanie Schaub, MD¹, Kristina Lachance, MS¹, Emily Huynh¹, Nikhil Harikrishnan¹, Maclean Cook¹, Yolanda Tseng, MD¹, Jay Liao, MD¹, Smith Apisarnthanarax, MD¹, Kent Wallner, MD¹, Paul Nghiem, MD, PhD¹, Upendra Parvathaneni, MBBS, FRANZCR¹; ¹University of Washington

Background: In the absence of randomized prospective data, the role of postoperative radiotherapy (PORT) for localized Merkel cell carcinoma (MCC) is controversial with varying practice patterns. Although a majority of patients with resected stage I/II MCC without adverse features may be cured with surgery alone, those with adverse features including head and neck (HN) primary tumors have local recurrence rates of 20% or more without PORT (Takagishi et al Adv Radiat Oncol, 2016). Extrapolating from our experience demonstrating high rates of local control with single fraction radiotherapy (SFRT) for metastatic MCC (Iyer et al Cancer Med, 2015), we hypothesized that SFRT (8 Gy) may be effective as PORT to optimize local control for stage I/II MCC with adverse risk features [e.g. HN disease, immunosuppression, recurrent disease, non-oncologic resection, lymphovascular space invasion (LVSI)], especially in patients for whom a conventional RT course may not be feasible.

Objectives: Determine if single fraction radiotherapy (8 Gy) may be effective as PORT to optimize local control for stage I/II Merkel cell carcinoma with adverse risk features.

Methods: A single-institution, retrospective review of patients with clinical or pathological stage I/II MCC receiving SFRT (8 Gy) as post-operative treatment (SF-PORT) was completed from a prospectively-enrolled database.

Results: Thirty patients (median age 78 y) were identified who received SFRT after wide local excision (n = 24; 80%), Mohs surgery (n = 1; 3%), shave or excisional biopsy only (n = 5; 17%) of the primary. Patients had pathological stage I (n = 15; 50%), clinical stage I (n = 10; 33%), pathological stage II (n = 3; 10%) or clinical stage II (n = 2; 7%) disease. All patients received SF-PORT (8 Gy) at a median of 43 days (range: 14-203) following resection or biopsy. Five patients (4 with HN disease) received SFRT to draining lymph nodes. The majority of patients had HN tumors (77%), LVSI was present in 23%, 17% were immunosuppressed and 7% had locally recurrent disease (n = 2). At median follow-up of 11.3 months (range: 3-45.7), no local or in-field

recurrences were observed. No local or distant recurrences, MCC specific deaths, or RT related toxicities grade > 1 (CTCAE v5.0) were observed. There were two out-of-field regional nodal recurrences in HN patients who did not receive elective nodal RT.

Conclusions: Our early experience demonstrates a high rate of in-field local control in patients with stage I/II MCC with adverse features managed with SF-PORT. This approach warrants further study.

(P080) Sex Differences in Health Related Quality of Life in Head & Neck Cancer One Year After Treatment

Madeline Goosmann, MD¹, Steven Chang, Attending¹, Amy Williams, PhD², Samantha Tam, MD, MPH³; ¹Henry Ford Hospital, ²Department of Otolaryngology-Head and Neck Surgery, Henry Ford Hospital, ³Department of Otolaryngology, Henry Ford Cancer Institute

Background: Head and neck cancer (HNC) makes up about 3% of all cancers and is treated with systemic therapy, radiation, surgery, or a combination of these. HNC treatment can be associated with decreased patient reported health related quality of life (HR-QoL), which can lead to depression.¹ The majority of studies found that females reported worse patient reported HR-QoL than males,²⁻⁷ however, there were a few that did not have a significant difference in overall patient reported QoL.⁸⁻⁹ With the discovery of patient oriented outcomes (PROs) in clinical practice affecting patient satisfaction, provider-patient relationship, and overall patient mortality,¹⁰ it is vital to include PROs in the creation of treatment plans.

Objectives: The objectives of this project are to highlight the differences in HR-QoL between men and women. Ultimately, using these PROs clinically will help to improve patient care, augment patient-provider trust, and optimize treatment plans. Using PROs and recognizing where unconscious biases of providers come into play is pinnacle, and this project aims to highlight how men and women's experiences are different in the treatment of HNC.

Methods: Participants were given the FACT-H&N instrument one year after treatment for head and neck cancer at a single tertiary academic center to assess different aspects of Hr-QoL. Sex differences were analyzed between the groups. A Wilcoxon Rank Sum test was performed to assess associations with sex and survey responses, as well as to assess associations with total laryngectomy and survey responses.

Results: There were 100 participants from a single academic center of which 73% were men and 27% women. Several of the questions had significant differences between men and women: "I feel ill ($P=0.0299$)," "I am satisfied with my family communication about my illness ($P=0.0075$)," "I am satisfied with my sex life ($P=0.0496$)," "My voice has its usual quality and strength ($P=0.0057$)," "I can swallow naturally and easily ($P=0.0437$)," and "I can eat solid foods ($P=0.0248$)." There were no significant differences between men and women with laryngectomies.

Conclusions: Overall, men felt more ill, were less satisfied with their sex lives, were less likely to feel a normal strength and quality of voice, felt decreased ability to swallow normally, and felt they could not eat solid foods; women were less satisfied with communication about their disease to their families. For those who had undergone laryngectomy, there were no significant differences between men and women. Different aspects of quality of life for men and women are affected by head and neck cancer. Monitoring PROs are becoming increasingly standard of care for patients, and providers need to be equipped understand how to interpret data accordingly and understand the inherent biases.

(P081) More TORS, More Problems? Institution-level Patterns of Care for Early Stage Oropharynx Cancers in the US

James Janopaul-Naylor, MD¹, Yuan Liu, MS, PhD², William Stokes, MD¹; ¹Winship Cancer Institute at Emory University, ²Rollins School of Public Health at Emory University

Background: Increasing use of TORS in early-stage oropharyngeal cancer (esOPC) has stimulated debate over the role of radiotherapy, both as definitive non-surgical treatment and as adjuvant therapy

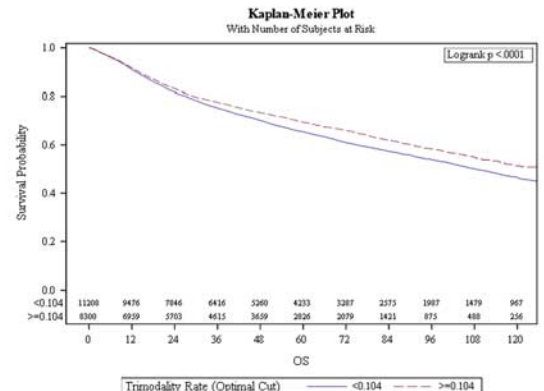

Trimodality Rate (Optimal Cut)	No. of Subject	Event	Censored	Median Survival (95% CI)	60 Month Survival	120 Month Survival
<math><0.104</math>	11208	4136 (37%)	7072 (63%)	108.3 (104.4, 112.7)	65.5% (64.5%, 66.4%)	46.4% (45.0%, 47.8%)
>math>≥0.104</math>	8300	2455 (30%)	5845 (70%)	126.6 (116.8, 132.2)	69.4% (68.2%, 70.5%)	51.4% (49.2%, 53.6%)

FIGURE 1. Kaplan-Meier plot of overall survival based on institutional rate of trimodality therapy (surgery followed by adjuvant chemoradiation).

following surgical resection. Underutilization of adjuvant radiotherapy (aRT) or chemoradiotherapy (aCRT) may indicate inappropriate pathologic risk stratification and treatment selection, which may adversely impact survival (OS) at an institutional level.

Objectives: Examine institution-level patterns of surgery, aRT, and aCRT for esOPC in the United States and their associations with OS.

Methods: Cases of cT1-2 N0-1 M0 oropharynx squamous cell carcinoma who received upfront surgery from 2004-2015 were identified from the NCDB. Cases treated at the same institution were grouped for institution-level analysis. Survival distributions were estimated with Kaplan-Meier and log-rank tests. Clustering effects by institution were

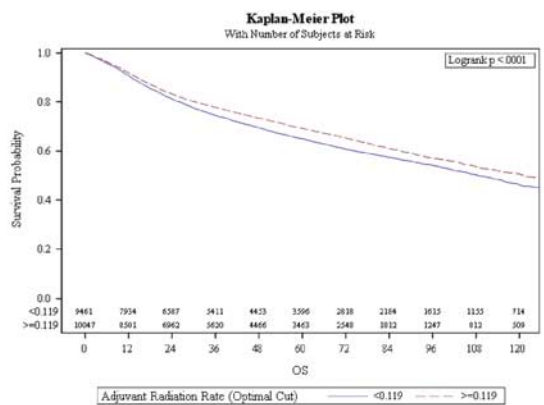

Adjuvant Radiation Rate (Optimal Cut)	No. of Subject	Event	Censored	Median Survival (95% CI)	60 Month Survival	120 Month Survival
<math><0.119</math>	9461	3500 (37%)	5961 (63%)	108.3 (104.7, 113.2)	65.0% (63.9%, 66.1%)	46.1% (44.5%, 47.7%)
>math>≥0.119</math>	10047	3091 (31%)	6956 (69%)	121.5 (114.7, 126.7)	69.1% (68.0%, 70.1%)	50.5% (48.7%, 52.2%)

FIGURE 2. Kaplan-Meier plot of overall survival based on institutional rate of adjuvant radiation (surgery followed by adjuvant radiotherapy).

calculated with optimal cut search using bias-adjusted log-rank tests. Cox proportional hazards models were built with backward selection. **Results:** 19,508 patients treated within 2,290 institution-years received upfront surgery. Institution-level median rate of aRT was 9.0% (IQR 0-25%), and median rate of aCRT was 3.4% (IQR 0.0-20.0%), despite median rate of positive margins of 25.0% (IQR 0.0-50.0%). From 2004-2007 to 2012-2015, median rate of upfront surgery increased from 42% to 50% ($P < 0.01$), the median rate of aRT increased from 6% to 9% ($P = 0.11$), and the median rate of aCRT increased from 0% to 8% ($P < 0.01$). On UVA, OS was longer for patients treated at institutions with higher case volume, higher rates of upfront surgery, higher rates of aRT, and higher rates of aCRT (all $P \leq 0.04$). Applying optimal cut points, five-year OS was lower for patients at institutions with $< 11.9\%$ of patients receiving aRT (65.0% vs 69.1%; $P < 0.01$) and with $< 10.4\%$ of patients receiving aCRT (65.5% vs 69.4%; $P < 0.01$). On MVA there were significant associations for race, comorbidities, income, lymph node size, lymphovascular invasion, and HPV status with OS, but non-significant associations for lower institutional use of aRT (HR 1.05; 95%CI 1.00-1.11, $P = 0.06$) or aCRT (HR 1.02; 95%CI 0.96-1.08, $P = 0.55$). **Conclusions:** Low institutional rates of aRT and aCRT for esOPC do not appear to be independently associated with OS. However, institution-level utilization of both upfront surgery and aCRT are increasing in tandem, suggesting that patients previously considered poor or borderline surgical candidates are increasingly being offered surgery. Moreover, institutions offering surgery exhibit a troubling mismatch between reported risk factors and adjuvant therapy: one-quarter report positive margins in $\geq 50\%$ of cases, but three-quarters provide aCRT in $\leq 20\%$ of cases. These findings underscore the importance of multidisciplinary care in optimal selection of upfront and adjuvant therapy in esOPC (Figs. 1 and 2).

(P082) Improved Local Control in p16 Negative Oropharyngeal Cancers with Hypermethylated MGMT

Garrett Jensen, MD¹, Gabriel Axelrud, MD², David Fink, DO³, Arundhati Rao, MD⁴, Kendall Hammonds, MPH⁴, Kimberly Walker, MSHA⁴, Marcus Volz, BS⁴, Gowan Alan, MD⁴, Niloyjyoti Deb, MD⁴, Sameer Jhavar, MD⁴; ¹Baylor Scott & White, ²Covenant Health, ³Incyte Diagnostics, ⁴Baylor Scott and White

Background: Patients with oropharyngeal cancers that are p16 negative (p16-) have worse outcomes than those who are p16 positive (p16+) and there is an unmet need for prognostic markers in this population. O6-Methylguanine (O6-MG)-DNA-methyltransferase (MGMT) gene methylation has been associated with response to chemoradiotherapy (CRT) in glioblastoma.

Objectives: We sought to find if MGMT promoter methylation was associated with outcomes of locally advanced oropharyngeal and oral cavity squamous cell carcinoma (OOSCC) in patients treated with definitive concurrent CRT.

Methods: Patients were identified with primary OOSCC, known p16 status, retrievable pre-treatment biopsies, and at least 6 months of follow-up who received definitive concurrent CRT from 2004 to 2015. Biopsies were tested for MGMT hypermethylation (MGMT+) using a Qiagen pyrosequencing kit (Catalog number 970061). Outcomes were subsequently recorded and analyzed.

Results: Fifty-eight patients were included with a median follow up of 78 (range 6-196) months. Fourteen patients (24.1%) had oral cavity cancer and 44 (75.9%) had oropharyngeal cancer. A significant difference was found for local recurrence free survival (LRFS) by combined MGMT and p16 status ($P = 0.0004$). Frequency of LR in MGMT+/p16+, MGMT+/p16-, MGMT-/p16+, and MGMT-/p16- patients was 14.3, 14.3, 13.0, and 69.2%, respectively ($P = 0.0019$). A significant difference was not found for distant recurrence free survival ($P = 0.6165$) or overall survival ($P = 0.1615$). LRFS remained significant on analysis restricted to oropharyngeal cancer patients (P -value = 0.0038).

Conclusions: Patients who are p16- and MGMT+ with oropharyngeal and oral cavity squamous cell carcinoma have significantly better LC with definitive CRT than those who are p16- and MGMT-. Prospective studies are needed to verify these findings (Fig. 1).

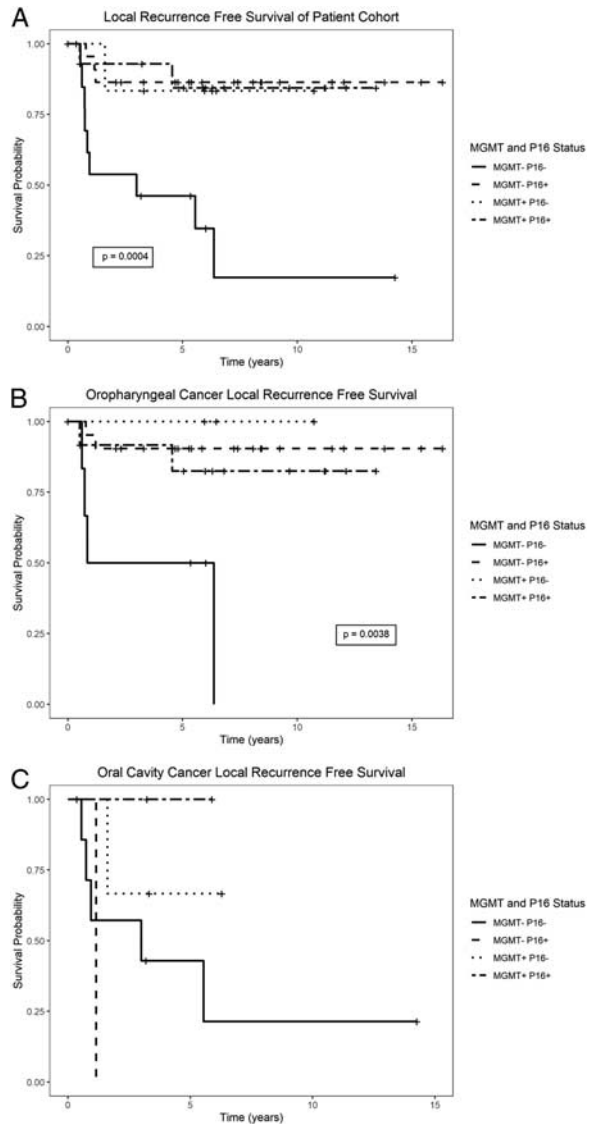

FIGURE 1. Local recurrence free survival by MGMT and p16 status of a) patient cohort, b) oropharyngeal cancer, and c) oral cavity cancer.

(P083) Analysis of Oral Microbial Flora in Patients Undergoing Chemoradiation for Head and Neck Cancer

Rafi Kabarriti, MD¹, Shalom Kalnicki, MD¹, Chandan Guha, MD, PhD¹, Madhur Garg, MD²; ¹Montefiore Medical Center, ²Montefiore

Background: Patients undergoing chemoradiation for head and neck cancer experience treatment related side effects including mucositis and xerostomia which can significantly alter oral microbiome and provoke microbial dysbiosis, further compounding and contributing to the complex pathogenesis of the treatment related side-effects. In this study, we prospectively evaluated the oral microbiome in patient undergoing chemoradiotherapy for head and neck cancer.

Objectives: In this study, we prospectively evaluated the oral microbiome in patient undergoing chemoradiotherapy for head and neck cancer.

Methods: Patients undergoing definitive or postoperative radiation therapy with concurrent chemotherapy were prospectively enrolled in an investigator initiated clinical trial assessing the supportive care during chemoradiation for head and neck cancers. As part of the

correlative portion of the study, oral swabs were collected and sent for bacterial culture.

Results: There were a total of 60 oral swabs from fifteen patients with a median of 5 swabs per patient. 19 of these were collected during chemoradiotherapy and remaining 41 were collected following completion of radiotherapy (up to 15 months post-treatment). Of the 19 swabs during chemoradiotherapy, 89.4% (17) showed normal or mixed oral flora and 10.5% (2) were abnormal with one showing staphylococcus aureus and another with candida albicans. Of the 41 swabs post-chemoradiotherapy, 58.5% (24) swabs showed normal or mixed oral flora and 41.5% (17) swabs were abnormal with 10 showing many staphylococcus aureus, 4 showing candida albicans, 1 showing many yeast not candida albicans, 1 showing Beta Streptococcus group F and 1 showing Beta Streptococcus group C.

Conclusions: Patients with head and neck cancer undergoing chemoradiotherapy had an increase in abnormal oral microbial swabs post-chemoradiotherapy with the most common microbial isolates including staphylococcus aureus and candida albicans. Strategies to modulate the oral microbial community for the treatment of chemoradiotherapy treatment related side-effects are ongoing.

(P084) Intensity Modulated Proton Therapy Better Spares Non-Adjacent Organs and Reduces the Risk of Secondary Malignant Neoplasms in the Treatment of Sinonasal Cancers

Luke Lewis, MD¹, Paul Kreinbrink, MD¹, Yongbin Zhang, MS¹, Madeline Doberstein, MS, RT(T)¹, Max Richardson, MS, CMD, RT(T)¹, Morgan Westerfield, MS, CMD, RT(T)¹, Kevin Redmond, MD¹, Vinita Takiar, MD, PhD¹; ¹University of Cincinnati

Background: Sinonasal cancers (SC) are a rare and heterogeneous group of malignancies arising from the nasal cavity, with a male predominance, a diversity of histologic sub-types and largely locally advanced presentation (Youlden D, et al Cancer Epidemiol 2013).

Surgery is the mainstay of treatment for SC but is often insufficient to achieve widely clear margins and satisfactory local control, thus adjuvant radiotherapy is frequently employed to improve outcomes. (Robins K, et al Head Neck 2011). Despite the challenges posed by adjacent anatomy and post-operative target delineation, advances in radiation technology now allow for optimal SC treatment while reducing treatment morbidity.

Objectives: The potential dosimetric indications for treating SC with intensity modulated proton therapy (IMPT) versus volumetric modulated arc therapy (VMAT) are unclear. This study compares dosimetric parameters and risk of secondary malignant neoplasms (SMNs) using IMPT and VMAT plans for the treatment of SC.

Methods: After IRB-approval, 10 patients previously treated with IMPT for cancers of the ethmoid, sphenoid, maxillary, or cavernous sinuses were identified. VMAT plans were generated for comparison. Volume coverage and dose to organs at risk (OAR) were recorded and compared using paired t-tests. Cases were divided into three groups based on primary tumor location (ethmoid sinus, sphenoid sinus and other) to evaluate for differences between proton and photon distribution by disease subsite. Organ equivalent dose (OED) of tissues outside of the treatment volume was used to define the excess absolute and relative risk of SMNs.

Results: In all cases, both VMAT and IMPT provide acceptable target volume coverage and are able to meet OAR constraints. IMPT is superior for brain V10 ($P < 0.001$), V30 ($P = 0.012$), and mean ($P < 0.001$), brainstem maximum point dose ($P = 0.027$), ipsilateral cochlea V30 ($P = 0.003$), contralateral cochlea mean ($P < 0.001$), contralateral lacrimal gland mean ($P = 0.007$), contralateral parotid mean ($P = 0.029$), spinal cord D0.01 ($P = 0.015$) and body outside of the CTV V10 ($P < 0.001$), V20 ($P < 0.001$), and V30 ($P = 0.009$). VMAT is superior for ipsilateral eye mean ($P = 0.004$), ipsilateral lens mean ($P < 0.001$), CTV V100 ($P = 0.003$) and maximum dose ($P = 0.013$). Ethmoid sinus tumors ($n = 4$) benefit more from IMPT dosimetry while tumors of the sphenoid sinus ($n = 2$) or other sites (maxillary, cavernous sinus or multiple sinuses, $n = 4$) did not favor one

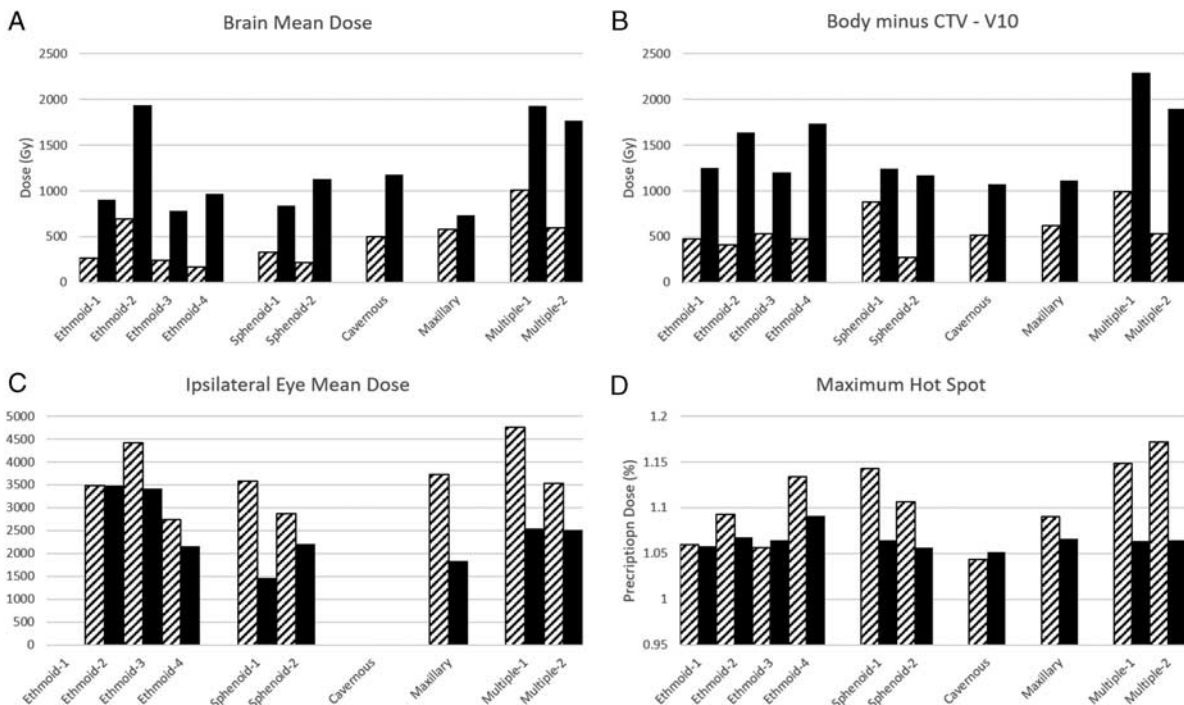

FIGURE 1. Parameters by anatomic location. Photons (solid), protons (dashed). Brain mean (A) and body minus CTV V10 (B) are representative dosimetric parameters that favor IMPT due to decreased dose to distant organs and total dose respectively. Ipsilateral eye mean (C) and maximum hot spot (D) are representative dosimetric parameters favoring VMAT for adjacent organ dose and target coverage homogeneity respectively.

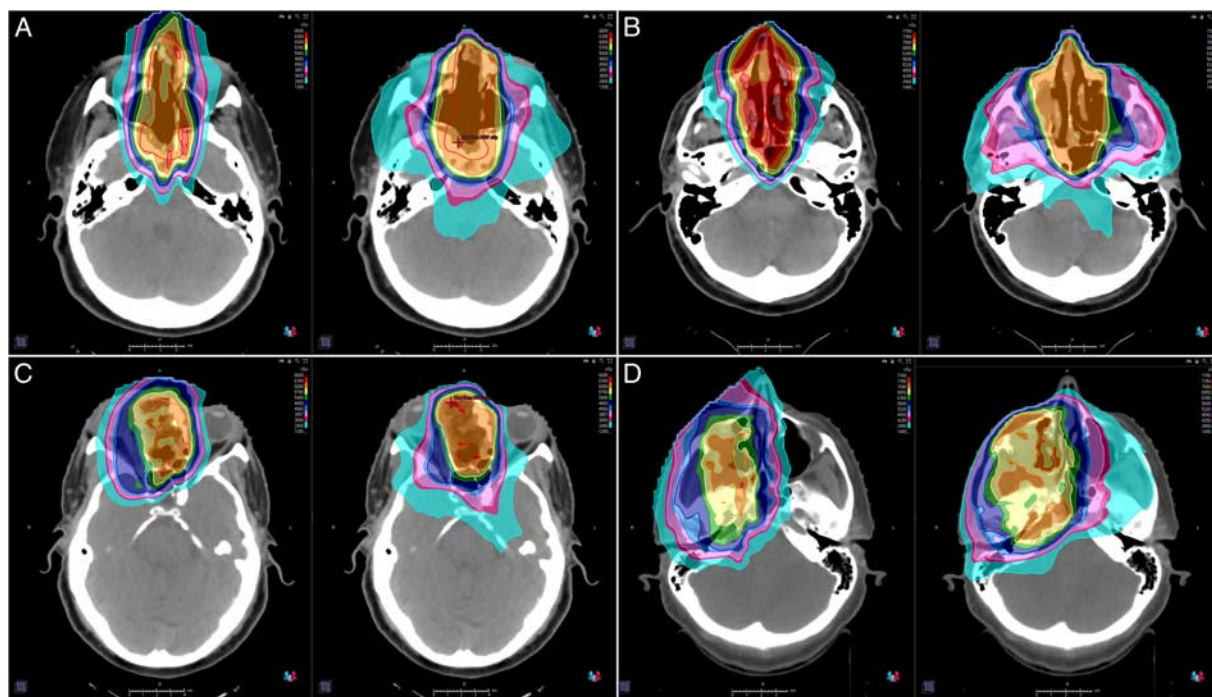

FIGURE 2. Representative comparative plans. IMPT plans are shown on the left and VMAT plans are shown on the right of each panel. Panel A demonstrates low dose spread with VMAT with a sphenoid tumor. Panel B demonstrates hotspots and heterogeneous dose distribution with IMPT with a tumor involving multiple sinuses. Panel C demonstrates the sharper dose falloff of VMAT around the eyes with an ethmoid tumor. Panel D demonstrates more effective sparing of contralateral structures with IMPT with a maxillary sinus tumor.

modality over the other. The relative risk of SMNs with VMAT compared with IMPT was 3.35 (95% CI, 1.92-5.89).

Conclusions: For the treatment of SC, IMPT spares OARs that are not immediately adjacent to the treatment volume and reduces the risk of SMNs when compared with VMAT. However, VMAT spares OARs abutting the target volume better than IMPT and has more homogeneous target coverage (Figs. 1 and 2). These differences suggest sinonasal tumors located superiorly, such as those of the ethmoid sinus, benefit most from IMPT while neither modality is superior for tumors in other locations.

(P085) Recurrence of Primary Mucosal Head and Neck Squamous Cell Carcinoma in Solid Organ Transplant Recipients

Evan Liang, MD¹, Marissa Gilbert, BS¹, Farzan Siddiqui, MD, PhD, CPE²; ¹Henry Ford Health System, ²Department of Radiation Oncology, Henry Ford Cancer Institute

Background: Patients that undergo a solid organ transplant have been shown to have a higher risk of developing cancer and even subsequent recurrences due to the immunosuppressants required to prevent rejection. Most established literature has been in the setting of cutaneous malignancies. In this study, we examine patients diagnosed with primary mucosal head and neck squamous cell carcinomas (HNSCC) diagnosed post-transplant to analyze their disease characteristics and clinical outcomes.

Objectives: To retrospectively characterize patients with primary mucosal HNSCC with history of prior solid organ transplant to define patient and tumor factors as well as analyze their long-term outcomes.

Methods: IRB approval was obtained for a retrospective evaluation utilizing our institutional head and neck cancer database. The analysis included patients who had previously undergone a solid organ

transplant and subsequently were diagnosed with a primary mucosal HNSCC. These included patients diagnosed from March 2006 to March 2021. The onset of recurrence was analyzed to identify long-term health implications for this patient cohort. Kaplan-Meier analyses were performed to calculate overall and disease-free survival.

Results: Out of 1,221 patients in our database, 24 patients met the inclusion criteria. Three patients were excluded due to lack of treatment or follow-up information, creating a sample of 21 patients. Of these, 13 (61.9%) received a liver, 4 (19%) received a kidney, 1 (4.8%) received a lung, and 3 (14.3%) received two transplants. After receiving the transplant, the median time to a HNSCC diagnosis was 6.4 years (range of 0.5 y to 18.5 y). The primary tumors included 8 (36.3%) oropharyngeal, 8 (36.3%) oral cavity, 5 (22.7%) laryngeal, and 1 (4.5%) hypopharyngeal lesion for a total of 22 lesions, with one patient having concurrent primaries of the oral cavity and oropharynx. The cohort included 1 (4.7%) stage 0, 7 (33.3%) stage I, 3 (14.3%) stage II, 3 (14.3%) stage III, and 7 (33.3%) stage IV; no patients had distant metastasis at time of diagnosis. Of the patients, 7 (33.3%) were treated with surgery alone, 6 (28.6%) received post-operative radiation/chemoradiation, 6 (28.6%) were treated with definitive chemoradiation, and 2 (9.5%) received definitive radiation. Median overall survival was 31 months. After treatment, 6 (28.6%) patients experienced a recurrence. Disease-free survival was 72.1% at 12 months. All patients who had a recurrence also died within the follow-up period. The median time of death after recurrence for all six patients was 11.5 months (range of 1 month to 22 mo).

Conclusions: Solid organ transplant patients are at a higher risk of developing many different cancers. Treatment of primary mucosal HNSCC is frequently done with curative intent and can be associated with significant morbidity. A better understanding of how solid organ transplant history modifies the disease course can help properly guide treatment decisions. In particular, this series highlights a high rate of mortality among patients who experience a disease recurrence. Further research is needed to better understand the risks associated with recurrence in solid organ transplant patients.

(P086) Development of a Novel Accelerator System and New Targeted Drugs for BNCT

Tioga Martin, PhD¹, Kataro Matsumoto, PhD², Fuyuhiko Tamanoi, PhD², Michael Torgov, PhD³, Linnette Capó, MS¹, Maki Ikeura, BA⁴, Chunying Zhang, MS¹, Maria Malinao¹, James Welsh, MD⁵, Kendall Morrison, PhD¹; ¹TAE Life Sciences, ²Institute for Integrated Cell-Material Sciences, Institute for Advanced Study, Kyoto University, ³Company, ⁴TAE life sciences, ⁵Department of Radiation Oncology; Loyola University Stritch School of Medicine and Edward Hines Jr VA Medical Center

Background: Boron neutron capture therapy (BNCT) is a binary radiation modality: following infusion with a ¹⁰B-containing compound that targets cancer cells, the tumor is irradiated with a low-energy neutron beam that triggers fission of the ¹⁰B isotope. The fission releases nuclear fragments that cause dsDNA breaks resulting in apoptotic cell death. BNCT development has been hindered by a number of practical hurdles, especially the need for a nuclear reactor as a source of neutrons and the reliance on poorly soluble boronophenylalanine (BPA) for ¹⁰B delivery. We are developing a new neutron source and drugs to overcome these hurdles.

Objectives: For successful BNCT at least 20 µg of ¹⁰B needs to be delivered per gram of tumor and the minimal tumor:healthy cell boron ratio 3:1. BPA has several inefficiencies including solubility and inadequate boron delivery. We aim to overcome these by developing new boron-carrying entities including unnatural amino acids, small peptides and boron enriched nanoparticles.

Methods: Boronated amino acids are designed based on known LAT-1 substrates and synthesized by adding boronic acid and purified using preparative HPLC. The aqueous solutions are formulated to achieve high concentrations. Nanoparticles are based on periodic mesoporous organosilica that can be complexed with BPA. All boronated amino acids and BPMOs are tested for their uptake using FaDu and other cell lines representing the cancer indication currently treatable by BNCT. Intracellular boron concentration is measured by ICP OES.

Results: We developed a compact 2.5 MeV tandem accelerator neutron source operating at 10mA with a lithium target generating neutrons in the epithermal spectrum ideal for BNCT. We are testing novel boronated artificial amino acids possessing good solubility, and with cellular uptake and retention, and easier formulation than BPA. TDP-747, an amino acid analogue that is taken up by the large neutral amino acid transporter (LAT-1), which is upregulated in many cancers. In vivo, TDP-747 has shown encouraging boron delivery. In addition, we have generated boronated biodegradable periodic mesoporous organosilica nanoparticles (BPMO) that carry boron through attachment of BPA. They are approximately 200 nm in size and are able to carry large amounts of BPA and target tumors by the EPR (enhancer permeability and retention) effect. We have shown in the CAM tumor model that they are effective for BNCT using neutrons from the KUR1 reactor in Kyoto, Japan.

Conclusions: A compact tandem accelerator suitable for BNCT in hospital settings has been developed along with novel boron drugs with improved tumor selectivity and ¹⁰B loads. BNCT is experiencing now a revival due to the introduction of accelerator-based neutron sources and it was approved in April 2020 for the treatment of recurrent head and neck cancer. We are readying our accelerator system for regulatory submission in the US and in Europe, with a target date of 2022 and a goal to start clinical trials in in the next 2 to 3 years.

(P087) Utilizing the Genomic Profile to Characterize Radiosensitivity and Progression in Non-melanoma Skin Cancers

Russell Palm, MD¹, Daniela Martir, MS², G. Daniel Grass, MD, PhD³, Steven Eschrich, PhD⁴, Eric Welsh, PhD⁵, Javier Torres-Roca, MD³, Evan Wuthrick, MD³, Kamran Ahmed, MD³; ¹Moffitt Cancer Center, ²Ponce Health Sciences University, ³Department of Radiation Oncology, ⁴H. Lee Moffitt Cancer Center & Research Institute, ⁵H. Lee Moffitt Cancer Center & Research Institute, ⁵Department of Biostatistics and Bioinformatics, H. Lee Moffitt Cancer Center & Research Institute

Background: Radiotherapy is employed in both the adjuvant and definitive settings in the management of basal and squamous cell skin cancers. The radiosensitivity index (RSI) is an extensively validated signature of radiosensitivity. Higher RSI values (scale 0-1) are associated with greater radioresistance. The CIBERSORT algorithm is a computational method that infers the presence of tumor infiltrating leukocytes (TILs). Previous studies have shown the presence of TILs have varying significance amongst cancer histologies.

Objectives: In this study, we characterized RSI and correlated the presence of TILs assessed through the CIBERSORT algorithm with clinical outcomes in basal and squamous cell skin cancers from our institution's tissue biorepository.

Methods: A retrospective collection of clinical data for patients treated at our institution with transcriptionally profiled tissue samples was performed. A previously defined cut point for RSI (greater than or equal to 0.375) was used to define greater radioresistance. A total of 11 basal cell and 16 squamous cell skin cancer samples were identified from our institutional biorepository and stored between the dates of August 2006 through August 2010. All samples were surgically excised. Cox proportional hazard analyses were conducted to assess the presence of 22 individual TILs and risk of progression. Time-to-event analysis was conducted with the Kaplan-Meier (KM) method with differences assessed via log-rank.

Results: Median follow-up of samples following tissue collection was 12.7 months (range: 0.4-142.7 mo). Median patient age was 61 (33-78 y). The 12-month KM rates of time to progression were 80% and 60% for basal and squamous cell samples, respectively $P=0.12$. There were no significant differences between the RSI of basal cell (median 0.47, range: 0.28-0.86) and squamous cell samples (median 0.42, range: 0.26-0.54), $P=0.2$. The majority of basal and squamous cell samples were radioresistant, 73% and 69%, respectively. Significant differences were noted in the TIL profiles between samples noted to undergo progression and those that did not. Elevated expression of neutrophils (HR: 4.3; 95% CI 1.8-28.1; $P=0.03$) and decreased resting mast cells (HR 2.9; 95% CI 0.8-10.9; $P=0.09$) trended towards predicting progression. No other variables were found to be significant for progression.

Conclusions: The majority of basal and squamous cell samples were radioresistant in our analysis. Significant differences were noted in the presence of TILs between samples noted to undergo progression and those that did not. These results may help inform clinical decision making to identify tumors warranting treatment escalation.

(P088) Evaluating the Use of Primary Radiotherapy in Metastatic Head and Neck Cancers: A Retrospective Review

Riley McDougall¹, Nicholas Gravbrot¹, Charles Hsu, MD, PhD², Jared Robbins, MD³; ¹University of Arizona College of Medicine - Tucson, ²University of Arizona Cancer Center, ³University of Arizona

Background: Squamous cell carcinoma of the Head and Neck (SCCHN) presents with distant metastases in ~10% of cases. In this scenario, systemic therapy is the standard of care, but some patients receive local radiation therapy (RT). Understanding the prognosis and outcomes for these patients is important to guide management and determine the benefit of primary site RT in this population.

Objectives: To review treatment practices and evaluate the role of primary site RT in SCCHN with de novo distant metastatic.

Methods: Utilizing the National Cancer Database, a retrospective analysis was conducted using data from 2010 to 2015. Only patients with SCCHN and de novo distant metastatic disease were included. All treatment modalities were evaluated to determine treatment patterns. Univariate and multivariate analyses were performed for overall survival (OS). Case-controlled matching was used to compare chemotherapy (CHT) vs chemoradiation (CRT) with definitive intent. Comparisons were made with and without a landmark analysis before matching. Once matched, frequencies were analyzed. The 1-year OS, 3-year OS, and median OS were reported.

Results: 4667 patients were included: 33.3% oral cavity, 27.4% oropharynx, 11.2% nasopharynx, 24.2% larynx, and 3.8% had a sinus primary tumor. Osseous metastases alone were seen in 20.8% of patients, lung in 49.0%, liver in 7.50%, brain in 1.5% and multi-organ in 21.2% of patients. Primary-site RT alone was delivered to 444 patients, metastatic-site RT +/- CHT to 304, CHT alone to 1116, concurrent CRT (cCRT) to 679, sequential CRT (sCRT) to 536, surgical intervention +/- other modalities (SURG) to 530 (adjuvantly 303 with CHT and 248 with RT), and 1058 received no treatment. CRT patients had relatively more advanced disease and nodal involvement when compared with CHT. On multivariate analysis age, race, insurance status, Charlson-Deyo score, primary location, T4 status, metastatic location, and treatment modalities were significant. Median OS began from the start of therapeutic intervention: primary RT alone was 4.12 months, metastatic site RT +/- CHT was 5.65 months, CHT alone was 8.57 months, cCRT was 9 months, sCRT was 14.34 months, SURG was 10.5 months, and no treatment was 2.27 months. 2211 received RT, with 1410 receiving definitive intent (dRT) and 801 receiving palliative RT (pRT) (465 to primary, 336 to metastatic site): 16.2% receiving RT died in 30 days of receiving treatment (10.9% dRT, 25.5% pRT). In the matched cohort analysis, CHT vs CRT with and without a landmark analysis noted 44.2% vs 58.5% and 43.0% vs 54.7% OS at 1-year, 9.0% vs 20.8% and 9.7% vs 19.4% OS at 3-years, and a median OS of 11.14 vs 15.17 and 10.29 vs 14.58 months ($P < 0.001$) respectively.

Conclusions: Definitive primary-site RT added to CHT may improve overall survival in select patients with SCCHN with de novo distant metastases. Further study in prospective and randomized trials is warranted.

(P090) Evaluating Quality of Life and Functional Outcomes in Salvage Surgery for Head and Neck Cancer

John Riley, DO¹, Amy Williams, PhD², Keisha Best, MS³, Nitika Tripathi, BS³, Steven Chang, MD⁴, Tamer Ghanem, MD, PhD⁴, Suhail Momin, MD⁴, Farzan Siddiqui, MD, PhD, CPE⁵, Vivian Wu, MD⁴, Samantha Tam, MD, MPH⁴; ¹Henry Ford Macomb Hospital, ²Department of Otolaryngology-Head and Neck Surgery, Henry Ford Hospital, ³School of Medicine, Wayne State University, ⁴Department of Otolaryngology, Henry Ford Cancer Institute, ⁵Department of Radiation Oncology, Henry Ford Cancer Institute

Background: Unique challenges surround treatment for residual or recurrent head and neck squamous cell carcinoma (HNSCC). Of the limited treatment options for residual or recurrent HNSCC, salvage surgery is often the best option. However, salvage surgery can result in significant morbidity, affecting both quality of life (QoL) and functional outcomes. Few studies have examined QoL outcomes following salvage surgery in the setting of HNSCC.

Objectives: To analyze head and neck related quality of life and functional outcomes in patients with head and neck cancer who underwent salvage surgery.

Methods: In this IRB approved study, FACT-HN Version 4 was administered pre-operatively and 6 months post-operatively to patients undergoing salvage surgery for HNSCC between November 4, 2014 and April 27, 2020. Retrospective cohort analysis was performed on this population with major outcome being postoperative QoL score. Functional outcomes included postoperative tracheostomy and feeding tube status. QoL outcomes were compared with paired t-tests. Univariate logistic regression was used to determine characteristics associated with presence of permanent tracheostomy and feeding tube, defined as presence greater than 30 days.

Results: Overall, 25 patients undergoing salvage surgery for HNSCC were included in this analysis. Primary tumor sites were larynx/hypopharynx (44.0%), oral cavity (24.0%), oropharynx (20.0%), salivary (4.0%), skin (4.0%), and unknown primary (4.0%). Salvage surgeries consisted of total laryngectomy (36.0%), definitive neck dissection (24.0%), mandibulectomy (16.0%), parotidectomy (8.0%), with total laryngectomy/total glossectomy, radical tonsillectomy, TORS base of tongue excision, and transoral laser laryngeal excision all comprising 4% of cases. Total QoL scores were not significantly different preoperatively to postoperatively (mean 108.7, 95% CI=97.7 to 119.7 vs. 103.8, 95% CI: 93.1 to 114.5; $P=0.436$, with maximum total score of 148). Patients

with lower preoperative Emotional Well-Being (EWB) subscores demonstrated significantly worse EWB subscores postoperatively (post-operative mean: 17.0, 95% CI: 14.5 to 19.4 vs. 21.7, 95% CI: 20.0 to 23.4; $P=0.002$). Of patients who underwent tracheostomy tube placement, 53.8% ($N=7/13$) remained tracheostomy dependent long-term (> 30 d). Of patients who underwent feeding tube placement, 81.0% ($N=17/21$) remained feeding tube dependent long-term (> 30 d). Tracheostomy and feeding tubes remained in place with median durations of 3.02 months (range 0.16 to 20.55) and 10.13 months (range 0 to 24.89), respectively. All patients with T3/4 disease undergoing salvage surgery required long-term feeding tube ($N=6$).

Conclusions: This study provides important information about quality of life and functional outcomes for patients undergoing salvage surgery for HNSCC. There is a high rate of long-term tracheostomy and feeding tube dependence following salvage surgery. While no difference was found in head and neck related quality of life total score and sub-scores at 6 months postoperatively, general emotional well-being preoperatively was most associated with general emotional well-being postoperatively. This information should be taken into consideration when counseling and managing patients with residual or recurrent HNSCC.

(P091) A Two-decade, Single-institution Experience of Superficial Radiation for Squamous Cell and Basal Cell Carcinoma of the Skin in Select Patients

Sumi Sinha, MD¹, Priyanka Ghosh, MD², William Silveira, MD, PhD³, Jason Chan, MD⁴, Sue Yom, MD, PhD, MAS⁵; ¹University of California San Francisco, Department of Radiation Oncology, ²Weill Cornell Medical College, ³Clovis Community Medical Center, ⁴University of California San Francisco, ⁵University of California, San Francisco

Background: Skin cancer remains the most common form of cancer in the United States. Non-melanoma skin cancers (NMSC) including squamous cell carcinomas (SCC) and basal cell carcinomas (BCC) are largely considered curable disease with primary surgical resection. However, surgery may not be recommended in patients with cancers in cosmetically sensitive areas or who are of advanced age or with significant co-morbidities. Radiotherapy is also recommended for patients with positive margins after surgery, recurrent disease, or who prefer a non-surgical approach. Superficial radiotherapy has historically demonstrated excellent outcomes but its use has declined in recent years.

Objectives: The study aims to assess appropriate candidacy, therapy, and outcomes of patients with SCC or BCC of the skin undergoing treatment with superficial radiotherapy.

Methods: A single-institution cancer registry was used to identify patients who received superficial radiation for SCC or BCC from 10/2003–8/2020 and records were retrospectively reviewed. Toxicity was assessed using CTCAE version 5.0. Local control (LC) and overall survival (OS) were estimated using Kaplan-Meier curves with 95% confidence intervals (CI). All statistical analysis was performed in STATA (version 14.2).

Results: Sixty-six patients were identified, 18 with SCC and 48 with BCC. The median age was 78.6 years (interquartile range, IQR, 67.8–88.4 y) and 43% were female. A history of melanoma was uncommon (9%) though history of other NMSC was common (62%). Patients were predominantly referred for lesions of the face (72%) or for multiple lesions (15%) with the remaining having lesions in the head and neck (12%). All treatments were given at 100 KV. The median number of treated lesions was 1 (IQR 1-1) though up to 7 lesions were treated in a single patient. Median lesion size was 15 mm (IQR 8-25 mm). Referral was most often for surgical contraindications (32%) compared with medical contraindications (21%), patient preference (23%), or positive margins (18%). The most common treatment regimen was 51 Gy in 17 fractions (44%, biologically equivalent dose, BED = 66.3 Gy) followed by 40 Gy in 10 fractions (11%, BED = 56 Gy). Treatment was tolerated well with no grade 4 or higher toxicity though 3 patients (5%) experienced grade 3 toxicity. At a median follow-up of 1.9 years, overall outcomes were excellent with 1 year LC 94.2% (95% CI 83.4-98.1%) and 2 year local control 85.2% (95% CI 69.0-93.3%). One year OS was 94.1% (95% CI 82.8-98.1%) with no additional deaths at 2 years.

Conclusions: Superficial radiotherapy is an excellent treatment option for patients who have contraindications to surgical management or who prefer a non-surgical approach. These patients are more likely to be of advanced age and/or have lesions on the face. Superficial radiotherapy should be considered as a major primary treatment for SCC and BCC of the skin.

(P092) Utility of Chemotherapy in Intensity Modulated and Proton Beam Reirradiation Therapy of Recurrent Head and Neck Squamous Cell Malignancies

Moaz Soliman, MD¹, Chidinma Anakwenze, MD¹, Courtney Pollard, MD, PhD¹, Mark Edson, MD², Amy Moreno, MD¹, Jack Phan, MD, PhD³; ¹MD Anderson Cancer Center, ²Kaiser, ³The University of Texas M.D. Anderson Cancer Center

Background: More conformal radiation techniques have led to increased interest in reirradiation of head and neck cancer (HNC). The benefit of the addition of chemotherapy in the setting of reirradiation of recurrent HNC is currently unknown. We evaluated our 16-year institutional experience using intensity modulated radiation therapy (IMRT) and proton beam therapy (PBT) for reirradiation of recurrent HNC focusing on chemotherapy related outcomes.

Objectives: We aim to review the effects of using systemic therapy on survival outcomes, including induction chemotherapy (ICT) and/or concurrent chemotherapy (CC), in the setting of IMRT or PBT reirradiation in patients with recurrent HNC.

Methods: We retrospectively reviewed the records of consecutively treated patients between 1999–2016 with definitive IMRT or PBT reirradiation for recurrent HNC at one site to definitive doses. Only patients with Squamous Cell Carcinoma (SCC) histology and treated with curative intent were included in the analysis.

Results: Median follow-up for 209 eligible patients was 25.1 months (range 1-167). Patients with a complete response to induction systemic therapy demonstrated improved 2-year overall survival (OS) when compared with those patients that had either a partial response, no response, or progressive disease to induction chemotherapy (76% vs. 49%, $P=0.026$). There was no difference between partial responders and non-responders to induction chemotherapy with regards to OS. In addition, treatment with concurrent cisplatin doublet therapy demonstrated improved 2-year locoregional control (LRC) when compared with treatment with concurrent single agent carboplatin ($P=0.030$) or no concurrent chemotherapy ($P=0.023$) and trended towards improvement when compared with treatment with concurrent single agent cisplatin ($P=0.064$). Single agent platinum regimens did not improve LRC when compared with no concurrent chemo during HNC reirradiation.

Conclusions: Response to induction chemotherapy can be predictive of outcome in the setting of reirradiation of recurrent head and neck malignancies. Concurrent chemotherapy with particular platinum doublet regimens may improve LRC in the reirradiation setting.

(P093) Clinical Outcomes of Gamma Knife Boost for Head and Neck Cancers with Skull Base Extension

Alan Sosa, MD¹, Catherine Wang, PhD², Theresa Nguyen, BS², Jay Reddy, MD², Amy Moreno, MD², Adam Garden, MD³, David Rosenthal, MD², Steven Frank, MD², Clifton Fuller, MD, PhD², Shalin Shah, MD², William Morrison, MD², Gary Gunn, MD³, Shirley Su, MBBS, FRACS², Jack Phan, MD, PhD³; ¹MD Anderson, ²MD Anderson Cancer Center, ³The University of Texas M.D. Anderson Cancer Center

Background: Many Head and Neck Cancers (HNC) have a predilection for perineural spread which can track proximally and lead to skull base involvement. In cases of skull base involvement, including gross/residual disease after surgery, it can be challenging to deliver tumor-icidal radiotherapy dose without exceeding nearby critical structure constraints. The use of Gamma Knife stereotactic radiosurgery as a boost (GK-boost) to the overall radiotherapy (RT) plan may further improve sparing of these critical structures while escalating dose to disease in the skull base.

Objectives: We report the clinical outcomes of patients receiving a GK-boost to the skull base as a component of their overall RT plan.

Methods: Patients with HNC and gross/residual skull base disease after surgery treated with conventionally fractionated radiation therapy (IMRT/IMPT) plus a GK-boost were retrospectively reviewed. Six patients had squamous cell carcinomas, one patient had an adenoid cystic carcinoma, and another patient had an initially unclassified epithelioid malignancy most consistent with melanoma. Treatment toxicity, survival, and local control were evaluated.

Results: Of the patients evaluated, 5 received adjuvant radiotherapy within a mean of 7 weeks after surgery and 3 were treated with definitive radiotherapy. The median dose for IMRT was 66 Gy in 30-35 Fx. The median GK-boost dose was 8-12 Gy in a single fraction. The boost was delivered to the trigeminal nerve tract in 6 patients and the facial nerve tract in two patients. Median follow-up was 38 months. There were no local failures within the boost field but there was one local (and distant) failure in one patient with melanoma. Another patient developed a regional recurrence and expired. The regional recurrence occurred 11.2 months after completing treatment in the left orbit outside the prescribed PTV, which received 30 Gy or less. There were no grade 3 or higher acute toxicities associated with GK-boost but there were three patients that developed asymptomatic temporal lobe radionecrosis. The median onset of radionecrosis was at 12.8 months (range 9.3-33.9 mo) with a peak in radiographic necrosis after a mean of 11.9 months followed by a gradual improvement in two patients.

Conclusions: Gamma Knife boost to the skull base is well tolerated and provides a durable local control benefit. An ongoing dosimetric comparative study will assess the extent of normal tissue dose sparing. A larger prospective study is needed to validate these clinical findings.

(P094) Association of Gene Alterations and Patterns of Failure in HNSCC

Whitney Sumner, MD¹, Xenia Ray, PhD², Leisa Sutton, MAS², Daniel Rebibo, BS², Parag Sanghvi, MD², Vitali Moiseenko, PhD², Ida Deichaite, PhD²; ¹University of California, San Diego, ²Moore's Cancer Center, University of California, San Diego

Background: Head and neck squamous cell carcinoma (HNSCC) represents a profoundly heterogeneous collection of malignancies with rapidly evolving treatment paradigms. Next-generation sequencing has been increasingly utilized in patients with recurrent or metastatic disease, which generates tremendous potential to understand associations of genetic alterations with treatment outcomes in this population following radiation therapy (RT). The augmentation and validation of these associations is critical to the development of radiogenomic databases with a goal of personalized, risk-adapted therapeutic regimens.

Objectives: This study presents the findings of an initial evaluation of next-generation sequencing data in patients with HNSCC to identify associations with treatment outcomes.

Methods: Next-generation sequencing data was collected from HNSCC patients who received RT for primary or locally recurrent HNSCC. The twelve most commonly altered genes were included for analysis as genes of interest (GOI). Relevant patient characteristics and outcome data including local recurrence (LR) and distant metastasis (DM) were collected including site of metastatic disease. Associations with LR and DM were assessed for each of the GOI.

Results: A total of 35 patients met inclusion criteria. On bivariate analysis, LR was significantly associated with alterations in TP53 ($r=0.44$, $P=0.009$), CDK2NA ($r=0.49$, $P=0.003$), CASP8 ($r=0.35$, $P=0.04$) and NFE2L2 ($r=0.35$, $P=0.04$). Analysis of DM revealed that BRCA2 was associated with a higher likelihood of DM ($r=0.44$, $P=0.01$). Of patients who experienced DM, BRCA2 alterations were found in nearly 40% compared with 0% without DM. Only two patients experienced brain metastases, however these patients each harbored alterations in four GOIs with BRCA2, NOTCH1 and PIK3CA alterations found in both patients.

Conclusions: Assessment of gene alterations in HNSCC represents a promising area of exploration as we seek to predict treatment response to RT and understand the populations at greatest risk for LR or DM.

Here, we present next-generation sequencing in a cohort of HNSCC patients demonstrating associations of gene alterations with both LR and DM. Swift expansion of analyses in this domain are critical for both prognostication and treatment optimization in this complex population.

(P095) Re-irradiation of Recurrent or Second Primary Head and Neck Cancer After Prior Radiation: Initial Findings of an American Radium Society™ (ARS) Appropriate Use Criteria Systematic Review

Matthew Ward, MD¹, Shlomo Koefman, MD², Richard Bakst, MD³, Danielle Margalit, MD⁴, Beth Beadle, MD⁵, Jonathan Beitler, MD, MBA⁶, Steven Chang, MD⁷, Allen Chen, MD⁸, Jay Cooper, MD⁹, Thomas Galloway, MD¹⁰, John Ridge, MD, PhD¹¹, Jared Robbins, MD¹², Minh-Tam Truong, MBBS¹³, C. Jillian Tsai, MD, PhD, MS¹⁴, Sue Yom, MD, PhD, MAS¹⁵, Farzan Siddiqui, MD, PhD, CPE¹⁶; ¹Levine Cancer Institute, Atrium Health, ²Cleveland Clinic, ³Mount Sinai, ⁴Dana Farber Cancer Institute, ⁵Stanford, ⁶Knox County Health Clinic, ⁷Department of Otolaryngology, Henry Ford Cancer Institute, ⁸UC Irvine, ⁹Retired, ¹⁰Fox chase cancer center, ¹¹Fox Chase, ¹²The University of Arizona College of Medicine - Tucson, ¹³Boston University, ¹⁴Memorial Sloan Kettering Cancer Center, ¹⁵University of California, San Francisco, ¹⁶Department of Radiation Oncology, Henry Ford Cancer Institute

Background: In 2011, the Appropriateness Criteria for Retreatment of Recurrent Head and Neck Cancer After Prior Definitive Radiation were published. The American Radium Society (ARS) Appropriate Use Criteria (AUC) committee performed an updated literature review in 2021.

Objectives: Update the literature review to prepare for the upcoming AUC.

Methods: The ARS convened a multidisciplinary expert panel composed of radiation, medical and surgical oncologists. A search of the medical literature was conducted using subject-specific keywords in PubMed, Embase and Scopus databases. Five key questions were approved by the committee. Screening identified articles containing original data published from January 2000-December 2020 in the English language. Articles were removed if they focused on salvage therapies other than re-irradiation or were not otherwise relevant to one of the key questions. The final data tables contained the details of all systematic reviews, meta-analyses, and prospective randomized trials and the highest level of evidence available for each key question.

Results: The key questions are listed in Table 1. From the initial search, 686 citations were identified, of which 231 were duplicates. An additional 8 citations were identified through other sources. Of the resulting 463 abstracts, 189 were excluded because they were review manuscripts (N = 66) or because the primary subject focused on the initial course of therapy (N = 43), were in non-English language (N = 23), or were published before 2000 (N = 23). In total, 274 manuscripts informed the panel discussion, of which 9 were systematic reviews/meta-analyses, 5 were prospective randomized trials, 28 were single-arm prospective studies, 15 were multi-institution retrospective studies, 188 were single-institution retrospective studies and 29 were original manuscripts of other types (models, case reports, etc.). Table 2 presents the 30 studies identified by type, with those included in the detailed data table shaded (a single study may be included in multiple cells).

TABLE 1. Key Questions

KQ1	Is aggressive local therapy for rapid/large/incurable locoregional-only recurrences appropriate?
KQ2	What are appropriate treatment options for resectable disease?
KQ3	What is the appropriate management of patients treated nonoperatively?
KQ4	Is there an appropriate role for SBRT?
KQ5	What is the appropriate role of Re-RT for non-squamous histologies?

TABLE 2. Number and Types of Studies Identified in the Literature Search

	KQ1	KQ2	KQ3	KQ4	KQ5	Other
Systematic Review/Meta-analysis	0	2	1	1	0	5
Randomized Controlled Trial	0	2	3	0	0	0
Prospective, Single Arm	0	2	16	3	0	8
Retrospective, Multi-Institution	4	6	8	1	0	1
Retrospective, Single-Institution	14	27	82	31	8	41
Other	0	0	7	2	3	12

Conclusions: The AUC head and neck committee completed a literature search intended to update the original reirradiation publication in 2011. This updated literature review will inform the forthcoming updated AUC.

(P096) Expanding Our Understanding of Adherence: The Role of Health Literacy and Cognitive Function in Adherence and Outcomes in Head and Neck Cancer

Amy Williams, PhD¹, Maria Olex, PsyD², Mary Kate Miller, PsyD³, Marissa Gilbert, BS⁴, Farzan Siddiqui, MD, PhD, CPE⁵; ¹Department of Otolaryngology-Head and Neck Surgery, Henry Ford Hospital, ²Medical College of Wisconsin, ³UMass Memorial Medical Center, ⁴Henry Ford Health System, ⁵Department of Radiation Oncology, Henry Ford Cancer Institute

Background: Health literacy is the degree to which a person has the capacity to obtain, process, and understand basic information and services needed to make decisions about their health care. Poor health literacy has been associated with difficulties managing medications, assessing and evaluating health information, completing medical and financial forms, and comparing nutritional information of foods. As such, health literacy is closely related to adherence to medical treatment. Cognitive function contributes to one's health literacy, though also independently contributes to adherence. Patients with head and neck cancers require complex, often multimodal care, and both health literacy and cognitive function have been found to be lower than the general population. However no study has examined the interaction between cognitive function and health literacy within treatment for head and neck cancer and outcomes.

Objectives: To examine the role of cognitive function and health literacy in adherence to definitive and adjuvant radiotherapy and chemoradiotherapy and disease-free and overall survival in patients with head and neck cancer.

Methods: 149 patients who received either definitive or adjuvant radiotherapy or chemoradiotherapy for squamous cell carcinoma of the head and neck and were assessed by psycho-oncology provider before initiating treatment were included. Patients between August 2017 through March 2020 were included. Patients were administered the Montreal Cognitive Assessment (MoCA) and the Rapid Estimate of Adult Literacy in Medicine (REALM-SF) by the psych-oncologist before starting treatment. Cancer and treatment related variables, including adherence, were obtained via chart review. Adherence was defined as having completed the treatment recommended by the Multidisciplinary Tumor Board.

Results: Patients were predominantly male (78%), white (73%), with an average age of 62 years (SD = 9.1). The average years of education was 13.6 years (SD = 2.6). The mean health literacy score was 6.3 out of 7 (SD = 1.3, range 0-7), indicating reading at 7-8th grade level. The mean cognitive function score was 23.8 out of 30 (SD = 3.6, range 10-30, scores less than 26 are indicative of cognitive impairment). Sixteen percent of patients were non-adherent to treatment recommendations

and this was not associated with either health literacy or cognitive function ($P=0.5$ & 0.36 , respectively). Lower health literacy was associated with later stage at presentation ($P<0.05$). Health literacy was not associated with disease-free or overall survival ($P=0.66$ & 0.11 , respectively). However, cognitive function was associated with overall survival ($P<0.0001$) but not disease-free survival ($P=0.22$).

Conclusions: Psychosocial variables such as health literacy and cognitive function are infrequently considered or studied in head and neck cancer. However, there exists significant evidence that patients with head and neck cancer tend to have higher rates of cognitive impairment and lower health literacy than the general population. Further, literacy and cognitive function are known to contribute to health outcomes in other populations. The current study found that cognitive impairment, but not health literacy, is associated with overall survival, while not being associated with treatment adherence. Further research is needed into the pathways that cognitive function interacts with cancer care and survival. This study highlights the need for assessment of cognitive function in patients with head and neck cancer, as identification and intervention with these patients can aid in survival outcomes and quality of life.

(P097) Survival of Mucosal Melanoma Patients in the Immune Checkpoint Inhibitor Era

Charles Hsu, MD, PhD¹, Jessica Xing, MD², Baldassarre Stea, MD, PhD³, Shona Dougherty, MB, ChB, PhD², Montaser Shaheen, MD², Le Christopher, MD, FACS², Jared Robbins, MD⁴; ¹University of Arizona Cancer Center, ²University of Arizona, Tucson, ³Banner/University of Arizona/Dept. Radiation Oncology, ⁴University of Arizona

Background: Mucosal melanoma (MM) is an uncommon subtype of melanoma with a poor prognosis due to its aggressive behavior, typically arising in the head and neck, anorectal, and vulvovaginal regions. Surgical resection with adjuvant radiation or definitive dose radiation therapy for gross or residual disease have shown variable local control with frequent distant metastatic disease, poor response to cytotoxic chemotherapy, and generally worse survival than cutaneous melanoma (CM). The role of immune checkpoint inhibitors (ICI) is well-established for CM, but the utility of radiation therapy and ICI is poorly characterized for MM presenting with localized disease.

Objectives: Our goal was to explore practice patterns of treatment and examine survival of ICI and radiation therapy for MM presenting with localized/locally advanced disease.

Methods: We reviewed cases with histologically confirmed mucosal melanoma without distant metastasis (DM) at presentation who were treated with RT in the adjuvant or definitive setting at our institution from 2010–2021. Rates of local control (LC), DM, and overall survival (OS) were calculated with the Kaplan-Meier method and measured from the end of radiation therapy. The log-rank test was used to assess differences in survival.

Results: Of 17 patients with MM treated with RT, primary sites were N=15 (88%) head and neck and N=2 (12%) vagina with median

follow-up of 19.2 months. 52.9% of patients were female, and mean age at the time of RT was 68.2 years (11.8% <50 y and 47.1% >70 y). At diagnosis, 23.5% of head and neck and 0% of vaginal had nodal involvement. Surgical resection included partial biopsy (5.9%), excisional biopsy (11.8%), wide local excision (47.1%), and radical resection (35.3%), with 64.7% of patients having gross or residual disease. Technique used included fractionated IMRT/3D in N=14 (82.4%, mean dose 60 Gy, mean fractions 28.6), 3D conformal (45 Gy/25fxns) with brachytherapy boost (15 Gy/5fxs) in N=1 (5.9%), brachytherapy alone (30 Gy/5) in N=1 (5.9%), and SBRT alone (30 Gy/5) in N=1 (5.9%). Mean BED a/b=2.5 was 110 (92.4-129.3) with mean EQD2 of 61.3 Gy (median 60.2 Gy, 51.4 Gy-71.8 Gy). Of N=12 with tumor sequencing, none were BRAF positive and N=1 (8.3%) PD-L1 positive. 94.1% of patients were treated with ICI with N=3 with CTLA-4 inhibitor alone (17.7%), N=6 with CTLA-4/PD-1 inhibitor (35.3%), and N=7 with PD-1 inhibitor alone (41.2%). N=2 (12%) received ICI as initial treatment, N=7 (41%) adjuvant after surgery and/or RT, and N=7 (41%) after recurrence. Overall survival: As of last follow-up, 35.3% of patients were deceased, and median OS was 50.2 months with 1-, 2-, and 5-year OS of 92.9%, 71.6%, and 35.8%. Median OS was longer for those without gross disease after surgery (91.1 mos vs. 32.1 mos) as well as those treated to EQD2 >=60 Gy (50.2 mos vs. 20.4 mos) but not statistically significantly different (log-rank $P>0.05$). Local control: N=7 (41.2%) had local recurrence: 2 patients progressed locally before completion of RT, another 5 progressed after completion of RT with median local-recurrence free survival (LRFS) of 48.0 month and 1-, 2- and 5-year LRFS of 76.2%, 76.2%, and 38.1%. Though patients without gross disease had median LRFS of 60.9 months, even those with gross disease treated with adjuvant or definitive dose RT had fair LC with LRFS of median 48.0 months, log-rank $P=0.15$. Median LRFS was greater but not statistically significantly different for those treated to EQD2 >=60 Gy (>=60 Gy 48.0 mos vs. <60 Gy 11.3 mos, log-rank $P=0.81$). Distant metastases: N=13 (76.5%) of patients developed distant metastases. Median DM-free survival (DMFS) was 13.2 months, with 1-, 2-, and 5-year DMFS of 53.7%, 30.7%, and 10.2%. Median DMFS did not differ by gross residual tumor (none 13.2 vs. yes 15.2 mos, log-rank $P=0.77$) or by EQD2 >=60 Gy (<60 Gy 11.3 months vs. >=60 Gy 17.2 months, log-rank $P=0.16$). OS, LRFS, and DMFS did not differ by type and timing of ICI (log-rank $P>0.05$).

Conclusions: Among patients treated with either adjuvant or definitive RT for localized mucosal melanoma of the vagina and nasal/paranasal cavities, nearly all patients received ICI, though timing and type of ICI was variable. Gross total resection and dose of radiation seemed to influence OS, though these factors were not statistically significantly associated with outcomes due to the small number of patients. Unfortunately, distant metastases affected the majority of patients and appeared to drive outcomes. We were unable to determine how ICI administration influenced their survival as most patients were treated with these drugs. Further prospective/randomized studies are necessary to better evaluate optimal methods and sequencing of therapy to improve survival in this rare and deadly disease (Figs. 1 and 2).

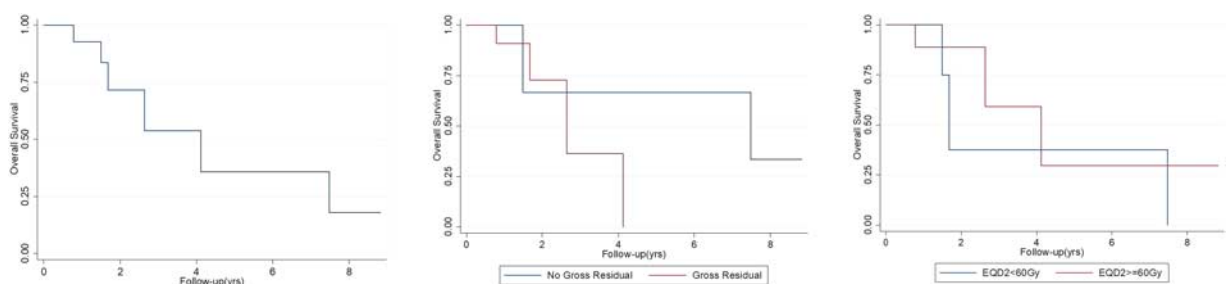

FIGURE 1. Overall survival for all patients, and by gross disease and RT dose.

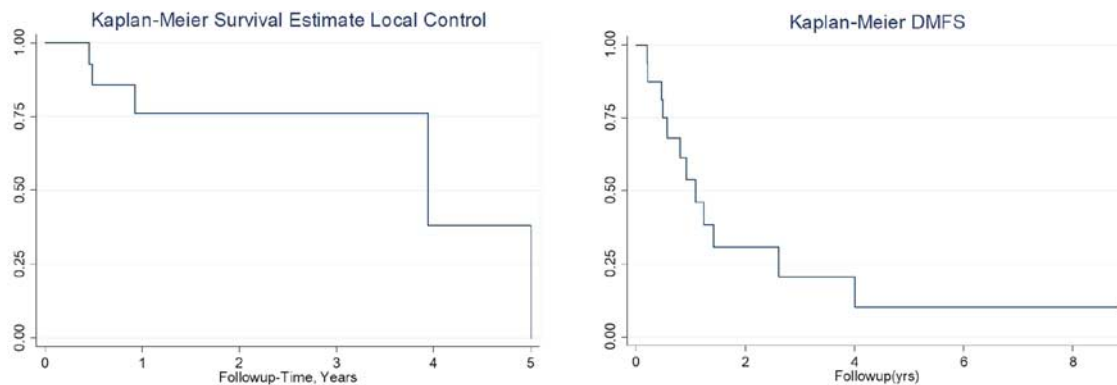

FIGURE 2. Local recurrence and distant metastasis free survival.

(P098) A Prospective Trial Evaluating Patient Reported Outcomes (PROs) of Oral Stents Fabricated Using Intraoral Scanning (IOS) and 3D Printing for Head and Neck Cancer Patients Receiving Radiotherapy (RT)

Mohamed Zaid, MD¹, Nimit bajaj, BDS, MPH², Ryan Mathew, BS², Millicent Roach, BS², Anshuman Agrawal, BS², Christopher Wilke, MD, PhD³, Caroline Chung, MD, MSc², Clifton Fuller, MD, PhD¹, Gary Gunn, MD⁴, Jack Phan, MD, PhD⁴, William Morrison, MD¹, Adam Garden, MD⁴, Steven Frank, MD¹, David Rosenthal, MD¹, Richard Cardoso, DDS, MS², Ruth Aponte Wesson, DDS, MS², Adegbenga Otun, BDS², Mark Chambers, DMD, MS², Eugene Koay, MD PhD⁵; ¹MD Anderson Cancer Center, ²The University of Texas, MD Anderson Cancer Center, ³University of Minnesota, ⁴The University of Texas M.D. Anderson Cancer Center, ⁵MD Anderson

Background: Oral stents can be useful in improving the therapeutic index of RT in patients (pts) with head and neck cancer (HNC). However, standard stents require extensive resources to fabricate, which are less likely to exist outside academic institutions and therefore limit their utilization in community practices.

Objectives: Previously we reported that 3D printed stents are non-inferior to standard stents in terms of PROs and positioning reproducibility. Also, we showed that 3D printed stents require significantly less time and resources to fabricate (Zaid, et al Oral Oncology 2020). Here, we report the interim results of the second cohort of this trial, in which we utilize IOS and virtual articulating techniques to create the stent.

Methods: Prospectively, we evaluated pts with HNC who were dispatched to receive RT and prescribed mouth-opening tongue-depressing stents. Pts had their traditional impressions and bite records acquired (~2 cm mouth opening) to construct a stone model that would be used to manually craft the traditional wax pattern for simulation and the acrylic stent for RT. Then, we used IOS to scan the patient's upper and lower teeth, and the closed bite registration. Scan files were imported to computer aided design (CAD) software, where we used a home-developed virtual articulator to simulate the 2 cm mouth opening. Then, we designed and 3D printed the stents as previously described (Zaid, et al RO 2019). Pts inserted the 3D printed stent and the traditional stent for 5–10 minutes at 3 time points (TP): 1) before simulation (wax pattern), 2) pre-treatment (acrylic stent), and 3) mid-treatment (weeks 3–5 of RT, acrylic stent). After each TP for each stent, pts were asked to fill out a questionnaire covering the design domains of oral stents that included comfort, ease of insertion, gagging, jaw pain, roughness and stability in treatment position (Kaanders, et al IJROBP 1992). Each question was graded on a scale of 0 (best) to 10 (worst). We used Matched-Pairs test for statistical analysis at significance level of <0.05.

Results: With a target of 10 evaluable pts, four pts fulfilled our inclusion criteria, and completed the three TPs (age 26–73 years, 4

male, 3 oropharyngeal cancer and 1 nasopharyngeal cancer, median RT dose = 68 Gy). At the first TP, there was no significant difference between the 3D printed stent and the wax pattern scores (mean difference = -2.3, 95%CI [5, -10], $P=0.36$). Similarly, there was no significant difference in the overall scores of the 3D printed (mean difference = -1.25, 95%CI [2, -4], $P=0.3$) and acrylic stents combining TPs 2 and 3.

Conclusions: The interim results indicate that 3D printed stents designed using IOS, virtual articulators and CAD are not superior, and potentially not inferior to the traditional stent in terms of PROs. This updated digital workflow can further expand the utilization of these devices to radiation oncology practices that currently lack the support to make these devices.

(P099) Compromising Care of Cervical Cancer Patients Through Disincentivizing Brachytherapy: Exploring the Impact of Reimbursement on Utilization and Outcomes

David Boyce-Fappiano, MD¹, Kevin A. Nguyen, MS², Mitchell Kamrava, MD³, Olsi Gjyshi, MD, PhD¹, Lauren Andring, MD⁴, Ann H. Klopp, MD, PhD⁵, Catheryn Yashar, MD⁶, Peter F. Orio III, DO, MS⁷, Nikhil G. Thaker, MD⁸, Albert Chang, MD, PhD⁹; ¹MD Anderson Cancer Center, ²David Geffen School of Medicine, University of California Los Angeles (UCLA), ³Cedars-Sinai Medical Center, ⁴UT MD Anderson Cancer Center, ⁵The University of Texas MD Anderson Cancer Center, ⁶UC San Diego School of Medicine, ⁷Dana-Farber Cancer Institute, Brigham and Women's Hospital, ⁸Arizona Oncology, ⁹University of California Los Angeles

Background: Optimal management of locally advanced cervical cancer (CC) involves multi-modality therapy with chemotherapy and combined external beam radiation therapy (EBRT) and brachytherapy (BT). There are growing concerns regarding decreased BT utilization despite evidence displaying compromised outcomes without BT.

Objectives: We sought to explore patterns of BT utilization and relate these findings to changes in reimbursement while exploring the impact of the new radiation oncology alternative payment model (RO-APM).

Methods: This study included a total of 21,153 patients from the Surveillance, Epidemiology, and End Results registry with a diagnosis of cervical cancer between 1988 and 2015 who received radiation therapy without any surgery to their primary site. Utilization patterns to be reflective of the RO-APM were conducted on all patients. A sub-cohort of patients with locally advanced (stage IB2-IVA) non-metastatic disease were utilized to determine utilization patterns and survival outcomes (n = 14,121). Overall (OS) and disease-specific survival (DSS) were compared between

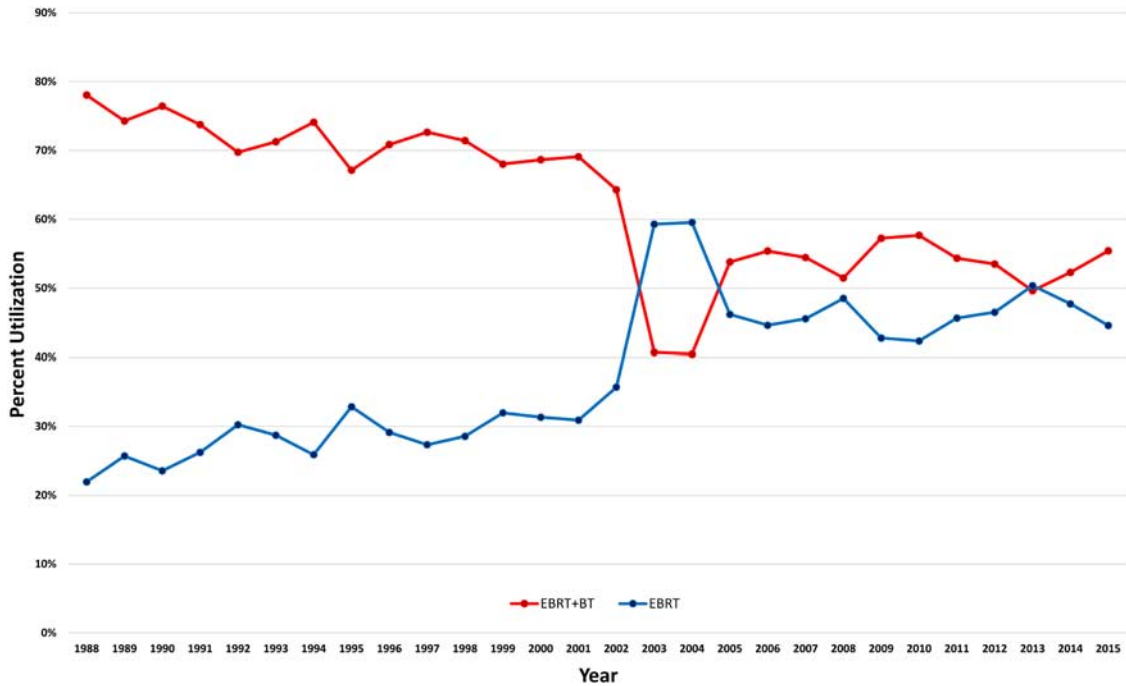

FIGURE 1. Trends in radiation modality utilization for cervical cancer from 1988 to 2015.

radiation modalities within this sub-cohort. Medicare episodes and reimbursement rates for EBRT and BT were obtained from 2009-2020. Reimbursement levels were compared using multiple methodologies including MPFS, Ambulatory Payment Classification (APC), comprehensive APC (C-APC) and the newly proposed RO-APM.

Results: In total, 10,107 (47.8%) and 5,888 (41.7%) patients received EBRT while 11,046 (52.2%) and 8,233 (58.3%) received EBRT + BT in the overall and sub-cohort respectively. Overall from 1988-2015 BT utilization declined by 22.7%. Within the sub-cohort median OS was 2.33 and 5.92 years while median DSS was 4.0 vs. 17.4 years for EBRT and EBRT + BT respectively ($P < 0.0001$). Treatment with BT was associated with improved OS (HR: 0.68, 95%CI:

0.65-0.71, $P < 0.0001$) and DSS (HR: 0.68, 95%CI: 0.64-0.71, $P < 0.0001$). Black race, increasing age and higher stage disease were associated with inferior outcomes. Medicare claims for BT declined by 42.1% from 2009-2020 with the steepest decline occurring in 2017 (42.2%) correlating with a 66.7% cut in reimbursement with C-APC implementation. On comparison of payment methodology for 2018 RO-APM final rule resulted in a 31.7% cut from the current C-APC model, and a 51.5% reduction from the APC model.

Conclusions: Brachytherapy utilization continues to decline and closely mirrors changes in reimbursement. In its present form, RO-APM will amplify the already substantial reductions in reimbursement thus threatening the sustainability of BT and compromising care for CC patients (Figs. 1-3).

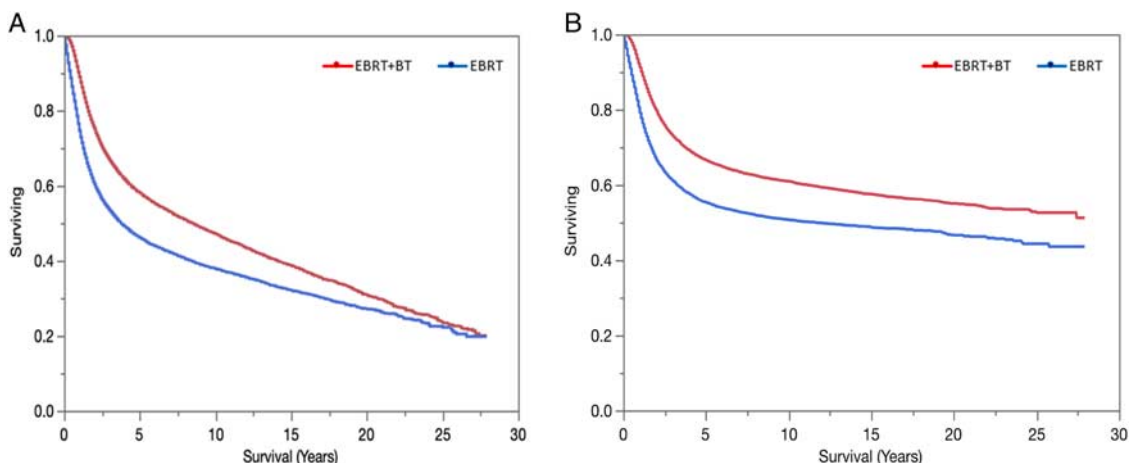

FIGURE 2. Kaplan Meier curves comparing (A) overall survival by receipt of radiation (B) disease-specific survival by receipt of radiation for patients with locally advanced cervical cancer (stage IB2-IVA).

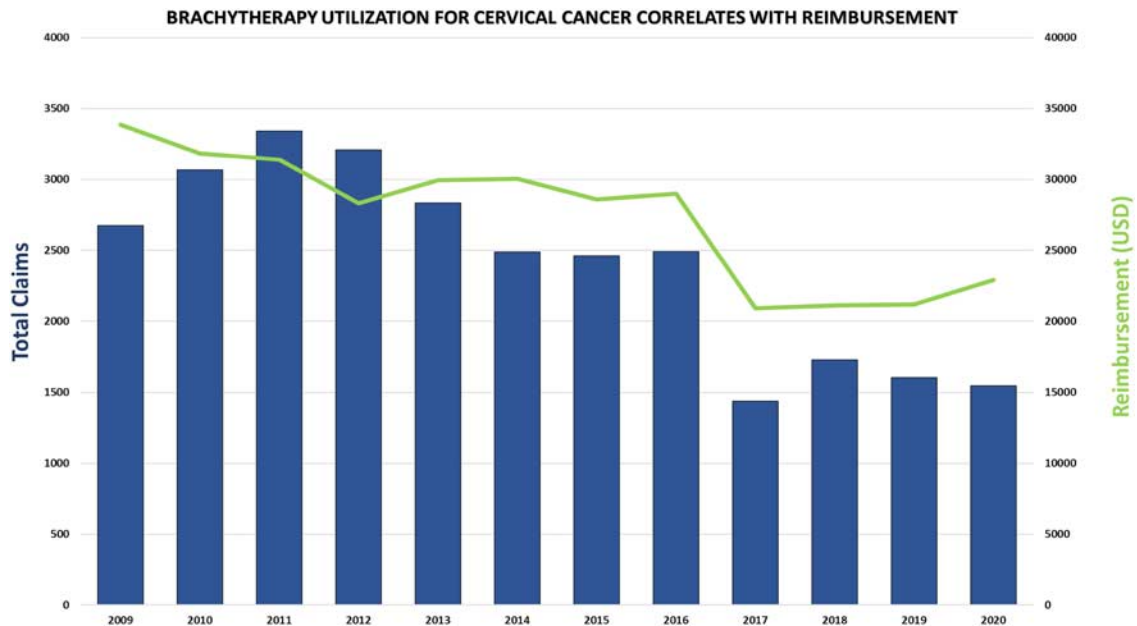

FIGURE 3. Comparison of Medicare claims filed for cervical cancer brachytherapy and expected annual reimbursement utilizing the ambulatory payment methodology for HOPDs (APC FFS from 2009-2016 and C-APC from 2017-2020).

(P100) Impact of Socioeconomic Status on Cervical Cancer Prevention and Screening

Christine Hill-Kayser, MD¹, Ronak Dave, BA², Michael LaRiviere, MD¹, Carolyn Vachani, MSN, RN, AOCN¹, Margaret Hampshire, RN, BSN, OCN¹, James Metz, MD¹, Christina Bach, MSW, MBE, LCSW³, Karen Arnold-Korzeniowski, BSN, RN¹, Marisa Healy, BSN, RN¹; ¹University of Pennsylvania, ²Augusta University/University of Georgia Medical Partnership, ³Oncolink

Background: Cervical cancer (CC) screening effectively reduces rates of CC, and is recommended by the U.S. Preventative Services Task Force, American College of Gynecology, and American Cancer Society. (Curry S, et al, JAMA 2018; Practice Bulletin No. 168, Obstetrics and Gynecology 2016, Fontham E, et al, A Cancer Journal for Clinicians 2020) Prior research has shown that over 50% of invasive CC in countries with screening programs are in women who are underscreened, and differences in CC screening are associated with race, age, income, education, geography, and healthcare access. (Bos A, et al, International Journal of Cancer 2006; Akers A, et al, Current Problems in Cancer 2007).

Objectives: We attempted to determine how income, family history, and Medicaid expansion were related to utilization of CC screening and/or vaccination and avoidance of risk factors.

Methods: A convenience sample was obtained from users voluntarily completing an Internet-based survey designed to assess individual cancer risk (oncolink.org). (LaRiviere M, et al, ASCO 2019) Analysis was limited to users who self-identified as women living in the U.S. Users were classified as lower income (LI) [annual household income (AHHI) < \$25,000] and higher income (HI, AHHI > \$100,000) and stratified by age (≤25 vs 26+). Comparisons of before vs. after Medicaid expansion were limited to users living in states that had implemented expansion of Medicaid. Due to the large number of comparisons, the 2-tailed P-value cutoff was set to 0.0026.

Results: Of eligible users, 1,774 identified as LI (64% ≤25 y, range <18-80, 70% white), and 2,257 identified as HI (31% ≤25 y, range <18-74, 84% white). With the exception of rates of vaccination in those >25y and pap smears in those ≤25y, HI patients tended to access preventative services and avoid risk factors for CC at the highest rates (Table 1). Further examination of LI group demonstrated that FH of CC did not impact rates of vaccination against HPV or risky sexual activity

TABLE 1. Effect of Income on Rates of Cervical Cancer Prevention use and Risk Factor Avoidance in Higher vs. Lower Income Patients, Stratified by Age

	Age ≤ 25	Age > 25
Higher rates of up-to-date pap smears	Lower income (29.1% vs. 45.3%, p < 0.0001)	Higher income (91.9% vs. 73.4%, p < 0.0001)
Higher rates of HPV vaccination	Higher income (59.6% vs. 45.6%, p < 0.0001)	Lower income (7.6% vs. 11.9%, p = 0.0013)
Higher rates of 0-5 lifetime sexual partners	Higher income (82.8% vs. 70.9%, p < 0.0001)	Higher income (54.2% vs. 35.0%, p < 0.0001)
Higher rates of abstinence from receptive anal sex	Higher income (88.5% vs. 78.2%, p < 0.0001)	Higher income (79.9% vs. 60.2%, p < 0.0001)

Results are presented with highest frequency user group (lower vs higher income) listed in each age group and for each mechanism of prevention. Comparisons refer to higher income vs. lower income.

TABLE 2. Effect of Either a Family History of Cervical Cancer (Stratified by Age) or Medicaid Expansion on Rates of Cervical Cancer Prevention Use and Risk Factor Avoidance in Lower Income Patients

	Family History		Medicaid Expansion
	Age ≤ 25	Age > 25	All ages
Higher rates of up-to-date pap smears	--	No difference (72.6% vs. 83.3%, p = 0.104)	No difference (66.1% vs. 57.3%, p = 0.293)
Higher rates of HPV vaccination	No difference (50.3% vs. 45.3%, p = 0.441)	--	No difference (17.7% vs. 36.0%, p = 0.0175)
Higher rates of 0-5 lifetime sexual partners	No difference (70.7% vs. 72.7%, p = 0.730)	No difference (35.0% vs. 34.7%, p = 0.968)	--
Higher rates of abstinence from receptive anal sex	No difference (78.2% vs. 77.3%, p = 0.861)	No difference (61.6% vs. 42.9%, p = 0.0100)	--

Results for family history are presented as negative family history vs. positive family history. Results for Medicaid expansion are presented as before expansion vs. after expansion.

(Table 2). Of LI users living in states with Medicaid expansion, 63 responses were submitted before expansion (46% ≤ 25 y, age range 18-73, 75% white), and 75 responses were submitted after (45% ≤ 25 y, age range 18-64, 61% white). Medicaid expansion did not significantly affect rates of adherence with pap smears or HPV vaccination (Table 2).

Conclusions: Individuals with greater income demonstrated better access to preventative care and avoidance of risk factors associated with cervical cancer. In the LI user group neither FH of CC nor Medicaid expansion impacted rates of access to preventative services or avoidance of risk factors. These findings point to need for education surrounding CC risk and prevention, particularly for LI women, regardless of age, insurance status, or family history.

(P101) Your Cancer Journey: The Development of a Culturally Informed Patient Education Material to Improve Willingness to Pursue Radiation Therapy in American Indian & Alaska Native Individuals (View Study)

Sasha Ebrahimi, PhD¹, Todd DeWees, PhD², Farhia Omar, MPH², Timothy Mathews, FNP – BC³, Donald Northfelt, MD², Samir Patel, MD²; ¹Mayo Clinic Arizona, ²Mayo Clinic, ³Phoenix Indian Medical Center

Background: Patients from American Indian and Alaska Native (AI/AN) these communities are often diagnosed with advanced stage cancers and do not complete guideline concordant cancer care. A recent study by our group at the Mayo Clinic, in collaboration with the Phoenix Indian Medical Center (PIMC), shows that many AI/AN patients are concerned about side effects of radiation therapy (RT) and their concerns are directly associated with the inability of their providers to explain their treatments adequately (Patel SH, et al Cancer Control 2020). Studies show that standardized patient education that use diverse cultural representation and simple language can lead to better clinical outcomes – particularly in populations with low health literacy. Here

we propose a project to address the communication barrier AI/AN patients face by using a culturally informed brochure.

Objectives: 1. To design an educational aid that addresses concerns and questions specific to the AI/AN population in a culturally informed manner with input from all stakeholders. 2. To subsequently use this material to assess improvements in patient anxiety, perception of information received, and RT completion rate in a randomized controlled trial.

Methods: Members of the PIMC staff and the AI/AN patient appearing in the brochure served as community advisors and helped us refine the brochure's language and images in an iterative process. 100 adult AI/AN patients receiving cancer treatment at the PIMC will be recruited. 50 patients will receive the standard Mayo Clinic educational booklet while the other 50 patients will also receive our educational brochure. All patients will be surveyed twice, once at their clinical visit where radiation therapy referral is made, and a subsequent visit 1-2 weeks later to assess patient anxiety and perception of the information received.

Results: Community advisors identified the following key elements for the brochure: 1. Graphic representation of native communities and Arizona landscapes. 2. Employing motifs of windows and doorways to elaborate on cultural themes of illness as a journey. 3. Depicting native patients and their family in a story-telling manner. 4. Avoiding complex topics such as fractionation. 5. Including reassuring verbiage, and 6. Highlighting importance of exercise, eating healthy, and family support. The prototype was designed through an unique collaborative effort with the Phoenix Indian Medical Center and the Mayo Clinic (Figs. 1 and 2). The project has received IRB approval and is currently proceeding with activation.

Conclusions: Adapting medical educational literature to make the language and imagery inclusive, accessible, and understandable may be a powerful tool towards equitable care. This study serves as a prototype that can be utilized in addressing underserved communities facing communication barriers in other clinical contexts.

SOME WORDS YOU MIGHT HEAR AND WHAT THEY MEAN:

Radiation Therapy or radiotherapy is when we use energy beams and point them towards the cancer. Radiation is how we describe the beam of energy. Your doctor may describe parts of your body that have been 'irradiated' – this means these parts have received radiation.

Proton beam therapy is a new type of radiation therapy. The energy beam contains 'protons' and it may be safer to the healthy parts of your body.

Photon beam therapy is another type of radiation therapy. The energy beam contains 'photons' – or light particles similar to X-rays. This is how radiation therapy has been done for many years.

Curative intent is when radiation therapy is used with the goal of removing cancer from your body.

Palliative intent is when radiation therapy is used with the goal of reducing pain to make you more comfortable.

Simulation is when the radiation team brings you in before your treatment. They will position you and figure out the exact location and size of the area to be treated. You will not receive radiation during simulation. The team may give you contrast to drink or through IV needle. Contrast is a mixture that allows them to see your internal organs better.

mayoclinic.org

©2020 Mayo Foundation for Medical Education and Research. All rights reserved. MAYO, MAYO CLINIC and the triple-shield Mayo logo are trademarks and service marks of MMR.

V1395014

Dose is the amount of radiation that you will receive. More radiation will kill more cancer, but will also cause your body more damage. Balance is key.

Fractions are the number of radiation treatments that you will get. Treatment is given once a day. Your doctor will recommend how many days your treatment will last. There may be a chance to do less sessions; talk to your doctor.

Biopsy is when your team takes a small piece of the cancer to look at it under a microscope. This helps them learn more about your cancer.

CT or "cat" scan is when they take a 3D image of your body. It helps the doctors see what is happening inside the body.

PET scan is another type of imaging. It lets the doctors see which parts of your body are using more energy; which usually happens in parts that have cancer.

Stage (1,2,3, or 4) is a way doctors describe how serious the cancer is. The higher the number means the cancer is more serious.

Grade is a way doctors describe the shape and look of the cancer cells. It may also tell us how dangerous the cancer is.



Your Cancer Journey

Radiation Therapy



FIGURE 1. Bifold brochure, outside view.



Radiation can be both helpful and harmful. Natural Radiation is everywhere: sun light, plants, soil, rocks and even healthy human bodies!

Balancing the good and bad effects of radiation is very important in your treatment. Your radiation team will talk with you about how to manage the bad side effects.



Your radiation treatment is typically once a day everyday, for 3 - 6 weeks. There may be an option for less treatment sessions. Ask your doctor.



FIGURE 2. Bifold brochure, inside view.



Cancer is scary, but you don't have to face it alone. This brochure is meant to answer just a few questions.

Please ask your healthcare team any time you have a question or concern.



TREATING CANCER

There are hundreds of different cancers. They all cause unwanted growth in your body. Radiation Therapy is when we take a beam of energy and try to get rid of unwanted growth.



A healthy lifestyle will help you fight cancer. You may be able to do your usual activities, like working or caring for your family, during radiation. Ask your doctor.

(P102) Changing Landscape of Community Oncology Differential Delay in Cancer Diagnoses Due to the COVID 19 Pandemic

Mitchell Finkelstein, High School Student¹, Kevin Healey, Medical Student 1st year², Steven Finkelstein, MD, DABR, FACRO¹; ¹FCA/US Oncology Network, ²AUI

Background: In March 2020, the U.S. health-care system delayed performing routine procedures secondary to the COVID-19 pandemic. The number of cancer screenings plummeted according to data from Medicare, insurers, and electronic medical records. It is unclear if this delay effected all facets of community oncology equally.

Objectives: To test the hypothesis of a differential delay in cancer diagnoses by disease subsite in some community oncology organizations due to the COVID 19 pandemic.

Methods: This is a retrospective review of prospectively collected data; new patients referred to a large multispecialty community oncology organization before COVID 19 (quarter 2 April-June 2019) were compared with during COVID 19 (quarter 2 April-June 2020). Data was obtained using Centricity and iKnowMed electronic medical records for completeness. Cancer disease subsites data (n = 24) were recorded and compared.

Results: As compared with previous year quarter 2 (analogous time period before COVID 19 pandemic), there was an overall decrease in new patients cancer referrals to a large multispecialty community oncology organization. Out of twenty four different cancers subsites, 14 (58%) were decreased. Brain, carcinoid, and breast (DCIS) were greatest decreased by 75%, 50%, and 40% respectively. Common cancers skin, breast, and lung were decreased by 6.8%, 5.3%, and 11.7%. Interestingly, head and neck (unknown primary), GI (upper), and multiple myeloma were increased by 150%, 52.6%, and 45.4%.

Conclusions: The data suggest a differential delay in cancer diagnoses by disease subsite in some community oncology organizations. Interestingly, head and neck (unknown primary) was increased by 150% suggesting referral before complete staging. Further data over time will assess if these changes persist into the future.

(P103) Worsening Disparities in Intensity-modulated Radiotherapy Utilization Among Non-Hispanic Black Patients

Ryan Hutten, MD¹, Christopher Weil, MD², David Gaffney, MD, PhD¹, Kristine Kokeny, MD³, Shane Lloyd, MD⁴, Charles Rogers, PhD, MPH, MS, MCHES⁵, Gita Suneja, MD²; ¹Huntsman Cancer Institute at the University of Utah, ²University of Utah Huntsman Cancer Institute, ³Huntsman Cancer Hospital, University of Utah, ⁴University of Utah, Huntsman Cancer Institute, ⁵University of Utah School of Medicine

Background: Across many cancer sites, intensity-modulated radiotherapy (IMRT) results in improved quality of life, decreased acute and late toxicity, and opportunities for dose escalation compared with standard 3D conformal radiotherapy (3DCRT). Sparse published

TABLE 1. Likelihood of IMRT Utilization in Non-Hispanic Black Patients

Cancer type	2004-2010		2011-2017	
	AOR‡	95% CI	AOR‡	95% CI
H&N	0.79	[0.73,0.84]*	0.88	[0.82,0.93]*
Esophagus	0.86	[0.73,1.01]	0.89	[0.80,0.99]*
Stomach	1.11	[0.88,1.40]	1.02	[0.89,1.18]
Rectum	1.06	[0.93,1.20]	0.90	[0.83,0.98]*
Anus	1.14	[0.98,1.34]	0.92	[0.82,1.04]
Brain	1.96	[0.79,4.86]	1.20	[0.48,2.99]
Lung	0.97	[0.90,1.04]	1.01	[0.97,1.05]
Cervix	0.87	[0.74,1.02]	0.82	[0.73,0.91]*
Uterus	1.02	[0.85,1.22]	0.86	[0.76,0.97]*
Prostate	0.99	[0.95,1.02]	1.00	[0.97,1.04]

‡ Adjusted odds ratio relative to NHW; *p<0.05

TABLE 2. Subset Analysis of IMRT Usage Based on Insurance in Non-Hispanic Black Patients

Cancer type	Private insurance		Medicare	
	AOR‡	95% CI	AOR‡	95% CI
H&N	0.834	[0.768,0.907]***	0.835	[0.776,0.898]***
Esophagus	0.897	[0.753,1.069]	0.848	[0.743,0.967]*
Stomach	1.225	[0.998,1.503]	1.017	[0.855,1.210]
Rectum	0.884	[0.787,0.992]*	1.021	[0.913,1.142]
Anus	0.956	[0.819,1.115]	1.004	[0.857,1.175]
Brain	1.518	[0.556,4.145]	0.918	[0.258,3.270]
Lung	0.981	[0.915,1.053]	1.001	[0.956,1.048]
Cervix	0.747	[0.639,0.873]***	0.891	[0.750,1.059]
Uterus	0.899	[0.759,1.066]	0.89	[0.770,1.028]
Prostate	0.991	[0.953,1.031]	0.978	[0.945,1.011]

‡ Adjusted odds ratio relative to NHW; *p<0.05

literature from the early IMRT era suggests non-White patients had lower rates of IMRT utilization, yet the magnitude IMRT-related disparities has not been reported as IMRT utilization has increased.

Objectives: To evaluate temporal trends in IMRT utilization when stratifying by race and ethnicity.

Methods: The National Cancer Database was queried to identify 10 disease sites with the highest total number of cancer patients treated with definitive-intent IMRT in 2017, the most recent year of available data. Patients who were stage IV at diagnosis, <18 years of age, had unknown insurance status or race, or treated with palliative intent radiation were excluded. Race and ethnicity were classified as Asian, Hispanic, Hawaiian/Pacific islander, Native American/Eskimo, non-Hispanic Black (NHB), and non-Hispanic White (NHW). Using clinical and demographic covariates, multivariable logistic regression for IMRT utilization was conducted for each disease site for both early (2004-2010) and contemporary (2011-2017) cohorts.

Results: Among 10 disease sites (see Table 1), 1,010,292 patients received radiotherapy as part of definitive treatment with rates of IMRT utilization increasing from 22.0% to 57.8% between 2004 and 2017. When adjusting for clinical and sociodemographic covariates, NHB patients were significantly less likely to receive IMRT in 1 of 10 disease

sites in the 2004-2010 cohort, and 5 of 10 disease sites in the 2011-2017 cohort compared with NHW patients (see Table 1). Of 119,601 NHB patients, 33.3% had private insurance, 46.3% had Medicare, 46.3% had Medicaid, and 4.61% had no insurance. Compared with patients with private insurance in the contemporary cohort, patients insured by Medicare were more likely to receive treatment with IMRT in 6 of 10. Subset analyses by insurance status revealed that NHB patients with private insurance or Medicare were less likely to receive IMRT in 3 of 10 and 2 of 10 disease sites, respectively (see Table 2).

Conclusions: Despite greater awareness of racial disparities in cancer care and outcomes, this study demonstrates that as IMRT utilization has increased over time, the disparity in utilization of IMRT between NHB and NHW patients has worsened. Compared with private insurance, patients with Medicare appear to have higher likelihood of IMRT utilization on multivariate analysis, however disparities exist even when stratifying by insurance type. Further investigation of the underlying drivers of differential IMRT use—including the role of prior authorization for IMRT utilization in patients with private insurance and social determinants of health such as insurance access—is warranted.

(P104) Design and Implementation of an Internet-Based Cancer Risk Assessment Tool: Use over 10 Years

Michael LaRiviere, MD¹, Ryan O'Keefe, BS¹, Maribel Carpenter¹, Hann-Hsiang Chao, MD, PhD², Isabella Amaniera¹, Carolyn Vachani, MSN, RN, AOCN¹, Margaret Hampshire, RN, BSN, OCN¹, Christina Bach, MSW, MBE, LCSW³, Karen Arnold-Korzeniowski, BSN, RN¹, James Metz, MD¹, Christine Hill-Kayser, MD¹; ¹University of Pennsylvania, ²Hunter Holmes McGuire Veterans Administration Medical Center, ³Oncolink

Background: Prevention and early intervention can improve survival and quality of life across cancers. Patient understanding of risk factors, and associated actionable lifestyle changes and screening programs, is not well understood by clinicians.

Objectives: We sought to understand individuals' non-modifiable and modifiable risk factors for the development of cancer.

Methods: An Internet-based tool, Reduce My Risk, was created in 2009 and made available on oncolink.org after beta testing and review by a multidisciplinary advisory board. Users voluntarily completed a survey

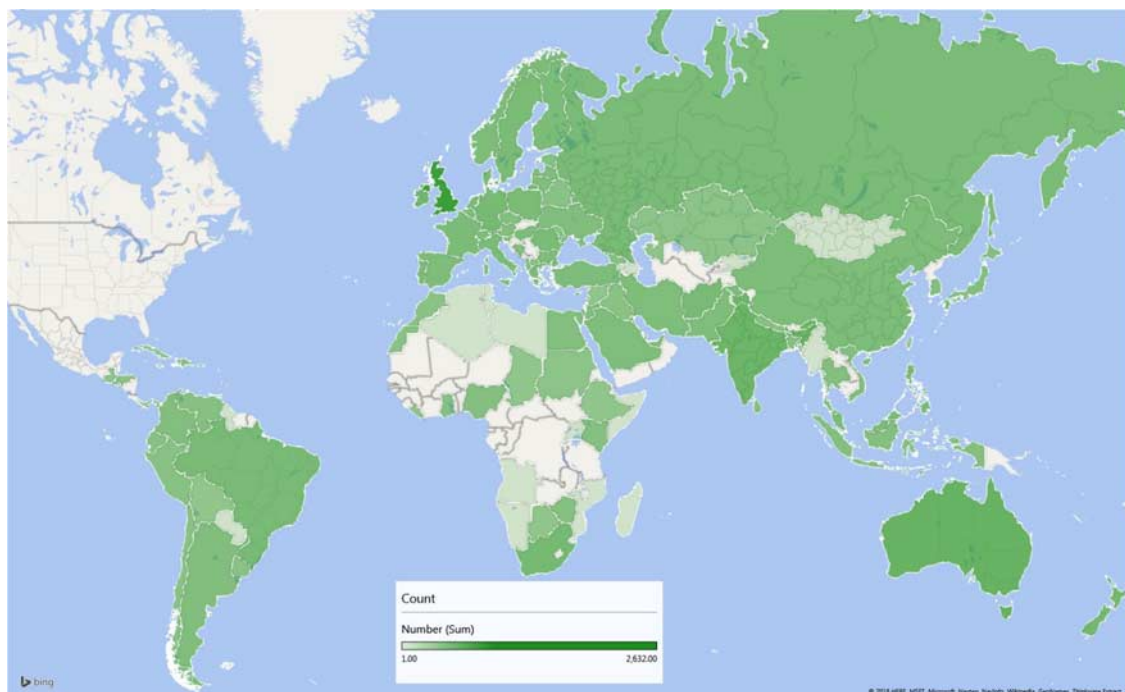

FIGURE 1. Geographic location of respondents outside of North America (“Where have you spent the majority of your life?”).

TABLE 1. Survey Questions

Age	
What is your gender?	
Have you ever been diagnosed with cancer? (except nonmelanoma skin cancer)	
Where have you spent the majority of your life?	
What is your race/ethnicity?	
What is the highest educational level you obtained?	
What is the median annual adjusted gross income of your household?	
How many people live in your household?	
In which of the following settings do you live?	
Do you currently smoke cigarettes?	
On average, how much do you smoke?	
For how many years have you smoked cigarettes?	
Did you ever smoke cigarettes?	
On average, how much did you smoke?	
For how many years did you smoke?	
How long ago did you quit?	
Do you now or did you ever do any of the following?	
smoke cigars or tobacco in a pipe	use areca nut or betel leaf
smoke marijuana	exotic smoking
use oral snuff/chew/quid	
How much cigar/pipe smoking do you do?	
How much marijuana smoking do you do?	
Are you exposed, on a regular basis, to significant amounts of secondhand smoke (from another individual smoking cigarettes, a pipe or a cigar) at work, at home or in a regular social setting?	
Do you drink alcohol?	
How many drinks do you typically have, on average, in one week?	
What is your height?	
What is your weight? (BMI is calculated)	
How would you describe your diet?	
How often do you engage in moderate to vigorous physical activity, above usual activities?	
When you engage in moderate to vigorous physical activity, how long is your average exercise routine on any given day?	
Which of the following describe you?	
"I am a sun worshipper and love to sunbathe"	"My skin shows the signs of sun damage (lots of freckles, sun spots, etc.)"
"I had blistering sunburns as a child or teenager"	"Very fair (red/blond hair, fair skin)?"
"I have more than 50 moles/birthmarks on my skin"	
Have you ever used or do you currently use tanning salons/booths?	
At what age did you first have sexual intercourse?	
How many sexual partners have you had in your lifetime?	
Do you or did you engage in receptive anal intercourse?	
Do you or did you engage in oral sex?	

regarding demographics and cancer risk factors (Table 1), and received information about their cancer risk. Research related to these data has been IRB-approved.

Results: 28,001 surveys were completed from 2009-2019. Median age among respondents was 26y (18-101); 60% were female, 87% lived in

North America (Fig. 1), 76% were White/Non-Hispanic, 37% had at least a bachelor's degree, and 22% had household income > \$100,000/y. Household size was 3 or less among 54% of respondents. Most lived in a city/suburb (81%). Users reported on behavioral/modifiable risk factors: 13% were current smokers, 23% previous smokers, 10% used

TABLE 2. Reported Family History of Cancer by Primary Cancer Type

	Anal cancer	Biliary Tract Cancer (Cholangiocarcinoma)	Bladder cancer	Breast cancer	Cervical cancer	Colorectal cancer	Endometrial (Uterine) Cancer
Yes	279	86	856	6849	1053	2794	395
	1.00%	0.31%	3.06%	24.46%	3.76%	9.98%	1.41%
No	27722	27915	27145	21152	26948	25207	27606
	99.00%	99.69%	96.94%	75.54%	96.24%	90.02%	98.59%
	Esophageal cancer	Gastric cancer	Head & Neck Cancer	Hodgkin's Lymphoma	Leukemia	Liver cancer (HCC)	Lung cancer (NSCLC and SCLC)
Yes	862	1005	645	438	1573	1290	5326
	3.08%	3.59%	2.30%	1.56%	5.62%	4.61%	19.02%
No	27139	26996	27356	27563	26428	26711	22675
	96.92%	96.41%	97.70%	98.44%	94.38%	95.39%	80.98%
	Melanoma	Mesothelioma	Multiple Myeloma	Non-Hodgkin Lymphoma	Non-melanoma skin cancer	Ovarian cancer	Pancreatic cancer
Yes	2072	146	326	699	819	1453	1653
	7.40%	0.52%	1.16%	2.50%	2.92%	5.19%	5.55%
No	25929	27855	27675	27302	27182	26548	26448
	92.60%	99.48%	98.84%	97.50%	97.08%	94.81%	94.45%
	Prostate cancer	Renal cell carcinoma	Sarcoma	Testicular cancer	Thyroid Cancer (all varieties)	Vulvar/vaginal cancer	Brain Cancer
Yes	2627	403	348	361	682	130	1601
	9.38%	1.44%	1.24%	1.29%	2.44%	0.46%	5.72%
No	25374	27598	27653	27640	27319	27871	26400
	90.62%	98.56%	98.76%	98.71%	97.56%	99.54%	94.28%

cigars or pipe tobacco, 6% used oral snuff/chew/quid, and 29% reported secondhand smoke exposure. Other substance use included marijuana (22% former users, 10% current users), alcohol (52% current users, 8% of those ≥ 14 drinks/week), and areca nut, betel leaf, or exotic smoking (1%). Body mass index (BMI) was ≥ 30 in 19%; 74% of all surveys reported dietary risks and 36% reported infrequent exercise. Intercourse <18y and >10 sexual partners were reported by 43% and 10%, respectively. Excess UV exposure was reported by 19%, and exposure to known carcinogens 14%. Sixty-two percent of respondents reported having received the hepatitis B virus vaccine, 49% of women and 23%

of men between 18-25y received the human papilloma virus (HPV) vaccine. Among women surveyed, 36% reported performing breast self-examinations monthly, and 50% reported receiving a breast examination by a clinician at least once every 3y. Sixty seven percent of men between 55-75y reported undergoing screening prostate specific antigen testing, and 50% of men in this age group annual digital rectal examinations. Nonmodifiable risk factors included family cancer history (64%, Table 2) or genetic syndrome (3%), and cancer-predisposing health condition (26%); 31% of women began menstruating <12y and 33% gave birth to a first child >30y.

Conclusions: This free, publicly accessible cancer risk assessment tool has a large user population. Users have higher educational status and smaller household than the general population. Not only did 97% of users report behavioral risk factors, but 60% of all individuals reported at least 4 modifiable risk factors. By understanding detailed characteristics of a large number of respondents, in-depth analysis of these data has the potential to improve educational interventions to reduce cancer risk through behavioral modification and cancer screening across the general public.

(P105) Trends in Diagnosis and Treatment of Metastatic Cancer in the United States

Eric Lehrer, MD, MS¹, Kelsey Stoltzfus, MPH², Brianna Jones, MD¹, Niraj Gusani, MD, MS², Vonn Walter, PhD³, Ming Wang, PhD², Daniel Trifiletti, MD⁴, Shankar Siva, MBBS, PhD⁵, Alexander Louie, MD, MSc, PhD⁶, Nicholas Zaorsky, MD, MS³; ¹Icahn School of Medicine at Mount Sinai, ²Penn State College of Medicine, ³Penn State Cancer Institute, ⁴Department of Radiation Oncology, Mayo Clinic, Jacksonville, FL, USA, ⁵Peter MacCallum Cancer Centre, ⁶Odette Cancer Centre - Sunnybrook Health Sciences Centre

Background: Metastatic cancer has historically been considered fatal; however, there is a paucity of evidence characterizing the epidemiology of incidence, treatment, and outcomes.

Objectives: We aim to: (I) characterize the epidemiology of metastatic cancer over time; (II) characterize treatment trends for metastatic

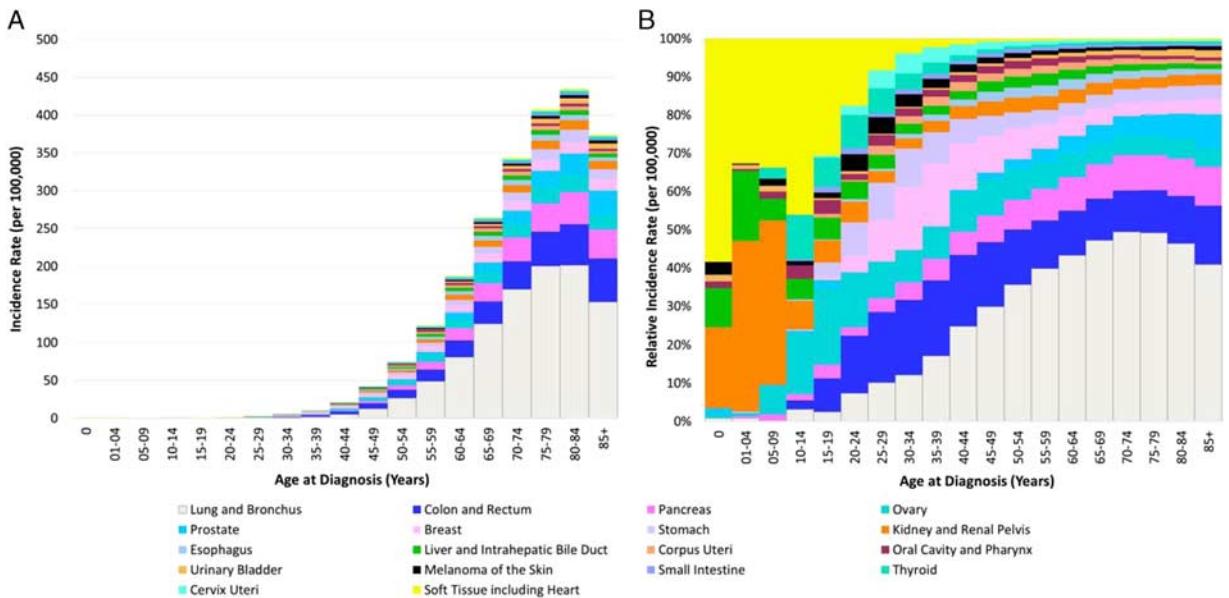

FIGURE 1. Age-adjusted incidence rates per 100,000 by primary cancer site and age at diagnosis. A) The y-axis depicts the age-adjusted incidence rate of metastatic cancer per 100,000, and the x-axis depicts the age group at diagnosis in years. Age groups are divided into 5 year increments. The colors depict the primary cancer site. (B) The y-axis depicts the relative incidence rate of metastatic cancer per 100,000 compared with other metastatic cancer patients, and the x-axis depicts the age group at diagnosis in years. For patients under age 25 soft tissue cancers, kidney, and liver cancers make up the plurality of cases. For patients ages 25 to 50, lung, colorectal, breast, and ovarian cancers have the highest incidence rates. For patients over age 50, the plurality of cases are seen in lung, colorectal, pancreatic, breast, and prostate cancers.

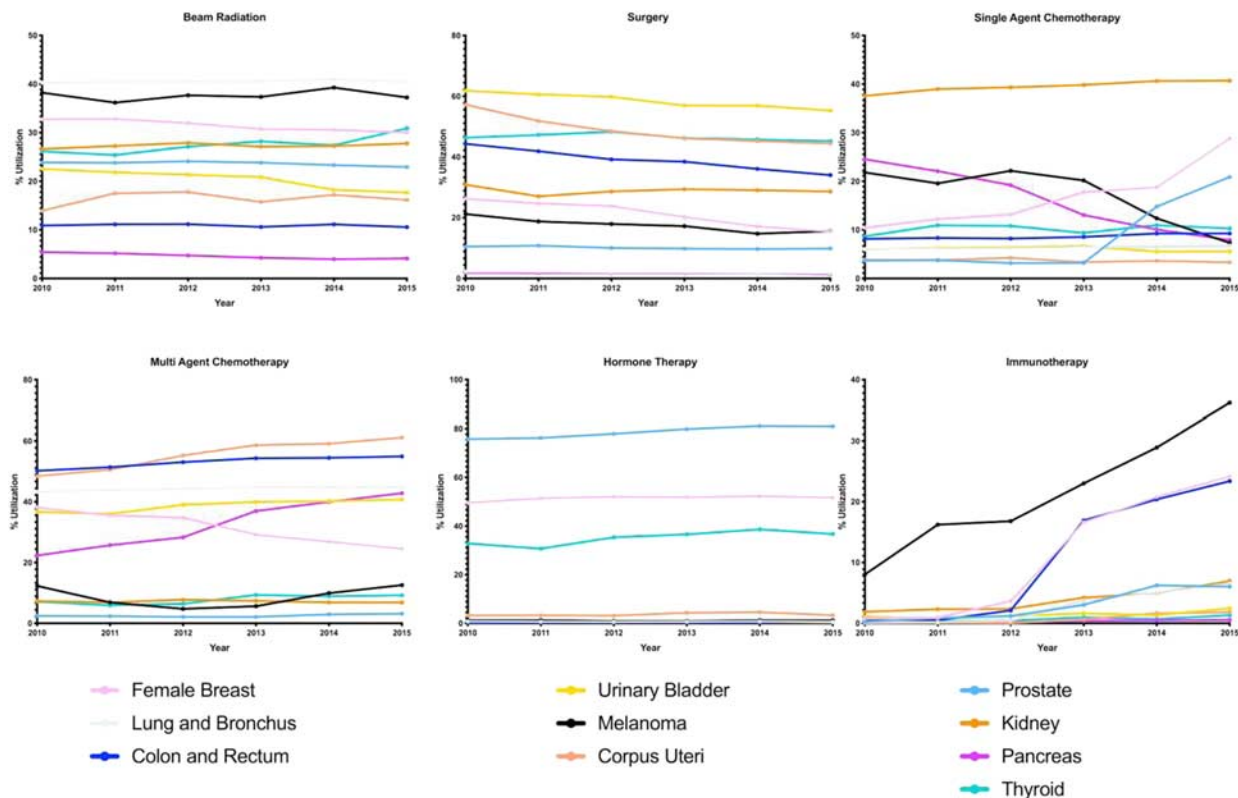

FIGURE 2. Trends in the utilization of various treatment options in metastatic cancer patients. (Top row) The y-axis depicts the percent utilization of the particular treatment (beam radiation, surgery, single-agent chemotherapy). The x-axis depicts the year, from 2004 to 2015. The colors depict the primary cancer site. (Bottom row) The y-axis depicts the percent utilization of the particular treatment (multi-agent chemotherapy, hormone therapy, immunotherapy). The x-axis depicts the year, from 2010 to 2015. The colors depict the primary cancer site.

disease; (III) evaluate if survival has improved for metastatic cancer patients over time.

Methods: The Surveillance, Epidemiology, and End Results (SEER) and the National Cancer Database (NCDB), 1998-2015 to determine incidence rates, annual percent change (APC), descriptive epidemiological statistics, and odds ratios for survival.

Results: There were a total of 1,055,860 patients with metastatic cancer. The most frequent primary cancers were lung (42.6%), colorectal (9.5%), and ovarian (5.5%). Metastatic lung and colorectal cancer incidence decreased, APC: -1.57 ($P < 0.001$) and APC: -1.48 ($P < 0.001$), respectively; metastatic pancreatic cancer incidence increased, APC: 0.62 ($P = 0.001$). The use of local therapies decreased for almost all sites, and the use of systemic therapies increased across multiple sites: single-agent chemotherapy in kidney cancer (2.54% increase/year), female breast cancer (1.14% increase/year) and prostate (1.08% increase/year); multi-agent chemotherapy, most notably in pancreas (2.23% increase/year), uterus (1.81% increase/year), and colorectal cancer (1.54% increase/year). Increased utilization of immunotherapy was observed across the majority of sites, most notably in melanoma (2.14% increase/year). Patients diagnosed from 2006-2010 had 17.4% higher odds of surviving at least 60 months compared with 1998-2002.

Conclusions: Metastatic disease has been shown to have unique epidemiological patterns, and survival has improved. Continued research on metastatic disease is important in understanding and addressing the distinct health concerns of this population (Figs. 1 and 2).

(P106) Characterizing Geographic Isolation from RT Facilities

Sean Maroongroge, MD, MBA¹, David Wallington, MD², Paige Taylor, MS¹, David Followill, PhD¹, Diana Zhu, BA², Beverly Guadagnolo, MD, MPH¹, Benjamin Smith, MD¹, James Yu, MD, MHS³,

Leslie Ballas, MD⁴; ¹University of Texas MD Anderson Cancer Center, ²Yale University, ³Yale School of Medicine, ⁴University of Southern California Keck School of Medicine

Background: Across multiple contexts, travel distance has been shown to impact the timing and type of care cancer patients receive. (Ambroggi M, et al Oncologist 2015) Radiation therapy (RT) is no different, and in fact, may be more prone to the effect of travel distance given the daily treatments required. However, the current distribution of RT facilities in the US is not well established. A comprehensive inventory of US RT facilities was last assessed in 2005, based on data from state regulatory agencies and international dosimetric quality assurance bodies. (Ballas L, et al IJROBP 2006) We updated this database to characterize population-level measures of geographic access to RT in the US and analyze changes over the past 15 years. We also sought to identify characteristics of counties that were furthest from existing RT facilities to better understand challenges faced by patients who are geographically isolated from RT resources.

Objectives: Our objectives include refining our “gold standard” database of RT facilities in the US, mapping the data to allow for the visualization of spatial and temporal trends in access over time, and identifying characteristics of counties that face the greatest geographic barriers to receiving RT.

Methods: We compiled data from state regulatory agencies and independent quality assurance bodies to identify US facilities that delivered RT for human medical treatment in 2018-2020. Addresses were geocoded, mapped, and analyzed with Geographic Information Services (GIS) software. Geographic isolation was defined as a Euclidean distance of greater than 50 miles between a county centroid and the nearest RT facility. We assessed changes in multiple measures of geographic access over time. Univariate and multivariate logistic regression analyses (with a forward selection process) were performed at the county level to identify features associated with geographic isolation.

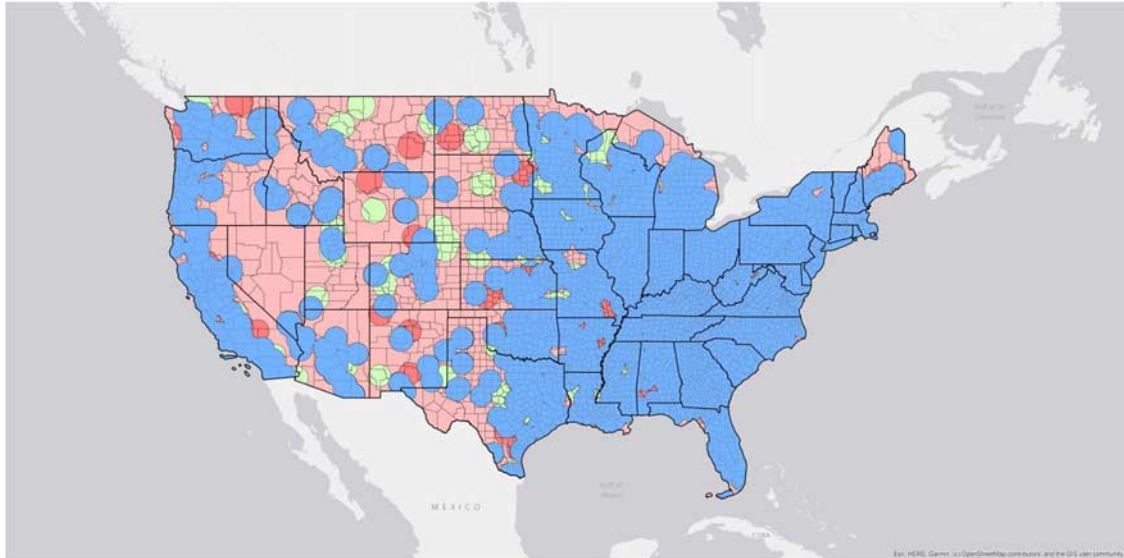

FIGURE 1. Service area map of RT facilities in the US. Salmon-colored regions represent areas more than 50 miles from the nearest RT facility. Green circles represent areas with new coverage in the latest dataset (2020). Deep red circles represent areas that have lost coverage since 2005. Blue shaded regions represent areas that have maintained coverage through both periods.

Results: In 2020, a total of 2,313 US RT facilities were reported compared with 1,986 in 2005, representing a 16.5% growth in facilities over nearly 15 years. 513 of 3,143 (16.9%) of counties met our definition for geographic isolation in the 2020 dataset compared with 589 of 3,143 (18.7%) in 2005. 233 counties are located more than 75 miles from the nearest RT facility, which is notably the upper limit of distance for which the Department of Health and Human Services allows for local transportation reimbursement in its latest guidance regarding the local transportation safe harbor (85 FR 77684). We also found that increased distance to RT was significantly associated with county measures of rural status, less insurance coverage, older median age, and lower rates of cancer death.

Conclusions: Based on a 50-mile threshold, we found that one-sixth of counties in the US can be considered geographically isolated from RT facilities. Further consideration should be given to policies and technologies that would support the rural patients most vulnerable to the financial toxicity of cancer care to address the health disparities they face (Fig. 1).

(P107) Impact of the Early COVID-19 Pandemic on Sex Participation in Academic Publishing in Radiation Oncology

Robert Miller, MD¹, Nancy Anabaraonye², Jillian Tsai, MD, PhD³, Hina Saeed, MD⁴, Fumiko Chino, MD⁵, Oscar Garcia, MPH⁶, Ekaete Ekpo, BA⁷, Sudeep Ahuja, BA⁸, Christine Lauro, MD⁹; ¹University of Tennessee Medical Center Knoxville, ²University of Pennsylvania, ³Memorial Sloan Kettering, ⁴University of Wisconsin, ⁵Memorial Sloan Kettering Cancer Center, ⁶University of Southern California, ⁷Johns Hopkins, ⁸University of Maryland Baltimore County, ⁹University of Tennessee Knoxville

Background: There is a known sex gap in oncology publishing with worse disparities within specialty fields such as radiation oncology. There has been a dramatic increase in the number of manuscripts submitted to academic journals during the pandemic. Several analyses have suggested that the pandemic has had a disproportionate impact on academic productivity of women in academia, as measured by manuscript publication rates.

Objectives: To determine if female authors published fewer manuscripts proportionally in the early months of the COVID-19 pandemic in ASTRO Advances in Radiation Oncology.

Methods: A comparison of the sex of first/co-first and corresponding/co-corresponding authors, as well as early career versus mid/late career status and manuscript type, for all papers published by Advances from its inception in December 2015 to the end of February 2020 was made to those published after the spread of COVID-19 to North America from March to the end of May 2020.

Results: This examination of papers published during COVID-19 did not indicate a statistically significant decrease in the overall proportion of women publishing in Advances. For early career female authors, this proportion fell just short of statistical significance (39% vs. 19%, $P=0.051$). When only scientific manuscripts were considered, there was a statistically significant decrease in publications by early career female first authors during the early months of the pandemic (37% vs. 11%, $P=0.02$).

Conclusions: In the early months of the pandemic, early career female investigators published fewer manuscripts proportionally compared with historical rates. Although the results of this study were inconclusive, they do shed light on the broader problem of sex inequality in academia and raise questions regarding methods to remediate this issue. A sex gap in academic publishing exists. It has been speculated that family and parental obligations may affect the trajectory of careers differently between women and men.

(P108) How Do Radiation Oncology Program Directors Increase Diversity in Residency Training Programs?

Arif Musa, MS¹, James Nimia, MS², Julianne Flowers, BS¹, Maysoun Al-Hihi, MD³, Richard Jennelle, MD⁴, Eric Chang, MD⁴, Omar Ragab, MD⁴; ¹Wayne State University School of Medicine, ²Wayne State University, ³Detroit Medical Center, ⁴University of Southern California Keck School of Medicine

Background: Radiation oncology remains one of the least diverse specialties in medicine. Despite attempts to increase the number of females and under-represented minorities (URM), females make up only 33.3% of residents and under-represented minorities (URMs) only 6.9% (1). Recently, an overall decline in the number of applicants coincided with a decline in Black applicants to radiation oncology residency (2). As a result, there has been a call to action to increase diversity in radiation oncology residency programs by optimizing the resident selection process (3).

Objectives: This cross-sectional study of residency training program directors was performed to identify which strategies were most

preferred to increase the number of female and URM radiation oncology residents.

Methods: An anonymous, electronic survey was submitted to a list of residency training program directors in the specialty of radiation oncology. The survey included questions about program characteristics, demographic and representation data, and strategies to potentially increase diversity. The level of agreement or disagreement for each strategy was quantified based on a 5-point scale (1 = disagree, 2 = somewhat disagree, 3 = neutral, 4 = somewhat agree, 5 = agree). A weighted average (WA) was calculated for each strategy. Data were collected from March to May 2021. A lottery incentive was included.

Results: Responses were received from 15.4% of 91 residency program directors from university and hybrid programs located in urban and suburban regions of the United States. Program directors most supported increasing the number of female and URM faculty, recruiting female and URM medical students directly, and promoting mentorship among female and URM applicants (WA = 4.9) to increase diversity followed by establishing a “safe space” to discuss workplace issues (WA = 4.8). Other highly supported strategies included holistic application review, pipeline program establishment, and concrete measures to track success of such initiatives (WA = 4.7). Supporting “Women in Radiation Oncology” and similar groups was also believed to increase diversity according to program directors (WA = 4.6). Respondents also expressed somewhat less agreement towards establishing a mission statement related to increasing diversity, unconscious bias training, and forming a subcommittee dedicated to increasing diversity (WA = 4.4). Similar levels of agreement were expressed for establishing an office of diversity, conducting research regarding diversity, cultural competence training, and “Second Look Days” for applicants (WA = 4.3). In addition, program directors somewhat agreed that a webpage dedicated to diversity (WA = 4.2), increasing funding for diversity initiatives (WA = 4.2), and advertising the specialty at diverse medical schools (WA = 4.0) could increase representation. By comparison, program directors expressed less support for deemphasizing exam scores (WA = 3.9), Grand Rounds presentations related to diversity (WA = 3.7), accepting a minimum number of female, URM or international applicants (WA = 3.4), and de-identifying applications (WA = 3.1).

Conclusions: Radiation oncology residency training program directors that responded to our survey expressed varying levels of support for several strategies to increase diversity. Principally endorsed strategies included increasing the number of female and URM faculty, promoting mentorship of female and URM residents, and direct recruitment of interested female and URM applicants. Several diversity-related initiatives such as a dedicated website, mission statement, and resident selection committee were also endorsed to a lesser degree. However, deemphasizing exam scores, accepting a minimum number of applicants, and de-identifying applications garnered less support. These strategies may be useful to residency program directors and selection committees seeking to increase representation. Future research is needed to determine which strategy or combination of strategies is significantly associated with increasing the percentage of female and URM residents in radiation oncology training programs.

(P109) Impact of the Radiation Oncology Alternative Payment Model (RO-APM) on Reimbursement for MRI-Guided Radiotherapy and Adaptive Replanning

Russell Palm, MD¹, Kurt Eicher², Austin Sim, MD, JD³, Susan Pene-guy¹, Stephen Rosenberg, MD MS¹, Stuart Wasserman¹, Peter Johnstone, MD, FACR, FASTRO¹; ¹Moffitt Cancer Center, ²Guidehouse Consulting, ³Department of Radiation Oncology, H. Lee Moffitt Cancer Center & Research Institute

Background: The pending implementation of Radiation Oncology Alternative Payment Model (RO-APM) has raised concerns regarding the adoption and development of new technology in radiation oncology. A novel technique that will be impacted by a deviation from a fee-for-service (FFS) model is MRI-guided adaptive radiotherapy (MRgART) which is intensive of both physician and medical physicist time.

Objectives: We sought to model a typical patient load and distribution for an MRI-Linac (MRL) and compare current reimbursement under FFS (Model A) to the proposed RO-APM Final Rule as published on

9/29/2020 (Model B). We then derived a new modifier that could be used in the RO-APM to account for the additional resources necessary to provide this type of adaptive therapy (Model C).

Methods: A sample MRL patient load and distribution consisted of an annual throughput of 200 patients with 5 primary cancer diagnoses: breast (31%), lung (13%), colorectal (15%), pancreas/hepatobiliary (28%), and prostate (13%). Online adaptive treatment planning was utilized in both lung and pancreatic cancer, and MRI guidance without adaptive planning was used for breast, colorectal, and prostate cancer. All treatment regimens except colorectal cancer were hypofractionated. We utilized nationwide average TruVian FFS Medicare reimbursement for current procedural terminology (CPT) codes associated with the technical fees for treatment planning and delivery (Model A) compared with payment for the technical component of treatment associated with the diagnosis in RO-APM (Model B). Within the framework of the RO-APM, we added a modifier to account for the proportion of treatments that were adapted across the total treatment course (Model C); this retained standard reimbursement for MR guided treatments that did not require adaptation.

Results: Reimbursement for all selected diagnoses were lower in Model B compared with Model A, with the largest differences in the adaptive treatments for lung cancer (−89%) and pancreatic cancer (−83%) and more moderate differences for nonadaptive treatments (breast: −75%; colorectal: −65%; prostate: −51%). A total annual reimbursement discrepancy in Model B would amount to −79%. Without implementation of adaptive replanning there was no difference in reimbursement in breast, colorectal and prostate cancer between Model B and Model C. Accommodating online adaptive treatments in Model C would result in a difference from the FFS (Model A) of −55% for lung cancer and −53% for pancreatic cancer with an overall difference of −59%.

Conclusions: Without adjustment, the viability of MRgART as a new treatment strategy is threatened under the RO-APM. Modifications that allow for the proportion of adaptive fractions to be billed would allow the evidence supporting this technique to grow while still allowing for significant cost-savings by encouraging high-value care.

(P110) To Biopsy or Not to Biopsy: Harnessing the NCDB to Examine Overall Survival Differences as a Function of Staging Method in Early-Stage Non-Small Cell Lung Cancer Treated with SBRT

James Cantrell¹, Pawan Acharya², Sara Vesely², Tyler Gunter¹; ¹Department of Radiation Oncology/Stephenson Cancer Center/OUHSC, ²Department of Biostatistics and Epidemiology/OUHSC

Background: The use of stereotactic body radiation therapy (SBRT) for early-stage non-small cell carcinoma of the lung (ES-NSCLC) has been increasing, and many patients are being treated with SBRT without complete mediastinal staging, contrary to NCCN Guideline recommendations (NCCN 2021). There is a possibility that forgoing invasive staging in these patients increases the risk of nodal recurrence, thereby decreasing survival.

Objectives: This study aims to identify overall survival (OS) differences for ES-NSCLC depending on staging method, using the National Cancer Database’s (NCDB) data set. Further, we intend to identify any patient, tumor, or treatment characteristics associated with survival.

Methods: Using the NCDB, a retrospective observational cohort study was performed investigating survival outcomes and prognostic indicators for ES-NSCLC patients receiving SBRT. Only those patients with ES-NSCLC treated with SBRT (defined as 1-5 fractions with allowable dose of 3000-7000cGy) within 1 year of diagnosis were included. Patients receiving any surgical or systemic therapy were excluded. Kaplan Meier method, log-rank test, and Cox proportional hazards regression were performed to determine characteristics associated with OS.

Results: A total of 12,413 patients from 2010 to 2015 met inclusion criteria for analysis with 876 (7.1%) receiving nodal sampling (NS) and 11537 (92.9%) receiving no nodal sampling (NNS) as part of their staging work-up. Median survival (MS) for all ES-NSCLC patients receiving SBRT was 35.8 months (95% CI 35.1-36.8 mo), with 2-year and 5-year OS estimates of 66.2% and 28.6%. There was no difference in OS between the NS and the NNS group on univariate or multivariate

TABLE 1. Univariate and Multivariate Analysis

Characteristic	Univariate analysis				Adjusted analysis			
	HR	Lower CI	Upper CI	p-value	HR	Lower CI	Upper CI	p-value
Age								
<65 years	reference							
65-74 years	1.14	1.05	1.23	0.0014	1.07	0.98	1.15	0.1243
≥75 years	1.29	1.20	1.39	<0.0001	1.21	1.12	1.30	<0.0001
SEX								
Female	reference							
Male	1.31	1.25	1.38	<0.0001	1.25	1.19	1.32	<0.0001
Race								
White	reference							
Black	0.83	0.76	0.91	<0.0001	0.87	0.79	0.95	0.002
Others/unknown	0.82	0.70	0.97	0.0185	0.82	0.69	0.96	0.0162
Charlson-Deyo Score								
0	reference							
1	1.11	1.04	1.17	0.0007	1.12	1.06	1.19	0.0001
2	1.26	1.17	1.35	<0.0001	1.26	1.17	1.35	<0.0001
≥3	1.56	1.42	1.72	<0.0001	1.54	1.40	1.70	<0.0001
Histology								
Non-small cell carcinomas, NOS	reference							
Adenocarcinomas	0.81	0.75	0.87	<0.0001	0.81	0.75	0.87	<0.0001
Adenosquamous carcinomas	1.16	0.91	1.49	0.2381	1.09	0.83	1.40	0.5195
Squamous cell carcinomas	1.12	1.04	1.21	0.0019	1.04	0.97	1.12	0.0038
Tumor size								
<1 cm	reference							
1-2 cm	1.18	1.02	1.36	0.022	1.17	1.02	1.33	0.0308
2-3 cm	1.45	1.26	1.67	<0.0001	1.41	1.23	1.63	<0.0001
3-4 cm	1.69	1.46	1.96	<0.0001	1.62	1.39	1.88	<0.0001
4-5 cm	2.06	1.75	2.44	<0.0001	1.94	1.64	2.29	<0.0001
>5 cm	2.52	2.05	3.08	<0.0001	2.34	1.90	2.87	<0.0001
Unknown, size not stated	1.47	1.17	1.84	0.0009	1.40	1.11	1.76	0.0046
Nodal examination								
Nodal Sampling (NS)	reference							
No Nodal Sampling (NNS)	0.93	0.84	1.02	0.1272	0.99	0.90	1.09	0.8298
BED								
BED 100-140	reference							
BED >140	0.92	0.87	0.97	0.0035	0.97	0.91	1.03	0.2906
BED <100	1.33	1.18	1.51	<0.0001	1.27	1.12	1.44	0.0002
Diagnosis to radiation								
Months	0.97	0.95	0.99	0.0017	0.97	0.96	0.99	0.0073

analysis (MVA) (HR 0.99 (95% CI 0.9-1.09), $P=0.83$) (Fig. 1, Table 1). Negative prognostic factors on MVA include age greater than 75, male sex, Charlson-Deyo Score of 1 or greater, increasing tumor size, and biological effective dose < 100 Gy. Positive prognostic factors on MVA include Black or other non-white race, adenocarcinoma histology, and shorter interval from diagnosis to SBRT. On MVA there was a 3% decrease in OS for every additional month from diagnosis to start of SBRT ($P=0.0075$).

Conclusions: The use of SBRT to treat ES-NSCLC continued to increase over the period of this study, with most patients proceeding to

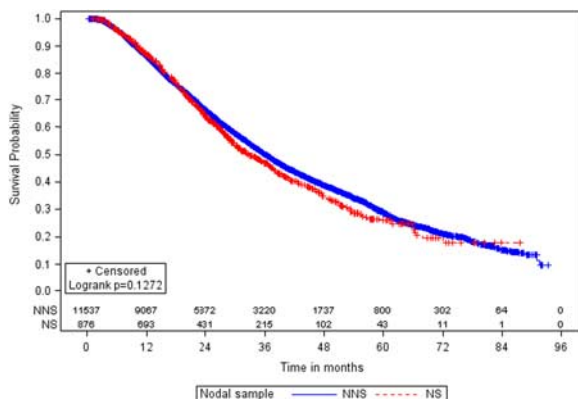

FIGURE 1. Overall survival comparison of NS and NNS groups.

SBRT without nodal staging. These findings suggest similar OS between patients with ES-NSCLC treated with SBRT who underwent mediastinal nodal staging versus those without nodal staging. Furthermore, this study highlights numerous patient, disease, and treatment related prognostic variables to consider when counseling and planning therapy for similar patients. Prospective randomized controlled trials are required to confirm the lack of survival difference between staging approaches, but these results support the NCCN Guidelines recommendation that certain tumors do not necessarily require invasive nodal staging.

(P111) Utilization of a Modified Frailty Index in Predicting Oncologic Outcomes and Toxicity for Patients with Early Stage Non-small Cell Lung Cancer Treated with Hypofractionated Radiotherapy

Justin Cohen, MD¹, Maria Sanchez, BS², Kai Sun, MS³, Melissa Vyfhuis, MD/PhD⁴, Akshar Patel, MD⁴, Sara Dudley, MD⁵, Pranshu Mohindra, MD, MBBS⁶; ¹University of Maryland Medical Center Department of Radiation Oncology, ²University of Maryland School of Medicine, ³University of Maryland School of Medicine Department of Epidemiology and Public Health, ⁴Baltimore Washington Medical Center Department of Radiation Oncology, ⁵Central Maryland Radiation Oncology, ⁶Department of Radiation Oncology, University of Maryland School of Medicine

Background: Moderately hypofractionated regimens have emerged as an alternative to stereotactic body radiotherapy for patients (pts) with central/ultra-central non-small cell lung cancer (NSCLC) who are medically inoperable due to age, poor performance status (PS) or comorbidity and who may be at a higher risk of severe toxicity.

Objectives: Utilize a modified frailty index (mFI) to identify frail pts and demonstrate that frailty could better stratify clinical outcomes in these pts.

Methods: We retrospectively analyzed 41 consecutive previously unirradiated pts with stage I-IIIB or recurrent NSCLC treated with definitive hypofractionated (8-15 fractions) radiation therapy (RT) in our multi-site practice. An 11 factor mFI score was calculated based on the following variables: ECOG score ≥ 2, impaired sensorium, diabetes, chronic lung disease, myocardial infarction within 6 months, hospitalization within 6 months for heart failure, coronary/cardiac disease, HTN on medication, history of transient ischemic attack, stroke with deficits, and peripheral vascular disease. Kaplan-Meier (KM) method was used to estimate 1-year overall-survival (OS), local control (LC), freedom from progression (FFP) and logistic regression for severe toxicity (≥ grade 3) with patients stratified by mFI score (0-3 vs ≥ 4), median age (< 78 vs ≥ 78) and ECOG PS (0-1 vs ≥ 2).

Results: Most pts were elderly (median 78 y; range 58-94), White (78%), with squamous cell carcinoma (43.9%). Twenty pts (48.8%) had Stage I disease, 12 (29.2%) had Stage II, and 9 (30%) had recurrent disease. Pts were treated with 8-15 fractions (fx) with a dose range of 50-70 Gy; 70 Gy in 10 fx was most common. At a median follow-up of 17 months, KM estimated 1-year OS for the whole cohort was 87%. When stratified by mFI score (0-3 vs ≥ 4), there was no significant difference in 1-year LC (84.3% vs 100%), FFP (76.5% vs 76.5%), or OS (86.5% vs 92.3%). When stratified by median age (< 78 vs ≥ 78), there was no significant difference in 1-year LC (82.1% vs 92.9%), FFP (67.3% vs 84.8%), or OS (94.4% vs 80.7%). When stratified by ECOG PS (0-1 vs ≥ 2), there was no significant difference in 1-year LC (89.3% vs 93.8%), FFP (80.7% vs 71.4%), or OS (86.5% vs 87.2%). There were 4 instances of severe grade 3 toxicity (all cardiopulmonary), all in the frailer group (mFI score ≥ 4) which was significant on multivariate analysis ($P=0.0136$). Stratification by median age and PS was not significant.

Conclusions: We found a strong association between higher frailty score and toxicity outcomes in patients with early-stage NSCLC treated with hypofractionated RT, a difference that was not predicted by age or PS. Despite the toxicity risk, hypofractionated RT allowed even frail patients to achieve comparable tumor control and survival when compared with non-frail patients. Future analyses in larger datasets could explore the balance between the two competing end-points of toxicity versus tumor control/survival in frail patients.

(P112) Examining Outcomes and Toxicity When Using Hypofractionated Radiotherapy to Early-Stage Tumors for Patients with Non-Small Cell Lung Cancer

Abigail Copella, MD¹, Karthik Devarajan, PhD¹, Sameera Kumar, MD¹; ¹Fox Chase Cancer Center

Background: Stereotactic Body Radiation Therapy (SBRT) is standard of care for medically-inoperable, peripheral, non-small cell lung cancer (NSCLC). While SBRT has been used in peripheral early-stage NSCLC, the use of SBRT in central lesions is controversial. The most high-risk central lesions are ultracentral, which come within 5mm or less of the primary or secondary bronchi. Hypofractionated radiation therapy (HFRT) for these tumors is a new paradigm that remains largely unexplored. A prospective study of 47 patients with ultracentral tumors looking at efficacy and safety of a 6000 cGy in 12 fractions regimen found 38% of patients experienced grade \geq acute/late toxicity, with 1 patient experiencing grade 4 and 7 patients experiencing grade 5 hemoptysis (Tekatli H, et al JTO 2016). A second prospective study demonstrated feasibility of accelerated radiation therapy for non-operable, early stage, NSCLC by using HFRT. This study delivered 6987cGy in 411cGy fractions, over 17 fractions, with toxicity comparable with conventionally fractionated radiation (Bogart J, et al JCO 2010).

Objectives: The aim of this study is to present local progression free survival (L-PFS), progression free survival (PFS), overall survival (OS) and toxicity data for a single institution experience using an HFRT regimen, 6987cGy in 17 fractions.

Methods: This is a retrospective review of patients with early stage (I or II) NSCLC treated at a single institution between 2011 and 2019. Kaplan-Meier curves, log-rank tests and Cox proportional hazards models were used to analyze L-PFS and PFS. Toxicity rates were evaluated for patients with ultra-central tumors based on presence of bronchial stricture/necrosis (BSN), hemoptysis and/or pneumonitis after treatment. IRB approval was obtained.

Results: A total of 35 patients with NSCLC were included in this study. Twenty patients had ultra-central tumors, 7 had central tumors and 8 had peripheral tumors. Median age of patients was 79 years. Forty-six percent of patients were female. Fifty-one percent had squamous histology while 49% had adenocarcinoma histology. One and 2 year L-PFS were 81.6% (95% CI 0.68-0.98) and 73% (95% CI 0.54-0.97) respectively. The PFS was 60% (95% CI 0.4-0.82) and 51% (95% CI 0.33-0.79) at 1 and 2 years respectively. The OS at 1, 2, and 3 years was 62% (95% CI 0.48-0.81), 38% (95% CI 0.24-0.61) and 26% (95% CI 0.13-0.49) respectively. In patients with ultra-central tumors, 4 patients (20%) experienced BSN and 2 patients (10%) experienced pneumonitis. Hemoptysis occurred in 1 patient (5%) with an ultracentral tumor in the setting of local recurrence.

Conclusions: This study demonstrates that the HFRT regimen 6987cGy in 17 fractions is both safe and feasible, and thus, is an attractive treatment option for central and ultra-central lung tumors. The toxicity profile is limited with early data demonstrating acceptable L-PFS and PFS.

(P113) Impact of Dosimetric Factors on Distant Failure in Early Stage Non-Small Cell Lung Cancer Patients Receiving Stereotactic Body Radiation Therapy

Shahed Badiyan, MD¹, James Cordova, MD, PhD², Randall Brennehan, MD PhD², Yi Huang, MS², Kylie Kang, MD², Gregory Vlacich, MD, PhD², Clifford Robinson, MD², Pamela Samson, MD, MPH², Matthew Spraker, MD, PhD², Aadel Chaudhuri, MD, PhD³; ¹Washington University School of Medicine, ²Department of Radiation Oncology, Washington University School of Medicine in St. Louis, ³Washington University School of Medicine in St. Louis

Background: Stereotactic body radiation therapy (SBRT) has local control (LC) rates of >90% for early stage non-small cell lung cancer (NSCLC) (Timmerman et al JAMA 2010). Despite excellent LC, distant failure (DF) is common with upwards of 31% of patients failing at 5 years (Timmerman et al IJROBP 2014). Identification of risk factors predictive of DF may help identify those who would benefit from adjuvant systemic therapy.

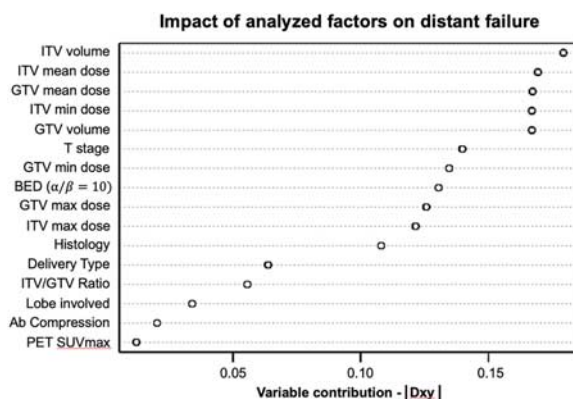

FIGURE 1. Impact of clinical and treatment factors on time to DF. ITV volume, ITV mean, ITV min, GTV mean, and GTV volume were the factors most strongly associated with DF. Levels of categorical variables: Histology (squamous cell carcinoma, adenocarcinoma, NSCC-NOS, and no biopsy / non-diagnostic biopsy); Delivery type (IMRT and 3D); T stage (T1, T2, and T3); Lobe involved (LUL, LLL, RUL, RML, and RLL); Abdominal compression (present or absent). Units: Dose (Gy), Volume (cc).

Objectives: To identify clinical and dosimetric risk factors for DF in a cohort receiving SBRT for early stage NSCLC to assist in risk stratification.

Methods: Using a prospectively maintained, IRB-approved registry, patients with early stage NSCLC were reviewed for failure. DF was defined as new distant tumor focus on CT with evidence of viability by biopsy or FDG PET. The following variables were recorded for each case: GTV and ITV volume, target min/mean/max dose, BED ($\alpha/\beta=10$), histology, clinical T stage, lobe, PET SUVmax, type of SBRT delivery, and \pm abdominal compression. ITV/GTV ratio was calculated as a surrogate for respiratory motion. The effect of each factor on DF was evaluated with the Hoeffding's D statistic, and correlation between factors was assessed with Pearson's correlation coefficient.

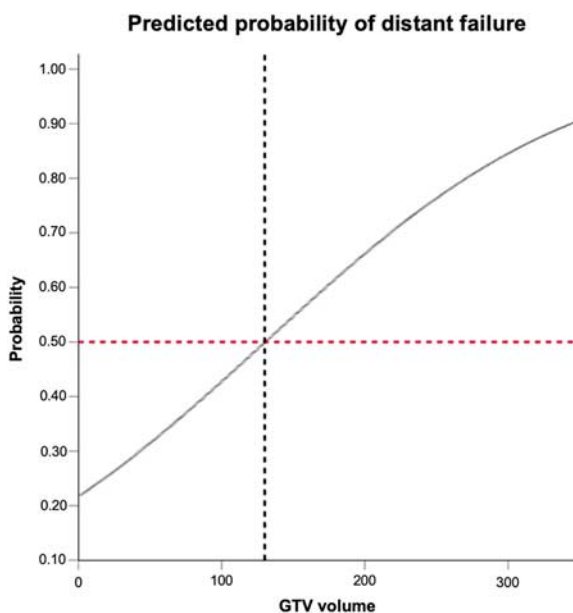

FIGURE 2. Probit regression curve for GTV volume versus DF. Estimated baseline probability of DF was 22% while 50% predicted probability of DF (horizontal red dashed line) was seen with GTV volume \geq 130 cc (vertical black dashed line). Units: Volume (cc).

Uncorrelated variables associated with DF were evaluated using univariate and multivariate Cox regression. Probit regression was used to build a continuous model predicting probability of DF. Significance was set at $\alpha < 0.05$ for all comparisons.

Results: Of those treated between October 2005 and March 2015, 305 patients with complete dosimetric data were identified for analysis. Median follow up time was 19.5 months (range, 0-168 mo), and DF was noted in 25.2% of cases. The cohort consisted of 95.5%, 0.7%, and 3.8% T1, T2, and T3 tumors, respectively. Histology included squamous cell carcinoma (36.1%), adenocarcinoma (38.7%), and NSCLC not otherwise specified (NSCC-NOS, 18.1%); 7.1% were treated empirically. ITV volume, ITV mean and min, GTV mean, and GTV volume were most strongly associated with DF (Fig. 1). ITV volume, ITV mean, and ITV min were highly correlated with GTV volume and GTV mean, and were omitted from regression analysis. On univariate analysis, GTV volume was significantly associated with DF (HR: 1.01, $P=0.01$). GTV volume remained significant on multivariate analysis (HR: 1.01, $P=0.01$) when controlling for GTV mean and ITV/GTV ratio in the model. Probit analysis estimated the baseline probability of DF to be 22% (range, 17-28%) with 50% probability of DF at GTV volume ≥ 130 cc ($P=0.02$, Fig. 2).

Conclusions: In this early stage NSCLC cohort, larger GTV volume was associated with a higher likelihood of DF following SBRT. Baseline probability of DF exceeded 20% while a GTV ≥ 130 cc (equivalent to a 6.3 cm spherical tumor) predicted a 50% probability of DF. Larger studies evaluating the predictive capacity of dosimetric quantities, including GTV volume, are warranted to validate models for risk stratification in early stage NSCLC.

(P114) A Novel STING Agonist in Combination with Radiotherapy to Treat Local and Systemic PD1-resistant Lung Adenocarcinoma

Hampartsoum Barsoumian, PhD¹, Livia Cox², Duygu Sezen, MD², Kewen He, MD², Ethan Hsu, BA², Yun Hu, PhD³, Nahum Puebla-Osorio, PhD², Maria Angelica Cortez, PhD², James Welsh, MD¹; ¹MD Anderson Cancer Center Welsh Lab, ²MD Anderson Cancer Center, ³Welsh Lab Radiation Oncology MD Anderson Cancer Center

Background: Immunotherapy has revolutionized the oncological landscape in recent years, proving to be an effective and minimally toxic cancer therapeutic in the treatment of solid tumors. However, resistance to immunotherapy remains a substantial challenge. In most tumor types, immunotherapy treatment maintains a 20-40% response rate, with one third of initial responders developing acquired resistance to the immunotherapy (1). The combination of immunotherapy with stereotactic body radiation therapy (SBRT) has become a powerful clinical strategy in the treatment of solid tumors, as well as an effective tool to combat immunotherapy resistance. This combination simultaneously regulates immune pathways, while promoting an abscopal response in which treatment to the primary tumor site exposes the immune system to antigens, propagating a vaccine-like response to non-irradiated metastatic sites (2). This study uses an innate agonist to stimulator of interferon genes protein (STING). When co-administered with checkpoint inhibitor(s) and SBRT, the STING agonist further activates antigen presenting cells and subsequently T-cells to promote abscopal antitumor responses (3, 4).

Objectives: This study uses a novel STING agonist in combination with radiotherapy (RT) to overcome α -PD1 resistance and enhance abscopal occurrence in murine models resembling non-small cell lung adenocarcinoma (NSCLC). By using this therapeutic combination, immunologically "cold" tumors convert to immunologically "hot" (5), therefore restricting the growth of both primary and secondary metastatic tumors.

Methods: Bilateral tumor models were established in 129Sv/Ev mice with either 344SQ-Parental (344SQ-P) or 344SQ α -PD1-Resistant (344SQ-R) lung adenocarcinoma cells (6). Primary and secondary tumors were implanted subcutaneously on right and left hind legs respectively. When primary tumors reached around 7mm in diameter, they were irradiated with a Cesium source with a dose of either 5 Gy x 3 fractions or 12 Gy x 3 fractions. Both primary and secondary tumors were measured twice per week using digital calipers and mice were euthanized when average tumor diameter reached 14mm. STING

agonist (BMS-986301) was injected into primary tumors 3, 9, and 19 days after the last fraction of RT for the parental model; and 2, 7, and 16 days post-RT for the resistant model. Systemic anti-PD1 (200 μ g/IP injection) was administered twice per week starting on day 5 post-primary tumor inoculation. At defined endpoints, lungs were also harvested, stained with Bouin's fixative, and enumerated for lung lesions. Log-Rank tests were used to compare survival curves, while two-way ANOVA was used to compare tumor growth curves.

Results: When coupled with RT, the STING agonist and α -PD1 combination significantly improved control of both the primary and secondary tumors in the 344SQ-P as well as 344SQ-R models. Moreover, comparing the efficacy of 5 Gy x 3 + STING to 12 Gy x 3 + STING, both groups were equally capable to delay the growth of primary and secondary tumors in the 344SQ-P model (5 Gy x 3 vs 5 Gy x 3 + STING, $P < 0.0001$; 12 Gy x 3 vs 12 Gy x 3 + STING, $P < 0.0001$). Therefore, we selected the 5 Gy x 3 dose to proceed with the next set of experiments in the resistant model and to reduce the chance of any potential toxicity. In 344SQ-R, the triple combination of RT + STING agonist + α -PD1 significantly prolonged survival time relative to all other groups (5 Gy x 3 median survival was 25 days vs 5 Gy x 3 + STING 36 days vs triple therapy 43 days; 5 Gy x 3 vs 5 Gy x 3 + STING $P=0.0210$; 5 Gy x 3 vs triple therapy $P=0.0039$). The triple therapy also achieved prominent abscopal responses in 344SQ-R as measured by secondary tumor growth curves (5 Gy x 3 vs triple therapy, $P < 0.0001$). In addition, although the dual treatment of RT and STING reduced lung metastases compared with control or RT only, the triple combination of RT + STING agonist + α -PD1 led to significantly lower lung metastasis counts compared with RT alone ($P=0.0235$) in the aggressively growing 344SQ-R model.

Conclusions: Based on these preclinical results, radiotherapy along with local STING agonist may be a potent therapeutic approach to treat NSCLC cases with anti-PD1 resistance, prolong survival, and maximize abscopal responses.

(P115) Care Patterns for Stereotactic Radiosurgery in Small Cell Lung Cancer Brain Metastases

Olsi Gjyshi, MD, PhD¹, Steven H. Lin, MD, PhD¹, Todd A. Pezzi, MD, MBA¹, Matthew Ning, MD, MPH¹, Junsheng Ma, PhD¹, Suyu Liu, PhD¹, Chad G. Rusthoven, MD²; ¹MD Anderson Cancer Center, ²University of Colorado School of Medicine

Background: The historical standard of care for brain metastases (BMs) from small cell lung cancer (SCLC) has been whole-brain radiotherapy (WBRT). However, there is growing interest in upfront stereotactic radiosurgery (SRS) for select SCLC patients.

Objectives: To determine the current practices and rate of SRS vs. WBRT use in patients with SCLC BMs.

Methods: We invited United State-based Radiation Oncologists (ROs) via email to answer an anonymous survey using a branching logic system addressing their use of SRS and WBRT for SCLC BMs. Wilcoxon rank-sum test and Fisher's exact test were used to compare differences in continuous and categorical variables, respectively. Multivariable logistic regression analyses were fitted for outcome variables including covariates with $P < 0.10$ obtained on univariable analysis.

Results: In total, 309 ROs completed the survey and 290 (93.7%) reported that they would consider SRS for SCLC BMs under certain clinical circumstances. Across patient characteristics, the number of BMs was the most heavily weighted factor (mean 4.3/5 in importance), followed by performance status, cognitive function, and response to prior therapy. Fewer BMs was correlated with increased SRS use (55.8% offered SRS 'very frequently' [$> 75\%$ of cases] or 'often' [51-75% of cases] for 1 BM vs. 1.1% for > 10 BM, $P < 0.001$). In situations where WBRT was preferred, concern for rapid intracranial progression (45.3%) and lack of high-level data (36.9%) were the most important factors. The majority (60.6%) were aware of a large recent international retrospective analysis (FIRE-SCLC) reporting similar OS between upfront SRS and WBRT; awareness of this study was the only respondent variable predictive of SRS use for limited BMs (19.2% of those aware of the study preferring SRS for limited [≤ 4] BMs before vs. 61% preferring SRS after the publication, $P < 0.001$). 88.2% expressed a willingness to enroll patients on a recently opened cooperative group phase III trial of SRS vs. hippocampal-avoidance WBRT.

Conclusions: In the first survey of SRS for SCLC BMs, we observed a high level of physician openness to upfront SRS in SCLC, particularly for patients with limited numbers of BMs, as well as significant interest in generating prospective randomized data to clarify the role of SRS in this population.

(P116) Cardiac Events Following Chemoradiotherapy for Locally Advanced Non-Small Cell Lung Carcinoma with Photon and Proton Beam Radiotherapy

Timothy Kegelman, MD, PhD¹, Nikhil Yegya-Raman, MD¹, Kristine Kim, MD¹, Steven Feigenberg, MD¹, Srinath Adusumalli, MD¹, Corey Langer, MD¹, Roger Cohen, MD¹, Rupal O'Quinn, MD¹, Bonnie Ky, MD¹, Michael Kallan, MS¹, Srinivas Denduluri, PhD¹, Keith Cengel, MD, PhD¹, Aditi Singh, MD¹, Charu Aggarwal, MD, MPH¹, Joshua Bauml, MD¹, William Levin, MD¹, Abigail Berman, MD, MSCE¹; ¹University of Pennsylvania

Background: Cardiac toxicity secondary to chemoradiotherapy (CRT) for locally advanced non-small cell lung cancer (LA-NSCLC) is of particular concern in a patient population with underlying cardiac risk factors. Heart radiation dose correlates with adverse cardiovascular events (CVEs) following CRT. A strategy to minimize this dose is to utilize Proton Beam RT (PBRT).

Objectives: We aimed to test if type of radiation received correlated with decreased risk of incurring a post-RT CVE, or with decreased grade of post-RT CVE in a single-center retrospective study.

Methods: Between December 2008 and November 2016, 187 consecutive patients with LA-NSCLC were treated definitively with CRT utilizing either PBRT or photon RT. No patient received adjuvant immunotherapy as this cohort predates the results of the PACIFIC trial. Clinical characteristics, RT details, and outcomes were collected. Using the institutional electronic medical record, we conducted a screen for first instance of CVE, including myocardial infarction (MI), atrial fibrillation (AFIB), stroke, aortic aneurysm, coronary artery disease, heart failure, and graded these events. Associations with these events with RT type were calculated by using Fisher's Exact test, and survival by log-rank test from Kaplan-Meier analysis.

Results: All patients received CRT to a median dose in both groups of 66.6 Gy (range 52.2–74.0 Gy). 89 (47.6%) received photon RT, while 98 patients (52.4%) received PBRT. Median follow up was 29 months (range 4–134). The photon cohort was significantly younger, median age 63.8 years compared with 69.4 years ($P=0.01$) and had a less extensive smoking history (median 30 vs 40 pack-years, $P=0.035$). Mean heart dose (MHD) was significantly higher in the photon group (median 15.0 vs 6.7 Gy, $P<0.001$) as were the proportions of patients receiving >10 Gy (61.8% vs 28.6%, $P<0.001$) and >20 Gy MHD (29.2% vs 7.1%, $P<0.001$). The photon cohort had a lower burden of CVEs before RT, 34.8% compared with 54.1% of the PBRT group ($P=0.012$). After RT, overall CVEs recorded were similar, observed in 42.7% of the photon group compared with 40.8% of the PBRT group ($P=0.88$). Following treatment, more total (5.7%, $n=5$ vs 1.1%, $n=1$) and grade 3+ ($n=3$ vs $n=1$) MIs occurred in the photon group compared with the PBRT group, although the association did not reach statistical significance ($P=0.88$ and 1 respectively). Likewise, numerically more strokes occurred in the photon cohort compared with the PBRT cohort (4.8%, $n=4$ vs 0, $P=0.052$). Median overall survival was similar between the groups (29.2 vs 29.0 months, $P=0.6$). Type of radiation received did not correlate with occurrence of other CVEs or in evaluating time to individual CVEs.

Conclusions: In our retrospective analysis of definitive treatment of LA-NSCLC, the use of PBRT lowered the mean radiation dose to the heart. While we observed fewer total and grade 3+ MIs and strokes in the PBRT group, the differences in CVEs did not reach statistical significance.

(P117) Pulmonary Hemorrhage in Patients Treated with Thoracic Stereotactic Ablative Radiotherapy and Anti-Angiogenic Agents

Brianna Lau, BA¹, Hyunsoo No, MD, CMD¹, Yufan (Fred) Wu, MD², Max Devine, BS¹, Ryan Ko, BS³, Billy Loo, MD, PhD¹, Maximilian

Diehn, MD, PhD¹, Alex Chin, MD, MBA¹, Lucas Vitzthum, MD, MAS¹; ¹Stanford University Radiation Oncology, ²Stanford University, ³Oakland University

Background: Hemoptysis is a rare but potentially fatal toxicity associated with thoracic stereotactic ablative radiotherapy (SABR). Prior studies have suggested that vascular endothelial growth factor inhibitors (VEGFI) may potentiate the risk for pulmonary hemorrhage in patients treated with SABR for centrally located lung tumors. However, the toxicity severity relative to timing or sequence of treatment delivery between SABR and VEGFI, as well as location of the treated tumor, is not well defined.

Objectives: The purpose of this study is to evaluate the combined toxicity of VEGFIs and SABR for peripheral, central, or ultra-central tumors.

Methods: We retrospectively evaluated patients with primary or metastatic lung tumors treated with SABR between 2008 and 2018 at a single institution. Baseline patient, tumor and treatment characteristics were evaluated. Pulmonary bleeding events were graded using CTCAE version 5.0. Rates of a grade three or higher (G3+) or any ipsilateral pulmonary hemorrhage at three years were estimated using the Kaplan-Meier method. We compared rates of bleeding by tumor location, treatment with a VEGFI, sequence of therapy and VEGFI within 90 days of SABR using the log-rank test.

Results: This inclusion criteria identified a total of 925 pulmonary tumors treated with SABR in 691 patients. Of this cohort, 44 patients were treated with a VEGFI (bevacizumab, sorafenib, pazopanib, sunitinib or ramucirumab), with the majority receiving bevacizumab ($n=38$, 86.3%). Median follow-up was 32.2 months for the overall cohort and 46.4 months for VEGFI patients. The rate of G3+ hemorrhage was significantly higher in patients treated with a VEGFI (7.3 vs 0.8%, $P<0.01$). The rate of any grade hemorrhage did not significantly vary between groups (9.4 vs 2.7%, $P=0.1$). Among those treated with a VEGFI, the median interval between VEGFI therapy and SABR was 16 weeks, ranging from zero days to 3.7 years, with 15 (34.0%) patients treated within 90 days of SABR. Among patients treated with SABR and VEGFI, there was no significant difference in rates of hemorrhage when the interval was $>$ or \leq 90 days (12.0 vs 0.0%, $P=0.17$). Similarly, there was no significant difference between rates of G3+ hemorrhage when VEGFI was given before (12.9%), after (8.3%), or before and after SABR (0.0%). Patients were treated with SABR to peripheral (738, 79.8%), central (137, 14.8%) and ultra-central (50, 5.4%) locations with a median BED10 of 87.5 Gy. When stratified by location, both central/ultra-central tumors (21.1 vs 3.2%, $P=0.03$) and peripheral tumors (3.4 vs 0.1%, $P=0.03$) had increased rates of G3+ hemorrhage when treated with a VEGFI.

Conclusions: VEGFI therapy was associated with an increased rate of high-grade hemorrhage in patients undergoing SABR to pulmonary tumors. Rates of high-grade hemorrhage were increased with VEGFI for both central/ultra-central and peripheral tumors although the absolute rate was low for peripheral tumors. While limited by low sample size and event rate, there was no correlation observed between interval or sequence of VEGFI and SABR and rate of high-grade hemorrhage.

(P118) Pulmonary Adverse Events After Real World Adjuvant Immune Checkpoint Inhibitor (ICI) Therapy and Its Impact on Survival for Locally Advanced Non-Small Cell Lung Cancer

Zhongxing Liao, MD, FASTRO, FFAWR¹, Lirong Wu, MD, PhD², Ting Xu, MD, PhD³, Saumil Gandhi, MD, PhD⁴, Steven H. Lin, MD, PhD⁵, Wang Jing, MD, PhD⁶, Quynh-Nhu Nguyen, MD³, Aileen Chen, MD³, Joe Chang, MD, PhD³, Mehmet Altan, MD³, Anne Tsao, MD³, Roza Nurieva, PhD³, Ajay Sheshadri, MD⁴, James Welsh, MD⁷, Percy Lee, MD³; ¹The University of Texas MD Anderson Cancer Center, ²Jiangsu Cancer Hospital, ³UT MD Anderson Cancer Center, ⁴UT MD Anderson Cancer Center, ⁵MD Anderson Cancer Center, ⁶Shandong Cancer Hospital, ⁷MD Anderson Cancer Center Welsh Lab

Background: In the PACIFIC trial, only lung cancer patients without disease progression and who did not have symptomatic pneumonitis from concurrent CRT were included in the randomization, excluding many patients from the benefit of ICI due to concern over severe

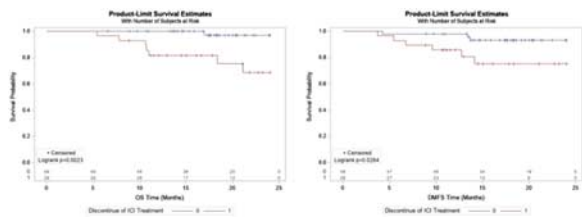

FIGURE 1. Two-year disease outcomes in NSCLC patients developed TRPT stratified by completion of ICI treatment.

pulmonary adverse events. In real world practice, however, ICI is commonly given to any patient after concurrent CRT, even though it is not clear whether deviation from PACIFIC patient selection for combining ICI with CRT will increase the risk of lung complications or not. **Objectives:** 1) To assess the impact of adjuvant immune checkpoint inhibitor (ICI) on the incidence of pulmonary adverse events (PAE), and 2) to assess the impact of ICI and PAE on survival in locally advanced non-small cell lung cancer (LA-NSCLC).

Methods: Patients with a diagnosis of LA-NSCLC who received concurrent chemotherapy with curative intention were included in this study. Information on patient-, disease-, treatment-characteristics, and outcomes (survival and toxicities) have been collected on an IRB approved protocol for retrospective chart review and informed consents has been waived. Characteristics were compared by t-test for continuous variables and χ^2 test for categorical variables. Survival and PAE were calculated from the end of radiotherapy. PAEs included pneumonitis, pneumonia, fibrosis, and pleural effusion. Outcomes were compared between patients who received ICI versus who did not by Cox proportional hazard regression and Kaplan-Meier analysis. The impact on survival due to ICI interruption caused by pulmonary toxicities was also assessed.

Results: Total 336 patients treated from July 2010 to November 2019 were included in this study, among them, 217 patients received standard concurrent chemoradiation (CRT) and 119 patients treated after December 2014 received additional ICI (CRTI). Patient- and disease-characteristics were similar between CRT and CRTI groups. The 2-year survival rates were 62.7% and 86.6% for CRT and CRTI groups respectively ($P < 0.0001$); and the survival curves starts to diverge at the end of radiotherapy which was the beginning of OS assessment time point. In multi-variable analysis, CRTI patients had statistically significantly improved 2-year survival (HR = 0.43, 95% CI 0.24-0.76, $P = 0.004$), adjusted for age, sex, race, smoking packyear, ECOG score, histology, stages, gross tumor volume, tumor location, total radiation dose, mean lung dose and radiation modality. ECOG score, smoking pack-year, mean lung dose and adjuvant chemotherapy were also significant independent factors for 2-year survival. Additionally, CRTI patients had improved 2-year PFS with HR of 0.58 (95% CI 0.39-0.85, $P < 0.006$). Incidence of \geq grade 2 PAEs was 34.1% in CRT group compared with 68.9% in CRTI group (CRT vs. CRTI: HR = 0.46, 95% CI 0.34-0.64, $P < 0.0001$). Finally, compared with those who completed ICI after developing PAEs, patients who had to discontinue ICI due to severe PAEs had worse 2-year OS (68% vs 98%, $P < 0.0001$) and higher rates of distant metastasis (69% vs 79%, $P = 0.015$) (Fig. 1).

Conclusions: Immune checkpoint immunotherapy has improved 2-year survival and disease control of patients with LA-NSCLC treated with concurrent chemoradiation. Patients who received CRTI were more likely to develop PAEs compared with those who received CRT. The ICI discontinuation due to PAEs negatively impacted 2-year overall and distant metastasis free survival.

(P119) Patterns of Care in Maintenance Therapy in U.S. Patients Undergoing Definitive Chemoradiation for Stage 3 Non-Small Cell Lung Cancer (NSCLC)

Jason Liu, MD¹, Emily Bratton, PhD², Xinyan Yu, BS², Colton Ladbury, MD¹, Joseph Wagner, MPH², Mackenzie Small, BS², Arya Amini, MD¹; ¹City of Hope National Medical Center, ²IQVIA

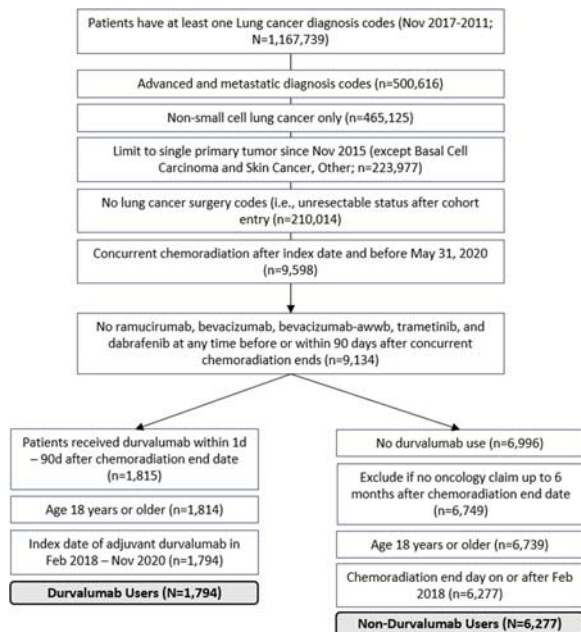

FIGURE 1. Steps of analytic dataset creation for stage 3 NSCLC cohorts (durvalumab users and non-durvalumab users) in open claims.

Background: The recommended treatment for patients with unresectable stage 3 NSCLC is definitive chemoradiation followed by 1 year of maintenance durvalumab.

Objectives: To assess use of maintenance durvalumab based on patient and physician characteristics among stage 3 NSCLC patients in the U.S. **Methods:** Analyses were conducted in both open claims (IQVIA pharmacy and medical claims data) and adjudicated closed claims (IQVIA PharMetrics Plus Health Plan Claims Database). Patients were filtered with the following criteria: (1) ≥ 1 lung cancer diagnosis code Nov 2017–Nov 2020, (2) retain any metastatic/advanced codes, (3)

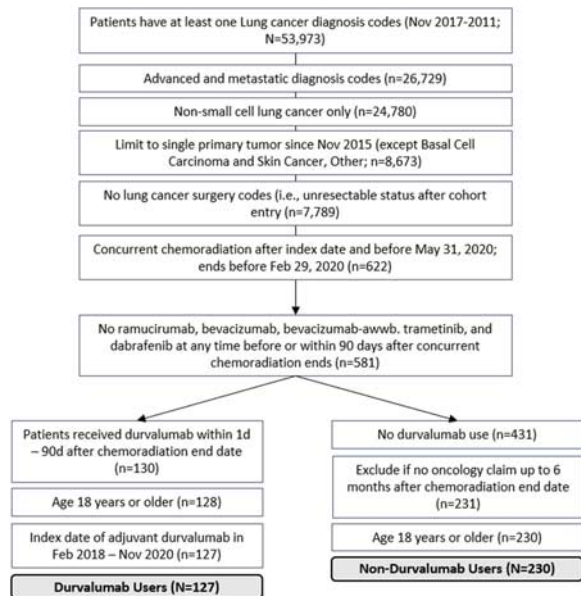

FIGURE 2. Steps of analytic dataset creation for stage 3 NSCLC cohorts (durvalumab users and non-durvalumab users) in closed claims.

TABLE 1. Summary of NSCLC Patient Characteristics based on Open Claims (left) (Nov 2017- Nov 2020) and Closed Claims (right) (Nov 2017- Nov 2020)

	Overall N=8071	% 100	Durvalumab N=1794	% 100	No Durvalumab N=6277	% 100
Age (years)						
Mean	66.8		67.5		66.7	
SD	9.45		8.9		9.6	
Median	67.0		68.0		67.0	
Min	18.0		20.0		18.0	
Max ¹	85.0		85.0		85.0	
Age Category						
<65y	3186	39.5	651	36.3	2535	40.4
≥65y	4885	60.5	1143	63.7	3742	59.6
Gender						
Female	3691	45.7	845	47.1	2846	45.3
Male	4380	54.3	949	52.9	3431	54.7
Insurance Status						
Commercial	4,627	57.3	1003	55.9	3624	57.7
Medicaid	220	2.7	36	2.0	184	2.9
Medicare	3,189	39.5	748	41.7	2441	38.9
Unknown	35	0.4	7	0.4	28	0.4
Income Category (USD)						
≤\$50,000	5803	71.9	1324	73.8	4479	71.4
\$50,001-75,000	1091	13.5	222	12.4	869	13.8
\$75,001-100,000	294	3.6	61	3.4	233	3.7
>\$100,000	578	7.2	120	6.7	458	7.3
Missing	305	3.8	67	3.7	238	3.8
Location of Care²						
Urban	7303	90.5	1607	89.6	5696	90.7
Rural	463	5.7	120	6.7	343	5.5
Unknown	305	3.8	67	3.7	238	3.8
Geographic Region						
Midwest	1860	23.0	469	26.1	1391	22.2
Northeast	1154	14.3	252	14.0	902	14.4
South	3531	43.7	780	43.5	2751	43.8
West	1221	15.1	226	12.6	995	15.9
Unknown	305	3.8	67	3.7	238	3.8
Adjuvant Treatment⁴						
Chemotherapy	2785	34.5	-	-	2785	44.4
Combination treatment	1629	20.2	-	-	1629	26.0
Pembrolizumab	2047	25.4	-	-	2047	32.6
Nivolumab	137	1.7	-	-	137	2.3
Atezolizumab	39	0.5	-	-	39	0.6
EGFR or ALK inhibitors	79	1.0	-	-	79	1.3
None	2820	34.9	-	-	2820	44.9

	Overall N=357	% 100	Durvalumab N=127	% 100	No Durvalumab N=230	% 100
Age (years)						
Mean	66.6		67.1		66.3	
SD	9.5		9.0		9.8	
Median	66.0		67.0		66.0	
Min	38.0		44.0		38.0	
Max ¹	85.0		85.0		85.0	
Age Category						
<65y	153	42.9	48	37.8	105	45.7
≥65y	204	57.1	79	62.2	125	54.3
Gender						
Female	186	52.1	61	48.0	125	54.3
Male	171	47.9	66	52.0	105	45.7
Insurance Status						
Commercial	140	39.2	46	36.2	94	40.9
Medicaid	5	1.4	2	1.6	3	1.3
Medicare	208	58.3	77	60.6	131	57.0
Unknown	4	1.1	2	1.6	2	0.9
Income Category (USD)						
≤\$50,000	259	72.5	92	72.4	167	72.6
\$50,001-75,000	33	9.2	13	10.2	20	8.7
\$75,001-100,000	1	0.3	0	-	1	0.4
>\$100,000	6	1.7	2	1.6	4	1.7
Missing	58	16.2	20	15.7	38	16.5
Location of Care²						
Urban	127	35.6	55	43.3	72	31.3
Rural	25	7.0	9	7.1	16	7.0
Unknown	205	57.4	63	49.6	142	61.7
Geographic Region						
Midwest	146	40.9	61	48.0	85	37.0
Northeast	56	15.7	23	18.1	33	14.3
South	96	26.9	28	22.0	68	29.6
West	58	16.2	15	11.8	43	18.7
Unknown	1	0.3	0	-	1	0.4
Adjuvant Treatment⁴						
Chemotherapy	124	34.7	-	-	124	53.9
Combination treatment	63	17.6	-	-	63	27.4
Pembrolizumab	82	23.0	-	-	82	35.6
Nivolumab	12	3.4	-	-	12	5.2
Atezolizumab	1	0.3	-	-	1	0.4
EGFR or ALK inhibitors	1	0.3	-	-	1	0.4
None	72	20.2	-	-	72	31.3

1 – Maximum recorded age is 85 years for all patients to ensure protection of patient identity. 2 – If physician was affiliated with any academic institution, then academic practice was coded as ‘yes’. 3 – Urban/rural status associated with chemoradiation claim. 4 – First adjuvant regimen following chemoradiation and within 90 days of treatment end date.

exclude SCLC patients, and (4) limit to single primary tumor looking back to Nov 2015. Lastly, patients must have been ≥ 18 years, have no lung cancer surgery codes during the observation period, and received chemoradiation after the index date and before May 31, 2020. Logistic regression was used to evaluate differences between patients who received durvalumab following chemoradiation compared with those who did not.

Results: N = 8071 NSCLC patients were included from the open claims source; 1794 (22.2%) received maintenance durvalumab (Table 1). Overall, distributions of baseline characteristics were similar between durvalumab and non-durvalumab patients. Durvalumab patients had a higher probability of older age (≥ 65 y) (odds ratio [OR] 1.2, 95% CI 1.1–1.3) and being treated in the Midwest (OR 1.2, 95% CI 1.0–1.4), respectively. Among non-durvalumab users (N = 6277), chemotherapy (n = 2785; 44.4%) and pembrolizumab (n = 2047; 32.6%) were most commonly used, with combination chemotherapy treatment given to n = 1629 (26.0%) patients. N = 357 NSCLC patients were included from the closed claims source; 127 (35.6%) received maintenance durvalumab (Table 1b). Overall, distributions of baseline characteristics were similar between durvalumab and non-durvalumab patients. None of the baseline characteristics differed between exposure groups (all 95% CIs crossed the null). Among non-durvalumab users (N = 230), chemotherapy (n = 124; 53.9%) and pembrolizumab (n = 82; 35.6%) were most commonly used, with combination chemotherapy treatment given to n = 63 (27.4%) patients.

Conclusions: The rate of durvalumab utilization was overall low in both the open and closed claims data sources (22.2% and 35.6% respectively). In the open claims data source, durvalumab utilization was higher for patients ≥ 65 years and treated in the Midwest; similar trends were observed in the closed claims database but did not reach

significance. Interesting findings include a higher rate of pembrolizumab utilization than expected. Future studies are needed to better understand these current practice patterns in the U.S. (Figs. 1 and 2).

(P120) Multiple Primary Lung Cancers: Treatment Outcomes After Stereotactic Body Radiotherapy (SBRT)

Gyujae Choi, MD¹, Angela Zhu, MD¹; ¹Baylor College of Medicine

Background: Patients with lung cancer may often present with multiple primary lung cancers (MPLCs), whether found to have two primary foci of disease at the same time (synchronous) or developing a second lesion after treatment of their initial disease (metachronous). Surgery is considered the mainstay of treatment for patients with stage I-II non-small-cell lung cancer (NSCLC), with stereotactic body radiation therapy (SBRT) an acceptable alternative for patients unfit for surgery or who refuse surgery.

Objectives: We investigated our institutional treatment outcomes following SBRT for patients with early-stage MPLCs.

Methods: From June 2011 to March 2020, patients receiving SBRT for MPLC were reviewed. Patients underwent review of imaging and pathology at a multi-disciplinary tumor board before undergoing definitive treatment. Dose and fractionation varied with the most common prescriptions being 50 Gy/5 fractions, 56 Gy/4 fractions, and 55 Gy/5 fractions.

Results: A total of 38 patients were treated for 80 metachronous and synchronous lesions, which were comprised of 68 T1 lesions and 12 T2 lesions. Median follow-up was 25.9 months, with local control (LC) rates calculated per lesion to be 98.6%, 93.3%, and 88.2% at 1, 2, and 3 years. Median overall survival (OS) was 43.5 months, with OS rates at

83.6%, 67.8%, and 52.3% at 1, 2, and 3 years. 62 of the 80 (77.5%) treated lesions were not associated with any subsequent acute or late toxicity. The 18 (22.5%) lesions associated with toxicity were comprised of 9 acute and 9 late events. All reported toxicity were grade 1 (13 of 18) or grade 2 (5 of 18).

Conclusions: SBRT for early-stage MPLC achieves high control rates with limited toxicity. Patients deemed unfit for surgical management of MPLC should be considered for definitive SBRT.

(P121) Single Institution Experience of Stereotactic Body Radiation Therapy (SBRT) in Lung Cancer

Mary Nittala, DrPH¹, Eswar Mundra, MD², Satyaseelan Packianathan, MD, PhD³, Maria Smith, MSN, NPC², William Woods, MSN, NPC², rahul bhandari, MD⁴, Robert Allbright, MD², Srinivasan Vijayakumar, MD, MPH²; ¹The University of Mississippi Medical Center, ²University of Mississippi Medical Center, ³University of Mississippi Medical Center, ⁴G.V. (Sonny) Montgomery VA Medical Center

Background: Stereotactic body radiation therapy [SBRT] is an effective treatment for early stage non- small cell cancer [NSCLC] patients who do not undergo surgery, either medically inoperable or who decline surgery. SBRT provides enhanced tumor control and overall survival [OS] results in medically inoperable early stage NSCLC patients. In this study, we investigated the effectiveness of two different radiation fractions used and presented our institutional experience.

Objectives: To determine the clinical outcomes between two treatment regimens (50 Gy vs. 55 Gy) among stage I NSCLC patients treated with SBRT at a state academic medical center.

Methods: A retrospective analysis of 114 patients with stage I (T1-2N0M0) NSCLC lesions treated at a state academic medical center between October, 2009 and April, 2019. Survival analysis with treatment regimens of 50 Gy and 55 Gy were conducted to evaluate the significant effect of scheduled fractionation. The primary endpoints of this retrospective study included rates of OS, local control [LC] and disease free survival [DFS]. Log rank test and the Kaplan-Meier method was used to analyze the survival function between populations of two treatment intervals. The SPSS v.24.0 was used for statistical analysis.

Results: The 114 early stage NSCLC patients (median age, 68 y; range 12-87 y) had a median follow-up of 23 months (range 2- 64). Number of males (n = 72; 63.2%) were diagnosed and treated for NSCLC compared with females (n = 42; 36.8 %). The majority of patients in this study were Caucasians (n = 68; 59.6%) compared with African-Americans (n = 46; 40.4%). The majority of patients (n = 76; 66.7%) were treated with 50 Gy in 5 fractions, and 38 patients (33.3%) with 55 Gy in 5 fractions. The 1, 2 & 3-year OS and DFS rates were better for the patients treated with 55 Gy group [OS, 81.7% vs. 72.8%; 81.7% vs. 58.9%; 81.7% vs. 46.7% (P=0.049)], [DFS, 69.7% vs. 69.7%; 61.9% vs. 55.7%; 61.9% vs. 52.0% (P=0.842)] compared with the

TABLE 2. Number of Patients Who Failed Categorized

	Table 2. Number of Patients who failed categorized								
	Local Failure			Regional Failure			Distant Failure		
	50 Gy	55 Gy	p-value	50 Gy	55 Gy	p-value	50 Gy	55 Gy	p-value
Total cohort	11 (9.6%)	6 (5.3%)	0.853	18 (15.8%)	3 (2.6%)	0.040	10 (8.8%)	3 (2.6%)	0.405
Tstage									
T1a	5 (6.6%)	3 (7.9%)	0.591	12 (15.8%)	2 (5.3%)	0.110	6 (7.9%)	1 (2.6%)	0.707
T1b	5 (6.6%)	2 (5.3%)		3 (3.9%)	1 (2.6%)		3 (3.9%)	1 (2.6%)	
T2a	1 (1.3%)	1 (2.6%)		3 (3.9%)	0 (0.0%)		1 (1.3%)	1 (2.6%)	
Lobe									
RUL	2 (2.6%)	1 (2.6%)	0.024	6 (7.9%)	1 (2.6%)	0.438	2 (2.6%)	0 (0.0%)	0.333
RML	0 (0.0%)	0 (0.0%)		3 (3.9%)	0 (0.0%)		0 (0.0%)	0 (0.0%)	
LLL	5 (6.6%)	3 (7.9%)		3 (3.9%)	2 (5.3%)		2 (2.6%)	1 (2.6%)	
LUL	2 (2.6%)	0 (0.0%)		5 (6.6%)	0 (0.0%)		2 (2.6%)	2 (5.3%)	
LLL	2 (2.6%)	2 (5.3%)		1 (1.3%)	0 (0.0%)		4 (5.3%)	0 (0.0%)	
BED Gy									
100 Gy	11 (14.5%)	-	0.853	18 (23.7%)	-	0.040	10 (13.2%)	-	0.405
115.5 Gy	-	6 (15.8%)		-	3 (7.9%)		-	3 (7.9%)	
FX scheduled									
10 Gy x 5	11 (14.5%)	-	0.853	18 (23.7%)	-	0.040	10 (13.2%)	-	0.405
11 Gy x 5	-	6 (15.8%)		-	3 (7.9%)		-	3 (7.9%)	
Histology									
Adenocarcinoma	6 (7.9%)	3 (7.9%)	0.459	8 (10.5%)	3 (7.9%)	0.441	5 (6.6%)	3 (7.9%)	0.518
Squamous cell carcinoma	5 (6.6%)	3 (7.9%)		9 (11.8%)	0 (0.0%)		3 (3.9%)	0 (0.0%)	
Lung Nodules	0 (0.0%)	0 (0.0%)		1 (1.3%)	0 (0.0%)		2 (2.6%)	0 (0.0%)	

patients treated with 50 Gy. Adenocarcinoma was the most common pathology in both groups comprising (51.3% & 68.4%) lesions. A total number of [39 (34.2%) vs. 12 (8.5%)] failed. Among these, 11 (9.6%) vs. 6 (5.3%) local, 18 (15.8%) vs. 3 (2.6%) regional, and 10 (8.8%) vs. 3 (2.6%) distant failures were observed between two groups treated with 50 Gy vs. 55 Gy.

Conclusions: Early stage NSCLC lesions treated with modified SBRT fractionation group 55 Gy shows better local control, overall survival and disease free survival rates compared with the interval group of patients treated with 50 Gy (Tables 1, 2 and Fig. 1).

TABLE 1. 1-, 2-, and 3-year Overall Survival and Disease Free Survival (%)

		Table 1. 1-, 2-, and 3-year Overall survival and Disease free survival (%)						P- value
Group		1 year		2 years		3 years		
		50 Gy	55 Gy	50 Gy	55 Gy	50 Gy	55 Gy	
Overall Survival	Entire cohort	72.8%	81.7%	58.9%	81.7%	46.7%	81.7%	0.049
	Tumor Stage 1	70.0%	86.1%	57.7%	86.1%	46.2%	86.1%	0.056
	Tumor Stage 2	71.4%	60.0%	71.4%	60.0%	53.6%	60.0%	0.056
	Path-Adenocarcinoma	76.3%	83.1%	59.3%	83.1%	46.1%	83.1%	0.076
	Pathology- SCCa	75.0%	77.8%	60.9%	77.8%	48.7%	77.8%	0.076
	Upper Lobe	71.8%	82.1%	59.4%	82.1%	46.9%	82.1%	0.060
	Middle Lobe	75.0%	-	75.0%	-	50.0%	-	0.060
	Lower Lobe	67.4%	86.7%	52.9%	86.7%	45.4%	86.7%	0.060
	FX Size 10 Gy vs. 11 Gy x 5	72.8%	81.7%	58.9%	81.7%	46.7%	81.7%	-
	Disease free survival	Entire cohort	69.7%	69.7%	55.7%	61.9%	52.0%	61.9%
Tumor Stage 1		67.6%	70.1%	62.2%	61.4%	58.1%	61.4%	0.919
Tumor Stage 2		85.7%	60.0%	17.1%	60.0%	17.1%	60.0%	0.919
Path-Adenocarcinoma		78.3%	68.3%	56.6%	54.7%	42.4%	54.7%	0.981
Pathology- SCCa		55.6%	70.0%	49.5%	70.0%	41.2%	70.0%	0.981
Upper Lobe		78.0%	77.8%	61.6%	77.8%	61.6%	77.8%	0.563
Middle Lobe		50.0%	-	50.0%	-	50.0%	-	0.563
Lower Lobe		57.7%	62.2%	44.9%	46.7%	29.9%	46.7%	0.563
FX Size 10 Gy vs. 11 Gy x 5		69.7%	69.7%	55.7%	61.9%	52.0%	61.9%	-

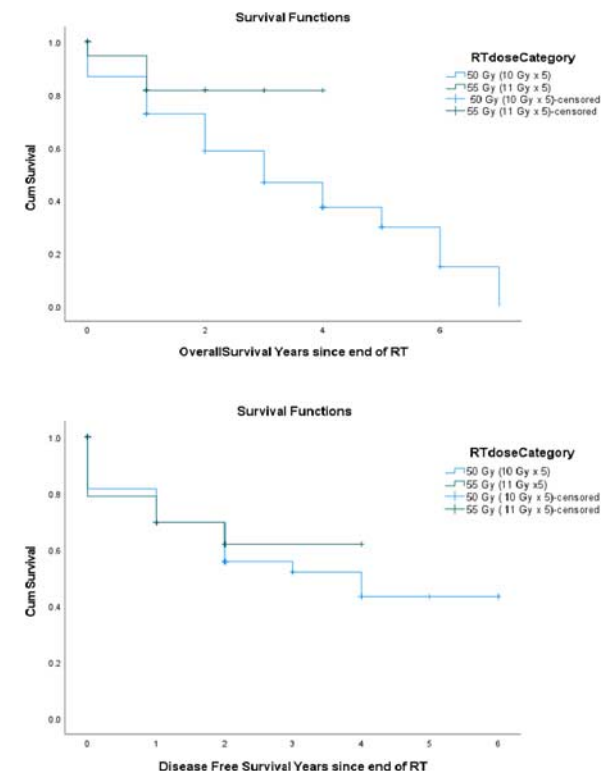

FIGURE 1. Overall survival and disease free survival years since end of SBRT.

(P122) Treatment Patterns for Isolated Nodal Recurrences in Non-Small Cell Lung Cancer After Definitive Stereotactic Ablative Radiotherapy

Hyunsoo No, MD, CMD¹, Max Devine, BS¹, Brianna Lau, BA¹, Billy Loo, MD, PhD¹, Maximilian Diehn, MD, PhD¹, Alex Chin, MD, MBA¹, Lucas Vitzthum, MD, MAS¹; ¹Stanford University Radiation Oncology

Background: Stereotactic ablative radiotherapy (SABR) results in high rates of primary tumor control for early-stage non-small cell lung cancer (NSCLC). However, medical literature notes up to 2-9% of patients may develop isolated nodal recurrence (INR) after initial treatment. An optimal treatment paradigm for those experiencing INR has not been well defined.

Objectives: The objective of this study is to determine the rates of INR after SABR for treatment of early-stage NSCLC and to analyze the patterns of care and outcomes for early-stage NSCLC patients who developed post-SABR INR.

Methods: This retrospective cohort study included patients with Stage T1-3 N0 M0 NSCLC treated with definitive SABR from 2003-2018. Exclusion criteria included synchronous primaries, first-line systemic therapy, and patients with <3 months follow up. We investigated the incidence of INR and baseline factors between patients who did and did not exhibit INR. Among patients who experienced INR, we described treatment patterns and outcomes including overall (OS) and progression free survival (PFS) from the time of nodal failure using the Kaplan-Meier method.

Results: A total of 342 patients met inclusion criteria for the study. The median follow-up post-SABR was 3.3 years with a 3-year INR rate of 10.6% (95% CI, 6.6%–13.4%). The median OS for patients with INR was 2.1 years with an estimated 3-year survival of 39.3% (95% CI, 24.4–63.3%). The median PFS was 1.4 years with an estimated 3-year PFS of 26.7% (95% CI, 14.1–50.3%). Both OS and PFS differed by treatment type. Thirty of the 34 patients exhibiting INR had known salvage treatment courses, including chemoradiotherapy (CRT) (43.3%, n=13), RT alone (26.7%, n=8), chemotherapy alone (13.3%, n=4), and observation (16.7%, n=5). Patients treated with CRT had the best survival outcomes with an estimated 3-year OS and PFS of 81.5% (95% CI, 61.1–100.0%) and 63.9% (95% CI, 40.7–100.0%), respectively. No patients treated with chemotherapy, RT alone, or observation were alive without a censoring event at 3 years.

Conclusions: INR occurred in approximately 10% of patients treated with SABR for early-stage NSCLC. The highest rates of survival among patients with INR were observed in those treated with chemoradiotherapy.

(P123) Hypofractionated vs. Standard Radiotherapy for Locally Advanced Limited-Stage Small Cell Lung Cancer

Nadia Saeed, BA¹, Lan Jin, PhD, MSc², Alexander Sasse, BA³, Arya Amini, MD⁴, Vivek Verma, MD⁵, Nataniel Lester-Coll, MD⁶, Po-Han Chen, MD, PhD⁷, Roy Decker, MD, PhD⁸, Henry Park, MD, MPH⁹; ¹Yale University School of Medicine, ²Yale School of Medicine, Department of Surgery, ³Yale University, ⁴City of Hope National Medical Center, ⁵University of Texas M.D. Anderson Cancer Center, ⁶Department of Radiation Oncology, ⁷University of Vermont Larner College of Medicine, Division of Radiation Oncology, ⁸Yale School of Medicine, Department of Pathology, ⁹Yale School of Medicine

Background: There is increasing interest in hypofractionated radiation therapy (HFRT) in locally advanced limited-stage small cell lung cancer (SCLC), particularly during the COVID-19 pandemic. HFRT with 40-45 Gy in 15 fractions is preferred in many Western countries but not used regularly in the U.S. HFRT is likely more convenient and less expensive than standard radiation therapy (RT), and reduces exposure during the pandemic. The real-world impact of definitive HFRT with chemotherapy in this setting remains unclear.

Objectives: We sought to determine if: (1) HFRT is associated with different patient characteristics & practice patterns but similar overall survival (OS) compared with standard RT in locally advanced limited-stage SCLC; (2) the relationship between fractionation schedule and OS is impacted by chemotherapy timing.

Methods: This retrospective cohort analysis included patients in the National Cancer Database with unresected primary stage II-III SCLC diagnosed in 2008-2016. All patients underwent chemotherapy initiated

within six months of starting either HFRT (40-45 Gy in 15 fractions) or standard RT (45 Gy in 30 fractions or 60-70 Gy in 30-35 fractions). Associations among sociodemographic and clinicopathologic variables with fractionation were assessed using χ^2 , Fisher's exact test, ANOVA, and multivariable logistic regression. Kaplan-Meier estimator, log-rank test, and multivariable Cox proportional hazards regression modeling were used to evaluate OS. Propensity score matching (PSM) analysis was used to reduce confounding on OS. Subset analyses were performed to evaluate the effect of chemotherapy timing in relation to RT.

Results: Our analysis included 7,143 patients: 25.8% received 45 Gy in 30 fractions, 72.1% 60-70 Gy in 30-35 fractions, and 2.1% HFRT. Median age was 64 years. 85.2% of patients had stage III disease and 71.9% underwent early concurrent chemotherapy (RT and chemotherapy initiated within 30 d of each other). In the PSM cohort (N=292), median OS was similar between standard RT (22.9 mo [95% CI 18.2-30.4]) vs. HFRT (21.2 mo [CI 16.3-24.7]; $P=0.13$). MVA on the whole cohort (N=7,143) also yielded comparable OS (HR for HFRT 1.09, CI 0.90-1.32, $P=0.37$). On PSM, OS was numerically shorter with HFRT in the early concurrent chemotherapy subset (16.0 [CI 13.5-19.3] vs. 19.1 mo [CI 15.4-24.8], $P=0.20$) and numerically longer with HFRT in the non-early concurrent chemotherapy subset (30.0 mo [CI 21.4-37.7] vs. 18.6 mo [CI 15.0-21.5], $P=0.075$).

Conclusions: OS with HFRT appears similar to standard RT in locally advanced limited-stage SCLC, although the timing of chemotherapy may modify the effect of fractionation on OS. HFRT may be considered over standard RT in select patients (particularly those unable to receive early concurrent chemotherapy), which may offer certain advantages both during and after the pandemic era. Given the limitations of this retrospective analysis and lack of data on toxicity and tumor control, further investigation is needed.

(P124) Hypofractionated vs Conventionally Fractionated Radiation Therapy with Concurrent Chemotherapy for Stage III Non-small Cell Lung Cancer

Alexander Sasse, BA¹, Vikram Jairam, MD², Nadia Saeed, BA³, Henry Park, MD, MPH²; ¹Yale University, ²Yale School of Medicine, ³Yale University School of Medicine

Background: A standard definitive treatment option for locally advanced non-small cell lung cancer (NSCLC) includes conventionally fractionated radiation therapy (CFRT) with concurrent chemotherapy. Moderately hypofractionated radiation therapy (HFRT), a potential alternative, is frequently used outside the United States. HFRT has increased convenience for patients and minimizes exposure to the healthcare setting, which is particularly beneficial during the COVID-19 pandemic.

Objectives: The aims of this study were to evaluate practice patterns and compare overall survival (OS) between patients who received concurrent chemoradiotherapy with HFRT vs CFRT for stage III NSCLC.

Methods: The National Cancer Database (NCDB) was queried for patients with stage III NSCLC diagnosed between 2004 and 2015 with known vital status who received concurrent chemoradiation, defined as chemotherapy received within 30 days of radiation. CFRT was defined as delivery of 60 Gy in 30 fractions. HFRT was defined as 55-60 Gy in 20-24 fractions with 2.5-3 Gy/fraction. Univariable and multivariable logistic regression was used to identify factors associated with receipt of HFRT. We evaluated the association between fractionation schedule and OS using the Kaplan-Meier method, and significance was determined using the log-rank test. Univariable and multivariable Cox proportional hazards regressions were used to identify predictors of OS. Propensity score matching (PSM) was performed to account for known confounders of OS. PSM was performed using the variables with a P -value less than 0.1 after multivariable cox regression analysis.

Results: A total of 6,914 patients were included in this analysis, among whom 6751 (97.6%) received CFRT and 163 (2.4%) received HFRT. On χ^2 analysis, HFRT was associated with lower vs. higher education level (56% vs. 44%, $P=0.007$) and a higher vs. lower T-stage (63% vs. 51%, $P=0.002$), but was not associated with age, N-Stage, comorbidity score, income, or insurance. In the whole cohort, HFRT was significantly associated with decreased OS compared with CFRT on

univariable (median 14.9 [CI 13.0-16.7] vs. 21.6 mo [CI 20.9-22.1], $P < 0.001$) and multivariable (HR 1.39, 95% CI 1.14-1.69, $P = 0.003$) analysis. After PSM, similar findings were noted on univariable analysis but were no longer statistically significant (median 15.2 [CI 12.8-17.1] vs. 21.7 [15.1-27.1] months, $P = 0.10$).

Conclusions: Our findings suggest that moderately hypofractionated radiotherapy with concurrent chemotherapy may not be a viable alternative to concurrent chemoradiotherapy with conventionally fractionated radiation therapy for routine utilization in stage III NSCLC, even during the COVID-19 pandemic. Given that selection bias may affect the observed outcomes after HFRT, prospective studies will be needed to directly compare these regimens.

(P125) Residing in Food Priority Areas Correlates with Unique Socioeconomic Demographics and Patterns-of-care in Patients with Stage III Non-small Cell Lung Cancer

Bansi Savla, MD¹, Muhammad Hamza, Medical Student², Kanav Markan, Medical Student³, Dan Yacubovich, Undergraduate Student⁴, Stephen Cobbs, Undergraduate Student⁵, Katherine Scilla, MD⁶, Whitney Burrows, MD⁷, Raneeh Mehra, MD⁸, Robert Miller, MD, MBA, FASTRO⁹, Christian Rolfo, MD, MBA⁸, Pranshu Mohindra, MD, MBBS², Melissa Vyuhuis, MD, PhD¹⁰; ¹University of Maryland, ²Department of Radiation Oncology, University of Maryland School of Medicine, ³American University of Integrative Sciences, ⁴University of Maryland Baltimore County, ⁵Stonehill College, ⁶University of Maryland Department of Medical Oncology, ⁷University of Maryland Division of Thoracic Surgery, ⁸University of Maryland Division of Medical Oncology, ⁹Division of Radiation Oncology, University of Tennessee Medical Center, ¹⁰Baltimore Washington Medical Center Department of Radiation Oncology

Background: Nutritional deficiencies have been linked with poor prognosis in multiple cancer sites. Patients living in food priority areas (FPAs) may have limited access to healthy foods. To our knowledge, there is no published data analyzing how residence in an FPA may impact treatments rendered or outcomes for patients with locally advanced non-small cell lung cancer (LA-NSCLC).

Objectives: We aim to characterize socioeconomic and cancer demographics of stage III NSCLC patients living in zip code-designated FPAs treated with curable intent at a single institution. We hypothesize that residence in an FPA will impact treatments rendered and cancer outcomes.

Methods: This is an IRB-approved single institution retrospective study of 515 LA-NSCLC patients treated with curative intent from January 2000-January 2019. χ^2 tests were done to compare variables stratified by residence in FPAs. Mann-Whitney U-test was used to compare differences between continuous variables. Kaplan-Meier analysis and cox proportional hazard models were used to analyze overall survival (OS) and freedom from recurrence (FFR). Cox regression with forward model selection was used for multivariate analysis (MVA).

Results: Twenty-eight percent of our LA-NSCLC patients live in FPAs (N = 144). Patients living in an FPA were more likely than patients not living in an FPA to self-identify as black (86% vs 18.7%, $P < 0.0001$), single (70.6% vs 39.5%, $P < 0.001$), younger than 60 (52.1% vs 35.7%, $P = 0.001$), uninsured (13.9% vs 10.5% $P < 0.0001$), with lower median income (\$28548 vs. \$66200, $P < 0.001$) and worse performance status compared with non-FPA patients (ECOG PS > 1.40%, $P = 0.025$). Patients in FPAs had lower pre-chemoradiation (CRT) albumin ($P = 0.006$), took longer to finish RT [Avg. 48d (28-78) vs. 46d (1-77), $P = 0.044$] and were less likely to undergo trimodality therapy (14% vs. 86%; $P < 0.001$). Most patients received concurrent CRT (91%) with definitive doses (82% of patients received ≥ 60 Gy) of RT. There was no difference in OS (23.1m vs. 25m, $P = 0.46$) or FFR (15.4m vs 18.4m, $P = 0.32$) between the two groups. On MVA, insurance status (HR: 0.38, 95% CI: 0.242-0.618, $P < 0.001$), consolidation chemotherapy receipt (HR: 0.556, 95% CI: 0.409-0.755, $P < 0.0001$), marital status (HR: 1.37, 95%CI: 1.049-1.884, $P = 0.037$), pre-CRT albumin (HR: 0.628, 95% CI: 0.507-0.765, $P < 0.001$) and post-CRT BMI (HR: 0.968, 95% CI: 0.943-0.994, $P = 0.017$) were all predictors of OS.

Conclusions: In this institutional analysis examining impact of FPAs in patients with LA- NSCLC, we demonstrate a socioeconomic divide in this population, where residing in FPAs reflects distinct patient

demographics and receipt of less aggressive therapy (i.e. surgery). Though cancer outcomes were not different between the groups, important nutritional factors were predictive of OS in LA-NSCLC. To overcome limitations of a retrospective analysis, we are currently characterizing nutritional needs of our patients in a prospective study.

(P126) Integration of Anti-TIGIT and anti-Lag3 with NBTXR3-mediated Immunoradiation Therapy Improves Abscopal Effect and Induces Long-term Memory Against Cancer

Yun Hu, PhD¹, Lily Schuda², Sébastien Paris, PhD³, Hampartsoum Barsoumian, PhD⁴, Angelica Cortez, PhD⁴, James Welsh, MD⁴; ¹Welsh Lab Radiation Oncology MD Anderson Cancer Center, ²MD Anderson Experimental Radiation Oncology Welsh Lab, ³Nanobiotix, ⁴MD Anderson Cancer Center Welsh Lab

Background: TIGIT and Lag3 are inhibitory receptors expressed on cytotoxic CD8+ T cells and NK cells and directly inhibit the activation and proliferation of these cells. We proposed that blockade of TIGIT and Lag3 could improve antitumor immune response in a mouse model of anti-PD1-resistant mice.

Objectives: In this study, we aim to improve the therapeutic outcome of radioimmunotherapy by combining a radio-enhancer (NBTXR3), radiation, anti-PD1, anti-LAG3, and anti-TIGIT.

Methods: 129Sv/Ev mice were inoculated with 50,000 anti-PD1-resistant 344SQR cells in the right leg on day 0 (primary tumor) and with 50,000 cells in the left leg on day 4 (secondary tumor). Primary tumors were injected with NBTXR3 (radioenhancer nanoparticles) on day 7 and irradiated with 12 Gy on days 8, 9, and 10. Anti-PD1 (200 μ g), anti-Lag3 (200 μ g), and anti-TIGIT (200 μ g) were given to mice by intraperitoneal injections on days 5, 8, 11, 14, 21, 28, 35, and 42. On day 21, primary tumors, secondary tumors, and blood samples were harvested and analyzed with flow cytometry to evaluate changes in immune cell populations. Mice in which tumors were completely eradicated were re-challenged with another 50,000 344SQR cells in the right flank at least two months post radiation; no further treatment was given to these mice, and tumor growth was monitored.

Results: The addition of anti-TIGIT, anti-Lag3, or anti-TIGIT+anti-LAG3 to NBTXR3+XRT+anti-PD1 therapy significantly improved control of both primary and secondary tumors, and the addition of anti-TIGIT plus anti-LAG3 also led to fewer spontaneous lung metastases. The addition of either anti-TIGIT or anti-Lag3 to NBTXR3+XRT+anti-PD1 extended the mouse survival time relative to NBTXR3+XRT+anti-PD1. None of the 8 mice in either the NBTXR3+XRT+anti-PD1+anti-TIGIT group or the NBTXR3+XRT+anti-PD1+anti-Lag3 group survived more than 32 days; in contrast, 3 of the 8 mice that received NBTXR3+XRT+anti-PD1+anti-TIGIT+anti-Lag3 survived until the end of the experiment. These surviving mice were found to have developed memory against 344SQR cells, and no further tumor growth was observed after re-challenge. Flow cytometry analysis showed that adding anti-TIGIT+anti-Lag3 to NBTXR3+XRT+anti-PD1 increased the percentages of proliferating CD8+ T cells in primary tumors, secondary tumors, and blood, and increased the percentage of NK cells in the secondary tumors.

Conclusions: Blockade of TIGIT and Lag3 with NBTXR3+XRT+anti-PD1 improved CD8+ T-cell proliferation, augmented the antitumor response at both irradiated and unirradiated (abscopal) tumors, and induced potent long-term antitumor memory in mice.

(P127) Radiotherapy Targeting One or Two Metastases in the Setting of Oligoprogressive Lung Cancer

Rebecca Shulman, MD¹, Mengying Deng¹, Martin Edelman, MD¹, Sameera Kumar, MD¹; ¹Fox Chase Cancer Center

Background: Improved outcomes for metastatic lung cancer achieved with immunotherapy and other innovative treatments have raised expectations that progression-free survival of patients with oligoprogressive lung cancer may be prolonged with SBRT and hypofractionated radiotherapy (RT).

Objectives: This retrospective study tested the hypothesis that RT targeting one or two metastases in patients with oligoprogressive lung cancer will delay metastatic progression with little added toxicity.

Methods: A retrospective chart review was conducted for lung cancer patients treated from 2018 to 2020 at a single institution. Covariates examined included age, sex, length of illness, regimen of systemic treatment, sites of metastases, and toxic side effects. Oligoprogression before RT was defined as radiographic evidence of progression of one or two metastases while all other metastases remained stable. The patients' lung cancer was considered to have progressed after RT if surveillance imaging during a follow-up period ranging from 32 and 471 days demonstrated extension of at least one metastasis, including any metastasis at a non-irradiated site. Kaplan-Meier curves were calculated for PFS.

Results: Twenty five patients were identified who had received RT for oligoprogressive lung cancer, including 24 patients with NSCLC (19 with adenocarcinoma, 4 with squamous cell, 1 with mixed adenocarcinoma and squamous) and one patient with small cell lung cancer. One patient had not undergone surveillance imaging post-RT and was excluded from further study. Sites of oligoprogression in the remaining 24 patients included lung (71%), mediastinal/supraclavicular lymph nodes (21%), bone (4%), and adrenal gland (4%). The median progression free survival time for all patients was 9.5 months. After receiving RT, 13 of 24 patients (54%) demonstrated no further disease progression during the follow-up period. Of the 11 patients with progression post-RT, 9 involved extracranial lesions, 1 involved intracranial lesions and 1 involved both. Seven patients (64%) with progressive disease had received immunotherapy and four patients (36%) had received a form of targeted systemic therapy. For all 25 study patients receiving RT for oligoprogressive disease, toxicity was short-term and no worse than grade 2, limited chiefly to cough and dysphagia.

Conclusions: A retrospective chart review reveals that 54% of patients who received RT targeting 2 or fewer metastases for oligoprogressive lung cancer showed no evidence of disease progression during a follow-up period ranging from 32 to 471 days. The median progression free survival time for all patients was found to be 9.5 months. Toxicity associated with RT for oligoprogressive disease was mild and transient.

(P128) Radiation Therapy (RT) for Diffuse Large B-cell Lymphoma (DLBCL) of the Orbit: A Single Institution's Cohort Experience

Jonathan Baron, BS¹, Christopher Wright, MD¹, Daniel Lee, BS¹, Maribel Carpenter¹, Cesar Briceño, MD², Amit Maity, MD PhD¹, John Plasteras, MD, PhD¹, Ima Paydar, MD¹; ¹Department of Radiation Oncology, University of Pennsylvania, ²Department of Ophthalmology, University of Pennsylvania

Background: Orbital DLBCL can arise as a primary ocular adnexal lymphoma or, more commonly, as a secondary manifestation of already systemic disease. RT has been established as a potential treatment option, but due to the limited number of patients presenting with orbital DLBCL, the efficacy and safety of this modality needs to be further characterized.

Objectives: Our purpose was to describe a single institution's experience of treating patients with orbital DLBCL with RT, as well as to assess the safety and outcomes in this population.

Methods: We retrospectively analyzed data from 10 patients with orbital DLBCL treated with RT between May 2009 and January 2019 at the University of Pennsylvania. Patient, tumor, radiation, and systemic therapy details were retrospectively recorded from the patients' medical records. Acute (<3 mo) and late (>3 mo) radiation toxicity were graded by CTCAEv5. Follow-up time was defined as time from start of RT to event or last follow-up. Overall response was defined as achieving a complete or partial response by clinical exam or imaging as defined by Deauville or RECIST criteria. Progression free survival was estimated using the Kaplan-Meier method.

Results: Median follow-up time was 24.8 months (range 0.8-87.5). The majority of the patients were male (70%), with a median age of 60 (22-74). Nine patients presented with unilateral and 1 patient with bilateral orbital involvement. Median maximum dimension of disease treated was 26mm (range 15-52). Most patients (70%) had systemic

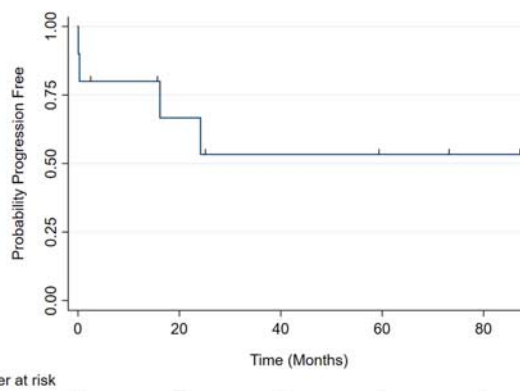

FIGURE 1. Progression Free Survival.

lymphoma preceding secondary orbital involvement. Ocular muscles were the most common orbital subsite involved (60%), while 4 patients had lacrimal gland and eye lid involvement, and 3 patients had extension of disease to bone. Five patients received rituximab before RT, 2 patients after RT, and 3 patients did not receive systemic therapy. Median RT dose used was 17.5 Gy (range 3-36 Gy) in 1.5-2 Gy fractions. Photon RT was used in 9 patients (IMRT in 6 patients & 3DCRT in 3 patients) and proton RT in 1 patient. Grade 1 (G1) and G2 acute RT toxicities were present in 7 patients and 2 patients, respectively. No G3 or higher acute toxicities occurred. Dry eye syndrome occurred in two patients, one with G1 toxicity first noted 3 months after RT (treated with 10.5 Gy) and one with G2 toxicity first noted 1 month after RT (treated with 25 Gy); both patients developed chronic dry eyes. No other long-term toxicities occurred. The overall response rate was 90%, with 60% of patients achieving a complete response. No patients had orbital disease recurrence, while 4 patients experienced systemic progression (Fig. 1).

Conclusions: RT for the treatment of orbital DLBCL resulted in favorable outcomes, with no local recurrence and with modest long-term toxicity. Future studies may be undertaken to further clarify the dose and technique of RT to optimize local control and toxicity.

(P129) Radiation Therapy for Early Stage Low Grade Follicular Lymphoma Is Associated with Improved Overall Survival in the Rituximab Era

Jordan Fenlon, MD¹, Ryan Hutten, MD¹, Skyler Johnson, MD¹, David Gaffney, MD, PhD¹, Randa Tao, MD¹; ¹Huntsman Cancer Institute at the University of Utah

Background: National Comprehensive Cancer Network (NCCN) treatment guidelines for early stage follicular lymphoma (FL) includes involved-site radiation therapy (ISRT). Up to 50% of early stage FL treated with radiation therapy (RT) remain relapse-free at 10 years and are likely cured. Despite this, RT utilization has been decreasing.

Objectives: To compare overall survival (OS) for stage I and II, grade 1 and 2 FL between various treatment regimens, in the era that ISRT is standard and rituximab became widely available. Secondary objectives were to evaluate trends in national practice patterns over time, and identify predictors for receipt or omission of RT.

Methods: The National Cancer Database (NCDB) was queried to identify patients with stage I-II and grade 1-2 nodal or extranodal FL diagnosed between 2011 and 2017. Patients were stratified by treatment group including observation, RT, rituximab, RT + rituximab, and chemotherapy + rituximab. OS was calculated using a Kaplan-Meier estimator and analyzed with log rank testing. Multivariable Cox proportional hazards modeling was utilized to evaluate associations between clinical variables and survival. Multivariable logistic regression was used to identify predictors for recommendation and receipt of RT vs. observation. The observation and RT groups were

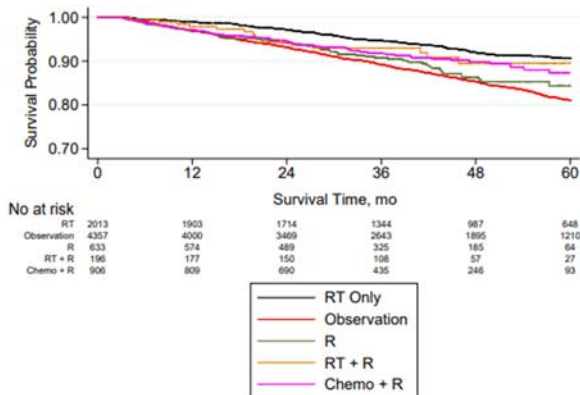

FIGURE 1. Survival by treatment group. Kaplan-Meier analysis for patients by treatment group. All patients had stage I-II, grade 1-2 FL. Abbreviations: RT, radiotherapy; FL, follicular lymphoma; R, rituximab.

propensity matched to mitigate confounding factors and again analyzed with multivariable Cox, Kaplan-Meier estimator, and log rank testing.

Results: 11,645 patients were included in the analysis with a mean follow up time of 45 months who underwent treatment with either RT only (n=2,399), observation (n=5,214), rituximab (n=808), RT + rituximab (n=242), or chemotherapy + rituximab (n=1,165). Five-year OS was 90.6% for RT only, 81.1% for observation, 84.3% for rituximab, 89.5% for RT + rituximab, and 87.3% for chemo + rituximab. Compared with RT alone, observation was associated with worse OS outcomes (HR 1.41, $P < .001$), while the other treatment groups were not significantly different. Compared with patients with private insurance, those with Medicaid had worse survival (HR 2.26, $P < .001$). Patients who made > 46,000 dollars per year had better survival than those who made < 30,000 (HR 0.75, $P = .03$). Treatment at an academic center was predictive for both the recommendation (OR 1.30, $P < .01$) and receipt (OR 1.39, $P < .01$) of observation instead of RT. Between 2011 and 2017, RT monotherapy decreased from 33.4% to 22.4%, chemotherapy + rituximab increased from 0.5% to 15%, and rituximab monotherapy increased from 0.6% to 10.2%. After propensity matching the RT and observation groups, observation remained associated with worse overall survival (HR 1.23, $P = .02$).

Conclusions: In early stage low-grade FL, RT was associated with improved survival compared with observation in propensity matched

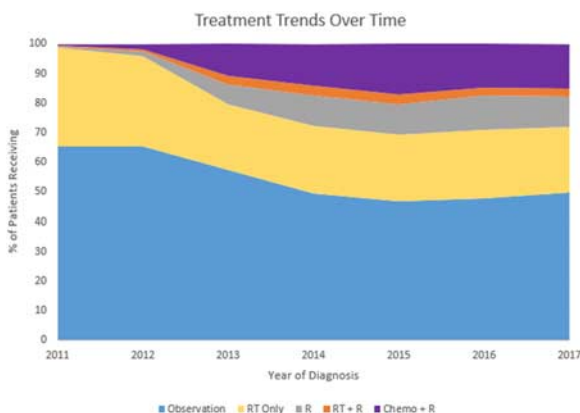

FIGURE 2. Treatment trends over time. Treatment trends over time comparing observation, RT, R, RT + R, and chemo + R between 2011 and 2017. Abbreviations: RT, radiotherapy; R, rituximab.

cohorts. Despite lack of evidence supporting a change in patterns of care, RT utilization continues to decline and systemic therapy is increasing (Figs. 1 and 2).

(P130) Clinical Outcomes for Patients with Diffuse Large B-cell Lymphoma Treated with Radiation Therapy and Lenalidomide

Sungjune Kim, MD, PhD¹, Shreni Shah, Medical Student², Su-Yuan Yu, Medical Student³, Matthew Mills, MD¹, Nicholas Figura, MD¹, Timothy Robinson, MD, PhD¹; ¹H. Lee Moffitt Cancer Center and Research Institute, Department of Radiation Oncology, ²USF Morsani College of Medicine, ³University of South Florida, Morsani College of Medicine

Background: First-line treatment for diffuse large B-cell lymphoma (DLBCL) consists of combination immunochemotherapy with rituximab, cyclophosphamide, doxorubicin, vincristine, and prednisone (R-CHOP). Patients who develop relapsed or refractory (R/R) disease following second-line salvage high-dose chemotherapy and autologous stem cell transplantation have a dismal overall prognosis (Crump M, et al. Blood 2017).

Objectives: Lenalidomide is an immunomodulatory agent that has been shown to demonstrate efficacy in the setting of R/R DLBCL; however, there is currently minimal evidence on the role of combining lenalidomide with radiotherapy (RT).

Methods: This is a single institution retrospective review of DLBCL patients who underwent RT within 3 months of lenalidomide administration. Local control (LC), progression-free survival (PFS), and overall survival (OS) were estimated using the Kaplan-Meier method from the start date of RT and were compared with the log-rank test.

Results: The study identified 10 DLBCL patients who received RT to 12 distinct disease sites within 3 months of lenalidomide administration. Median clinical follow-up post-RT was 6.9 months (range, 0.1-118.0 mo). The majority of patients were stage IV (n=7, 70%) with a median age of 69 years (range, 42-93 y). Three patients demonstrated BCL2 rearrangement while one patient demonstrated MYC rearrangement; however, there were no cases of double- or triple-hit DLBCL. The median number of systemic regimens before lenalidomide was 2.5 (range, 0-6). The 12 disease sites treated with RT received a median dose of 36 Gy (range, 18-50 Gy) to a planned target volume of 553cc (range, 16-4764 cc). The 12-month LC, PFS, and OS were 87.5%, 34.4%, and 62.5%, respectively. There were no episodes of acute nor late grade ≥ 3 radiation-related toxicities.

Conclusions: The combination of radiotherapy with concurrent lenalidomide appears to be a well-tolerated treatment option for patients with R/R DLBCL. While early outcomes data appear comparable with historical controls, further evaluation of long-term clinical outcomes and toxicities remains warranted.

(P131) Upfront versus Delayed Stereotactic Radiosurgery for Brain Metastases in Epidermal Growth Factor Receptor (EGFR) Mutant Non-Small Cell Lung Cancer Treated with EGFR Tyrosine Kinase Inhibitors

Ammoren Dohm, MD¹, Joseph Tang, BA¹, Matthew Mills, MD¹, Bradford Perez, MD¹, Timothy Robinson, MD, PhD², Ben Creelan, MD¹, Jhanelle Gray, MD¹, Arnold Etame, MD¹, Michael Vogelbaum, MD, PhD¹, Peter Forsyth, MD¹, Hsiang-Hsuan Michael Yu, MD¹, Daniel Oliver, MD¹, Kamran Ahmed, MD³; ¹H. Lee Moffitt Cancer Center & Research Institute, ²H. Lee Moffitt Cancer Center and Research Institute, Department of Radiation Oncology, ³Department of Radiation Oncology, H. Lee Moffitt Cancer Center & Research Institute

Background: Epidermal growth factor receptor-tyrosine kinase inhibitors (EGFR-TKI) and stereotactic radiosurgery (SRS) have shown response in the management of non-small cell lung cancer (NSCLC) brain metastases (BM). However, whether to withhold metastasis-

directed therapy until progression of asymptomatic intracranial disease while on EGFR-TKI or to treat with upfront SRS remains an area of investigation, especially in the era of 3rd generation EGFR-TKI.

Objectives: We evaluated clinical outcomes in NSCLC BM treated with SRS and EGFR-TKI to determine optimal management. Our primary objective was to evaluate the effect of SRS timing with EGFR-TKI on distant intracranial control (DIC).

Methods: A total of 30 NSCLC BM patients, treated between 2015 and 2019, to a total of 110 intact (non-operative) BM over 43 single fraction SRS sessions were included. EGFR-TKI therapies included osimertinib (n = 10), afatinib (n = 3), erlotinib (n = 13), and gefitinib (n = 4). Time-to-event analysis was conducted with the Kaplan-Meier method, with log-rank testing to determine differences in outcomes by subgroup. Outcomes included DIC and local control (LC) calculated from SRS and overall survival (OS) from the date of BM diagnosis.

Results: Median follow-up from BM diagnosis was 11.0 months (1.1-53.1 mo) and 9.3 months from SRS (0.1-52.4 mo). SRS was conducted before, concurrently, and after EGFR-TKI therapy in 15, 87, and 8 lesions, respectively. No significant differences in age ($P=0.77$), sex ($P=0.07$), presence of systemic metastasis ($P=0.07$), SRS dose ($P=0.40$), KPS ($P=0.23$) or EGFR-TKI generation ($P=0.45$) were noted between treatment groups. The median DIC was 26.2, 21.0, and 3.2 months ($P=0.086$) for SRS upfront, concurrently, and after EGFR-TKI, respectively; only SRS timing was significant on univariate analysis favoring upfront SRS (HR 0.13, $P=0.048$). Median OS was 42.8, 11.9, and 4.0 months for SRS upfront, concurrently, and after EGFR-TKI, respectively ($P=0.0009$). No differences were noted in LC ($P=0.58$) based on timing of SRS. Rates of radiation necrosis did not differ between treatment groups and were 0%, 3.5%, and 0%, for upfront, concurrent, and after EGFR-TKI groups, respectively, $P=0.49$.

Conclusions: In our analysis of NSCLC BM patients treated with SRS, we demonstrate that upfront SRS before EGFR-TKI was associated with a trend towards improved DIC and improved OS. Further evaluation of concurrent treatment with SRS and third-generation EGFR-TKIs is warranted.

(P132) A Patient-level Data Meta-analysis of the Abscopal Effect

Steven Hatten, Medical Student¹, Eric Lehrer, Resident Physician², Jenn Liao, Medical Student¹, Mike Sha, Medical Student¹, Daniel Trifiletti, MD³, Shankar Siva, Physician⁴, Sean McBride, Physician⁵, David Palma, Physician⁶, Sheldon Holder, Physician⁷, Nicholas Zaorsky, Physician⁸; ¹Department of Radiation Oncology, Penn State Cancer Institute, Hershey, PA, USA, ²Department of Radiation Oncology, Icahn School of Medicine at Mount Sinai, New York, NY, USA, ³Department of Radiation Oncology, Mayo Clinic, Jacksonville, FL, USA, ⁴Sir Peter MacCallum Department of Oncology, University of Melbourne, Melbourne, Australia, ⁵Department of Radiation Oncology, Memorial Sloan Kettering Cancer Center, New York, NY, USA, ⁶Department of Radiation Oncology, London Health Sciences Centre, London, Ontario, Canada, ⁷Division of Hematology and Oncology, Penn State Cancer Institute, Hershey, PA, USA, ⁸Department of Public Health Sciences, Penn State College of Medicine, Hershey, PA, USA

Background: The abscopal effect is defined by local therapy resulting in response within a targeted tumor but also reducing tumor burden in distant, untreated areas.

Objectives: Number one is to systematically review cases of the abscopal effect. Number two is to perform a patient-level data analysis for clinical predictors of duration of response and survival.

Methods: PICOS/PRISMA/MOOSE was used for articles published before 09/2019 in MEDLINE/PubMed and Google Scholar. Inclusion criteria were: (1) population: patients with reported abscopal response; (2) intervention: documented treatment(s); (3) control: none; (4) outcomes: overall and progression-free survival; (5) setting: retrospective case reports. Time from treatment until abscopal response and time from abscopal response until progression or death were calculated.

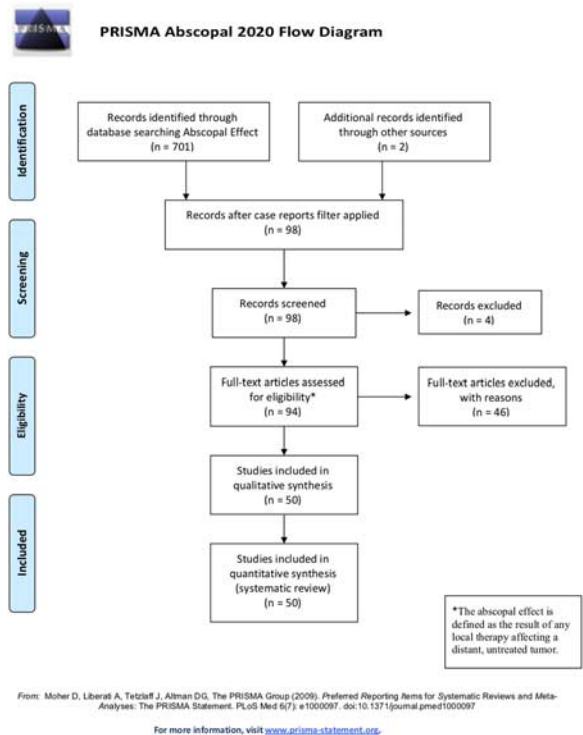

FIGURE 1. PRISMA flow diagram.

Univariate and multivariate analyses were conducted for survival outcomes.

Results: 50 studies (n = 55) were included. Median age was 65 years, (interquartile range, IQR: 58-70) and 62% were male. 54 (98%) patients received radiotherapy; 34 (62%) received radiotherapy alone, 5 (9.1%) underwent surgery, 4 (7.3%) received chemotherapy, and 11 (20%) received immunotherapy. Median total dose was 32 Gy (IQR: 25.5–48 Gy) and median dose per fraction was 3 Gy (IQR: 2-7.2). Median time until abscopal response was 4 months (IQR: 1-5, min 0.5, max 24). At 5-years, overall survival was 63% and distant progression-free survival was 45%. No variables had statistical significance (all $P > 0.05$) in predicting duration of response or survival.

Conclusions: Almost all reported cases of the abscopal response are after radiation therapy; however, there are no known predictors of duration of response or survival in this population (Figs. 1 and 2).

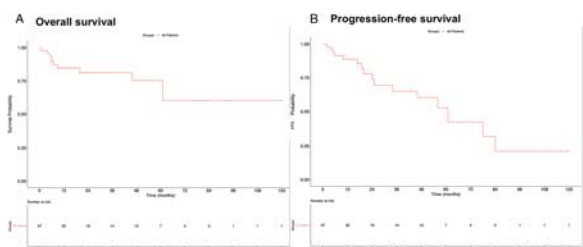

FIGURE 2. Outcome survival and progression free survival.

(P133) Normalized Standardized Uptake Value Characterization of Adrenal Metastases for Biology-Guided Radiation Therapy Utilizing FDG-PET

Calvin Huntzinger, MS¹, Daniel Palmieri, BS², Shervin Shirvani, MD¹, Ronald Lalonde, PhD², Adam Olson, MD³; ¹Reflexion Medical, ²University of Pittsburgh Medical Center, ³Department of Radiation Oncology, UPMC Hillman Cancer Center, University of Pittsburgh School of Medicine

Background: Biology-guided radiation therapy (BgRT) is a tracked dose delivery method utilizing positron emissions emanating from tumors to deliver radiation to moving targets, while minimizing dose to adjacent normal tissue. This novel approach may be beneficial in the application of ablative radiation to treat adrenal metastases in non-small cell lung cancer (NSCLC). Because BgRT is predicated on detecting the SUV of active tumors, it requires PET contrast between the surrounding tissue and the metastasis, which is quantified as the normalized standardized uptake (NSUV).

Objectives: In this study, we reviewed various calculations of NSUV for adrenal metastases, a common site of metastatic spread for non-small cell lung cancer (NSCLC), to determine optimal numerical thresholds for BgRT delivery.

Methods: We measured NSUV values in a retrospective cohort of patients at a single center who received an FDG PET-CT before SBRT for adrenal metastases between January 1, 2007 and July 1, 2019. We excluded patients who received systemic therapy between PET-CT and SBRT or whose PET-CT was more than 180 days before SBRT. NSUV was calculated by dividing max SUV within the gross tumor volume (GTV) by mean SUVs in 5, 10, and 15-mm rings around the GTV. The liver area was cropped from the rings surrounding right adrenal metastases while bowel and stomach areas were cropped from rings surrounding left adrenal metastases. All contouring was performed in an Eclipse treatment planning system. A two-tailed T-test was used for any comparisons. A prespecified NSUV of 3 was assumed as the minimum NSUV for BgRT and potential factors associated with NSUVs above this threshold were explored.

Results: Eighteen patients were ultimately included in the analysis. Ten (56%) received SBRT for a right adrenal metastasis and 8 (44%) for a left adrenal metastasis. The average age at time of treatment was 69 (range 44-87) with 13 male (72%) and 5 female (28%) patients. The average time elapsed between PET-CT and SBRT was 43 days (range 15-133). Ten (56%) patients received systemic therapy in the year before their PET-CT and 8 (44%) received no systemic therapy. The NSUVs are presented in the following table: GTV Ring Size NSUV (Mean±SD) NSUV Range 5 mm 3.95±2.24 1.94-9.76 10 mm 4.66±2.80 2.16-12.19 15 mm 5.03±3.02 2.23-13.09. There was no significant difference in NSUV ratio between the 5 mm and 15 mm ring method ($P=0.233$). Tumor size was not associated with a higher odds of an NSUV of 3 or greater ($P=0.3978$ for 5 mm ring, $P=0.7597$ for 10/15 mm ring) nor was right vs. left adrenal metastasis ($P=1.0$ for 5 mm ring, $P=0.1176$ for 10/15 mm rings).

Conclusions: Biology guided radiation therapy (BgRT) shows promise in the treatment of adrenal metastases. Mean NSUVs increased as the GTV ring size increased, but the difference between the smallest and largest increase was not significant. A 5 mm ring around the GTV could provide a robust and simple method to calculate NSUVs to see whether adequate contrast is present for BgRT. Assuming an NSUV of 3 is required for optimal functioning of BgRT, most of the adrenal metastases would be BgRT candidates. This investigation will inform future investigations of BgRT for NSCLC metastases in the upper abdomen.

(P134) Improved Accuracy in Predicting Survival When Supplementing a Predictive Model with Clinical Intuition

Johnny Kao, MD¹, Amanda Zucker, DO², Michelle Urso, RN¹, Pawel Karwowski, BA¹, Giavanna Bustamante, RN¹, Deborah Lugo, RN³, LuAnn Rowland, RN, OCN, CNS¹; ¹Good Samaritan Hospital Medical Center, ²New York College of Osteopathic Medicine, ³Memorial Sloan Kettering Cancer Center Regional Care Network

Background: Neither clinical intuition or validated prognostic models adequately predict survival for patients with advanced cancer.

Objectives: We hypothesized that experienced clinicians could predict survival of patients with metastatic cancer better than validated models alone thereby demonstrating the value of clinician intuition.

Methods: This prospective, single institution, cohort study conducted at a community hospital recruited 73 patients with advanced cancer

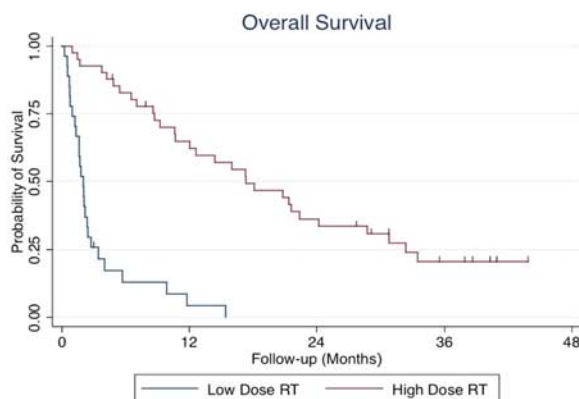

FIGURE 1. Overall survival by radiation dose intensity.

referred to radiation oncology between October 2016 and December 2017. A survival estimate was calculated using the validated NEAT model based on number of active tumors, ECOG performance status, albumin, and primary tumor site. The consulting nurse and physician were prospectively surveyed on whether the patient would survive a longer or shorter duration than the NEAT estimate. Concurrent predictions made by the validated Chow and TEACHH models were used as a control. Overall survival was calculated from time of enrollment. The accuracy of predictions compared with observed survival between groups was assessed using the McNemar's χ^2 test.

Results: The median survival for enrolled patients was 7.8 months. The accuracy of nursing and physician predictions was similarly accurate (61.6% vs. 60.3%, $P=0.85$). The accuracy of the TEACHH model and Chow models were also similar (49.3% vs. 48.0%, $P=0.74$). The accuracy of human predictions was significantly improved compared with the accuracy of computer models alone (61.0% vs. 48.6%, $P=0.016$). Radiation dose intensity was informed by predicted survival and median survival was significantly higher in patients receiving an EQD2 ≥ 40 (17 mo vs. 2 mo, $P<0.001$).

Conclusions: Experienced clinicians, both nurses and oncologists, have insight that can modestly supplement the accuracy of validated models to predict survival in patients with advanced cancer (Fig. 1).

(P135) Local Control of 1-5 Fraction Radiotherapy Regimens for Spinal Metastases: An Analysis of the Impacts of Biologically Effective Dose and Primary Histology

Roman Kowalchuk, MD¹, David Cousins, MD², Kelly Spencer, MS³, K. Richardson, MS³, James Larner, MD², Timothy Showalter, MD², William McAllister, MD⁴, Jason Sheehan, MD, PhD², C. Kersh, MD³, Sunil Dutta, MD⁵; ¹Mayo Clinic - Rochester, ²University of Virginia, ³University of Virginia / Riverside, ⁴Riverside Regional Medical Center, ⁵Emory University

Background: Ablative doses of radiotherapy for the treatment of oligometastatic disease can improve overall survival (OS). Despite this benefit, toxicity can be severe and patient selection is critical.

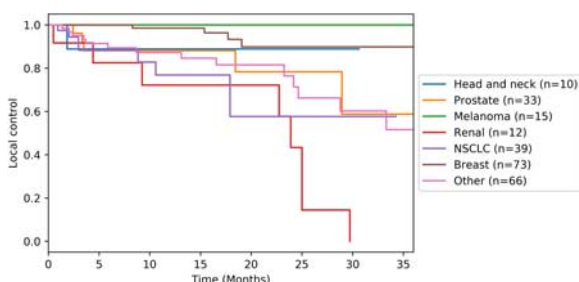

FIGURE 1. The local control rates of the different primary histologies are shown.

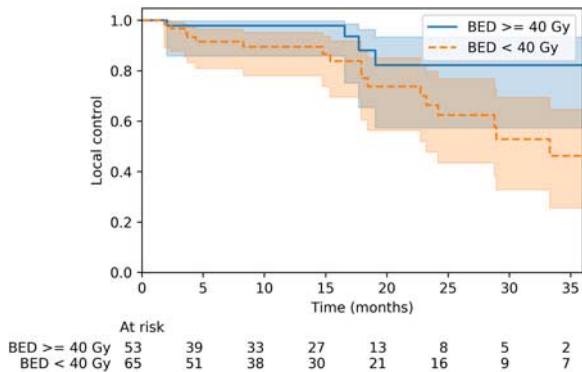

FIGURE 2. Patients in RPA class 1 demonstrated improved local control with BED ≥ 40 Gy ($P=0.05$).

Objectives: This analysis evaluates the impacts of biologically effective dose (BED) and primary histology on local control (LC) of spinal metastases treated with highly conformal radiotherapy to moderately escalated doses per fraction.

Methods: Patients were treated at two institutions with either stereotactic body radiation therapy (SBRT) or tomotherapy for spinal metastases from 2010-2020, and at least one clinical or imaging follow-up was required. Patients treated with less than 5 Gy per fraction or 8 Gy in 1 fraction were excluded. The dataset was divided into three RPA classes predictive of survival (Chao et al IJROBP 2012). Class 1 required > 30 months from primary disease diagnosis and Karnofsky performance status (KPS) > 70; class 2 included > 30 months from primary diagnosis and KPS ≤ 70 or ≤ 30 months from diagnosis and age < 70 years; class 3 involved ≤ 30 months from diagnosis and age ≥ 70. The primary endpoint was LC; secondary endpoints were toxicity and OS. Key statistical methods included the Kaplan-Meier method and Cox hazards analysis. An alpha/beta ratio of 10 Gy was used for BED calculations.

Results: 223 patients with 248 treatments met inclusion criteria. Patients had a median KPS of 80, and common primary disease sites included breast (29.4%), non-small cell lung cancer (15.7%), and prostate (13.3%). Patients presented at a median age of 67.4 years at a median 42.8 months after primary diagnosis. A median 24 Gy (6-36) was delivered in a median 3 fractions (1-5) to a median planning target volume (PTV) of 37.3 cc (1.1-2436.0). Median BED was 38.4 Gy (9.6-79.2). At a median clinical follow-up of 12.85 months, there were 44 local failures. 2-year LC was 75.7%, and 2-year OS was 42.1% via the Kaplan-Meier method. No difference in LC was noted between SBRT and tomotherapy, but PTV > 30 cc was indicative of increased local failure ($P=0.01$). LC was varied among primary histology in the cohort (Fig. 1), and increased BED was predictive of improved LC for primary prostate cancer (HR = 0.85 95% CI [0.74-0.99]). When matched according to RPA class, patients with favorable survival (class 1) had improved LC with BED ≥ 40 Gy ($P=0.05$, Fig. 2). This relationship was also shown using an ROC curve. Patients in the intermediate and poor survival groups failed to show this improvement. Toxicity was minimal, with only 6 total instances of grade 2 toxicity reported, and no grade 3-5 toxicities.

Conclusions: Treatment of spinal metastases with a range of moderately escalated doses per fraction using modern radiation techniques was efficacious and well-tolerated. BED ≥ 40 Gy may improve LC, particularly for prostate cancer and patients with favorable survival; however, a multidisciplinary approach may be necessary for larger tumor volumes.

(P136) Adoption of Immunotherapy in the Treatment of Metastatic Malignant Melanoma

Todd A. Pezzi, MD, MBA¹, Ashley Pezzi, MD², Amanda Shreders, MD³, William Hammond, MD³, Jennifer Crozier, MD³, Christopher Pezzi, MD³; ¹MD Anderson Cancer Center, ²Baylor College of Medicine Dermatology, ³Baptist MD Anderson Cancer Center

Background: Major advances have occurred in the treatment of metastatic melanoma since 2011 leading to improvements in response to therapy and overall survival—notably the usage of immunotherapy

TABLE 1. Trends of Immunotherapy Over Time

YEAR	Immunotherapy Alone	Chemotherapy Alone	Immunotherapy OR Chemotherapy	Immunotherapy OR Chemotherapy, in those Age ≤65 and Comorbidity score of 0
2004	13.4%	34.7%	42.4%	54.4%
2005	11.3%	37.4%	44.2%	56.3%
2006	11.0%	41.1%	48.0%	57.4%
2007	8.5%	38.7%	44.1%	55.0%
2008	10.0%	41.2%	47.7%	60.3%
2009	9.4%	43.1%	49.2%	61.9%
2010	9.3%	43.7%	50.1%	57.7%
2011	16.5%	38.1%	51.4%	58.9%
2012	17.8%	37.6%	51.9%	63.8%
2013	24.9%	38.0%	57.3%	66.1%
2014	29.6%	35.6%	59.5%	72.1%
Overall	15.7%	39.1%	50.7%	61.0%

and targeted agents. Using the National Cancer Database (NCDB) we examined the utilization of such treatments overtime and attempted to identify potential barriers of use.

Objectives: The objective is to explore trends in the utilization of immunotherapy/targeted therapy in the treatment of metastatic melanoma.

Methods: The NCDB was queried for patients with MM from 2004-2014. Sociodemographic, treatment, and overall survival data was examined.

Results: The use of immunotherapy/chemotherapy in healthy patients increased overtime to 54% in 2004 to 72.1% in 2014. Patients were less likely to receive immunotherapy if they lacked insurance, were of older age, and received care at a community practice as compared with

TABLE 2. Multivariate Analysis of Predictors of Receiving Immunotherapy

	p-value	OR	95% C.I. for OR	
			Lower	Upper
Age <50				
50 - 60	<0.005	0.796	0.693	0.914
61 - 70	<0.005	0.646	0.555	0.751
>70	<0.005	0.298	0.25	0.355
Female vs Male	0.088	0.921	0.838	1.012
2011 - 2014 vs 2004 - 2010	<0.005	2.968	2.707	3.254
Charlson/Deyo Score 0 (ref)				
Score 1	<0.005	0.738	0.649	0.838
Score 2	<0.005	0.414	0.327	0.523
Insurance, None (ref)				
Private	<0.005	2.578	2.029	3.275
Medicare	0.051	1.341	0.999	1.8
Medicaid	<0.005	2.05	1.584	2.652
Other Govt	0.013	1.716	1.122	2.624
Facility Type, Community Cancer (ref)				
Comprehensive Community Cancer	0.331	1.095	0.912	1.315
Academic Research	<0.005	1.809	1.512	2.163
Integrated	0.143	1.177	0.946	1.464
Median Income, by zip code of residence, <\$38k (ref)				
38 - 48k	0.716	1.031	0.874	1.217
48 - 63k	0.149	1.132	0.957	1.339
>63k	0.323	1.097	0.913	1.319
% No high-school degree, by zipcode; >21% (ref)				
13 - 21%	0.119	1.139	0.967	1.341
7 - 13%	0.065	1.172	0.99	1.387
<7%	0.001	1.389	1.15	1.678
XRT NO (ref)				
Yes	0.093	0.923	0.84	1.014
Surgery NO (ref)				
Yes	0.016	1.124	1.022	1.236
Chemo (none)				
Yes	<0.005	0.389	0.348	0.435
Recommended, not administered	<0.005	0.41	0.338	0.497

Multivariate analysis of predictors of receiving immunotherapy for treatment of metastatic melanoma in the National Cancer Data Base, 2004-2014.

academic centers. Those who received immunotherapy had greater overall survival.

Conclusions: Immunotherapy and targeted agents have become standard of care in those with MM. Adoption of these new therapies has been slow despite the improved response and survival compared with other treatments (Tables 1 and 2).

(P137) Disparities in Survival and Surveillance Imaging in Long-Term Survivors with Brain Metastasis Treated with Stereotactic Radiosurgery

Benjamin Rich, MD¹, Deukwo Kwon, PhD², Yash Soni³, Danny John³, Jonathan Bell, MD, PhD¹, Gregory Azzam, MD¹, Eric Mellon, MD¹, Raphael Yechieli, MD¹, Carolina Benjamin, MD⁴, Ronald Benveniste, MD⁴, Matthew Abramowitz, MD¹, Ricardo Komotar, MD⁴,

Michael Ivan⁴, Jacques Morcos⁴, Tejan Diwanji, MD¹; ¹University of Miami/Sylvester Comprehensive Cancer Center, Department of Radiation Oncology, ²University of Miami/Sylvester Comprehensive Cancer Center, ³University of Miami Miller School of Medicine, ⁴University of Miami, Department of Neurosurgery

Background: Guidelines recommend surveillance magnetic resonance imaging (MRI) every three months in asymptomatic patients with brain metastasis following treatment based on the majority of patients with central nervous system (CNS) disease-free survival (DFS) under one year (Patel SH, et al Am J Clin Oncol. 2012). Patients with long-term CNS DFS with brain metastasis treated with stereotactic radiosurgery (SRS) are an increasingly important population, but survival disparities and follow-up patterns are not established.

Objectives: Our objective is to evaluate disparities in survival and follow-up surveillance imaging in patients with brain metastasis treated with SRS with long-term CNS DFS.

TABLE 1. Patient Characteristics

Characteristic	Patients (N=55)
Age in years – median	60
Sex – n (%)	
Female	30 (54.5)
Male	25 (45.5)
Race/Ethnicity – n (%)	
Non-Hispanic White	35 (63.6)
Hispanic	13 (23.6)
Black	4 (7.3)
Other/Unknown	3 (5.5)
Income class – n (%)	
Lower	9 (16.4)
Middle	26 (47.6)
Upper	19 (34.6)
Unknown / International Patient	1 (1.8)
Primary Language – n (%)	
English	45 (81.8)
Spanish	10 (18.2)
Insurance – n (%)	
Private	34 (61.8)
Medicare/Medicaid	21 (38.2)
Religion – n (%)	
Catholic	14 (25.5)
Protestant	18 (32.7)
Jewish	7 (12.7)
Other	8 (14.5)
None	8 (14.5)
Karnofsky Performance Status – n (%)	
>70	49 (89.1)
≤70	6 (10.9)
Primary Site of Disease – n (%)	
Breast	11 (20.0)
Lung	24 (43.6)
Melanoma	9 (16.4)
Other Solid Cancer	11 (20.0)
Number of Treated Intracranial Lesions – n (%)	
0	12 (21.8)
1	27 (49.1)
2	6 (10.9)
>2	10 (18.2)
Number of Treated Post-Operative Cavities – n (%)	
0	38 (69.1)
1	15 (27.3)
2	2 (3.6)
Duration between radiation oncology visits during CNS DFS – n (%)	
<12 months	28 (50.9)
≥12 months	27 (49.1)
# MRIs of Brain after one year during CNS DFS – n (%)	
1	9 (16.4)
2-5	30 (54.5)
6-10	16 (29.1)
Last Known Vital Status – n (%)	
Alive	44 (80.0)
Dead	11 (20.0)
CNS Progression – n (%)	
Progression	11 (20.0)
No Progression	44 (80.0)
CNS Progression and Vital Status – n (%)	
Alive without CNS progression	37 (67.3)
Alive with CNS progression	7 (12.7)
Dead without CNS progression	7 (12.7)
Dead with CNS progression	4 (7.3)

CNS – central nervous system, DFS – disease free survival, MRI – magnetic resonance imaging

TABLE 2. Effect of Selected Variable on MRI Brain Frequency After One Year From SRS Treatment

Variable	Category	Univariable Analysis (UVA)		Multivariable Analysis (MVA)	
		RR (95% CI)	P-value	RR (95% CI)	P-value
Age	<60 years old	Reference		Reference	
	60-69 years old	0.91 (0.68, 1.22)	0.532	-	-
	≥70 years old	1.15 (0.83, 1.58)	0.408	-	-
Sex	Female	Reference		Reference	
	Male	1.32 (1.02, 1.70)	0.034	1.14 (0.81, 1.62)	0.456
Race/ethnicity	Non-Hispanic White	Reference		Reference	
	Hispanic	0.89 (0.65, 1.21)	0.448	0.88 (0.62, 1.25)	0.477
	Black	0.81 (0.49, 1.34)	0.421	0.75 (0.42, 1.34)	0.332
	Other	0.41 (0.20, 0.82)	0.013	0.59 (0.23, 1.49)	0.265
Income class	Low	Reference		Reference	
	Middle	0.67 (0.46, 0.97)	0.036	0.67 (0.44, 1.01)	0.057
	High	0.65 (0.44, 0.97)	0.037	0.65 (0.41, 1.04)	0.074
Primary language	English	Reference		Reference	
	Spanish	0.87 (0.61, 1.24)	0.447	-	-
Religion	Protestant	Reference		Reference	
	Catholic	1.04 (0.75, 1.45)	0.800	0.96 (0.65, 1.41)	0.824
	Jewish	1.05 (0.67, 1.66)	0.828	1.07 (0.66, 1.72)	0.794
	None	0.91 (0.62, 1.35)	0.636	0.84 (0.56, 1.27)	0.418
	Other	0.63 (0.41, 0.96)	0.032	0.79 (0.47, 1.33)	0.382
Insurance	Medicare/Medicaid	Reference		Reference	
	Private	0.82 (0.63, 1.06)	0.124	-	-
Karnofsky Performance Status	>70	Reference		Reference	
	≤70	1.19 (0.81, 1.73)	0.373	-	-
Primary Site of Disease	Lung	Reference		Reference	
	Breast	0.77 (0.54, 1.10)	0.155	-	-
	Melanoma	0.85 (0.61, 1.19)	0.345	-	-
	Other Solid Cancers	1.00 (0.69, 1.44)	0.998	-	-
	Number Treated Intracranial Lesions	0	Reference		Reference
1	0.96 (0.68, 1.35)	0.806	-	-	
2	1.10 (0.67, 1.80)	0.706	-	-	
>2	0.84 (0.57, 1.25)	0.396	-	-	
Number of Treated Post-Op Cavities	0	Reference		Reference	
	1	1.03 (0.78, 1.37)	0.818	-	-
	2	0.73 (0.32, 1.65)	0.447	-	-
Volume of Treated Intracranial Lesions	One unit increased	Reference		Reference	
		1.04 (0.99, 1.08)	0.115	-	-
Volume of Treated Post-Op Cavities	One unit increased	Reference		Reference	
		0.99 (0.95, 1.03)	0.675	-	-
Time Between Rad Onc Visits	0-12 months	Reference		Reference	
	>12 months	0.65 (0.49, 0.87)	0.003	0.72 (0.50, 1.02)	0.068

CNS- central nervous system, MRI – magnetic resonance imaging, Post-Op – Post Operative, Rad Onc – Radiation Oncology, RR – relative risk with Poisson regression analysis, SRS – stereotactic radiosurgery

Methods: We identified a cohort of 373 consecutive patients with brain metastasis treated with SRS in the definitive or postoperative setting at our institution from 9/2014 to 9/2019. Eligible patients had at least one year of CNS DFS from SRS treatment for newly diagnosed brain metastasis. Patient socioeconomic and disease characteristics were retrospectively collected. The MRI brain scans from one-year post-treatment during CNS DFS were collected with a Poisson regression univariable (UVA) and multivariable (MVA) analysis conducted to assess impact of select factors on imaging follow-up. Overall survival (OS) was calculated as time from SRS treatment to death. Survival was censored at death or last follow-up. Kaplan-Meier univariate analysis was conducted to assess impact of factors on OS. *P*-value of <0.05 was used for significance.

Results: 55 patients met eligibility criteria for inclusion in this study (median follow-up 2.48 years, median age at treatment 60 y). The median CNS disease-free survival and OS was not reached. 11 patients (20.0%) had intracerebral progression at median time of 2.26 years. A median of 4 MRIs were performed during CNS DFS after one year. On UVA, males (RR 1.32, *P*=0.034) had increased MRI frequency, whereas increased income (middle income RR 0.67, *P*=0.036; upper income RR 0.65, *P*=0.037) and more than 12 months between radiation oncology follow-ups (RR 0.65, *P*=0.003) were associated with lower MRI frequency. On MVA, there was a trend for radiation oncology follow-ups and income (*P*<0.10).

Conclusions: Patients with metastatic disease to the brain treated definitively or postoperatively with SRS who have CNS DFS at one year have a good prognosis. Factors that predict survival at time of treatment do not appear to be associated with survival in this selective

population. A low level of income and regular follow-ups with a radiation oncologist were associated with increased follow-up imaging frequency on UVA. While these findings did not remain significant on MVA, the cohort may be underpowered to detect this difference. We believe these findings warrant further investigation with a multi-institutional cohort (Tables 1 and 2).

(P138) Determining Factors of Salvage Radiation Therapy Modality for Distant Brain Metastasis Failure After Initial Stereotactic Radiosurgery

Yash Soni¹, Benjamin Rich, MD², Deukwoo Kwon, PhD³, Wei Zhao³, Danny John¹, Crystal Seldon, MD², Carolina Benjamin, MD⁴, Ronald Benveniste, MD⁴, Ricardo Komotar, MD⁴, Macarena De La Fuente, MD⁵, Maria del Pilar Prieto, MD⁵, Gregory Azzam, MD², Eric Mellon, MD², Matthew Abramowitz, MD², Tejan Diwanji, MD²; ¹University of Miami Miller School of Medicine, ²University of Miami/Sylvester Comprehensive Cancer Center, Department of Radiation Oncology, ³University of Miami/Sylvester Comprehensive Cancer Center, ⁴University of Miami, Department of Neurosurgery, ⁵University of Miami/Sylvester Comprehensive Cancer Center, Department of Neurology

Background: The likelihood of distant brain metastasis failure is increased in patients initially undergoing stereotactic radiosurgery (SRS) versus whole brain radiation therapy (WBRT) for brain metastasis (LeCompte MC, et al J Neurooncol 2020). Although the factors influencing survival outcomes have been studied extensively, those used to determine salvage reirradiation with SRS versus WBRT are unknown.

TABLE 1. Baseline Patient Characteristics by Salvage Therapy Type

Variable	Total		Salvage Treatment			
	N	%	WBRT		SRS	
	N	%	N	%	N	%
Total Patients	84	100.0	15	100.0	69	100.0
Age						
Median	59.6	-	59.7	-	59.5	-
Primary Malignancy						
Lung	43	51.2	9	60.0	34	49.3
Breast	17	20.2	4	26.7	13	18.8
Melanoma	6	7.1	-	-	6	8.7
Other	18	21.4	2	13.3	16	23.2
Gender						
Female	52	61.9	7	46.7	45	65.2
Male	32	38.1	8	53.3	24	34.8
Primary Language						
English	57	67.9	9	60.0	48	69.6
Spanish	27	32.1	6	40.0	21	30.4
Religion						
Catholic	30	35.7	7	46.7	23	33.3
Christian/Protestant	15	17.9	1	6.7	14	20.3
None	16	19.0	4	26.7	12	17.4
Other	23	27.4	3	20.0	20	29.0
Race/ethnicity						
Non-Hispanic White	35	41.7	5	33.3	30	43.5
Non-Hispanic Black	5	6.0	-	-	5	7.2
Hispanic	39	46.4	9	60.0	30	43.5
Asian/Other/Unknown	5	6.0	1	6.7	4	5.8
Income Level						
1 st quintile	-	-	-	-	-	-
2 nd quintile	24	28.6	4	26.7	20	29.0
3 rd quintile	41	48.8	7	46.7	34	49.3
4 th quintile	16	19.0	3	20.0	13	18.8
5 th quintile	2	2.4	1	6.7	1	1.4
Unknown	1	1.2	-	-	1	1.4
KPS						
≤70	6	7.1	1	6.7	5	7.2
>70	78	92.9	14	93.3	64	92.8
# sites of DBF						
1	33	39.3	1	6.7	32	46.4
2	16	19.0	2	13.3	14	20.3
≥3	35	41.7	12	80.0	23	33.3
Extracranial Disease						
Not progressing	26	31.0	4	26.7	22	31.9
Progressing	58	69.0	11	73.3	47	68.1
Systemic therapy status						
No active systemic therapy	14	16.7	1	6.7	13	18.8
Active systemic therapy	70	83.3	14	93.3	56	81.2
Brain metastasis velocity						
<4 per year	35	41.7	2	13.3	33	47.8
≥4 per year	49	58.3	13	86.7	36	52.2
Vital status at last follow-up						
Alive	45	53.6	4	26.7	41	59.4
Dead	39	46.4	11	73.3	28	40.6
Insurance						
Medicaid	8	9.5	-	-	8	11.6
Medicare	23	27.4	4	26.7	19	27.5
Private	51	60.7	11	73.3	40	58.0
Uninsured	2	2.4	-	-	2	2.9

WBRT: Whole Brain Radiation Therapy; SRS: Stereotactic Radiosurgery; DBF: Distant Brain Metastasis Failure; KPS: Karnofsky Performance Status Scale

Objectives: To determine the clinical and demographic characteristics associated with treating distant brain metastasis failure (DBF) with salvage SRS vs. salvage WBRT after initial SRS treatment.

TABLE 2. Effect of Selected Variable on Receipt of Salvage SRS or Salvage WBRT (WBRT = Reference)

Variable	Category	Univariate Analysis		Multivariate Analysis	
		OR (95% CI)	P-value	OR (95%)	P-value
Primary Cancer	Lung	Reference			
	Breast	0.86 (0.23, 3.29)	0.826		
	Melanoma	NE	NE		
Gender	Female	Reference			
	Male	0.47 (0.15, 1.44)	0.186		
Language	English	Reference			
	Spanish	0.66 (0.21, 2.06)	0.474		
Religion	None	Reference			
	Catholic	1.10 (0.27, 4.50)	0.900		
	Christian/Protestant	4.67 (0.46, 47.63)	0.194		
	Other	2.22 (0.42, 11.66)	0.346		
Ethnicity	Hispanic or Latino	Reference			
	NOT Hispanic or Latino	1.95 (0.63, 6.08)	0.250		
Race	White	Reference			
	Asian	1.02 (0.11, 9.84)	0.968		
	Black or African American	NE	NE		
Race/Ethnicity	Non-Hispanic White	Reference			
	Non-Hispanic Black	NE	NE		
	Hispanic	0.56 (0.17, 1.85)	0.339		
	Asian/Other/Unknown	0.67 (0.06, 7.25)	0.739		
Income Level	2 nd Quintile	Reference			
	3 rd Quintile	0.97 (0.25, 3.74)	0.966		
	4 th Quintile	0.87 (0.17, 4.52)	0.865		
	5 th Quintile	0.20 (0.01, 3.91)	0.289		
	Unknown	NE	NE		
KPS	≤70	Reference			
	>70	0.91 (0.10, 8.45)	0.937		
# sites of DBF	1	Reference		Reference	
	2	0.22 (0.02, 2.62)	0.230	0.26 (0.03, 2.39)	0.244
	≥3	0.06 (0.01, 0.49)	0.009	0.10 (0.01, 0.81)	0.031
Extracranial Disease	Not progressing	Reference			
	Progressing	0.78 (0.22, 2.72)	0.693		
Systemic therapy status	No active systemic therapy	Reference			
	Active systemic therapy	0.31 (0.04, 2.55)	0.275		
Brain met velocity	<4 per year	Reference		Reference	
	≥4 per year	0.17 (0.04, 0.80)	0.025	1.04 (0.16, 6.71)	0.971
Insurance	Private	Reference			
	Medicaid	NE	NE		
	Medicare	1.31 (0.37, 4.64)	0.660		
	Uninsured	NE	NE		
Age	Every one unit increased				
		0.99 (0.94, 1.04)	0.713		
Time to Salvage Therapy	Every one unit increased				
		1.00 (0.93, 1.06)	0.940		

WBRT: Whole Brain Radiation Therapy; NE: Not estimable; KPS: Karnofsky Performance Status Scale; DBF: Distant Brain Metastasis Failure

Methods: We identified a cohort of 374 consecutive patients with brain metastases treated with SRS in the definitive or postoperative setting, at a single institution, from August 2014 to September 2019. Eligible patients received subsequent salvage radiation at our institution with WBRT or SRS due to DBF at least one month after initial SRS. Clinical and demographic characteristics were retrospectively recorded. Univariate (UVA) and stepwise multivariate analyses (MVA) were performed to determine if there was an association between these factors and the use of salvage SRS versus WBRT. Odds ratios (ORs) and corresponding P-values were estimated from a logistic regression model. A survival analysis was also performed to assess the hazard ratio (HR) of these factors on survival. All tests were two sided and P-value of <0.05 was used for significance.

Results: A total of 84 patients (median age 59.6, median time to salvage radiation 5.4 months, median follow-up from initial treatment 1.45 years and 0.84 years from salvage treatment) met eligibility criteria for inclusion in this study. 69 patients received SRS and 15 patients received WBRT at the time of first DBF. The following factors were associated with decreased use of salvage SRS on UVA: ≥3 sites of DBF (OR 0.06, P=0.009) and brain metastasis velocity ≥4 (OR = 0.17, P=0.025). On MVA, ≥3 sites of DBF was associated with decreased use of salvage SRS (OR 0.07, P=0.012). There were no socioeconomic or other clinical factors associated with receipt of salvage SRS versus WBRT on UVA or MVA. Median overall survival from retreatment was 21 months. On MVA, progressing extracranial disease was associated with decreased survival (HR 2.96, P=0.018) and receipt of salvage SRS versus WBRT increased survival (HR 0.30, P=0.006).

Conclusions: In this analysis, the only factor independently associated with selection of salvage WBRT vs. SRS for DBF is the number of new intracranial lesions. This is congruent with current guidelines. No socioeconomic disparities were found to significantly influence modality of salvage therapy. In this cohort, salvage SRS was associated with a statistically significant improvement in OS; however, this may represent a selection bias. We await results of the accruing randomized trial NRG-BN009, which is evaluating these

salvage treatment modalities, for further guidance in this patient population (Tables 1 and 2).

(P139) CT-guided Interstitial HDR Brachytherapy Is a Safe and Effective Treatment Option for Central and Ultra-central Lung Malignancies

Stephanie Yoon, MD¹, Robert Suh, MD¹, Fereidoun Abtin, MD¹, Mitchell Kamrava, MD², Puja Venkat, MD¹, Alan Lee, MD¹, Albert Chang, MD, PhD¹; ¹University of California Los Angeles, ²Cedars-Sinai Medical Center

Background: Central lung tumors lie in close proximity to critical organs that, if untreated, can cause significant morbidity. Effective treatment options are limited with an increased risk for toxicity. CT-guided interstitial high-dose rate (HDR) brachytherapy is a relatively novel therapeutic option for lung malignancies, and has the potential to overcome limitations faced with current therapeutic options, such as image-guided thermal ablation or stereotactic body radiotherapy, for central lung tumors. Few institutions globally offer HDR brachytherapy for pulmonary malignancies with our institution, to our knowledge, being the first to offer this therapy in the United States.

Objectives: The aim of this investigation was to assess the long-term safety and efficacy of interstitial HDR brachytherapy for pulmonary malignancies.

Methods: From September 2015 to August 2019, 25 patients with 37 pulmonary tumors were treated with interstitial HDR brachytherapy. CT-guided placement of interstitial catheters was performed followed by radiation delivery. Twenty-three patients received a median total dose of 21.5 Gy (range, 15-27.5) in a single fraction. Two patients received median total dose of 24.75 Gy (range 24-25.5 Gy) over 2-3 fractions. Patients were followed every 3 months with chest CT and physical exam to assess tumor response and treatment-related toxicity.

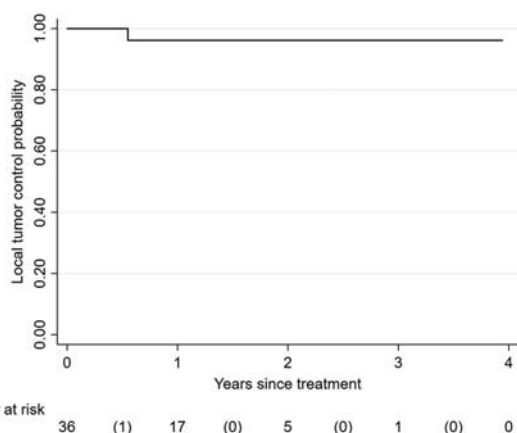

FIGURE 1. Kaplan-Meier curve for local tumor control.

TABLE 1. Rates of Procedural Complications and Treatment-related Toxicities Following CT-guided HDR Interstitial Brachytherapy Ablation

Procedural complication rate ¹	Total procedures (n=39)
Minor pneumothorax	13 (33.3%)
Major pneumothorax	4 (10.3%)
Pulmonary hemorrhage ²	1 (2.5%)
Acute toxic events	Total evaluable patients (n=22)
Grade 0	18 (81.8%)
Grade 1	2 (9.1%)
Grade 2	2 (9.1%)
Grade ≥ 3	0 (0%)
Late toxic events	Total evaluable patients (n=18)
Grade 0	18 (100%)
Grade 1	0 (0%)
Grade 2	0 (0%)
Grade ≥ 3	0 (0%)

¹All procedural complication rates self-resolved within 24 hours ² Pulmonary hemorrhage was grade 1

Descriptive statistics were reported for patient demographics, clinical features, procedural complications, and toxicity. Fisher’s exact test assessed the association between LC and several covariates. Kaplan-Meier method estimated local tumor control (LC), progression-free survival (PFS) and overall survival (OS).

Results: Of 37 treated tumors, 88% of patients had lung metastases. 24.3% and 54.1% of tumors were centrally and ultra-centrally located, respectively. Average tumor volume was 11.6 cm³ (SD 12.4, range 0.57-62.8). Median follow-up was 19 months (range 3-48). Two and 3-year LC were 96.2% (Fig. 1). No clinical or treatment covariates were associated with LC. Two and 3-year PFS were 29.7%. Two and 3-year OS were 65.5%. Thirteen of 39 (33.3%) procedures were associated with trace minor pneumothorax requiring no intervention, 4 (10.3%) procedures were associated with major pneumothorax requiring chest tube insertions, and 1 (2.5%) procedure with minor radiographic pulmonary hemorrhage. All procedural complications resolved within 24 hours from treatment (Table 1). Four patients developed acute grade 1-2 toxicity. No patients developed late toxicity.

Conclusions: CT-guided interstitial HDR brachytherapy is a safe and effective treatment. Brachyablation should be considered in the multi-disciplinary management of centrally-located pulmonary tumors.

(P140) Psycho-social Impact of COVID-19 on Hematologic Cancer Patients and Caregivers

Isabella Amaniera¹, Christina Bach, MSW, MBE, LCSW², Carolyn Vachani, MSN, RN, AOCN¹, Karen Arnold-Korzeniowski, BSN, RN¹, James Metz, MD¹, Christine Hill-Kayser, MD¹, Margaret Hampshire, RN, BSN, OCN¹, Marisa Healy, BSN, RN¹, Alexander Rodriguez¹, Courtney Misher, MPH,BSRT(T)¹, Laura Kendrick, MHA, BSRT(T)¹; ¹University of Pennsylvania, ²Oncolink

Background: Patients with hematologic cancers (HC) are at higher risk for severe Covid-19 infection, due to the nature of their disease and treatment. This risk is even higher for those undergoing transplant. At baseline, the HC population is at risk for increased feelings of isolation, psychosocial challenges, and financial distress.

Objectives: Further understand the impact of the COVID-19 pandemic on feelings of isolation, psychosocial challenges, and financial distress in the HC population.

Methods: An Internet-based survey was available on Oncolink.org over a 3-month period from April to June 2020. It was completed by a convenience sample consisting of individuals diagnosed with cancer over the age of 18 or their caregivers. Demographics, treatment-related variables, practical needs (transportation, caregiving responsibilities) financial impact (costs of cancer treatment, loss of a job, insurance, reduction in income) and factors surrounding access to food were collected.

Results: There were 281 respondents. Caregivers and patients with HC made up 37% of respondents (n=104). Of these, 89% were patients and 11% were caregivers. Age ranged from 28 to 81 (median 61). The majority of participants were White (87%) and lived in the United States (88%). Hematologic diagnoses included multiple myeloma (66%), non-Hodgkin lymphoma (17%), acute leukemia (5%), Waldenstrom macroglobulinemia (5%), chronic leukemia (4%), and Hodgkin lymphoma (2%). Most (76%) participants reported undergoing active cancer treatment, with 96% receiving chemotherapy (alone or combined with other therapies). In total, 37% of participants reported that their treatments were changed or delayed during this time period. Reasons for this change or delay of treatment included: decision by oncology team (63%), worry about COVID exposure at treatment center (13%), and worry about increased COVID risk related to treatment (11%). The majority of participants reported feeling increased social isolation (81%) since the beginning of the COVID19 pandemic, and reported that their mental health (worry, mood, sleep) was affected by the pandemic (70%). Those reporting feeling more socially isolated were also more likely to report negative impact on mental health ($P < 0.00001$). Participants reporting that COVID-19 was affecting their worry, mood and sleep were more likely to report an increase in expenses ($P = .003$) and reduced access to food ($P = .002$). They were also more likely to report COVID-19 impacting their ability to pay for their monthly expenses ($P < 0.005$).

Conclusions: Patients and caregivers with HC represented the top user group completing our survey. Our findings demonstrate that early in the pandemic, patients experienced treatment delays and changes. These patients reported feeling more socially isolated and this was related to compromised mental health. Our results also illustrate the interconnectedness between mental health and practical needs. As we emerge from the pandemic, oncology providers should be aware of the lingering effects of social isolation and how this impacts mental health.

(P141) Standardization of PRISMA-Based Systematic Review Practices for American Radium Society Appropriate Use Criteria Guidelines

Christopher Anker, MD¹, Jonathan Beitler, MD, MBA², Kristina Novick, MD, MS³, Sue Yom, MD, PhD, MAS⁴, William Small, MD, FACRO, FACR, FASTRO⁵, Karen Heskett, MSI⁶; ¹University of Vermont Larner College of Medicine, Division of Radiation Oncology, ²Knox County Health Clinic, ³University of Pennsylvania, ⁴University of California, San Francisco, ⁵Loyola University Chicago, Stritch School of Medicine, Cardinal Bernardin Cancer Center, ⁶University of California San Diego

Background: The American Radium Society (ARS) Appropriate Use Criteria (AUC) Committees consist of disease-site expert panels that provide modified Delphi-derived treatment guidelines based on a rigorous review of the literature. The Preferred Reporting Items for Systematic Reviews and Meta-Analyses (PRISMA) guidelines have established methodologic standards for systematic reviews, including most recently via the 2020 statement (Page, et al BMJ 2021) and accompanying explanation and elaboration document (Page, et al BMJ 2021). However, adherence to PRISMA guidelines is variable among publications noting their use.

Objectives: Standardize systematic review methodology to improve reproducibility, quality, and transparency of the ARS AUC guideline development process.

Methods: To tailor the PRISMA 2020 checklist to the ARS AUC methodology, we performed an extensive analysis of resources

TABLE 1. American College of Radiology (ACR) Study Quality Rubric

	Category 1	Category 2	Category 3	Category 4 (Not useful as primary evidence)
Description of Prospective, Post-Hoc, or Retrospective Studies	The study is well designed and accounts for common biases with 5-6 study quality elements present	The study is moderately well designed and accounts for most common biases with 3-4 study quality elements present.	The study has important study design limitations with only 1-2 study quality elements present.	The article may not be a clinical study or the study design is invalid.
Clarifying Details about study quality elements	<input type="checkbox"/> Statistical measures (e.g., odds ratios, survival rates/curves, hazard ratios, mean or median, etc.) <input type="checkbox"/> Uncertainty measure/range (e.g., standard errors, confidence intervals, percentiles, power calculations for sample size, etc.) <input type="checkbox"/> Prospective study <input type="checkbox"/> Allocation of subjects into control & intervention groups. <input type="checkbox"/> Random allocation of subjects into groups. <input type="checkbox"/> Length of follow-up (e.g., length of follow up, survival rates, recurrence rates, toxicity rates, etc.) <input type="checkbox"/> Accounts for all study subjects. <input type="checkbox"/> Retrospective studies only: Study population must reflect the population targeted by the study question. <input type="checkbox"/> Retrospective studies only: Adequate workup and appropriate length and quality of follow up.			Not a hypothesis-based clinical study (e.g. book chapter, consensus document, case report or case series description); or The study may synthesize and draw conclusions about several studies such as a literature review article or book chapter but is not primary evidence.
Category M				
Meta-analysis	Meta-analysis studies are not rated for study quality using the study element method because the method is designed to evaluate individual studies only. An "M" for the study quality will indicate that the study quality has not been evaluated for the meta-analysis study.			

available on the EQUATOR network (Enhancing the QUALity and Transparency Of health Research), assessing the PRISMA documents as well as the The Cochrane handbook (<https://training.cochrane.org/handbook>, accessed March 29, 2021).

Results: The essential elements of the PRISMA 2020 checklist that pertain to ARS AUC procedures were defined. A topic proposal document based on PRISMA-P is submitted for approval to the Disease-Site Committee Chair and the Steering Committee before reference screening. Topic proposals will use the Cochrane FINER Criteria (Feasible, Interesting, Novel, Ethical, and Relevant) to formulate focused PICOTS (Population, Intervention, Comparison, Outcome, Timing, Study type) question(s). The search strategy must be optimized through consultation with a librarian or information specialist. The search must involve ≥ 1 databases, including Medline (via Ovid or PubMed) and Embase (strongly recommended). To confirm the search's sensitivity we suggest checking results against a pre-selected validation set of articles. Article titles/abstracts must be reviewed by ≥ 2 reviewers and full text by at least 1. Backward citation searching (from references within the selected articles) and forward citation searching (for papers that cite the selected articles) is encouraged. Study quality rating using modified American College of Radiology (ACR) definitions will be assigned by ≥ 2 reviewers (Table 1). Certainty assessment will be defined via ACR "Strength of Evidence" and "Strength of Recommendation" categorization. The final publications are to include the search strategies reported in full, the PRISMA 2020 flowsheet detailing the record selection process, and the PRISMA 2020 checklist.

Conclusions: We have redefined the ARS AUC guideline development process using PRISMA 2020 documents, including the checklist. The resulting reproducibility and transparency will increase the quality of ARS AUC guidelines.

(P142) Normal Pressure Hydrocephalus: A Reversible Late Side-Effect of Whole Brain Radiation

Abigail Copella, MD¹, Scott Shepard, MD², Elizabeth Handorf, PhD¹, Shelly Hayes, MD¹, Stephanie Weiss, MD¹; ¹Fox Chase Cancer Center, ²Temple University Hospital

TABLE 1. Response to Shunting Intervention

Patient	WBRT to NPH Dx (mos)	Presenting NPH Sx	Gait	Cognition	Urinary	Sx at relapse	Time to sx relapse (mos)	Followup without relapse (mos)
1	63	G,C,U	Y	Y	Y	NA	NA	17
2	37	G,C,U	Y	Y	Y	G,C	8	NA
3	40	G,C,U	Y	Y	Y	G	7	NA
4	7	G,C	Y	N	NA	G	1	NA
5	148	C,U	NA	N	Y	NA	NA	17

NA = not applicable; Dx = Diagnosis Sx = Symptoms; Mos = months.

Background: Whole brain radiotherapy (WBRT) remains widely used despite the emergence of radiosurgery (SRS) for treatment of metastatic disease to the brain (Barbour A, et al *Advances in Radiation Oncology* 2019; Modh A, et al *IJROBP* 2017). Attempts to minimize late effects of WBRT typically involve alternative planning and dosing strategies. Recently a significant improvement in time to neurocognitive decline was observed with hippocampal avoiding WBRT (HA-WBRT) but surviving patients remain at risk for long term sequelae of treatment (Gondi V, et al *IJROBP* 2018). High dose per fraction has long been recognized as a predictor for a clinical syndrome hallmarked by “progressive dementia, ataxia and urinary incontinence” in long-term survivors (Deangelis L, et al *Neurology* 1989). Dementia, gait disturbance and urinary incontinence are the classic triad associated with normal pressure hydrocephalus (NPH), which can be diagnosed through a lumbar drain trial (Williams M, et al *Continuum* 2016), and may be reversible in up to 80% of patients through ventriculoperitoneal (VP) shunting (Toma AK, et al *Epub* 2013). Because survival after diagnosis of brain metastasis has improved significantly over the past decade (Sperduto P, et al *JAMA Oncology* 2017), interventions that reverse long-term treatment-related toxicity are valuable.

Objectives: Describe value to patients of VP shunting for NPH after receipt of WBRT for brain metastases.

Methods: Patients who underwent WBRT at an NCI Comprehensive Cancer Center were retrospectively cross-matched to a list of patients who underwent therapeutic VP shunt for NPH between January 1 2016 and January 31 2020. All patients were referred by a CNS specialist in radiation oncology to a neurosurgeon for clinical suspicion of NPH including new or progressive symptoms of magnetic gait (G), cognitive changes (C), and/or new onset of urinary incontinence (U). NPH was confirmed via large volume lumbar drain in all patients before shunting. Five patients were identified and constitute the subjects of this report. All patients were scored as either having (Y) or not (N) symptoms of G, C and U at diagnosis of NPH, and at post-shunting follow-ups. Time to any symptom failure or last follow up was calculated.

Results: Median time from WBRT to presentation of symptoms suggesting NPH was 40 months (Range, 7-148m). The majority of patients were found to have improvement in all presenting symptoms. Patients 4 and 5 did not achieve improvement in cognition with VP shunt. Two patients were found to have durability of symptom improvement at time of analysis. Three patients experienced relapse of symptoms after VP shunt placement with median time to shunt failure being 7 months (Range, 1-8m).

Conclusions: NPH is a potentially reversible late side effect of VP shunting may achieve complete or partial relief of symptoms in these patients and should be considered in the follow-up of long-term survivors with cognitive, gait and urinary changes after WBRT (Table 1).

F. Graham Cancer Center Christiana Care Health System, ⁴Department of Radiation Oncology, Brigham and Women's Hospital and Dana-Farber Cancer Institute, Harvard Medical School

Background: Although brachytherapy (BT) plays a critical role in cancer treatment (Holschneider CH, et al *Brachytherapy* 2019), recent data shows a decline in utilization and underrepresentation of women and early-career providers (Valle LF, et al *JCO Oncol Pract* 2021; Lu DJ, et al *Brachytherapy* 2019). Resident surveys have cited lack of exposure during training as a cause of decreased comfort, with an interest in on-the job training (Marcrom S, et al *Brachytherapy* 2018). These findings highlight the importance of a targeted approach toward ensuring an adequate supply of brachytherapists.

Objectives: The purpose of this analysis is to describe the experiences and obstacles to BT practice reported by mentees, before and within the first few months of participation, in a national mentorship program. We hypothesize that structured access to experienced mentors for early-career practitioners can provide a venue to address obstacles and increase BT exposure and comfort.

Methods: #NextGenBrachy was prospectively developed as a virtual mentorship program to allow for flexible communication and ongoing collaborations between experienced BT mentors and early-career mentees. The goal was to serve as an on-the-job virtual training platform, with a secondary goal of increasing representation of women and early-career practitioners. An anonymous REDCap survey was sent to mentees, within the first few months of program initiation. A Linkert-type 5-point scale was used to measure initial BT comfort and confidence. Free text responses provided additional descriptive data.

Results: A total of 13/17 mentees completed the survey (76% response). Mentees were 82% female and 82% in their final year of residency or had completed training within the last 4 years. Comfort and confidence of participants was highest in performing gyn BT and least in prostate BT, with prostate HDR having the lowest level of comfort or confidence among participants. For open ended questions regarding obstacles, qualitative data analysis revealed multiple themes: difficulties or lack of access in obtaining mentorship, obstacles with networking, and lack of knowledge or awareness of available resources. In regards to what participants hoped to gain, recurring themes included: the ability to lead a BT program, comfort and competence with BT, improved networking, and increased participation on a national level. The majority (76%) reported feeling minimally connected to the BT community and none reported a leadership position in a national BT association.

Conclusions: Although the declining trends in BT use are multifactorial, targeted mentorship programs, such as #NextGenBrachy, can serve as a catalyst to increase BT utilization and diversity. Future work is needed to evaluate the overall impact of such programs and to develop solutions to increase awareness regarding the impact of mentorship in creating and sustaining a representative workforce that provides standard of care to all patients.

(P143) Mixed Methods Evaluation of #NextGenBrachy: A Targeted Mentorship Program to Increase Competence, Comfort, and Representation in Brachytherapy

Idalid Franco, MD, MPH¹, Daniel Petereit, MD², Firas Mourtada, PhD³, Lisa Singer, MD, PhD⁴; ¹Harvard Radiation Oncology Program, ²Monument Health Cancer Care Institute at Monument Health, ³Helen

(P144) Radiation Oncology Practice Size Consolidation

Brian Baumann, MD¹, Jacob Hogan, BS², Amit Roy, MD³, Jordan Pollock, BS⁴, John Baumann, MD⁵, Hiram Gay, MD¹, Carlos Perez,

MD⁶; ¹Department of Radiation Oncology, Washington University School of Medicine in St. Louis, ²Washington University School of Medicine, ³Washington University in St. Louis, ⁴Mayo Clinic, ⁵Princeton Radiation Oncology, ⁶Washington University in St. Louis, Department of Radiation Oncology

Background: In recent years, there has been evidence of practice consolidation in US healthcare. To our knowledge, a detailed quantitative study of recent changes in radiation oncology practice size has not been performed.

Objectives: We aim to evaluate radiation oncology practice size changes between 2012 and 2020 in the US overall, for all regions, and for both male and female physicians.

Methods: Using the Medicare Physician Compare Database, we identified practices employing radiation oncologists using their Taxpayer Identification Number and individual radiation oncologists using their National Provider Identifier. We assigned physicians with multiple practice affiliations to the practice with the largest size. Practice size includes the number of physicians of any specialty employed at that practice, not just radiation oncologists. We compared the number of individual radiation oncologists and the number of practices in each practice size category between 2012 and 2020. Further analysis by US census region and sex were performed. Cochran-Armitage test for trend was used to detect significant differences.

Results: Between 2012 and 2020, the total number of practicing radiation oncologists identified increased by 9% (4,300 to 4,679) while the number of practices employing radiation oncologists decreased by 11.5% (1,606 to 1,422). The number of radiation oncologists in practices of size 1-2, 3-9, 10-24, and 25-49 decreased by 3.7%, 4.7%, 4.9% and 2%, respectively, while the number of radiation oncologists in practices of size 50-99, 100-499, and 500+ increased by 1.4%, 2.1%, and 11.8%, respectively (all 500+ practices are multi-specialty groups). The increase in practice size at both the individual and practice levels

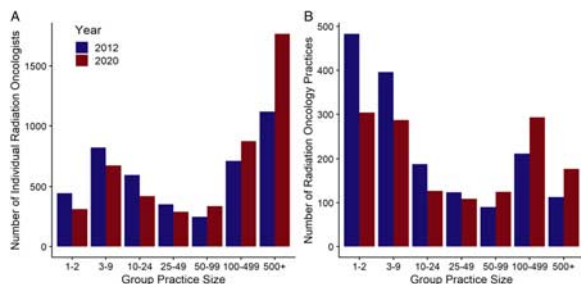

FIGURE 2. Bar plot of overall changes in group practice size. Bar plot showing (A) the number of radiation oncologists and (B) the number of group practices in each size category for 2012 and 2020.

was consistent in all regions and for both genders (FDR-adjusted $P < 0.001$ in all cases).

Conclusions: Our analysis provides objective evidence that practice size consolidation is occurring within the US Radiation Oncology workforce. The potential implications of practice consolidation for physicians and patients should be considered by specialty leaders, hospital administrators and government officials when determining future financial policy (Figs. 1 and 2).

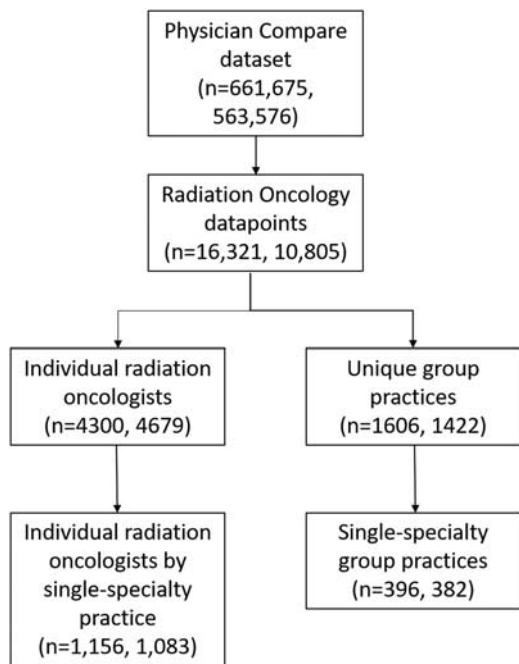

FIGURE 1. Physician selection flowchart. Flowchart of physician selection using the Physician Compare dataset (n=number in 2012, number in 2020).

(P145) Feasibility of a Phase II Study Utilizing Spatially Fractionated Radiation Therapy for Bulky or Radio-resistant Tumors of the Head and Neck, Thorax, Abdomen, Pelvis, and Extremities

Elizabeth Jeans, MEd, MD¹, Michael Grams, PhD¹, Randi Finley, CMD¹, William Breen, MD¹, Dawn Owen, MD, PhD¹, Sean Park, MD, PhD¹, Bradley Stish, MD², Scott Lester, MD¹, Ivy Petersen, MD¹, Safia Ahmed, MD¹, Kimberly Corbin, MD¹, Mark Waddle, MD¹, Michael Haddock, MD¹, Kenneth Merrell, MD¹, Christopher Hallemeier, MD¹, Nadia Laack, MD¹, Daniel Ma, MD¹; ¹Mayo Clinic, Rochester, ²Mayo Clinic Rochester

Background: Spatially fractionated radiotherapy (SFRT), the modern-day implementation of grid therapy, delivers a heterogeneous dose, consisting of high-dose distribution of “hotspots” interspersed with low dose “valleys”, to a designated target volume.

Objectives: Bulky or radioresistant tumors have specific treatment challenges. SFRT allows for high dose delivery with sparing of closely approximated tissues and the potential to stimulate the radiation-induced bystander effect and non-specific immune system cells. This study reports the feasibility of developing and accruing to a prospective institutional protocol utilizing SFRT for curative or palliative purposes.

Methods: Patients are registered to a curative- or palliative-intent arm. SFRT delivery options include a brass aperture to deliver a static field or lattice SFRT, utilizing VMAT. SFRT technique, dose, and optional consolidative radiotherapy dose/fractionation are prescribed at physician’s discretion. The primary outcome is radiographic local control rate, utilizing RECIST criteria, at 3 - 6 months. The secondary objectives include acute and late adverse event profile by assessment of grade 3 or higher adverse events (NCI-CTCAE version 5 criteria), overall survival, regional progression, and distant disease control. An enrollment of 120 patients, 70 palliative and 50 definitive, is planned based on a 95% exact binomial confidence interval for local failure rate of $\leq 10\%$ (curative), $\leq 30\%$ (palliative) and an estimation of adverse (grade 3+) events within 90 days of $\leq 5\%$. Patient disease and treatment-related characteristics, as well as follow-up details, including disease site-specific patient reported outcomes are maintained in a prospective database.

TABLE 1. Disease Site and Median Tumor Size

Site	Number (%)	Median Size (cm) [IQR]
Head and Neck	5 (21%)	7.0 [5.7 – 10.0]
Thorax and Breast	5 (21%)	14.0 [7.05 – 14.8]
Abdomen	6 (25%)	10.0 [9.25 – 18.6]
Pelvis	8 (33%)	8.7 [6.7 – 12]
Extremity	0	-

Results: From 01/2020 until 01/2021, 24 patients have been accrued and received palliative (n=19) or curative (n=5) SFRT. Tumor location and size are listed in Table 1. Median dose of SFRT was 20 Gy in a single fraction [range, 18 Gy–25 Gy]. Twenty-one patients received VMAT SFRT and 3 patients received brass aperture SFRT. All curative patients received consolidative RT 1-2 weeks following SFRT to a median of 57.5 Gy in 25 fractions [35–62.5 Gy, 10–25 fractions], EQD2 median 58.9 Gy [39.4 Gy–65.1 Gy, α/β ratio 10]. Eleven palliative patients (58%) received consolidative RT to a median of 30 Gy in 5 fractions [20–30 Gy, 3–5 fractions], EQD2 median 40.0 Gy [27.7 Gy–40.0 Gy, α/β ratio 10]. For the patient's enrolled to date, median follow-up is 4.1 months.

Conclusions: This ongoing prospective trial accruing patients with radioresistant and bulky tumors for treatment with SFRT demonstrates feasibility. Continued follow-up is necessary to determine efficacy and safety of SFRT. An understanding of appropriate selection for patients undergoing SFRT is warranted. Co-enrollment on a sister study analyzing pre- and post-RT frozen biospecimens for immune cell subtypes may help to elude underlying mechanisms of SFRT and appropriate selection of patients, alongside sequencing of optimal adjunct therapies.

(P146) Global Health Opportunities in US Radiation Oncology Programs

Amy Le, MD¹, Jordan Holmes, MD, MPH¹; ¹Indiana University Department of Radiation Oncology

Background: The incidence of cancer has increased in low- and middle-income countries (LMIC), however, many countries have limited access to cancer care with inadequate resources (Jemal A, et al Cancer Epidemiol Biomarkers Prev 2010). There is a need to train global oncologists to work with colleagues in LMIC to assist with local capacity-building efforts and develop sustainable infrastructure for clinical oncology care, education, and research. There is growing awareness of the benefits formal training in global health provides however formalized training and career pathways have been slow to emerge in radiation oncology.

Objectives: The purpose of this study was to explore the extent of online information on global health education available to potential US radiation oncology residency program applicants. We hypothesized that the majority of US radiation oncology programs do not have formal training in global oncology or do not provide the information to prospective applicants in an accessible manner via internet resources.

Methods: Residency program websites were reviewed for 89 US radiation oncology programs. The homepages and residency program portion of the websites were examined for specific mention of international or global health initiatives, rotations, research collaborations, or dedicated programs. Results were compared with prior report based on data from the Association of Residents in Radiation Oncology (ARRO) and the 2018 ARRO Global Health Resident Survey.

Results: Program websites for 76 programs (85.4%) had no information available on global health education, 3 websites (3.4%) mentioned potential for involvement in general global health initiatives, 5 websites (5.6%) described international rotations (including 2 in non-LMIC), 1 website (1.1%) described international research collaborations, and 4 websites (4.5%) provided evidence of a global health track or program. The websites for some residency programs did not include information on the international opportunities they offered (5 websites, 5.6%), based on comparison with report from ARRO and the 2018 ARRO Global Health Resident Survey which identified 11 programs with global health initiatives

based on active resident and faculty involvement in global health opportunities and focus on LMIC (Li BC, et al Glob Onco 2021).

Conclusions: A few radiation oncology residency programs had a dedicated global health track or program detailed on the program website, while several others described international collaborations or rotations. Some programs did not include information on the program website about global health opportunities, running the risk of failing to attract global health-minded applicants. Expansion of more formalized training would allow for more radiation oncology residents to enrich their global health perspective and gain experience for a career in global oncology.

(P147) Emergency Department Presentations for Radiation Cystitis Among Patients with a History of Prostate Cancer

Victor Lee, BS¹, James Yu, MD, MHS¹, Henry Park, MD, MPH¹, Vikram Jairam, MD¹; ¹Yale School of Medicine

Background: Radiation therapy is often used to treat abdominopelvic cancers such as prostate, cervical, uterine, and rectal cancer. Radiation cystitis (RC) is a known complication of radiation therapy to the pelvic area that can manifest years after initial treatment.

Objectives: We aim to shed light on the national burden of RC and identify patients who at increased risk of requiring invasive measures to manage this complication.

Methods: The Nationwide Emergency Department Sample was queried for patients with prostate cancer who presented to the emergency department (ED) from 2006 to 2015 for a primary diagnosis of radiation cystitis. Visits associated with the use of an invasive procedure (transurethral procedures and cystectomies) were further identified. Baseline demographic, socioeconomic factors, and hospital characteristics were compared between patients receiving and not receiving invasive procedures using the χ^2 test for categorical variables, and the Mann-Whitney U or analysis of variance tests for continuous variables. Multivariable logistic regression was used to identify factors associated with the receipt of invasive procedures. Weighted frequencies were used to create national estimates for all data analysis.

Results: Between 2006 and 2015, a weighted total of 17,456 ED visits occurred for RC among patients with a prostate cancer history, of which 5,925 (33.9%) were treated with an invasive procedure. ED visits associated with invasive procedures were more likely to also be associated with hypertension (53.3% vs 48.9%), inpatient admission (98.7% vs 86.2%), longer length of stay (6.6 d vs 4.6 d), and higher median total charges compared with visits without an associated invasive procedure (\$36,213.00 vs \$19,166.70) compared with those without invasive procedures. On adjusted analysis, factors associated with undergoing an invasive procedure included hospital location in the Northeast compared with Midwest (odds ratio [OR], 1.34; 95% confidence interval [CI], 1.04-1.73), having metastatic cancer (OR, 1.46; 95% CI, 1.05-2.04), hypertension (OR, 1.31; 95% CI, 1.10-1.55), and a history of prostatectomy (OR, 2.96; 95% CI, 1.86-4.70).

Conclusions: In conclusion, radiation cystitis can be a significant complication of prostate cancer among patients who undergo radiation therapy. Approximately one third of ED visits for radiation cystitis are treated with an invasive procedure, and patients with metastatic cancer, hypertension, and a prior prostatectomy may be at particularly high risk. While radiation remains a safe and effective treatment for patients with prostate cancer, providers should be mindful of radiation cystitis as a potential complication requiring procedural intervention, as severe cases could lead to significant bleeding or anemia. Patients at greatest risk for this complication should be monitored closely in the outpatient setting.

(P148) Geospatial Disparities in Access to Proton Therapy in the Continental United States

Luke Maillie¹, Stanislav Lazarev, MD², Charles Simone, MD, FACRO³, Matthew Sisk, PhD⁴; ¹Icahn School of Medicine at Mount Sinai, ²Mount Sinai, ³New York Proton Center, ⁴University of Notre Dame

Background: Proton therapy (PT) is increasingly recognized as an important component of therapy for select cancers due to its negligible

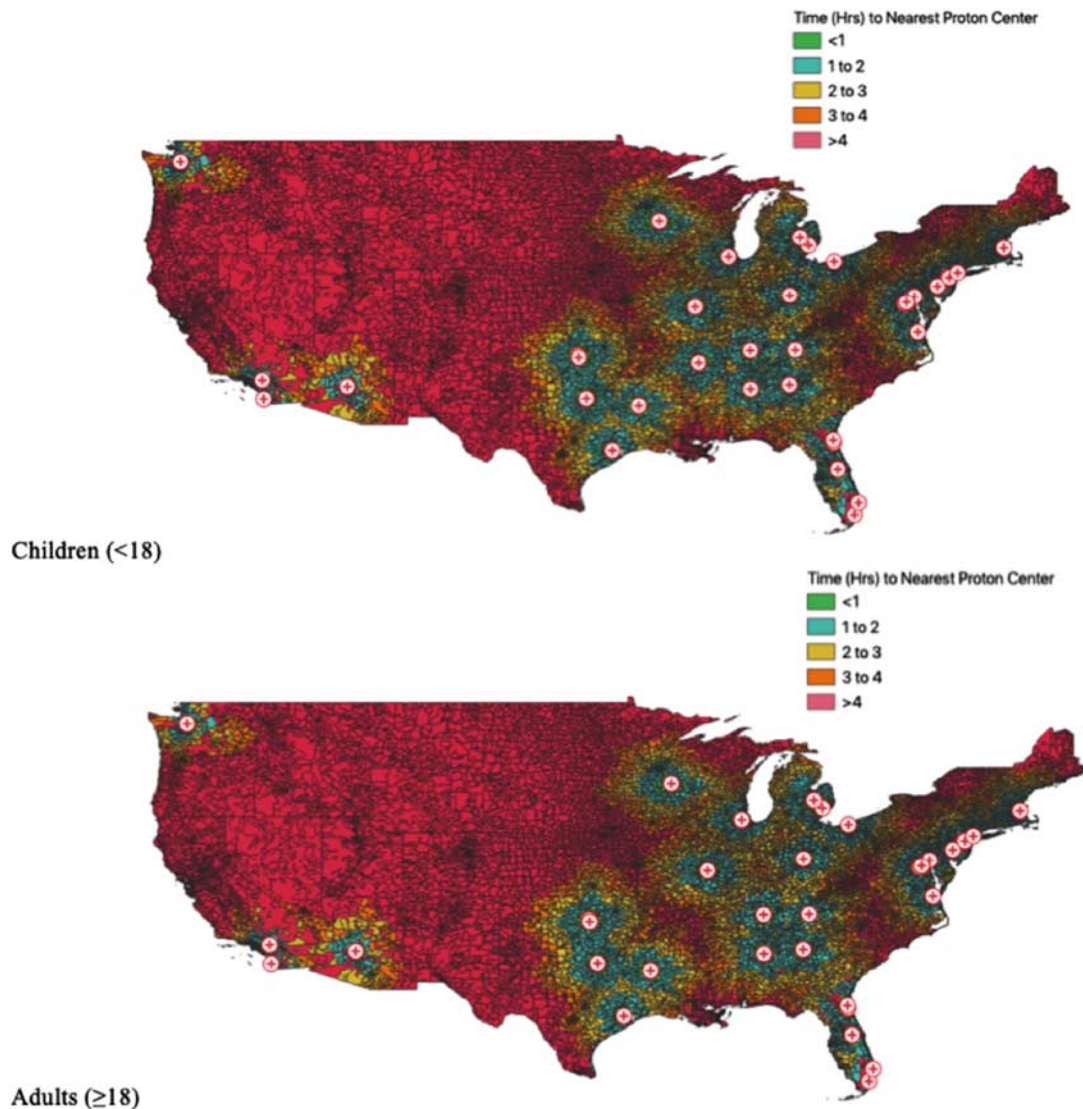

FIGURE 1. Time to the nearest PT center for children and adults. The boundary of each ZCTA in the mainland U.S. is shown.

exit dose and, as a result, improved normal tissue sparing and lower risk of adverse effects compared with conventional photon-based radiotherapy techniques. It is often purported that due to the existence of relatively few centers in the continental United States (US), inequities in access to PT may be present, however no formal study of geospatial access to proton centers has been conducted to date.

Objectives: This study examined access to PT in the continental US by quantifying travel time to PT centers.

Methods: Population data from 2014-2018 were available for 320.7 million people in 32,644 zip code tabulation areas (ZCTAs) in the continental US. Addresses for all PT centers in operation were geocoded. ArcGIS Pro Mapping software was used to determine travel time from the center point of each ZCTA to the nearest PT center. Two models were constructed, one for adults (≥ 18 y) and one for children (< 18 y) due to one proton center being available only for children. Data on age, race, health insurance status, household income, educational attainment, and geographic area were also analyzed.

Results: A total of 36 proton centers were identified in the continental US. The median travel time was 1.61 (IQR 0.67-3.36) hours for children and 1.64 (IQR 0.69-3.33) hours for adults. 35.7% of children and 34.7% of adults were found to live within one hour of the nearest PT

center, while 29.0% of children and 29.1% of adults were found to live over three hours from the nearest PT center. Significant variation in travel time to the nearest PT center was observed between states, with 11 states having a median travel time of less than 1 hour and 20 states having a median travel time of over 3 hours. Catchment, defined as the population located closest to a facility, varied widely between facilities with a median of 5.71 (IQR 3.75-9.30) million per facility for adults and 1.45 (IQR 1.02-2.75) million per facility for children. The West has a longer median travel time of 3.51 (IQR 1.15-7.13) hours when compared with the Midwest (1.70, IQR 0.79-2.69), South (1.60, IQR 0.61-3.12), and Northeast (1.04, IQR 0.57-2.01). Native Americans were seen to live at further distances when compared with other races. Households within the highest income quartile were observed to live closer to PT centers when compared with lower income quartiles. Time to nearest proton center did not differ significantly based on insurance status or education level.

Conclusions: Average travel time to the nearest PT center is high, and travel times vary significantly based on the state of residence. While being from the West or being Native American confers a higher median travel time and being in the highest income quartile confers a lower median travel time, travel time does not significantly vary based on

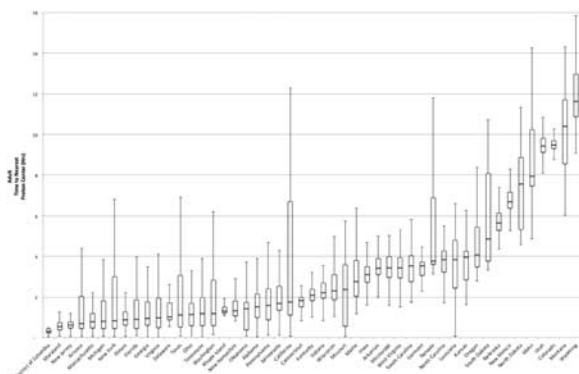

FIGURE 2. Time to the nearest PT center by state for adults. States are shown in order of increasing median travel time to nearest PT center.

health insurance status or educational attainment. Disparities in geographic access for certain populations warrant further examination to improve access to this important cancer treatment modality (Figs. 1, 2 and Table 1).

(P149) OncMonic: A Novel Visual Proprietary Study Paradigm for the Oncologist-in-training

Gohar Manzar, MD PhD¹; ¹The University of Texas MD Anderson Cancer Center

TABLE 1. Time to Nearest PT Center Based by Demographic Variables

	Median (IQR)	Pop. in Millions (%)
Age		
<18	1.61 (0.68-3.35)	73.1 (22.8)
18-39	1.62 (0.65-3.35)	95.5 (29.8)
40-64	1.62 (0.69-3.30)	103.2 (32.2)
≥65	1.74 (0.76-3.34)	48.9 (15.3)
Region		
Northeast	1.04 (0.57-2.01)	44.3 (17.9)
Midwest	1.70 (0.79-2.69)	52.4 (21.2)
South	1.60 (0.61-3.12)	93.9 (37.9)
West	3.51 (1.15-7.13)	57.0 (23.0)
Race		
White	1.79 (0.78-3.42)	234.1 (73.0)
Black	1.08 (0.51-2.72)	40.9 (12.7)
Hispanic	1.36 (0.58-3.54)	57.3 (17.9)
Asian	1.07 (0.52-3.35)	17.0 (5.3)
Native American	2.99 (1.33-5.32)	2.6 (0.8)
Health Insurance		
Insured	1.64 (0.69-3.34)	286.3 (90.6)
Not Insured	1.60 (0.63-3.36)	29.6 (9.4)
Income Quartile		
<\$46,676	2.05 (0.99-3.47)	-
\$46,677-\$59,167	2.02 (0.86-3.59)	-
\$59,170-\$78,331	1.57 (0.68-3.30)	-
>\$78,333	0.98 (0.57-2.40)	-
Education		
No High School	1.60 (0.67-3.34)	26.8 (12.4)
High School	1.74 (0.77-3.27)	58.9 (27.1)
Some College	1.74 (0.74-3.47)	62.9 (29.0)
College	1.50 (0.62-3.26)	42.2 (19.4)
Advanced	1.38 (0.58-3.14)	26.2 (12.1)

Comparison of access to PT by demographic and geographic characteristics in the continental US.

Background: In recent years, a new generation of visual mnemonic learning devices has emerged to assist with medical education for board licensure examinations. SketchyMedical¹ and Picmonic² have revolutionized the study of pathophysiology, microbiology, and pharmacology. The use of such memory anchor devices has demonstrated increased long-term memory retention by 331% and an improvement in test scores after one week by 50% among medical students in a randomized double-blind controlled study¹. The basis for this is a dual coding phenomenon whereby distinct verbal and visual pathways to encode information diversifies the basis for recall, as well as the Von Restorff effect, whereby a potentially stimulated sensorium offers superior context for layering memory as compared with plain bulleted texts. There is a general lack of embracement of such pedagogical innovation among medical sub-specialties. Oncology is an ideal candidate for supplementation of traditional study approaches with the exponential increase in data and its meaningful utilization in multidisciplinary tumor boards to guide clinical decision making, particularly in the space of clinical trials.

Objectives: To develop and validate an assistive visual mnemonic paradigm for the study of major clinical trials under the domain of radiation oncology.

Methods: An IRB proposal will investigate the recall of landmark clinical trials presented with the use of pictorial mnemonics among clinical radiation oncology residents participating in a weekly didactic seminar series. A separate clinical trial included within the same presentation by the same speaker without the visual assistive device will serve as the internal control.

Results: A survey will be collected among consenting residents immediately post-seminar, one week post-seminar, and eight weeks post-seminar. Metrics for recall of specific symbolic cues will include the study name or acronym, primary and/or secondary outcomes of the trial, and clinical criteria the study generated. Statistical analysis will be conducted using a Student’s t test.

Conclusions: Rich visual tools are transforming medical education with less reliance of traditional lackluster memorization. Embracing such pedagogical advances within radiation oncology by leveraging proven research in memory recall will empower residents to better utilize the vast array of data at their disposal and may potentially influence clinical dispositions.

(P150) Optimizing Practical Implementation of Automated Radiotherapy Treatment Planning Tool: A Survey

Gwendolyn McGinnis, MD, MS¹, Matthew Ning, MD, MPH², Remigio Makufa, MS³, Carlos Cardenas, PhD², Surbhi Grover, MD⁴, Laurence E. Court, PhD², Grace Smith, MD MPH²; ¹UT MD Anderson Cancer Center, ²MD Anderson Cancer Center, ³Gaborone Private Hospital, ⁴University of Pennsylvania

Background: Low-to-middle income countries (LMIC) have inequitable access to radiation treatment secondary to shortages in both available technology and personnel training. The use of automated planning software can lessen this disparity. The Radiation Planning Assistant (RPA) is an automated treatment-planning tool designed for limited resource environments. In anticipation of international deployment, understanding practical implementation of the RPA in LMIC is critical to optimizing its value.

Objectives: We conducted a survey to better characterize the optimal approach to RPA deployment in LMIC clinical settings.

Methods: Providers in three countries expressing interest in piloting RPA were approached for survey participation, with 100% response. Providers received an initial 1-hour remote, live videoconference learning session supported by interactive learning using breast and head and neck cancer dummy radiation plans. Providers were surveyed on anticipated need for training and ongoing support.

Results: Five institutions were included with 25 total participants. Countries included South Africa (n = 13), Tanzania (n = 1), and Guatemala (n = 12). Most commonly, participants were between the ages of 31-50 years old (72%) and in practice for > 5 years (68%). The

distribution of included respondent roles were as follows: physician (32%), dosimetry (24%), physicist (32%), resident/registrar (4%), radiation therapist (4%), and administrator (4%). Most participants reported they would find printed materials (96%), on-site in-person training (96%), off-site in-person training (92%), interactive online training (100%), and online video tutorials (100%) helpful. When asked to rate how helpful each of these resources would be on a scale of 1 to 5 (5 being most preferred), on-site in-person training (mean 4.25, SD = 0.9) scored the highest followed by interactive online training (mean 4.2, SD = 0.8), online video tutorials (mean 4.0, SD = 1.3), off-site in-person training (mean 3.74, SD = 1.1), and printed materials (mean 3.71, SD = 1.2). Only 44% of participants had previously used online training to learn about software designed for radiation treatment planning. When asked how comfortable they would be using the RPA after completing only an online training program on a scale of 1 to 5 (5 being very comfortable), participants rated a mean score of 3.8 (SD = 1.3). In terms of ongoing support for use of the RPA, participants reported that they would find telephone (88%), online chat (100%), email (92%), in person (88%), scheduled online (96%), and online discussion (88%) support helpful. Online chat (mean 4.1, SD = 1.1) was rated as the most helpful on a scale of 1 to 5 (5 being the most helpful) followed by email (mean 4.0, SD = 1.2), online discussion (mean 3.9, SD = 1.3) in person (mean 3.9, SD = 1.4), scheduled online (mean 3.8, SD = 1.3), and telephone (mean 2.5, SD = 1.4) support.

Conclusions: This survey indicates various strategies may be effective in training providers to use the RPA. However, these data provide early signal that although many providers may not have had similar online interactive training experiences, such an approach appears both acceptable and effective for training the target users of the RPA. Online training would be expected to be substantially less costly and have potentially wider reach than in-person trainings globally. These data help create a framework for global training to promote uptake and proficiency in use of automated radiation therapy planning technologies.

(P151) Diversity in Medical Physics Research Leadership: Quantifying the Representation of Racial, Cultural, and Sex Identity Minority Groups

Richard Castillo, PhD¹, Jillian Rankin², Brendan Whelan, PhD³, Julianne Pollard-Larkin, PhD⁴, Matthew Scarpelli, PhD⁵, Keyvan Farahani, PhD⁶; ¹Emory University, ²Emory University School of Medicine, ³University of Sydney, ⁴MD Anderson Cancer Center, ⁵Barrow

Neurological Institute, ⁶National Cancer Institute, National Institutes of Health

Background: The existence of disparities in the representation of minority groups has been an ongoing, systemic issue in STEM fields. Prior work has shown this is exacerbated for leadership positions and awards recipients. However, a characterization of racial, ethnic, and sex minority representation in medical physics research leadership has not yet been established.

Objectives: The purpose of this study was to investigate the presence and potential extent of disproportionate racial, ethnic, and sex representation in medical physics research leadership.

Methods: NIH grant funding was used as a proxy for research leadership. A list of AAPM members who received NIH grant funding as principal investigator between 1985-2020 was generated using the AAPM research database (Whelan B, et al Med. Phys. 2017). Anonymized demographics data for the group of NIH-funded AAPM members (N = 416), as well as for all current AAPM members (N = 8690), was provided by the AAPM. Fisher's Exact test for independence was used to test association between grant funding status and racial, ethnic, and sex demographic factors. Two-sample z-tests were used to compare proportions of individual demographic groups between the two study populations. Member profiles for which race, ethnicity, or sex were not reported were excluded from analysis.

Results: While not significantly associated with ethnicity, relative representation in research leadership was significantly associated with sex ($P < 0.05$) and had an association nearing significance with race ($P = 0.055$). Amongst demographic groups, women were significantly underrepresented as research leaders relative to their representation in the medical physics workforce ($P < 0.05$). Although not statistically significant due to low absolute representation in both groups, decreased relative representation amongst grant recipients was observed for individuals identifying as Black or African American, or as being of Hispanic, Latino, or Spanish origin. Within the group of research leaders, there were no individuals who identified as American Indian, Alaskan Native, transgender, or androgynous. Demographic data for AAPM was limited due to the ~40% rate of members self-declaring a racial or ethnic identity within membership profiles.

Conclusions: Our results suggest that the demographic makeup of the pool of NIH-funded medical physicists is distinct from that of practicing medical physicists in general, with significant differences in sex inclusivity observed. While we did not establish a statistically significant association between race or ethnicity and grant funding, analysis was limited due to a severe lack of minority representation in AAPM membership. Efforts to increase diversity and inclusion within

Gender Identity Demographic Profiles

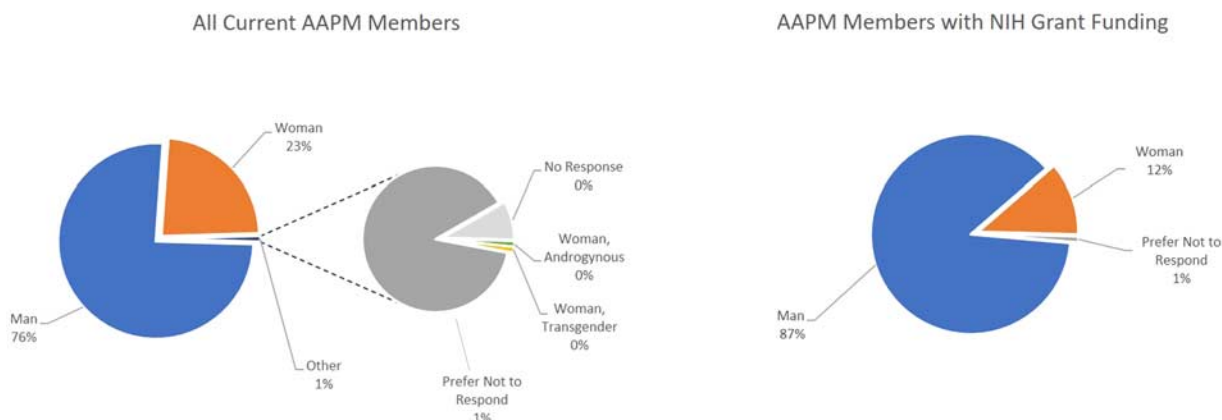

FIGURE 1. Gender identity demographic profiles of AAPM members and AAPM members with NIH grant funding. Relative representation in research leadership is significantly associated with sex ($P < 0.05$). Amongst AAPM members, women are underrepresented as NIH grant recipients relative to their male counterparts. Individuals identifying as transgender or androgynous have little representation in either group, but are notably absent from the NIH grant recipient group.

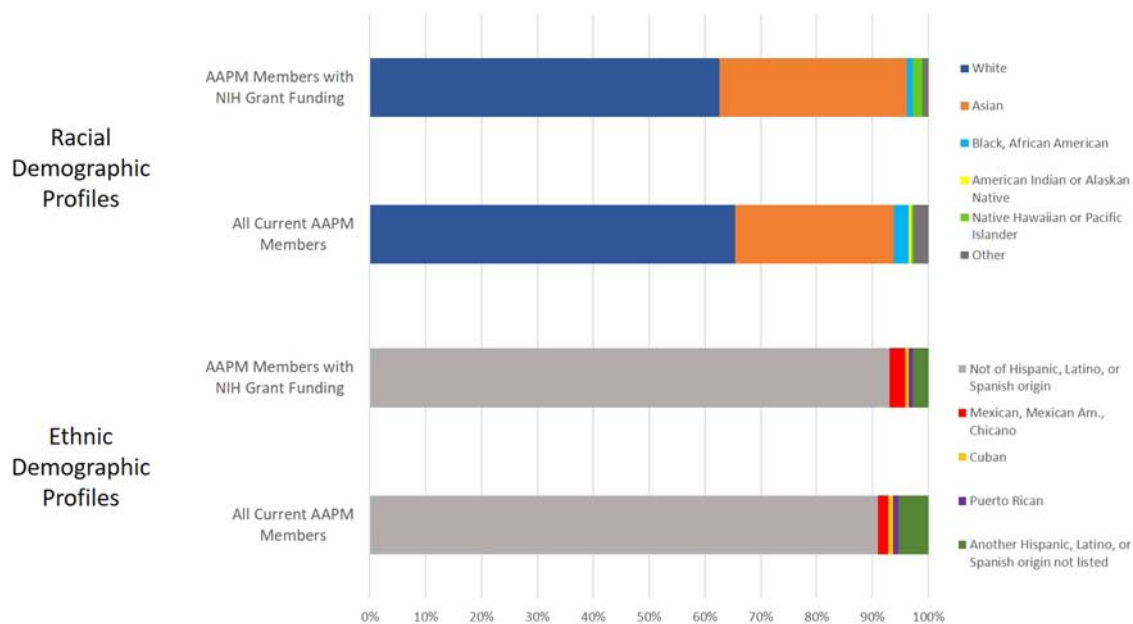

FIGURE 2. Racial and ethnic demographic profiles of AAPM members and AAPM members with NIH grant funding. Minority racial and ethnic groups are severely underrepresented in both the all-AAPM member population and AAPM member-NIH grants recipients population. Decreased relative representation amongst grant recipients is observed for individuals identifying as Black or African American, or as being of Mexican, Mexican American, Chicano, Cuban, Puerto Rican, or other Hispanic, Latino, or Spanish origin. Within the group of research leaders, there are no individuals who identify as American Indian or Alaskan Native.

AAPM will help yield more meaningful results. Further investigation is necessary to inform actionable policy to ensure diverse, equitable, and inclusive representation, both in research funding and within the professional body at large (Figs. 1 and 2).

(P152) Decision Making Process and Operations for Irradiation of COVID-19 Positive Patients

Quynh-Nhu Nguyen, MD¹, Julius Weng, MD², Bouthaina Dabaja, MD², Prajnan Das, MD, MS, MPH³, Albert Koong, MD, PhD², Elizabeth Bloom, MD², Gary Gunn, MD⁴, Cody Wages, BS, CMD², Gregory Chronowski, MD², Ryan Ritchey, RT (R) (T)², Ann H. Klopp, MD, PhD⁵, Kham Nguyen, BS, CMD, RT (T)², Andrew Bishop, MD², Danna Fullen, RT³, Ivy Robinson, RT (R) (T)², Denise Zaebst, RN, MSN², Jared Brokaw, RT (R) (T)², Greg Swiedom, RT (R), MR², Christopher Sanders, BS, RT (R) (T)², Zhongxing Liao, MD, FASTRO, FAAWR⁵, Mary McAleer, MD⁵; ¹UT MD Anderson Cancer Center, ²MD Anderson Cancer Center, ³MD Anderson, ⁴The University of Texas M.D. Anderson Cancer Center, ⁵The University of Texas MD Anderson Cancer Center

Background: During the COVID-19 pandemic, patients who test positive experience unique challenges of risking a treatment break in their radiation therapy course which can affect their clinical outcome. Many cancer centers quickly adopted policies and CDC guidelines into their daily operations to ensure continued patient care and treatment during the pandemic. It is important to develop and operationalize a safe process involving clinical leaders and teams to deliver safe and effective radiation treatments for oncologic emergencies and definitive radiation courses. Treatment of COVID-19 positive patients for both routine and urgent RT indications requires careful consideration and modification of workflow to balance potential therapeutic benefits and risk of transmission to other patients and staff.

Objectives: To report decision making process and workflow to irradiate COVID-19 positive patients at a tertiary cancer center from 4 treatment locations.

Methods: The Radiation Oncology Covid-19 committee (RO COVID RT) developed an integrated process to triage, provide consensus treatment recommendations, and safely deliver radiation therapy to patients who could not have a 21-day treatment break and patients who

needed emergent RT. Radiation oncology specific COVID policies were created for each center by physicians, nurses, and radiation therapists, which was then approved by the institution’s COVID committee. All COVID-19 positive patients were presented to the RO COVID RT group, evaluated for clinical urgency, benefit with radiation, and life expectancy, and, if deemed necessary, a limited planned break, modification of radiation dose, and hypofractionated course was recommended. To minimize risk to staff and other vulnerable oncology patients, inpatients were treated at our hospital’s main radiation facility and outpatients were treated at three of our six ambulatory centers. We conducted a retrospective review of patients treated with these COVID policies between June 2020 to July 2021.

Results: A total of 20 patients were treated using COVID precautions due to testing positive (n = 12, 60%) or for exposure/suspected COVID (n = 8, 40%). Six (30%) patients received treatment for an emergent indication (spinal cord compression, symptomatic leptomeningeal disease, cauda equina syndrome, and gastrointestinal bleeding). The remaining patients were already receiving RT at the time of their positive COVID test and underwent treatment breaks for 7-14 days. Thirteen (65%) patients were asymptomatic and were tested for routine pre-radiation screening or due to concerns of COVID exposure. All treatments were successfully completed without known spread of COVID to staff. Sixteen patients (80%) were alive at last follow up.

Conclusions: In this study, COVID positive patients were effectively treated with radiation therapy without significant delays in access or COVID transmission. We found that prospective review of cases at COVID Operations Leadership meetings was essential in determining urgency of RT, recommending hypofractionated regimens, and optimizing operational workflow of treating COVID patients.

(P153) ESAS Based Palliative Care Intervention in a Radiation Oncology Clinic

Ronica Nanda, MD¹, Alexandra Owens, MD², Heather Jim, PhD¹, Roberto Diaz, MD, PhD³, Sunny Raiker, BS², Nicholas Figura, MD⁴, Peter Johnstone, MD, FACR, FASTRO³; ¹H. Lee Moffitt Cancer Center and Research Institute, ²Morton Plant Hospital, ³Moffitt Cancer

Center, ⁴H. Lee Moffitt Cancer Center and Research Institute, Department of Radiation Oncology

Background: Symptom palliation as a component of routine cancer care has been proven to improve overall survival and quality of life for patients with advanced cancer. However, acute palliative care resources are limited at many cancer centers, especially in the outpatient setting; therefore, strategies to optimize the identification and selection of patients who require palliative care (PC) services are needed. We piloted a program at our institution in March 2018 to provide outpatient palliative care for cancer patients undergoing radiotherapy (RT) with referral based on high Edmonton Symptom Assessment Scale (ESAS) scores to divert resources toward patients in greatest need.

Objectives: To prospectively determine the impact of a palliative care consultation and follow up care on patient for radiation oncology patients with symptoms exceeding predetermined thresholds. We piloted a program at our institution to reflexively refer patients for outpatient palliative care should they report high symptom burden, as measured by the clinically validated Edmonton Symptom Assessment Scale (ESAS) score to divert resources toward patients in greatest need in a community-based cancer center.

Methods: The Radiation Oncology clinic established use of a modified ESAS tool (clinically validated in the outpatient oncology setting) in 2017, assessing 12 symptom domains on a 10-point scale. Higher scores indicate higher symptom burden. Each patient was asked to complete the modified ESAS at each consult, follow up, or weekly visit, and total scores were calculated. Patients with either a high cumulative ESAS score or a high score (> 6) on a single symptom domain were referred to the palliative care physician. Demographic and individual patient data were obtained from the electronic medical record. Individual domain and total scores were recorded in a deidentified database. The net change between highest and lowest total scores as well as net change in total scores from initial encounters and last follow up were calculated to determine the effect of a standard symptom-based palliative care referral. Patients without a subsequent clinical encounter and accompanying ESAS score following the palliative care consult were excluded from final analysis.

Results: Between March 2018 and January 2021, a total of 91 patients consulted with outpatient palliative care at least once. A total of 75 patients met the criteria for final analysis. ECOG performance status for all patients was 0-2. Mean total score from initial radiation oncology encounter was 49.4 +/- 22.3 (range 0 to 97); at initial PC consultation, mean total score was 53.2 +/- 22.9 (standard deviation) (range 1-101). At time of last follow up, mean total scores was 45.1 +/- 25.6 (range 0-103). The mean lowest total score was 30.0 +/- 22.1. (range 0-88) and highest total scores mean was 66.6 +/- 21.7 (range 13-107). Mean change in total scores from initial radiation oncology visit to last follow up was -4.28 points +/- 25.6 (range -86 to 61) and from initial PC consult to last follow up was -8.03 points +/- 22.1 (range -88 to 40). 84% of patients had improvement in the highest individual score by at least one point, and of those who had an improvement, 70% had an individual score improve from severe (> 6) to not severe (< = 6). Of the 21 patients who passed away during this interval, twelve had lower or stable total ESAS scores at last follow up.

Conclusions: Radiation oncology patients referred to outpatient palliative care have high symptom burden at baseline. Palliative care consultation and follow up were correlated with a decrease in total ESAS scores of 8 points. Previous literature suggests that improvement in ESAS scores is associated with improved quality of life and decrease in total scores of 3-4 points is clinically meaningful. Patients at end of life in this cohort appeared to have stable ESAS scores suggesting a significant benefit from early palliative care intervention.

(P154) Malignant Cord Compression and Timing of Post-operative Radiotherapy

April Vasantachart, MD¹, Phillip Bonney, MD¹, Eugene Lin, MD, MS², Shelly Bian, MD²; ¹LAC+USC Medical Center, ²Keck School of Medicine of USC

Background: Malignant spinal cord compression (MSCC) can result in permanent neurologic injury and often requires prompt neurosurgical decompression followed by radiation therapy (RT). Post-surgical care

Relative Risk for Impaired Ambulation at Specified Times to Initiation of Radiation

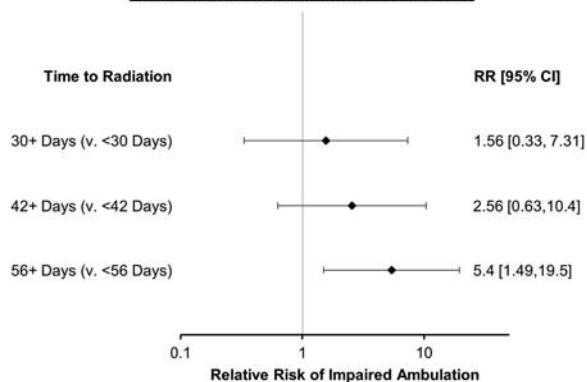

FIGURE 1. Forest plot of relative risk for impaired ambulation based on time to treatment initiation of radiation. RR=relative risk. CI=confidence interval.

can include rehabilitation and time for wound healing which can lead to delays in post-operative RT.

Objectives: This study aims to retrospectively review the time to initiation (TTI) of RT after surgical intervention for MSCC and its association with ambulatory status at 3 months. We also compare TTI in patients discharged to home, versus inpatient rehabilitation, or a skilled nursing facility.

Methods: Our institutional database was queried for patients with solid malignancies and spinal metastases with Bilsky 2 or 3 MSCC who underwent surgical intervention from 2015-2020 and postoperative RT. In patients who were ambulatory peri-operatively, we computed the relative risk of decreased ambulation at 3 month follow up using different TTI cutoff values of 30, 42, and 56 days. *P* values were generated using a 1-sided Fisher's Exact Test. TTI was also evaluated in all patients who underwent post-operative RT based on their discharge to either home, inpatient rehabilitation, or a skilled nursing facility.

Results: We found 85 patients with MSCC who underwent surgery. Within this group, 56 received post-operative RT with known TTI. For our TTI analysis, we excluded 14 patients who were not peri-operatively ambulatory and 10 patients who did not have at least 3 months of follow up. Three-month ambulatory rates for TTI of ≤ 30 vs > 30 days, ≤ 42 vs > 42 days, and ≤ 56 vs > 56 days were 86% vs 78% (*P*=0.460), 87% vs 67% (*P*=0.203), and 89% vs 40% (*P*=0.034), respectively. For all patients who received post-operative RT without wound complications causing delays in RT, TTI based on discharge to home (*n*=35), a skilled nursing facility (*n*=4), or inpatient rehab (*n*=16) was 28 days (IQR 19-41), 28 days (IQR 16-41), and 35 days (IQR 24-53), respectively. Six patients were found to have locally recurrent disease causing cord compression—only one recurred after post-operative RT while five recurred before post-operative RT. Three had TTI > 100 days due to recurrent disease at 33 days and 56 days requiring two re-resections, transportation difficulties from skilled nursing facility, and continued oncologic care at an outside hospital who did not refer the patient for RT. The other three patients received RT within 30 days, however two recurred before RT and one recurred at 465 days.

Conclusions: Initiation of post-operative radiation more than 56 days after surgical resection for MSCC showed lower ambulatory rates at 3 months. Further studies evaluating the optimal timing of post-operative RT and causes for delay are needed (Fig. 1).

(P155) Prisoner of the Heart – Primary Unresectable Cardiac Angiosarcoma in an African American Man

Jehan Yahya, MD¹, David Henkin, MD², Joseph Montecalvo, MD³, Rami Khoury Abdulla, MD³; ¹OHSU: Oregon Health & Science University, ²UT Health, ³Henry Ford Hospital

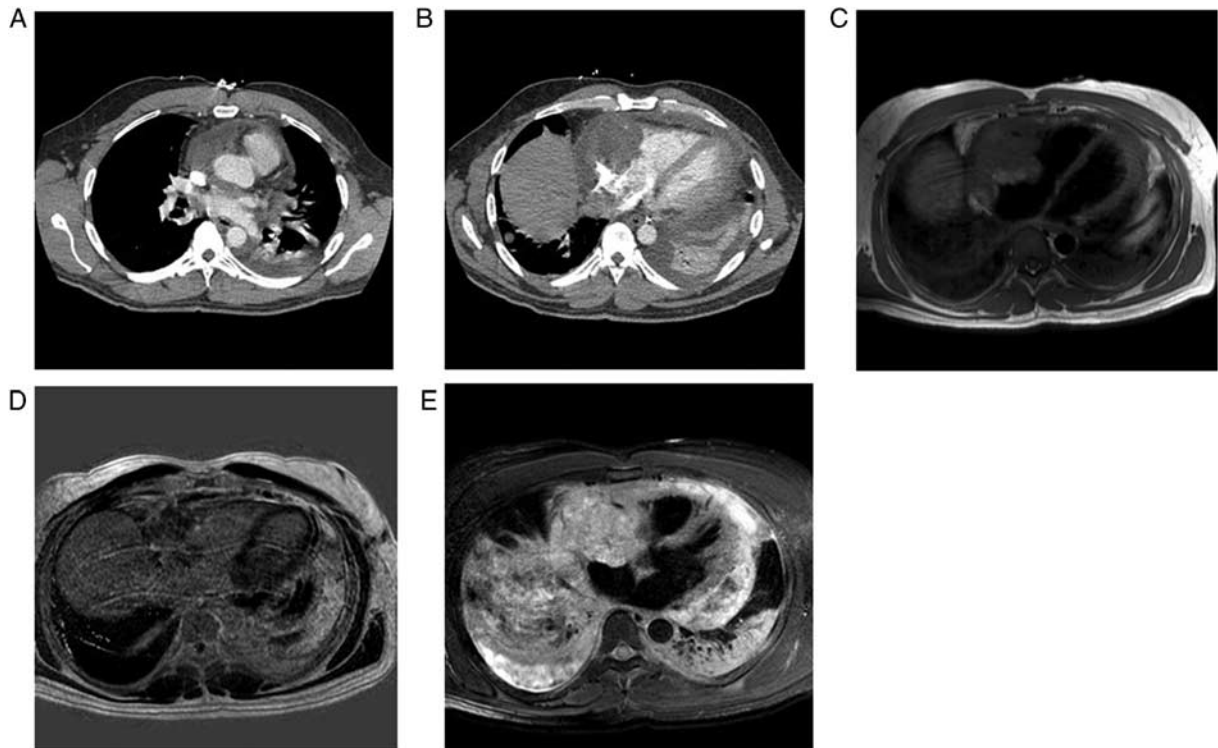

FIGURE 1. (A) CT axial showing mass centered in right atrioventricular groove with extension into the right atrium and ventricle, pericardial effusion. (B) CT showing right lower lobe 14 mm pulmonary nodule. (C) Cardiac MRI Proton Density Black Blood images showing the mass is heterogeneous in signal with areas of isointense signal and hyperintense signal compared with normal myocardium. There is a moderate pericardial effusion along the left ventricle (no signal). (D) Cardiac MRI T2 Weight, Fat Saturated, Black Blood demonstrating a heterogeneous T2 hyperintense signal within the 7 x 7.8 cm mass. The pericardial effusion along the left ventricle demonstrates high signal. (E) Cardiac MRI Phase Sensitive Inversion Recovery images obtained after the administration of intravenous contrast showing a heterogeneous enhancement within the mass. There is no signal in the pericardial effusion.

Background: One-quarter of cardiac tumors are malignant [Centofanti P, et al *Ann Thorac Surg* 1999] and present with metastasis [Patel S, et al *Med Sci Mon* 2014]. The most common malignant primary cardiac tumor is sarcoma, of which 30% is angiosarcoma [Patel S, et al *Med Sci Mon* 2014]. From all histologic subtypes, primary cardiac angiosarcoma (PCA) has the statistically lowest medial overall survival of 7 months with no associated improvement over the last decade [Yin K, et al *J thorac cardiovasc Surg* 2019]. Given this, the outcomes of interventions are controversial. Eleven percent of PCAs are found in African-Americans [Yin K, et al *J thorac cardiovasc Surg* 2019]. We contribute a report of unresectable PCA in an African-American imprisoned man who faced numerous obstacles, resulting in partial completion of radiotherapy.

Objectives: • Cardiac angiosarcoma has a higher incidence within the White population. • The presenting symptoms include dyspnea and

hemorrhagic pericardial effusion. • Delay in diagnosis prolongs hemodynamic instability and patient discomfort. • This case offers value for future male African American epidemiologic studies. • There are no radiotherapy guidelines in treating patients diagnosed with any cardiac sarcoma • Radiation therapy provided symptom free in a metastatic setting • The COVID-19 pandemic complicates disposition, especially relating to prisons.

Methods: Case Description A 42-year-old imprisoned African-American man with no relevant history presented to an outside hospital with chest pain, dyspnea, tachycardia, muffled heart sounds and jugular venous distention without hypotension secondary to a large hemorrhagic pericardial effusion with tamponade. The subxiphoid approach pericardiocentesis was unsuccessful. The subsequent pericardial window via left mini thoracotomy with pericardial biopsy removed 1500 cc of bloody pericardial effusion status post chest tube placement,

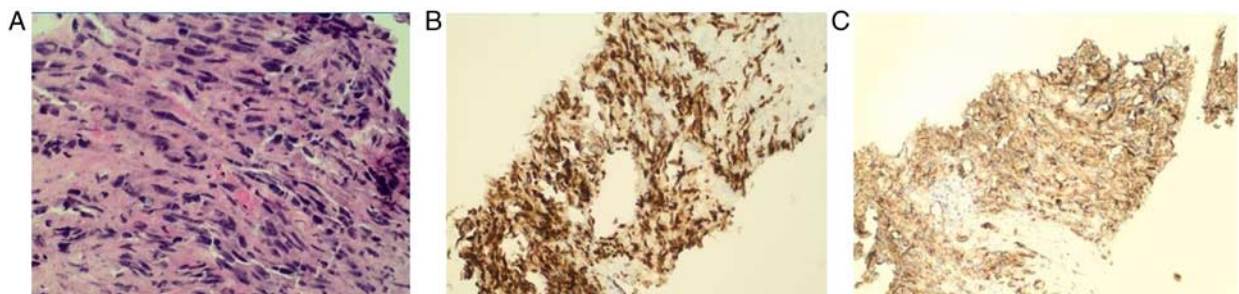

FIGURE 2. (A) HE stained cardiac mass specimen. (B) Specimen stained with ERG. (C) Specimen stained with CD31. Specimen had a negative sarcoma fusion panel.

resulting in symptomatic improvement. Transthoracic echocardiogram (TTE) revealed 62% ejection fraction, pericardial effusion and hyperdynamic biventricular systolic functions with right ventricular diastolic collapse. The pericardial biopsy showed poorly differentiated malignant epithelial neoplasm. Computed tomography (CT) chest showed a 6 x 5.8 x 8 cm mass of the right heart border extending into both right atrial and ventricular lumens with abutment into the superior vena cava, lymphadenopathy, and 14 mm pulmonary right lower lobe nodule suspicious for metastasis (Fig. 1). The patient was transferred to our hospital. Repeat CT chest revealed an interval decrease in pericardial effusion and new left pleural effusion, and Pleur-x catheter was placed. Increased dyspnea prompted CTPE, which was negative, with repeat TTE showing reaccumulation of pericardial effusion. CT abdomen pelvis was negative for metastasis. Cardiac MRI revealed a 7 x 7.8 cm mass originating from the atrioventricular groove extending into the left atrium, the lateral atrial recess, the right atrial posterior and lateral free walls, and the pericardium with right coronary artery encasement. Another 2.5 x 3 cm heterogeneous mass was found involving the right superior and inferior pulmonary veins. Cardiac biopsy pathology revealed positivity for ERG and CD31 stains (Fig. 2), consistent with angiosarcoma. His course was complicated by an unstable arrhythmia and a new 1400 cc hemorrhagic effusion requiring thoracentesis. TTE demonstrated interval decrease to 4.9 x 4.1 cm after six of the 30 fractions prescribed to 60 Gray (Gy). The prevalence of COVID-19 in both our hospital and Michigan prisons complicated disposition. Thus, he enrolled in hospice after 12 fractions of radiotherapy and expired in jail 5 months from initial symptom onset.

Results: N/A

Conclusions: The rarity of primary cardiac tumors [Reynen K, Am J Cardiol 1996] makes randomized trials investigating outcomes difficult. An evaluation of primary cardiac sarcomas within the United States, not exclusively PCA, using the SEER database found 24% of patients received radiotherapy with no association to better outcomes [Yin K, et al J thorac cardiovasc Surg 2019]. It is unclear what percentage of patients with the angiosarcoma histology (43% of their study population) received radiotherapy. Additionally, the database did not include the timing of interventions. Our patient's tumor decreased by half after receiving a total of 12 Gy with moderate symptom relief. There was no additional interval imaging to trend tumor size after receiving 24 Gy. Currently, there are no radiotherapy guidelines in treating patients diagnosed with any cardiac sarcoma. The risk of contracting COVID-19 while admitted was high. Thus, he only received 24 Gy, enrolled into hospice and transferred back to his jail hospital and expired. Did the partial radiation provide benefit? The radiotherapy he did receive had no effect on his overall survival given he expired within the expected timeframe, however he did not complete his prescription. Isambert et al found that radiotherapy was associated with improved progression-free survival, retrospectively [Isambert N, et al Journal of General Internal Medicine 2017]. However, our patient is not well-represented in their study cohort encompassing all histologies and only patients with non-metastatic disease received radiotherapy. For the

entire cohort, about 19% received radiotherapy as monotherapy. The mean age of PCA diagnosis is 47.2 years old [Yin K, et al J thorac cardiovasc Surg 2019], which aligns closely to that of our patient's. PCAs arise in the right atrium [6] causing cardiac encasement, pericardial involvement, pericardial effusion, and cardiac tamponade [Reynen K, Am J Cardiol 1996]. The most common site of metastasis is the lungs [Patel S, et al Med Sci Mon 2014, Abdel-Rahman Z et al Journal of General Internal Medicine 2017], as most likely seen here. All of the above factors made achieving disease control or patient comfort a challenge. PCA must be in the differential for pericardial effusion. The need to further evaluate the role of radiotherapy is greatly needed. Given the rarity of PCA, it is unlikely that clinical trials will investigate the role of radiotherapy or other interventions. This report chronicles interval tumor size decrease and symptom relief. Lastly, more investigations on PCA in African-American men [Galven D, et al Oncoscience 2018] are needed.

(P156) Sequential Diffusion Tensor Imaging and Magnetic Resonance Spectroscopy in Patients Undergoing Re-irradiation for Progressive Diffuse Intrinsic Pontine Glioma

Julianna Bronk, MD, PhD¹, Ping Hou, PhD¹, Mark J. Amsbaugh, MD¹, Soumen Khatua, MD¹, Anita Mahajan, MD², Leena Ketonen, MD¹, Susan McGovern, MD, PhD³; ¹University of Texas MD Anderson Cancer Center, ²Mayo Clinic, ³The University of Texas MD Anderson Cancer Center

Background: Diffusion tensor imaging (DTI) for evaluation of white matter tracts is used with magnetic resonance spectroscopy (MRS) to improve management of diffuse intrinsic pontine glioma (DIPG). Changes in apparent diffusion coefficient (ADC), fractional anisotropy (FA), and tumor metabolite ratios have been reported after initial radiation for DIPG, but these markers have not been studied sequentially in patients undergoing re-irradiation for progressive DIPG.

Objectives: We evaluated quantitative changes in FA, ADC, and tumor metabolites and qualitative changes in white matter tracts in patients who received re-irradiation for progressive DIPG on a prospective clinical trial.

Methods: Four patients with progressive DIPG treated with re-irradiation on a prospective trial had DTI and MRS before and after re-irradiation. Median re-irradiation dose was 25.2 Gy (24-30.8 Gy). Fiber tracking was performed using standard tractography analysis. FA and ADC values were calculated pre- and post-reirradiation. Multivoxel MRS was performed. Findings were correlated with clinical features and conventional MRI of tumors.

Results: All patients had an initial response to re-irradiation as shown by a decrease in tumor size. FA increased with disease response and decreased with progression while ADC decreased with disease response and increased with progression. At second progression, the FA fold change relative to pre-re-irradiation values decreased (median fold change -0.15). Visualization of tracts demonstrated robust reconstitution

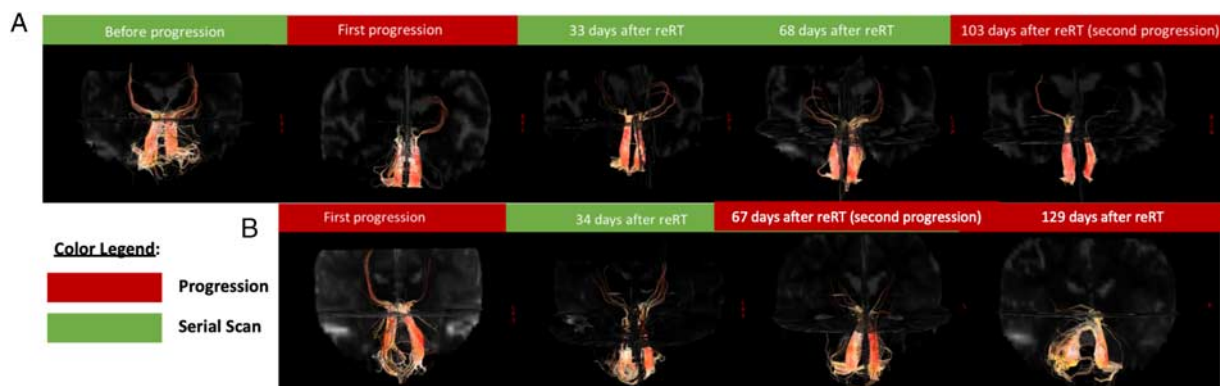

FIGURE 1. Sequential DTI tractography during disease response and progression. DTI tractography of the medial lemniscus tracts in Patient 2 (A) and Patient 3 (B) are shown before re-irradiation, during treatment response and at second progression.

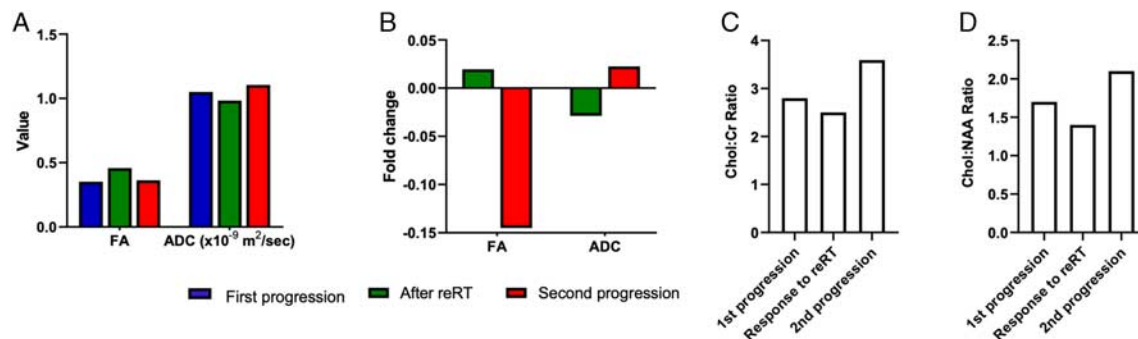

FIGURE 2. Quantitative measurements of FA, ADC, and metabolites before and after re-irradiation and at second progression. A. Absolute values for FA and ADC for the corticospinal and medial lemniscus tracts at first progression, after reRT, and at second progression in patients who underwent reRT for progressive DIPG. B. Median fold change in FA and ADC during disease response and at second progression for patients with serial imaging following re-irradiation. C and D. Median Chol:Cr (C) and Chol:NAA (D) ratios at first progression (n = 1 scan), during response to re-irradiation (n = 6 scans), and at second progression (n = 3 scans).

of previously disrupted paths during tumor response; conversely, there was increased fiber tract disruption and infiltration during tumor progression. MRS analysis revealed a decrease in Chol:Cr (median 2.5) and Chol:NAA ratios (median 1.4) during tumor response and increase during progression (median 3.6 for Chol:Cr, median 2.1 for Chol:NAA).

Conclusions: This study is the first to prospectively examine changes in white matter tracts and tumor metabolism in DIPG patients undergoing re-irradiation. Changes related to tumor response and progression are observed even after only 24-30.8 Gy re-irradiation (Figs. 1 and 2).

(P157) MRI Radiomics Features Correlate with Histologic Tumor Necrosis Following Neoadjuvant Radiation Therapy in Extremity Soft Tissue Sarcoma

Crystal Seldon, MD¹, James Grosso, MD, PhD², Ty Subhawong, MD³, Gautam Shrivastava, ScM¹, Melanie Fernandez, BS¹, Raphael Yechieli, MD¹, Matthew Mason, BS⁴; ¹University of Miami/Sylvester Comprehensive Cancer Center, Department of Radiation Oncology, ²University of Miami, Department of Diagnostic Radiology, ³University of Miami, Department of Diagnostic Radiology, ⁴University of Miami, Department of Diagnostic Radiology

Background: Radiomics has become a new method of extracting data from radiographic images for quantifying pixelated data far beyond what the human eye can perceive. Unique differences at the pixel level between subsets of patients can help radiologists interpret radiographic images in a clinically meaningful way to predict response to oncologic treatments, predict prognosis, and help in diagnosis of tumor types.

Objectives: The purpose of this study is to identify MRI radiomic features of sarcomas treated neoadjuvantly with radiation that correlate with excised tumor histologic necrosis.

Methods: Patients with intermediate- or high-grade extremity soft tissue sarcomas who underwent neoadjuvant radiation therapy, and who had post-treatment MRI scans were included. We employed MINT Lesion radiomics software for extraction of quantitative imaging data from contrast-enhanced sequences. The lesion Regions of Interest (ROIs) were manually contoured on a single slice demonstrating largest tumor cross-sectional areas; 3 ROIs were analyzed as replicates within each scan, and averaged before final analysis. Following neoadjuvant treatment, tumors were excised and histologic tumor necrosis was determined. Using Pearson correlation statistics, the percent necrosis was compared with radiomic features of post treatment scans. Only radiomic features with a P value <0.05 were considered statistically significant which correlated with a Pearson value of less than -0.25 or greater than 0.25.

Results: 11 patients, treated between 2013 and 2019 were included in the study. The clinical characteristics were: male-(45%) and female-(55%); type of sarcomas included Synovial, Spindle, Liposarcoma, and Myxofibrosarcoma. The average necrosis on final pathology was 71% +/- 38% std. A total of 42 radiomic features were extracted from the ROIs. 12 of the

delta-radiomics parameters were significantly correlated with necrosis (P-value < 0.05). The significantly correlated radiomic features includes first and second order values representing the distribution of voxel intensities within the segmented image regions and the statistical inter-relationships between neighboring voxels, respectively. The highest correlated radiomic features included (names directly from Mint lesion): secondorder.Information_correlation_1, secondorder.Dissimilarity, and secondorder.Difference_average.

Conclusions: Radiomics features, including both first and second order features, are associated with histologic necrosis in neoadjuvantly treated extremity soft tissue sarcomas. This data supports multi-parametric image texture mapping in the development of prediction models for neoadjuvant treatment response in sarcoma.

(P158) Vertebral Body Growth Retardation Following Proton Craniospinal Radiation

Shannon MacDonald, MD¹, Myrsini Ioakeim-Ioannidou¹, Andrzej Niemierko, PhD¹, Drosoula giantsoudi, PhD¹, Roshan Sethi, MD¹, Daniel Kim, MD MBA¹, Joseph Simeone, MD¹; ¹Massachusetts General Hospital

Background: Craniospinal irradiation (CSI) is a standard component of curative therapy for several childhood brain tumors. Long-term survivors are at risk of late complication from CSI. A known side-effect of CSI is growth impairment of the vertebral column resulting in decreased sitting height for survivors

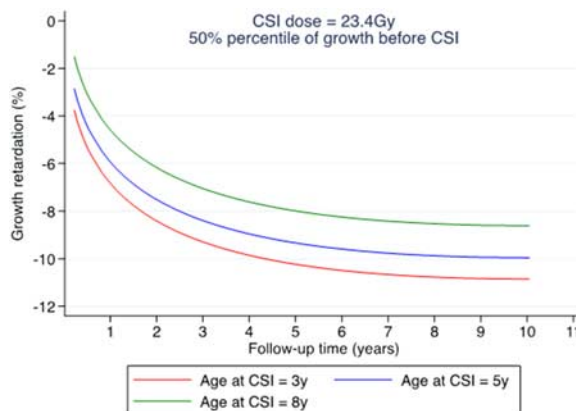

FIGURE 1. Growth retardation as a function of follow-up time.

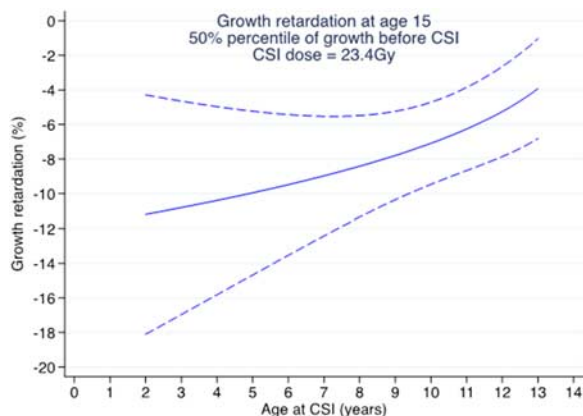

FIGURE 2. The effect of age at CSI on expected growth retardation at age 15.

Objectives: We determined the rate and amount of vertebral body (VB) growth retardation after proton craniospinal irradiation (CSI) compared with patients that did not receive spinal irradiation.

Methods: We performed a retrospective outcome data analysis of 87 patients < 16 years old with central nervous system (CNS) tumors who received proton radiotherapy (PRT) at our institution between 2002 and 2010 with available spinal MRI imaging. Fifty-five patients received CSI, while 32 brain tumor patients that received focal cranial irradiation served as controls. Vertebral body height was measured midline using sagittal T1-weighted contrast or non-contrast enhanced MRI images of the spine. Measurements were repeated at multiple levels (C3, C3-C4, T4, T4-T5, C3-T6, T4-T7, L3, L1-L5) on available scans for the duration of follow-up. Data were fitted using a mixed-effects regression multivariable model, including follow-up time, CSI dose, age at CSI, and pre-treatment VB percentile as parameters.

Results: Median follow-up was 70 months for patients treated with proton CSI and 52.9 months for the control group. There was a significant association of CSI dose, age at treatment, and pre-treatment percentile with VB growth retardation. Growth retardation was shown to be independent of sex or growth hormone deficiency.

Conclusions: Although the current practice of PRT CSI delivery allows for sparing of the organs anterior to the spine, the vertebral column receives radiation therapy (RT) due to its close proximity to the targeted spinal canal. In growing children, the whole vertebral body is generally included so that growth impairment is even across the VB. We present a quantitative model predicting the growth retardation of patients treated with PRT CSI based on age at treatment, CSI dose, follow-up time, and pre-treatment growth percentile (Figs. 1–3).

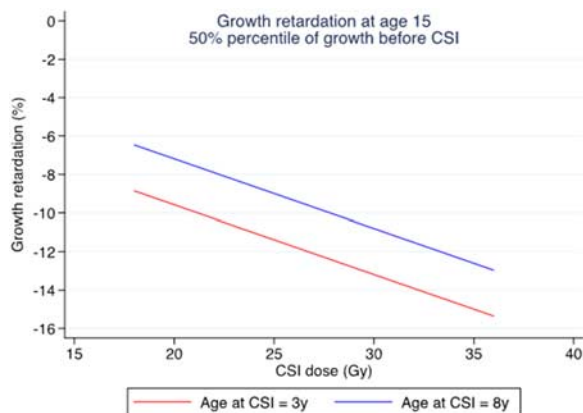

FIGURE 3. The effect of CSI dose on expected growth retardation at age 15.

(P159) Survival Disparities Among the Adolescent and Young Adult (AYA) Sarcoma Population

Crystal Seldon, MD¹, Gautam Shrivastava, ScM², Abdurrahman Al-Awady, BS³, David Asher, MD³, Stephen Ramey, MD³, Melanie Fernandez, BA³, Sarah Dooley, MD³, Wei Zhao, MS⁴, Deukwo Kwon, PhD², Tejan Diwanji, MD¹, Jonathan Trent, MD, PhD³, Ty Subhawong, MD³, Raphael Yechieli, MD¹; ¹University of Miami/Sylvester Comprehensive Cancer Center, Department of Radiation Oncology, ²University of Miami/Sylvester Comprehensive Cancer Center, ³University of Miami/Sylvester Comprehensive Cancer, Department of Radiation Oncology, ⁴University of Miami/Sylvester Comprehensive Cancer Center, Biostatistics and Bioinformatics Shared Resource

Background: Soft tissue sarcomas (STS) are rare in the adult population, however, occur more frequently in the adolescent and young adult population (AYA) (Bleyer, et al Nat Rev Cancer 2008). Notably, survival rates among AYAs are similar to those of children and higher than in adults, however, this is not seen in STS (American Cancer Society, Cancer Facts & Figures 2020). Poorer prognosis is attributed to numerous factors including more aggressive clinical characteristics of STS in the AYA population compared with those diagnosed in children, poor clinical trial participation of AYAs, and lack of data regarding prognostic factors in this age group (Bleyer, et al Cancer 2005).

Objectives: In this retrospective study, we sought to determine survival disparities and variables associated with poor prognosis among AYAs as compared with older patients with extremity STS in the National Cancer Database (NCDB).

Methods: The NCDB was utilized to identify patients (pts) 18 and older with extremity STS diagnosed between 2004-2014 and treated definitively with limb-sparing surgery (LSS) or amputation. Multivariable analyses used logistic regressions for patterns of treatment and their correlation with demographic factors (sex, race, ethnicity, insurance status, income, education, and distance from hospital) and tumor characteristics (primary site, grade, size, clinical stage, depth of extension, and surgical margins).

Results: 8,201 patients were included in the study of which 1,141 were AYA (13.9%). At the time of the analysis, 5,465 patients were alive with an overall survival of 9.6 years. Patients aged 40-64 years old (HR 1.37, 95% CI 1.18-1.59, $P < 0.001$) and those 65 and older (HR 2.85, 95% CI 2.47-3.28, $P < 0.001$) had significantly worse survival when compared with the AYA population as identified on Kaplan-Meier plot for OS. On multivariable analysis, there were no factors associated with increased survival in the AYA population. Two comorbidities (HR 6.82, 95% CI 1.77-26.3, $P = 0.005$), location in a small metro area (HR 1.52, 95% CI 1.05-2.18, $P = 0.025$), tumor size greater than 5 cm (HR 3.53, 95% CI 1.99-6.27, $P < 0.001$), and positive surgical margins (HR 1.89, 95% CI 1.06-3.47, $P = 0.031$) were associated with worse survival in this age group. Living in a smaller metro location was a unique factor for poor prognosis among AYAs that was not seen in the older age groups.

Conclusions: Survival disparities exist among the age groups of patients diagnosed with extremity STS. Further study is warranted to identify the impact of these survival disparities.

(P160) Impact of Radiation Therapy on Survival of Pediatric Metastatic Neuroblastoma: Analysis of the National Cancer Database

Sherif Shaaban, MD¹, Kathryn Dusenbery, MD¹, Emily Greengard, MD¹, Stephanie Terezakis, MD¹; ¹University of Minnesota Medical Center

Background: Radiation therapy (RT) has been incorporated in treatment of pediatric metastatic neuroblastoma (MNB) with demonstrated local control benefit. Although the impact on overall survival is still unknown.

Objectives: We identify the impact of RT on overall survival among MNB patients.

Methods: The NCDB was queried for patients aged ≤ 18 years diagnosed with neuroblastoma between 2004-2016. Patients with metastatic disease were included with exclusion of patients with 4S/MS disease aged ≤ 12 months. Univariable logistic regression was used to evaluate factors associated with the delivery of RT. Overall survival (OS) analysis was performed using Kaplan-Meier and log-rank test. Cox hazards modeling were used to ascertain variables associated with OS.

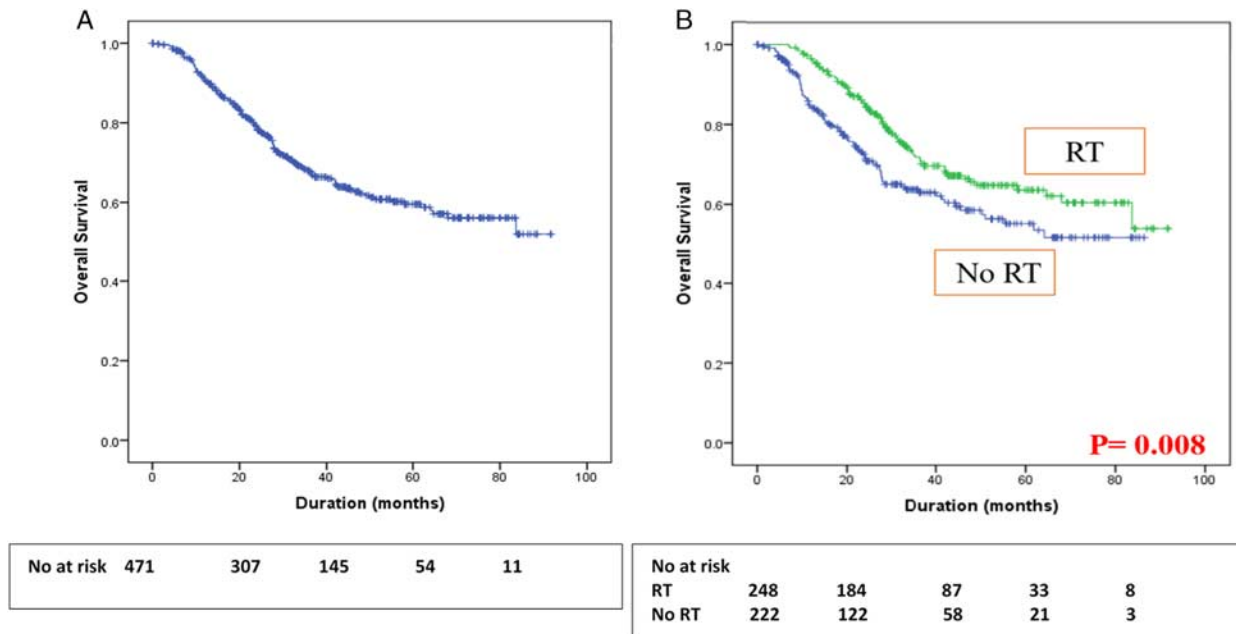

FIGURE 1. Overall Survival of all study population (A) and stratified by radiotherapy treatment (B).

Results: 504 patients met the study criteria; 257 patients (51%) received RT and 247 (49%) did not. Surgery was performed more frequently among RT group (88%) versus the non-RT group (32%). The number of patients who underwent autologous bone marrow transplant (ABMT) in the RT group was significantly higher than those in the non-RT group (73% versus 26%, $P=0.0001$). The most common utilized RT modalities were 3D CRT (50%) and IMRT (34%). The most common used RT dose was 2,160 cGy (58%) and the most frequent boost dose was 1,440 cGy. Logistic regression analysis confirmed that surgery with positive surgical margins, use of ABMT and immunotherapy covariates were associated with increased likelihood of receiving RT. After stratification by RT receipt, the median OS was significantly higher among the RT group, 67 months (95% CI, 62.53-71.4 mo) versus 56 months among the non-RT group (95% CI, 51.64-61.38 mo) ($P=0.008$). Cox hazards modeling confirmed that non-receipt of RT was associated with poorer OS on univariate (HR 1.51, 95% CI 1.11- 2.05, $P=0.009$) and multivariate (HR 1.52, 95% CI 1.115- 2.07, $P=0.008$) analysis. Presence of bone metastases was significantly associated with worse OS on univariate analysis (HR 1.80, 95% CI 1.08- 2.97, $P=0.022$). ABMT receipt was associated with better OS on univariate (HR 0.333, 95% CI, 0.145- 0.763, $P=0.009$) and multivariate (HR 0.234, 95% CI, 0.147- 0.897, $P=0.002$) analysis.

Conclusions: Impact of RT on OS has not been widely investigated. Our study demonstrated that RT was significantly associated with improved OS. Future prospective studies are warranted to identify the impact RT on survival in high risk and metastatic neuroblastoma (Fig. 1).

(P161) Impact of Strict Brainstem Dosimetric Parameters on Symptomatic Brainstem Injury and Survival After Proton Beam Radiation in Pediatric Brain Tumors

Rituraj Upadhyay, MD¹, David Grosshans, MD, PhD¹, Susan McGovern, MD, PhD¹, Mary McAleer, MD¹, Kristina Woodhouse, MD¹, Wafik Zaky, MD¹, Murali Chintagumpala, MD², Anita Mahajan, MD³, Arnold Paulino, MD¹; ¹The University of Texas MD Anderson Cancer Center, ²Texas Children's Cancer Center, Baylor College of Medicine, ³Mayo Clinic

Background: Brainstem toxicity after radiation is a devastating complication and is a particular concern with protons, given the biological differences and range uncertainties. Dosimetric predictors of brainstem

injury are not well defined and the prescription dose is often decreased to limit the risk, especially in tumors involving the posterior fossa.

Objectives: To investigate the difference in survival and risk of brainstem injury in pediatric brain tumors treated with proton therapy when using strict brainstem dosimetric.

Methods: All patients < 18 years with infratentorial brain and pineal tumors, treated with proton beam radiation at our institution from 2007–2019, with a brainstem Dmean of > 30 Gy and/or Dmax > 50.4 Gy were included. We excluded patients with primary brainstem tumors. In 2014, our institution started using strict brainstem dose constraints of Dmax ≤ 57 Gy, Dmean ≤ 52.4 Gy and V54 ≤ 10% to decide final dose to the target(s). We analyzed Symptomatic brainstem injury (SBI) and survival before and since incorporation of these guidelines. SBI was defined as any new or progressive cranial neuropathy, bulbar weakness, ataxia, dysmetria and/or motor weakness with corresponding radiographic abnormality within the brainstem. Kaplan-Meier test was used for survival analysis.

Results: A total of 595 patients were reviewed and 362 (medulloblastoma = 209, ependymoma = 86, ATRT = 43, pineoblastoma = 9, others = 15) met our inclusion criteria. Median age at RT was 5 years (range 0.7–17.9 y) and median prescribed RT dose was 54 CGyE (range 39.6–59.4 CGyE). About 32% patients were prescribed > 54 Gy before 2014, compared with only 9% since 2014. Median follow up was 40 months (range 1–152). 2-year progression free survival in patients treated before and since 2014 was 70.3% and 70.6% ($P=0.649$), while overall survival was 80.8% and 86.1% ($P=0.77$) respectively. Ten patients (2.7%) developed SBI, at a median of 4 months after radiation (range 1-6). Asymptomatic imaging changes within brainstem were seen in 47 patients (13%) at a median of 4 months after RT, with most common findings being increased T2 flair, focal enhancement and encephalomalacia. The incidence of SBI decreased from 4.2% (2007-2013) to 0.7% (2014-2019) ($P=0.047$) while asymptomatic imaging changes remained similar (11.6% vs 15.1%, $P=0.33$). On univariate analysis, only timing of radiation (before/since 2014) was an independent predictor of SBI ($P=0.028$), while no significant association was observed with extent of resection, number of resections, age at radiation, prescribed RT dose, cone down and systemic treatment.

Conclusions: Although our study is limited given the heterogenous population and different time-period of comparison, our results suggest that the use of strict brainstem dose constraints to determine final dose to the tumor/ tumor bed results in a lower incidence of SBI, without compromising the survival.

(P162) Patterns of Care and Utilization Disparities in Proton Radiation Therapy for Pediatric Central Nervous System Malignancies

Christopher Weil, MD¹, Lew Felicia, DVM², Vonetta Williams, MD/PhD³, Ralph Ermoian, MD³, Matthew Poppe, MD¹; ¹University of Utah Huntsman Cancer Institute, ²Washington State University Elson S. Floyd College of Medicine, ³University of Washington

Background: Proton radiotherapy (PR) is well established in the treatment of pediatric malignancies in the central nervous system (CNS) given established dosimetric advantages that may reduce the late effects of radiotherapy.

Objectives: In this analysis, we sought to update our 2016 published patterns of care data on the receipt of PR in children with primary CNS malignancies since both the number of proton centers and availability have significantly increased in the interim. We aimed to evaluate the utilization of PR in this population and characterize the clinical and sociodemographic factors predictive of receipt of PR.

TABLE 1. Baseline Patient Characteristics Between Photon and Proton Radiotherapy Groups

Characteristic	Photons, n (%)		Protons, n (%)		P
Age (years)					<0.01
0-5	2279	28	373	29	
6-10	2519	31	339	31	
11-18	3283	41	333	32	
Year of diagnosis					<0.01
2004-2008	3022	37	84	8	
2009-2012	2411	30	231	22	
2013-2017	2648	33	730	70	
Race					<0.01
White	6189	77	794	76	
Black	1079	13	68	7	
Asian	329	4	50	5	
Native American/Eskimo	55	1	10	1	
Native HI/Pacific Islander	20	<1	4	<1	
Other/Unknown	409	5	119	11	
Ethnicity					0.81
Non-Hispanic/unreported	6820	85	878	86	
Hispanic White	1136	14	141	14	
Hispanic Black	32	<1	3	<1	
Insurance Status					<0.01
Privately insured	4734	63	702	72	
Medicaid	2768	37	276	28	
Charlson comorbidity index					0.18
0	7407	92	977	93	
1	359	4	39	4	
2	245	3	22	2	
3+	70	1	7	1	
Income (\$)					<0.01
<30,000	1049	15	76	8	
30,000-34,999	1256	17	116	12	
35,000-45,999	2025	28	284	31	
46,000+	2892	40	450	49	
Distance from treatment, miles					0.02
<50	5349	72	643	67	
51-200	1733	23	255	27	
>200	391	5	59	6	
Community type					<0.01
Metro	6413	83	892	90	
Urban	853	11	72	7	
Rural	485	6	27	3	
Histology					<0.01
Low-grade glioma	1862	24	114	11	
High-grade glioma	1803	23	99	10	
Ependymoma	1034	13	239	23	
Medulloblastoma	1967	25	379	37	
PNET	286	4	40	4	
Craniopharyngioma	59	1	9	1	
Germ cell tumors	350	4	59	6	
Meningioma	119	2	11	1	
ATRT	203	3	51	5	
Other	153	2	28	3	

TABLE 2. Univariable and Multivariable Predictors of Receipt of Proton Radiotherapy

Predictor	Univariate analysis			Multivariate analysis		
	Odds ratio	95% CI	P	Odds ratio	95% CI	P
Age (years)						
0-5	1.6	1.4-1.9	<0.01	1.3	1.1-1.6	0.01
6-10	1.3	1.1-1.6	<0.01	1.1	0.9-1.4	0.31
11-18	-	-	-	-	-	-
Year of diagnosis						
2004-2008	-	-	-	-	-	-
2009-2012	3.5	2.7-4.5	<0.01	4.2	3.2-5.7	<0.01
2013-2017	10	7.9-13	<0.01	11	8.5-15	<0.01
Race						
White	-	-	-	-	-	-
Black	0.48	0.38-0.63	<0.01	0.62	0.45-0.85	<0.01
Asian	1.2	0.87-1.6	0.28	1.1	0.77-1.6	0.56
Native American/Eskimo	1.4	0.72-2.8	0.31	1.4	0.54-3.4	0.52
Native HI/Pacific Islander	1.6	0.53-4.6	0.42	1.8	0.55-6.1	0.33
Other/Unknown	2.3	1.8-2.8	<0.01	2.3	1.7-3.1	<0.01
Ethnicity						
Non-Hispanic/unreported	-	-	-	-	-	-
Hispanic White	0.96	0.80-1.2	0.70	1.0	0.80-1.3	0.83
Hispanic Black	0.73	0.22-2.4	0.60	0.63	0.08-5.0	0.66
Insurance Status						
Privately insured	-	-	-	-	-	-
Medicaid	0.67	0.58-0.78	<0.01	0.62	0.51-0.75	<0.01
Charlson comorbidity index						
0	-	-	-	-	-	-
1	0.82	0.59-1.2	0.26	0.70	0.45-1.1	0.10
2	0.68	0.44-1.1	0.09	0.90	0.52-1.5	0.68
3+	0.76	0.35-1.7	0.49	1.0	0.38-2.6	0.98
Income (\$)						
<30,000	-	-	-	-	-	-
30,000-34,999	1.3	0.94-1.7	0.11	1.1	0.75-1.5	0.74
35,000-45,999	1.9	1.5-2.5	<0.01	1.5	1.1-2.0	0.02
46,000+	2.2	1.7-2.8	<0.01	1.6	1.2-2.3	0.01
Distance from treatment, miles						
<50	-	-	-	-	-	-
51-200	1.2	1.1-1.4	<0.01	1.4	1.2-1.8	<0.01
>200	1.3	0.94-1.7	0.12	1.6	1.1-2.5	0.02
Community type						
Metro	-	-	-	-	-	-
Urban	0.61	0.47-0.78	<0.01	0.72	0.53-0.99	0.05
Rural	0.4	0.27-0.59	<0.01	0.47	0.29-0.75	<0.01
Histology						
Low-grade glioma	-	-	-	-	-	-
High-grade glioma	0.9	0.68-1.2	0.44	0.82	0.59-1.2	0.25
Ependymoma	3.8	3.0-4.8	<0.01	3.9	2.9-5.2	<0.01
Medulloblastoma	3.2	2.5-3.9	<0.01	3.6	2.8-4.7	<0.01
PNET	2.3	1.6-3.3	<0.01	3.3	2.1-5.2	<0.01
Craniopharyngioma	2.5	1.2-5.2	0.01	1.9	0.72-5.3	0.19
Germ cell tumors	2.8	2.0-3.9	<0.01	3.4	2.2-5.0	<0.01
Meningioma	1.5	0.79-2.9	0.21	2.0	0.95-4.0	0.07
ATRT	4.1	2.9-5.9	<0.01	3.7	2.3-5.7	<0.01
Other	3.0	1.9-4.7	<0.01	3.6	2.1-6.2	<0.01

Methods: The National Cancer Data Base (NCDB) was queried to identify all pediatric patients with primary CNS malignancies treated with radiotherapy (RT) with curative intent from 2004 to 2017. Clinical characteristics and demographics were analyzed using standard T and χ^2 testing. Predictors of receipt of PR were identified with univariable and multivariable logistic regression.

Results: We identified 9,126 patients age \leq 18 years treated with RT between 2004 and 2017, of which 1,045 (11.5%) received PR. PR usage continued to increase significantly, from <1% in 2004 to 28% in 2017. This increase was most striking for ependymoma and medulloblastoma, where PR was utilized in 45% and 47% of cases, respectively, in 2017. The proportion of White and Asian patients receiving PR for non-high grade glioma and non-meningioma CNS malignancies over the study period rose from <1% for both to 35% and 44%, respectively, while in Black patients the proportion rose from <1% to 26%. Multivariable predictors of receipt of PR include year of diagnosis, age under 6 years, income level, distance from PR facility, and histology; multivariable predictors of receipt of non-proton radiotherapy include Black race, rural residence and Medicaid insurance. These factors remained significant when isolating the most recent five years of data.

Conclusions: The usage of PR for CNS malignancies continues to increase and has doubled over the last four years. Despite the potential clinical advantages to PR for pediatric primary CNS malignancies, there are notable socioeconomic, geographic and racial disparities in the receipt of PR that have persisted despite the increased availability and accessibility over the study period. Further study is warranted to identify how to address the disparities and better support these patients (Tables 1-3).

TABLE 3. Univariable and Multivariable Predictors of Receipt of Proton Radiotherapy Limited to Low Grade Glioma, Ependymoma, Medulloblastoma, Primitive Neural Ectodermal Tumors, Craniopharyngiomas, Germ Cell Tumors and Atypical Teratoid/Rhabdoid Tumors

Predictor	Univariate analysis			Multivariate analysis		
	Odds ratio	95% CI	P	Odds ratio	95% CI	P
Age (years)						
0-5	1.3	1.1-1.6	<0.01	1.3	1.1-1.7	<0.01
6-10	1.2	1.01-1.4	0.04	1.2	0.9-1.5	0.21
11-18	-	-	-	-	-	-
Year of diagnosis						
2004-2008	-	-	-	-	-	-
2009-2012	4.3	3.2-5.8	<0.01	5.0	3.6-6.8	<0.01
2013-2017	13	10-17	<0.01	13	9.7-17.8	<0.01
Race						
White	-	-	-	-	-	-
Black	0.48	0.36-0.63	<0.01	0.63	0.45-0.90	0.01
Asian	1.3	0.95-1.8	0.10	1.2	0.84-1.8	0.29
Native American/Eskimo	1.6	0.80-3.2	0.19	1.5	0.58-3.9	0.41
Native HI/Pacific Islander	1.6	0.46-5.8	0.45	1.6	0.40-6.6	0.50
Other/Unknown	2.2	1.7-2.8	<0.01	2.1	1.9-4.0	<0.01
Ethnicity						
Non-Hispanic/unreported	-	-	-	-	-	-
Hispanic White	0.87	0.71-1.1	0.20	0.94	0.71-1.2	0.66
Hispanic Black	0.56	0.13-2.4	0.43	0.70	0.08-5.8	0.74
Insurance Status						
Privately Insured	-	-	-	-	-	-
Medicaid	0.66	0.56-0.78	<0.01	0.62	0.50-0.76	<0.01
Charlson comorbidity index						
0	-	-	-	-	-	-
1	0.84	0.58-1.2	0.34	0.72	0.45-1.2	0.18
2	0.85	0.51-1.4	0.53	0.90	0.46-1.7	0.74
3+	1.2	0.49-2.8	0.73	1.5	0.54-4.3	0.42
Income (\$)						
<30,000	-	-	-	-	-	-
30,000-34,999	1.3	0.94-1.9	0.10	1.2	0.80-1.8	0.40
35,000-45,999	2.1	1.6-2.8	<0.01	1.7	1.2-2.4	0.01
46,000+	2.4	1.8-3.2	<0.01	1.9	1.3-2.7	<0.01
Distance from treatment, miles						
<50	-	-	-	-	-	-
51-200	1.26	1.06-1.49	0.01	1.6	1.3-2.0	<0.01
>200	1.35	0.98-1.87	0.07	1.7	1.1-2.7	0.02
Community type						
Metro	-	-	-	-	-	-
Urban	0.65	0.50-0.85	<0.01	0.76	0.54-1.1	0.11
Rural	0.40	0.26-0.61	<0.01	0.46	0.27-0.78	<0.01
Histology						
Low-grade glioma	-	-	-	-	-	-
Ependymoma	3.8	3.0-4.8	<0.01	3.9	2.9-5.2	<0.01
Medulloblastoma	3.2	2.5-3.9	<0.01	3.6	2.8-4.7	<0.01
PNET	2.3	1.6-3.3	<0.01	3.3	2.1-5.3	<0.01
Craniopharyngioma	2.5	1.2-5.2	0.01	1.9	0.70-5.2	0.21
Germ cell tumors	2.8	2.0-3.9	<0.01	3.4	2.2-5.1	<0.01
ATRT	4.1	2.9-5.9	<0.01	3.7	2.4-5.8	<0.01

(P163) A Dose Accumulation Assessment of Alignment Errors During Spatially Fractionated Radiation Therapy

John Ginn, PhD¹, Sai Duriseti, MD, PhD¹, Thomas Mazur, PhD¹, Matthew Spraker, MD, PhD¹, James Kavanaugh, PhD²; ¹Department of

Radiation Oncology, Washington University School of Medicine in St. Louis, ²Washington University School of Medicine

Background: Spatially-fractionated radiotherapy (SFRT) treatment techniques produce high-dose peaks and low-dose valleys by interweaving a matrix of high- and low-dose spheres through a technique termed Lattice. Due to the highly localized spatial dose gradients associated with SFRT, it is critical for patients be aligned correctly for treatment.

Objectives: Here we report the dosimetric impact of daily alignment setup uncertainty through a dose accumulation study.

Methods: Dose accumulation was retrospectively performed for ten patients enrolled on a completed prospective trial evaluating Lattice for large tumors (NCT04133415). SFRT was completed in 5 fractions with 20 Gy prescribed to the entire tumor volume and 66.7 Gy prescribed to the high-dose spheres of 1.5cm diameter. Daily alignment error was quantified through a landmark analysis with paired landmarks manually selected in both the planning computed tomography (CT) scan and the registered daily cone beam CT image. The dosimetric impact of alignment errors was quantified by translating the isocenter in the treatment planning system by the daily average alignment error for each fraction. To understand the effect of varying magnitude and frequency of alignment errors, we also performed a simulated error analysis by translating isocenter by 5 mm and 10 mm for one and two fractions, with alignment errors separately assessed for the superior-inferior and axial dimensions. We hypothesized misalignment errors will reduce the volume of tumor receiving both 66.7 Gy and 20 Gy while also blurring the dose gradient between the high- and low-dose spheres. Therefore, we quantified the ratio of the mean dose in the high-dose and adjacent low-dose spheres (DR) as well as the mean dose (Dmean) and standard deviation of the mean in the 1.5 cm ring surrounding the high-dose spheres.

Results: The total average and standard deviation alignment error was 1.8 mm and 0.6 mm across all patients. Visual inspection revealed alignment errors tend to blur the edges of the high- and low-dose distributions. Quantitatively, mean DR decreased from 3.42 to 3.32 in the dose accumulation study. On average Dmean in the 1.5 cm ring was 35.5 Gy in both the initial plans and accumulated dose, while the standard deviation of the dose in this region decreased by 25.5 cGy from the initial plan to 10.7 Gy. The simulated worst case was an inferior-superior shift of 10 mm for two fractions. In this case average DR decreased to 2.72, and the Dmean and standard deviation of the dose in the surrounding ring decreased 24.5 cGy and 148.0 cGy, respectively.

Conclusions: The dose accumulation study revealed on average DR only decreased from 3.42 to 3.32. However, setup errors > 5 mm result in larger dosimetric degradation than those observed clinically. As indicated by our simulation study, even a single large setup error can substantially reduce the DR and overall SFRT plan quality,

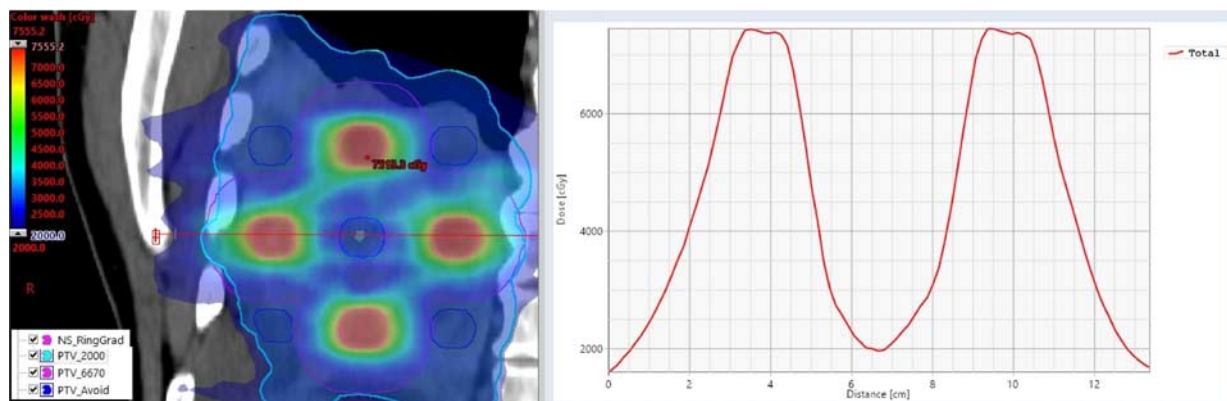

FIGURE 1. Example of a spatially fractionated dose distribution. A coronal view of a spatially fractionated dose distribution showing the high- and low-dose spheres dispersed throughout the target.

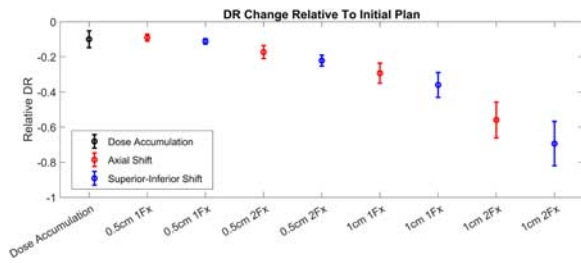

FIGURE 2. Relative change in mean dose ratio. The change in mean dose ratio relative to the initial plan. The results are displayed for the dose accumulation study utilizing the alignment errors from the landmark analysis (black), the axial simulated shifts (red) and superior-inferior simulated shifts (blue).

emphasizing the importance of accurate daily alignment during fractionated SFRT (Figs. 1 and 2).

(P164) Dosimetry Comparison of Palliative Radiation Plans Generated from Available Diagnostic CT Images versus Dedicated CT Simulation for Inpatients

Quoc-Anh Ho, MD¹, Lexie Smith-Raymond, MAdm, BS, RT(R)(T), CMD², Angela Locke, BS, RT(T), CMD², Jared Robbins, MD³; ¹The University of Arizona, ²Banner Health, ³The University of Arizona College of Medicine - Tucson

Background: The morbidity sequelae of advanced cancer are often irreversible. Early palliative radiation can prevent, delay, and even improve these consequences. Treatment may be delayed due to a packed CT (computed tomography) simulation schedule or other logistics including the cost and burden of arranging ambulance transportation when radiation centers are off-site.

Objectives: The primary objective was to determine the feasibility of using a recent diagnostic CT scan in lieu of a dedicated simulation CT to generate an adequate plan without sacrificing dosimetric goals and subsequent efficacy or tolerability. Secondary objectives included how much the lesion has grown, and how much earlier treatment could start if planned on a diagnostic CT scan.

Methods: For each inpatient treated with palliative radiation, a prior recent diagnostic CT scan was imported into the RayStation (RaySearch Laboratories, Stockholm, Sweden) planning system. From these diagnostic scans, planning treatment volumes (PTV) and organs at risk (OAR) were contoured using the same technique as the patient's actual treatment. The primary outcome was to compare both the PTV coverage and OAR dose between the plan generated from the diagnostic CT compared with that from the simulation CT. Our secondary outcomes include mean time between CT simulation and first treatment, change in tumor volume between diagnostic scan and CT simulation, and the hottest 1% of each plan (D1).

Results: Between May and August 2019, a total of 22 inpatients were treated palliatively. Of those 22 patients, 10 patients (ages 32-92 y, median 64.5 y, 50% spine) met study criteria and had a diagnostic CT scan that was obtained within 14 days of simulation CT that was also compatible with our planning software. In the plans that were delivered, a mean of 98.8% (range 94.4-100%) of PTV was covered by at least 95% prescription dose. In the diagnostic CT plans, a mean of 95.4% (range 84.5-100%) of PTV was covered by at least 95% prescription dose. The difference between plans trended towards significance ($P=0.061$). When looking at patients receiving treatment to the spine or having a diagnostic CT within 4 days of the simulation CT, there was no statistically significant difference between the two plans ($P=0.032$ and 0.030 , respectively). The OARs received on average, 1.4% less mean radiation dose in the hypothetical plans ($P=0.911$). All OAR constraints were met in both groups. The mean time between diagnostic CT and CT simulation was 5.9 days, and between CT

simulation and first treatment was 1.9 days (range 0-5 d). The mean change in tumor volume was 22.64% smaller in the diagnostic CT scan plan. The D1 was an average 1% hotter in the hypothetical plans ($P=0.16$).

Conclusions: In hospitalized patients with an indication for palliative radiation, treatment planning on a pre-existing recent diagnostic CT scan produces comparable dose distributions without increases in dose to OARs when compared with the use of CT simulation scans, particularly for treatment of the spine or when a very recent diagnostic CT is available. Bypassing CT simulation in select cases allows for earlier delivery of radiation with less patient and logistical burden. In combination with daily image-guidance, this may translate to more timely delivery of radiation, less cost and burden to critically ill patients, and improved palliative benefit.

(P165) Assessment and Development of Plan Quality Metrics for Spatially Fractionated Radiation Therapy

James Kavanaugh, PhD¹, John Ginn, PhD², Sai Duriseti, MD PhD², Thomas Mazur, PhD², Matthew Spraker, MD, PhD²; ¹Washington University School of Medicine, ²Department of Radiation Oncology, Washington University School of Medicine in St. Louis

Background: Spatially fractionated radiation therapy (SFRT) delivers highly heterogeneous dose distributions (100-30% variation) within a tumor and has been shown to be an effective treatment for large solid tumors (Amendola, et al Radiation Research 2020, Wu, et al Radiation Research 2020). Modern SFRT can be delivered with volumetric modulated radiation therapy (VMAT) via a technique known as Lattice, in which the internal dosimetric gradients are achieved using optimization structures (high- and low-dose spheres) placed within the tumor. Standard plan quality metrics used to define dose to the target are insufficient in assessing the quality and consistency of the dose distributions of SFRT.

Objectives: This study investigated several potential metrics to quantify the heterogeneous SFRT dose within the gross tumor volume (GTV) using existing evaluation tools within modern planning systems.

Methods: Plan quality metrics were assessed using 23 Lattice treatment plans delivered as part of a Phase I clinical trial (NCT04133415). The periphery of the high-dose spheres received a prescription of 66.7 Gy and the low-dose spheres and periphery of the PTV received a prescription of 20 Gy delivered in 5 fractions (Duriseti, et al, Advances in Radiation Oncology, 2021). Metrics included EUDA=-10, ratio of the mean dose within the high-dose and low-dose spheres (DR), and ratio of the mean and standard deviation dose within a 1.5cm ring surrounding the high-dose spheres (DR_1.5) (Fig. 1). For each metric, outliers were defined as individual values that were above/below the first/third quartile by at least 1.5 times the interquartile range. The plan quality, including dosimetric gradients within the GTV, for outliers for each metric were compared with the plan quality of the entire patient cohort to determine if any observable dosimetric difference existed. Dosimetric profiles comparing outlier cases to non-outlier cases of comparable GTV volume were evaluated.

Results: Two DR outliers (plan #11 and #12 in Fig. 2) and a single DR_1.5 outlier (plan #11 in Fig. 2) were identified, with no outliers identified for the EUDA=-10. Dosimetric profiles comparing plan #11 (GTVvol=3714cc) to plan #21 (GTVvol=3616cc) were taken through the center of aligned high- and low-dose spheres in the axial plan, with a representative example shown in Figure 1. The achieved dose gradients within plan #11 visibly broader, with doses >20 Gy extending into the low-dose spheres. Both plan #11 and #12 were for the same patient and represented one of the first set of plans from a newly trained dosimetrist.

Conclusions: The review of three quantifiable metrics (EUDA=-10, DR, and DR_1.5) within 23 Lattice plans indicates that both DR and DR_1.5 are sensitive to gradient difference within the GTV. These metrics offer the potential for translation of Lattice planning experience to include easy-to-quantify metrics as surrogates for consistency in the achieved GTV dose heterogeneity.

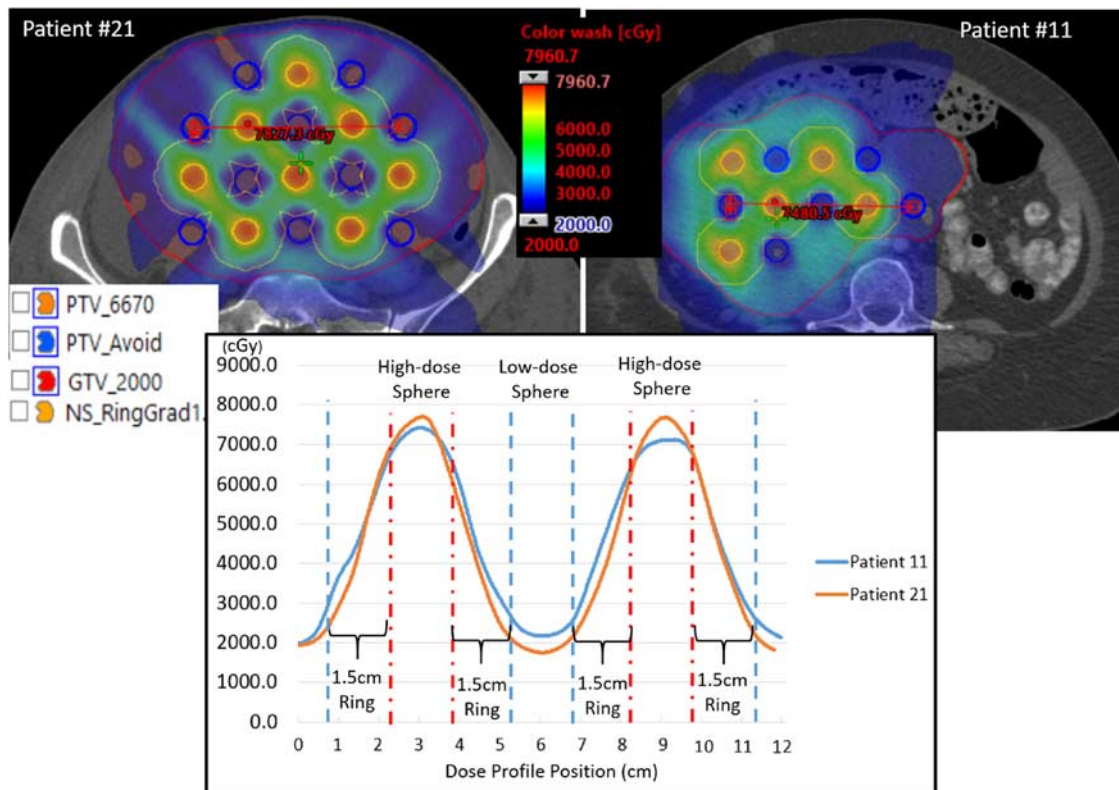

FIGURE 1. Dose distribution and profile comparison for two lattice cases. Comparison of dose distribution and gradients for outlier case (patient #11) and similar volume abdominal patient (patient #21). Broader dose gradients in the outlier case correspond to the DR and DR_1.5cm metrics.

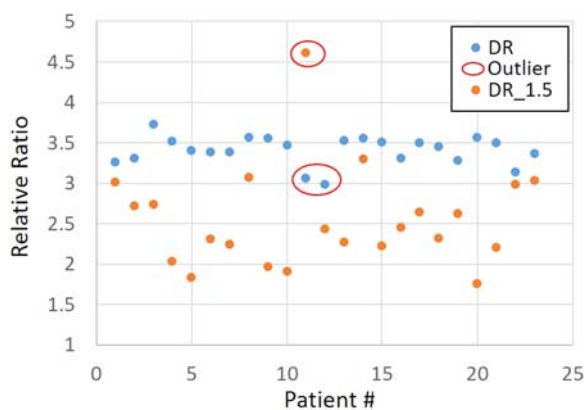

FIGURE 2. Computed DR and DR_1.5 metrics for 23 patient population. Ratios for both the DR and DR_1.5 metrics across the 23 patient population. Outliers for both metrics are shown in the red circles.

(P166) IMRT Treatment Planning Study for the First Clinical Biology-guided Radiotherapy System

Nataliya Kovalchuk, PhD¹, Daniel Pham, MS¹, Dylan Breikreutz, PhD¹, Eric Simiele, PhD¹, Dante Capaldi, PhD¹, Lucas Vitzthum, MD, MAS², Daniel Chang, MD³; ¹Stanford Radiation Oncology, ²Stanford University Radiation Oncology, ³Stanford University

Background: The first clinical biology-guided radiotherapy (BgRT) system—RefleXion X1 - is installed and being commissioned for clinical use at our institution. RefleXion X1 is a 6MV-FFF linac mounted on a ring gantry rotating at 60 rpm while the couch advances in 2.1mm increments. The modulation is achieved via 50 firing positions with 64 binary MLCs (6.25mm at 85cm SAD) with either 1cm or 2cm jaws.

Objectives: This study was conducted to compare the treatment plan quality for IMRT cases without PET-guidance.

Methods: Nineteen patients previously treated with VMAT on C-arm linacs were selected for this retrospective study including 8 prostate cancer patients (80 Gy/40fx), 6 lung cancer patients (66 Gy/30fx) and 5 post-surgical parotid cancer patients (60 Gy–66 Gy/30fx). For each VMAT plan, a corresponding plan was generated on the RefleXion treatment planning system (TPS) using our institutional planning constraints. All clinically relevant metrics in this study, including plan PTV

TABLE 1. Comparison of Average Dosimetric Indices for Head and Neck, Lung, and Prostate Cases

Head and Neck					Lung					Prostate				
Structure	Mean VMAT	Mean Reflexion	Mean Difference (Reflexion - VMAT)	P-value	Structure	Mean VMAT	Mean Reflexion	Mean Difference (Reflexion - VMAT)	P-value	Structure	Mean VMAT	Mean Reflexion	Mean Difference (Reflexion - VMAT)	P-value
PTV D95%, %	100.0%	100.8%	0.8	0.13	PTV D95%, Gy	66.0	66.4	0.4	0.05	PTV D95%, Gy	80.0	80.1	0.1	0.10
PTV D1%, %	104.5	103.8	-0.7	0.10	PTV D1%, %	105.8	105.6	-0.2	0.35	PTV D1%, %	105.6	105.6	0.0	0.50
CI	1.044	1.097	0.053	0.15	CI	1.052	1.065	0.012	0.33	CI	0.993	1.006	0.013	0.78
BRAINSTEM Dmax, Gy	19.3	14.5	-4.8	0.008*	BRONC_TREE Dmax, Gy	65.6	64.0	-1.6	0.13	BLADDER V80, %	8.0	7.5	-0.5	0.05
COCHLEA_ipsi Dmean, Gy	21.5	15.1	-6.4	0.09	ESOPHAGUS Dmean, Gy	16.1	13.8	-2.3	0.039*	BLADDER V75, %	10.6	10.0	-0.6	0.08
COCHLEA_contra Dmean, Gy	9.7	5.0	-4.8	0.01*	ESOPHAGUS Dmax, Gy	47.0	45.2	-1.8	0.05	BLADDER V70, %	12.4	112.8	-0.5	0.10
ESOPHAGUS Dmean, Gy	2.7	2.0	-0.7	0.025*	HEART V30, %	4.4	2.7	-1.7	0.025*	BLADDER V65, %	14.2	13.9	-0.4	0.21
SUBMIND_ipsi Dmean, Gy	39.9	37.2	-2.7	0.025*	HEART V45, %	2.0	1.6	-0.4	0.12	FEMUR_L_Dmax, Gy	40.3	35.5	-4.8	0.001*
SUBMIND_contra Dmean, Gy	9.3	6.0	-3.2	0.04*	HEART Dmax, Gy	64.5	64.2	-0.3	0.39	FEMUR_LV45, %	1.1	0.2	-0.9	0.11
GLOTTIS Dmean, Gy	10.2	6.7	-3.6	0.06	HEART Dmean, Gy	5.6	5.2	-0.4	0.21	FEMUR_LV40, %	2.8	1.0	-1.8	0.09
LARYNX Dmean, Gy	16.8	13.9	-2.9	0.15	LUNG_ipsi V5, %	59.5	60.6	1.2	0.16	FEMUR_R_Dmax, Gy	41.0	35.9	-5.0	0.001*
LIPS Dmax, Gy	18.8	15.4	-3.5	0.007*	LUNG_ipsi V20, %	37.6	40.0	2.5	0.17	FEMUR_RV45, %	0.9	0.2	-0.7	0.10
MANDIBLE Dmax, Gy	63.5	63.5	0.0	0.46	LUNG_ipsi Dmean, Gy	18.0	18.4	0.4	0.25	FEMUR_RV40, %	3.4	0.9	-2.5	0.07
OPTIC_NRV_L Dmax, Gy	2.2	1.8	-0.4	0.039*	LUNG_contra V5, %	45.0	44.2	-0.7	0.43	PENILE_BULB Dmean, Gy	25.9	27.1	1.2	0.06
OPTIC_NRV_R Dmax, Gy	2.2	1.4	-0.8	0.043*	LUNG_contra V20, %	2.2	2.9	0.7	0.02*	RECTUM V75, %	11.3	9.7	-1.6	0.01*
ORAL_CAVITY Dmean, Gy	14.8	15.9	1.1	0.21	LUNG_contra Dmean, Gy	5.4	5.9	0.6	0.17	RECTUM V70, %	14.7	13.3	-1.4	0.05
PAROTID_contra Dmean, Gy	4.8	4.6	-0.3	0.26	SPINAL_CORD Dmax, Gy	27.4	23.8	-3.6	0.001*	RECTUM V65, %	17.9	16.6	-1.2	0.10
PHARYNX Dmax, Gy	17.6	16.8	-0.8	0.27	TRACHEA Dmax, Gy	53.0	50.8	-2.3	0.18	RECTUM V60, %	21.0	19.9	-1.1	0.18
SPINAL_CORD Dmax, Gy	20.3	14.4	-5.9	0.06	VESSEL_AORTA Dmax, Gy	69.7	69.4	-0.4	0.19					

Colors signify Reflexion plan superiority (green) or inferiority (red).

D95%, PTV D1%, Conformity Index (CI), and organs at risk constraints were analyzed and compared between the VMAT and Reflexion plans using paired t-tests.

Results: Clinically acceptable plans were obtained with both techniques. For the prostate, lung, and head and neck sites, no statistically significant difference was observed in PTV D95%, PTV D1%, or CI between the VMAT and Reflexion treatment plans. Due to inherent OAR dose penalties in the Reflexion optimizer, dose reduction to certain critical structures was observed in Reflexion plans: brainstem Dmax (-4.8 Gy, $P < 0.008$), contralateral cochlea Dmean (-4.8 Gy, $P < 0.01$), lips Dmax (-3.5 Gy, $P < 0.007$) for head and neck cases; esophagus Dmean (-2.3 Gy, $P < 0.039$), spinal cord Dmax (-3.6 Gy, $P < 0.001$) for lung cases; femurs left and right Dmax (-4.8 Gy, $P < 0.003$ and -5.0 Gy, $P < 0.01$) and rectum V75% (-1.6%, $P < 0.01$) for prostate cases.

Conclusions: The Reflexion TPS provided comparable plan quality to VMAT plans (Table 1).

(P167) Lower Baseline Apparent Diffusion Coefficient Values Associated with Poor Prognosis in Locally Advanced Pancreatic Cancer

Anna Laucis, MD, MPhil¹, Yilun Sun, PhD¹, Yue Cao, PhD¹, Theodore Lawrence, MD, PhD, FASTRO¹, Mahmoud Al-Hawary, MD², Thomas Chenevert, PhD², Kyle Cuneo, MD¹; ¹University of Michigan Department of Radiation Oncology, ²University of Michigan Department of Radiology

Background: A challenge in locally advanced pancreatic cancer is the difficulty in obtaining adequate tumor tissue to personalize therapy. Non-invasive diffusion magnetic resonance imaging (dMRI) has the potential to tell us about the biology of a tumor and its responsiveness to therapy. Our prior work found a significant association between pre-treatment apparent diffusion coefficient (ADC) and pathological response in patients with resectable pancreatic cancer undergoing pre-operative chemoradiation.

Objectives: The goal of the current study was to prospectively investigate the relationship between dMRI characteristics and outcomes after chemoradiation in locally advanced pancreatic cancer patients.

Methods: Patients with locally advanced pancreatic cancer were prospectively enrolled onto an IRB-approved clinical trial investigating dMRI characteristics at multiple time points before and during chemoradiation. Each pancreatic tumor was delineated by two radiation oncologists on T1-weighted MRI and dMRI images. Baseline and mid-treatment ADC values were then analyzed and compared with clinical outcomes including time to local failure (TTLF), time to distant failure (TTDF), progression free survival (PFS), and overall survival (OS). Additionally, CA-19-9 values were obtained for each patient pre-radiation and at four months post-

radiation and compared with clinical outcomes. Univariable Cox proportional hazard models, Student's t-tests, and Kaplan Meier methods were used for statistical analysis.

Results: A total of 23 MRI scans were obtained in nine patients receiving gemcitabine-based chemoradiation. There were six male and three female patients, with median age of 64 years (range 52-73). The median PFS was 18 months and median OS was 25.3 months from diagnosis for the cohort. Pre-treatment baseline MRIs were obtained a median of 25 days (range 1-35) before radiation. We found a significant association between lower baseline ADC values and several clinical outcomes. Specifically, lower mean baseline tumor ADC values were associated with lower OS, lower PFS, shorter TTLF, and shorter TTDF. The difference between baseline and mid-treatment ADC values were also found to be significantly different between patients with and without distant failure (Fig. 1, $P = 0.049$). In comparison, there was no significant relationship between CA-19-9 lab values or mid-treatment ADC with any clinical outcome. Table 1 summarizes the baseline and mid-treatment ADC value results.

Conclusions: Lower baseline tumor ADC values were found to significantly correlate with clinical outcomes including worse survival in locally advanced pancreatic patients. This is concordant with prior studies showing poor pathological responses in resectable pancreatic cancer patients with lower baseline ADC values. Further research is needed in a larger cohort of patients to study how this non-invasive imaging biomarker may help with clinical decision-making and treatment planning.

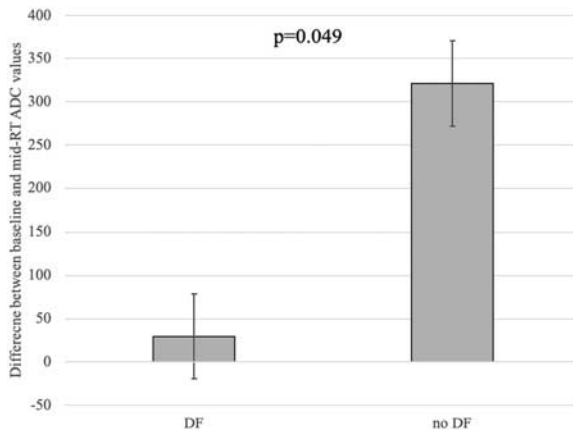

FIGURE 1. Difference between baseline and mid-radiation (mid-RT) ADC values were significantly different for patients with and without distant failure (DF), $P = 0.049$.

TABLE 1. Cox Proportional Hazards Model of Mean Pancreatic Tumor ADC

Timepoint	Endpoint	Hazard Ratio	95% CI	p-value
Baseline	OS	0.65	0.4–1.0	0.0496
Baseline	PFS	0.54	0.3–0.9	0.01
Baseline	TTLF	0.18	0.04–0.8	0.02
Baseline	TTDF	0.54	0.3–0.9	0.03
Mid-RT	OS	1.13	0.8–1.6	0.51
Mid-RT	PFS	1.08	0.8–1.5	0.65
Mid-RT	TTLF	0	0–Inf	0.99
Mid-RT	TTDF	0.65	0.4–1.1	0.13

(P168) A Diode-based 64X64 X-ray Detector for Cancer Radiotherapy

Mekhail Anwar¹, Kyoungtae Lee², Bruce Faddegon¹, Jessica Scholey¹, Kavita Mishra¹, Michel Maharbiz²; ¹UCSF, ²UC Berkeley

Background: The ability to monitor radiation dose delivered in real time to the tumor and organs at risk (OAR), is critical for radiotherapy quality and safety, particularly for targets subject to motion or near critical OARs. A highly sensitive in vivo microdosimeter (IVμD) implanted within the tumor and OAR via biopsy needle solves this problem by monitoring and relaying the dose delivered within the patient in real time. We have developed a real time millimeter IVμD [1]. We hypothesize that the device is capable of measuring photons via secondary electrons generated by pair production and Compton scattering. Here we present the first results for photon detection: the IVμD is capable of counting the number of secondary electrons generated by x-ray photons with the form factor and power consumption compatible with in vivo implantation.

Objectives: An IVμD must satisfy the following requirements: 1) measure and relay dose in real-time, 2) be millimeter scale for implantation through a core biopsy needle, 3) high sensitivity, and 4) low power (to minimize battery size or wireless power transfer requirements). To accomplish these requirements, we exploit CMOS fabrication technology (i.e. ‘computer chip technology’) that enables direct integration of complex circuitry with highly sensitive sensing elements in a small form factor.

Methods: A P-N diode was used to detect the secondary electrons generated from a photon interacting with the silicon. About 1/3 of the energy deposited in the depletion region creates electron-hole pairs (EHPs), which are then integrated on a nearby capacitor, transforming to a voltage pulse. Because the voltage pulse amplitude is inversely proportional to the parasitic capacitance, a nearly minimum size of 1X1μm² P-type diode was used to maximize the signal. To readily detect photons while preserving sensor sensitivity, the diodes are arrayed in a 64X64 structure. Each pixel has its own amplifying circuit resulting in a total detection area of 512X512 μm² with the fill factor of 1/64. The duration of the voltage pulse (PW - pulse width) is quantized by a 10-bit digital converter, the PW and pixel location on chip are conveyed off chip. The device was tested under Siemens Avant-Garde clinical 6 MeV X-ray linear accelerator. The total radiated dose was 5 Gy with 3 Gy/min dose rate.

Results: At baseline, the flux (0 Gy/min) is 0 counts/sec. At 3 Gy/min, the response is near instantaneous, and measured flux was 4,097 counts/seconds/mm². The standard deviation of the flux when the beam is on is 32.9 counts/sec/mm².

Conclusions: A new diode based 64X64 X-ray detector was developed and verified under the clinical beam setting. We envision that the proposed work can be used to improve the effectiveness of the cancer radiotherapies.

(P169) Normal Tissue and Tumor Segmentation Using V-Net Regularized by YOLO

John Lucas, K.¹, Chih-Yang Hsu, PhD¹; ¹St. Jude Childrens Research Hospital

Background: Automated tumor segmentation from Fluorodeoxyglucose (18FDG)-positron emission tomography and computed tomography (18FDG-PET/CT) has the potential to aid diagnosis and

treatment response evaluation in multiple tumor systems. Manual delineation is time consuming and subject to human bias. Conventional segmentation methods are often obscured by radiotracer uptake from normal tissues, including brain, heart, liver, bilateral kidneys, and bladder. Specifically, heart, liver, and kidneys are variably avid on routine 18FDG-PET examinations, imposing additional challenge for accurate segmentation.

Objectives: In this work, we propose a semantic segmentation network based on autoencoder architecture reinforced by an object detection branch for segmenting normal tissue and tumor from 3D 18FDG-PET/CT. The autoencoder network consists of symmetrical encoder and decoder with ResNet blocks and skip connections. The object detection branch is derived from You only look once (YOLO) -real time object detection which is added at the end of the encoder. Our hypothesis is that the object detection branch not only regularizes the network but also imposes location constraints based on anatomy.

TABLE 1. Encoder and Decoder Structure

Layers	Size
Input	128x128x256x2
3x3x3 Convolution	128x128x256x32
Identity Skip Connection	
Downsampling with 3x3x3 convolution stride 2	
3x3x3 Convolution	64x64x128x32
Identity Skip Connection	
Downsampling with 3x3x3 convolution stride 2	
3x3x3 Convolution	32x32x64x32
Identity Skip Connection	
Downsampling with 3x3x3 convolution stride 2	
3x3x3 Convolution	16x16x32x32
Identity Skip Connection	
Downsampling with 3x3x3 convolution stride 2	
3x3x3 Convolution	8x8x16x32
Identity Skip Connection	
Layers	Size
Encoder Output	8x8x16x32
Upsampling with 3x3x3 transpose convolution stride 2	
Concatenation	
3x3x3 Convolution	16x16x32x32
Upsampling with 3x3x3 transpose convolution stride 2	
Concatenation	
3x3x3 Convolution	32x32x64x32
Upsampling with 3x3x3 transpose convolution stride 2	
Concatenation	
3x3x3 Convolution	64x64x128x32
Upsampling with 3x3x3 transpose convolution stride 2	
Concatenation	
3x3x3 Convolution	128x128x256x32
Dropout	
1x1x1 Convolution	128x128x256x8

The encoder starts with a 1x1x1 convolution and uses ResNet blocks [12] where each block consists of three convolutions with ReLU activation followed by identity skip connection. After skip connection, the image dimensions are downsampled using convolutions with strides of 2 and kernel size 3x3x3. We repeat the process four times and reach an encoder output size of 8x8x16. All convolutions are 3x3x3 in kernel size and 32 filters. Table 1 outlines the encoder structure. The number of convolutions at each level of the decoder and is thus symmetrical to the encoder. Each level begins with upsampling by a factor of 2 using transpose convolution followed by concatenation from matching encoder level. ResNet blocks with three convolutions and ReLU is then applied and the process is repeated four times. A dropout layer with rate of 0.5 is connected before the final convolution layer of 1x1x1 kernel size for dense inference of eight classes with softmax activation. Table 2 outlines the decoder structure.

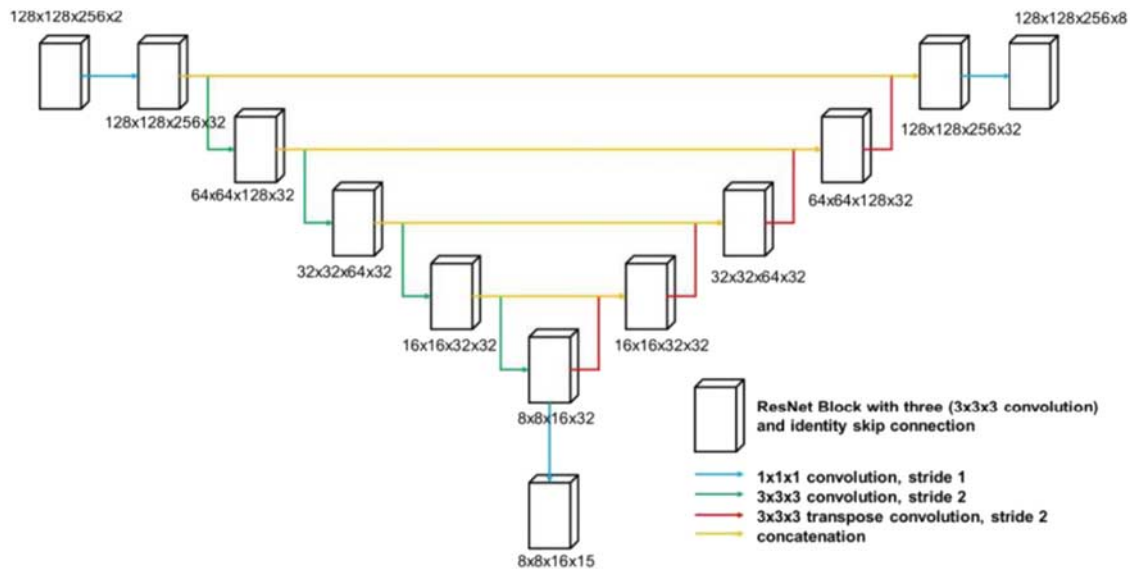

FIGURE 3. Proposed network structure. The proposed approach utilizes autoencoder based convolutional neural network (CNN) architecture with a symmetrical encoder and decoder. The object detection branch is added at the end of the encoder.

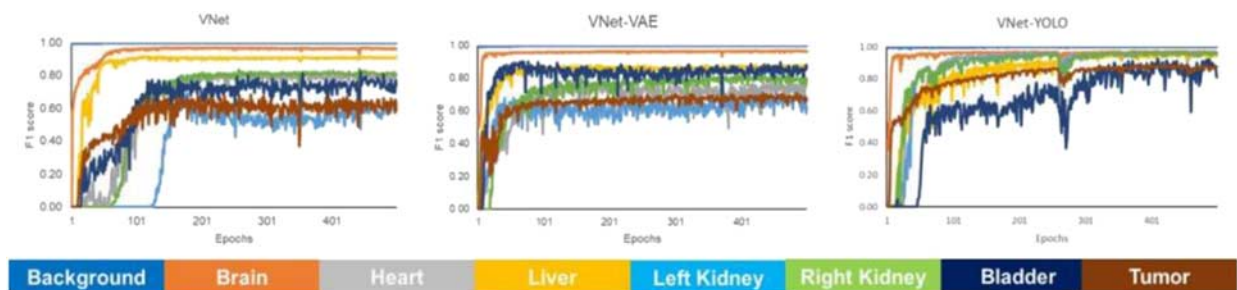

FIGURE 4. Shows the average F1 score for each class in the validation set throughout training.

Methods: We test our hypothesis in a limited cohort consists of 34 pediatric patients with Hodgkin lymphoma with pre-treatment PET/CT images. We used F1 score and Hausdorff distance at 95th percentile to quantify segmentation accuracy and compare the results with established networks.

Results: The proposed method achieved the overall best segmentation accuracy and improved the average F1 score by 0.19 in normal tissues and tumor segmentation compared with V-Net. The overall Hausdorff distance improved by 83% compared with V-Net.

Conclusions: Automatic detection and segmentation of normal tissues and tumors by combining segmentation and regularization networks substantially improves the clinical detection and treatment response evaluation of PET and CT images relative to existing models (Table 1 and Figs. 3, 4).

(P170) Large Random Sporadic Patient-Specific Stereotaxic Uncertainties Demand a New Workflow for Frame-Based Intracranial Radiosurgery

LIJUN MA, PhD¹, Nam Woo Cho, MD, PhD¹, Benjamin Ziemer, PhD¹, Lauren Boreta, MD², Penny Sneed, MD¹, Steve Braunstein, MD, PhD¹; ¹UCSF School of Medicine, ²UCSF

Background: Frame-based MR-imaging-only stereotaxy has been the gold standard for single-fraction intracranial radiosurgery. With advent of integrated online 3D stereotactic imaging such as voxel-by-voxel

mapped Gamma Knife Icon platform, small patient-specific uncertainties associated with rigid frame-based MR-imaging-only stereotactic definition can now be promptly quantified before treatment delivery.

Objectives: In this study, we investigated patient-specific uncertainties associated with classic rigid metal frame-based MR-imaging-only stereotactic definitions specific to single-fraction stereotactic radiosurgery.

Methods: Pre-treatment phantom-based stereotactic definition measurements as well as pre-treatment patient-specific stereotactic definition measurements were performed for a randomly sampled patients undergoing brain radiosurgery (N=16) treated since 2016 at our institution, with the most common indication of trigeminal neuralgia, with voxel-by-voxel stereotactic mapping available with use of a stereotactic CBCT (sCBCT) unit. Independent patient-specific measurements were performed with sCBCT scans as well as stereotactic serial CT (ssCT) scans in conjunction with the classic frame-based MR-imaging-only stereotactic definitions. The phantom measurements were performed via a Elekta grid phantom as previously reported. Pre-treatment patient-specific measurements were performed via comparing identical MR imaging studies that mapped stereotactic coordinates via (1) stereotactic localizer box attached to the frame for conventional stereotactic MR scans with a slice thickness of 0.6 mm to 1.5 mm, (2) stereotactic localizer box attached to the frame for independent ssCT scans, and (3) sCBCT scans acquired immediately before the treatment delivery. For each case, 6-12 anatomical and/or device landmarks were first identified via auto-segmentation of the same window/level/

thresholding, and the stereotactic coordinates of these landmarks were then compared across the different stereotactic definition methods.

Results: Pre-treatment phantom measurements produced < 0.8 mm deviations among all three stereotactic definition methods in agreement with our previous studies. However, discrepancy among three stereotactic definitions ranged from 0.2 to 2.5 mm (0.81 ± 0.67 mm) among patient cases studied. Large shifts > 1.0 mm were predominately observed in the peripheral brain region and mostly along the longitudinal z-axis. These shifts were random and sporadic across MR scanning sequences, slice thickness, target sizes, isocenter locations, and the patient head-tilt angles for the setups. Of note, such shifts were within 1.0 mm when only comparing ssCT and sCBCT based measurements for the studied cases.

Conclusions: Sporadic patient-dependent uncertainties exceeding 2 mm were observed with conventional frame-based MR-imaging-only stereotactic definitions. Such a result is alarming and demands further investigations toward independent validations of stereotaxy, review of clinical outcomes and possible revision of the workflow for the current frame-based brain radiosurgery.

(P171) GammaKnife Auto-planning Using Artificial Intelligence: A Preliminary Comparison of ML and DL Treatment Planning Parameters for Vestibular Schwannoma

Lijun, MA, PhD¹, Tom Nano, PhD², Christopher Pang, MSc³, Yannet Interian, PhD³, Gilmer Valdes, PhD⁴, Olivier Morin, PhD⁴; ¹UCSF School of Medicine, ²University of California San Francisco, ³USF, ⁴UCSF

Background: Gamma Knife treatment planning is a manual and iterative approach that is tedious, time-consuming and produces highly variable plans which depends on planner patients and experience. Consequently, automatic and inverse planning techniques have been previously developed. However, automatic planning methods are not clinical implemented due to poor performance. The purpose of this work is to develop artificial intelligence models that predict treatment planning parameters for vestibular schwannoma cases.

Objectives: The objectives of this work are to develop and compare machine learning (ML) and deep learning (DL) models for predicting treatment planning parameters (number of shots, shot coordinates, shot weights and collimator settings) and the dosimetry impact of prediction errors.

Methods: A total of 223 vestibular schwannoma cases treated on Leksell Gamma Knife Icon with a frame setup were used to build ML and DL models. Each case consisted of a single target prescribed to 12.5 Gy to the 50% isodose line. The range of target sizes was 0.7–6.1 cc and the range of shots used were 1–61, varying in weight and collimator settings that were manually planned by three experienced physicist. MR images, target masks and organs-at-risk masks (cochlea and brainstem) were used as model inputs. A linear regression ML model with Lasso regularization was trained on radiomic image features extracted from MR images multiplied by the target mask. A 3D convolutional neural network (ResNet-34 architecture) was trained on 3-channel inputs containing MR image, target mask and OAR masks. An 80/20 data split was used for training and testing subsamples and mean-squared error (MSE) and R2-score was used to evaluate model predictions.

Results: The ML model has a MSE mean of 53.77 and 31.48 in the training and test datasets respectively for all treatment planning parameters predicted. The R2 score in the test dataset was 0.63, showing a good-fit for our ML regression model. The DL model has a MSE mean of 0.15 and 75.21 in the training and test datasets respectively for all treatment planning parameters predicted. The R2 score in the test dataset was 0.42, showing a worst correlation in the DL model predictions relative to ML predictions.

Conclusions: We have developed ML and DL model for predicting Gamma Knife treatment planning parameters (number of shots, shot coordinates, shot weights and collimator settings). Model predictions from ML are more generalizable to out-of-sample performance than DL predictions, indicating that ML models are superior than DL for automatic Gamma Knife treatment planning. Vestibular schwannoma cases were chosen because of their simplicity (single target, average number

of shots less than 20). We will evaluate the dosimetric impact (target coverage, gradient index, selectivity, beam-on time) of ML and DL prediction uncertainties relative to clinical plans. In the future, this method will be expanded to multi-target lesions.

(P172) Generation of Synthetic X-ray Images Using Deep Learning for Evaluation of Real-time Tracking

Tom Nano, PhD¹, Sicheng Zhou, MSc², Yannet Interian, PhD², Gilmer Valdes, PhD³, Olivier Morin, PhD³, Martina Descovich, PhD²; ¹University of California San Francisco, ²USF, ³UCSF

Background: Real-time tracking using projection x-ray images during stereotactic-body radiation therapy (SBRT) requires accurate identification of targets relative to planning computed tomography (CT). Target localization is highly dependent on co-registration of digitally reconstructed radiographs (DRRs) that are generated from planning CT. However, current DRRs do not contain the same fine-detail as projection x-rays and are ultimately limited in tracking accuracy of sharp edges in fiducials and bony-spine anatomy. The purpose of this work is to develop a deep learning model that generates synthetic x-ray that can be used to improve real-time tracking accuracy.

Objectives: The objective of this work is to develop a deep learning model that will convert DRRs into synthetic x-ray images which will be a more accurate representation of real-time patient x-ray images. The model will be trained on image-to-image domain transformation (DRR to x-ray image domains) rather than pixel-to-pixel mapping which will allow for synthetic x-rays to be generated from multiple treatment sites (intracranial, lung, abdomen and pelvis).

Methods: DRR-to-x-ray image pairs were extracted from 128 CyberKnife patient treatments of lung cases. For each case, the best co-registered image pair during the entire treatment for each orthogonal view (camera A and B) were chose for model building from 256 image pairs as it provides the most stationary case. The "processed DRR" and "processed x-ray" images as provided by the CyberKnife system (and used to determine tracking parameters) consisted of a 512 by 512 matrix for our model input and output respectively. A 2D convolutional neural network using cycle-consistent generative adversarial networks (CycleGANs) was trained on 80% of the data and testing on a 20% hold-out set. All images (synthetic x-rays, real x-rays, and DRRs) were z-score normalized for fair a comparison removing mean pixel value and gain variations between image domains. The mean-squared error (MSE), maximum absolute error MAE) and structural similarity index metric (SSIM) was used to compare synthetic x-ray accuracy to real x-ray images.

Results: Mean and standard deviation between DRR and real x-ray images was 0.23 +/- 0.17, 0.35 +/- 0.14 and 0.96 +/- 0.03 for MSE, MAE and SSIM respectively. Mean and standard deviation between CycleGAN synthetic x-ray predictions to real x-ray images was 0.09 +/- 0.08, 0.13 +/- 0.10 and 0.99 +/- 0.01 for MSE, MAE and SSIM respectively. CycleGAN synthetic x-rays contain more fine detail at bone edges, and appear shaper with less blurring, then DRRs which fundamentally cannot contain this information because they are generated from CT.

Conclusions: We have developed a method of generating synthetic x-rays using deep learning that are more similar to real-time x-ray projections than conventional DRRs. Synthetic x-rays that more accurately match with real x-rays provide more accurate real-time tracking. We will evaluate registration performance with synthetic x-rays and evaluate synthetic x-ray generation for other treatment sites (intracranial, lung, abdomen and pelvis).

(P173) Prediction of 3D Dose Distribution in Head and Neck Cancer with Convolutional Neural Network

Simeng Zhu, MD¹, Zhenzhen Dai, MS¹, Ning (Winston) Ning, PhD, MBA¹; ¹Henry Ford Cancer Institute

Background: Intensity-modulated radiation therapy (IMRT) is a commonly used technique for head and neck cancer, but the treatment planning process can be time-consuming due to the inherent complexity

of the iterative optimizations. Knowledge-based planning (KBP) has been proposed as a solution to expedite the process. The currently commercially available method uses regression-based machine learning approach to predict dose-volume histograms to drive the optimizer in the inverse planning.

Objectives: In this study, we aim to show the efficacy of convolutional neural network in predicting the 3-dimensional (3D) radiation dose distribution directly as part of KBP in head and neck cancer.

Methods: We obtained the data of 340 patients with head and neck cancer from a public dataset as part of the 2020 OpenKBP challenge hosted by the American Association of Physicists in Medicine. The data for each patient consists of downsampled computed tomography (CT) images (128 x 128 x 128 voxels, with voxel size of approximately 3.5mm x 3.5mm x 2mm), binary masks for planning target volumes (prescribed to 70, 63, and 56 Gy) and 7 organs-at-risk (OAR), and the 3D radiation dose distribution delivered by IMRT technique with 9 equispaced coplanar beams. A 3D U-Net with encoder-decoder architecture was used as the model for prediction. The inputs to the model consisted of the simulation CT image with normalized Hounsfield units, masks for the PTVs, and a combined mask for the OARs. Based on the input information, the model predicted a 3D (128 x 128 x 128 voxels) radiation dose distribution in Gy. Three hundred cases were randomly selected as the training set, and the rest of 40 patients were used for testing only. Ten-fold cross validation was used during training, with mean absolute error (MAE) between the predicted and real doses within the body as the loss function. Adam was used as the optimizer with a learning rate of 0.0001. The algorithm was implemented in Python 3.8 with Tensorflow 2.2 as the framework. The network training was performed on both Google Colab and NVIDIA Tesla V100 GPU. The model performance was assessed by comparing the MAE between the predicted and real dose distributions.

Results: The model was trained for 200 epochs, and model convergence was confirmed based on the validation loss (MAE < 3.0 Gy for the last 10 epochs). On the independent test set consisting of 40 patients, the mean MAE for the predicted 3D dose distribution was 2.62 Gy per voxel (range, 1.00–6.67 Gy), 3.8% of the prescribed dose of 70 Gy.

Conclusions: We showed that, with the CT images and contours of the PTVs and OARs as input, convolutional neural networks are excellent at predicting the radiation dose distributions that are similar to clinically delivered doses.

(P174) Relative Incidence of Emergency Department Visits After Treatment for Localized Prostate Cancer with Different Modalities of Radiation Therapy or Prostatectomy

Jes Alexander¹; ¹Department of Radiation Oncology, University of California, San Francisco

Background: Side effect profiles play an important role in treatment decisions for localized prostate cancer. Many datasources do not directly capture side effects, but emergency department visits (EDVs) can be measured in structured electronic health record (EHR) data. EDVs during or shortly after treatment may be due to side effects or psychological distress from treatment or comorbidities. There is limited evidence examining EDVs associated with treatment for prostate cancer.

Objectives: Determine whether treatment for prostate cancer is associated with EDVs using a self-controlled cohort study (SCCS) to control for comorbidities within individuals.

Methods: The cohort included patients treated with a single course of radiation therapy (RT) or radical prostatectomy (RP) for prostate cancer between 2011 and 2021, who had ≥ 6 months (mo) of lead-up and ≥ 6 mo of follow-up time documented in the EHR surrounding treatment and ≥ 1 EDV in this period. Relative incidence (RI) of EDVs was determined using the SCCS R package, which employs a Cox proportional hazards model, with the risk period for EDV events consisting of the time between start of treatment and 1 month after completion, and the baseline period consisting of all other time in the lead-up and follow-up periods. Associations with EDV events were analyzed with a Woolf test for homogeneity followed by a Cochran-Mantel-Haenszel χ^2 test or Fisher's exact test, for patients treated with RT or RP, respectively.

Results: Among 211 patients with RP, the median age was 66 years (range: 42 to 79) and among 179 patients with RT, the median age was 69 years (range: 47 to 87). After adjusting for age and, in the case of RT, hormone therapy, there were higher rates of EDVs after RP (RI 19.5, 95% confidence interval [CI]: 14.7 to 25.9, $P < 0.001$) and RT overall (RI 2.5, 95% CI: 1.8 to 3.5, $P < 0.001$). There were higher rates of ED visits for conventionally fractionated (CF) intensity modulated radiation therapy (IMRT) with high-dose rate brachytherapy (HDR) boost or stereotactic body radiation therapy (SBRT) boost or for HDR alone: RI 3.2 (95% CI: 1.6 to 6.4, $P = 0.001$), RI 6.9 (95% CI: 3.3 to 14.3, $P < 0.001$), and RI 15.7 (95% CI: 6.9 to 35.5, $P < 0.001$), respectively. In contrast, there were not higher rates of EDVs after SBRT alone, low-dose rate brachytherapy alone or CF or hypofractionated IMRT alone compared with baseline. Genitourinary and gastrointestinal diagnoses were more likely for EDVs in the risk period as compared with the baseline period for both RT (odds ratio (OR): 4.3, 95% CI: 1.6 to 11.3, $P = 0.002$) and RP (OR: 3.4, 95% CI: 1.4 to 8.0, $P = 0.004$). However, admissions from EDVs were not significantly more likely during the risk period for RT or RP.

Conclusions: The relative rates of EDVs during or within 1 mo of completion of RT for prostate cancer varies by modalities used, suggesting differing severities of side effects or psychological distress. These data may aid in selecting treatments for patients.

(P175) Measure What Matters: Total Patients Under Treatment No Longer a True Indicator of Radiation Oncology Clinic Patient Volume

Joshua Asper, PA-C¹, Travis Corwin², William Nordwick, RTT, MBA², Ruben Mesa, MD², Timothy Wagner, MD¹, Mark Bonnen, MD²; ¹UT Health San Antonio, ²UT Health San Antonio Mays Cancer Center

Background: In an era defined by measuring what matters Radiation Departments are still being held to outdated metrics that may or may not be the best indicators of productivity and revenue. Frequently, total number of patients under treatment is tracked as the leading indicator for Radiation Oncology department productivity and revenue. The popularity of hypofractionated regimens has decreased total number of patients on treatment even when clinic and planning activities are on the rise.

Objectives: Our data demonstrates the effects of these shorter courses of treatment on the traditional metrics used as leading indicators for productivity and revenue. We will also propose new metrics that our data suggests more closely tracks both revenue and whole department productivity.

Methods: Using EPIC EMR we collected service date information for services rendered during fiscal years 2015 to 2020. One fiscal year was defined as the 12 months, September to August. Collected Data included: total new patients, total treatments, average number of treatments per patient, and total clinical treatment plans (CTP), total charges (indicated in millions) and total RVU (in thousands). We utilized CTP to indicate unique patient new starts. The charge master remained unchanged throughout the years reported. We compared the utilization of conventional treatment options to SRS treatments with hope to demonstrate increasing use of higher value treatment options.

Results: The total new patients seen were 1030 (FY15), 1091 (FY16), 1097 (FY17), 1123, (FY18), 1238 (FY19), 1191 (FY20). The total number of treatments per year were 16358, 18338, 18086, 17021, 18263, 17754 respectively. The total number of CPT (new starts) per year were 908, 967, 999, 1023, 1120, 1154. Dividing the total treatments delivered by the new starts resulted in the average number of treatments per patient, 18, 19, 18, 17, 16, 15. Total charges (in millions) by FY were: 23.5, 27.4, 25.1, 22.2, 27.1, 26.7. Total RVU (in thousands) by FY 41.8, 48.8, 48.8, 46.9, 52.7, 53.4. The total number of new patients and new starts both continued to rise each year. The ratio of new patients to new starts were 88, 88, 91, 92, 89, and 86 percent. When comparing conventional to other short treatment options, the most dramatic growth was demonstrated in SRS, with total treatments 39, 39, 37, 50, 108, 114 respectively.

Conclusions: Traditional methods of total number of patients under treatment is no longer the best predictor of volume of work being done.

Given the current trend of shorter course higher value treatments the average number of patients on treatment and total treatments no longer are best indicators of treatment value. We suggest using new treatments starts as the new indicator as a predictor of value of work being done. Secondly, we suggest that clinics should follow the ratio of new patients to new starts to ensure that new patients being seen in clinic result in new starts. Total patients on treatment at any given point is a measurement of the past.

(P176) Proton Therapy at the End of Life: A Retrospective Review

Mina Bakhtiar, BA¹, Anish Butala, MD², Neil Taunk, MD, MS³, John Nicholas Lukens, MD³, Joshua Jones, MD, MA³, Ima Paydar, MD⁴; ¹Perelman School of Medicine, University of Pennsylvania, ²Department of Radiation Oncology, Perelman School of Medicine, University of Pennsylvania, ³Hospital of the University of Pennsylvania, ⁴Department of Radiation Oncology, University of Pennsylvania

Background: Cancer patients often receive proton beam radiotherapy (PBT) to reduce side-effects and in the re-irradiation setting. A proportion of patients receive radiotherapy near the end of life. The indications for and acute toxicities associated with proton beam therapy near the end of life are poorly understood.

Objectives: To identify the characteristics, treatment indications, and acute toxicities among patients who received PBT in the final year of life at a tertiary academic medical center.

Methods: A retrospective review of 175 patients treated with PBT within the last year of life was performed. Electronic medical records were reviewed for patient and treatment details. Follow-up was calculated from start of PBT until death. Acute (<3 mo) and chronic (>3 mo) toxicities were graded using the CTCAE v5.0. Simple logistic regression was used to evaluate factors associated with acute toxicity and grade (G) 3 or 4 toxicity.

Results: Mean age was 66 years (19-94 y), with 57% male and 43% female patients. The most common cancers were non-small cell lung cancer (31%), hepatocellular carcinoma (13%), and small cell lung cancer (7%). Concurrent systemic therapy was delivered to 47%. Median dose was 4988 cGy (180-7388 cGy), with 38% receiving < 50 Gy. Mean treatment time was 38 days (1-189 d). Median time from first fraction to death was 185 days (1-363 d). On average, patients spent 27% of the remaining days of life receiving PBT. The most common indications were LC (67%) and pain (24%), along with other clinical symptoms including bleeding and dysphagia (9%). Forty-six percent received PBT for reirradiation. Of 56 patients treated for symptoms, 69%, 27%, and 4% had partial/complete resolution, stable symptoms, or progression of symptoms. Acute toxicity of any grade was noted in 87% of patients (55% G1, 39% G2, 6% G3). The G3 toxicities included dyspnea, fatigue, and dermatitis. Seven patients (4%) experienced chronic toxicity; the most severe was a tracheo-esophageal fistula (G4). Among patients who received PBT for re-irradiation, 6 patients (8%) experienced acute and 1 patient (<1%) experienced chronic G3 or greater toxicity. In the simple logistic regression model, higher dose was positively associated with concurrent systemic therapy ($B = 0.026$, $P = 0.025$). Higher dose was also positively associated with any grade acute toxicity ($B = 0.09$, $P < 0.001$). No patient or treatment factors were associated with >G3 toxicity.

Conclusions: Patients receiving PBT at the end of life have high rates of symptom control. However, some patients spend a large portion of their remaining days on treatment. Also, toxicities are moderate and associated with higher dose. Therefore, further research is needed to identify the best candidates for PBT at the end of life.

(P177) Analysis of Approaches to Missing Patient-Reported Data in Radiotherapy Trials

Jackson Howell¹, Jordan Kharofa, MD², Christopher Anker, MD³; ¹University of Cincinnati College of Medicine, ²University of Cincinnati College of Medicine, Department of Radiation Oncology, ³University of Vermont Larner College of Medicine, Division of Radiation Oncology

TABLE 1. Summary of National Clinical Trials Network Radiotherapy Randomized Controlled Trials Included in This Analysis

Trial:	Cancer Site:	Reference for Manuscript Publishing PRO Data:
GOG-0249	Endometrium	Randall, et al., J. of Clin. Oncol., 2019
NCCGT N0574	CNS	Brown, et al., Lancet Oncol., 2017
NCCGT N107C	CNS	Brown, et al. JAMA, 2016
NRG-CC001	CNS	Brown, et al., J. of Clin. Oncol., 2020
NSABP B-35	Breast	Ganz, et al., Lancet, 2016
NSABP R-04	Rectum	Russel, et al., Ann. Surg., 2015
RTOG 0415	Prostate	Bruner, et al., JAMA Oncol., 2019
RTOG 0522	Head & Neck	Truong, et al., Int. J. of Radiat. Oncol. Biol. Phys., 2017
RTOG 0617	Lung	Movsas, et al., JAMA Oncol., 2016
RTOG 0831	Prostate	Pisansky, et al., JAMA, 2014
RTOG 1016	Head & Neck	Gillson, et al., Lancet, 2020
RTOG 1203	Endometrium and Cervix	Klopp, et al., J. of Clin. Oncol., 2018

CNS indicates central nervous system; PRO, patient-reported outcome.

Background: The use of patient-reported outcomes (PROs) in randomized clinical trials (RCTs) improves the sensitivity of adverse event detection and enhances the appreciation of patient quality of life concerns. However, PRO data collection is often incomplete—for reasons varying from logistical obstacles to patient death, exit from trials, and refusal—and the statistical analysis of these incomplete data sets so as to minimize bias and maintain conclusion integrity imposes a formidable challenge to trialists (Chowdhry et al, Int. J. Radiat. Oncol. Biol. Phys., 2021). The Setting International Standards in Analyzing Patient-Reported Outcomes and Quality of Life Endpoints Data Consortium (SISAQOL) was formed to establish PRO analysis recommendations, including guidance for anticipating and addressing missing PRO data (Coens, et al, Lancet Oncol., 2020).

TABLE 2. Summary of Relevant Patient-reported Outcome (PRO) Data Analysis Recommended Statements Established by Setting International Standards in Analyzing Patient-Reported Outcomes and Quality of Life Endpoints Data Consortium (SISAQOL) and a Survey of These Features in the Trial Set Analyzed in This Work (Coens, et al, Lancet Oncol., 2020)

Recommended Statements:	Objectives:	Considerations:	Portion of Adherent Trials:
24, 26, 29	Collected reasons for missing PRO/QOL data	<ul style="list-style-type: none"> Improves understanding of the impact of missing data Allows imputations methods to be founded upon weaker assumptions 	67% (8 of 12)
27	Specified a clear analysis approach for missing data a priori in the trial protocol	<ul style="list-style-type: none"> Because data analysis approaches can yield variable results, transparency in data analysis plans are imperative 	75% (9 of 12)
27	Adhered to a priori plan in final data analysis	<ul style="list-style-type: none"> Further measure of transparency 	78% (7 of 9)
30	Avoided use of missing data approaches that ignored patients with incomplete data (e.g., complete case analysis)	<ul style="list-style-type: none"> Methods that allow the use of all available data are recommended, as they make weaker assumptions about missing data, compared to complete case analysis 	33% (4 of 12)

QOL indicates quality of life.

Objectives: Survey recently completed radiotherapy (RT) RCTs that utilized PROs to evaluate how they approached the challenge of missing PRO data and compare their methods to SISAQOL recommendations to identify specific areas for improvement in future trials.

Methods: In prior work, a survey of all RT RCTs initiated by the National Cancer Institute's National Clinical Trials Network organizations between 2000 and 2020 was performed (Howell et al, *Int. J. Radiat. Oncol. Biol. Phys.*, 2021). Trial protocols were acquired from the Cancer Trial Support Unit, and published manuscripts presenting the trials' data were collected. Only completed trials from this set that published PRO data in manuscript form were considered. The protocols and manuscripts produced by these trials were carefully examined, with the data analysis methods and presentation of results compared with the SISAQOL recommendations for the assessment of missing PRO data (Coens, et al, *Lancet Oncol.*, 2020).

Results: Twelve trials met these criteria (Table 1), and evaluation objectives are summarized in Table 2. Only 75% specified a clear strategy for addressing missing PRO data in the protocol, and 78% of those trials adhered to the a priori strategy. Saliently, 67% of trials analyzed recorded reasons for incomplete PRO data collection, which is important when designing imputation methods for estimating missing data. Importantly, 67% of trials at least partially incorporated a listwise deletion strategy into their PRO data analysis, which can weaken the analysis.

Conclusions: Areas for improvement in planning future RCTs include increasing specificity of and adherence to a priori strategies for analyzing PRO data, collecting reasons for missing data, and utilizing data imputations methods, rather than listwise deletion methods, when missing data arises. These methods will improve the quality of PRO data analysis by utilizing the maximum amount of collected data and decreasing the role of assumptions regarding missing data.

(P178) The Impact of the Clinical and Translational Research Infrastructure Network (CTR-IN) Program on Oncology Research in the Mountain West (MW) Region

Parvesh Kumar, MD¹, Chad Cross, Associate Professor¹, Tony Ward, Professor², Curtis Noonan, Professor²; ¹University of Nevada Las Vegas, ²University of Montana

Background: The MW CTR-IN grant is a U-54 Institutional Development Award (IDeA) funded by the NIH / NIGMS to increase and enhance research capacity. The CTR-IN Program (ctrin.unlv.edu) is only one of 12 clinical and translational research centers funded by NIGMS in the US. The CTR-IN involves a partnership with the 13 major public universities in the MW region (i.e., Nevada, New Mexico, Wyoming, Montana, Idaho, Alaska and Hawaii) that covers 1/3rd of the US land mass and almost 1/3rd of all IDeA states. Of the 13 CTR-IN partner public universities, only 4 have schools of medicine (SOM). To increase and enhance research capacity, the CTR-IN Program initiated a pilot grant (PG) program for eligible research faculty of the 13 MW University partners in 2013 that is now in its 8th year with a very successful track record of producing independent extramural grant funding.

Objectives: We conducted a retrospective review of our CTR-IN PGs to determine their impact on oncology research in the Mountain West region. All of our PGs undergo a rigorous "NIH-like" review process and our funding percentile is typically in the 25th - 30% range. The typical funding range for our PGs is usually \$60 - \$66k each with a duration of one year.

Methods: During the initial grant cycle (2013 - 2017), a total of 83 PGs were funded for approximately \$60 - \$66k each in many different areas including cancer. Eight (9.6%) of the 83 PGs had a cancer focus. We analyzed and compared various major outcome metrics such as the Journal Impact Factor (JIF) of the published manuscripts, the Extramural Grant Funding (EMGF) and Return on Investment (ROI = total EMGF amount/total awarded PG amount x 100%) for the cancer focused PGs (n=8) vs. the non-cancer PG awards (n=75). Exact comparisons of the means of the major outcomes (i.e., JIF, EMGF,

ROI) between the cancer focused PGs vs. the non-cancer PGs were conducted.

Results: Of the 8 pilot grants funded in cancer research, only 2 were funded for faculty at a SOM while the others were funded at other schools (i.e., Biological Sciences, Allied Health, Social Work, Nursing and Computer/Mathematical Sciences) at our 13 partner universities. The major outcomes for the cancer focused PGs vs. the non-cancer focused PGs were as follows, respectively: (1) Mean JIF = 3.94 (SD = 4.83) for 24 publications for the cancer focused PGs vs. Mean JIF = 3.05 (SD = 1.69) for 126 publications for the non-cancer focused PGs, $P=0.102$; (2) Mean Amount of EMGF = \$1,255,913 (SD = \$294,931) for a total EMGF amount of \$2,511,826 involving 4 grants (all from faculty at non-SOM Universities) vs. Mean Amount of EMGF = \$2,317,870 (SD = \$3,669,986) for a total EMGF amount of \$46,358,174 involving 43 grants, $P=0.765$; (3) ROI was 2,002% (SD = 792%) vs. 3,644% (SD = 6,643%), $P=0.789$.

Conclusions: Despite not having medical schools at majority of our 13 partner institutions, our comparative analysis of major scholarship outcomes (i.e., JIF, EMGF and ROI) reveals that our cancer focused PG awardees were just as successful as our non-cancer focused PG awardees. The MW CTR-IN Program has been instrumental in seeding a culture of investigator initiated clinical and translational research through its pilot grant program including oncology research despite the sparsity of medical schools in the MW region.

(P179) Radiotherapy Patients' Procedural Stress and Anxiety: A National Survey Study of Radiation Therapists' Experience in Daily Treatment

Nina Mayr, MD¹, Daniel Hippe, MS², Dean Baraba, RTT², Simon Lo, MB, ChB, FACR, FASTRO², Jamie Bartalamay, MBA, RTT², William Yuh, MD, MSEE², Kai Borm, MD³, Stephanie Combs, MD³, Alexandra Chadderdon, Psy D⁴; ¹Nina A. Mayr, ²University of Washington, ³Technische Universitaet Muenchen, ⁴University of Colorado

Background: Patients' anxiety and stress towards radiation therapy have been well recognized. However, little is known about their effects on daily treatment delivery/workflow and about anxiety management in the radiotherapy environment.

Objectives: We sought to assess prevalence, impact and management of patient anxiety/stress in external radiotherapy from the perspective of the radiation therapists (RTTs) who have the closest daily interactions with patients.

Methods: A national survey of RTTs was conducted to collect their experiences regarding prevalence and perceived importance of patients' anxiety/stress, impact on their daily workflows, approaches to evaluation and management, and responsibilities for anxiety management in radiotherapy patients.

Results: Among 739 responders, the importance of managing radiotherapy-associated patient anxiety/stress in the RTT's practice was judged as high by 97% (extremely important: 61%; very important: 36%). Anxiety-related interferences were reported by 89% for conventional and by 87% for advanced/complex (SBRT/IGRT/breathhold) radiotherapy procedures. Interferences consisted predominately of delays in fraction completion, need for re-imaging, patients' inability to cooperate and increased pain. Anxiety was assessed most commonly through unstructured verbal discussion (82%). Assessment was most commonly performed by nurses (83%), followed by RTT's and radiation oncologists. The majority reported that RTTs carried the most responsibility for anxiety management in their clinics. Management was variable. Methodically unstructured measures including empathic attention and patient education prevailed (Fig. 1). Requests for pharmacological anxiolytic therapy were common (72%), while most integrative health approaches, with the exception of breathing exercises, were rare.

Conclusions: Patients' procedural anxiety/stress has profound impact on daily external radiotherapy delivery and workflows. Anxiety management varies widely and relies heavily on RTTs. Integrative health approaches that are used in radiology and other medical procedures appear underrepresented. Our observations may help inform strategies

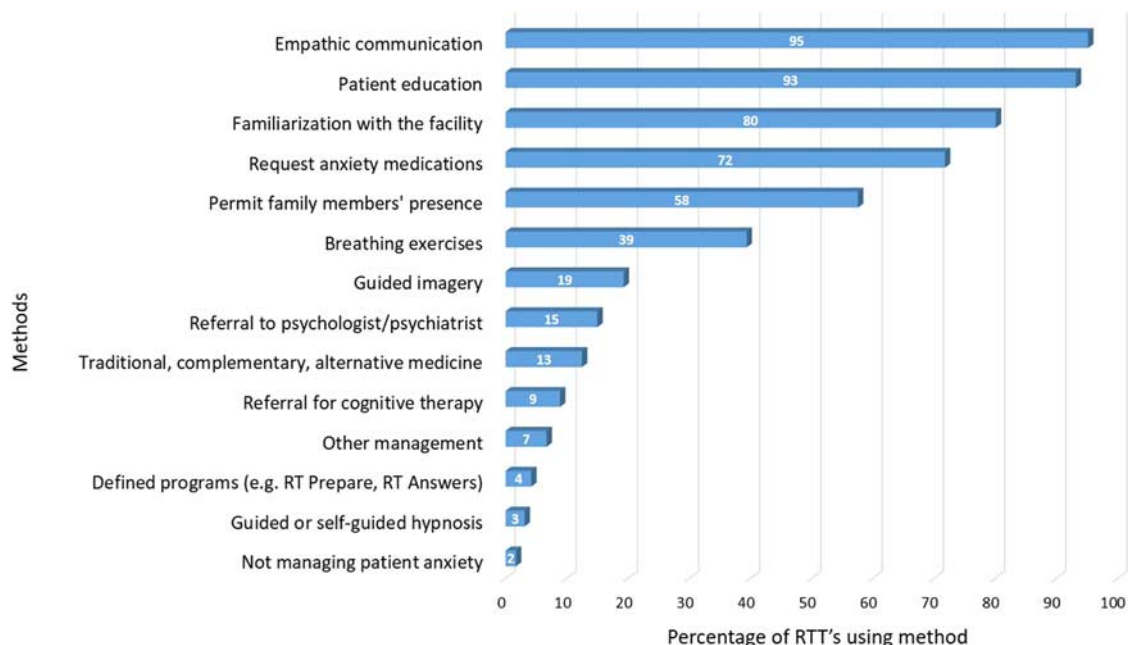

FIGURE 1. Method(s) used to manage radiation oncology patients' procedural anxiety. Methods for the management of patient anxiety used by responders are shown in descending frequency. Multiple choices were permitted.

to advance patient anxiety management within the radiation oncology care team, decrease its interfering effects on radiotherapy delivery, and improve patient experience.

(P180) Dosimetric Parameters Associated with Long-Term Patient-Reported Quality of Life Following Definitive Chemoradiation for Anal Cancer

Michael Rooney, MD¹, Brian De, MD¹, Kelsey Corrigan, MD, MPD¹, Graciela Noguera Gonzalez, MS¹, Prajnan Das, MD, MS, MPH², Cullen Taniguchi, MD, PhD², Grace Smith, MD MPH¹, Bruce Minsky, MD¹, Albert Koong, MD, PhD¹, Eugene Koay, MD PhD², Ethan Ludmir, MD¹, Craig Messick, MD¹, Nancy You, MD MHSc¹, George Change, MD¹, Ouida Westney, MD¹, Van Morris, MD¹, Emma Holliday, MD¹; ¹MD Anderson Cancer Center, ²MD Anderson

Background: Data describing long-term patient-reported outcomes (PROs) following intensity-modulated radiation therapy (IMRT)-based chemoradiation (CRT) for the treatment of squamous cell carcinoma of the anus (SCCA) remain scarce.¹ Furthermore, clinical and dosimetric risk factors associated with adverse PROs are unknown.

Objectives: To identify dosimetric parameters which may be associated with patient-reported quality of life after treatment with chemoradiation for SCCA.

Methods: We identified 248 patients with SCCA treated at our institution from 2010-2018 who were alive and without recurrence. We requested that all patients complete five validated PRO instruments: Fecal Incontinence QOLScale (FIQOL), Low Anterior Resection Syndrome Score (LARS), International Consultation on Incontinence Questionnaire (ICIQ) male and female lower urinary tract symptoms (MLUTS and FLUTS, respectively), International Index of Erectile Function (IIEF), and Female Sexual Function Index (FSFI). For those completing surveys, we retrospectively segmented pelvic organs at risk

using published atlases and calculated prespecified dosimetric parameters (anal PTV D1, bowel bag V30(cc)/V35/V40/V45/D1, small bowel V30(cc)/V35/V40/V45/D1, bladder V40(%) /V45/V50, vagina V40(%) /V45/V50/mean dose(Gy), external genitalia V30/V20, penile bulb mean dose, and prostate mean dose) using approved treatment plans. After selecting factors with intuitive potential causal relations with PROs and those with association on univariate analysis ($P < 0.05$), we generated multiple regression models to identify factors independently associated with PROs.

Results: One-hundred eight (44%) patients completed surveys. Eighty percent of respondents were female, mean (standard deviation) age was 60 (8.9) years, and 23% had T3/T4 disease. Mean bowel bag D1 was 49.9 Gy (3.3), and mean small bowel D1 was 48.1 Gy (4.6). Average vaginal mean dose was 47.0 Gy (6.3), average penile bulb mean dose was 49.2 Gy (7.1), and average prostate mean dose was 49.3 Gy (6.5). Median [IQR] time from CRT to the completion of the PRO survey was 51 [37-84] months. Multiple regression modeling revealed that increasing bowel bag D1 was significantly associated with lower FIQOL score ($P = 0.001$) and higher LARS score ($P = 0.003$), both signifying worse bowel function. Higher bladder V40 was associated with increased ICIQ score ($P = 0.001$), indicating worse urinary function. Increasing vaginal V40 was associated with lower FSFI ($P = 0.011$), correlating with worse sexual function. There were no significant dosimetric relationships detected with IIEF or PROMIS scores.

Conclusions: Multiple dosimetric parameters are associated with patient-reported quality of life across multiple symptomatic domains following receipt of IMRT-based chemoradiation for the treatment of SCCA. Minimizing hotspots in the bowel as well as V40 of the bladder and vagina may improve long-term bowel, urinary and sexual function for patients undergoing definitive chemoradiation. The dosimetric parameters from this study could potentially be used to develop radiotherapy planning constraints that optimize patient reported quality of life.