

Power Quality in DC railway systems

Original

Power Quality in DC railway systems / Giordano, D.; Signorino, D.; Femine, A. D.; Gallo, D.; Cipolletta, G.. - ELETTRONICO. - (2021), pp. 1-6. ((Intervento presentato al convegno 11th IEEE International Workshop on Applied Measurements for Power Systems, AMPS 2021 tenutosi a Cagliari, Italy nel 29 September 2021 - 01 October 2021 [10.1109/AMPS50177.2021.9586027]).

Availability:

This version is available at: 11583/2969118 since: 2022-07-08T10:39:55Z

Publisher:

Institute of Electrical and Electronics Engineers Inc.

Published

DOI:10.1109/AMPS50177.2021.9586027

Terms of use:

openAccess

This article is made available under terms and conditions as specified in the corresponding bibliographic description in the repository

Publisher copyright

IEEE postprint/Author's Accepted Manuscript

©2021 IEEE. Personal use of this material is permitted. Permission from IEEE must be obtained for all other uses, in any current or future media, including reprinting/republishing this material for advertising or promotional purposes, creating new collecting works, for resale or lists, or reuse of any copyrighted component of this work in other works.

(Article begins on next page)

Power Quality in DC railway systems

D. Giordano, D. Signorino

Italian National Institute of Metrological Research (INRIM)
Torino, Italy
d.giordano@inrim.it

A. Delle Femine, D. Gallo, G. Cipolletta

Department of Engineering
University of Campania “Luigi Vanvitelli” - Aversa (CE), Italy
daniele.gallo@unicampania.it

Abstract— The topic of the power quality in railway systems has more and more interest driven by the need of having a reliable, efficient and resilient system. The paper contributes to the identification and cataloguing of transient and power quality events and power quality indices that affect the DC metro and railway systems. Several transient events detecting on-board the 3 kV and 1.5 kV traction units and in a 3 kV substation are presented and described. The behaviour of the amplitude and frequency content of the voltage and current ripple under a particular operating condition is described. The events have been extracted by the measurement campaigns performed in the framework of the European project MyRailS.

Keywords— DC Power quality, Railway system, voltage deep, voltage swell, electric arc, transient events

I. INTRODUCTION

The power quality issue is a relatively new topic in the railway world [1]-[8]. The grown interest is driven by technical and economic issues. The technical issues arise from the need to have a railway system even more sustainable, reliable and with high resilience. The economic issues are triggered by the liberalization of the railway market that has introduced two actors in the railway system: the infrastructure manager and the railway companies. The quality of the power exchanged between the two actors have economic and fiscal consequences. In this scenario, widespread monitoring of the railway and metro system performed both on-board and in supply substations can be not only a valuable tool for a much more predictive diagnosis of the entire railway electric system but also an economic tool to promote trains and supply system even more efficient [9].

On the other hand, the railway and metro networks supplied by direct current (DC) systems are experiencing an important technical improvement. The need of maximizing the recovering of the energy generated during the electric braking of the trains has stimulated the development and implementation of new technical solutions to collect and reuse this extra energy. However, these techniques can lead to a worsening of PQ conditions by generating transient reversal of power flows [10], [11].

For these reasons, measurement tools for the monitoring of the ripple in terms of amplitude and frequency and algorithm for the detection and classification of transient events are the base for the monitoring of the power quality in order to perform the predictive maintenance, to assess the impact of the new supplying architecture in terms of compliance with the EMC limits and to verify the energy efficiency improvement.

The scientific research on the PQ in railway system is mainly oriented towards the AC railway supply systems. Mariscotti has provided a relevant contribution to the PQ in both DC railway and distribution grids [1] [2] and [3]. Suarez et al [4] have analysed the over-voltages produced by the

braking rheostat for specific light trains with DC traction motors. Pons et al [5] have contributed to the investigation on over-voltages occurring at the Tram network of Torino (Italy). Diez et al have analysed the power quality of the Medellin metro system with the aim of cataloguing the over-voltages according to their nature [6]. An interesting review paper has been published by Kaleybar et al [7]. The paper provides and classifies a collection of PQ events for both AC and DC railway systems.

The authors have contributed to this topic by analysing, through suitable algorithms, the electrical quantities provided by the measurement campaigns carried out in the framework of the European project MyRailS [8]. A statistical analysis on the voltage level experienced in the 3 kV DC lines, such as the analysis of voltage deeps and swells, have been performed and described in [9]. Moreover, a preliminary collection of transient events has been provided by [10].

The research activity here presented enlarge the typology of PQ events found in the huge amount of data provided by the measurement campaigns performed both on-board railway and metro traction unit and in a railway substation. The paper presents a collection of transient events detected on board the Trenitalia (the most important Italian railway company) E464 electrical locomotive for commuter service operating at 3 kV DC, on-board the S9000 electro-train operating on the lines of the Metro de Madrid network supplied at 1.5 kV DC and in the 3 kV railway substation that supplies the Bologna – Rimini (Italy) line. The paper is organized as follow: after a brief description of the measurement setups implemented on-board the traction systems and in the substations are provided in section II and section III respectively. Section IV provides a collection of both the transient power quality events and the voltage and current ripple behaviour. Finally, Section V describe the power quality analysis provided in the 3 kV substation

II. THE TRACTION UNITS TEST CASES

The measurement instrumentation installed on board the train was designed for only two purposes: 1) the analysis of the energy flows exchanged between the train and the catenary and 2) the measurement of the signals used as control parameters of the locomotive. Therefore, for the analysis of the energy quality it is necessary a specific additional instrumentation with better performances than those of the instrumentation normally present on board the trains. For this reason, for the measurement campaigns on board both the railway and metropolitan trains new sensors and a high performance data acquisition systems have been installed, [10] [11].

As reported in [10] and [11], the Trenitalia E464 locomotive and the MetroMadrid S9000 metropolitan train have a supply input stage characterized by a second order LC filter whose purpose is to limit the voltage distortion applied to the motors during the traction phase and, vice versa, to

limit the spectral pollution produced by the motors towards the line during the energy recovery phase. Therefore, for PQ analysis, it is necessary the accurate monitoring of the voltage quantities upstream, V_p , and downstream of the filter, V_f , and the current absorbed by the locomotive, I_p (see Figure 1).

The voltage transducers used for this activity are the Ultravolt TF 40 Series. These ohmic capacitive transducers have a scale factor of 1000V / 1V and a full scale of 40kV but the main reason for this choice is the wide bandwidth: from DC to 1 MHz with an accuracy of 0.25%.

The current transducer used to measure the current absorbed by the pantograph is the LEM HOP 2000. It is a Hall effect transducer with a 3 kHz bandwidth and allows to measure signals up to ± 2000 A. Its output is a voltage signal up to ± 4 V, with an accuracy better than 1% after the systematic error compensations. It is an openable transducer; therefore, it can be easily installed without interfering in any way with the locomotive's input circuit. It is important to underline that all the transducers used were characterized at the National Institute for Metrological Research (INRiM) before being used for the measurement campaigns.

As reported in [10] and [11] the data acquisition system used to acquire the signals provided by the transducers is based on the National Instrument Compact Rio 9034, a standalone chassis that features an embedded controller with a 1.91 GHz Real-Time processor, a reconfigurable (Field Programmable Gate Array) FPGA, 2 GB RAM DDR3 and a SD port for data storage. As regards the acquisition modules, the Compact Rio 9034 houses two NI 9223 that are 4-channel voltage modules, with differential inputs and simultaneous sampling with a maximum range of ± 10 V, 1 MHz as maximum sampling rate and a resolution of 16 bit. The sample clock of the first NI 9223 is exported to the second one, in order to obtain simultaneous sampling on all 8 channels. The data acquisition is performed at a sample rate of 50 kHz. The acquisition system is referenced to absolute time via the GPS module NI 9467, that provides a Pulse Per Second (PPS) signal with an accuracy of 100 ns. Obviously, the GPS receiver cannot work well underground, but the train passes in an open sky track once a day, the system can synchronize with UTC in that moment and keep time using the internal real-time clock.

III. THE SUBSTATION TEST CASE

A measurement setup similar to that used on-board the train has been installed in the DC 3kV substation close to Forlì station. The substation is constituted by two AC/DC converters parallel connected, one is a mobile converter system placed in a railway carriage, the other is fixed (see Fig.2).

The measurement system is the same used for the on-board application and it is placed in the fixed AC/DC converter. The monitored quantities are the current flowing in the positive bus bar (I_p) and in the negative one (I_N), measured through two LEM HOP 2000 transducers, and the voltage before (V_{upf}) and after (V_{dwr}) the inductance (L_{fil}) constituting the 100 Hz second-order filter, measured by means of two Ultravolt transducers. All the voltages are measured taking as reference the rail potential. Four electric quantities have been recorded at a frequency of 50 kHz thanks to a National Instrument compact RIO system. The data are stored in a 1 Terabyte SD card and periodically changed.

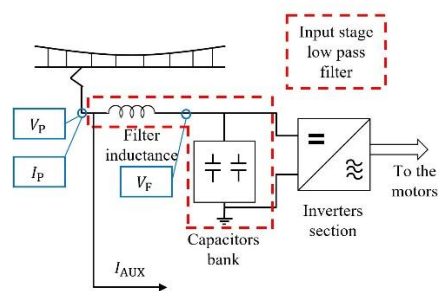

Figure 1. Measurement setup arranged in the DC substation.

From the first analysis of collected data, numerous interesting events and trends have been detected and presented in the following:

- High voltage oscillations
- Transient overvoltage triggered by the electric arc at pantograph
- Voltage swell produced by a regenerative braking
- Intervention of traction protection system
- Load insertion
- Opening of the main circuit breaker due to the high 50 Hz content on the current at the pantograph.

IV. COLLECTION OF TRANSIENT EVENTS DETECTED ON-BOARD TRAINS

A. High voltage oscillations

The supplying of a section of line previously disconnected provokes an overvoltage and a consequent damped oscillation of high amplitude. Figure 3 that provides the voltage behavior at the pantograph of the 3 kV locomotive shows such an event. The overhead contact line was previously disconnected; when the re-connection occurs, the voltage reaches the 3 kV level following a damped oscillation behavior. At the first oscillation, the voltage reaches a peak of 6.3 kV and a minimum of 1.5 kV during the oscillation. The oscillation frequency is 2.4 kHz.

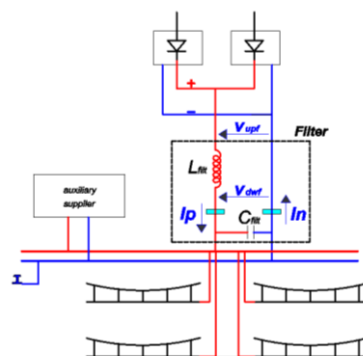

a)

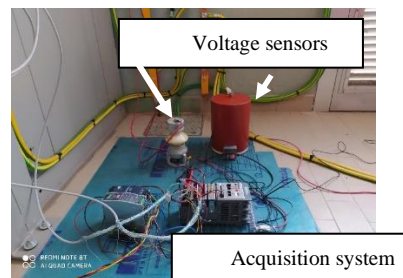

b)

Figure 2. Measurement setup arranged in the DC substation. Scheme a) and picture a) of the setup.

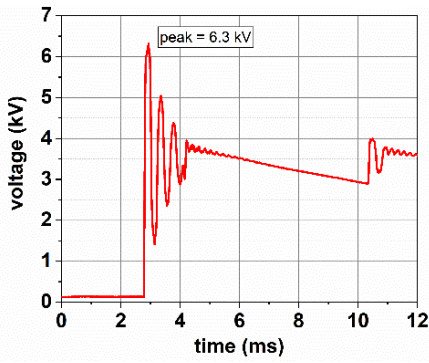

Figure 3. Voltage behavior detected at the pantograph of a 3 kV locomotive during the re-connection of the overhead supply line.

B. Transient overvoltage triggered by the electric arc

The electric arc occurring at pantograph since the detachment between the two sliding contacts (pantograph and OverHead Contact Line (OHCL)) during a regenerative braking provokes a transient overvoltage. In fact, the arc event, in a very simple way, can be seen as a resistor series interposed between the overhead contact line and the pantograph. The traction unit can be seen as a current generator that inject the current produced by the traction motor in the OHCL. The sudden appearances of the resistance emulating the arc provokes an increase of the voltage, as described by the circuit provided in [12]. Figure 5 shows the time behavior of the voltage and current at pantograph when an electric arc occurs. Before the arc event that occurs at time $t_{start} = 6.6$ s the train was braking in a regenerative way injecting in the OHCL a current of about 300 A.

Once the detachment between the two electrodes of the sliding contact (pantograph and OHCL) occurs, the voltage at pantograph V_p increases and the current start reduces; when it reaches zero amperes, the quenching of the arc occurs, the locomotive is electrically disconnected by the OHCL and the voltage V_p dramatically decreases to the voltage level imposed by the traction motors which operate as generators.

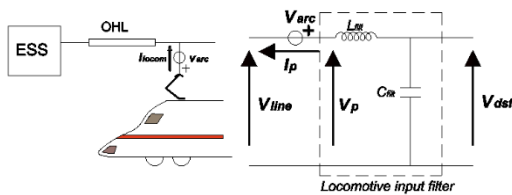

Figure 4. Electric circuit modelling the arc event during a regenerative braking stage.

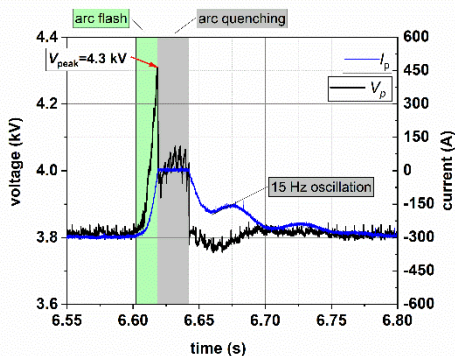

Figure 5. Transient overvoltage provoked by the electric arc event occurred during a regenerative electric braking.

A more detailed description of such behavior can be found in [12]. The overvoltage produced by this event is of 500 V from the initial value (3.8 kV) reaching 4.3 kV in about 18 ms with a consequent down step of 300 V (from 4.3 kV to 4 kV) in about 1.4 ms. When the pantograph again is in good electric contact with the OHCL, a new down step voltage of 200 V occurs in about 100 μ s.

C. Voltage swell produced by a regenerative braking

The electric braking allows to recover the energy produced during the braking [10], [11] by delivering such energy to other trains or DC loads by means of the OHCL. This provokes a voltage increase (swell), which is higher at the pantograph of the braking train, so the voltage decreases along the line moving towards the load. The amplitude of the swell depends on the equivalent distance between the source and the load. To mitigate such overvoltage, a braking rheostat is connected in parallel with the traction units that become generator during the braking. A chopper modulates the amplitude of the current shunted by the rheostat in order to control the voltage level increase. An example of the electric quantities at the input of the traction unit during a braking is provided in Figure 6. Before the braking, the voltage experienced at pantograph was of about 3.5 kV while the absorbed current was of 1250 A. The driver suddenly sets a sharp braking; the voltage dramatically increases of 370 V; the voltage swell has an increase of 30% of the rated voltage (3 kV). Figure 6 also shows the chopped current shunted by the on-board braking rheostats that mitigates the swell.

D. Load insertion

The locomotive provides the energy to the carriages towards a 3 kV cable that connects all the carriages. This cable shunts the current before the locomotive input filter. This means that if the loads on board each carriage is not adequately filtered their insertion – disinsertion provoke a fast transient event on the voltage. This hypothesis is proved by the measurement performed on-board the locomotive. As can be seen in Figure 7, which provides the voltage at the pantograph and the current flowing in the auxiliary 3 kV cable, every time a current step occurs as a consequence of a load insertion, a fast oscillation occurs on the voltage. This event is clearer shown in the zoom provided in Figure 8. At a step increase of about 8 A for the auxiliary current provoked by a carriage load insertion, it corresponds a damped voltage oscillation with a maximum peak-to-peak oscillation of 1.3 kV.

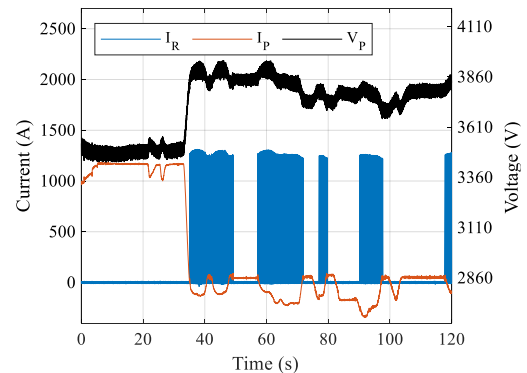

Figure 6. Example of voltage swell provoked by the regenerative braking.

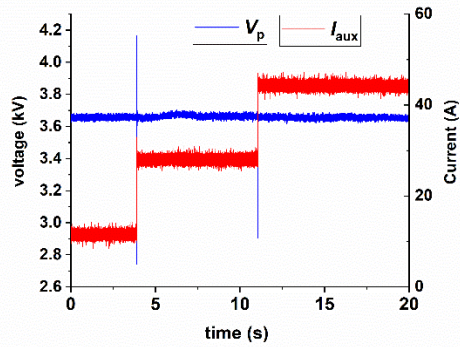

Figure 7. Voltage transient events triggered by the rolling stock loads insertion.

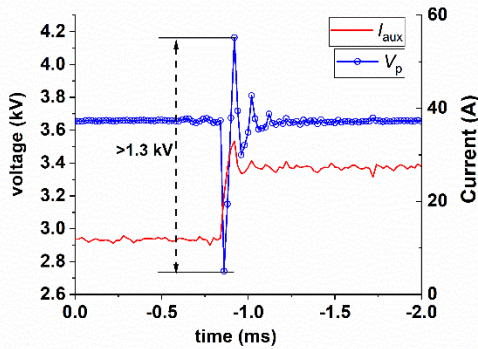

Figure 8 Zoom of the event provoked by the rolling stock load.

A very approximated estimation of the frequency oscillation, carried-out by taking the first two minimum voltage peaks, provides a value of about 10 kHz.

E. Intervention of traction protection system

The Figure 9 provides an example of a low-frequency damped oscillation. Before the event, the locomotive was accelerating absorbing a constant current of 1 kA while the average voltage at the pantograph was of about 3.3 kV. Suddenly, the traction unit was disconnected probably as a consequence of the intervention of the circuit breaker protecting the traction motors. The absorbed current dramatically decreases to zero following a damped oscillation behavior. The voltage after the filter, such as the voltage at the pantograph, follows the typical behavior of a step response of a second-order linear system. Such a response is due to the LC input filter of the locomotive. Impressive is the oscillation of the voltage V_f that reaches a peak of 4.4 kV while the peak reached by V_p is limited to 3.9 kV.

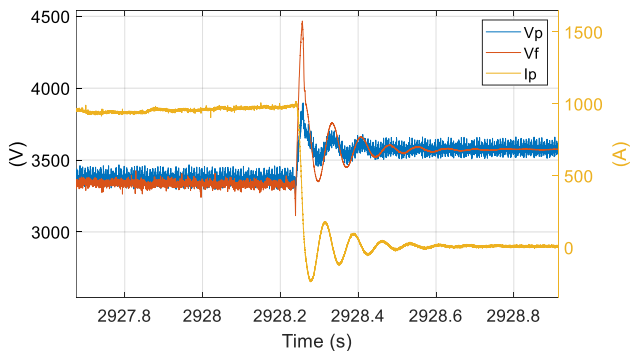

Figure 9. Low frequency transient oscillation triggered by the intervention of the circuit breaker that protects the traction system.

F. Opening of the main circuit breaker due to PQ events

This event has been recorded in presence of an iced OHCL that makes the supply contact very bad: continuous detachment occurs between the pantograph and the OHCL. This increases the electrical pollution as demonstrated by the high amplitude of the ripple harmonics of the absorbed current provided in Figure 10 and Figure 11. Since the high amplitude of the 50 Hz current component, the control system triggers the opening of the main circuit breaker. After opening, the level of pollution stays at low values till the breaker was reclosed again.

V. SURVEY ON THE VOLTAGE RIPPLE

Several analyses on the supply voltage ripple have been performed on both the railway and metro test cases. The analysis was performed considering successive periods of 200 ms duration. For sake of brevity, only some results related to analysis on the metro test case is reported in the following. The monitoring was performed on the line of Madrid 10B during a whole day with about 23 round-trip journeys recorded. In particular, the average values over one minute of the rms of the AC ripple are provided in Figure 12. Compared the Italian railway case study, the ripple has a more stable behavior over time but is greater. It goes from 55 V to a peak value of 190 V. Since the ripple is a combination of several frequency tones superimposed to the DC component a frequency content analysis has been performed considering a time interval for the analysis of 200ms and averaged each second.

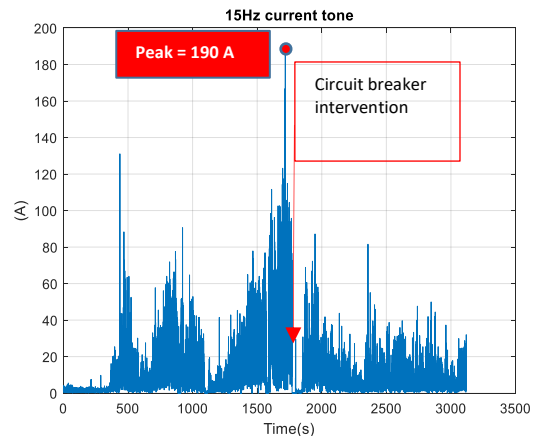

Figure 10 Harmonic component of current at 15 Hz.

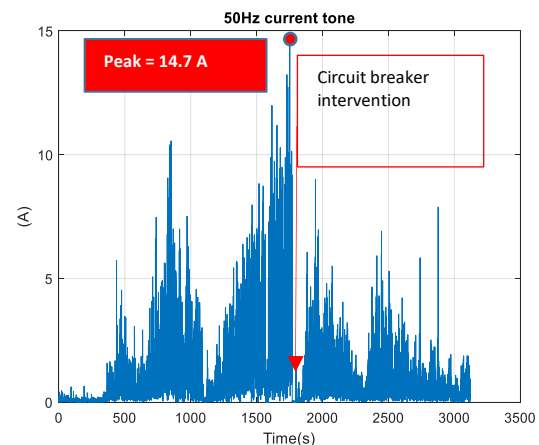

Figure 11 Harmonic component of current at 50 Hz.

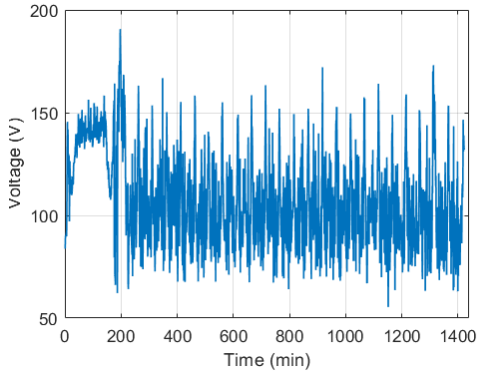

Figure 12. Behavior of the rms voltage ripple for a day.

The spectral analysis has been conducted considering the harmonics in a range that goes from 50 Hz to 3 kHz to evaluate the effect of the 12-pulse rectifiers installed in the substations that supply the line. An important PQ parameter is the presence of the 2400 Hz tone (see Figure 13). In particular, the amplitude of the 2400 Hz tone as percentage of the DC component during the day is reported. Except for the first five hours in which the train is not yet travelling the line 10 B, it can be noted a time periodicity of the ripple. In fact, each peak around the 0.3 % occurs in a time-interval of about 49 minutes.

Since the train is controlled through an ATO (Automatic Train Operation), the driving profile and the duration of each roundtrip journey is nearly the same and so the path travelled by the train as well. This is confirmed observing the traction current between two peaks of the 2400 Hz tone. In fact, comparing Figure 15, a zoom of Figure 13 between minute 380 and 430, and Figure 15, in which is shown the traction current in the same time interval, it can be noted that the two peaks of the 2400 Hz component occur in correspondence of the same substation.

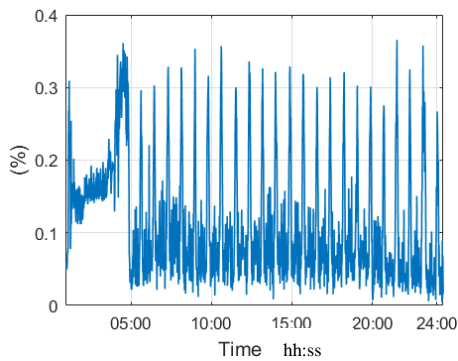

Figure 13. Behavior of the ripple tone at 2.4 kHz for a working day.

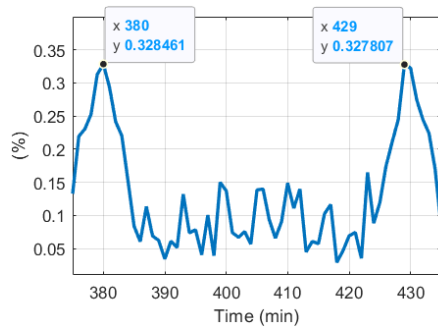

Figure 14. zoom of Figure 13 of the time interval [380 min – 430 min].

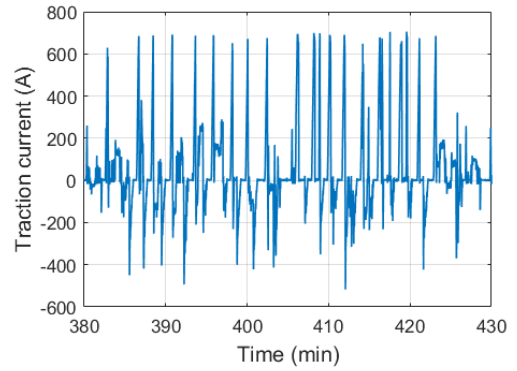

Figure 15. current behavior of a complete journey (go and back). The time 380 min and 430 min corresponds to the same station.

It possible to argue that this PQ disturbance was originated in a specific substation so what before appears as time periodicity was instead a spatial periodicity: the level increases as the train is approaching to a specific station.

VI. PQ EVENTS DETECTED IN SUPPLY SUBSTATION

- Invers polarization of diode rectifiers
- Low frequency oscillation in the substation
- Arc event observed by the substation and on-board

A. •Invers polarization of diode rectifiers

Since the regenerative braking of the traction units, the voltage of the DC supply line can become higher than the AC upstream voltage. When this occurs, the current generated by the substation reaches zero amperes while the voltage is imposed by the braking locomotive. Figure 16 gives an example of this event. The provided electrical quantities are averaged over 200 ms.

The current provided by the section of the substation monitored is delivering about 30 A and the imposed voltage is about 3740 V. at time 8:8:50 the current falls down close to zero while the voltage increases of about 55 V. An accurate analysis of the voltage ripple allows concluding that the average voltage increase is actually due to the reduction of the lower side of the voltage ripple.

B. Low frequency oscillation in the substation

Because of the presence of the second order LC filter insert at the output of the conversion system, each fast variation of the absorbed current, due to for example the main circuit breaker of some locomotive supplied by the considered substation provokes an oscillation of the voltage.

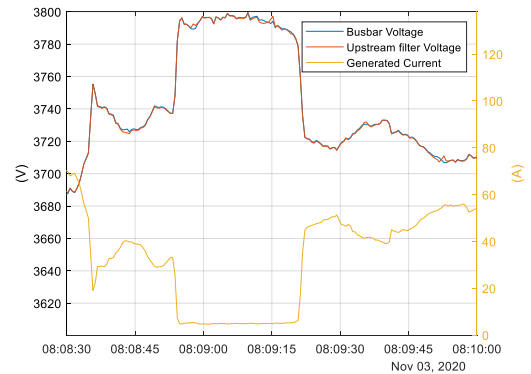

Figure 16. behavior of the voltage and current at the substation bus-bar when an inverse polarization of the diode rectifier occurs.

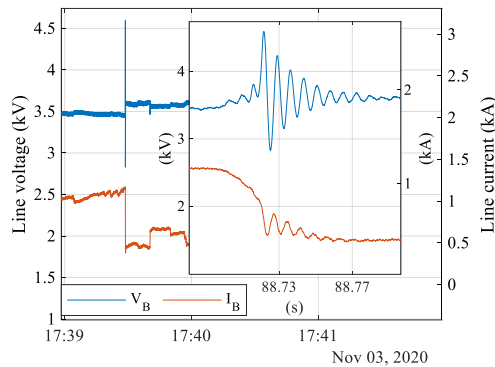

Figure 17 low frequency oscillation detected in the substation.

An example is provided in Figure 17. A current reduction from 1 kA to 500 A occurring in about 15 ms trigger a voltage oscillation of about 138 Hz (close to the natural frequency oscillation of the substation filter) with a peak-to-peak oscillation of about 1.7 kV.

C. Arc event observed by the substation and on-board

Synchronized measurements performed both on-board and in substations allowed to compare the conducted effects provoked by the electric arc at pantograph with the conducted effect of the same event experienced in the substation supplying the test locomotive. Figure 18 allows to compare the typical voltage and current time behavior detected at pantograph when an electric arc occurs during a regenerative braking stage (the voltage V_p experienced a transient overvoltage and the current I_p is negative) and the transient oscillation experienced in the substation where both the voltage at the bus-bars V_b and the current flowing in the positive busbar of the substation shown a low frequency, about 100 Hz, damped oscillation.

VII. CONCLUSIONS

This paper shows and describes five transient events detected on-board a 3 kV DC locomotive, provoked by i) the re-energizing of the catenary, ii) the electric arc event, iii) the regenerative braking, iv) the carriage load insertion and the main circuit breaker intervention. Moreover, preliminary results on the frequency and amplitude content of the ripple is provided for the particular case of iced OHCL and for the metro case. In this case, the analysis of the 2400 Hz tone proves that a specific substation generates such a tone.

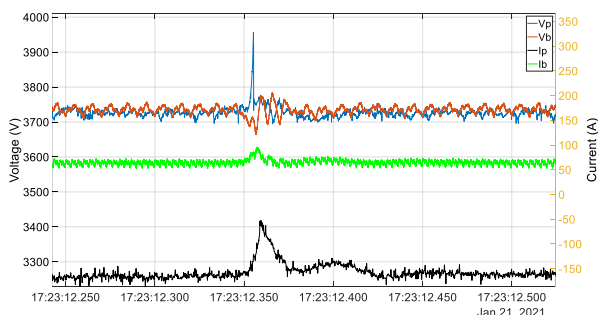

Figure 18 conducted effects of the arc seen on-board and in substation.

Finally, events observed in the supply substation due to the inverse polarization of the diode rectifier, the effect of the intervention of a locomotive main circuit breaker, and the propagation of the conducted arc event is shown and described. The last event has been detected since the synchronized measurement performed onboard locomotive and in a substation. Further statistical analysis on the occurrence of such PQ events is ongoing.

ACKNOWLEDGMENT

The results here presented are developed in the framework of the 16ENG04 MyRailS Project. The latter received funding from the EMPIR program co-financed by the Participating States and from the European Union's Horizon 2020 research and innovation program. The authors thanks RFI and Metro de Madrid for their valuable support in performing the measurements.

REFERENCES

- [1] A. Mariscotti and D. Giordano, 'Experimental Characterization of Pantograph Arcs and Transient Conducted Phenomena in DC Railways', *ACTA IMEKO*, vol. 9, no. 2, Art. no. 2, Jun. 2020, doi: 10.21014/acta_imeko.v9i2.761.
- [2] A. Mariscotti, 'Characterization of Power Quality transient phenomena of DC railway traction supply', *ACTA IMEKO*, vol. 1, no. 1, Art. no. 1, Jul. 2012, doi: 10.21014/acta_imeko.v1i1.17.
- [3] A. Mariscotti, 'Discussion of Power Quality Metrics suitable for DC Power Distribution and Smart Grids', presented at the 24th IMEKO TC4 International Symposium Electrical & Electronic Measurements, Xi'an, China, Sep. 20, 2019. doi: 10.5281/zenodo.3604343.
- [4] M. A. Suárez, J. W. González, and I. Celis, 'Transient overvoltages in a railway system during braking', in *2010 IEEE/PES Transmission and Distribution Conference and Exposition: Latin America (T D-LA)*, Nov. 2010, pp. 204–211. doi: 10.1109/TDC-LA.2010.5762883.
- [5] E. Pons, P. Colella, and R. Rizzoli, 'Overvoltages in DC Urban Light Railway Systems: Statistical Analysis and Possible Causes', in *2018 IEEE International Conference on Environment and Electrical Engineering and 2018 IEEE Industrial and Commercial Power Systems Europe (EEEIC / I CPS Europe)*, Jun. 2018, pp. 1–6. doi: 10.1109/EEEIC.2018.8494549.
- [6] A. E. Díez, M. Restrepo, J. Vega, C. Meléndez, J. D. Arcila, and E. Manrique, 'A Power Quality Case Study of Contact Overhead Lines in the Medellín Metro System', in *2019 IEEE Workshop on Power Electronics and Power Quality Applications (PEPQA)*, May 2019, pp. 1–6. doi: 10.1109/PEPQA.2019.8851567.
- [7] H. J. Kaleybar, M. Brenna, F. Fioadelli, S. S. Fazel, and D. Zaninelli, 'Power Quality Phenomena in Electric Railway Power Supply Systems: An Exhaustive Framework and Classification', *Energies*, vol. 13, no. 24, Art. no. 24, Jan. 2020, doi: 10.3390/en13246662.
- [8] E.-E. A. of N. M. Institutes, 'Details'. <https://www.euramet.org/research-innovation/search-research-projects/details/?L=0> (accessed Jun. 08, 2021).
- [9] A. D. Femine, D. Gallo, D. Giordano, C. Landi, M. Luiso, and D. Signorino, 'Power Quality Assessment in Railway Traction Supply Systems', *IEEE Trans. Instrum. Meas.*, vol. 69, no. 5, pp. 2355–2366, May 2020, doi: 10.1109/TIM.2020.2967162.
- [10] G. Crotti *et al.*, 'Monitoring Energy and Power Quality On Board Train', in *2019 IEEE 10th International Workshop on Applied Measurements for Power Systems (AMPS)*, Sep. 2019, pp. 1–6. doi: 10.1109/AMPS.2019.8897794.
- [11] G. Cipolletta *et al.*, 'Monitoring a DC Train Supplied by a Reversible Substation', in *2020 IEEE International Instrumentation and Measurement Technology Conference (I2MTC)*, May 2020, pp. 1–6. doi: 10.1109/I2MTC43012.2020.9128644.
- [12] D. Signorino *et al.*, 'Dataset of measured and commented pantograph electric arcs in DC railways', *Data Brief*, vol. 31, p. 105978, Aug. 2020, doi: 10.1016/j.dib.2020.105978.