

Enhanced Stray-Load Loss Measurements Through a Zig-Zag Variable Load Test Approach

*Original*

Enhanced Stray-Load Loss Measurements Through a Zig-Zag Variable Load Test Approach / Vaschetto, Silvio; Cavagnino, Andrea; Agamloh, Emmanuel B.; Tenconi, Alberto. - In: IEEE TRANSACTIONS ON INDUSTRY APPLICATIONS. - ISSN 0093-9994. - (2021), pp. 226-235. [10.1109/TIA.2020.3029757]

*Availability:*

This version is available at: 11583/2859222 since: 2022-04-05T10:19:33Z

*Publisher:*

IEEE

*Published*

DOI:10.1109/TIA.2020.3029757

*Terms of use:*

openAccess

This article is made available under terms and conditions as specified in the corresponding bibliographic description in the repository

*Publisher copyright*

IEEE postprint/Author's Accepted Manuscript

©2021 IEEE. Personal use of this material is permitted. Permission from IEEE must be obtained for all other uses, in any current or future media, including reprinting/republishing this material for advertising or promotional purposes, creating new collecting works, for resale or lists, or reuse of any copyrighted component of this work in other works.

(Article begins on next page)

# Enhanced Stray-Load Loss Measurements Through a Zig-Zag Variable Load Test Approach

Silvio Vaschetto, *Senior Member, IEEE*, Andrea Cavagnino, *Fellow IEEE*,  
Emmanuel B. Agamloh, *Senior Member, IEEE*, Alberto Tenconi, *Senior Member, IEEE*

**Abstract**—This paper proposes an enhanced procedure for executing the standard variable load test that allows obtaining high correlation factors for indirectly measured stray-load loss during efficiency tests of induction motors. This helps to achieve the minimum values required by the international standards to consider the variable load test well executed, avoiding unwelcome test repetitions and leading to significant amount of time saved. With the machine at steady state temperature, the enhanced procedure consists of alternatively applying load levels higher and lower than the rated load, so that the stator winding temperature zigzags around the rated value. Hence, multiple readings can be performed for each load points, having the machine in isothermal conditions. This allows averaging many measurements of the same load point to mitigate the impact of instrumentation and reading errors. The paper includes load tests conducted on different induction motor sizes and pole counts, applying both the standard variable load test procedure and the proposed approach. The experimental results show that the proposed technique allows achieving higher correlation factors on the stray-load losses than the standard procedure.

**Index Terms**—Induction motor, stray-load losses (SLL), efficiency, variable load test, temperature test, no-load test, IEEE Std 112-B, IEC 60034-2-1.

## I. INTRODUCTION

THE WIDE use of Induction Motors (IM) in industrial applications makes by far their impact on global energy consumption of relevant importance. Therefore, regulations impose to IM manufacturers the efficiency labeling of their products, as tested according to international standards such as the IEEE 112 or the IEC 60034-2-1. These standards propose various efficiency test methods which might be selected depending on the machine rating or the capability of the test facility to perform the required measurements. However, all the proposed test procedures require to quantify the stray-load loss (SLL) for the efficiency computation. This loss component represents that portion of the total machine loss not accounted for by the sum of the stator and rotor Joule loss, the core loss and the windage & friction loss [1]. Therefore, the SLL cannot be directly measured using the standard no-load, locked rotor and rated temperature tests [2].

The standards consider three different approaches for evaluating the SLL component: (i) the indirect measurement,

(ii) the direct measurement, and (iii) an assumed value.

Among these, the indirect SLL measurement is indicated as the preferred method for machines having a rated power in the range 0.75 –300 kW. This method comprises a variable load test, conducted at the machine steady-state temperature, at six load points spread between 150% and 25% of the rated load. The different load levels have to be applied consecutively, starting from the highest value down to the lowest. To minimize temperature variations in the machine during these measurements, the test must be conducted as quickly as possible. Industrial sectors of many manufacturers addressed the issue by introducing advanced automated equipment to quickly collect necessary data for each load point, thereby avoiding significant motor temperature variations during the tests. These automated systems work well, but require some capital investment. Furthermore, even when automated systems are used, some temperature variation in stator windings is inevitable due to the time that must be allowed for transient measurement values to stabilize when load points are changed from one value to the next level. Such a temperature variation, together with possible errors in the instrumentation or in the readings when manual procedures are used, can affect the accuracy of the SLL determination and particularly the linear correlation of load the test points used to evaluate the validity of the test. Thus, the stray-load loss represents a key element for a precise efficiency evaluation, but also remains the barrier as to whether a test is passed or repeated [3], [4]. Since the correlation factor of the SLL versus the squared torque indicates how the test data points align, the standards prescribe minimum levels that must be achieved to consider the test valid. In case the required criteria are not met, one out-of-line test point can be deleted in order to improve the correlation coefficient. If after the deletion, the required minimum value is not met, the entire test must be repeated, which is obviously unwelcome. Considering that the calculated efficiency value is often not affected, regardless of whether the correlation factor is valid or not, such test repetitions are totally wasteful.

Both academic and industrial researchers have proposed alternative and improved approaches to evaluate the SLL focusing on dedicated testing procedures as well as on approaches that combine measurements and analytical/numerical evaluations [4]-[13]. Equivalent circuits which take into account the stray-load loss have also been proposed [14], [15]. The ultimate goal for all these research activities is to improve the accuracy on the evaluation of IMs efficiency, and the proposed approaches may be considered for the development of future revision of the international standards [16], [17].

Manuscript received June 19, 2020; revised August 4, 2020; accepted October 4, 2020. Paper 2020-EMC-0879.R1, presented at the 2019 IEEE Energy Conversion Congress and Exposition, Baltimore, MD, USA, Sept. 29 – Oct. 3, and approved for publication in the IEEE TRANSACTIONS ON INDUSTRY APPLICATIONS by the Electric Machine Committee of the IEEE Industry Application Society.

S. Vaschetto, A. Cavagnino and A. Tenconi are with the Politecnico di Torino, Dipartimento di Energia, Turin, Italy (silvio.vaschetto@polito.it, andrea.cavagnino@polito.it, alberto.tenconi@polito.it).

E.B. Agamloh is with the Department of Electrical and Computer Engineering, Baylor University, Waco, Texas, USA (eagamloh@ieec.org).

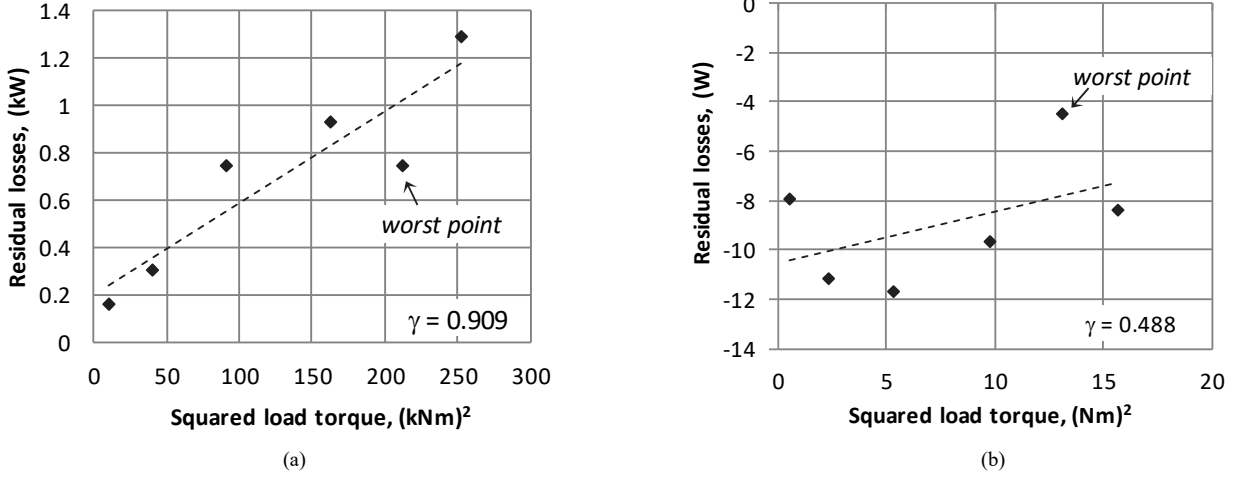

Fig. 1. Standard residual losses vs. squared load torque and SLL correlation factor  $\gamma$ : (a) 100hp, 4 pole, 60 Hz motor, (b) 1.5hp, 2 pole, 60 Hz, motor..

TABLE I  
SLL CORRELATION FACTOR THRESHOLDS IMPOSED BY THE STANDARDS

Standard	Minimum value for the SLL correlation factor	Reference
IEEE 112-B	0.90	[1]
IEC 60034-2-1	0.95	[21]

The SLL are a critical issue also under inverter supply [18]-[20]. However, this work focuses on sinusoidal supply voltage, proposing an enhanced variable load test procedure that enables for achieving high correlation factors of the SLL fitting line, markedly minimizing the risk of an unwelcome test repetition. The proposed approach replaces the regular load test procedure with a ‘quasi-standard’ variable load test consisting of alternatively applying load levels higher and lower than the rated load, so that the stator winding temperature alternatively increases and decreases (zigzags) around its steady state value. This allows to take multiple measurements at the different load points, while having the machine always at the steady-state temperature value. In this way, it is then possible to average the different measurements at the same load point, thereby mitigating potential errors in the instrumentation and/or in the readings. The paper reports the testing activity conducted on IMs having different sizes and pole counts. The experimental results show that the proposed zig-zag approach enables to achieve a higher correlation factor for the SLL than the standard procedure. The higher correlation factor implies that the risk of test repetitions is minimized for the zig-zag approach compared to the standard approach. Finally, the pros and cons of the proposed method and its industrial applicability are discussed.

## II. STANDARD STRAY-LOAD LOSS INDIRECT MEASUREMENTS

According to IEEE 112-B, the SLLs are indirectly obtained by subtracting the total conventional losses (i.e. the sum of stator and rotor  $I^2R$  losses, the core loss, the friction and windage loss) from the apparent total losses (i.e. the difference between stator and shaft power). The SLL value is computed for each load point of the variable load test [1]. This computed quantity (SLL value) is defined as ‘residual losses’ by the IEC standard [21]. Both standards prescribe a linear fitting of the above quantity versus the squared load torque to obtain the

corrected SLL. Although test procedures for the indirect SLL measurement are comparable between the two standards, they require different thresholds for the correlation factor (referred in this study as  $\gamma$ ) for the test validity: 0.9 for the IEEE 112-B, and 0.95 for the IEC 60034-2-1. The correlation factor of the standards are summarized in Table I. Upon completion of the variable load test, the correlation factor can be quickly computed using inbuilt functions of electronic spreadsheets or, for instance, by (1), where  $i$  is the number of tested load points,  $T$  are the load torques and  $P_{Lr}$  are the residual losses for each load levels [21].

$$\gamma = \frac{i \times \sum (P_{Lr} \times T^2) - (\sum P_{Lr}) \times (\sum T^2)}{\sqrt{(i \times \sum (T^2)^2 - (\sum T^2)^2) \times (i \times \sum P_{Lr}^2 - (\sum P_{Lr})^2)}} \quad (1)$$

For graphical visualization, when the residual losses are plotted versus the squared load torque, they usually show a scattered nature with respect to the trend line. An example is shown in Fig. 1 for a 100hp, 4 pole, 60Hz and a 1.5hp, 2 pole, 60Hz induction motors, tested according to the standard IEEE 112-B. These scatters are typically due to errors either in the instrumentation or in the test readings [1].

For the tested 100hp motor, the correlation factor considering all the six load points results 0.909. As discussed above, this value is borderline acceptable for the IEEE 112-B, but unacceptable for IEC 60034-2-1. However, if the worst point is excluded as standards allow, the correlation factor increases to 0.980. For the 1.5hp motor in Fig. 1b, the first test indicates a correlation coefficient of 0.488. However, even if the worst point is deleted, the correlation coefficient does not achieve the minimum level required by the standards to consider the test valid. In this case, the errors are such that test repetition is warranted. Therefore, an improved technique is welcome to mitigate such occurrences.

As the instrumentation accuracy is prescribed by the standards, the authors believe that the only way to improve the measurement ‘stability’ and repeatability is to keep the motor temperature as constant as possible during the test execution. For this reason, the proposed zig-zag procedure for the variable load test looks at the target of obtaining highest correlation factors on the SLL, minimizing the risk for a complete test repetition.

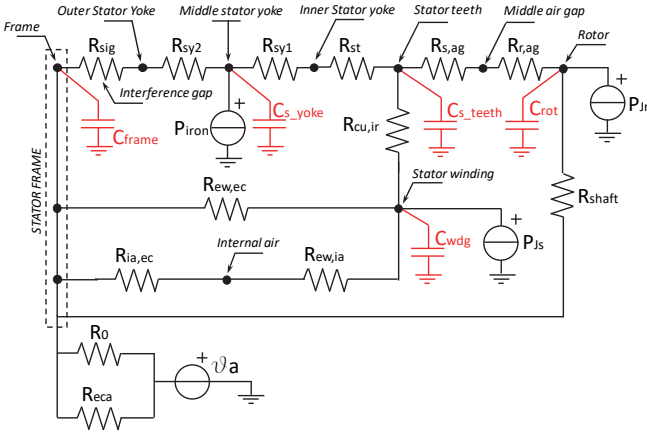

Fig. 2. Simplified thermal network for IM transient thermal prediction.

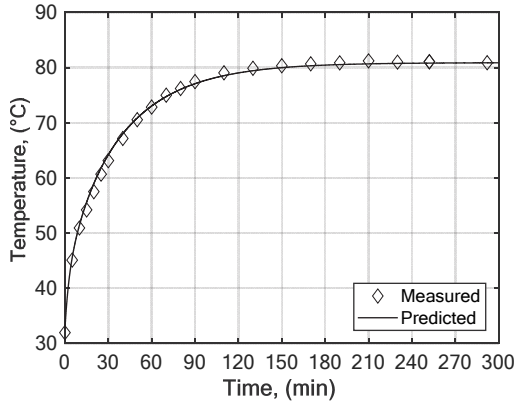

Fig. 3. Thermal model calibration for the tested 15kW IM (load test conditions: 97.5 Nm and 1465 rpm).

### III. TEMPERATURE VARIATIONS DURING THE VARIABLE LOAD TESTS

Even if the standard variable load test is executed quite rapidly, a variation in the stator winding temperature is inevitable when the different load levels are transitioned from one level to another. This temperature variation directly impacts the winding resistance and the actual Joule losses. Therefore, the indirect measurement of the SLL for each load point result is also affected.

In order to gain an insight into the average stator winding temperature variation during the execution of the variable load test prescribed by the standards, the authors developed and calibrated a lumped parameter thermal model for a 15kW Total Enclosed Fan Cooled (TEFC) induction motor tested for this research activity.

#### A. Thermal model definition and calibration

The thermal model used in this work for evaluating the average stator winding temperature is based on a simplified lumped parameter thermal network developed and validated by the authors in previous research activities [22]. The reference thermal network allows for predicting the steady-state temperature of the TEFC induction motor. Therefore, in order to evaluate the thermal transient performance of the machine during the variable load test execution, the network has been updated to include the thermal capacitances.

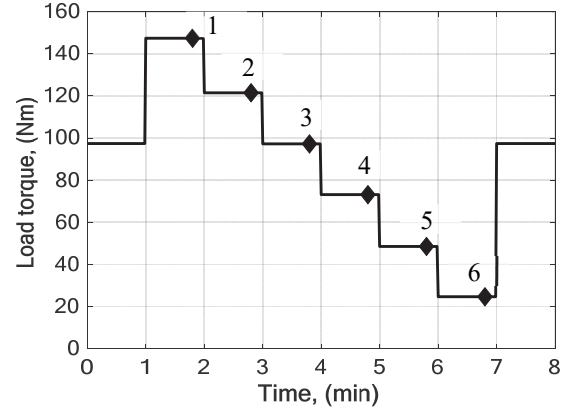

(a)

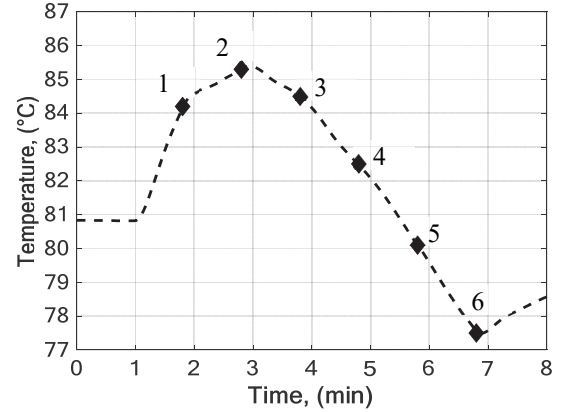

(b)

Fig. 4. Standard variable load test for the 15kW IM: (a) load torque, (b) average stator winding temperature evaluated by the calibrated thermal model.

Figure 2 highlights the five thermal capacitances that represent the rotor structure, the machine frame, the stator yoke, the stator teeth and the stator winding. For the tested 15kW IM, the values of the thermal capacitances were computed by the weights of the different machine parts, while the thermal resistances were computed as describe in [22].

As the 15kW motor under test is equipped with four thermal sensors placed in the stator winding (one in the slot and three in the end-windings), a fine calibration of the thermal model has been done by comparing the predicted temperatures with those measured during the rated load temperature test. Figure 3 shows the comparison between the predicted and the measured average stator winding temperature at rated torque and speed.

It is important to highlight that, even if the machine under test is equipped with thermal sensors, these measures do not represent the average winding temperature. For this reason, the comparison with the model prediction has been done considering the average measurement of the four sensors in the stator winding. Under steady-state thermal conditions, it has been verified that this value is almost equal to the average temperature estimated at shutdown.

#### B. Average stator winding temperature for standard variable load test

Fig. 4a shows the load torque levels applied for the standard variable load test on the above mentioned 15kW IM.

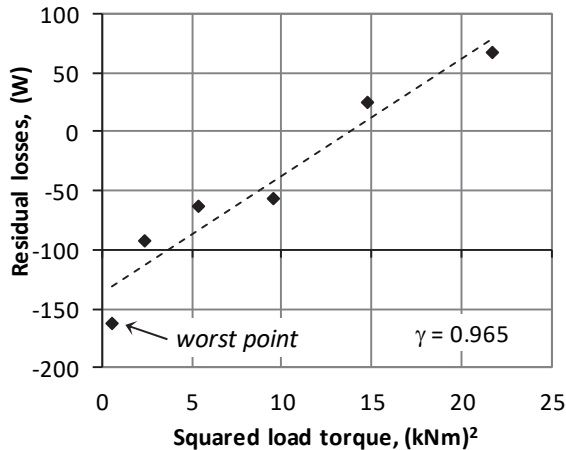

Fig. 5. Standard residual losses vs. squared load torque for the 15kW, 4 pole, 50Hz induction motor.

The test has been performed by a skilled operator, and the elapsed time between one measurement point and the other was the minimum necessary for the load torque settings and the instrument readings to remain steady. In Fig. 4 the marker numbering indicates the measurement sequence that is prescribed by the standards, requiring the test to be performed, starting from the highest load level down to the lowest. Note that in Fig 4a (also in Fig 4b), the markers have been graphically placed at the time instants at which the test measurements have been recorded during the test execution.

Fig. 4b shows for each load point the average stator winding temperature evaluated using the calibrated thermal model. Note that it is not possible to measure the average winding temperature during the standard variable load test. Even with the standards requiring the test to be performed, starting from the highest load level down to the lowest in order to mitigate the temperature variation, this investigation shows that appreciable temperature differences occur during the test. In particular, the average stator winding temperature rapidly increased when the highest load torque levels are applied, and fell below the steady state temperature for reduced load points. The conducted standard variable load test results in a correlation factor for the SLL equal to 0.965 for the six load points, as shown in Fig. 5. However, the scattered nature of the residual losses with respect to the linear fitting line is also well visible in Fig. 5.

The correlation factor increases up to 0.979 if the worst point is deleted. Hence, the test can be considered satisfactory according to the standards, and a test repetition is excluded in the case of this test. In this case, the superiority of the proposed enhanced procedure for the variable load test can only be evaluated by the extent to which a higher correlation factor is achieved in comparison to the standard test.

#### IV. ZIG-ZAG VARIABLE LOAD TEST

The proposed zig-zag variable load test consists of applying the six load levels prescribed by the standards in alternating high and low level sequence in a zig-zag manner. The method was previously described in [23] and the zig-zag sequence is graphically represented in Fig. 6a for the 15kW induction motor. In Fig 6a, the test data points are from 25% up to 150% of the rated load, with steps of 25%.

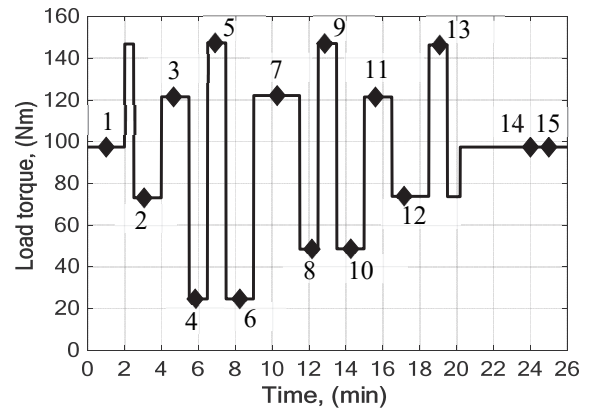

(a)

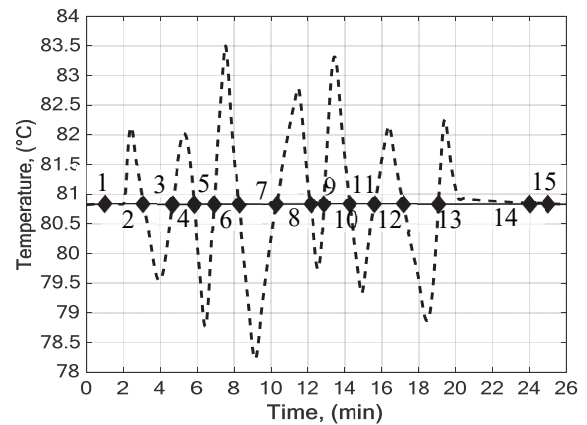

(b)

Fig. 6. Zig-zag variable load test for the 15kW, 4 pole, 50Hz induction motor: (a) load torque, (b) average stator winding temperature evaluated with the calibrated thermal model.

While the load is varied in this fashion, the average stator winding temperature increases and decreases repeatedly with respect to the steady-state value and follows the dotted line shown in Fig. 6b which was obtained by means of the calibrated thermal model. As the average stator winding temperature crosses the steady-state value, the instrument readings for each load point are taken at the points depicted by the numbered markers. The proposed zig-zag technique does not require a specified or optimized pattern regarding the load level sequence. For instance, once the machine is at steady-state temperature and test point #1 (Fig 6a) was taken, the authors initially increased the load level over the rated value; this allows to verify that the machine correctly operates at the maximum load level foreseen for the test and to check the instruments ranges. During this operation, the stator winding temperature increases over its steady state value and no measurements are recorded. Then, the load is reduced below the rated value (to 75%, test point #2 in Fig 6a) so that the winding temperature starts decreasing; when it crosses the steady state temperature value, the test data reading is recorded (point #2) and the zig-zag procedure continues. Alternative patterns of the zig-zag sequence are possible and equally effective. The common thing is that, the initial rated load temperature test (heat run) is needed to establish the baseline steady state temperature, so that as the winding temperature crosses the steady-state temperature target, the data measurement at the specified load points are taken.

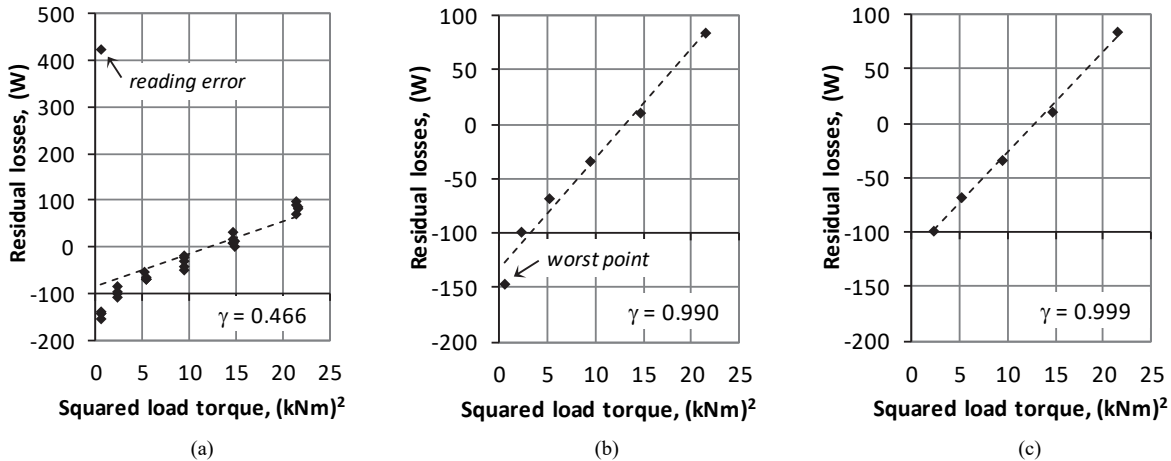

Fig. 7: Zig-zag variable load test for the 15kW, 4 pole, 50Hz induction motor: (a) residual losses vs. squared load torque, (b) average values for each load point, (c) worst point deleted.

Fig. 7 shows the zig-zag variable load test results for the same 15kW TEFC induction motor that was previously tested with the standard method (see Fig. 5). Besides having the machine in the same thermal conditions for all the measurement points, the zig-zag procedure features additional advantages compared to the standard method. For instance, multiple readings can be done for each load level; in case of errors in the instrument readings a single measurement point is deleted but the others are still valid for the SLL evaluation. This error occurrence is evident in the results shown in Fig. 7a, where the indicated  $\gamma$  value has been computed considering the out of line point due to the obvious reading error.

If this point is excluded the correlation factor for the initial measurements equals to 0.983, and is higher than the value obtained by the standard test. Moreover, for each load point the zig-zag approach enables averaging, since several measurements at the same load point is taken. In this way errors in the instrumentations are averaged and their effect is minimized, and test outcome is improved.

Considering the average values for the residual losses and the squared load torques, as shown in Fig. 7b, the correlation factor increases up to 0.990 for the tested 15kW motor. Furthermore, if the worst point among the six 'averaged' load levels is deleted, as allowed by the standards, the correlation factor practically tends to 1, as shown in Fig. 7c. Therefore, the performed tests show that very high values for  $\gamma$  are achievable using the proposed method.

To further validate the benefit of the zig-zag procedure to yield very high correlation coefficients, both the standard and the zig-zag variable load tests have been conducted on other IMs of different sizes and poles. The results for a 30hp, 4 pole, 60Hz motor tested according to the standard method and to the zig-zag procedure are shown in Fig. 8 and Fig. 9, respectively. The standard variable load test on this machine provided a correlation factor for all the six load points equal to 0.81 (Fig. 8a); however, the worst point deletion improves  $\gamma$  to 0.978, as shown in Fig. 8b. Hence, the test can be considered satisfactory and the second regression analysis can be used to determine the corrected SLL for the total motor loss computation. In this case, the motor efficiency evaluated according to the IEEE 112-B method was 93.5%.

Fig. 9 shows the results when the zig-zag variable load test is executed on the same 30hp motor. In this case the average residual losses and squared load torques of three measurements have been considered for each load point. Comparing the residual losses shown in Fig. 9 with those in Fig. 8 for the standard method, we see lower data scattering when the zig-zag procedure is used. This reflects in a  $\gamma$  value equal to 0.991 for the zig-zag method when all the six load points are considered (Fig. 9a); thus, the risk for a test repetition is practically excluded. Furthermore, as shown in Fig. 9b, if the worst point is deleted, the zig-zag procedure yields a correlation factor of 0.998 for this motor. It is worth mentioning that, in this case, using the zig-zag procedure for the determination of the corrected SLL component, the motor efficiency was 93.3%. Indeed, comparing Fig. 8 with Fig. 9, it is observed that the zig-zag test ended up with residual losses, and consequently the SLLs too, slightly higher than the standard procedure. More comments on the SLL estimation are presented in Section IV.A.

The residual losses obtained by applying the standard variable load test and the zig-zag procedure on a 60hp, 2 pole, 60Hz induction motor are shown in Fig. 10 and Fig. 11, respectively. For this machine, the regression analysis after a first execution of the standard test revealed a correlation factor of 0.49 when all the six points are considered. Even with the worst point deletion it was not possible to improve the correlation factor to the minimum value prescribed by the standard, as shown in Fig. 10a. Therefore, in this case the test failed and it had to be repeated. It is worth mentioning that during the test execution, the stator winding temperature variation measured using embedded sensors was within the 10°C range that the IEEE method stipulates. In the authors' opinion, the test failure suggests that this temperature tolerance may need to be tightened to avoid unsatisfactory test results. Note that even though the test has to be repeated, for the purpose of the research the motor efficiency computed using the residual losses in Fig. 10a was 94.6%. This efficiency number is invalid only because of the failed correlation coefficient. Beside the time required to repeat the variable load test itself, the test failure also implies to run the machine again with rated load until the steady-state temperature condition is restored, which is an obvious waste of time.



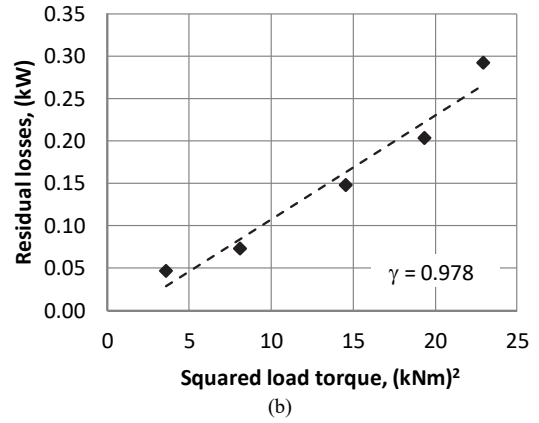
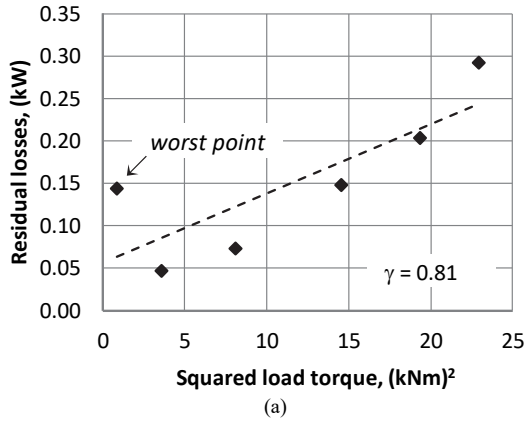

Fig. 8: Standard variable load test for the 30hp, 4 pole, 60Hz induction motor: (a) six measurement points, (b) worst point deleted.

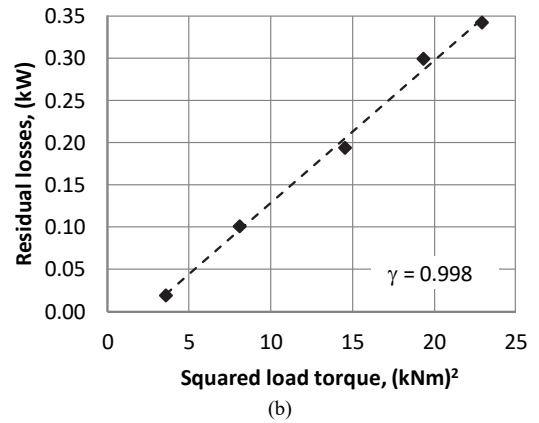
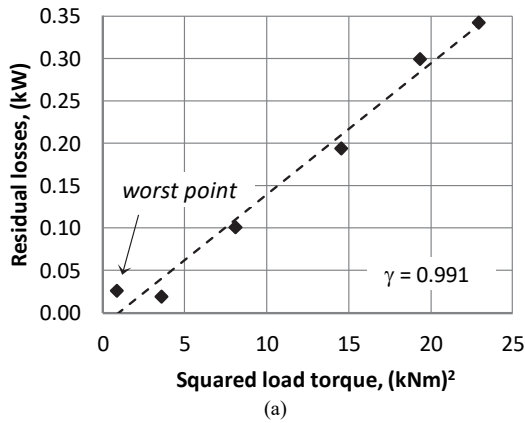

Fig. 9: Zig-zag variable load test for the 30hp, 4 pole, 60Hz induction motor: (a) six measurement points, (b) worst point deleted.

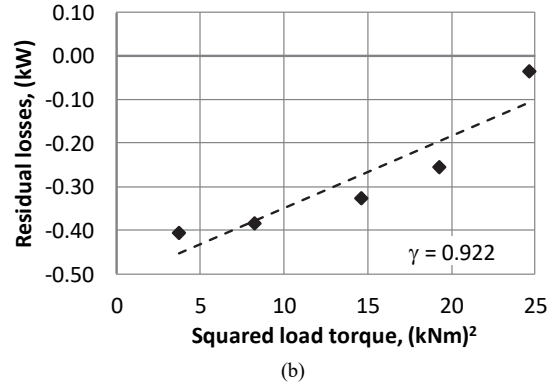
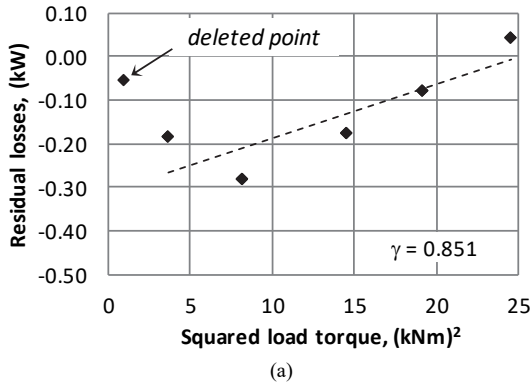

Fig. 10: Standard variable load test for the 60hp, 2 pole, 60Hz induction motor: (a) first test execution, (b) second test execution with worst point deleted.

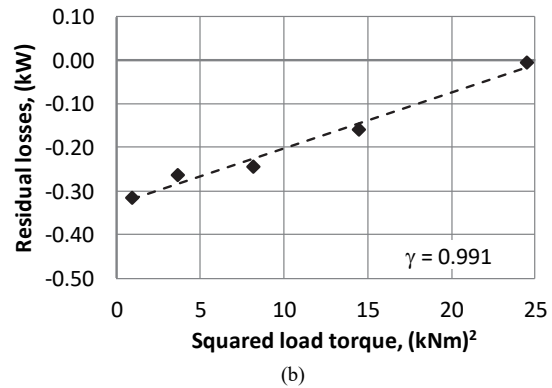
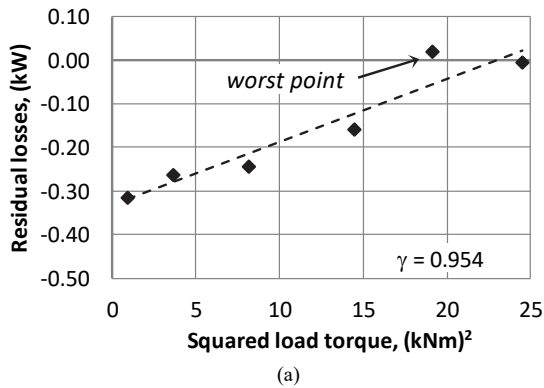

Fig. 11: Zig-zag variable load test for the 60hp, 2 pole, 60Hz induction motor: (a) six measurement points, (b) worst point deleted.

The repeated standard variable load test led to a correlation factor equal to 0.77 when six points are considered; deleting the 25% load point, the correlation factor increased up to 0.922, as shown in Fig. 10b. It is worth nothing that this value of correlation factor is acceptable for the efficiency test according to IEEE standards, but unacceptable for the IEC standard (see Table I).

The motor efficiency computed using the residual losses of this second test was 94.4% that is only slightly lower than the value obtained for the previous invalid test. However, it has to be noted that the 0.2% efficiency difference between the two tests is within the experimental error of the laboratory. Therefore, the efficiency result was practically not influenced by the correlation coefficient on the SLLs.

Fig. 11 shows the results for the zig-zag variable load test executed on an identical 60hp, 2 pole, 60Hz induction motor produced by the same manufacturer. In this case, a correlation factor equal to 0.954 has been obtained at the first test and without point deletion (see Fig. 11a). The motor efficiency resulted equal to 94.4% as for the other identical motor tested according to standard method, proving that the proposed zig-zag approach is solid. Furthermore, deleting the worst point among the six measurements, the  $\gamma$  value for the zig-zag approach increases up to 0.991, as shown in Fig. 11b.

Tests have also been conducted on a 1hp, 6 pole, 60Hz induction motor to further investigate the impact of the pole count. For this low speed machine, the standard method resulted in a correlation factor of 0.999 and the zig-zag yielded 0.9998. Indeed, low speed motors typically have good correlations and the adoption of the proposed zig-zig testing procedure may seem redundant.

#### A. Considerations on the SLL determination

In addition to achieving high correlation factor, it is worth to mention that the zig-zag method allows to determine comparable (but not exactly the same!) SLL, with respect to the conventional variable load test approach. Looking at Table II, for motors tested with or without the zig-zag method, we observe random variations both in the difference of the y-intercept of the regression lines of the residual losses and in the SLL at the rated load. Consequently, it is hard to say what is the most reliable methodology for the estimation of the stray-load losses. However, for all the investigated motor sizes, the differences in the SLL are marginal and they result in negligible or very small discrepancies in the rated efficiency values.

In order to identify potential reasons to explain the differences, the measurements performed on the 50hp, 4 pole, 60 Hz motor have been analyzed in more detail. This machine has been considered as the best candidate because its residual loss fitting line crosses the axes close to the origin (see Fig. 12) and because the largest difference in the SLL at rated load was observed (i.e. 80 W, see Fig. 13 and Table II).

The test bench allows to apply very accurate values of the load torque, making it possible to set identical load torques during the conventional and the zig-zag variable load tests. In addition, the supply voltage is very stable and constant during the tests. This results in negligible difference between the output power with or without the zig-zag method – as shown by the loss difference (*Delta Poutput*) trend represented by the triangles in Fig. 14.

TABLE II  
SELECTED LOSS DIFFERENCES WITH AND WITHOUT THE ZIG-ZAG METHOD

	y-intercept <sup>(*)</sup>	SLL @ $T_{rated}$	sec
15 kW – 4 pole	+15 W	+6 W	Figs. 5 – 7.c
30°hp – 4 pole	-253 W	+40 W	Figs. 8.b – 9.b
60°hp – 2 pole	+184 W	-55 W	Figs. 10.b – 11.b
50°hp – 4 pole	+40 W	+80 W	Figs. 12 – 13

<sup>(\*)</sup> the difference of the y-intercepts of the residual losses fitting lines.

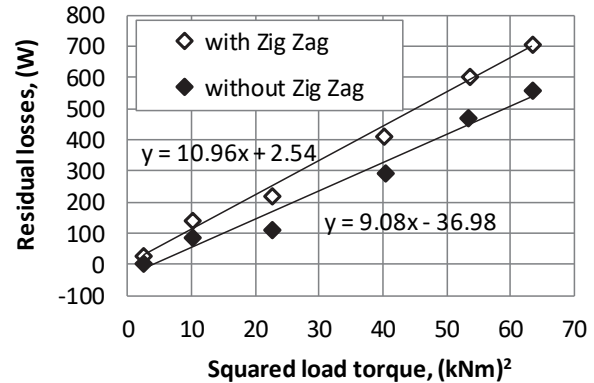

Fig. 12: Residual losses and their fitting lines for a 50hp, 4 pole, 60 Hz induction motor by the variable load test with or without the zig-zag method.

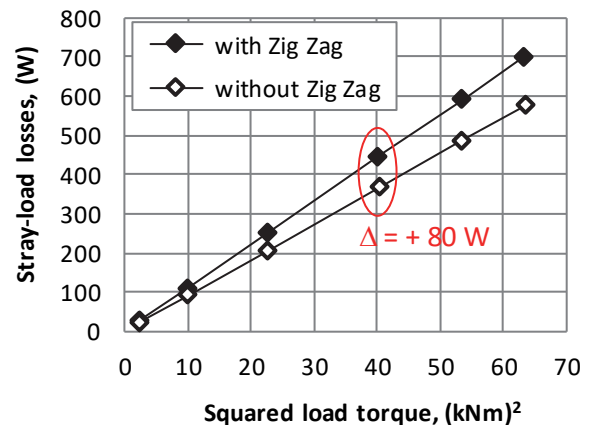

Fig. 13: Stray-load losses for a 50hp, 4 pole, 60 Hz induction motor by the variable load test with or without the zig-zag method.

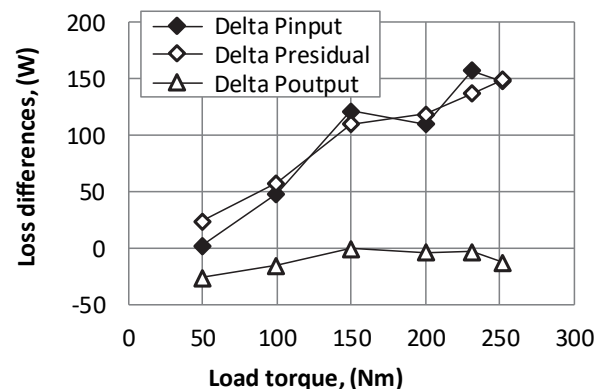

Fig. 14: Loss and power measurement differences for a 50hp, 4 pole, 60 Hz induction motor: variable load test measurements with the zig-zag method minus the conventional ones.

However, it was observed that the difference between the two residual loss trends shown in Fig. 12 (or, equivalently, the difference of the SLL in Fig. 13) are correlated with the



differences in the input power of the two variable load tests. This is evident in Fig. 14, where *Delta Presidual* and *Delta Pinput* are measurement difference for residual loss and power input, representing the difference between the quantities measured when the zig-zag approach is used compared to those measured with the standard approach. This indicates that for the considered machine, the input power and the total losses seem to slightly depend on the test methodology that is used. Despite the different test procedures, the stator and rotor Joule losses are practically identical at the considered load points. Therefore, the differences in the input power and, consequently, in the residual losses could be potentially explained assuming a comparable linear variation in the friction losses. However, considering the reliability of the test bench that was used and the fact that the zig-zag test and standard test was conducted by the same experienced technician, a hypothetical variation of the friction losses does not seem plausible. Summarizing, the analysis of the measurements does not explain the loss differences shown in Fig. 12–14, even if the impact on the rated efficiency is marginal: 93.1% and 93.3% with and without zag-zag method, respectively (the nameplate efficiency is 93.0%).

The small differences observed between the SLL evaluated by the two methodologies could be understood by subjecting the problem to a statistical analysis that the authors plan to undertake in a subsequent study.

#### V. APPLICABILITY REMARKS OF THE PROPOSED METHOD

In addition to achieving high correlation factor on the stray-load losses than the standard procedure, another key advantage of the proposed method that is worth mentioning is that at the end of the zig-zag variable load test the stator winding temperature is practically at the steady-state value (see, for example, Fig. 6b). This would allow measuring the *dc* winding resistance at the end of the zig-zag test instead of after the rated load temperature test, as currently prescribed by the standards. The advantage is that the motor does not need to be shut down for resistance measurement prior to the load test. Hence, the zig-zag procedure does not need any time delay between the rated load temperature test and the test under load for restoring the stator winding temperature within 10°C of the hottest temperature reading during the rated load temperature test.

The improved agreements on the test data points granted by the proposed zig-zag variable load test, as well as the possibility of *dc* winding measurements at the conclusion of the test, without time delays, can be of interest not only for research activities, but also for industry as laboratories endeavor to optimize personnel time during testing as well as reduce the risk of wasteful test repetitions. Obviously, the use of the proposed approach must be evaluated on a case by case basis, because it implies changing the well-established standard procedure. However, it is valuable approach for test motors that repeatedly achieve low correlation factors, especially for 2 pole and 4-pole motors and to a less extent for high pole count motors.

Furthermore, the proposed procedure requires a thermal sensor embedded into the stator windings. This winding temperature reading can be used to monitor the motor temperature transients during the test in order to define the time instants at which the measurement points have to be recorded (see Fig. 6). Considering the various instrument readings that

have to be recorded during a variable load test, a data acquisition system can help to perform fast and synchronized acquisitions when the temperature measured by the sensor crosses the steady-state temperature target during the zig-zag procedure. However, the use of such automated equipment is not mandatory, and the test can be conducted manually, as done by the authors for all the motors tested for this research activity.

#### VI. CONCLUSION

This paper proposed an enhanced test procedure for the indirect measurement of the stray-load losses in induction motors. In particular, the proposed approach enables to take multiple readings for each load level at the machine's rated condition steady-state temperature. Consequently, potential errors in the instrumentation and test readings can be mitigated by averaging the multiple measurements for each load level. This approach achieves higher correlation factors in the SLL calculation during efficiency evaluations, compared to the standard approach. The experimental tests conducted on different induction motor sizes and pole counts validated the benefit of the procedure to yield very high correlation coefficients, in particular for high speed machines (2 or 4 poles).

Since international standards impose a minimum value on the SLL correlation coefficient to consider the variable load test acceptable for efficiency evaluations, the proposed approach could lead to significant time savings in conducting efficiency tests that would otherwise have been repeated for invalid correlation. Therefore, the proposed test method has the potential to improve the test validity rate in an industrial setting. Furthermore, as the current standards allow for thermal sensors to be installed for tested motors, the proposed procedure can easily be incorporated into existing standards and would be of much benefit to industrial facilities.

#### REFERENCES

- [1] International Standard IEEE 112, "Test Procedure for Polyphase Induction Motors and Generators", 2017.
- [2] K.J. Bradley, W. Cao, J. Arellano-Padilla, "Evaluation of Stray Load Loss in Induction Motors With a Comparison of Input-Output and Calorimetric Methods", *IEEE Trans. Energy Convers.*, vol. 21, no. 3, pp. 682-689, Sept. 2006.
- [3] E.B. Agamloh, "An Evaluation of Induction Machine Stray Load Loss From Collated Test Results", *IEEE Trans. Ind. Appl.*, vol. 46, no. 6, pp. 2311-2318, Nov./Dec. 2010.
- [4] P. Pillay, M. Al-Badri, P. Angers, C. Desai, "A new Stray-Load Loss Formula for Small and Medium-Sized Induction Motors", *IEEE Trans. Energy Convers.*, vol. 31, no. 3, pp. 1221-1227, Sept. 2016.
- [5] M. Al-Badri, P. Pillay, P. Angers, "Induction Machine Rapid Performance Test", *IEEE Trans. Ind. Appl.*, vol. 55, no. 5, Sept/Oct. 2019, pp. 4685-4691.
- [6] A. Boglietti, A. Cavagnino, L. Ferraris, "Impact of the Supply Voltage on the Stray-Load Losses in Induction Motors", *IEEE Trans. Ind. Appl.*, vol. 46, no. 4, pp. 1374-1380, Jul./Aug. 2010.
- [7] M. Aoukadi, A. Binder, "When loads stray—Evaluation of Different Measurements Methods to Determine Stray Load Losses in Induction Machines", *IEEE Ind. Electron. Mag.*, vol. 2, no. 1, pp. 31-30, Mar. 2008.
- [8] K.J. Bradley, W. Cao, J. Arellano-Padilla, "Evaluation of stray load loss in induction motors with a comparison of input-output and calorimetric methods", *IEEE Trans. Energy Convers.*, vol. 21, no. 3, pp. 682-689, Sept. 2006.
- [9] M. Aoukadi, A. Binder, "Comparison of Different Evaluation Methods to Determine Stray Load Losses in Induction Machines With Eh-Star Method", *IEEE Trans. Ind. Appl.*, vol. 44, no. 6, pp. 1675-1682, Nov./Dec. 2008.

- [10] R. Kumar, P. Kumar, T. Kanekawa, K. Oishi, "Stray Loss Model for Induction Motors With Using Equivalent Circuit Parameters", *IEEE Trans. Energy Convers.*, vol. 35, no. 2, pp. 1036-1045, June 2020.
- [11] M. Bašić, D. Vukadinović, M. Polić, "Stray Load and Iron Losses in Small Induction Machines Under Variable Operating Frequency and Flux: A Simple Estimation Method", *IEEE Trans. Energy Convers.*, vol. 33, no. 2, pp. 869-876, June 2018.
- [12] J. Cheaytani, A. Benabou, A. Tounzi, M. Dessoude, "Stray Load Losses Analysis of Cage Induction Motor Using 3-D Finite-Element Method With External Circuit Coupling", *IEEE Trans. Magnetics*, vol. 53, no. 6, pp. 1-4, June 2017.
- [13] Yamamoto, H. Hirahara, B.A. Shantha, "A Method to Estimate Torque and Stray Load Loss of Induction Motor without Torque Detector", 2019 IEEE Energy Conversion Congress and Exposition (ECCE), Baltimore, MD, USA, 2019, pp. 2341-2346.
- [14] K. Yamazaki, A. Suzuki, M. Ohto, T. Takakura, S. Nakagawa, "Equivalent Circuit Modeling of Induction Motors Considering Stray Load Loss and Harmonic Torques Using Finite Element Method", *IEEE Trans. Magnetics*, vol. 47, no. 5, pp. 986-989, May 2011.
- [15] A. Boglietti, A. Cavagnino, L. Ferraris, M. Lazzari, "Induction Motor Equivalent Circuit Including the Stray Load Losses in the Machine Power Balance", *IEEE Trans. Energy Convers.*, vol. 23, no. 3, pp. 796-803, Sept. 2008.
- [16] R. McElveen, M. Melfi, J. McFarland, "Improved Characterization of Polyphase Induction Motor Losses: Test Standards Must Be Modified To Improve Efficiency Optimization", *IEEE Ind. Appl. Mag.*, vol. 25, no. 6, pp. 61-68, Nov./Dec. 2019.
- [17] A.T. De Almeida, F.J.T.E. Ferreira, A. Quintino, "Technical and Economical Considerations on Super High-Efficiency Three-Phase Motors", Conf. Rec. IEEE/IAS Industrial & Commercial Power Systems Technical Conference (I&CPS), 2012, pp.1-13.
- [18] H. Karkkainen, L. Aarniovuori, M. Niemela, J. Pyrhonen, "Converter-Fed Induction Motor Efficiency – Practical Applicability of IEC Methods", *IEEE Ind. Electron. Magazine*, pp. 45-57, June 2017.
- [19] M. Bašić, D. Vukadinović, I. Grgić, "Compensation of Stray Load and Iron Losses in Small Vector-Controlled Induction Generators", *IEEE Trans. Energy Convers.*, vol. 34, no. 3, pp. 1677-1685, Sept. 2019.
- [20] E. Levi, A. Lamine, A. Cavagnino, "Impact of stray load losses on vector control accuracy in current-fed induction motor drives", *IEEE Trans. Energy Convers.*, vol. 21, no. 2, pp. 442-450, June 2006.
- [21] Int. Standard IEC 60034-2-1, "Rotating Electric Machines Part 2-1: Standard methods for determining losses and efficiency from tests", 2015.
- [22] A. Boglietti, A. Cavagnino, M. Lazzari, M. Pastorelli, "A Simplified Thermal Model for Variable-Speed Self-Cooled Industrial Induction Motor", *IEEE Trans. Ind. Appl.*, vol. 39, no. 4, pp. 945-952, Jul./Aug. 2003.
- [23] S. Vaschetto, A. Cavagnino, E.B. Agamloh, A. Tenconi, "A new Zig-Zag Variable Load Test Approach for Enhanced Stray-Load Loss Measurements", 2019 IEEE Energy Conversion Congress and Exposition (ECCE), Baltimore, MD, USA, 2019, pp. 2294-2300.



**Silvio Vaschetto** (S'10–M'13–SM'19) received his M.Sc. and Ph.D. degrees in electrical engineering from the Politecnico di Torino, Italy, in 2007 and 2011 respectively. He is an Associate Professor at the Department of Energy, Politecnico di Torino. Dr. Vaschetto is involved in analyses and design of electrical machines for high performance drives for aerospace and automotive applications. Dr. Vaschetto is a member of the IEEE Industry Application Society (IAS) and the Industrial Electronics Society (IES). He is an Associate Editor of the IEEE TRANSACTIONS ON INDUSTRY APPLICATIONS and *IET Electric Power Applications* and regularly serves the scientific community as a Reviewer for several transactions, journals and international conferences.



**Andrea Cavagnino** (M'04–SM'10–F'20) was born in Asti, Italy, in 1970. He received his M.Sc. and Ph.D. degrees in electrical engineering from the Politecnico di Torino, Italy, in 1995 and 2000, respectively. He is a professor at the Politecnico di Torino. He has authored or coauthored more than 200 papers, receiving four Best Paper Awards. His research interests include electromagnetic design, thermal design, and energetic behavior of electrical machines. Prof. Cavagnino is an Associate Editor of the IEEE TRANSACTIONS ON ENERGY CONVERSION, a Past Chair of the Electrical Machines Technical Committee of the IEEE Industrial Electronics Society, and a past Associate Editor of the IEEE TRANSACTIONS ON INDUSTRIAL ELECTRONICS, and the IEEE TRANSACTIONS ON INDUSTRY APPLICATIONS. He was Guest Editor of six Special Sections for the IEEE TRANSACTIONS ON INDUSTRIAL ELECTRONICS. Prof. Cavagnino was the technical program chair of the IEEE-IEMDC 2015 conference. He is a reviewer for several IEEE TRANSACTIONS and other international journals and conferences.



**Emmanuel B. Agamloh** (S'02–M'05–SM'09) received the B.Sc. and M.Sc. degrees in electrical engineering from St. Petersburg State Technical University, St. Petersburg, Russia, in 1992 and 1994, respectively, and the Ph.D. degree in electrical and computer engineering from Oregon State University, Corvallis, OR, USA, in 2005. He is an Associate Professor with the Department of Electrical and Computer Engineering, Baylor University, Waco, TX, USA. His research interests include electric machine design, analysis, and testing and renewable energy with application areas, such as industrial, aerospace, transportation, and oil and gas. Dr. Agamloh was the recipient of two IEEE Best Paper Awards for his research. His extensive industry experience includes a 14-year stint as Technical Director of Advanced Energy's Motor Laboratory, Raleigh, NC, USA. He was a Technical Paper Review Chair of the IEEE TRANSACTIONS ON INDUSTRY APPLICATIONS and a past Chair of the Electric Machines Committee.



**Alberto Tenconi** (M'99–SM'10) received the M.Sc. and Ph.D. degrees in electrical engineering from the Politecnico di Torino, Torino, Italy, in 1986 and 1990, respectively. From 1988 to 1993, he was with the Electronic System Division, FIAT Research Center, where he was engaged in the development of electrical vehicle drive systems. He then joined the Department of Electrical Engineering (now Department of Energy), Politecnico di Torino, where he is currently full professor. His research activity is documented by more than 190 papers published in International Journals and International Conferences. He has participated, both as a designer and as scientific responsible, in many National and European Research Programmes. He is a reviewer for International Journals and has been Associate Editor for the Transactions on Industrial Electronics. His current research interests include electric machines, power converters and drives for transportation electrification.