

Granular flow characterization during sampling operation for Enceladus surface acquisition

Original

Granular flow characterization during sampling operation for Enceladus surface acquisition / Riccobono, Dario; Moreland, Scott; Backes, Paul; Genta, Giancarlo. - ELETTRONICO. - (2021). ((Intervento presentato al convegno ASCE Earth & Space Conference 2021 tenutosi a Seattle (Washington, USA) nel 19-22 Aprile 2021.

Availability:

This version is available at: 11583/2849058 since: 2020-10-19T14:16:17Z

Publisher:

ASCE

Published

DOI:

Terms of use:

openAccess

This article is made available under terms and conditions as specified in the corresponding bibliographic description in the repository

Publisher copyright

(Article begins on next page)

Granular flow characterization during sampling operation for Enceladus surface acquisition

Dario Riccobono^{1,2}, M.S., Scott Moreland², Ph.D., Paul Backes², Ph.D.,
Giancarlo Genta¹, Prof.

¹Department of Mechanical and Aerospace Engineering (DIMEAS), Politecnico di Torino, Corso Duca degli Abruzzi 24 10129 Torino, Italy; email:

dario.riccobono@polito.it, giancarlo.genta@polito.it

²Jet Propulsion Laboratory, California Institute of Technology, 4800 Oak Grove Drive 91109 Pasadena, California, USA; email: dario.riccobono@jpl.nasa.gov,

scott.j.moreland@jpl.nasa.gov, paul.g.backes@jpl.nasa.gov

ABSTRACT

A potential future mission landing on the surface of Saturn's moon Enceladus would represent a unique opportunity to probe the content of an extra-terrestrial ocean potentially hosting life beyond Earth. The content of the subsurface ocean is continuously ejected by plumes, and some of that material settles on the surface, as observed by the Cassini mission. The goal of a potential landing mission would be of collecting and analyzing samples from the upper 1 cm of the surface, made of most recently deposited material from plume fallback. However, the low surface gravity of Enceladus (1% of Earth's) represents a unique challenge for sample handling. This study focuses on the analysis of the novel Dual-Rasp sampling system enabling rapid sampling and collection of surface material into receptacles via momentum transfer. A numerical model based on the Discrete Element Method (DEM) was developed to investigate the tool-soil interaction and the resulting granular material flow while performing surface sample acquisition. A systematic process for validating the DEM simulation model is presented, including an experimental test campaign expected to be conducted in a vacuum chamber in both 1g and low-g environment.

ABBREVIATIONS/ACRONYMS

CAD

Computer-Aided Design

DEM

Discrete Element Method

MBD

Multi-Body Dynamics

1. INTRODUCTION

Observations from the Cassini mission indicate that Enceladus has a subsurface ocean which contains the necessary ingredients to sustain life including thermal vent energy sources and necessary elements. Enceladus has continuously erupting ice plumes that eject material from the subsurface liquid ocean out of surface vents. Some of the material contributes to Saturn's rings while some of the material falls back to the surface. The surface material has the potential to include evidence of life in the subsurface ocean if it exists there. The benign radiation environment of the Saturn surface would allow surface material to be preserved. A lander mission that collects

and analyzes the surface material has the potential to discover evidence of life in the Enceladus subsurface ocean (Figure 1).

It is desired that a sampling system would acquire only very shallow surface material in the top 1cm since this would be the freshest plume material that has fallen to the surface. It is believed that the plume fallback material accumulates at low rates (Southworth et al., 2019) but the approximately 80K surface temperature results in a very slow rate of sintering resulting in surface material that is likely weak and highly porous (Molaro et al., 2019). To account for the potential of greater sintering rates, a novel sampling system, named Dual-Rasp, has been developed to enable sampling from surface material between 400 kPa to 12 MPa strength and 40-95% porosity (Backes et al., 2020). The Dual-Rasp sampling system has been also designed to cope with the low 1% Earth gravity environment, a factor limiting the allowable reacted load from the sampling activity to a lander and represents a unique challenge for sample handling throughout the sample chain steps.



Figure 1. Left: Enceladus' plumes (Credit: NASA/JPL-Caltech/SSI). Right: artistic concept of a lander on the surface of Enceladus.

The Dual-Rasp sampling system (Figure 2) exploits the combination of two high-speed, counter-rotating rasp cutters with teeth to enable rapid sampling and collection of surface material. The sampling system removes the pristine material and throws the cuttings into a collection cup via momentum transfer.

This study focuses on the analysis of the collection of surface material by using the Dual-Rasp sampling system, presenting:

- The numerical model, based on the Discrete Element Method (DEM), developed to investigate the tool-soil interaction after separating sample from the surface and the resulting granular material flow while performing surface sample acquisition. The focus of the analysis is not on sampling mechanics.
- The set of metrics developed to characterize the granular material flow in terms of spatial dispersion and velocity distribution with the aim of supporting the sampling system design.
- The analysis for determining the most sensitive model parameters, including tool-soil interaction properties.
- The independent tests performed by using custom designed apparatus to directly measure the most sensitive model parameters.
- The expected future work to validate the DEM model.

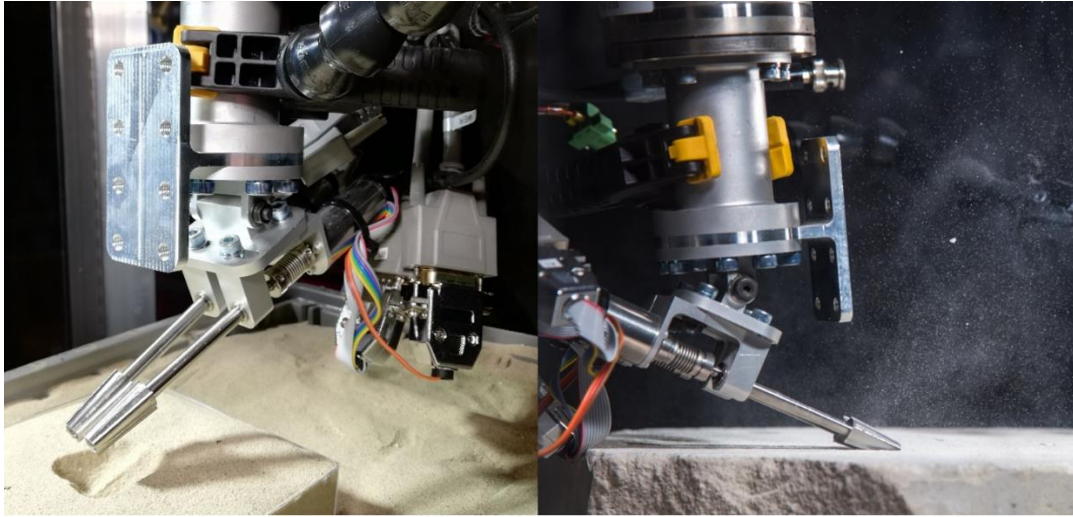

Figure 2. The Dual-Rasp sampling system.

2. APPROACH

The Dual-Rasp sampling system exploits the high-speed counter-rotating motion of its cutters for removing the surface material and throwing the cuttings into a collection cup. Sample collection is then achieved by transferring momentum to the cuttings, thus generating a granular material flow. Figure 3 shows a frame from a high-speed recording of the sampling operation performed by using the Dual-Rasp sampling system. The sample collection relies on the ability of the dual-rasp action of generating a granular material flow as a result of the momentum transfer from cutters to cuttings. Therefore, it is of key importance understating how this process works, in order to make predictions on how it might work in the Enceladus environment.

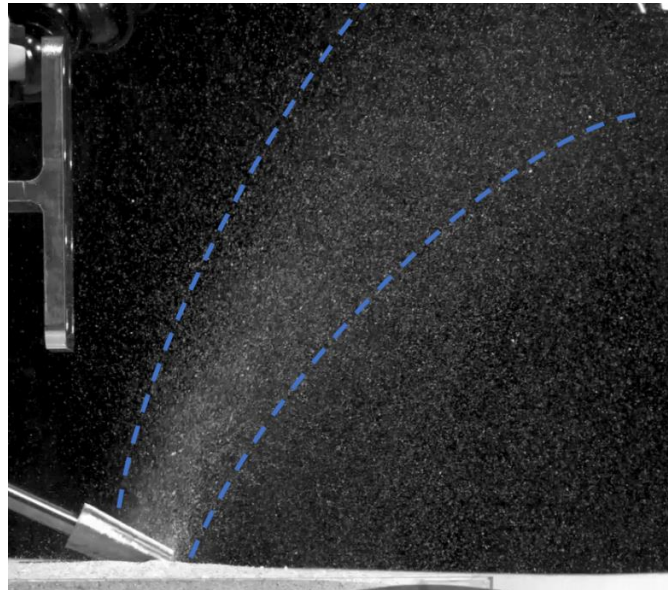

Figure 3. Side view of the granular material flow generated by the action of the Dual-Rasp sampling system while performing the sampling operation.

A numerical model based on the Discrete Element Method (DEM) was developed to investigate the tool-soil interaction and the resulting granular material flow while performing surface sample acquisition.

DEM is a numerical simulation technique for computing the motion and effect of a large number of particles. DEM models treat particles as unique entities in such a way the bulk material behavior arises from the interaction of particles' assembly. Applications include granular/discontinuous materials, granular flows and powder mechanics. As a result, a DEM model is ideal for investigating how momentum transfer works during Dual-Rasp sampling operation, and how granular material flow develops. The aim of such a DEM model is to provide predictions on how sample collection via momentum transfer performs in an Enceladus-like gravity environment, and provide guidelines for supporting the sampling system design.

3. DEM MODEL

The analysis of tool-soil interaction requires a co-simulation between DEM, simulating particles' assembly, and MBD (Multi-Body Dynamics), simulating the action of the Dual-Rasp sampling tool.

The open source software LIGGGHTS from CFDEM®project (2019), has been adopted for the DEM component of the simulation. The in-house-developed software M3tk described in Mukherjee et al. (2014), has been adopted for the MBD component of the simulation.

The DEM simulation model exploits the following contact models to evaluate forces/torques during tool-particle interaction:

- Hertz-Mindlin model for normal-tangential contact, described in Di Renzo and Di Maio (2004), Di Renzo and Di Maio (2005), Ai et al. (2011), Brilliantov et al. (1996), Schwager and Pöschel (2007), Silbert et al. (2001), Zhang and Makse (2005).
- Elastic-Plastic Spring-Dashpot (EPSD2) model for rotational contact, described in Ai et al. (2011).

4. ANALYSIS METRICS

In order to understand how momentum transfer works, how granular material flow develops and how the Dual-Rasp sampling system performs, it is required to define a set of metrics providing a quantitative characterization of the granular material flow. Since the granular material flow would follow a ballistic motion in an Enceladus-like environment with no atmosphere, similar metrics to those required to characterize a projectile ballistic motion were chosen (Figure 4).

- *Velocity magnitude*, this metric highly affects cuttings trajectories, together with the direction of the velocity vector, defined through the following two metrics. Since the granular material flow is made of a number of cuttings, the statistical distribution of the velocity magnitude among cuttings is evaluated with the possibility of determining the percentile of cuttings in a certain range of velocity magnitude values (Figure 4).

- *Elevation/Azimuth dispersion angles*, these two metrics complete the minimum set of information required to characterize the granular material flow in the 3D space. To determine cuttings trajectories, the information on velocity magnitude has to be coupled with the information on the direction of the velocity vector. This information is provided through elevation and azimuth angles, enabling a full 3D spatial characterization of the granular material flow. Since the granular material flow has a certain dispersion, as shown by Figure 3, the spatial dispersion angle is also included into the definition of these two metrics. Again, since the granular material flow is made of a number of cuttings, the statistical distribution of the spatial dispersion angles among cuttings is evaluated with the possibility of determining the percentile of cuttings in a certain range of dispersion angle values (Figure 5 and Figure 6).

The set of metrics is conceived to characterize both the simulated and the experimental granular material flow in order to get the same data products/analysis methods resulting in apples-to-apples comparison and ease of validation.

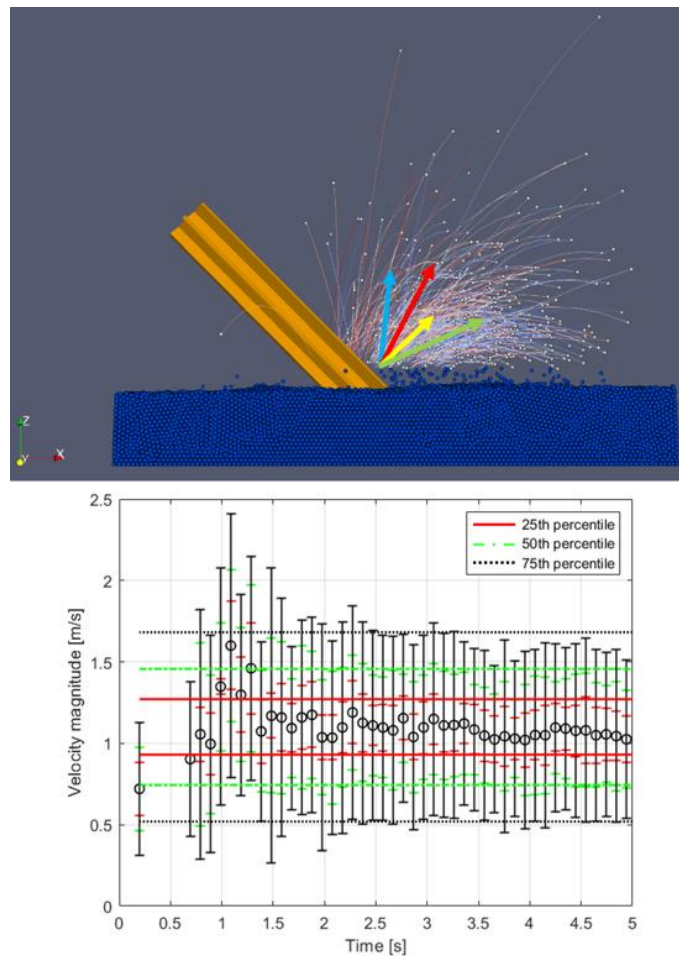

Figure 4. Velocity magnitude metric. Top: side view of DEM-simulated granular material flow with indication of velocity vectors. Bottom: plot of velocity magnitude distribution, including indication of the percentile of cuttings in a certain range of velocity magnitude values.

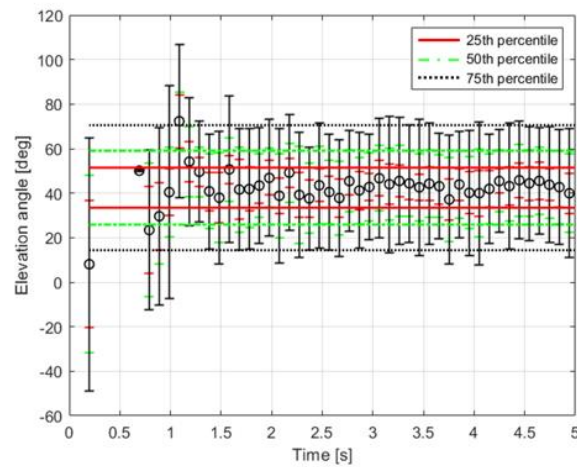
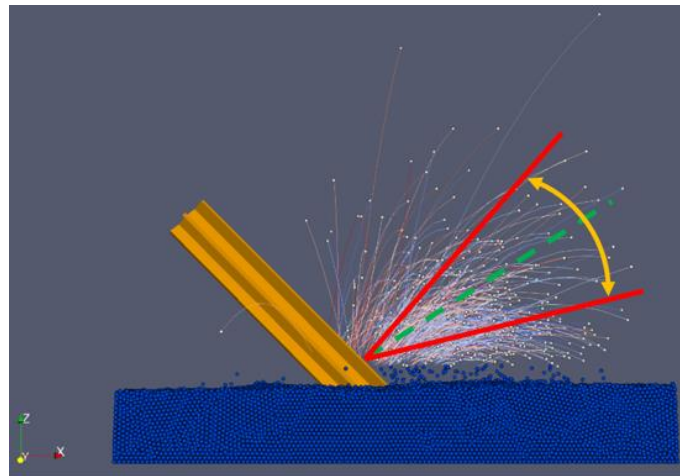

Figure 5. Elevation dispersion angle metric. Top: side view of DEM-simulated granular material flow with indication of elevation dispersion angle. Bottom: plot of elevation dispersion angle distribution, including indication of the percentile of cuttings in a certain range of elevation dispersion angle values.

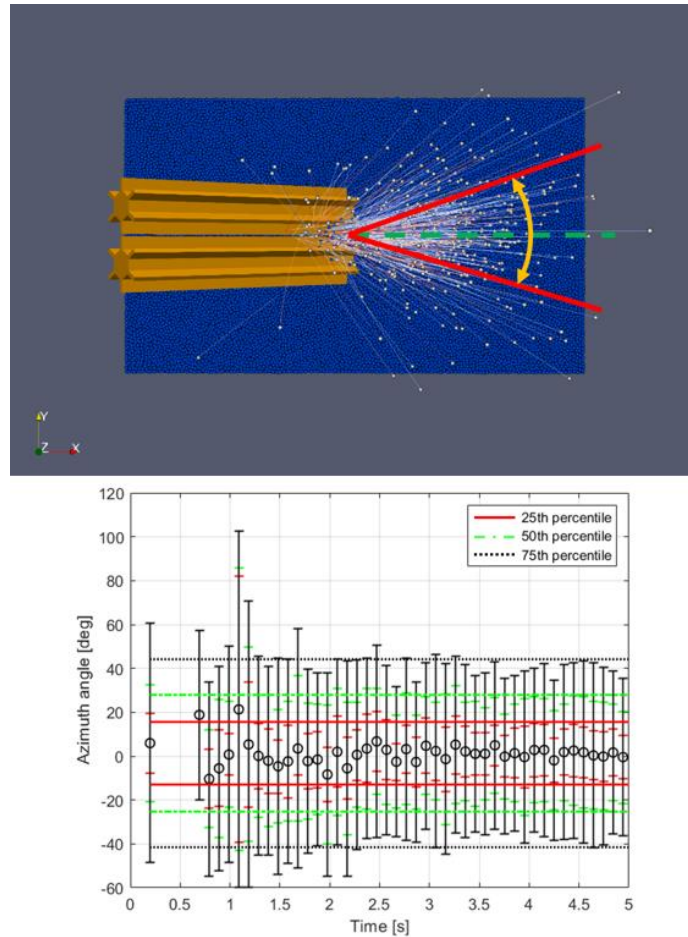

Figure 6. Azimuth dispersion angle metric. Top: side view of DEM-simulated granular material flow with indication of azimuth dispersion angle. Bottom: plot of azimuth dispersion angle distribution, including indication of the percentile of cuttings in a certain range of azimuth dispersion angle values.

5. DEM MODEL VALIDATION PROCESS

The process to develop and validate the DEM simulation model follows the steps below.

1. *Sensitivity analysis*, to identify most sensitive simulation model parameters.
2. *Measurement*, to measure most sensitive simulation model parameters. Such measured values are directly input into the simulation model. Determination of values for less sensitive simulation model parameters is based on convenience.
3. *Validation*, to validate the simulation model via experimental testing.

5.1 SENSITIVITY ANALYSIS OF DEM SIMULATION MODEL PARAMETERS

Table 1 shows the parameters of DEM simulation model grouped by category. Paired parameters characterize the interaction by pairs, according to the following: *pt* defines particle-tool interaction parameters, while *pp* defines particle-particle interaction parameters.

Table 1. DEM simulation model parameters.

Sampling tool	Particle	Paired	Common
Young's modulus	Young's modulus	<i>pt</i> coefficient of static friction	Gravity acceleration
Poisson's ratio	Poisson's ratio	<i>pp</i> coefficient of static friction	
	Density	<i>pt</i> coefficient of restitution	
	Size distribution	<i>pp</i> coefficient of restitution	
	Shape/Shape distribution	<i>pt</i> coefficient of rolling friction	
		<i>pp</i> coefficient of rolling friction	

MBD simulation model requires defining the geometry of the Dual-Rasp sampling tool (Figure 7), while its motion is prescribed according to the following:

- *Vertical straight motion velocity: 2 mm/s*
- *Max vertical straight motion displacement: 10 mm*
- *Cutters' rotational motion velocity: 2000 RPM*

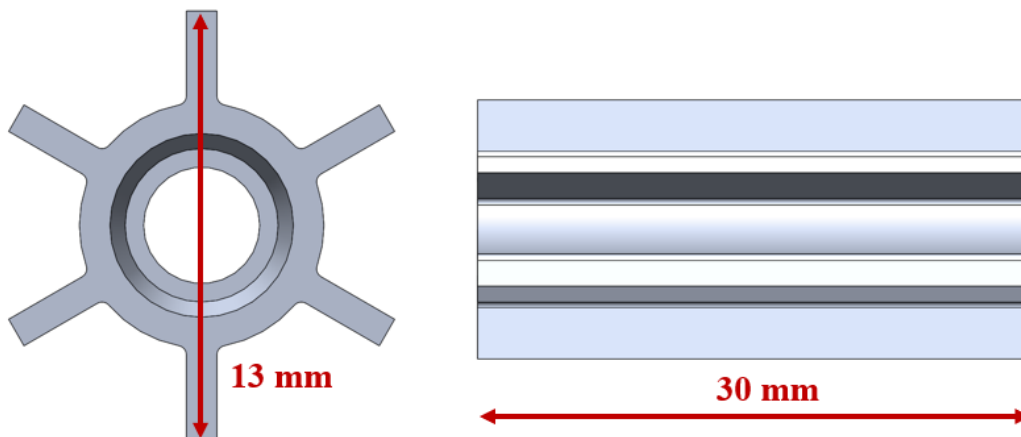

Figure 7. Front view (left) and side view (right) of the cutter of Dual-Rasp CAD model.

The sensitivity analysis performed had the purpose of reducing the dimensionality of DEM simulation model in order to determine the most sensitive parameters characterizing the granular material flow. As a result, the following parameters were considered constant during the whole analysis:

- *Sampling tool material*: Al 6061-T6
- *Gravity acceleration*: 1g
- *Particle size/shape distribution*: monodisperse 1mm-diameter spheres

DEM simulation model parameters subject to sensitivity analysis are the following:

- Particle's Young's modulus.
- Particle's Poisson's ratio.
- Particle's density.
- *pt* coefficient of static friction.
- *pp* coefficient of static friction.
- *pt* coefficient of restitution.
- *pp* coefficient of restitution.
- *pt* coefficient of rolling friction.
- *pp* coefficient of rolling friction.

DEM simulations were performed by varying those parameters in a pre-defined range and their influence on metrics was evaluated. Results are shown in Table 2.

Particle-tool coefficient of static friction and particle-tool coefficient of restitution were identified as the most sensitive DEM simulation model parameters influencing the granular material flow.

Table 2. Results of sensitivity analysis.

		Metrics		
		<i>Velocity magnitude</i>	<i>Azimuth dispersion angle</i>	<i>Elevation dispersion angle</i>
Parameters	Particle Young's Modulus	0.50	0.42	0.42
	Particle Poisson's ratio	0.33	0.25	0.25
	Particle density	0.33	0.25	0.25
	Particle-particle coeff. static friction	0.50	0.42	0.42
	Particle-particle coeff. restitution	0.50	0.42	0.42
	Particle-particle coeff. rolling friction	0.33	0.25	0.25
	Particle-tool coeff. static friction	0.92	0.75	0.75
	Particle-tool coeff. restitution	1.00	0.75	0.75
	Particle-tool coeff. rolling friction	0.42	0.42	0.42

5.2 MEASUREMENT OF DEM SIMULATION MODEL PARAMETERS

Most sensitive DEM simulation model parameters influencing the granular material flow were directly measured via independent tests performed by using custom designed apparatus.

For validation purposes, monodisperse 1mm-diameter spheres made of zirconia were selected for apples-to-apples comparison between DEM simulation model and experimental testing.

The particle-tool coefficient of static friction was measured by performing an inclined plane test. The apparatus designed and built for this purpose is shown by Figure 8. The *linear actuator* simply supports the *tool plate* at one of its ends and gently lift it for inclining the plate. The *inclinometer* measures the inclination of the *tool plate*. The *tool plate* is made of the same material of the Dual-Rasp cutters (i.e. Al 6061-T6) that are going to be used for performing the experimental validation test. The *particle plate* is placed on top of the *tool plate* and freely slides down the slope when the *tool plate* is inclined. The *particle plate* has three zirconia particles glued on its bottom face, which is placed face down on *tool plate*. In this way, the particles directly touch the *tool plate*, letting the static friction between them acting during the test.

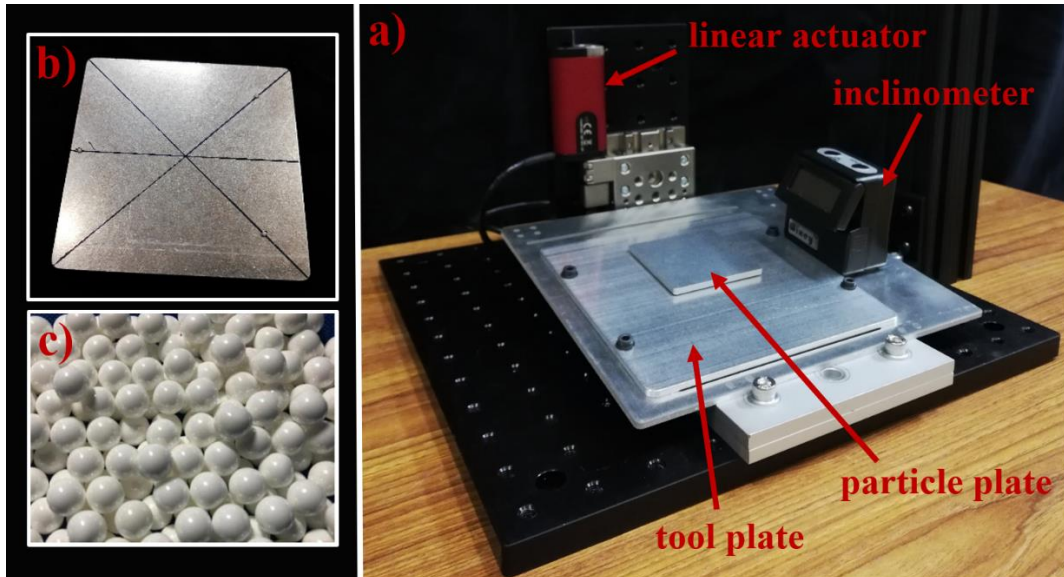

Figure 8. Inclined plane testbed (a). Detail of particle plate's bottom face with three particles glued on it (b). Zirconia particles (c).

Particle-tool coefficient of static friction μ_{pt} was evaluated from measurement of the *tool plate* inclination θ at *particle plate* incipient motion, according to classical mechanics

$$\mu_{pt} = \tan \theta$$

A value of 0.154 ± 0.003 was found for coefficient of static friction between zirconia particles and Al 6061-T6.

The particle-tool coefficient of restitution was measured by performing a particle drop test. The apparatus designed and built for this purpose is shown by Figure 9. The *drop*

tower drops one particle at the time that hits the *tool plate* and bounces back. The collision between particle and *tool plate* is recorded by using a high-speed camera. Particle-tool coefficient of restitution e_{pt} was evaluated from measurement of particles' vertical velocity right after impact v' and right before impact v , according to Mangwandia et al. (2007).

$$e_{pt} = \frac{v'}{v}$$

Particle's velocity was obtained by using a tracking software to post-process the high-speed recording.

A preliminary value of 0.65 ± 0.05 was found for coefficient of restitution between zirconia particles and Al 6061-T6.

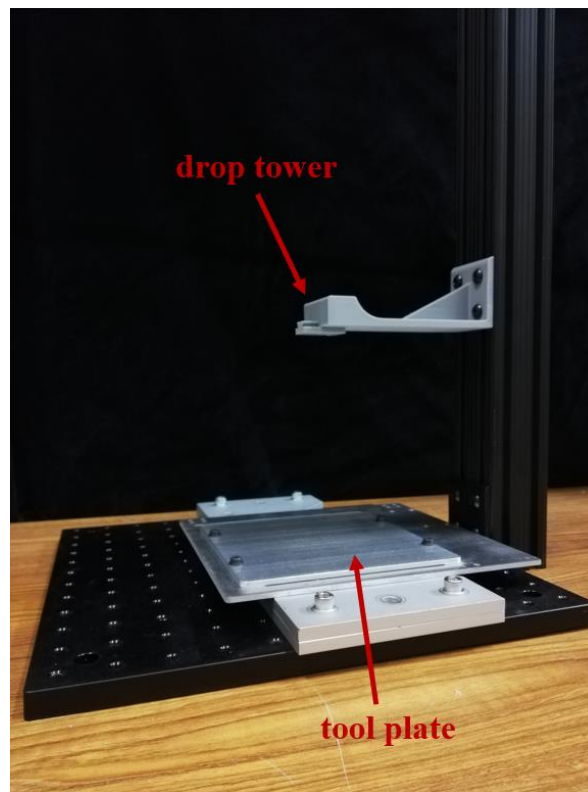

Figure 9. Drop test testbed.

6. FUTURE WORK

An experimental test campaign of the sampling operation is planned to be conducted in a custom designed vacuum chamber and recorded by using high-speed cameras. The goal is validating the DEM simulation model in a 1g environment by removing the effect of the atmospheric drag. An in-house-developed particle tracker code (Figure 10) was developed to take in input the high-speed recording and characterize the experimental granular material flow by using the same metrics used for characterizing the simulated granular material flow. This will provide an apples-to-apples comparison between DEM model and experimental testing.

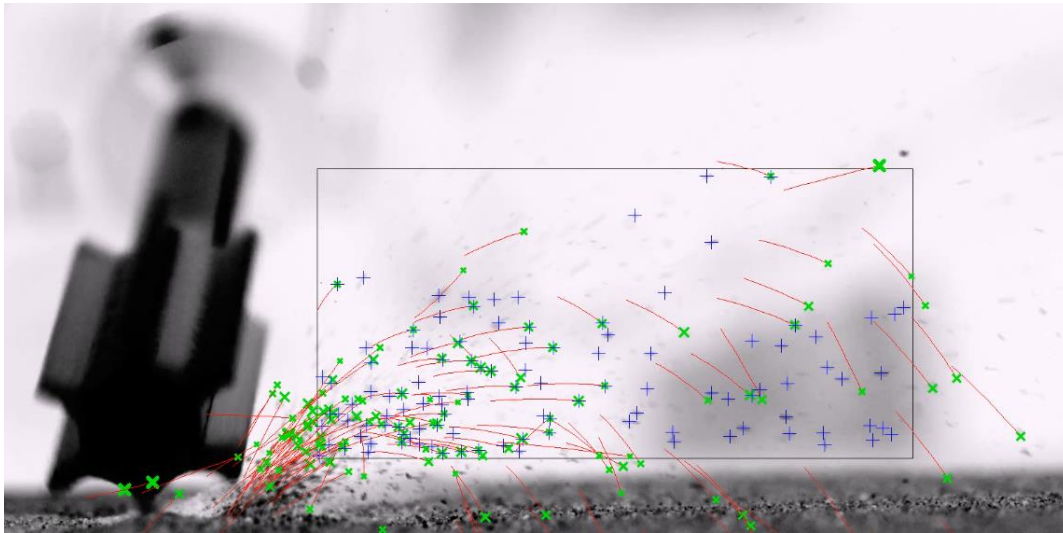

Figure 10. Frame of a high-speed recording of a single cutter of the Dual-rasp sampling tool in action. An in-house-developed particle tracker code is going to be used for validating the DEM simulation model by apples-to-apples comparison with the experimental testing.

7. CONCLUSIONS

This paper presented the analysis of tool-soil interaction and resulting material flow generated by a novel sampling system for Enceladus surface acquisition, namely the Dual-Rasp. The research scope was on modeling sample collection by using DEM in order to understand how sample collection via momentum transfer works with the aim of supporting the sampling system design by making predictions on how it might work in the Enceladus environment.

For dealing with this uncommon problem about granular matter dynamics, a DEM simulation model was developed for characterizing the granular flow generated by the Dual-Rasp, and a systematic approach was presented for validating such a model. A set of metrics was developed to characterize the granular material flow in terms of spatial dispersion and velocity distribution, while a sensitivity analysis was conducted to determine the most sensitive model parameters. Such parameters were directly measured via independent tests performed by using custom designed apparatus and input into the simulation model. An experimental test campaign is expected to be conducted in a vacuum chamber with the aim of validating the DEM simulation model in a 1g environment without the effect of the atmospheric drag. Future work will include an experimental test campaign performed on a parabolic flight to reproduce a low-g environment with the aim of validating the DEM model prediction for a low-g environment similar to the one found on Enceladus.

8. AKNOLEDGEMENTS

The research was carried out at the Jet Propulsion Laboratory (JPL), California Institute of Technology, under a contract with the National Aeronautics and Space

Administration (NASA). Special thanks go to JPL folks Michael Hans, Joshua Krohn, Mircea Badescu, Alex Brinkman and Tyler Okamoto for supporting the research activity.

9. REFERENCES

- Ai, J., Chen, J. F. J., Rotter, M., Ooi, J. Y. (2011), Assessment of rolling resistance models in discrete element simulations, *Powder Technology*, 206(3), 269–282.
- Backes, P., Moreland, S., Badescu, M., Riccobono, D., Brinkman, A., Choukroun, M., Molaro, J., Aggerwal, R., Newbold, T., Ahmad, A., Ubellacker, S. (2020), The Dual-Rasp Sampling System for an Enceladus Lander, *IEEE Aerospace Conference*, Big Sky (Montana, USA).
- Brilliantov, N. V., Spahn, F., Hertzsch, J. M., Pöschel, T. (1996), Model for collisions in granular gases, *Physical Review E*, 53(5), 5382-5392.
- CFDEM®project, LIGGGHTS® Open Source Discrete Element Method Particle Simulation Code, <<https://www.cfdem.com/liggghtsr-open-source-discrete-element-method-particle-simulation-code>> (Nov. 18, 2019).
- Di Renzo, A. and Di Maio, F. P. (2004), Comparison of contact-force models for the simulation of collisions in DEM-based granular flow codes, *Chemical Engineering Science*, 59(3), 525–541. Note: Wrong definition of G_{eq} in this paper, corrected in Di Renzo and Di Maio (2005).
- Di Renzo, A. and Di Maio, F. P. (2005), An improved integral non-linear model for the contact of particles in distinct element simulations, *Chemical Engineering Science*, 60(5), 1303–1312.
- Mangwandi, C., Cheonga, Y., Adamsb, M., Hounslowa, M., and Samana, A. (2007), The coefficient of restitution of different representative types of granules, *Chemical Engineering Science*, 62(1-2), 437–450.
- Molaro, J. L., Choukroun, M., Phillips, C. B., Phelps, E. S., Hodyss, R., Mitchell, K. L., Lora, J. M., Meirion-Griffith, G. (2019), The Microstructural Evolution of Water Ice in the Solar System Through Sintering, *Journal of Geophysical Review: Planets*, 124(2), 243-277.
- Mukherjee, R. et al. (2014), M3tk: A Robot Mobility and Manipulation Modeling Toolkit, *ASME 2014 International Design Engineering Technical Conferences and Computers and Information in Engineering Conference*, Buffalo (New York, USA).
- Schwager, T., Pöschel, T. (2007), Coefficient of restitution and linear dashpot model revisited, *Granular Matter*, 9, 465-469.
- Silbert, L. E., Ertas, D., Grest, G. S., Halsey, T. C., Levine, D., Plimpton, S. J. (2001), Granular flow down an inclined plane: Bagnold scaling and rheology, *Physical Review E*, 64, 051302-1/051302-14.
- Southworth, B. S., Kempf, S., Spitale, J. (2019), Surface deposition of the Enceladus plume and the zenith angle of emissions, *Icarus*, 319, 33-42.
- Zhang, H. P., Makse, H. A. (2005), Jamming transition in emulsions and granular materials, *Physical Review E*, 72, 011301-1/011301-12.