

VTT Technical Research Centre of Finland

Research report on SASUNE research programme project 3SMR (Small, Safe and Sustainable Modular Reactor)

Hillberg, Seppo; Ilvonen, Mikko; Jäppinen, Tarja; Kolehmainen, Jarno; Kurki, Joonas; Leppänen, Jaakko; Liinasuo, Marja; Nevasmaa, Pekka; Penttilä, Sami; Takasuo, Eveliina; Toivonen, Aki; Tuominen, Riku

Published: 19/12/2016

Document Version
Publisher's final version

[Link to publication](#)

Please cite the original version:

Hillberg, S., Ilvonen, M., Jäppinen, T., Kolehmainen, J., Kurki, J., Leppänen, J., Liinasuo, M., Nevasmaa, P., Penttilä, S., Takasuo, E., Toivonen, A., & Tuominen, R. (2016). *Research report on SASUNE research programme project 3SMR (Small, Safe and Sustainable Modular Reactor)*. VTT Technical Research Centre of Finland. VTT Research Report No. VTT-R-05548-16



VTT
<http://www.vtt.fi>
P.O. box 1000FI-02044 VTT
Finland

By using VTT's Research Information Portal you are bound by the following Terms & Conditions.

I have read and I understand the following statement:

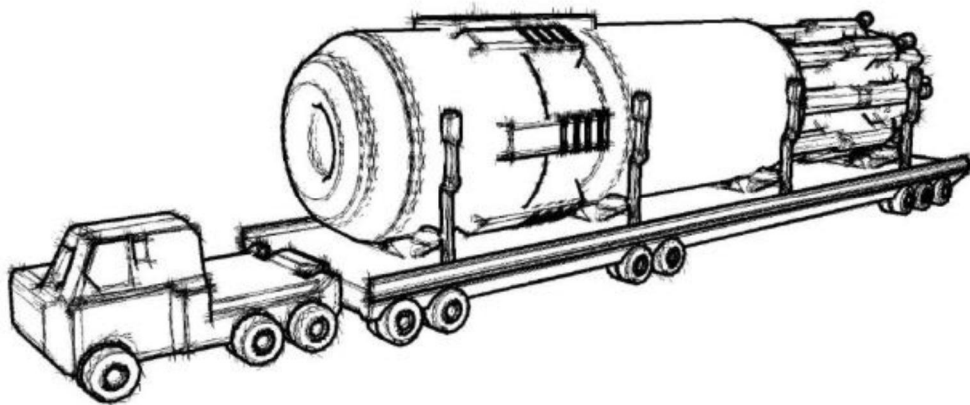
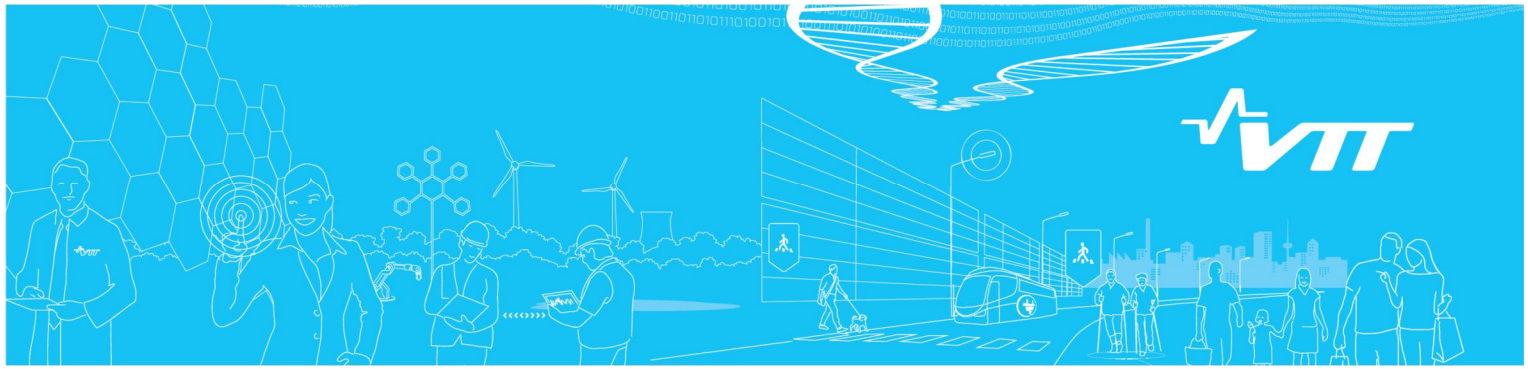

This document is protected by copyright and other intellectual property rights, and duplication or sale of all or part of any of this document is not permitted, except duplication for research use or educational purposes in electronic or print form. You must obtain permission for any other use. Electronic or print copies may not be offered for sale.



Research report on SASUNE research programme project 3SMR (Small, Safe and Sustainable Modular Reactor)

Authors: S. Hillberg, M. Ilvonen, T. Jäppinen, J. Kolehmainen, J. Kurki, J. Leppänen, M. Liinasuo, P. Nevasmaa, S. Penttilä, E. Takasuo, A. Toivonen, R. Tuominen

Confidentiality: Public

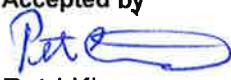
Report's title	
Research report on SASUNE research programme project "Safe, Sustainable and Small Modular Reactor" (3SMR)	
Customer, contact person, address	Order reference
VTT's SASUNE research programme	109990
Project name	Project number/Short name
Small, Safe and Sustainable Modular Reactor	109990 / 3SMR
Author(s)	Pages
Seppo Hillberg, Mikko Ilvonen, Tarja Jäppinen, Jarno Kolehmainen, Joonas Kurki, Jaakko Leppänen, Marja Liinasuo, Pekka Nevasmaa, Sami Penttilä, Eveliina Takasuo, Aki Toivonen, Riku Tuominen	70
Keywords	Report identification code
small modular reactor, safety, licensing, know-how	VTT-R-05548-16
Summary	
<p>Small modular reactors (SMRs) are a very attractive option in the near future due to many advantages compared to present day large power plants. One of the major advantages are the improved safety features which are seen as the most important aspect of the innovative reactor designs especially after Fukushima accident in 2011. Another important point of view is the reduced capital cost through design simplification/smaller size in current economic situation. Besides electricity generation, also a wide variety of other applications are available in SMR concepts including process heat production, desalination and hydrogen generation. In addition, SMRs are a potential option for developing countries where grid capacity is not sufficient for large NPPs.</p> <p>For assessing SMR design attractiveness in national and international level, there is a need to have a closer look at the licensing requirements and related safety issues. This project describes some of the safety features of selected SMR designs, as well as their development status in national and international level, which are discussed in terms of selected disciplines available at VTT. Further, the question is answered about the possible know-how needed at VTT in order to better assist our potential customers in the future.</p> <p>Based on the literature, it is shown that SMRs are seen as a very promising reactor design in many countries world-wide. In this work, we were focusing mainly on LWR type SMRs due to their proven technology and knowledge internationally. Many safety features still need to be studied more closely in order to assess the potential difficulties in licensing an SMR plant in Finland, and possibly suggest appropriate changes in the licensing procedures. The extent of passive safety systems and especially the feature of the control room according to which it is possible to control and monitor several reactors at the same time necessitates the new design of operator work and, consequently, new design of many human factors engineering related activities. There are also some technical challenges that need to be evaluated and tested before deployment of SMRs. This includes especially challenges related to functionality of passive safety systems, evaluation of possible off-site consequences, control room design as well as manufacturing and non-destructive testing of reactor components. In this report, some suggestions are also made on future directions of SMR research at VTT as well as an internal strategy how to follow international development on this topic.</p>	
Confidentiality	Public
Espoo 19.12.2016	
Written by	Reviewed by
	
Sami Penttilä Research Scientist	Ville Tulkki Senior Scientist
	Accepted by
	
	Petri Kinnunen, Research Manager

VTT's contact address

Vuorimiehentie 3, 02044 VTT

Distribution (customer and VTT)

SASUNE stakeholders, VTT BA25 RM, BDMS and KAMs, VTT archives

The use of the name of VTT Technical Research Centre of Finland Ltd in advertising or publishing of a part of this report is only permissible with written authorisation from VTT Technical Research Centre of Finland Ltd.

Preface

3SMR is a one year project funded by SASUNE research programme. In the project, the focus is on selected LWR type SMR designs and their technical feasibility in national and international perspective. The project is divided into 6 different subtasks:

1. Licensing,
2. passive safety systems
3. reactor physics,
4. severe accidents,
5. material challenges and
6. human factors.

This report has been prepared by the scientists involved in the project.

Espoo, 19.12.2016

Authors

Contents

Preface.....	3
1. Introduction.....	5
2. Goal.....	7
3. What are SMRs and why they are needed in the future	7
4. Short overview on selected SMR concepts	10
5. Results.....	13
5.1 Licensing	13
5.1.1 Finnish regulatory guides on nuclear safety	14
5.2 Passive safety systems.....	16
5.2.1 Passive safety systems and features in selected SMRs.....	16
5.2.2 Applications and possible problems of natural circulation.....	20
5.2.2.1 Introduction to natural circulation.....	20
5.2.2.2 Applications of natural circulation in nuclear power plants.....	22
5.2.2.3 Physical phenomena of natural circulation.....	24
5.2.2.4 Potential issues in natural circulation.....	28
5.2.2.5 Role of experiments and CFD in natural circulation problems.....	32
5.2.2.6 CFD in analysis and design of natural circulation	33
5.3 Reactor physics	35
5.3.1 Serpent and COSY models.....	36
5.3.2 Coupled calculation results	37
5.4 Severe accidents	38
5.4.1 The main differences from large reactors.....	41
5.4.2 Design and phenomenon-specific considerations	43
5.5 Material challenges.....	47
5.5.1 Materials, welds and NDE in selected SMRs	47
5.6 Human factors	51
6. VTT's near-term strategy on SMR R&D	54
6.1 International activities	55
6.1.1 Euratom NFRP-4	55
6.1.2 Russian SMRs	55
6.1.3 Halden MTO programme	56
6.1.4 The British SMR competition.....	56
6.1.5 IAEA activities in SMRs.....	56
6.2 VTT competence in CFD assessments.....	57
6.3 SMR related reactor physics research at VTT.....	57
6.4 SMR emergency planning zones (EPZs)	58
6.5 Advanced manufacturing & NDE of reactor components at VTT.....	58
6.6 Human factors considerations.....	59
6.7 VTT 'Lighthouses' and SMRs.....	59
6.8 Possible future opportunities for VTT.....	60
7. Conclusions	61
8. Summary	62
References.....	64

1. Introduction

Looking at the historical development, from 1950s to mid-1970s commercial nuclear power plants were in the size of a couple hundreds of megawatts demonstrating the commercial viability of nuclear energy. However, their unit capital costs (€/kW) were substantially higher compared to similar fossil fired plants due to increased plant cost. Also the adding of many new safety systems increased the capital costs and due to this it became necessary to also increase the output power of the plant. Following to this, the plant size increased rapidly from a couple of hundred of megawatts to present day LWRs with output power up to approximately 1700 MWe. This affected e.g. the number of manufacturers capable of producing such large components needed in the plant and thus costs increased enormously as well as the time from beginning of construction to initiating power production exceeded a decade [Carelli, 2014].

Many of the general features of SMRs (Small Modular Reactor) have a long history. As mentioned above, the size of reactor units has grown enormously in the course of time but at the same time there have been many hundreds of smaller power reactors built e.g. for naval use (up to 190 MW thermal) and as neutron sources, leading to expertise in the engineering of small power units [World Nuclear Association, 2016]. In general, the modern SMRs for power generation have many features in common with earlier designs like size (< 300 MW), relatively simple design, economy of series production largely in factories, short construction times, and reduced siting costs. Most designs include high level of passive or inherent safety features. Some designs are also designed to be placed below ground level which gives an increased resistance to impact-related threats [Subki and Reitsma, 2014; World Nuclear Association, 2016]. Presently the main questions are how to tackle licensing issues and economic challenges in order to bring SMRs as an option for competitive CO₂-free technology. SMRs must realize the economy of serial production (instead of economy of scale) to be profitable. The above mentioned arguments are in a key role when assessing the attractiveness of SMRs in fighting against climate change together with renewables as well as large NPPs.

The World Nuclear Association [World Nuclear Association, 2016] lists the features of an SMR as following:

- Small power (< 300 MW) and compact architecture and usually (at least for nuclear steam supply system and associated safety systems) employment of passive concepts. Therefore there is less reliance on active safety systems and additional pumps, as well as AC power for accident mitigation.
- The compact architecture enables modularity of fabrication (in-factory), which can also facilitate implementation of higher quality standards.
- Smaller reactors and lower power leading to reduction of the radioactive source term as well as smaller radioactive inventory in a reactor.
- Potential for sub-grade (underground or underwater) location of the reactor unit providing more protection from natural (e.g. seismic or tsunami according to the location) or man-made (e.g. aircraft impact) hazards.
- The modular design and small size lends itself to having multiple units on the same site.
- Lower requirement for access to cooling water – therefore suitable for remote regions and for specific applications such as mining or desalination.
- Ability to remove reactor module or in-situ decommissioning at the end of the lifetime.

According to IAEA [Subki and Reitsma, 2014] the size of the current worldwide SMR fleet can be estimated as follows: 131 SMR units are in operation in 26 IAEA member states with a capacity of 59 GWe and many SMRs are under construction e.g. in Argentina, China, India, Pakistan, the Russian Federation and Slovakia. R&D on SMR is being carried out world-wide on approximately 45 advanced SMR concepts and they are under development for all principal reactor types: light water reactors (LWRs), heavy water reactors (HWRs), gas cooled reactors (GCRs), liquid metal cooled reactors (LMCRs) and molten salt reactors (MSRs). Nowadays several countries are considering SMRs not only for electricity generation but also for other uses such as district heating, desalination and hydrogen production, together with other applications of industrial heat.

Currently, dozens of plant vendors have their SMR designs in various stages of the design, licensing or construction process. In many NPP projects the main concern to overcome is minimizing economic risk and to make a product to market within a promised timescale. This problem has been recognized in many ongoing NPP projects worldwide. As a leading technology, LWRs are seen to represent the lowest technical risks. There are many potential LWR type SMRs viable for the market, see Table 1, e.g. NuScale supported by US Department of Energy (DOE), as well as Westinghouse, having a feasible design. mPower didn't secure the required industry funding according to deal with DOE in 2012 - 2013 and already fell out in a race with other concepts in USA [Söderholm, 2015]. Other potential options are from Korea and Argentina, i.e. SMART and CAREM-25, respectively. In addition, the Russian barge-mounted KLT40S is under construction and intended to be deployed by 2019. It is also possible that molten salt, gas cooled, thorium and other forms of reactor types may have a long term future. However, in many countries the technological risk of LWR type SMRs is seen to be much lower compared to GenIV SMRs at the moment.

There is still a gap in knowledge between the designs and technologies of LWR type SMRs and commercializing these technologies. The deployment of SMRs might be an option when considering replacement of the ageing nuclear fleet (e.g. Loviisa NPPs) or coal-fired power generation in operation. However, careful assessment of this design needs to be performed and in many cases complete R&D efforts are required before licensing of new SMRs. One reason is that no new-build plant is acceptable without a feasible strategy for managing severe accidents (STUK YVL 2.2, old, and B.3 Deterministic Safety Analyses & B.6 Containment, new) in Finland. This is not the case in all countries, in many of which it is simply stated that the possibility of a severe accident is low enough to be ignored from the viewpoint of engineering.

Table 1. Status of some advanced PWR type SMR projects in the world [Lokhov and Sozoniuk, 2016].

SMR	Electric output		Plant configuration	Licensing status
	Unit(s)	MWe(net)		
CAREM-25 (a prototype) Argentina	1	27	Single module	Licensed Under construction
KLT-40S (w/desal) Russia	2	2 x 35	Twin-unit barge-mounted	Licensed Under construction, completion in 2019
SMART (w/desal) Korea	1	90	Single module	Licensed
mPower United States	2	2 x 180	Multi-module	Pre-application review
NuScale United States	12	12 x 45	Multi-module	Pre-application review
Holtec HI-SMUR United States	1	160	Single module	Pre-application review
Westinghouse SMR United Kingdom	1	225	Single module	Pre-application review

2. Goal

Today there are numerous different SMR concepts originating from around the world. Most of them are on early stages of design, some are developed for near-term deployment or are under construction and a few designs are already under operation. This report focuses on LWR type SMRs (PWR and BWR). When looking at only PWR type SMRs there is around 12 relevant designs available [Subki and Reitsma, 2016]. All the drivers in favour of SMR economics are currently theoretical and need to be demonstrated to work in practice meaning that a complete engineering design is needed before full engineering cost estimate can be made. SMR design applications will need to concentrate in particular on passive safety systems, licensing requirements and also design specific material solutions and inspection methods are needed. The objective of this project is to identify open issues of potential SMR designs and analyse which possibilities VTT could have assisting customers concerning SMRs nationally and internationally. This project is focusing on the following topics:

1. Licensing,
2. passive safety systems,
3. reactor physics,
4. severe accidents,
5. material challenges and
6. human factors.

The goal of the proposed project is to:

- identify the main characteristics of chosen LWR type SMRs,
- identify the needs for design and licensing of SMRs,
- identify open issues in SMR research,
- make an analysis on which competences VTT has and would need in such SMR work,
- identify potential customers for SMR use and
- analyse which possibilities VTT could have assisting customers concerning SMRs nationally and internationally.

Based on this work recommendations on the following steps in the R&D on SMRs in national level will be suggested.

3. What are SMRs and why they are needed in the future

SMRs offer a viable alternative to large present-day LWRs. SMRs fulfill many of the needs and aspirations related to flexibility and manageable capital investments in the present economic situation. SMRs are also designed to be especially safe and many SMR designs include numerous passive safety features. SMRs can be seen attractive also in countries where electricity grid is not capable for large reactors and where it is difficult to provide power in distant regions. There are a lot of potential customers for SMRs. China is aiming to have 110 operational nuclear reactors by 2030 for a capacity of 88 GW meaning 6 to 8 nuclear

reactors every year from 2016 for the next five years [*Nuclear Energy Insider, 2015*]. NuScale is aiming to build its first SMR plant in the US by 2023, and believes it could build its first UK plant by the mid-2020s. In addition, the construction of CAREM in Argentina, the first natural circulation integral pressurized water reactor, is on schedule with first criticality aimed by 2018 [*Kollar, 2015*].

According to IAEA [*Subki and Reitsma, 2014*] there are many different SMR concepts under development from around the world. They can be divided mainly to Gen III/III+ and GenIV designs. LWRs are the most common nuclear designs in the world: there are around 437 reactors in operation and of them 357 are LWRs. Of these LWRs 273 are PWRs. This means that of nuclear reactors the most experience has been gathered with PWR technology. LWR SMRs are seen to include a relatively low technological risk but the advanced designs can be smaller, simpler and with longer operation before refuelling [*Lokhov and Sozoniuk, 2016; Kollar, 2015*]. However, the SMR designs which represent GenIV of nuclear energy may bring new opportunities especially regarding the usage and recycling of nuclear fuel. When considering the situation in Finland, GenIII type of SMR is more likely to be deployed in commercial use in near term. However, a lot of research and development efforts are needed before that.

Electricity generation is the main purpose of the reactor in many cases, but also other uses have been found. Some examples are water desalination, district heating, high temperature process heat for process industry, and hydrogen production. Some of the SMR concepts are designed to be able to perform daily load following. Features and possibilities like desalination and suitability for low-capacity electricity grids are making SMRs a very attractive option also for developing countries.

More and more attention is given to smaller scale plants which could offer an alternative to huge NPP plants. It is assumed that smaller plants can avoid the pitfalls of larger ones. In some designs, all safety-critical equipment including the reactor and the fuel vessels are planned to be located underground, thereby minimising the need for expensive physical defences. This is seen one of the major challenges e.g. in EPRs because there are more huge structures which need to be protected against aircraft crash including many safety systems [*Stacey, 2016*]. In general, it is estimated by the experts that if enough modules are built in the same factory, costs per unit can be driven down well below those of larger plants [*Stacey, 2016*]. However, first ones will cost roughly the same per unit of electricity produced by a large reactor until costs can be driven down as long as enough of them are commissioned [*Stacey, 2016*]. In more pessimistic estimates, the SMR electricity generation cost will be higher for some first units, and only reach or go below the large plant level with dozens of units.

Potential benefits of SMRs, compared with present day's typical large NPPs include the following [*Carelli, 2014; Subki and Reitsma, 2014; World Nuclear Association, 2016; Lokhov and Sozoniuk, 2014; Rowinski, 2015*]:

- Many difficulties in the commissioning of present day's NPPs derive from the rules and guidelines in force in different countries. By building many small scale and similar units, they could be licensed once, and produced serially in a factory, and then transported to the construction site in one piece.
- Shorter construction schedules due to modular structure and enhanced quality because of replication in a factory setting should unarguable produce a higher quality product. Because of the smaller investment required for one unit in the beginning, they are expected to be easier to finance.
- The requirements for lower grid capacity in developing countries since not that much electric power is produced at one location. Also due to small unit size, the

requirement for backup power plants is smaller. In some cases the SMR could operate in its own grid, separate from the country's basic distribution network.

- SMRs are able to adjust their output as demand. Load following for e.g. intermittency of renewable energy sources can be partially accomplished by the number of SMR units in power production. In some designs, the use of heat could be increased when less electricity is needed. The energy output of SMRs is well suited to existing heat and water distribution networks and thus they could offer higher potential for cogeneration, such as water desalination and district heating.
- With a smaller core radioactive inventory, the size of the EPZ (Emergency Planning Zone), currently approximately 20 km in Finland, could possibly be reduced compared with larger NPPs. Furthermore, modularity of construction and small-sized units allow easier decommissioning.
- Multi-unit configuration helps to avoid a long outage period through unit-by-unit maintenance and refuelling. In addition, there are benefits in having several identical SMR units compared to one large unit in terms of human resource management of teams involved in operation and outage management.

As mentioned earlier, SMRs are already under construction in many countries and planned to be operational around 2020 [Söderholm, 2015]. A key advantage is that they are modular so that any number of plants can easily be built, from a single reactor unit to a larger number, to suit the demands of a particular application. Furthermore, their modular nature means they will be manufactured in factories, and then transported to site in modules. This kind of series fabrication in factories is faster and cheaper, and should arguably produce a higher quality product.

The share of SMRs in nuclear new build in 2020 - 2035 was estimated by OECD/NEA in 2016 [Lokhov and Sozoniuk, 2016]. This estimate is based on two scenarios: an optimistic high-case scenario assuming successful licensing procedure and factory production and associated supply chain, and a low-case scenario in which the SMRs are expensive to build as well as to operate. In the high-case scenario, up to 21 GWe of SMRs could be deployed in 2035, Fig. 1. Based on this about 9% of the total nuclear new build in 2020-2035 could be SMRs. Report by NNL [Waddington, 2014] estimates that the size of the potential SMR market in 2035 could be as high as 65-85 GW, e.g. 15 GW in both China and the USA assuming that this technology is made cost-competitive with advanced LWRs. However, this calculation do not take into account the potential for further development of SMR technologies and regulatory frameworks that might lead to changes in the existing NPP market.

The driving mechanisms for SMRs are mainly desire to reduce the total capital costs of the projects and shorten construction schedules. In addition to this, many enhanced safety features through simplified designs support their attractiveness among advanced reactor technology spectrum.

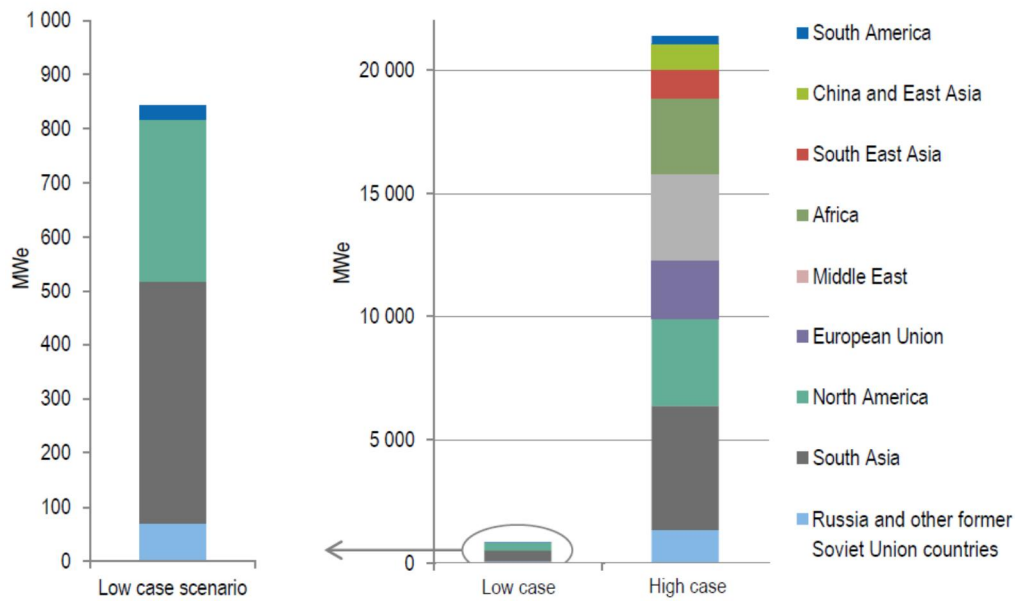

Figure 1. Estimated SMR capacity in 2035 with an optimistic high-case and low-case scenarios worldwide [Lokhov and Sozoniuk, 2016].

4. Short overview on selected SMR concepts

As discussed earlier, there are many different SMR concepts under development from around the world. They can be divided mainly to Gen III/III+ and Gen IV designs. LWRs are the most common nuclear designs in the world since there are around 437 reactors in operation and of them 357 are LWRs. This means that of nuclear reactors the most experience has been gathered with LWR and more precisely PWR technology. When considering the situation in Finland, Gen III type of SMR is more likely to be deployed in commercial use in near term based on national activities e.g. in SAFIR research programme at the moment. Due to this fact, we are focusing only on LWR type SMRs: NuScale/USA, SMART/Korea and ACP100/China.

NuScale Power Modular and Scalable Reactor is an integral pressurized water reactor (iPWR) capable of producing 45 MW of electricity or 160 MW of thermal power. An iPWR system means that the primary cooling system is integrated, i.e. the core, steam generators, the whole primary circuit coolant and control rod mechanism are located inside the reactor pressure vessel [Mazzi, 2005]. Each nuclear plant can consist of 1-12 of these modules, Fig. 2. Each of the units are housed in their own pressure containment which are submerged underwater in a stainless steel lined concrete pool. NuScale concept relies on natural circulation both in normal operation and in accident situations. The concept is being developed by NuScale Power LLC. [ARIS, 2016; Reyes, 2012] and they should submit the design certification application to the NRC by the end of 2016. The target for the design certification is 2020 and commercial operation is targeted in 2023 [ARIS, 2016].

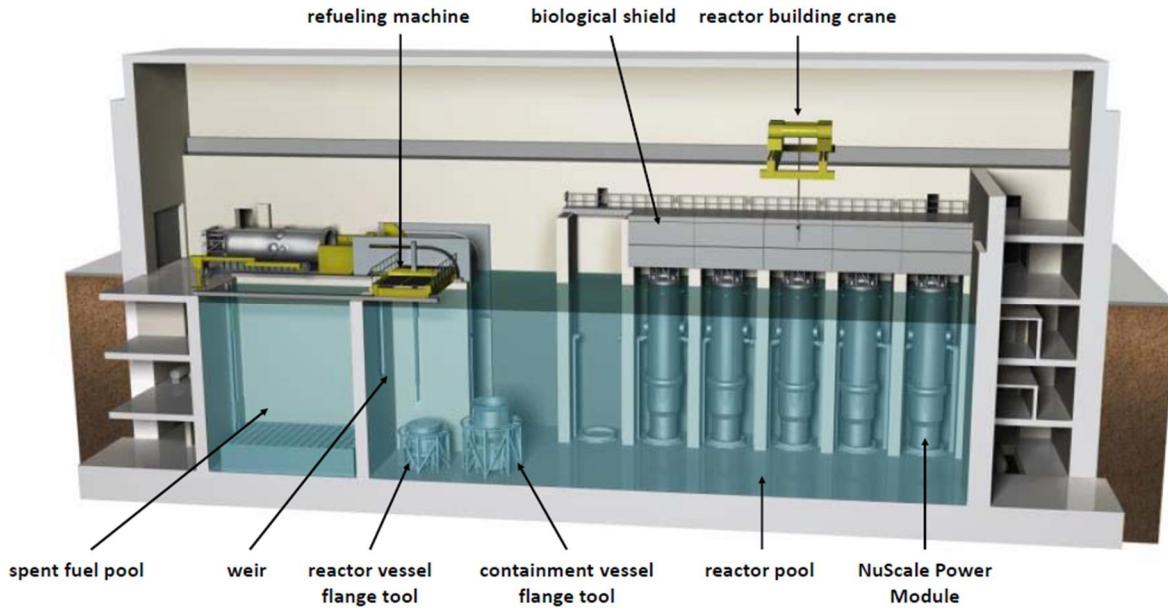

Figure 2. NuScale reactor building cross section [Surina, 2015].

SMART (System-integrated Modular Advanced Reactor), a 330 MWt advanced integral PWR, is developed by the Korea Atomic Energy Institute (KAERI) for electricity generation and seawater desalination. SMART can produce 100 MW of electricity or 90 MWe of electricity and 40000 tons of desalinated water per day. A single reactor pressure vessel contains major primary components such as a reactor core, a pressurizer, steam generators, and reactor coolant pumps, Fig. 3. SMART obtained Standard Design Approval in 2012 from the Korean nuclear regulatory authority becoming the first licenced integral reactor in the world [Chung, 2013; Kim, 2013].

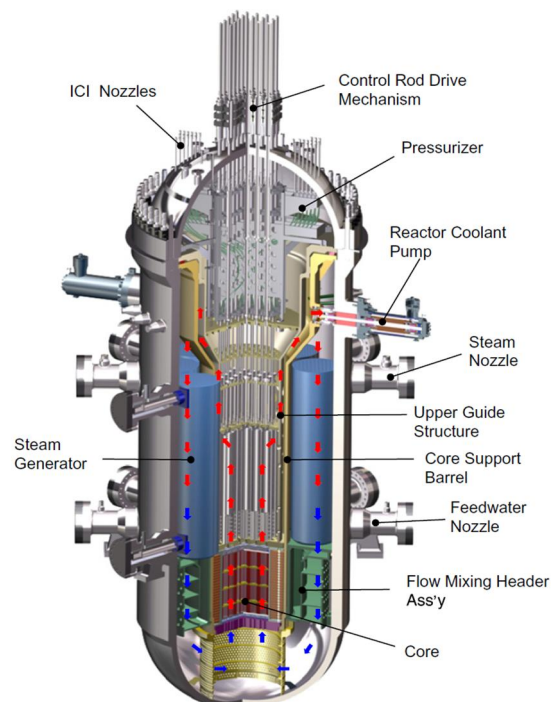

Figure 3. Layout of SMART reactor vessel [Chung, 2013].

The ACP100 has been developed mainly for the Chinese market. The ACP100+ represents a potentially attractive option e.g. for engagement for the UK in a new design programme [Waddington, 2014]. There is little information available on the ACP100+ reactor which is relevant to European market but based on what can be found it seems to be a slightly upscaled version of ACP100 SMR with increased passive safety systems. It is designed for co-generation of heat, electricity and water [Progress of SMR ACP100 Series, 2014]. Some technical aspects are compared in Table 2. Schematic diagram of the reactor module is presented in Fig. 4.

Table 2. Comparison of a few technical aspects between ACP100 and ACP100+ [Progress of SMR ACP100 Series, 2014].

	ACP100	ACP100+
Thermal power	310 MW	385 MW
Electrical power	~100 MW	~120 MW
Design life	60 years	
Refueling period	2 years	
Average coolant temperature	303 °C	305 °C
Steam generator type	once-through steam generator	
Main steam temperature	> 290 °C	
Main steam pressure	4 MPa	

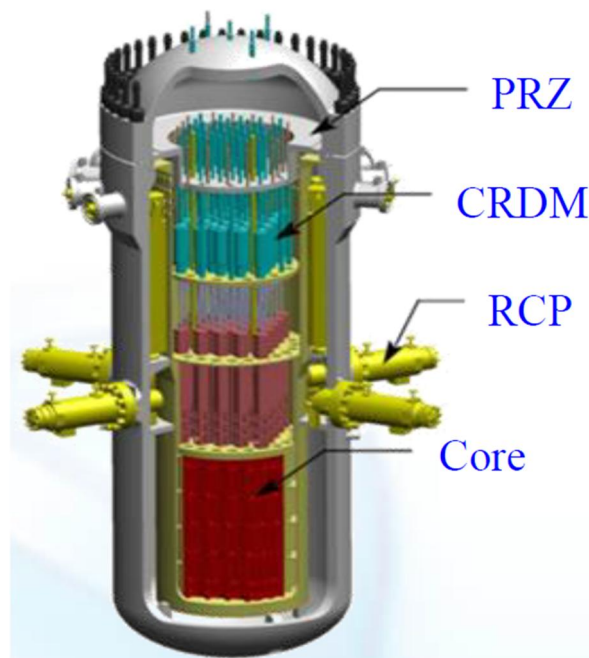

Figure 4. ACP100+ module with pressurizer (PRZ), control rod drive mechanism (CDRM) and reactor coolant pumps (RCP) [Progress of SMR ACP100 Series, 2014].

5. Results

5.1 Licensing

The Nuclear Energy Act (990/1987) describes the whole licencing process in Finland. The licencing process in Finland is a three step process shown in Fig. 5.

The first step is the decision in principle (DIP) which is a political decision of the Finnish government. The DIP has some prerequisites; preliminary safety assessment by Radiation and Nuclear Safety Authority in Finland (STUK) and environmental impact assessment (EIA) needs to be carried out also the local municipality has to give approval to the project. The DIP is ratified by the parliament of Finland.

The next step in the licensing process is the construction license (CL). Before the CL is granted by government STUK will make a statement in the application on the safety of the facility. The applicant has to provide information to STUK of the technical principles of the facility and show that Finland's requirements are met by the facility. The requirements are described in the Finnish regulatory guides on nuclear safety (YVL guides).

The final step is the operation license. In Finland the operation license is granted only for a fixed period. Detailed construction information must be attached to the application for the operation license. In STUKs safety assessment as well as the technical aspects of the build plant also the expertise of the applicants organisation is checked.

Three licensing steps

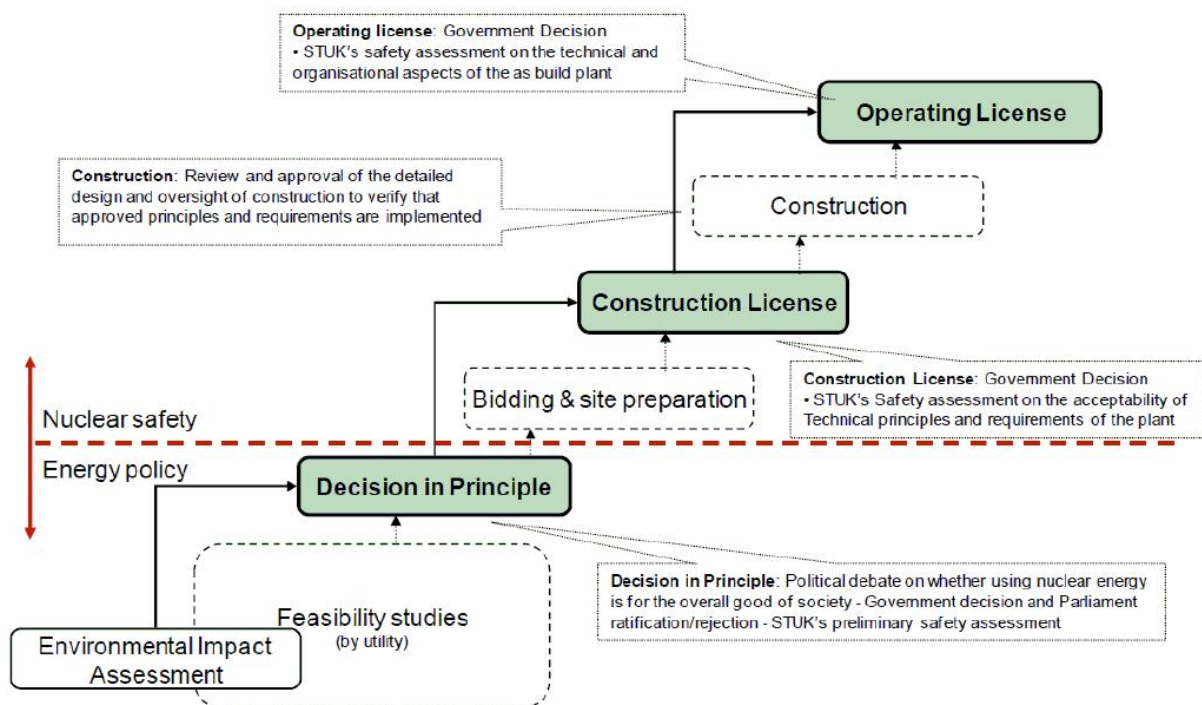

Figure 5. The licensing process in Finland [Tiippana, 2010].

The main strength of SMRs is the modularity, which the licensing process of Finland does not support. Nuclear industry especially SMRs could benefit from developing an internationally applicable "Standard Design Certificate of Module" (SDCM) that would ensure

the safety of the module design and pave a way to harmonisation of nuclear licensing internationally [Söderholm, 2013].

5.1.1 Finnish regulatory guides on nuclear safety

In Finland STUK specifies the detailed safety requirements concerning the implementation of safety level in accordance to the Nuclear Energy Act (990/1987). The Finnish regulation pyramid is shown in the Fig. 6.

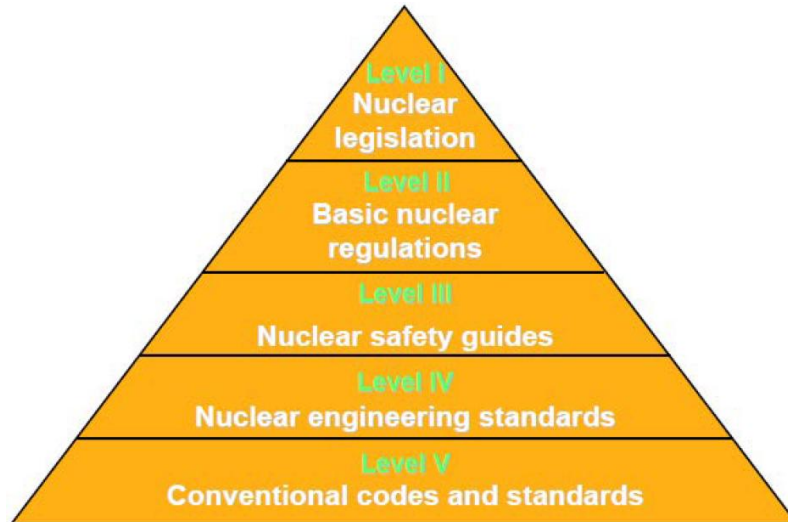

Figure 6. The structure of Finland's Nuclear regulation [Sjövall, 2010].

In the licensing point of view the Level 1 of the pyramid consists of the Nuclear Energy Act (990/1987), level 2 consists of the former Government Decrees (717/2013, 716/2013, 734/200, 736/2008) that were adopted to so called STUK regulations (Y/1/2016, Y/2/2016, Y/3/2016, Y/4/2016 and Y/5/2016) in 22.12.2015 and came into force 1.1.2016. The STUK regulations are binding regulations on technical details concerning nuclear safety principles. Regulatory guides on nuclear safety (YVL) are at the third level.

The YVL guides sets the requirements which must be fulfilled or the applicant must prove that the safety level set forth is achieved, this is stated in the section 7 r(3) of the Nuclear Energy Act. The base of the YVL guides is the defence-in-depth principle. The defence-in-depth levels according to WENRA is shown in the Fig. 7.

Levels of defence in depth	Objective	Essential means	Radiological consequences	Associated plant condition categories
Level 1	Prevention of abnormal operation and failures	Conservative design and high quality in construction and operation, control of main plant parameters inside defined limits	No off-site radiological impact (bounded by regulatory operating limits for discharge)	Normal operation
Level 2	Control of abnormal operation and failures	Control and limiting systems and other surveillance features		Anticipated operational occurrences
Level 3 ⁽¹⁾	3.a Control of accident to limit radiological releases and prevent escalation to core melt conditions ⁽²⁾	Reactor protection system, safety systems, accident procedures	No off-site radiological impact or only minor radiological impact ⁽⁴⁾	Postulated single initiating events
	3.b	Additional safety features ⁽³⁾ , accident procedures		Postulated multiple failure events
Level 4	Control of accidents with core melt to limit off-site releases	Complementary safety features ⁽³⁾ to mitigate core melt, Management of accidents with core melt (severe accidents)	Off-site radiological impact may imply limited protective measures in area and time	Postulated core melt accidents (short and long term)
Level 5	Mitigation of radiological consequences of significant releases of radioactive material	Off-site emergency response Intervention levels	Off site radiological impact necessitating protective measures ⁽⁵⁾	-

Figure 7. Defence in depth levels according to WENRA [WENRA, 2013].

New reactor concepts are designed to eliminate as much of the accident vulnerabilities and possible initiating events as reasonable achievable. Drastic safety advancements can be achieved by adopting inherent safety features and passive safety systems in new plant designs as well as incorporating lessons learned from old NPPs.

Most if not all mature SMR designs safety concepts are based on the defence-in-depth principle, so there should not be any fundamental show stoppers to license them in Finland. But without detailed designs nothing can be said for sure in the matter.

Over all the fundamental basis of the Finnish regulations on nuclear safety is the same as the driving force of the major SMR designs, utilisation of inherent safety and passive safety systems. This is clearly seen in the YVL guide part B.1: Safety Design of a Nuclear Power Plant seen below:

402. According to Section 14(1) of Government Decree 717/2013, in ensuring safety functions, inherent safety features attainable by design shall be primarily utilised. In particular, the

combined effect of a nuclear reactor's physical feedback characteristics shall be such that it mitigates the increase in reactor power.

403. According to Section 14(2) of Government Decree 717/2013, if inherent safety features cannot be utilised in ensuring a safety function, priority shall be given to systems and components which do not require a power supply or which, in consequence of a loss of power supply, will settle in a state preferable from the safety point of view.

448. In the event of anticipated operational occurrences or postulated accidents, it shall be possible to accomplish decay heat removal from the reactor and containment by one or several systems that jointly meet the (N+2) failure criterion and the 72-hour self-sufficiency criterion in such a way that the limits set forth for fuel integrity, radiological consequences and overpressure protection in the respective design basis category DBC2, DBC3 or DBC4 are not exceeded. If the decay heat removal systems or their auxiliary systems have passive components that have a very low probability of failure in connection with the anticipated operational occurrence or postulated accident, the (N+1) failure criterion may be applied to those components instead of the (N+2) failure criterion.

There may be some different interpretations on the safety grade of systems between the regulator and the designer but this is only speculation. Also the independence of the defence-in-depth levels may be an issue of some SMR designs. But as mentioned before the lack of detailed schematic of the different SMR designs nothing sure can be said on the licensability of the SMRs.

5.2 Passive safety systems

5.2.1 Passive safety systems and features in selected SMRs

IAEA's "Safety related terms for advanced nuclear plants" (IAEA-TECDOC-626) defines an inherent safety characteristic as a fundamental property of a design concept that results from the basic choices in the materials used or in the other aspects of design which assures that a particular potential hazard can not become a safety concern in any way. When an inherent hazard has not been eliminated, engineered safety systems, structures or components are provided. The concepts of active and passive safety describe the manner in which safety systems, structures or components function and are distinguished from each other by determining whether there exists any reliance on external mechanical and/or electrical power, signals or forces. The absence of such reliance in passive safety means that the reliance is instead placed on natural laws, properties of materials and internally stored energy. Some potential causes of failure of active systems, such as lack of human action or power failure, do not exist when passive safety is provided (Safety related terms for advanced nuclear plants, 1991). Main inherent safety features and passive safety systems of NuScale, SMART and ACP100+ SMR concepts are described in this chapter.

NuScale concept includes multiple design features that can be considered to inherently and passively enhance safety [^aARIS, 2016; ^bReyes 2012]:

- During normal power operation the containment atmosphere is evacuated in order to provide an isolating vacuum that significantly reduces heat loss from the reactor vessel. As a result the vessel does not require surface insulation – which in turn eliminates the potential for sump screen blockage. Low concentration of non-condensable gases in high vacuum also enhances condensation rates if safety valves vent steam into this space. Furthermore the absence of air prevents the possibility of combustible hydrogen mixture forming in an accident situation. This means that passive autocatalytic recombinators are not needed
- Due to reactor containment's relatively small diameter, it has a design pressure in excess of 4.1 MPa – roughly ten times that of a conventional containment structure.

- The reactor vessel has both a smaller nuclear core, with only 5 % of the fuel of a typical large reactor, and a much larger water inventory. The reactor vessel water volume to thermal power ratio is four times larger than that of a conventional PWR.
- The nuclear core is cooled entirely by natural circulation. This feature eliminates pumps, pipes and valves – thus eliminating the possible failures of those components.
- The module being submerged in a water pool provides multiple safety advantages. Beside the ECCS and DHRS systems which rely on it, it also dampens seismic events, acts as an additional fission product barrier, acts as a radiation shield, provides physical security and holds all the water needed for cooling the reactors already in place before any event.
- The integral configuration eliminates the possibility of a traditional large break loss of coolant accident.
- The water pool containing the reactor modules is housed in a steel-lined, pre-stressed, post-tensioned concrete containment that is capable of withstanding an aircraft impact.

In addition to inherent and passive features, the concept includes also two independent passive safety systems. The first of these systems is the decay heat removal system (DHRS) which is capable of transferring core decay heat from either of the two steam generators to isolation condensers immersed in the reactor pool. The system is closed loop, two-phase natural circulation cooling system with two redundant trains attaching to each of the steam generator loops. The DHRS is capable of decay heat removal for a minimum of 3 days without pumps or power [*ARIS, 2016; Reyes, 2012*].

The second system is emergency core cooling system (ECCS) which is composed of the reactor vent valves (RVVs) located on the reactor vessel head and the reactor recirculation valves, located on the sides of the reactor vessel. ECCS operates by opening the vent valves which vent primary system steam into the containment to be condensed on the containment's inner surface. The condensate collects in the lower region of the containment vessel. When the liquid level in the containment rises above the top of the recirculation valves, valves are opened to provide natural circulation path from the lower containment through the core and out the RVVs. The system works in conjunction with Containment Heat Removal System (CHRS) which appears to mean the passive convection and conduction heat transfer of the outer surface of the containment vessel [*ARIS, 2016; Reyes 2012*]. In Fig. 8 DHRS is marked as "water cooling" while "boiling" and "air cooling" mark the two phases of ECCS.

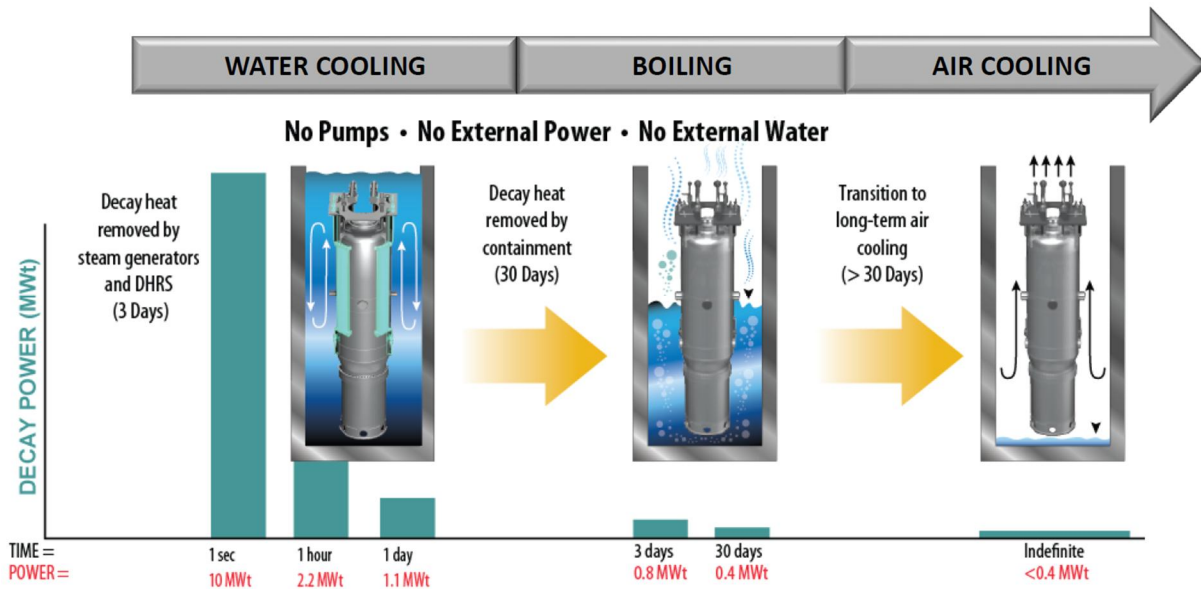

Figure 8. NuScale plant response to loss of all power situation [Surina, 2015].

Like NuScale concept, SMART has a number of design features that can be considered to inherently and/or passively enhance safety:

- The integrated arrangement of a reactor vessel assembly enables the large-size pipe connections to be removed, which results in an elimination of large break loss of coolant accidents [ARIS, 2016].
- SMART has a large coolant inventory to thermal power ratio. The core has also low power density (2/3 of a large PWR) [Park, 2011].
- SMART has a large containment volume. Assuming 100 % fuel cladding oxidation, in accident situation maximum hydrogen content is under 7 % which is not high enough for hydrogen explosion. In addition to large volume working as a safety feature, the containment also houses a passive safety system for hydrogen mitigation in the form of 12 passive auto-catalytic hydrogen recombiners (PARs). [Park, 2011; Kim K.K., 2014].
- The integrated arrangement of reactor vessel assembly enables the large size pipe connections to be removed, which results in the elimination of large break loss of coolant accidents. Small inventory of the steam generator secondary side water prohibits return-to-power following a steam line break accident (ARIS: System-Integrated Modular Advanced Reactor). Reactor coolant pumps with canned motors that have no pump seals inherently prevent loss of coolant associated with pump seal failure [Kim K.K., 2014].
- The containment and auxiliary building of SMART are designed to withstand an aircraft collision (Boeing 767) without damage to the reactor or spent fuel pool [Kim K.K. 2014].
- SMART has a flow mixing header assembly (FMHA) which can be considered to be an safety enhancing feature. The purpose of FMHA is to maintain a uniform temperature distribution in the coolant at the core inlet in the case of failure in the steam generator or reactor coolant pump. In other words, the main objective of the FMHA is to enhance thermal mixing of the the coolant [Kim J.W., 2012].

The concept contains passive residual heat removal system (PRHRS) which can passively remove decay heat through the steam generator and the condensate heat exchanger after a reactor shutdown. Since it is a passive system, it removes the possibility of undesired operator actions during accident and transient conditions. When an accident or transient occurs in SMART, the feedwater isolation valve (FIV) and the main steam isolation valve (MSIV) are closed, and the PRHRS isolation valve is opened. A closed loop with natural circulation flow is established, and the heat can be removed from the primary side of the steam generator through the PRHRS. This systems has four trains with 50 % capacity and has the capability to keep the core undamaged for 72 h without any corrective action by operators [Chung 2013, Kim Y.S., 2016; Kim K.K., 2014].

In order to improve safety performance and eliminate the inherent weakness of the active safety system under the circumstances of a loss of all electric power, KAERI is developing a passive safety injection system (PSIS) to replace the active safety injection system adopted in the standard design of SMART. It consists of four trains, each of which includes a gravity driven safety injection tank (SIT) and a core make-up tank (CMT). Schematic presentation of this system, which is still in development, can be seen in Fig. 9 [Chun, 2014].

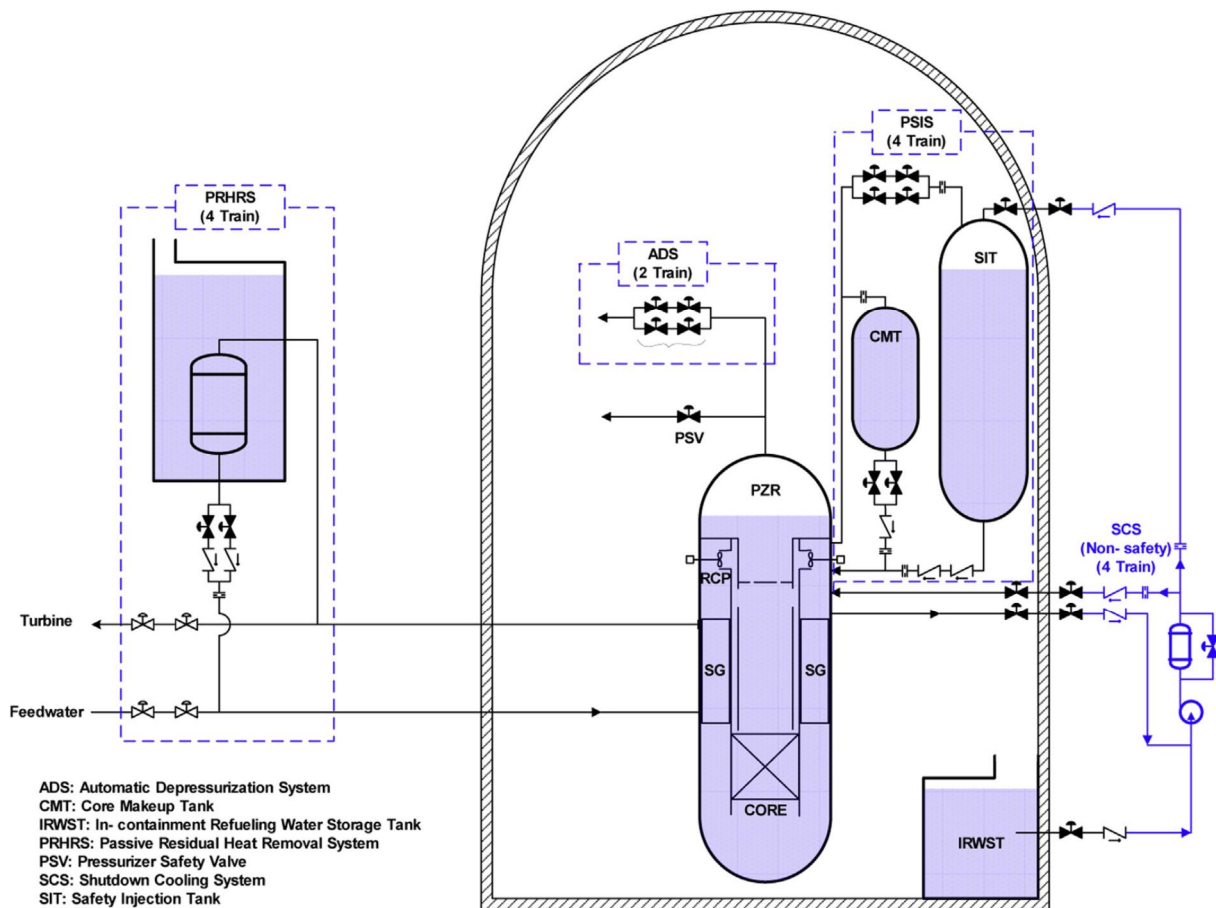

Figure 9. Schematic of the SMART passive safety system in development [Chun, 2014].

ACP100+ is designed as a forced circulation PWR with integrated reactor coolant system (RCS) to eliminate the primary loop pipes and surge line of pressurizer and therefore prevent the large and medium LOCA accidents. The atmosphere as the ultimate heat sink is achieved by a compact steel containment which is fully submerged in coolant. Control rod mechanism is internal which eliminates the possibility of rod ejection accidents. Passive safety systems are utilized to further lower the core damage frequency [Progress of SMR ACP100 Series, 2014].

Of the the passive residual heat remover (PRHR) no system description is available but based on what can be seen in Fig. 10, it seems fairly similar to that of SMART concept. The plant also contains ECCS system but description of it could be found. Same applies for the ADS and CSS systems which seem to be connected and presumably work as a over pressure protection system which leads primary steam into a water pool.

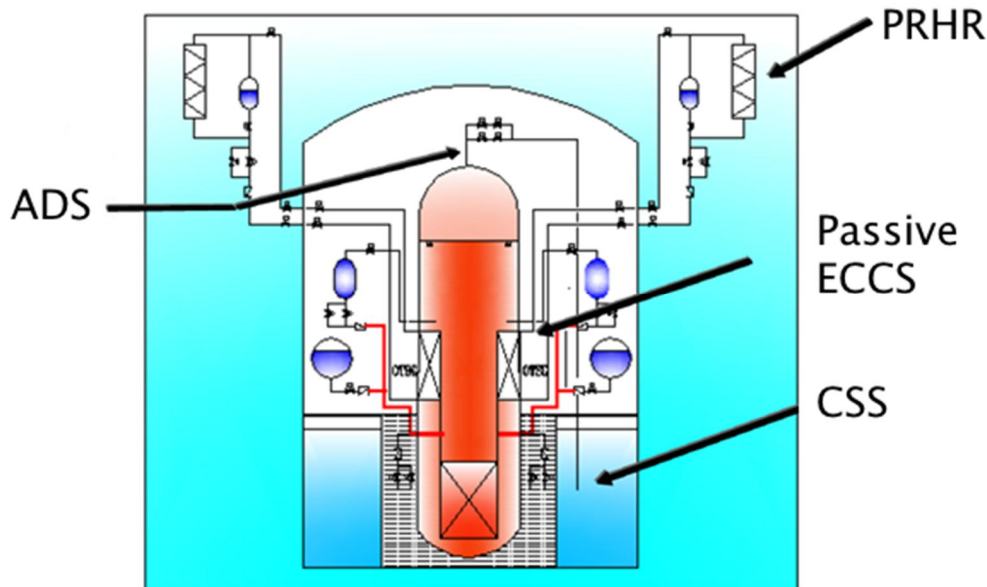

Figure 10. Overall technical plan of ACP100+ [Progress of SMR ACP100 Series, 2014].

5.2.2 Applications and possible problems of natural circulation

5.2.2.1 Introduction to natural circulation

The term 'natural circulation' refers to the case in which only naturally occurring forces, like buoyancy / gravity cause fluid to flow, usually in a closed circuit, but in cases also in an open circuit. This is in contrast to forced circulation, in which e.g. electric pumps create a pressure difference that forces the fluid to flow. The most usual case of natural circulation driving force is a system where the fluid is heated at low elevation, it becomes hotter and less dense and starts to rise until being cooled at a higher elevation, from where it will return as colder and denser to the heater part. There are lots of conventional (non-nuclear) and partly very old applications: cooling radiators in old cars, heating radiators in old houses, many fossil-fueled power plants, open fires, chimney upwards draught, immersed water heaters, etc., Fig. 11 shows the principle of natural circulation in a closed single-phase loop (left-hand side) and in an open two-phase loop (right-hand side).

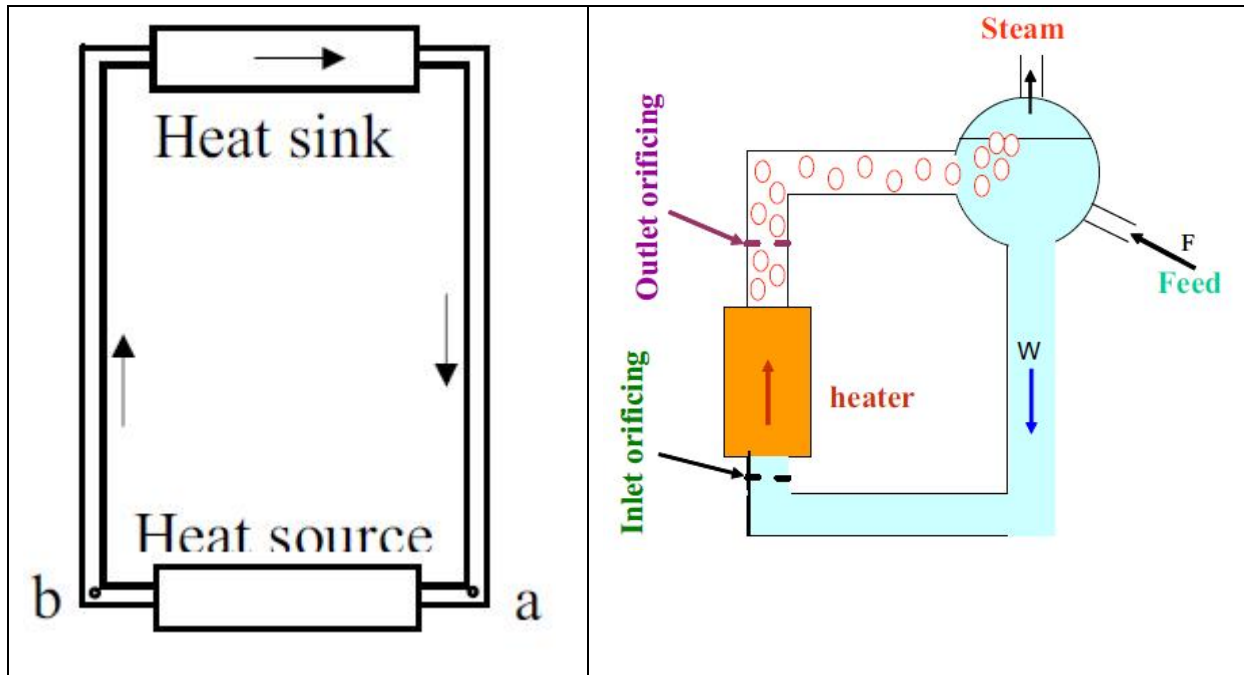

Figure 11. Hot leg, cold leg, riser, downcomer, recirculation ratio, inlet subcooling, inlet orificing, outlet orificing [Vijayan, 2010].

An important dimensionless number in connection with natural circulation is the Rayleigh number Ra . It is defined as the product of the Grashof number (ratio of buoyancy to viscous forces) and the Prandtl number (ratio of momentum diffusivity to thermal diffusivity):

$$Ra_x = Gr_x * Pr$$

So the Rayleigh number Ra can be interpreted as the ratio of buoyancy and viscosity forces multiplied by the ratio of momentum and thermal diffusivities. When the Rayleigh number exceeds the critical value for the particular fluid, heat transfer will mainly take place in the form of convection (free / natural convection).

Vijayan (2010) presented the following criteria for classification of natural circulation. It is immediately evident that a large number of completely different physical settings exist, so that a single method of modelling / simulation will probably not be suitable for all:

- Fluid state: single-phase, two-phase, supercritical
- Closed (only energy exchange) or open (mass and energy) loop
- Rectangular or other shape
- Gravity or centrifugal body force
- System inventory: single-phase, two-phase, reflux condensation in SG
- Single-channel / multi-channel

Examples of nuclear applications of natural circulation, specifically in SMRs, include NuScale and CAREM. In both, the primary circulation in normal operation (as well as possible residual / decay heat removal) is driven by natural circulation. A number of various other applications (than plant nominal main circulation) of natural circulation in SMRs exist. Both NuScale and CAREM are examples of iPWR, or integrated pressurized water reactor, designs. Integration

means that the reactor core and steam generators (and possibly pressurizer) are contained within the same pressure vessel.

In phase 1 of 2016 work on natural circulation, a literature review was conducted of some prominent, mostly LWR based, SMR designs and problems possibly encountered with natural circulation. In e.g. NuScale, the coolant density difference between the core and the heat exchanger causes coolant natural circulation. In such a system, pressure losses have to be small, which increases the sensitivity to thermal-hydraulic instabilities and may lead to oscillating conditions.

In phase 2 of 2016 work on natural circulation, a literature review was conducted of CFD assessments of SMR natural circulation. For possible future work, a rough proposal for a CFD simulation model of natural circulation primary cooling in an exemplary SMR plant is sketched. In buoyancy-driven natural circulation, pressure drop is controlled by the friction with all the walls of the whole circulation loop, and so a detailed CFD computation (with resolution of the geometry of the walls) of flow and heat transfer is unavoidable. A properly developed CFD model should be more mechanistic and reliable than a system code approach in discovering phenomena driven by fluid density differences.

5.2.2.2 Applications of natural circulation in nuclear power plants

In natural circulation reactors, appearing in many SMR designs (e.g. NuScale), the coolant density difference between the core and the heat exchanger causes coolant circulation. Consequently, the driving forces are weak and compared to forced circulation reactors, more careful design and analysis tools are needed. The channel power is limited by the mass flux through the core and in order to increase the channel power, the circulation loop resistance is reduced. Small pressure losses increase the sensitivity to thermohydraulic instabilities and may lead to oscillating conditions especially during the start-up period. In the low-pressure-low-flow conditions, the commonly employed thermohydraulic relationships (various correlations) are not applicable. Furthermore, since the pressure drop is not controlled by a few components but by the friction with all the walls of the whole circulation loop, a detail computation of flow and heat transfer is unavoidable. Stability analyses should be carried out also with coupled computations of neutron kinetics and hydrodynamics.

Most attention is here paid to plant designs that use natural circulation for their primary circulation in normal operation. Such SMR plants, listed below alphabetically by their country of origin, are e.g. the following:

- Argentina: CAREM-25 (27 MWe)
- India: AHWR300-LEU
- Japan: DMS, IMR
- Russia: ABV-6M, VK-300, UNITHERM, SHELF, ELENA
- USA: NuSCALE (45 MWe), SMR-160

The Argentinian CAREM-25 prototype plant with 27 MWe is developed jointly by CNEA and INVAP and presently being built near the Atucha NPP north of Buenos Aires. The project is expected to be completed in 2018 and followed by a bigger version with at least 100 MWe power. CAREM has integrated, self-pressurized primary cooling system with natural circulation. Also the safety systems rely on passive features. The RPV is 3.2 m in diameter

and 11 m in height. It has 61 hexagonal fuel assemblies and 12 once-through vertical helical steam generators.

The Indian AHWR design is an advanced heavy-water moderated reactor using LEU-Thorium fuel. It has vertical pressure tubes, in which the light water coolant boils, and produces 300 MWe. Natural circulation removes heat from the core in both operating and shutdown conditions. A notable design objective is that because of the advanced safety features, no exclusion zone should be required outside the plant boundary. AHWR is also suggested for water desalination.

The Japanese DMS (Modular simplified and medium small reactor, of BWR type, by GE-Hitachi) and IMR (Integrated modular water reactor, of PWR type, by Mitsubishi) are relatively powerful, slightly more than 300 MWe, using natural circulation (no pumps) for core cooling. They both have completed conceptual design and have hybrid (both active and passive) safety systems. In IMR, the concept of a two-phase riser (vertical component functioning in the principle of a chimney) is used: The light water coolant starts to boil in the upper part of the core, and bubbly flow continues upwards in the riser, until finally being condensed and cooled in the steam generators.

Of the five Russian designs on the list above, VK-300 received WNN news coverage in December 2016 after a Rosatom feasibility study concluded that 38 cogeneration (electricity & heat) reactors could be built at 14 sites in Russia. The VK-300 systems were found to have a rate of financial return higher than that of fossil-fueled systems. Designed by NIKIET, the VK-300 is a simplified water cooled & moderated BWR. It uses natural circulation, sufficient during normal operation and any emergency, for coolant and passive safety systems. The fuel elements are similar to VVER. The electric power output is 150-250 MWe depending on the proportions of heat and electricity. The design is based on a smaller prototype (VK-50) which operated for 31 years in Dimitrovgrad.

The ABV is a Russian floating or land-based PWR type plant with natural circulation of light water, producing 8.6 MWe. It is designed by OKBM Afrikantov and uses integral steam generator and primary natural circulation. The SHELF design by NIKIET is a 6 MWe seabed iPWR module (mainly for Arctic seas) which has both forced and natural circulation in the primary circuit. UNITHERM is a 5-10 MWe conceptual PWR design by RDIPE. It has 3 coolant loops with natural circulation, and passive RHRS and safety systems. ELENA is a very small (3.3 MWt but only 68 kWe) PWR design by Kurchatov Institute. It is intended to be an unattended (no personnel) NPP.

The American NuScale design, with core cooled by natural circulation only, was already described above in this report. The other one just listed, SMR-160, is a 160 MWe PWR type design by SMR Inventec / Holtec. No pumps are needed to run the reactor. It is claimed to be 'walk-away safe', meaning that no pumps or motors are needed to remove heat during any anticipated transients or postulated accidents.

Some possible applications of natural circulations in NPPs are briefly listed in the following. Examples here include also bigger plants than SMR.

According to the reactor type (PWR or BWR), there are the following possible system configurations in nominal operating conditions:

- Core and elevated SG (or other heat exchanger), either in integrated pressure vessel or connected by piping.
- Core which boils the coolant, causing two-phase flow, and inlet of colder feedwater in the downcomer (BWR).

In addition to normal operation, core heat must be removed under abnormal conditions (Passive Decay / Residual Heat Removal System, or PRHRS):

- Heat removal from intact primary system (normal operation heat sink has been lost) to e.g. the IRWST (in-containment refuelling water storage tank) or the atmosphere.
 - BWR, e.g. the ESBWR and BWR 90+: Isolation condensers (IC, gravity driven, with water pool possibly open to the atmosphere). Steam from the core is condensed inside IC tubes, after which the condensate water returns to core by gravity. Isolation condenser open side was the first application of the VTT in-house code PORFLO in 2003.
- Heat removal from primary system in case of accidents, e.g. ECCS.

Large pools of water (isolation condenser pools, elevated core make-up tanks, IRWST) will develop a 3D natural convection circulating flow when heat is transferred to them, possibly also by a natural circulation loop.

Also the containment atmosphere or vessel can be cooled passively, by closed loop natural circulation. For example, in the AES-2006 plant (large NPP), heat exchangers (vertical condenser tubes) of containment PHRS (passive heat removal system) are located inside the containment at high elevation near the containment wall. The heat is then transported to emergency heat removal tanks located outside on the roof of containment building. Obviously, their freezing or insulation by snow should be prevented in winter. Inside the containment, heat transfer will take place by circulating flow created by natural convection, which is dependent on density of gas mixtures vs. temperature.

Other examples of natural circulation use in nuclear power plants include passive corium cooling (e.g. the Indian SMR, AHWR300-LEU), moderator cooling in advanced CANDU, and passive shutdown in the PIUS reactor (Vijayan 2010).

Water is the most common, but not the only coolant type in natural circulation systems:

- Light water in the 11 examples above:
 - PWR: ABV-6M, UNITHERM, ELENA, SMR-160
 - iPWR: CAREM-25, IMR, NuSCALE, SHELF
 - BWR: DMS, VK-300
 - Pressure tube boiling: AHWR300-LEU
- Liquid lead: e.g. SUPERSTAR (Argonne), SVBR-100 (AKME, Russia), in primary circulation
- Fluoride salt: e.g. FHR (Berkeley), emergency passive decay heat removal

As a historical note on marine reactors for submarine propulsion, the largest US submarines (Ohio class), built 1976-1997, use S8G PWR nuclear reactor, and can operate at significant power with natural circulation (silent mode). Also Soviet Alfa class submarines (1970s), using Pb-Bi eutectic (LBE) coolant, could switch between maximum power and minimum noise modes.

5.2.2.3 Physical phenomena of natural circulation

Natural circulation is a result of differing body forces (N/m^3), usually gravity, acting on the coolant at different locations. The difference in force is caused by coolant density difference,

which usually results from temperature difference (rising temperature will generally decrease density). It is essential that the heat source (like reactor core) should be located lower than the heat sink (like steam generator). Otherwise the circulation would be halted by stratification of temperatures.

Driving force from gravity is generally weaker than what is achieved by using pumps. (Usual main pump head pressure is in the order of a few bar.) For this reason, flow resistance (friction, turbulence) of the circulation loop must be reduced, e.g. by using larger diameters, less turns, or more hydrodynamically formed parts. Otherwise, coolant mass flux will remain small.

Weak driving force leads to low flow velocities, even after practical reductions of flow resistance. Velocities can be a fraction of those in pump-driven PWR flow (e.g. approximately 10 m/s in EPR primary piping). In the Japanese MHI-designed Integral Modular Water Reactor IMR (IAEA, 2014) of iPWR type, bubbly flow is deliberately used to accelerate the velocities in the riser part above the core. Two-phase coolant is then condensed and cooled by the SGs. This Hybrid Heat Transport System (HHTS) makes it possible to reduce the height of the pressure vessel and still achieve good mass flow rates.

Advantages of natural circulation, as compared with pump-forced flow, can be listed as follows [Vijayan & Nayak, 2010]:

- Construction and maintenance is simpler, as there are no moving parts, leading to lower costs. In addition to the absence of moving parts, the geometry of the flow circuit is usually simpler, because there are less pipe bends, elbows, etc. - often of necessity (to reduce the resistance).
- Usually a substantial part of nuclear power plant accident scenarios result from pump events. All of these are readily eliminated when there are no pumps.
- For electric pumps to work under all conditions, emergency diesel generators or batteries are needed. For natural circulation, these active power supplies are not needed.
- Without pumps, there are fewer connections and so fewer potential leak sites in the system. There is also less connecting piping, the extreme case being the integrated pressure vessel containing steam generators. All of this results in fewer possible accident scenarios.
- Natural circulation may achieve better, uniform flow distribution, particularly important for the reactor core. In a typical PWR, a steam line break results in drop of secondary pressure and rapid cooling of the primary loop going through the affected SG. In normal operation, a flow distribution device may be used to direct core inlet flow. In natural circulation, the thermal driving head is greater for high-power channels. Furthermore, the driving force of possible colder water is readily decreased.
- Natural circulation flow, particularly two-phase flow, will increase with heating power, whereas forced two-phase circulation meets more resistance with power, as more bubbles are generated.
- In natural circulation, low flow velocities and reducing friction lead the design to large volumes and low power densities, which is inherently safer than higher power density and less coolant, because there will be large thermal inertia (slow thermal response) in the system as more time will be needed to heat the coolant to a certain temperature.

IAEA (2005), on natural circulation in water-cooled NPPs, classify the physical phenomena occurring in various plant components and systems in the following way:

Reactor core

The following 3 categories of physical phenomena must be accounted for when assessing the ability of natural circulation to remove heat from the reactor core:

1. Core heat transfer, providing the thermally induced pressure difference and thus the only driving force for natural circulation. Heat transfer depends on e.g. fuel heat production, fuel materials, fuel geometry, fluid properties and flow properties.
2. The pressure loss in the reactor core, which usually forms the main part of total pressure loss in natural circulation.
3. Core flow stability, particularly in BWRs.

Connecting piping

The pressure drop in pipes will obviously affect the natural circulation flowrate. In case of two-phase flow, the flow regime (flow mode) and density are important factors. A so-called riser, a tall vertical chimney, may be used after the exit from core. This will increase the driving pressure head, but may on the other hand create the possibility of instabilities, e.g. due to flashing vaporization caused by decreasing pressure.

Steam generators

In PWR type LWRs, heat is transferred to a secondary circuit by the use of steam generators. Also in many other reactor types some kind of heat exchanger is employed for similar purposes. Like in core, heat transfer (i.e. cooling of primary fluid) and pressure drop (usually second largest single drop, after core) affect the natural circulation flow. Like in the reactor core, steam generator heat transfer depends on materials, geometry & fluid and flow properties. Many integral PWRs have special helical coil steam generators with boiling of secondary fluid inside the helical tubes, which may introduce instability on the secondary side.

Passive RHRS

Residual heat removal systems (RHRS) transport decay heat to a heat sink after the reactor has been shut down. Typically the system has tubes, inside which single-phase fluid circulates. In a passive RHRS, the circulation is due to natural convection.

Containment shell cooling

In some reactor designs, the containment shell can be cooled by air or water from the outside. The MASLWR (Multi-application small light water reactor, a PWR with 35 MWe) is an American design with containment shell outer surface water cooling. The shell can act as ultimate heat sink during LOCA. Heat arrives at the wall in the form of vapor condensation, is then conducted through the wall, and then transported further outside by ambient water. Natural convection flow rates, flow patterns and heat transfer coefficients both inside and outside the containment shell affect the resulting rate of heat transfer. On the inside, non-condensable (NC) gases and condensate film thickness may have adverse effect on heat transfer.

Containment cooling (PCCS)

PCCS stands for passive containment cooling system. Its function is to transfer heat from containment inner atmosphere to heat sink outside the containment. A passive system is based on natural circulation flow. Phenomena affecting heat transfer include NC gases, condensation rates, CCFL (counter-current flow limitation), entrainment, deposition and flow resistance.

Cooling pools

Large water pools can be used as heat sinks for natural circulation heat exchangers that remove heat from reactor core or containment. Heat transfer rates are affected by natural circulation flow patterns and possible thermal stratification, which can block circulation and heat transfer.

The review of natural circulation physical phenomena here was mainly based on IAEA (2005). The phenomena described above are systematically listed in Table 3 according to the plant component or system where they take place.

Table 3. Local physical phenomena affecting natural circulation, arranged systematically according to the plant component or system [IAEA, 2005].

Component	Phenomena		
Reactor Core (Heat Source)	Fuel Heat Transfer		
	<ul style="list-style-type: none"> • Fuel/Cladding Conduction (geometry specific) • Gap Conductance (fuel specific) • Stored Energy Release • Cladding Convective Heat Transfer <ul style="list-style-type: none"> ○ Single-Phase Forced, Mixed or Natural Convection ○ Two-Phase Subcooled, Nucleate or Film Boiling ○ Critical Heat Flux (DNB or Dryout) • Decay Heat 		
	Pressure Drop (Single and Two-Phase Fluid)		
	<ul style="list-style-type: none"> • Friction, Static, and Acceleration Pressure Drops • Void Fraction 		
	Parallel Channel Flow Stability		
	Interconnecting Piping	Pressure Drop (Single and Two-Phase Fluid)	
		<ul style="list-style-type: none"> • Friction, Static, and Acceleration Pressure Drops • Void Fraction • Single-Phase Fluid Flashing 	
		Heat Sinks (Steam Generators)	Convective Heat Transfer in Horizontal or Vertical Tubes
			Pressure Drop
	Passive Residual Heat Removal Heat Exchanger	Natural Circulation Flow Rate	
Tube Bundle Internal and External Convective Heat Transfer			
Tube Wall Conduction Heat Transfer			
Tube Bundle Pressure Drop			
Containment Shell (External Air or Water Cooling)	Internal Wall Heat Transfer		
	<ul style="list-style-type: none"> • Non-condensable Gas Mass Fraction • Vapour Condensation Rates • Condensate Film • Natural Convection Flow Rates and Patterns • Containment Shell Heat Capacitance 		
	Wall Heat Conductance		
	External Heat Transfer		
	<ul style="list-style-type: none"> • Natural Convection Heat Transfer • Natural Convection Flow Patterns 		
	Containment Cooling Condensers/Heat Exchangers	Tube Heat Transfer	
		<ul style="list-style-type: none"> • Non-condensable Gas Mass Fraction • Vapour Condensation Rates 	
		Counter-Current Flow Limitations	
		Entrainment/De-entrainment	
Flow Resistance			
Large Cooling Pools (For Heat Exchangers, Spargers and as a Source of Coolant)	Thermal Stratification/Fluid Mixing		
	Vortex Formation		
	Direct Contact Condensation		

5.2.2.4 Potential issues in natural circulation

A joke about passive systems says that they may be 'too passive', i.e. not start to work at all when needed. Ultimate proof could be to check in the real plant, before loading with nuclear fuel, as many of the passive systems as possible for proper functioning when the starting condition is triggered. For natural circulation, many kinds of physical phenomena could prevent proper function: thermal stratification, a steam void blocking circulation, loop seal (blockage of primary coolant loop with filled water), or various manometer-type effects.

Vijayan & Nayak (2010) list several kinds of challenges that may compromise the proper functioning of natural circulation flow: low driving force in comparison with pumps, the resulting need to design for low pressure losses, low mass flux, various instability effects, problems specific to LPLF (low pressure low flow) regime, difficult start-up and operating procedures, and possibly low value of CHF (critical heat flux).

Instabilities / oscillations

Unfortunately, natural circulation is inherently less stable than forced (pump-driven) circulation. The latter can be stabilized by using inlet orificing (narrower part in the flow channel), which is not as easy in the case of natural circulation. The difficulty results in part from small pressure losses, which tend to increase sensitivity to thermohydraulic instabilities. There can be adverse nonlinear feedback effects: A small change in the driving force (buoyancy) is sufficient to change the flow, which affects the heat transfer, and then also the buoyancy resulting in change of driving forces. This chain of events can lead to a sustained oscillation. Particularly the start-up procedure of natural circulation reactors is prone to oscillations.

Table 4 contains a systematic classification of thermal-hydraulic instabilities. Dynamic instabilities can be studied by using time-dependent equations, whereas the for the static ones, steady state equations are sufficient from the explanation point of view. For example, Marcel et al. (2013) have studied the dynamic phenomenon called density wave oscillations (DWO) of Type I and Type II in the SMR plant design CAREM-25, currently being built in Argentina. The low-quality flow in CAREM-25 leads to the possibility of Type I instability, for which the main governing parameter is the transit time of steam voids through the chimney section.

Table 4. Classification of thermal-hydraulic instabilities [IAEA, 2005].

Class	Type	Mechanism	Characteristic
<i>Static Instabilities</i>			
Fundamental (or pure) static instabilities	Flow excursion or Ledinegg instabilities	$\left. \frac{\partial \Delta p}{\partial G} \right _{\text{int}} \leq \left. \frac{\partial \Delta p}{\partial G} \right _{\text{ext}}$	Flow undergoes sudden, large amplitude excursion to a new, stable operating condition.
	Boiling crisis	Ineffective removal of heat from heated surface	Wall temperature excursion and flow oscillation
Fundamental relaxation instability	Flow pattern transition instability	Bubbly flow has less void but higher ΔP than that of annular flow	Cyclic flow pattern transitions and flow rate variations
Compound relaxation instability	Bumping, geysering, or chugging	Periodic adjustment of metastable condition, usually due to lack of nucleation sites	Period process of super-heat and violent evaporation with possible expulsion and refilling
<i>Dynamic Instabilities</i>			
Fundamental (or pure) dynamic instabilities	Acoustic oscillations	Resonance of pressure waves	High frequencies (10-100Hz) related to the time required for pressure wave propagation in system
	Density wave oscillations	Delay and feedback effects in relationship between flow rate, density, and pressure drop	Low frequencies (1Hz) related to transit time of a continuity wave
Compound dynamic instabilities	Thermal oscillations	Interaction of variable heat transfer coefficient with flow dynamics	Occurs in film boiling
	BWR instability	Interaction of void reactivity coupling with flow dynamics and heat transfer	Strong only for small fuel time constant and under low pressures
	Parallel channel instability	Interaction among small number of parallel channels	Various modes of flow redistribution
Compound dynamic instability as secondary phenomena	Pressure drop oscillations	Flow excursion initiates dynamic interaction between channel and compressible volume	Very low frequency periodic process (0.1Hz)

Pressure losses and reducing them

Because of the low driving force, it is usually attempted in natural circulation systems to increase the driving head by increasing loop height, or decrease the resistance to flow. Increasing loop height may have some drawbacks, for example construction and maintenance cost will be increased, and additional height may bring bigger seismic concerns. The other route to bigger mass flow rates, decreasing resistance, can be achieved by e.g. simplifying the system, eliminating some components and using larger diameters.

Components of total pressure drop can be classified as follows (IAEA 2012, page 9):

- Distributed, friction-caused loss
- Local losses, caused by shape, direction etc. changes

- Reversible losses, caused by acceleration, density changes, elevation, gravity

In more detail, pressure loss is affected by e.g. the following factors:

- Geometry: pipes, annuli, rod bundles, heat exchangers, valves, headers, plenums, pumps, large pools
- Fluid status: 1-, 2-, multi-phase; 1-, 2-, multi-component
- Nature of flow: laminar / turbulent
- Two-phase flow mode (pattern): bubbly, slug, annular, etc.
- Direction: up, down, inclined, horizontal, countercurrent
- Flow type: separated, mixed
- Flow paths: 1D, multi-dimensional, open, closed, distributors, collectors
- Operating state: steady state, transient

In two-phase flow, the pressure loss depends not only on the geometry and flow velocity, but also on the flow regime, which makes it dependent on both liquid and gas flowrates. The dependence is generally not monotonic. Fig. 12 shows an example of pressure gradient variations as the flowrate of gas changes, and so the two-phase flow exhibits different flow patterns. Bubbly flow encounters most resistance, after which slug flow has a local minimum of pressure loss. In churn flow, pressure loss increases again, after which there is global minimum before going to proper annular flow.

This kind of pressure loss information is not directly useful for CFD simulations, but it could be used for qualitative assessment of simulation results that were generated by using CFD-applicable closure laws.

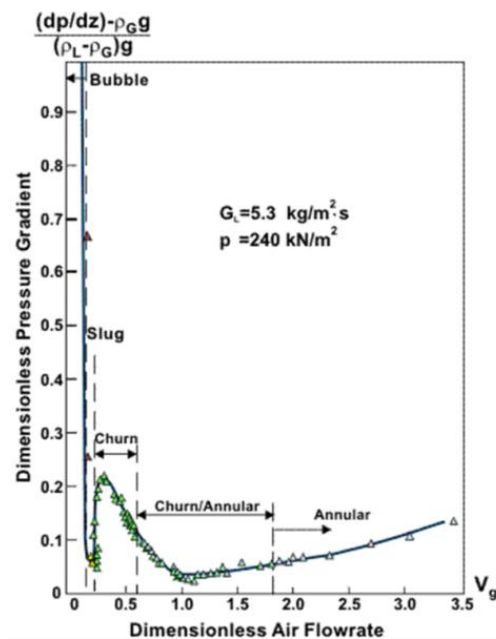

Figure 12. Example of pressure losses in the different regimes of two-phase flow. Bubbly and churn flow offer more resistance than the slug flow between them. When continuing towards annular flow, a global minimum of pressure loss is passed [Hewitt, 2011].

Other problems in natural circulation

In addition to instabilities and pressure losses, some further problems of natural circulation are related to control and operating procedures, CHF margins, and difficulties in simulation models:

- Low mass fluxes mean lower maximum channel power. To produce enough total reactor power, it is then necessary to use larger core volume, which in turn may bring zonal control & stability problems.
- It is relatively difficult to design start-up and shutdown procedures to avoid instabilities. The required procedures may be complicated. Questions include what is the optimal pressure to initialize boiling, should an external pressurizer (for cold start) be used, and should inlet subcooling be controlled.
- In a BWR type plant, it is harder to achieve good CHF margin when maximizing exit quality and at the same time minimizing size.
- At the start-up of natural circulation plant, the conditions are low pressure, low temperature and no flow (LPLF regime). Powering up from this to nominal operation may involve passing through an unstable zone, risking premature CHF. For a CHF correlation for NC / SMR, see Luitjens (2016).
- Natural circulation is harder to simulate properly than its pump-forced counterpart. A clear reason for this is the sensitivity to small changes in driving force and friction. Another problem is the poor availability of validated TH correlations particularly in LPLF conditions. This applies to system codes and CFD, but the problem is generally worse for CFD, because correlations based on local values would be needed, and their availability is worse than for correlations based on bulk quantities.
- A natural circulation plant will have to comply with both thermal and stability margin requirements. Usually the lower (Type I, low-quality flow, occurring with a chimney) instability threshold < CHF value < upper (Type II, high-quality flow, most common) instability threshold.
- Design may be complicated by the fact that factors such as inlet subcooling & bottom peaked power have opposite effects on CHF and stability. For example, increased inlet subcooling makes the stable region narrower.

For example, Marcel et al. (2013) have studied the stability performance of the Argentinian SMR design CAREM-25, which is a self-pressurized, natural circulation, low thermo-dynamic quality nuclear reactor. They looked at the following phenomena:

- Self-pressurization, flashing, condensation, density wave instabilities
- Numerous feedbacks between TH phenomena as such, and with neutronics

As with other passive systems, the central question with natural circulation is its reliability. IAEA (2005) have listed the phenomena most influencing on NC reliability as the following:

- Non-condensable gases
- Thermal stratification
- Mass stratification
- Pool heat transfer
- Moisture carryover (too much liquid content among steam)

5.2.2.5 Role of experiments and CFD in natural circulation problems

Because of the above-mentioned difficulties with simulation, natural circulation has been studied in countless experimental facilities. In many cases, the experimental facility is directly related to a certain plant design and can produce results directly applicable to the plant. Others may be used more generally for the validation of basic models in simulation codes. No simulation model (whether system code or CFD, coupled with neutron kinetics or not) can be relied on unless it has passed proper experiment-based validation. Some examples of natural circulation test facilities related to SMR-sized reactor designs are CAPCN in Argentina, MASLWR test facility in the USA, and DESIRE & CIRCUS in Netherlands (IAEA, 2005):

- The CAPCN (High pressure natural circulation rig) facility has full height relative to CAREM, but the volume is scaled at 1: 280. Its maximum pressure is 120 bar and maximum power 300 kW. The facility cover thermal hydraulics (TH), reactor control and operating techniques. The investigated TH phenomena included two-phase natural circulation, self-pressurization, condensation and stratification in the dome, void fraction generation and collapse in the riser, and SG heat transfer.
- MASLWR test facility, developed by OSU (Ohio State University) for the MASLWR (multi-application small light water reactor) reactor design has length scaled as 1:3 and volume as 1:254. It has a helical coil SG, internal pressurizer, an electric heated 700 kW core bundle, passively cooled high-pressure containment and an external cooling pool. The maximum pressure is 120 bar and temperature 590 K. The facility has been used to investigate e.g. primary loop flow stability of 1- and 2-phase natural circulation and helical coil SG heat transfer.
- The DESIRE and CIRCUS experimental facilities are related to the 58 MWe natural circulation Dodewaard BWR, which was in operation in the Netherlands from 1969 to 1997. DESIRE has height scaled as 1:2, circulates Freon-12 and is used to investigate natural circulation and stability at nominal system pressures. CIRCUS has the core and riser at 1:1 scale compared with the NPP. The experiments focused on thermal-hydraulic stability at low pressure start-up conditions.

Brief comparison of CFD vs. system codes

Natural circulation has been simulated with both thermal-hydraulic system codes (THSC, e.g. Apros) and with CFD codes. The main difference is the consideration of 3D phenomena. System codes can be used to create a 3D nodalization, or the proper 3D component of the system code can be used, but usually the approach is not comparable to CFD: Even with solution of 3D equations, the geometry and effect of walls is not accounted for. The definition of CFD (computational fluid dynamics) codes is usually thought to include at least the following features: Solution of fluid flow through the numerical 3D solution of Navier-Stokes

equations (equation of motion of a viscous fluid) with the continuous fluid domain divided into discrete cells or nodes such that cell faces correspond with the walls of the bounding structures (e.g. the inner walls of a pipe) so that it is possible to simulate the effect of wall friction in resisting the flow through viscosity. With another view, the definition corresponds to open-medium CFD, whereas in porous-medium CFD all the walls are not resolved, but are instead described statistically and their effects are modelled (e.g. the effect of wall friction is replaced by a total pressure loss). CFD is much more CPU intensive than THSCs. Open-medium one-phase CFD is a relatively mature field with reliable simulation results, but many complications arise with the introduction of turbulence, porous medium and two or more phases, with possible phase changes. Especially the combination of the three mentioned modelling difficulties is a very hard task. Examples of CFD codes include PORFLO (in-house development by VTT), NeptuneCFD (by the French EDF), CFX or FLUENT.

CFD can predict (simulate) local turbulence effects, which in principle makes experimental correlations less needed (IAEA, 2005). CFD validation experiments can basically be separate effect tests (SET), i.e. simpler than experiments in integral test facilities, because the code is assumed to mechanistically produce the integral outcome, just provided that all physical phenomena are correctly simulated. However, the experimental data sets acquired for CFD validation should be so-called CFD-grade, i.e. have high spatial and temporal resolution, corresponding the resolution of the simulation.

Some common, practical problems with CFD codes include:

- Physical models are not readily built-in, and correlations / models were mostly developed for system codes, referring to bulk (not local) values of physical quantities.
- Interfacing (coupling) with other components, like system codes, is not straightforward.
- Convergence difficulties during the simulation.
- Computer capacity limits turbulence description, spatial resolution (geometry of the structures and two-phase intermittency) and time steps, particularly in long-lasting transients.
- Numerical errors (continuous geometry, equations and solution in discrete form) and modelling errors (physical processes approximated by empirical models).
- According to usual best practice guidelines (e.g. by OECD/NEA, 2007), a CFD solution must be shown to be grid-independent, i.e. not changing significantly if mesh is refined.

5.2.2.6 CFD in analysis and design of natural circulation

In analysis of natural circulation, 3D flow solution (CFD) should theoretically perform inherently better than system code nodalization or use of its 3D component. However, a high-quality CFD solution is also hard to achieve, for the following reasons:

- Difficulties in closure law definitions at various operating points. Most common correlations are not applicable in low-pressure low-flow conditions. More generally, thermal-hydraulic correlations were historically developed for system codes and are based on bulk quantities, rather than local values of quantities in CFD sense.
- The natural circulation system is physically, in the real world, quite sensitive to small changes in driving forces (buoyancy, caused by heat transfer) and modifications changing the friction in the flow path. In CFD, small changes might possibly disrupt

the simulation even in a non-physical way. It could be difficult to know, if the change in results is real physics or just numerical artefact.

- Lots of NC experiments exist, but may not be relevant to the particular plant to be simulated. In addition, the measurements were seldom CFD-grade, i.e. they were not acquired at the most interesting locations and at sparse spatial points.
- CFD is best suited for single-phase flow in complex geometry. Two-phase CFD has received a lot of development effort during the past ten years (e.g. the EU projects NURESIM, NURISP and NURESAFE), but is still generally not considered reliable enough in predicting what will happen at plant scale.
- All the walls of the whole circulation loop may have important effect, which leads to geometrically fine-detailed computation of flow & heat transfer. This increases the number of cells in the computation mesh and so also the CPU time spent on simulation. However, also the porous medium concept will inevitably be needed, because otherwise the mesh would simply become too large for any, even massively parallel, simulation. Porous medium CFD has its own difficulties compared with the usual open medium.
- Coupling of CFD-neutronics is essential. This research area has advanced well at VTT in recent years, and in 2016, several CFD codes (Fluent, OpenFOAM and PORFLO) can be coupled to a system code or neutronics solver.

IAEA (2012) have identified some specific problems in the CFD simulation of large pool natural circulation: the validity range of the Boussinesq approximation may be exceeded. (Note: The Boussinesq assumption states that the Reynolds stress tensor τ_{ij} can be written by using a scalar property μ_t called the eddy viscosity.) Because gravity is particularly important, turbulence should be modelled by unisotropic simulation.

Some published CFD simulations of natural circulation SMR plants have been published in the literature. For example, Guo et al. (2016) have developed an FHR (fluoride salt cooled high temperature reactor) advanced natural circulation analysis code for emergency passive decay heat removal. The model has staggered mesh for complicated pipe network and heat structures with several material layers.

Ge et al. (2016) have also simulated an FHR reactor with passive cooling system. They used the commercial CFD code Fluent, 3 different sets of meshes, and both realistic and porous modelling approaches.

Martelli et al. (2017) have used Fluent and RELAP5 for coupled simulations of the NACIE (natural circulation experiment) facility run by ENEA in Italy. The experimental loop circulates LBE (lead-bismuth eutectic). They have also compared stand-alone RELAP5 and the coupled simulations. However, the Fluent simulations were only performed with 2D axisymmetric domains.

Zhao et al. (2015) have used Fluent 14.0 to analyse the natural circulation characteristics of a small modular LBE cooled fast reactor. They looked only at the steady state behaviour, and got flow and velocity distributions in the primary system, as well as core flow distribution behaviour at the core inlet region. They conclude that neither system codes nor CFD alone can reproduce the many multi-dimensional thermal-hydraulic phenomena of the natural circulation system, but a coupled simulation would be needed.

In plant design, problems are much the same as in analysis, but further complication is the need optimize the construction with respect to e.g. cost and easy maintainability. It is possible, but not necessarily adequate, to simulate a natural circulation system without 3D effects. For example, the system code Flownex has been used with plant components modelled as 1D flow and heat transfer elements. This kind of approach can be used in many

system codes, like Apros. In a 2016 Flownex SMR brochure, this approach is claimed to be good for designing passive safety systems with natural circulation: “Calculate the plant-wide temperatures and pressures in response to various accident scenarios, taking into account decay heat generation, multiple natural circulation loops, transient energy storage and rejection to ambient conditions.” The design so achieved would include sizing of major components and calculation of overall plant efficiency.

It is proposed (in the future, if SMR research will continue) to develop a preliminary CFD model of the primary circulation loop of an SMR, like the NuScale 50 MW design. The model should use the porous medium modelling concept, as a structure-fitted grid is not practically possible due to the many geometrical details. The most delicate choices in the model include the porosities and friction coefficients. In lack of forced circulation, small changes may disrupt the balance of the model, if not even the operation of the physical plant itself. It is possible to make comparisons with a system code model (‘1D nodalization’) of the same plant, to assess the capabilities of system / CFD modelling on the basis of code-to-code comparison. It is expected that a properly developed CFD model should be more mechanistic and reliable in discovering phenomena driven by fluid density differences (which are not so important in traditional, pump-driven coolant loops). As a first step, it is proposed to simulate intended normal operation of the plant.

In buoyancy-driven natural circulation, pressure drop is controlled by the friction with all the walls of the whole circulation loop, and so a detailed CFD computation (with resolution of the geometry of the walls) of flow and heat transfer is unavoidable. A properly developed CFD model should be more mechanistic and reliable than a system code approach in discovering phenomena driven by fluid density differences.

5.3 Reactor physics

The modelling of an operating nuclear reactor requires solving a non-linear problem, in which the neutronics solution is coupled to heat transfer and coolant flow via physical feedbacks, and to changes in material properties by fuel burnup. In practice this means that the solution to the coupled problem is obtained by iterating between different solvers. In order to obtain a converged solution within a reasonable time, the calculation typically relies on a deterministic multi-stage calculation scheme, in which the interaction physics at the fuel assembly level is first reduced into a handful of homogenized group constants, which are then used as the building blocks for the full-scale coupled model. These reduced-order methods have been used in fuel cycle simulation and transient analysis codes for decades, and represent the state-of-the-art methodology in reactor core design and safety analysis.

During the past ten years the development of computer capacity and parallel computing has also allowed performing reactor physics calculations by direct coupling of high-fidelity methods, albeit on a limited scale. This approach was also studied in the Academy of Finland funded NUMPS project [Leppänen, 2015], carried out at VTT in 2012-2016. One of the observations was that even though the computational cost for these high-fidelity methods is still prohibitively high to be applied to large LWR cores, the methodology could be a practical option in the SMR scale. The high-fidelity coupling established in the NUMPS project was put to practice in this preliminary study, in an effort to evaluate whether or not it can be considered a viable approach to SMR reactor design and safety analyses in the future.

The coupling was used to model the two-way feedback between neutronics and thermal-hydraulics. Thermal hydraulics is used to solve density and temperature distributions which have major effect on neutron flux distribution and spectrum. An increase in the moderator temperature results in a decrease in moderator density and moderating effectiveness. This in turn hardens the neutron spectrum which is a negative reactivity addition in a thermal reactor. In the fuel the neutron flux is mainly affected by the Doppler broadening of the effective resonance cross sections. As the fuel temperature increases so does the resonance

absorption of neutrons. As most SMR designs employ passive safety systems relying on feedback effects, it is vital to take the feedback with thermal-hydraulics into account when modelling SMRs.

As a test case a mock-up SMR core in a steady state at full power with single phase flow was modelled. Neutronics were solved with Serpent 2 Monte Carlo code and thermal-hydraulics with COSY (Component/System-scale) thermal-hydraulics tool. Both of the codes are developed at VTT. They were coupled externally and the data between the codes was transferred using Serpent's multi-physics interface. The coupled problem was solved by iteration. At each iteration COSY solves new temperature and density distributions based on the current power distribution. The temperature and density distributions are passed to Serpent to solve the corresponding power distribution which is passed back to COSY to start a new iteration.

In order to create Serpent and COSY models for the test calculation, information on SMR core specifications was searched online. The focus was on the three selected SMR designs: ACP100, SMART and NuScale. All of them are PWRs. The data available to public was very limited and detailed core design specifications for any of the selected three SMRs wasn't found online. Most of the available data was in the form of presentation slides. The largest amount of information was found on NuScale and therefore the mock-up SMR core for the test calculation was created based on the NuScale design.

The results of the test calculation were presented at the 4th International Technical Meeting on Small Reactors which was hosted by Canadian Nuclear Laboratories (CNL) and Canadian Nuclear Society (CNS) in Ottawa, Canada on 2nd – 4th November. A variety of topics related to small modular reactors and research reactors were covered at this technical meeting.

5.3.1 Serpent and COSY models

Key parameters of the Serpent and COSY models are listed in Table 5 and the radial layout of the Serpent model is presented in Fig. 13. Some of the data required for the modelling was acquired from NuScale documents [*NuScale Power, 2014; Linik, 2015*] but since no detailed core specifications were available, a large amount of guesswork was involved in the modelling. The BEAVRS PWR benchmark [*Horelik, 2013*] was utilized in the building of the Serpent model.

Compared to traditional PWRs the most obvious difference is the size of the mock-up SMR core. There are only 37 fuel assemblies and the thermal power is only 160 MW. In addition the active fuel height is only 200 cm. Corresponding values for the EPR unit (Olkiluoto 3) [*TVO, 2016*] being constructed in Finland are 241 fuel assemblies, thermal power of 4300 MW and active fuel height of 420 cm. The fuel assemblies are standard 17x17 square assemblies used in western PWRs and the fuel is UO₂ with U-235 enrichment of approximately 2.0 percent. For simplicity the enrichment is the same in all of the assemblies and fuel rods. This enrichment was chosen to achieve an approximately critical core when neutron absorbing boron was added to coolant. The cladding is standard Zircaloy 4.

Coolant flow was solved on a channel level and temperature distribution in a one average fuel rod in each assembly. In regions other than the active core constant properties were used for the coolant and other materials. The NuScale SMR is cooled by natural circulation but in the COSY model forced circulation with low core inlet velocity was used.

Table 5. Key parameters of the Serpent and COSY models.

Thermal power	160 MW	Fuel rod diameter	9.50 mm
Number of assemblies	37	Fuel element diameter	8.20 mm
Assembly type	17x17 square	Cladding thickness	0.53 mm
Number of fuel rods in assemblies	264	Pin pitch	1.26 cm
Assembly pitch	21.50 cm	Operating pressure	12.7 MPa
Fuel material	UO ₂ (~ 2.0 %)	Core inlet temperature	535 K
Cladding material	Zircaloy 4	Core inlet velocity	0.95 m/s
Active fuel length	200 cm	Coolant/moderator	Light water

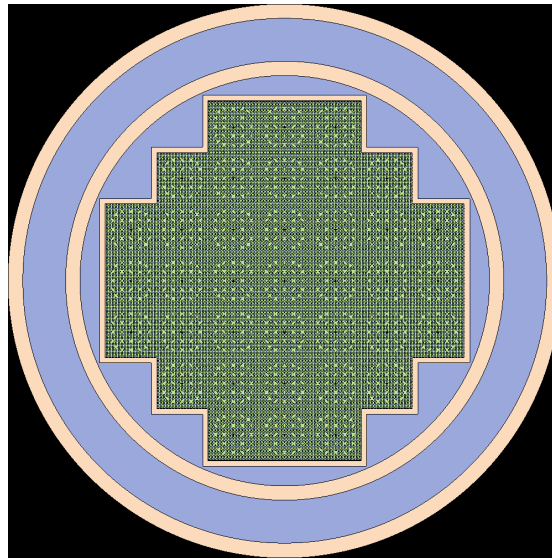

Figure 13. Radial layout of the Serpent model. The 37 square fuel assemblies in the center of the core are surrounded by core baffle. The smaller ring is the core barrel and the larger ring is the pressure vessel.

5.3.2 Coupled calculation results

The coupled calculation was run for 17 iterations. The calculation time was approximately 162 h on an outdated computer node consisting of two six core Intel Xeon X5690 3.47 GHz processors with 48 GB RAM. By using a newer node with more cores the calculation could have been run several times faster. The convergence of the coupled calculation was evaluated retrospectively by comparing the maximum absolute difference in the fuel temperature distributions on two consecutive iterations. After 17 iterations the maximum absolute difference was less than 0.4 K and 10 iterations would have been enough for a maximum absolute difference of less than 1 K. Radial and axial fuel temperature distributions for the coolant and the fuel are presented in Fig. 14 and Fig. 15. Higher temperatures are indicated by brighter colours. Regions other than the active core are

coloured blue as the temperature distribution was not solved in these regions. Because the fuel enrichment is the same in all of the assemblies, the power distribution is peaked to the center of the core. Therefore, the fuel temperature is also the highest and the coolant heats up the most in the center of the core.

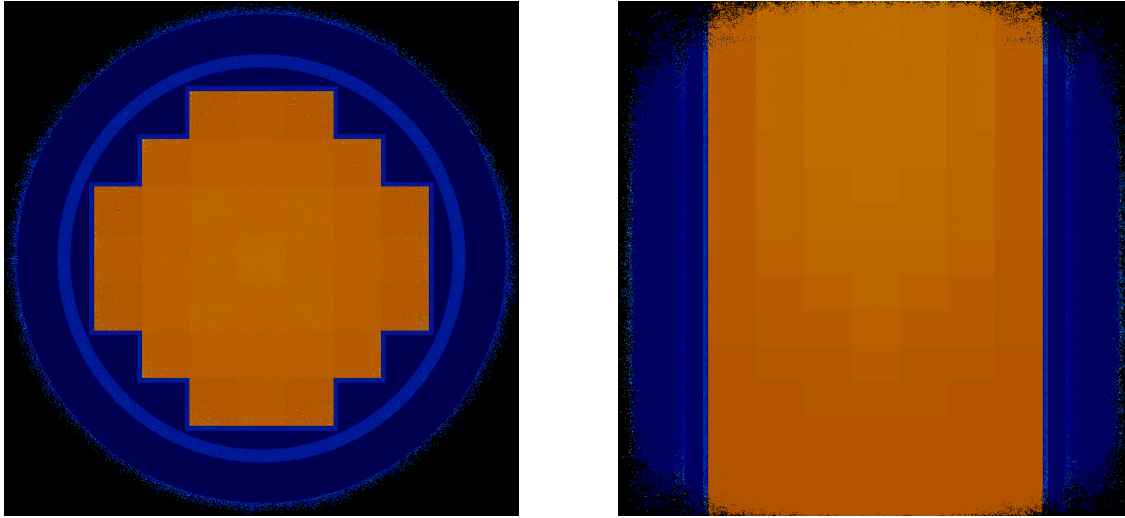

Figure 14. Radial and axial temperature distributions for the coolant.

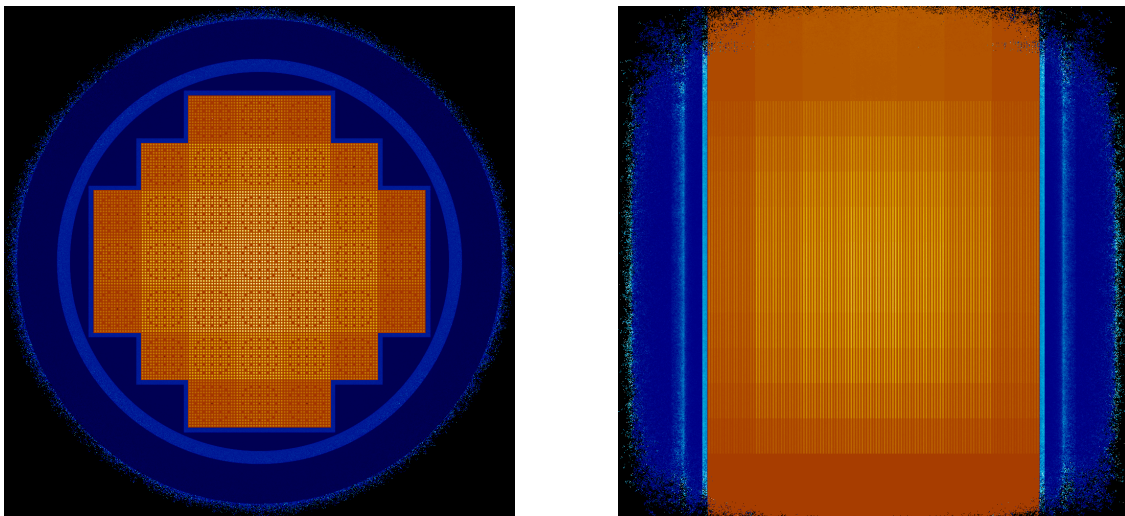

Figure 15. Radial and axial temperature distributions for the fuel.

5.4 Severe accidents

The possibility of a severe accident, even though unlikely, has to be taken into account in the design of modern power reactors. Severe accident management and mitigation measures are more and more often required of the licensees operating nuclear facilities by national-level regulations. This in contrast to the older, GENII power plants commissioned in the 1970s and the early 80s, for which it was considered adequate to prepare for design basis accidents only. In Finland, it is required by the nuclear safety authority (STUK) that severe accidents shall be considered in the planning of new-build reactors, and the role of severe accidents has been further revised in the recent reviews and updates on the Regulatory Guides on Nuclear Safety (YVL Guides).

For instance, on the stabilization of the molten core it is stated that “a nuclear power plant shall be equipped with systems to ensure the stabilisation and cooling of molten core

material generated during a severe accident. Direct interaction of molten core material with the load bearing containment structure shall be reliably prevented." (YVL B.6) In practice, this means that the new designs to be commissioned in Finland are equipped with a core catcher to retain and cool the corium, or rely on in-vessel retention. The latter means that the heat flux on the reactor pressure vessel (RPV) wall should remain below the critical heat flux that can be removed by the coolant on the outer surface of the vessel, in order to avoid damage and failure of the RPV.

In addition to the cooling of the molten core, the phenomena which are encountered in a postulated severe accident include formation of hydrogen and the related combustion risk, release and transport of radioactive fission products, direct heating of the containment, energetic fuel-coolant interactions (steam explosions), containment pressurization and the subsequent need for long-term decay heat removal, and re-criticality. The management methods of the severe accident phenomena which might threaten the containment integrity for four prominent SMR design are presented in Table 6. The handling of these phenomena often requires dedicated systems such as passive autocatalytic recombiners and external flooding of the reactor pressure vessel. The subsections of this Chapter focus on these key phenomena and their management and mitigation methods. Manufacturer sketches of the four designs present in the tables are shown in Fig. 16.

Table 6. Severe accident management in selected SMR designs. Containment phenomena.

	Core melt management	Hydrogen management	Fission product transport	Containment heat removal
NuScale	In-vessel retention	No combustible mixture of hydrogen and oxygen inside containment (vacuum)	Additional barriers: pressure vessel housing the RPV, module submerged in water (steel-lined container), biological shielding for each module, scrubbing in reactor pool	Passive heat exchangers (single-failure proof) 3 d, reactor/containment circulation 30 d, air cooling infinite
ACP100	In-vessel retention	Recombiners	Underground module	Passive decay heat removal, 3 d without operator intervention, 14 d water supply from cooling pool by gravity
ACP100+	In-vessel retention	No information available, atmosphere inert NuScale-style?	Submerged steel containment	Cooling water tank with large water inventory: Ultimate heat sink over the containment building
SMART	In-vessel retention	Recombiners		Passive decay heat removal at least 3 d, active systems being replaced by passive
mPower	In-vessel retention	Recombiners	Passive filtering	Passive heat exchangers, aim for long-term coping without off-site power

The above-mentioned direct containment heating (DCH), re-criticality and the possibility of containment bypass (release path through piping that penetrates the containment) are listed in Table 7. In this document, these phenomena are considered to be of lower priority, either due to unavailability of data or low probability of them playing a significant role in postulated accidents (or both). DCH and steam explosions can be considered unlikely if the in-vessel melt retention strategies are successful. The containment bypass (and also containment isolation failures) is more related to probabilistic risk assessment and the mechanical strength of tubing and other components, performance of filters etc. which are usually not included in the containment phenomenology. Re-criticality is, in principle, a possible but unlikely situation in a PWR, and its role in the SAM of SMRs is difficult to evaluate.

Table 7. Severe accident management in selected SMR designs. Phenomena with lower priority.

	Direct containment heating (DCH)	Re-criticality	Containment bypass	Steam explosions
NuScale	Vessel failure not likely	Not likely but has to be accounted for in licensing, similar to large PWRs	Release through secondary side less likely (helical coil SG)	Release of large amounts of melt droplets in water unlikely
ACP100			Once-through steam generator (OTSG)	
ACP100+			Same as AP100?	
SMART			Release through secondary side less likely (helical coil SG)	
mPower			(B&W OTSG)	

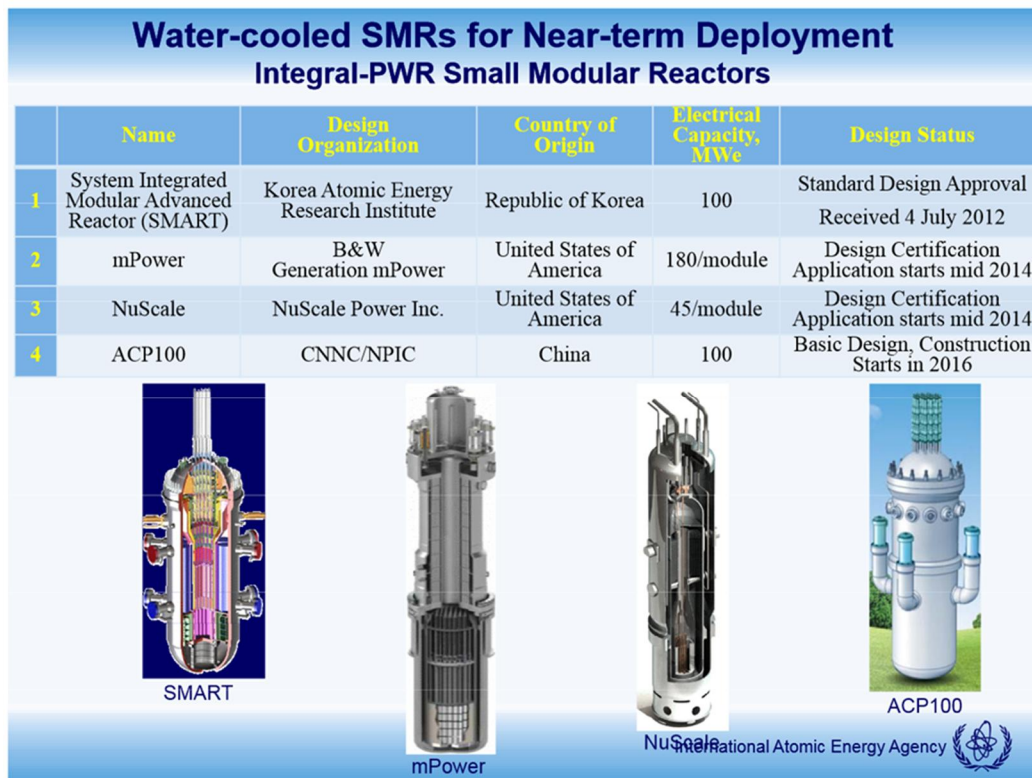

Figure 16. LWR type SMRs of the four designs present in the Tables 6 and 7.

5.4.1 The main differences from large reactors

A major difference compared to large plants in most SMRs is the integrated design of the primary circuit components and the steam generators in the reactor pressure vessel (RPV). Because the primary circulation pumps, steam generators, pressurizer and the control rod mechanism are housed inside the RPV, large penetrations and pipelines in the lower head below the level of the core are eliminated. Then, the failures associated to these structures are not possible, and the large-break LOCA accidents are inherently prevented. The designers also mentioned these features as limiting the scope of small and medium-break LOCAs [IAEA, 2009]. The integrated control rod mechanism prevents reactivity accidents by control rod ejection as there is no pressure difference that would cause such an event. The designs in Table 6 and Table 7 are integrated (sometimes named iPWR) with the exception of ACP100, which has an external pressurizer and control rod mechanisms. Thus, the possible accident sequences are somewhat different in this concept than in the fully integrated designs, ACP100 being closer to large reactors e.g. in the possibility of control rod ejection.

SMRs typically operate with thermal power below 300 MW. There are some advantages in the comparatively low power and the design features of SMR, which assist in the termination of accidents, such as passive safety systems (which operate without external power) and large coolant inventory compared to the core power. The decay heat in SMRs is lower compared to “large” plants, roughly by the same ratio as the nominal power of the plants. This is illustrated in Fig. 17, which show examples of the decay power curve for a 3200 MW and 300 MW reactors. Three days (72 h) after the accident, the SMR decay heat has dropped to about 1 MW, while the large reactor is still producing about 10 MW of heat.

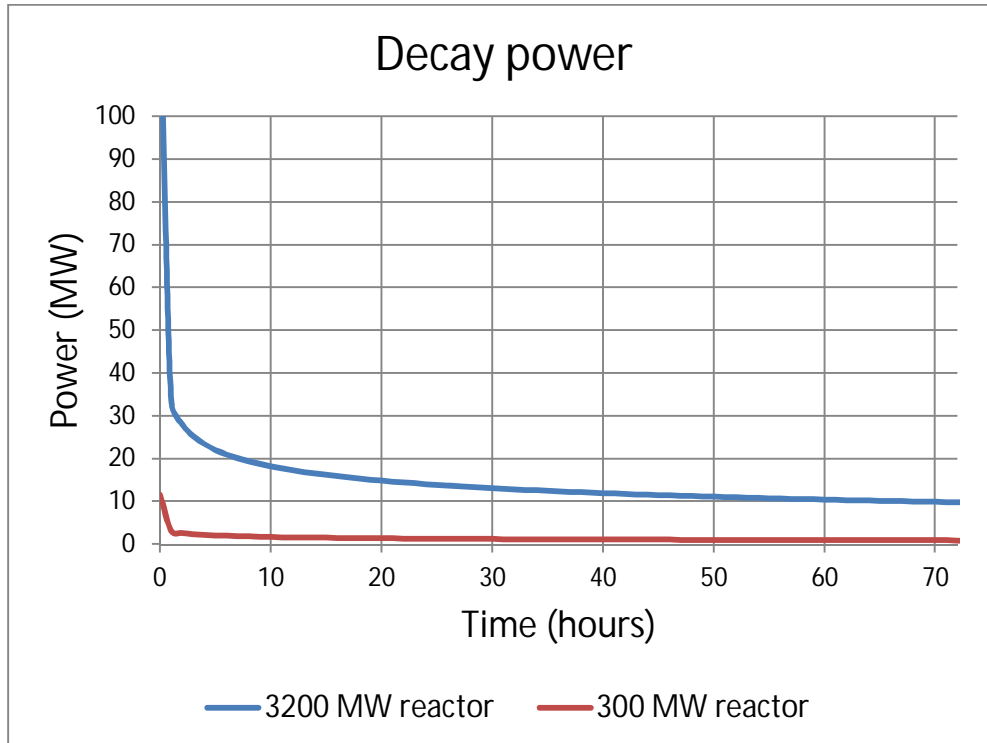

Figure 17. The decay power for 300 and 3200 MW nuclear reactors for 3 days after shutdown. Calculated using the equation by Todreas and Kazimi [Todreas, 1990] (based on [Glasstone, 1967]).

The in-vessel retention strategy is more likely to succeed with smaller decay heat. For instance, IRSN considers that the IVR strategy has been demonstrated as a reliable strategy for reactors below 600 MW electrical power, “even in the absence of water injection into the

vessel, provided that the vessel geometry and external cooling system design are suitable” [IRSN, 2015]. In Finland, the IVR strategy has received considerable attention due to the Loviisa VVER-440s relying on it in their SAM (see the review on IVR by [Asmolov et al. 2001]). All the SMR designs rely on the in-vessel retention strategy, meaning that core catchers are not provided, with the exception of the Argentinian CAREM-25 which provides for a sufficient floor space with extra layers of concrete to cool the molten corium in case some of it exits from the pressure vessel, regardless of the flooding of the reactor cavity [IAEA, 2005].

The smaller core also means that the inventory of the fission products is smaller. Similarly to the decay heat, this source term is roughly proportional to the reactor power, and the environmental consequences of a radioactive release from an SMR may be expected to be less severe than those from larger reactors. It has been suggested that this could be beneficial in terms of smaller emergency preparedness zones and reduced radiation shielding [Ingersoll, 2011]. On the other hand, the reduction of protection and emergency preparedness zones seems to be somewhat controversial, since one site can be expected to contain several SMR units, with the total source term as large as in a large power reactor. Moreover, in the aftermath of the Fukushima accident, IAEA has presented new requirements that emergency preparedness measures should be extended to cover the distance of 300 km from the plant site, which is far beyond the traditional emergency planning zone of 20 km.

The characteristics increasing the safety of SMRs compared to large reactors according to [Liu and Fan, 2012] are listed below. Mainly, they are similar to those pointed out by [Ingersoll, 2011].

- 1) “Increased relative coolant inventory. An enlarged vessel yields a larger inventory of water per unit of power than in the loop-type plant, which increases the relative thermal inertia within the reactor vessel. This results in a reduction in the rate at which the system temperature increases during a loss of forced flow transient, providing the operators with more time to respond to an upset condition.
- 2) Increased relative heat transfer area. A simple calculation could reveal that relative surface area of the iPWR vessel per unit power is increased. Roughly speaking, if a diameter of a SMR reactor core is $1/n$ of a large reactor, then the relative surface area of reactor vessel per unit power could be n times of a large reactor.
- 3) Increased passive cooling capability. The vessel height-to-diameter ratio of a SMR is 2–3 times larger than that of a large reactor since more equipments are incorporated vertically inside the vessel. This increases gravity-driven natural convection circulation capability. In the NuScale design, the natural circulation driving force is designed to be sufficiently strong to be used as a core cooling mechanism for full power operation, thus eliminating the need for pumps entirely.
- 4) Smaller radionuclide inventory. The radionuclide inventory in a reactor core is roughly proportional to power level. In addition to the intrinsically smaller radionuclide inventory of an SMR, some SMR designs add additional barriers to fission-product release to achieve a dramatically smaller accident source term.
- 5) Under-ground construction. The smaller plant footprint of an SMR makes it more economically viable to construct the primary reactor system fully below ground level, which significantly hardens it against external impacts

such as aircraft or natural disasters. As an example, the WSMR design has a containment vessel volume that is more than 23 times smaller than the Westinghouse AP-1000 containment. Below-grade construction of the reactor and containment vessels also provides the potential for additional seismic resistance and helps reduce the number of paths for fission-product release in the event of an accident.”

As challenges of the integrated design, the same authors mention the complexity of the internal components of the reactor pressure vessel: “A component inside the RPV will be more prone to affect other components compressed in the same small RPV. The radiation from reactor core will be more intensive and therefore the SMR will need a high reliability of the quality of the welding, the tube material, and the water of the secondary system. The difficulty in equipment manufacture will turn to the assembling and commissioning from forgings processing. And maintenance of such a compact structure could be more difficult.”

5.4.2 Design and phenomenon-specific considerations

Melt coolability and containment residual heat removal

The availability of information on the SMR reactors depends on the design. Of the prominent, PWR-type reactors, NuScale is relatively well documented in public literature. The concept relies largely on passive safety systems, and the primary coolant circulation under normal operation relies on natural circulation. According to [Liu and Fan 2013], each NuScale module includes two redundant passive safety systems to provide pathways for decay heat to reach the containment pool, the decay heat removal system (DHRS) and the containment heat removal system (CHRS). These systems do not require external power for actuation”. In addition, “NuScale has seven layers of barriers between fuel and environment. Besides fuel pellet and cladding, reactor vessel, and containment in conventional nuclear plants, it adds water in reactor pool, stainless steel lined concrete reactor pool, biological shield covers each reactor, and reactor building as release defense”.

The decay heat removal in NuScale is illustrated in Fig. 18. According to the manufacturer, the single-failure proof passive heat exchangers in the containment vessel provide cooling for three days while the containment pool is filled with water, after which the convective circulation and boiling in the reactor pool suffices for heat removal for 30 days. For dry reactor pool, air cooling is sufficient to remove the remaining decay heat for an infinite period [Reyes, 2012].

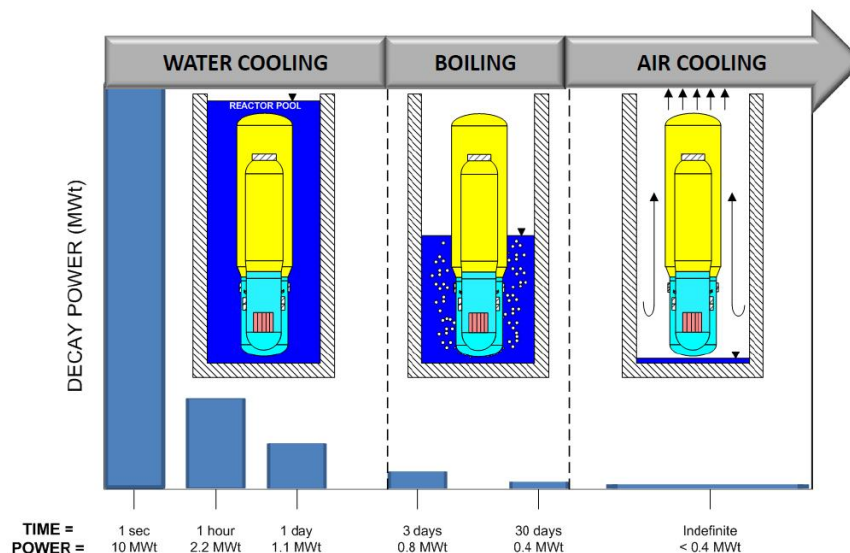

Figure 18. Residual heat removal in the NuScale design [Reyes, 2012].

The mPower SMR relies on the flooding of the containment and natural circulation for up to three days. According to Colmer (2015), after slow depressurization of the vessel, the core remains externally covered with coolant and, if the core begins to melt, the system follows an IVR strategy. The heat transfer characteristics which assist in the IVR strategy are the low thermal power rating of 530 MWt, lower total core and structure loading for melt pool formation, and an elliptical lower head geometry, which creates a flatter and more evenly distributed platform for the corium pool.

Direct containment heating (DCH)

The pressurization of the containment and DCH in the mPower design has been examined in a scoping study by Chang and Dinh (2014). A scenario in which all the safety functions aiming to prevent RPV failure fail, and some of the corium is released in the containment, was calculated using a lumped-parameter type approach. Chang and Dinh (2014) note that there are several design features that mitigate the consequences of the high-pressure melt ejection (HPME), even if the in-vessel retention fails. If the external reactor vessel cooling (ERVC) is active during the RPV breach, it provides coolant at the failure location, even though its primary function of maintaining RPV integrity fails. The absence of penetrations in the lower head and the presence of water to cool it, the likely failure location will be the in upper head of the RPV, which could lead to less risky “natural depressurization”. In the unlikely case of ERVC failing to activate (either automatically or manually), there are “three levels to mitigate the risk”:

- “The RPV lower head would be cooled by coolant due to ‘natural cavity flooding’. Given the reactor cavity located at the lower most position in the containment, condensate from the RCS coolant will collect into the cavity to provide ERVC”
- “Even when that the reactor cavity flooding level is not sufficient to cover the lower head, natural depressurization is a credible alternative that needs to be examined in detail”
- “In the event of RPV failure at the bottom area, the HPME is limited due to geometry constrains and DCH is eliminated due to limited mixing and more importantly, presence of condensate”

The containment pressure and temperature histories in the calculations are presented in Fig. 19. As a concluding remark Chang and Dinh (2014) state that their “scoping study indicates that HPME is extremely unlikely in mPower design, and in the unlikely event of HPME, its consequences can be effectively managed”.

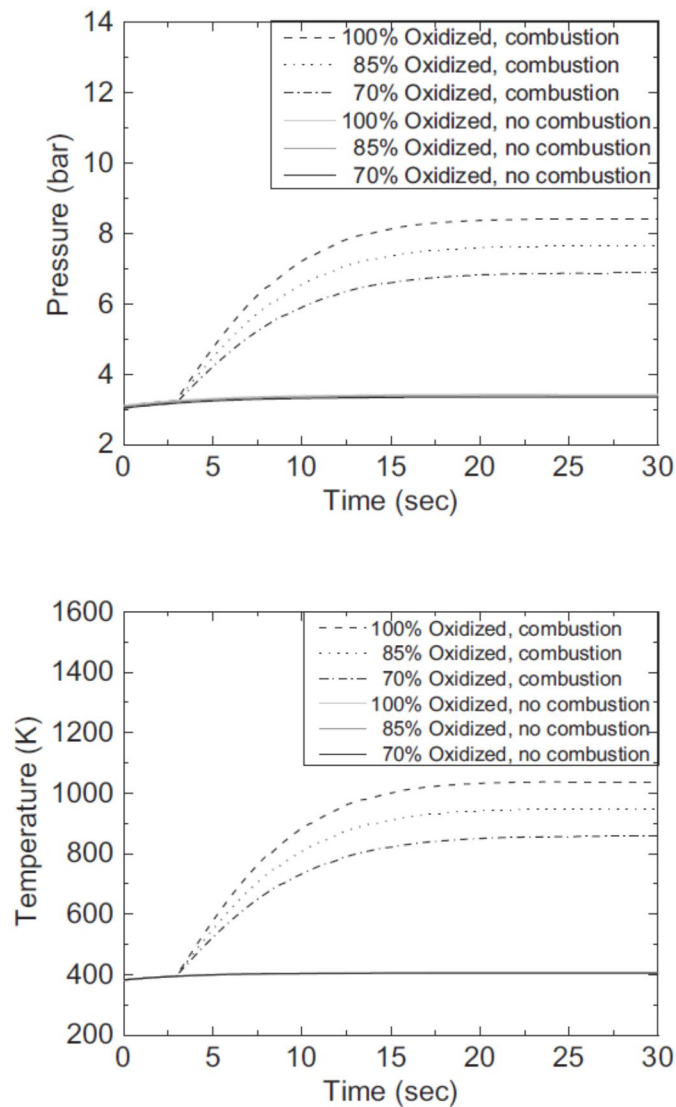

Figure 19. Containment pressure and temperature in a DCH event with varying degrees of oxidation, and with and without hydrogen combustion, no condensation of steam before HPME (PCCS failure) [Chang and Dinh, 2014].

Release through secondary side

One of the few public studies addressing the possibility of early containment failure in a SMR is found in the paper by Maioli et al. (2004). This study applied risk-informed approach to calculate the probability of large early release (LERF) frequency for the Westinghouse IRIS reactor. Westinghouse gave up the development of the IRIS design in favour of the smaller Westinghouse SMR in 2011, but the integrated design and the helical coil steam generator are a design feature common to many of the SMRs.

According to the study, the most significant differences between the large PWRs and IRIS are the absence of loop piping and the surge line, which eliminates two of the most significant paths for depressurization due to creep rupture for high-pressure sequences. The third path leading to this scenario is usually a thermally-induced steam generator tube rupture (SGTR), which causes the lifting of the secondary side safety relief valves. It is pointed out that the helical coil one-through steam generator has the primary coolant flowing on the exterior of the steam generator tubes, while the secondary flow is inside the Inconel 690 tubes. This means that the mechanical loading on the SG tubes is compression, rather

than tension, reducing the probability of creep rupture, and that the secondary side piping is designed for full primary pressure, eliminating the need for secondary side safety valves.

“Moreover, in a classical PWR, the possibility for thermally-induced tube rupture in the SG appears when the level in the vessel drops under the cold leg nozzles (i.e., when hot gases start circulating in the primary side of the SG). In IRIS, once the inventory level drops near the top of the core (i.e. under one third of the altitude of the entire vessel) the preferred steam path is expected to be the central riser rather than the annular space where the SGs are hosted. As a result of this configuration, circulation of hot gases in the SGs is expected to be dramatically reduced (some recirculation could be expected in the upper part of each SG, between RCP and the set of lower connection – shroud valves – between the riser part of the vessel and the SG primary side). Finally, the helical coil steam generator design used for IRIS evolved from similar designs developed for high-temperature gas cooled reactors, therefore the likelihood of creep described features concur in making IRIS less susceptible to creep ruptures, suggesting that this depressurization path, which leads to a direct release path, could be considered as negligible.” It is concluded that the “major differences in the SG design allow a significant reduction in the SGTR initiating event frequency and thermally-induced tube rupture; coupled with the possibility of isolation of the first part of the secondary side, this depressurization path is considered negligible.”

For hydrogen management, IRIS was planned to apply inert nitrogen atmosphere. The small size of the containment is mentioned as a drawback, since it results in a comparatively rapid pressurization in severe accident conditions. The preliminary evaluation showed that the LERF for IRIS is $6.42E^{-10}$, “around two order of magnitude lower than other advanced designs”.

Steam generator tube rupture has also been simulated in the case of the SMART reactor [Kim et al. 2013]. They make a similar conclusion of the advantage of the helical coil steam generator as Maioli et al. (2004); the probability of SGTR is lower in the case of the helical coil SG than in “commercial nuclear power plants”. In addition, Kim et al. (2013) note that even if SGTR occurs, the “actuation of the passive residual heat removal system will help to confine the radioactivity material in the secondary system because the design pressure is 17.0 MPa which is much higher than the design pressure of secondary side of commercial nuclear power plants. Moreover, there is no atmospheric dump system in SMART and the possibility of radioactivity diffusion into the atmosphere could be very low.”

The French IRSN (2015) have considered possible strategies of molten corium retention inside the reactor vessel: “Whatever the approach taken (corium in or outside the vessel), water injection and ongoing decay heat evacuation out of the containment are necessary, and the associated risks in terms of containment failure, through pressurisation or dynamic loads, must be examined.” “For reactors at or below 600 MWe, current knowledge makes it possible to adopt an in-vessel corium retention strategy, even in the absence of water injection into the vessel, provided that the vessel geometry and external cooling system design are suitable.”

At VTT, severe accident simulations are conducted by using the integral codes ASTEC and MELCOR. An example of a MELCOR model of an SMR plant is described in Fig. 20.

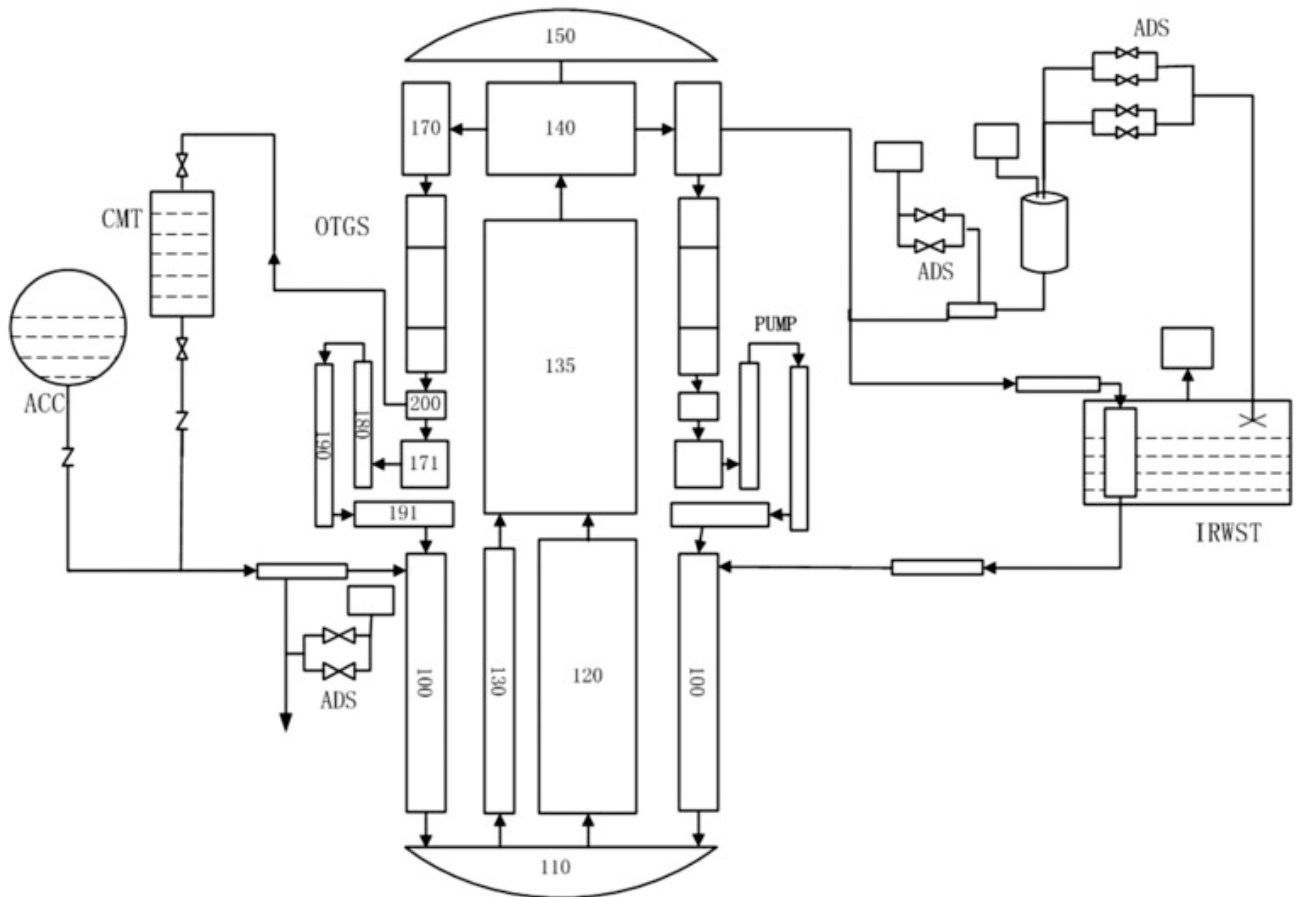

Figure 20. Example of a MELCOR nodalization for simulating a SMR. Taken from the SBO scenario calculation by [Yin et al. 2016].

5.5 Material challenges

5.5.1 Materials, welds and NDE in selected SMRs

One of the first SMRs that is already licenced and of which information concerning used materials is publicly available is Korean SMART (System-integrated Modular Advanced Reactor). SMART is the first licenced integral reactor (steam generator is inside the reactor pressure vessel) [Seo, 2013]. Construction materials of SMART are similar to the materials used in present day designs of large commercially operated LWRs, i.e., low alloy steels, austenitic stainless steels, Ni-base alloys and Zr-base alloys. For other studied SMRs, ACP100(+) and NuScale, very little information of materials is presently available in open literature. Design specific review standard (DSRS) for NuScale SMR is available already (Design Specific Review Standard for NuScale Small Modular Reactor Design, 2016), but specific construction materials are not defined or published yet. However, existing ASME codes are referred in the DSRS, so apparently the materials in the NuScale are similar to those in present day reactor designs.

Design of SMART, 330 MW_{th} PWR, started in 1997 by a conceptual phase. Basic design was completed in 2002. A design and construction project for a pilot plant, SMART-P, in 1/5 scale (65 MW_{th}) of the SMART, was started in 2002. The purpose of the SMART-P project was to demonstrate the SMART technologies and assess the overall performance and safety. The first phase focused on the design optimization and technology verification by high-temperature and high-pressure hydraulic tests, pressurizer heat transfer tests, and corrosion tests [Seo, 2013; ARIS, 2016].

Materials and chemistry of SMART-P differed somewhat from those of commercial PWRs, e.g., steam generator tubes were made of Ti-alloy, primary water was free of soluble Boron and pH was controlled with Ammonia. During normal operation H₂ concentration was in the same range as in commercial PWRs, i.e., 20-60 cc/kg(H₂O). H₂ was generated by radiolysis of ammonia. The major reason for boron-free primary water chemistry was the avoidance of Axial Offset Anomaly (AOA). AOA is a flux depression caused by boron accumulation on fuel cladding [Choi, 2005]. According to Choi et al., boron concentrates to the extent that a boron compound, most likely LiBO₂, precipitates within porous crud deposits as a result of local boiling. Three conditions must be present for AOA to occur: soluble boron, a layer of porous crud with sufficient thickness, and sufficient heat flux to cause local boiling at the fuel cladding surface.

In 2006-2007, reactor system development was continued in order to conclude the design optimization and to ascertain the economic feasibility prior to the commencement of the national R&D commercialization program. At this point, plans for the thermal power of the reactor was increased to 660 MW_{th} in order to improve the economic efficiency. After that (2009), a four year technology verification and standard design approval program was launched [ARIS, 2016]. Since the development of SMART-P, the primary circuit water chemistry and materials have been changed towards those of present day western PWRs. The reason for these changes is not clear, but is probably related to corrosion and irradiation testing results on the construction materials in the earlier design phase [Choo, 2014; Baek, 1999; Jeong, 2005]. In 2012, standard design approval (SDA) for 330 MW_{th} SMART was issued by NSCC, Nuclear safety and security commission of Korea [News on Smart, 2016].

Available material related data for the present design of SMART is listed below:

- Reactor pressure vessel: low alloy steel SA508 Grade 3, Class 1 [Kim, 2011; Park, 2011].
- Pressure vessel cladding¹: 321 SS [Park, 2005]
- Mixing head assembly and other internals¹: 304 SS (C 0.08 %wt) [Kim, 2011].
- Integrated helical SGs: SG tubes alloy 690 [Seo, 2013].
- Fuel cladding: Zircaloy 4 [ARIS, 2016].
- Fuel channel pressure tube: Zr 2.5% Nb [Seo, 2013].
- Control rod drive mechanism¹: bell bearings 440 SS, screw Incoloy 925, gear Incoloy 925 [Park, 2005].
- Highest n-dose outside the core is encountered probably by flow mixing head assembly: total dose after 60 years operation $1.9 \cdot 10^{21}$ n/cm² [Kim, 2011], translates roughly to $\sim 4 \cdot 10^{20}$ n/cm², E>0.1 MeV, i.e. ~ 0.3 dpa.
- n-dose of the RPV internal surface after 60 years is $3.8 \cdot 10^{20}$ n/cm² [Kim, 2011], translates roughly to $\sim 1 \cdot 10^{20}$ n/cm², E>0.1 MeV, i.e. 0.05-0.06 dpa; on the other hand, according to reference [Park, 2011], the vessel fluence is very low (1.1×10^{14} n/cm²).
- Soluble neutron absorber: H₃BO₃ [ARIS, 2016].
- Power: 330 MW_{th}; t inlet: 295.7°C, t outlet: 323°C; pressure: 15 Mpa; design life: 60 years [ARIS, 2016].

¹might be outdated information.

The reactor pressure vessel with its main components are shown in Fig. 21. In the list above, the material of mixing head assembly and other internals seems to be a mistake of Kim et al. (2011), because high carbon 304 stainless steel has not been used in new designs since 1980s. Since then, type 316L or 316NG has been used for recirculation piping and reactor internals in most “western” light water reactors (IAEA Nuclear Energy Series No. NP-T-3.13). Also, the RPV neutron dose estimates seem to be ambiguous. However, the difference between estimates by Kim et al. (2011) and Park (2011) may result from evaluation of the dose in different locations, i.e., internal surface vs., for example, external surface dose.

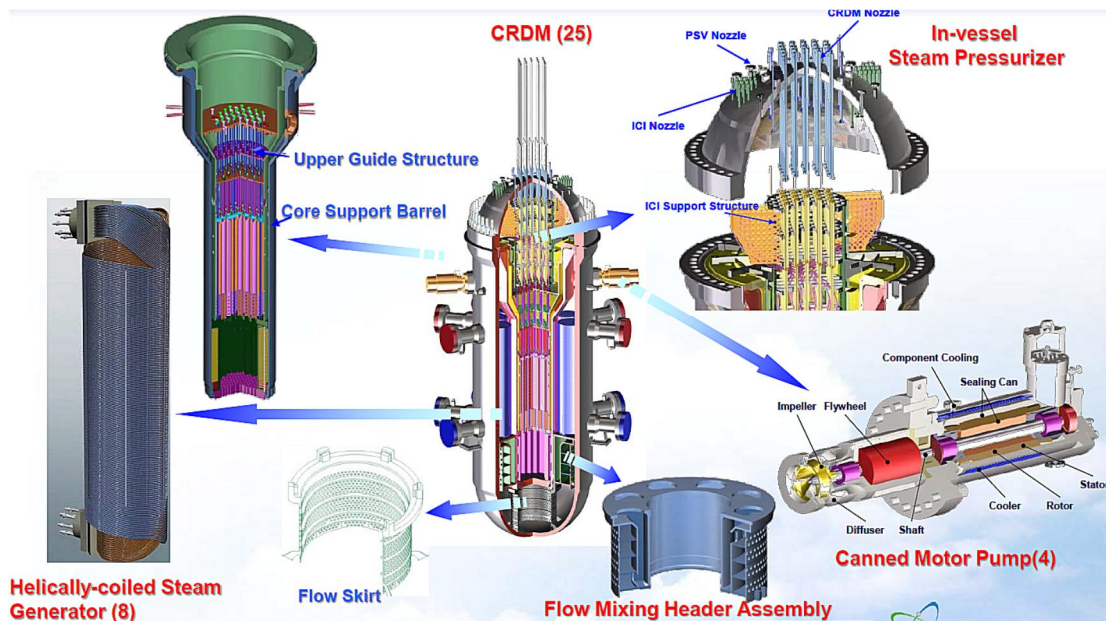

Figure 21. SMART reactor pressure vessel with its main components [Park, 2011].

With respect to welds, requirements for welding fabrication, weld integrity issues, as well as alternative joining solutions and manufacturing techniques typical of the SMR environment were searched from the literature and some potential challenges were listed in general.

A characteristic feature regarding SMRs is a high level of integration of the primary system equipment. This inevitably results in limited available space, as well as in more intense radiation inside the RPV. Consequently, operational conditions for welding become somewhat awkward, which emphasises the need for high reliability of the applied welding process and sets strict requirements for high quality of the welds [Liu, 2014]. Along with this, ensuring higher weld quality concomitantly calls for the development and implementation of advanced NDE methods, as well. A more complicated, close-spaced structure inside the RPV also sets increasing demands for the reliability and accuracy of the whole welding fabrication; an intention that can be accomplished e.g. by robotization of welding fabrication and/or using automated welding processes coupled with in-situ monitoring of welding [Liu, 2014; Wolfgang, 2013].

High-performance materials that are currently applied in the NPP components, such as nickel-base alloys, austenitic stainless steels and zirconium alloys are certainly used also in the new SMRs. In addition, however, an aspiration to the use of other advanced materials such as (i) advanced martensites, (ii) oxide-dispersion strengthened alloys (ODS), (iii) aluminides and (iv) ceramics that are either difficult, or impossible, to weld using fusion welding processes requires new alternative joining solutions, for example, solid-state processes such as friction-stir welding (FSW) and diffusion bonding, (DB) [Wolfgang, 2013]. Further, though apparently costly automation of FSW process towards the use of robotized (movable) welding head is believed to enhance the operability of the FSW process via enhanced mobility that allows various welding positions within closed-space sites. This can be expected to multiply the applications suitable for joining applying the FSW process.

Overall, trends of SMR development such as factory assembly, increased modularity and the use of small integrated parts in limited space also offer completely new possibilities to advanced alternative manufacturing techniques such as additive manufacturing (AM). This will obviously bring freedom for new SMR designs with lower associated costs. It should be pointed out, however, that an absolute prerequisite for an increasing use of these new manufacturing techniques for SMRs is a full demonstration of conformity to authority

requirements. Thus, a correspondence of mechanical properties, microstructures and material's performance of AM materials to the corresponding existing, approved wrought materials needs to be shown by relevant experimental techniques [Zinkle, 2013].

As well as new joining solutions are foreseen in the future SMRs also the non-destructive testing (NDT) procedures have to be flexible. Innovative testing and on-line monitoring devices for close-packed and complex material systems (iPWR) can be applied to verification of the material integrity. There is a new question of the relation of integrity inspections before utilization and in-service inspections with tightly packed structure of new designed SMRs. At the present NDT methods are in a key role in the Gen 2 and 3 nuclear power plants in-service inspections (ISI). This is assumed to be the case also in the SMR structures.

The questions that rises with NDT inspections:

- How to ensure the material integrity in all critical joints, welds and piping?
 - What kind of inspections for new materials are valid (Gen 4)?
 - What kind of inspections for new component and weld geometries?
- Are new type of scanners and manipulators needed to the tight places in the RPV?
- Are the nondestructive (NDT) methods used in Gen 2/3 type reactors valid also new modular reactors or are the new inspection techniques needed?
 - Could steam generator (SG) tubing inspection be done with eddy current probes?
 - Can RPV weld be inspected with ultrasonic techniques?
 - What is the method to inspect RPV lid bolt or are they even reachable for NDT testing?
- Are the components in the RPV supposed to inspect as components or RPV as whole?
 - Can parts of the module be lifted of for inspection?
- Radiation protection during NDT inspection?
- Should NDT inspection be made during outages (as in Gen2/3) or as continuous monitoring?

Also the assessment of the critical points where no inspection can be designated is important. Thinking beyond the present and defining the best vision for new type of inspections needed on the SMR environment need to start now.

An example of the NDT challenges in SMRs is SGs. Steam generators are an excellent example of the components that has distantly the same structure as in Gen 2 and 3 NPPs but are evidently smaller in size and in the free space. The structure is complex, tubes have helical shape and the SG is integrated in RPV, Fig. 22. In SMART the material for SG tubes is alloy 690, with outer diameter (OD) 17mm [Seo, 2013; Carelli, 2015]. In SMART and NuScale constructions primary circuit water is outside the tubes (In Gen 2/3 primary water is in the tubes).



Figure 22. On the left laboratory construction of the SMART Helical SG and on the right its In-service inspection tests with ET bobbin coil [Seo, 2013].

Simulation of the NDT inspection will be important part of the modular reactor inspection procedure in order to forecast the material behavior and to plan the inspection. Simulation assures that the right parts of the module will be inspected.

Additive manufacturing (AM) is still at an early stage in most application areas and which is mainly steered by large companies and technical institutes. At the moment the key emerging application areas seems to be car interior components, machine and airline parts, manufacturing moulds, implants and surgical planning tools etc. According to Nuclear AMRC, AM technology could significantly reduce lead times for major reactor components and foster the commercial viability of multiple SMR reactors [Thomas, 2016]. SMR reactor pressure vessels (RPV) might take around three years to build using conventional manufacturing but AM could reduce this to less than six months [Thomas, 2016]. In addition, advancements in AM technology are opening up more opportunities in nuclear build and design, e.g. quality assurance. AM can inspect and tailor individual layers of material, which could improve the microstructure of components being manufactured and significantly impact performance [Thomas, 2016]. Nuclear AMRC is looking at the ways to capture valuable manufacturing data at the material's microstructure level. In this way this valuable data could be compiled into formats which can be used for a variety of testing measures.

In the future of SMRs possibilities to use new advanced manufacturing techniques, e.g. AM and alternative welding & joining technologies as well as aspiration to use innovative materials, e.g., SiC/SiC composites or some other innovative solution for fuel cladding are foreseen. This results in a need to extend the present knowledge base of materials performance in reactor conditions to new materials and materials produced using new methods. Processes such as hot isostatic pressing (HIP), AM and spark plasma sintering can be used to create high-integrity, near-net shape parts from metal powder, avoiding the need to machine parts down from solid billets. These techniques are already used in industries such as aerospace, but are not yet qualified and approved for nuclear applications, although components manufactured from 316L powder by HIP are under the process to be included in ASME pressure vessel and piping codes [Gandy, 2012].

5.6 Human factors

The human factors expertise is especially needed when creating new human factors engineering program, when developing the new concept of operations and designing new human-system interface. The new design of SMR necessitates the design of new HSIs (human-system interfaces) and validation of them, especially due to higher level of automation, reduced staffing and possible on-line refuelling of separate modules and remote monitoring of operations. The concept of operations should be built so that it supports safe and effective operating of the plant, which requires the expertise of human factors.

Even if the functioning of SMR type NPP requires less human intervention in incidents and accidents, due to the passive safety systems, operators still need to be possess full situation awareness in order to be aware of the situation, understand what it means from the safety and process proceeding points of view and, still, to be able to act in an appropriate way when needed. Furthermore, SMR control room has the property of enabling the monitoring and controlling of several reactors at the same time. This is a new feature, compared to current NPPs, and it requires that the concept of operations, from the viewpoint of the tasks and responsibilities of the personnel in the control room, is designed in a new way. Consequently, the new division of work and as well as the possible types of incidents and accidents must be taken into account in the design of procedures and operator training. Thus, the human factors related activities concentrate on the planning and design phase of the new NPP but some human factors related work needs to be done also at the operational plant.

As a whole, the human factors (HF) perspective in the nuclear power plants is defined in NUREG-0711 [NUREG, 2012], Fig. 23. The document is used by the staff of the Nuclear Regulatory Commission to review the Human Factors Engineering (HFE) programs of applicants for construction permits, operating licenses, standard design certifications, combined operating licenses, and license amendments. The perspectives the document offers over human factors is applicable to any type of nuclear power plant as the focus is on human share of the functioning of the system, currently practically irrespective of technical principles the nuclear power plant is built on. The NUREG approach, also visible in the figure, also describes the relevant tasks to be done when building up a nuclear power plant. First, human factors perspective is needed when planning and analysing the future operation of the plant to be built or under construction. In the design phase, human factors related knowledge is needed as well. This phase already repeats itself at least partially for several times during the operation of the plant. The human-system interace design is going on not only in the planning or construction phase of the new plant but also whenever the interface is updated or renewed. New procedures are needed, correspondingly, not only in the beginning but whenever some new solution affecting operator work is performed. Verification and validation refers to the phase when the appropriatness of the new human-system interface is to be quaranteed. Moreover, the HF perspective is needed when the new desing is implemented. The whole chain related to design is, thus, an iterative process as long as the human-system interface goes through changes. Finally, the human performance monitoring requires HF expertise and that takes place in the phase when the plant is operational.

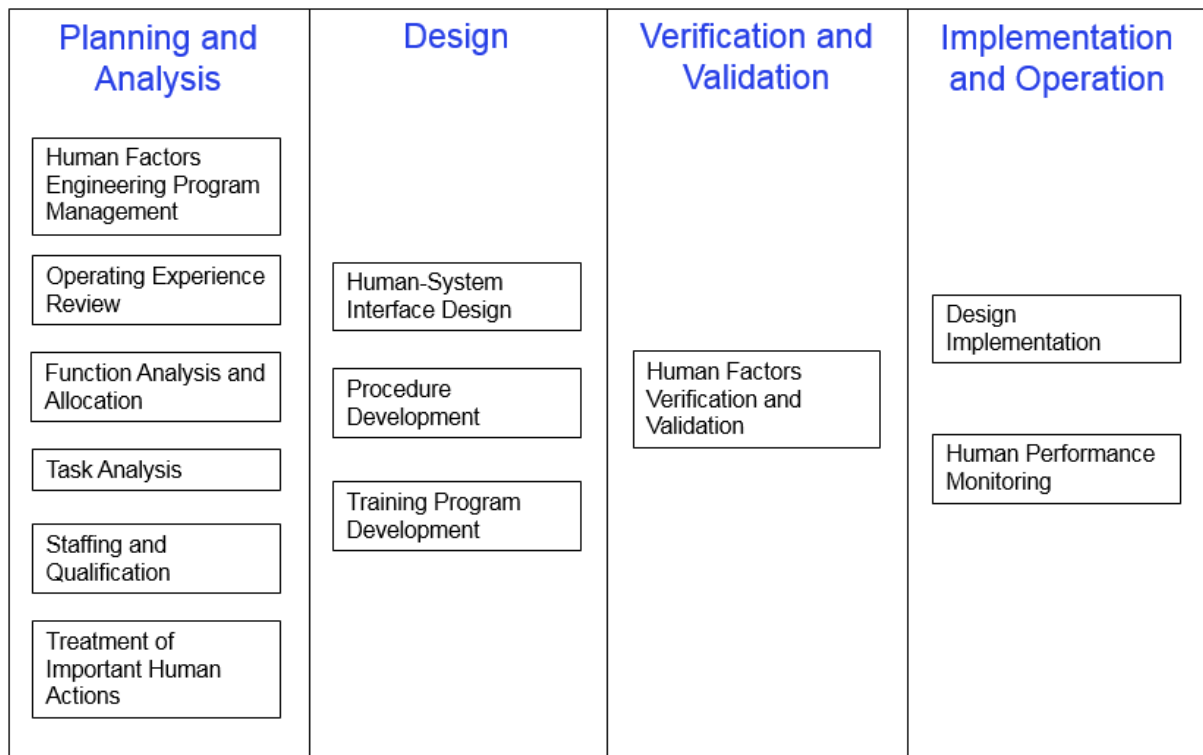

Figure 23. Elements of the HFE program's review model; redrawn from [NUREG, 2012].

Only totally autonomously running power plants would in principle be an exception to this and even then, human will be probably always needed to monitor the system, ensuring the power production and especially for supporting safety. Furthermore, the plant needs to have outages on regular basis which, in turn, requires manpower. A system as safety critical as the nuclear power plant cannot totally rely on technology but human insight is needed to prevent unexpected negative consequences of events and improbable but still possible conjunctions of events resulting in situations endangering safety.

The VTT human factors competences can be mapped in detail on the NUREG-0711 approach, Fig. 24. The main structure is the same as in the corresponding NUREG figure but the content is modified.

Human Factors Engineering Program planning and management: VTT has capability on planning the program and on supporting the management of Human Factors Engineering programs. The Human Factors process model should and will be in accordance with the existing engineering processes and HFE requirements in international standards and guidelines. The expertise also includes the evaluation of this program.

Core-Task Analysis means the clarification of the core task of various work roles, critical tasks and work demands. VTT has performed core-task analysis in various domains. In **task analysis**, tasks are described so that the critical aspects and specific features related to tasks are clarified. The analyses can be used to find the developmental needs of the of the work of the professionals and to support the development of tools to these professionals. VTT can also perform task analysis for tool development.

Safety culture analysis and development is needed when building safety culture and when evaluating the current safety culture, with the purpose of the identification of development needs, guiding the way to a more safe organisational culture. The approach is designed in VTT, called DISC model [Oedewald, 2011].

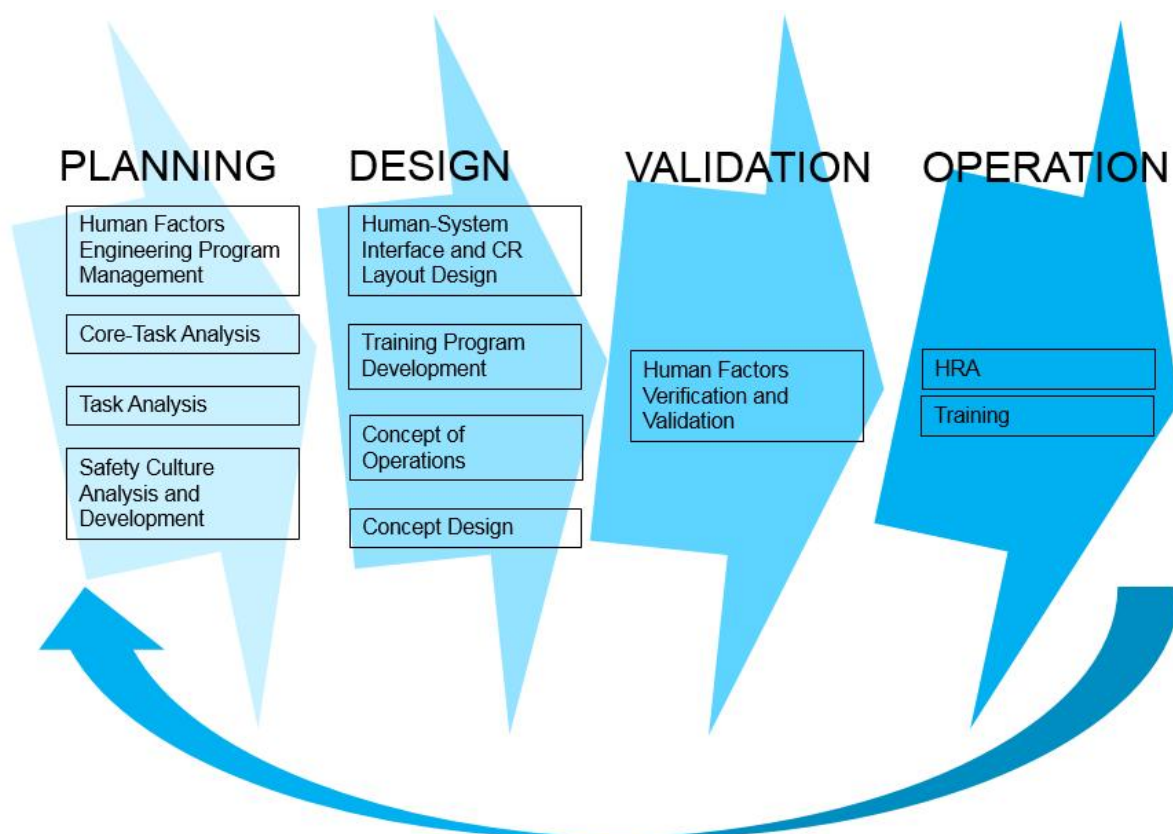

Figure 24. VT Human Factors related competences during system development.

In **Human-System Interface and Control Room Layout Design**, the usage point of view provided by VTT's HF approach can be offered as design input to the designing of the layout of the control room as well as to the design of the Human-System Interface.

Training Program Development includes the evaluation and assessment of the human workers' competence development need and the development and implementation of training programs.

Concept of Operations development means, for instance, the share of work performed by various human work roles or the sharing of work between humans and technology. Specifically, in the nuclear domain, VTT has provided justifications for the minimum level of manning for control rooms by studying the operation of plant systems performed by a minimum crew. This competence is also needed when defining the tasks to operator(s) in a control room where several reactors are monitored and controlled.

Concept Design refers to the development of new operational concept, taking into account work demands and new technology.

Human Factors control room verification and validation (V&V) means the evaluation of the control room design relative to requirements (verification) and related to the usage of the design (validation). VTT has experience in performing V&V in a stepwise manner, treating the V&V evidence in a systematic way (the so called Systems Usability Case [Laarni, 2014]). The extensive methodology used in V&V can also be used for other purposes when human performance is to be evaluated.

VTT has also experience in the **training** of professionals about the human factors perspective. The training competence includes also the evaluation of the successfulness of training.

HRA, Human Reliability Analysis, is related to risk analysis (PRA or PSA, Probability Risk or Safety Assessment) but it highly benefits from HF expertise when utilising human performance related data from various sources. VTT provides both expertise areas (HRA expertise and HF expertise).

6. VTT's near-term strategy on SMR R&D

The following section deals with the VTT future strategy in SMR research. In particular answers are sought for the following questions:

- which competences we have and what are needed in the near future, e.g. analyses to be provided
- customer needs and what possibilities we could have assisting them both nationally and internationally
- suggestions for actions

As an outcome of this project, it is strongly suggested to follow closely the international development and research effort in the field of SMRs. In the Euratom work programme, research topic NFRP-4 is on the safety of SMRs. Among European countries, France and Italy have SMR development projects (Flexblue, IRIS). Outside Europe, most SMR designs originate from Russia or the USA. Other countries active in this field of nuclear engineering include Canada, Argentina, South Africa, India, China, Korea and Japan. Still in the EU for the time being, the UK has an ambitious project to eventually build SMRs in the country. The UK government launched the initial phase of its SMR competition in March 2016. The OECD Halden Reactor Project (HRP) has identified SMRs as one of the central research topics for the period of 2018-2020 in its MTO (Man-Technology-Organization) research programme. The IAEA has some projects concerning SMR technology, like INPRO (International Project on Innovative Nuclear Reactors and Fuel Cycles) and 'Common Technologies and Issues for SMRs'.

6.1 International activities

6.1.1 Euratom NFRP-4

In the Euratom call for proposals with deadline October 5, 2016, the topic NFRP-4 considered 'the safety of small modular reactors'. Remote electricity networks and cogeneration of heat and electricity were explicitly mentioned as interesting applications. The call was justified by the fact that even if e.g. residual heat removal is inherently made easier by the smaller size of the reactor, further research is needed due to differences from large power reactors. The scope of action emphasized the following aspects:

- Compliance with the amended Euratom Safety Directive. Directive 2013/59/Euratom of 5 December 2013 will repeal (replace) several older directives in 2018. Member states must implement the directive in their legislation.
- The researchers should develop technical specifications such that fulfilling them would practically ensure the compliance of an SMR.
- SMR safety features, particularly passive ones, should be investigated.
- Develop methods to perform the safety demonstration.
- Effects of the proposed models on the licensing process of SMRs.
- Most attention should be paid to feasible / deployable SMR concepts; in practice, this means LWR technology, which is presently closest to future commercial operation in SMRs.
- Safety demonstration should include decommissioning of the plant and management of spent nuclear fuel (SNF).

VTT made a proposal called Trend-SMR (Technical and Market Requirements for European Deployment of Small Modular Reactors) in October 2016 in NFRP-4. The funding decisions will be available in late February, 2017. In addition to this, VTT is a partner in E-SMART project proposal (European Small Modular Supercritical Water Reactor Technology) where the objective is in the concept design & feasibility of a SCW-SMR type concept in terms of materials performance, thermalhydraulics and neutron physics.

In the upcoming Horizon2020 Call in 2018, the SMR topic is most probably part of Euratom's Work Programme. This should be taken into account especially in the case we receive negative funding decisions on the submitted SMR project proposal in the beginning of 2017.

6.1.2 Russian SMRs

Opposite to the western direction / EU cooperation, Russia has probably more different SMR designs than any other single country. This situation is at least partly based on the fact that Russia has a lot of experience in using nuclear power plants in both submarines and surface vessels. VTT could possibly offer some services if some of these SMRs will ever be sold to western countries, following the current situation of the first AES-2006 in the west, Hanhikivi-1 at Pyhäjoki. Cooperation could be envisaged with STUK (having good reputation internationally) or possibly with Fortum (having a lot of conventional power generation in Russia – 4.4 GW electricity & 9.9 GW heat). The following Russian LWR type SMR designs are under construction: KLT-40 (Akademik Lomonosov, floating plant by OKBM, for the eastern city of Vilyuchinsk), and RITM-200 (newer floating units). In addition to these, the only LWR type of SMR under construction is the CAREM-25 in Argentina. Furthermore, of LWR type, the ABV (floating), VK-300 and VBER-300 (floating) are in the detailed design or licensing phase in Russia.

6.1.3 Halden MTO programme

VTT has a long tradition of participation in the OECD Halden Reactor Project (HRP) in both fuels & materials (FM) and man-technology-organization (MTO) programmes. During the Halden country visit (CV) to VTT on October 5, 2016, the new proposal for the 2018-2020 joint research programme was presented. In the MTO research, new focus will be set on severe accidents, decommissioning and SMRs. As the MTO programme mainly considers e.g. human-computer interaction, user interfaces and control rooms, the focus in SMR research will presumably be in digital instrumentation and controls (I&C), high levels of automation and control room design & evaluation even for multiple SMR units at the same site. At VTT, these research areas are mainly cared for by automation researchers, like in BA1606.

6.1.4 The British SMR competition

In 2015, the UK government launched a competition whose purpose is to identify the best SMR design for the country's needs, included in a plan to invest 50 million pounds per year in a programme of nuclear research and development. According to World Nuclear News (WNA), a 'call for initial expressions of interest' was launched in March 2016. An 'SMR delivery roadmap' is also expected to be published in late 2016. Rolls-Royce has formed a consortium to develop a 7 GWe SMR fleet. Other participants in the competition are EDF-CNNC, Westinghouse and NuScale Power. The UK DECC (Department of Energy and Climate Change) has arranged a Techno-Economic Assessment (TEA) of SMRs to collect a data set on SMRs and assess their impact on the economy as well as future policy options for their deployment. According to the invitation to participate (September 7, 2015) the assessment criteria are divided in seven categories, which are general enough to seem applicable for Finland as well:

- Low cost low carbon electricity
- Ease of financing
- Economic growth
- Compatibility with existing regulation and licencing processes
- Ability to produce on a production line
- Shorter timescale for deployment
- Optimising the nuclear contribution within a balanced energy generation portfolio

6.1.5 IAEA activities in SMRs

In 2000, the IAEA established 'The international project on innovative nuclear reactors and fuel cycles' (INPRO). The purpose is to work towards sustainable energy production by nuclear power plants in the 21st century. Complementary to INPRO, the IAEA had or has currently several other programmes (Regular Budget Projects), the information on which can be found in www.iaea.org, but is reproduced here in compacted form for the reader's easy reference:

- Common issues and technologies for small and medium-sized reactors (2012-13)
- Near term & small and medium-sized reactor technology development (2014-17)
 - Technology roadmap for SMR deployments

- Technical documents on
 - Design and operations of water-cooled SMRs
 - Human factor issues of multi-module SMR stations
 - Emergency planning zone (EPZ) and physical security requirements
- E-toolkit for SMR technology assessment
- Integral water-cooled reactor simulators
- Non-electric engineered safety features
- Molten salt cooled SMRs
- Near-term water-cooled reactors and SMRs

Furthermore, the IAEA has established an SMR regulators' forum for better understanding of possible future challenges in SMR regulatory discussions. Related to the EPZ technical documents mentioned above, there will be a meeting on emergency preparedness in Vienna in February 2017 ('IAEA Technical meeting on next generation reactors and emergency preparedness and response').

6.2 VTT competence in CFD assessments

With all kinds of reactors, regardless of whether it is cooled actively by pumps or passively, and whether the core is open or consists of vertical channels, there are potential applications for 3D flow solution (CFD) in the safety analysis. In almost any reactor, the distribution of coolant in the downcomer and lower plenum can be solved for more reliably using CFD than traditional 1D system codes. If the core is open to flow in the lateral direction, as is the case with almost all PWRs, only CFD modelling can simulate the 3D flow field in the core, in order to account for its effect on fuel temperatures and assembly bowing. A clear application where CFD should bring better results than a system code is natural circulation, which is found in many SMR designs. It is used as a passive cooling system, without the use of electric pumps, which is driven by convection caused by gravity and density differences. Because the convective forces are small in comparison with pumps, bigger height differences, bigger coolant volumes and smaller resistance to flow are used in the design. The convective forces and friction coefficients depend on geometrical details and small changes in density, and so a relatively detailed simulation, only doable with CFD, is needed. The CFD simulation should be coupled with system code description of the plant circuit and a neutronics solver. VTT has competence in CFD, but a well-developed and fine-tuned application to an SMR would make it necessary to constantly maintain the competence, then direct a big enough effort into creating a fine-meshed and properly validated model of an SMR, and last but not least, have enough computing power available in order to run coupled simulations of transients with large CFD meshes.

6.3 SMR related reactor physics research at VTT

The preliminary study discussed in Sec. 5.3 showed that the high-fidelity approach based on Monte Carlo neutron transport simulation using the Serpent code can be a viable approach to reactor core analysis in the SMR scale. It should be noted, however, that the test case involved a single steady-state solution for the initial core, and extending the methodology to fuel cycle simulations (burnup coupling) and transient analysis (dynamic thermal hydraulics coupling) requires a lot of work. These issues will be addressed in a D.Sc. thesis project (Riku Tuominen) started at VTT in 2016.

It has been proposed that the entire computational framework used at VTT for reactor core safety analyses should be gradually renewed, starting from 2017. The emphasis in this effort is in the education of a new generation of experts, and securing the necessary knowledge basis and national competence in the field of reactor physics. The plan involves the development of two parallel methodologies, based on the traditional reduced-order calculation chain, and the directly-coupled high-fidelity approach, respectively. The field where these two methodologies meet is SMR core analysis, in which the computational challenges are light enough for high-fidelity methods, yet sufficiently challenging for testing and validating the traditional deterministic solvers. Reactor physics research on SMR technology is therefore expected to increase considerably within the near future.

6.4 SMR emergency planning zones (EPZs)

In the design of SMRs, the inherent safety features are emphasized in most cases. The probability of melting of the fuel is calculated to be so low that it is practically impossible. This results mainly from the smaller total power and the use of passive systems that can remove heat from the fuel without electricity and without actions from the operators. Limitation or even complete elimination of the need to prepare for off-site protective actions (mitigation of radiological consequences) has been mentioned as one of the design objectives of future NPPs. But the IAEA safety requirements in Emergency Preparedness and Response (EPR) call for taking into account also events that were not considered when designing the plant. The IAEA will arrange in Vienna in February 2017 a meeting whose objectives cover EPR and next generation NPPs: next generation design concepts and safety features & implementation of the 5th DiD (Defence in Depth) level and the IAEA safety requirements in EPR. In any case, even with a major fission product release from molten fuel, the distance of any given radiation dose level in the environment will be reduced to a fraction of that of a large power reactor, simply because of the smaller reactor core radioactive inventory. VTT has good competence in assessment of atmospheric and biospheric dispersion & the associated radiation doses, both in deterministic and probabilistic sense. The main input needed for such SMR calculations is the source term: what is the exact inventory of the specific type of reactor and what fractions of the nuclides will be released into the environment, what will be the effective release height, and also the expected temporal behaviour of release. As there are endlessly many different combinations, usually only a few different representative source terms, with significant probabilities from PSA level 2, can be calculated. With both in-house and NRC dose assessment codes, VTT can offer services in licensing safety analyses of SMRs if the compliance with dose limits has to be shown.

6.5 Advanced manufacturing & NDE of reactor components at VTT

Strategy on materials selection and manufacturing (e.g. additive manufacturing (AM)) as well as their inspectability in the near future is to widen the area of expert within the challenges they have. The gained expertise will be a key to the cooperation with the power companies that are planning to licence for SMRs as well as to manage the e.g. EU-funded projects.

In VTT the work in the field of NDE involves strong research and method development. That would be the issue also with NDE in SMRs since the components are not comparable to the Gen 2 and 3 components by their size and free space. To have reliable testing methods for the components of SMRs a method development is still needed. The knowhow of the latest NDT techniques used in the in-service inspections combined with the flexibility to develop methods towards more demanding testing is one of the strengths that can be utilised with SMR research. It is also important to have experience and ability to cooperate with the power companies that are planning to licence for SMRs.

One of the goals of NDT research in VTT in the near future is to be strong expert in the modelling of the NDT inspection in the challenging conditions. The combination of a good

modelling skills and ability to do demanding testing is one of the competences that VTT can promote the knowhow of SMRs in the near future. The combination of a good modelling skills and ability to do demanding testing is also one of the competences with which VTT can compete with other NDT companies.

AM technology could significantly reduce lead times for many components in SMRs and raise the commercial viability of multiple SMR reactors. The study on AM or 3D-printing has been in focus last years at VTT and possible applications within nuclear field will be taken into account in the upcoming projects.

6.6 Human factors considerations

Regarding VTT's human factors competences, our strength is on methodology and the existence of some references. The methodology driven offering makes VTT's human factor experts flexible and effective to work in various contexts, including different nuclear technologies. Of course, the need to follow closely the international development and research effort in the field of SMRs pertains also to the development of human factors competence. However, more references (commission work) is needed to make VTT a stronger competitor. This is, of course, a vicious or self-optimising circle; the more (or less) we have references compared to our competitors, the better (or the worse) we get commission work. Our competitors are Halden and the consulting companies which are specialized in the nuclear domain. Especially Halden (see chapter 'Halden MTO programme') competes in this area with VTT as Halden specifically constantly improves its' methodological competence. Also the NPPs themselves may win (and have won) when competing on human factors related commission work. Cooperation with Halden is one possibility which already takes place in the SAFIR programme. Cooperation in research may result in cooperation also in commission work.

On the other hand, VTT also wants to stand on its own. To better reach this goal, the core competences should be strengthened. At the moment, VTT has various types of methods to design human factors related matters in the NPPs, or to evaluate those matters as a supporting partner to local nuclear authority. The current means to strengthen the methodological capabilities are the projects in SAFIR programme, to some extent EU projects and, of course, self funded projects. Regarding the content of expertise to develop, one way to become a more prominent expert in human factors would be to strengthen our abilities in the interpretation of the acquired data in more meaningful ways. How to make more professional conclusions about the different types of data - how to evaluate the meaningfulness of data - what are the criteria upon which the data should be evaluated against. Currently, there is no organization which is specialized in these questions. VTT human factors experts have the capability to develop this type of competence.

6.7 VTT 'Lighthouses' and SMRs

VTT has recently recognized a set of five broad research topics that present a challenge for the Finnish society but also an opportunity of growth for Finnish companies and VTT, a set now called the VTT Lighthouses: Climate action, Resource sufficiency, Good life, Safety and security & Industrial renewal. SMRs would fit quite well several of these themes:

- Climate action: SMRs would help to fight climate change by reducing CO₂ emissions in many ways by replacing fossil fuels in various industrial processes.
- Resource sufficiency: Some SMR-sized advanced reactors would contribute to advanced nuclear fuel cycles and so more efficient use of uranium resources.
- Safety and security: The inherent safety features of many SMR designs would help to reach an ever higher level of nuclear safety.

- Industrial renewal: Several branches of industry would benefit from a nearby, scalable and possibly cheap supply of heat, electricity, hydrogen, desalinated water, among other commodities.

In a presentation of the 'Climate action' Lighthouse (November 24, 2016) Tulkki, Leppänen & Penttilä gave a listing of industries that now produce a significant contribution to CO₂ emissions, but could be a suitable application of SMR reactors:

- Intermittency of renewable energy sources could be balanced with SMRs by on/off switching or actual load following capability.
- Remote off-grid locations could be powered free of CO₂ by SMRs. Historically, a 1.8 MWe NPP operated at the McMurdo station in the Antarctic in 1962-1972.
- Finnish companies that act as subcontractors in NPP construction projects.
- Fertilizers industry could be supplied with H₂ and N₂ by SMR power.
- In many countries, there is not enough of cheap potable water – SMRs could power desalination plants.
- District heating in cities with SMR-produced hot water.
- Marine transportation currently runs with fossil fuels. So far, nuclear power has been used in icebreakers and military surface and submarine vessels, but only in very few commercial craft.
- Cement could be manufactured using high temperature gas from an SMR.
- In steel production, carbon is now used for both heating and reduction. This could be changed to electric heating and hydrogen-based reduction by SMRs.

6.8 Possible future opportunities for VTT

The above-mentioned international projects may bring various chances for VTT to learn from their experiences or in some cases possibly even participate in various ways. If the Trend-SMR EU application of VTT will be successful in the Euratom NFRP-4 programme, the project will bring a lot of fruitful cooperation with other research institutes and also many industrial partners. In Finland, it will be of utmost importance to follow carefully what Fortum, a big and international utility, will possibly do in the field of SMRs. Particularly Russian SMR designs might have a good chance to be built in developing countries as Rosatom is currently the NPP vendor with most ongoing projects or project plans there. This might open opportunities for VTT, because we are already assisting STUK, who have recently launched the STUK International company and have good international reputation as a regulatory body, and in Finland the licensing process of Hanhikivi Rosatom AES-2006 is currently in progress. Knowledge produced in the Halden Reactor Project could definitely improve understanding of control room issues, but would not directly bring paying customers. The IAEA projects could be of particular value to emerging nuclear energy countries, and so knowledge from them might be valuable for VTT if assisting such countries in licensing issues. The British SMR programme seems to be emphasizing their domestic participants, and may as such not provide direct opportunities for VTT, but nevertheless serve as an example of fruitful national SMR programme.

7. Conclusions

This project has introduced a new field of know-how at VTT on SMR designs and it has given a valuable insight on some challenges to overcome in order to make SMRs competitive. An essential knowledge pool was initiated in order to have readiness to estimate the licensing and techno-economic feasibilities of SMR designs in Finland and at later stage internationally. The results of the project have been used already in supporting EU applications. Close co-operation with Fortum has been initiated through the project in order to create new joint projects in Finland and to develop Finnish know-how on open issues related to overall safety of SMRs. The studies performed in 3SMR further strengthen VTT's possibilities in the international market for licensing services, developing simulation and analytical capabilities, advanced manufacturing or non-destructive testing adapted for SMR cases.

It seems that the USA is emphasizing LWR based SMRs primarily because the NRC (US Nuclear Regulatory Commission) has the most experience with licensing large LWRs, and there the SMR industry appears to be most interested in obtaining exemptions from several current rules [Sainati, 2015]. Regulatory authorities in several other countries seem to be more open to novel designs or deployment modes, e.g. Russia to lead-cooled fast reactors and floating power plants, India to thorium based heavy water reactors, and China to gas cooled high temperature reactors.

Literature reviews have been conducted regarding licensing issues, severe accident and core melt management, passive safety systems, reactor physics, human factors and material challenges. Based on this, the main observations were the following:

1. The Finnish licensing process is designed by large LWR's in mind. This makes the licencing process quite rigid and does not take into account the different design features of SMRs like modularity and multi reactor installations. But this said there is seen no reasons why SMRs could not be licensed to Finland if the Finnish demands are met, but the lack of detailed information on the SMR designs nothing sure can be said on the licensability of the SMRs. The defence-in-depth principle is the basis of the safety design of SMRs and also the foundation of the Finnish regulatory guidelines of nuclear safety. The passive decay heat removal safety systems, featured in many SMRs, are taken into account in Finnish regulations by giving them a reduced failure criterion (N+1) compared to (N+2) for active systems.
2. A review work of the use of passive safety systems in SMRs (NuScale and SMART in detail) and the role of natural circulation in SMRs, in both normal operation and safety systems, was conducted. The use of natural circulation decreases the need of possibly malfunctioning active systems, but may in turn bring some unexpected complications in thermal-hydraulic behaviour of the plant. It is possible to analyse natural circulation with system codes (mainly 1D approach), but in cases with 3D effects proper analysis may have to include CFD simulations.
3. Reactor physics: A variety of different SMRs, both thermal and fast reactors, have been designed. The focus in the literature review was on the following three LWR based SMRs: ACP100, SMART and NuScale. Data available to public was very limited and detailed core design specification were not found. The most notable difference compared to traditional LWR was the smaller size of the SMR core (number of fuel assemblies and active height of the fuel). VTT's competence in computational modelling and safety analyses is recognized worldwide. The existing calculation tools, such as Apros and Serpent, can be readily applied to SMR-scale simulations. An interesting direction for future work is the application of high-fidelity computational methods for core physics calculations. Coupled Monte Carlo

neutronics / thermal hydraulics calculations, which are computationally too expensive to be applied to full-scale LWR cores, may become a viable option in the SMR scale.

4. Even with inherent safety features, severe accidents cannot be neglected. In Finland, no new-build nuclear power plant is acceptable without a feasible strategy for managing severe accidents (STUK YVL 2.2, old, and B.3 Deterministic Safety Analyses & B.6 Containment, new). A review work of SMR severe accident scenarios and management was conducted. Differences from large power reactors include integrated RPVs, lower power levels and smaller reactor core radioactive inventories. Melt coolability and containment heat removal, among other topics, were described in the review. Study on this topic further supports the possibilities at VTT in the international market for developing simulation and analytical capabilities.
5. Material challenges: Lot of technical details are missing in order to make any deeper analyses on the critical challenges in intergrated PWRs in terms of material challenges. It is expected that most of the material selections are congruent with current Gen 2 and 3 plants. New manufacturing technologies (like additive manufacturing (AM) and hot isostatic pressing), joining methods and advanced materials are foreseen in future SMRs which is interesting in R&D point of view and could bring some added value also for our Finnish stakeholders in long term. It is expected that AM technology could significantly reduce lead times for many components in SMRs and raise the commercial viability of multiple SMR reactors, e.g. in the case of reactor pressure vessels (RPV). Manufacturing of RPV by using conventional techniques might take around three years but it is envisaged that AM could reduce this to less than six months. It is evident that research is needed in order to confirm the quality of AM reactor materials. At the moment research is focused on the quality of LWR materials in USA such as stainless steel and Inconel.
6. In terms of Human factors the core competences should be strengthened. At the moment, VTT has various types of methods to design human factors related matters in the NPPs, or to evaluate those matters as a supporting partner to local nuclear authority. One way to become a more prominent expert in human factors would be to strengthen our abilities in the interpretation of the acquired data in more meaningful ways. How to make more professional conclusions about the different types of data - how to evaluate the meaningfulness of data - what are the criteria upon which the data should be evaluated against. Currently, there is no organization which is specialized in these questions. VTT human factors experts have the capability to develop this type of competence.

8. Summary

The objective of the SASUNE 3SMR project was to identify the open issues of Small Modular Reactors (SMR) and analyse which possibilities VTT could have assisting customers concerning SMRs nationally and internationally. Literature reviews have been conducted regarding licensing issues, severe accident and core melt management, passive safety systems, human factors and challenges in complex material structures inside RPV.

In Finland, no new-build plant is acceptable without a feasible strategy for managing severe accidents (STUK YVL 2.2). A review of SMR severe accident scenarios and management was written. Differences from large power reactors include integrated RPVs, lower power levels and smaller reactor core radioactive inventories. Melt coolability and containment heat removal, among other topics, were described in the review. Study on this topic further supports the possibilities at VTT in the international market for developing simulation and analytical capabilities.

A review of the use of passive safety systems in SMRs and the role of natural circulation in SMRs, in both normal operation and safety systems, was written. The use of natural circulation decreases the need of possibly malfunctioning active systems, but may in turn bring some unexpected complications in thermal-hydraulic behaviour of the plant. Proper analysis may have to include CFD simulations.

Calculation models for Serpent and COSY were created for a mock-up NuScale core, based on data available to public. Using these models a coupled steady state test calculation with neutronics and one phase thermal hydraulics was run successfully. These calculations can be considered a proof-of-concept for the established high-fidelity computational scheme. The work on computational modeling of SMR's using Serpent is continued as part of a PhD project. Development of a new computational framework for core physics calculations is to be started in 2017. SMR-scale models are planned to be used as the first test cases for new nodal diffusion solvers and other tools and methods developed as part of this framework.

Based on the literature review most of the material challenges of LWR type SMRs are common to those of existing Gen II and III reactors. It is evident that integrated PWRs will introduce some challenges since the structures inside the RPV become more complicated as all primary system equipment, e.g. steam generators, control rod drive mechanisms (e.g. in SMART) etc., are integrated into one single vessel. It was also mentioned that the radiation from reactor core could be more intensive against components inside RPV but preliminary results showed that this is not always true (e.g. SMART). However, if this is the case in other reactor designs, it is sure that the need for high quality welds, tube materials and the water chemistry control of the primary system will be essential. In addition, components inside the RPV will be more prone to affect other components in the same small space. It is also expected that the smaller size and different geometries of components of LWR type SMRs compared to big nuclear reactors may also bring new challenges with manufacturing techniques and inspection cases. In this context, possibilities to new advanced manufacturing techniques, e.g. additive manufacturing (AM) or 3-D printing and alternative joining technologies as well as aspiration to use of innovative materials are foreseen. This will further increase the need to extend the knowledge base in the field of materials technologies at VTT. Innovative laboratory and on-line monitoring device development for close-packed and complex material systems (like in iPWRs), e.g. new welding and non-destructive testing (NDT) equipment and procedures, will increase knowledge in these topics. The gathered new knowledge can be used in other projects and customer assignments in the future.

Human factors expertise is especially needed when creating new human factors engineering program, when developing the new concept of operations and designing new human-system interface. The new design of SMR necessitates the design of new HSIs (human-system interfaces) and validation of them, especially due to higher level of automation, reduced staffing and possible on-line refuelling of separate modules and remote monitoring of operations. The concept of operations should be built so that it supports safe and effective operating of the plant, which requires the expertise of human factors. The human factors related activities concentrate on the planning and design phase of the new NPP but some human factors related work needs to be done also at the operational plant.

This project has introduced a new field of know-how on SMR designs at VTT. An essential knowledge pool was initiated in order to have readiness to estimate the licensing and techno-economic feasibilities of SMR designs in Finland and at later stage internationally. The end results of the project will be used to answer above-mentioned issues and in supporting EU projects. Close co-operation with Fortum has been initiated through the project in order to create new joint projects and to develop know-how on open issues related to overall safety of SMRs.

References

Arda, S.E., Holbert, K.E., *A dynamic model of a passively cooled small modular reactor for controller design purposes*, *Nuclear Engineering and Design* 289 (2015) 218–230

Arda, S.E., Holbert, K.E., *Nonlinear dynamic modeling and simulation of a passively cooled small modular reactor*, *Progress in Nuclear Energy* 91 (2016) 116-131

^aARIS, IAEA ARIS data base, NuScale Design Description, <https://aris.iaea.org/sites/IPWR.html>, Accessed on 5 December, 2016.

^bARIS, IAEA ARIS data base, status report 77 - System-Integrated Modular Advanced Reactor (SMART), <https://aris.iaea.org/sites/..PDF\SMART.pdf>. Accessed on 30 November, 2016.

Asmolov, V., Ponomarev-Stepnoy, N.N., Strizhov, V., and Sehgal, B.R., *Challenges left in the area of in-vessel melt retention*, *Nuclear Engineering and Design*, Volume 209, Issues 1–3, November 2001, Pages 87-96, ISSN 0029-5493, [http://dx.doi.org/10.1016/S0029-5493\(01\)00391-0](http://dx.doi.org/10.1016/S0029-5493(01)00391-0).

Baek, J.H., Lee, M.H., Choi, B.S., Kim, J.P., Jung, Y.H., Lee, D.J., 1999, *Corrosion behaviors of SMART materials in the ammonia atmosphere*, Korean Nuclear Society, fall 1999 conference, [http://www.kns.org/kns_files/kns/file/46\(%B9%E9%C1%BE%C7%F5\).pdf](http://www.kns.org/kns_files/kns/file/46(%B9%E9%C1%BE%C7%F5).pdf).

Basu, D.N., Patil, N.D., Bhattacharyya, S., Das, P.K., *Hydrodynamics of a natural circulation loop in a scaled-down steamdrum-riser-downcomer assembly*, *Nuclear Engineering and Design* 265 (2013) 411– 423

Butt, H.N., Ilyas, M., Ahmad, M., Aydogan, F., *Assessment of passive safety system of a Small Modular Reactor (SMR)*, *Annals of Nuclear Energy* 98 (2016) 191–199

Carelli, M.D., Ingersoll, D.T., Ed., 2015, *Handbook of Small Modular Nuclear Reactors*, Woodhead Publishing, 2015.

Chang, C., Dinh, N. (2014). *A scoping study of direct containment heating in a small modular reactor*. *Transactions of the American Nuclear Society*, Vol. 111, Anaheim, California, November 9–13, 2014.

Cho, J., Shin, Y-H, Hwang, I., S., *Power maximization method for land-transportable fully passive lead–bismuth cooled small modular reactor systems*, *Nuclear Engineering and Design* 289 (2015) 240–251

Choi, B-S., Kim, A-Y., Kim, S-H., Yoon, J., and Zee, S-Q., *Design Criteria of Primary Coolant Chemistry in SMART-P*, 2005
http://www.kns.org/kns_files/kns/file/594%C3%D6%BA%B4%BC%B1.pdf.

Choo, K.N., Cho, M.S., Lee, C.Y., Yang, S.W., Park, S.J., 2014, *Contribution of Hanaro Irradiation Facilities to National Nuclear R&D*, *Nuclear Engineering and Technology*, 46 (2014)

Chun J-H., Chung B-D., Lee G-H., Bae K-H., Kim Y-I., Chung Y-J., Kim K-K. *Safety evaluation of small-break LOCA with various locations and sizes for SMART adopting fully passive safety systems using MARS code*. *Nuclear Engineering and Design*, volume 277 (2014), 138-145.

Chung Y.J., Kim H.J., Chung B.D., Lee W.J., Kim M.H. *Thermo-hydraulic characteristics of the helically coiled tube and the condensate heat exchanger for SMART*. *Annals of Nuclear Energy*, volume 55 (2013), 49-54.

Colmer, W.D.L. 2015. *Development of Vessel Lower Head Heat Transfer Analysis Capability for Evaluation of In-Vessel Retention Thermal Margin*. Master of Science thesis, North Carolina State University, Raleigh, 2015.

Design Specific Review Standard for NuScale Small Modular Reactor Design, 2016, <http://www.nrc.gov/docs/ML1535/ML15355A295.html>

Gandy, D.W., Shingledecker, J. Siefert, J., 2012, *Overcoming Barriers for Using PM/HIP Technology to Manufacture Large Power Generation Components*, *Advanced Materials & Processes*, ASM International, 2012.

Ge, J., Wang, C., Xiao, Y., Tian, W., Qiu, S., Su, G.H., Zhang, D., Wu, Y., *Thermal-hydraulic analysis of a fluoride-salt-cooled pebble-bed reactor with CFD methodology*, *Progress in Nuclear Energy* 91 (2016) 83-96

Glasstone, S. and Sesonske, A., *Nuclear Reactor Engineering*, Van Nostrand Reinhold, 1967, 2nd edition.

Guo, Z., Zweibaum, N., Shao, M., Huddar, L.R., Peterson, P.F., Qiu, S., *Development of the FHR advanced natural circulation analysis code and application to FHR safety analysis*, *Progress in Nuclear Energy* 91 (2016) 56-67

Haskins, D.A., El-Genk, M.S., *Natural circulation thermal-hydraulics model and analyses of "SLIMM" – A small modular reactor*, *Annals of Nuclear Energy* 101 (2017) 516–527

Hewitt, G.F. *Gas-liquid flow*, *Thermopedia 2011, Gas-Liquid Flow*, DOI: 10.1615/AtoZ.gas-liquid_flow, Accessed on December 19, 2016.

Horelik, N., Herman, B., Forget, B., and Smith, K., *Benchmark for Evaluation and Validation of Reactor Simulations (BEAVRS), v1.0.1*. *Proc. Int. Conf. Mathematics and Computational Methods Applied to Nuc. Sci. & Eng.*, 2013. Sun Valley, Idaho

Hummel, D.W., *Source Term Evaluation for Advanced Small Modular Reactor Concepts*, 4th International Technical Meeting on Small Reactors (ITMSR-4) Delta Ottawa City Centre Hotel Ottawa, Ontario, Canada, 2016 November 2-4

Hänninen, H. (editor), Kiesi, T. (editor), Kiesi, T., Lindqvist, S., Leskelä, E., Lindroos, V., Pohja, R., Rantanen, V., Salenius, E., Sarikka, T., *Materials Science and Technology - Nuclear Materials, Advanced Course - Kon-67.5100 Postgraduate Seminar on Engineering Materials - Seminar papers 8 October, 2015, pages 79 - 96*.

IAEA Nuclear Energy Series No. NP—T-3.13, *Stress Corrosion Cracking in Light Water Reactors: Good Practices and Lessons Learned*, http://www-pub.iaea.org/MTCD/Publications/PDF/P1522_web.pdf.

IAEA, *Natural circulation in water cooled nuclear power plants. Phenomena, models, and methodology for system reliability assessments*, IAEA-TECDOC-1474, 2005

IAEA. 2005. *Status of innovative small and medium sized reactor designs 2005*. IAEA-TECDOC-1485.

IAEA, *Passive Safety Systems and Natural Circulation in Water Cooled Nuclear Power Plants*, IAEA-TECDOC-1624, 2009

IAEA Nuclear Energy Series Technical Reports. 2009. Design Features to Achieve Defence in Depth in Small and Medium Sized Reactors. No. NP-T-2.2.

IAEA, Natural Circulation Phenomena and Modelling for Advanced Water Cooled Reactors, IAEA-TECDOC-1677, 2012

IAEA Safety Standards Series No. GSR Part 7. (Draft) Preparedness and response for a nuclear or radiological emergency, General Safety Requirements. International Atomic Energy Agency. Vienna, 2015.

IAEA, Advances in Small Modular Reactor Technology Developments. A Supplement to: IAEA Advanced Reactors Information System (ARIS), 2016 Edition

Ingersoll, D.T., Deliberately small reactors and the second nuclear era, Progress in Nuclear Energy 51 (2009) 589–603

Ingersoll, D.T. 2011. Passive Safety Features for Small Modular Reactors. In: International Seminar on Nuclear War and Planetary Emergencies - 43rd Session (edited by R. Ragaini). World Scientific, 8.6.2011. Pp. 113-121.

IRSN. 2015. Considerations concerning the strategy of corium retention in the reactor vessel.

Ishii, M., Shi, S., Yang, W.S., Wu, Z., Rassame, S., Liu, Y., Novel modular natural circulation BWR design and safety evaluation, Annals of Nuclear Energy 85 (2015) 220–227

Jeong, Y.H., Park, S.Y., Baek, J.H., Choi, B.K., Park, J.Y., Lee, M.H., Kim, J.H., Bang, J.G., 2005, Evaluation of Corrosion Characteristics of SMART Materials (III), KAERI Report KAERI/CR-234/2005.

Karmakar, A., Dey, R., Paruya, S., Effect of local phenomena on subcooled boiling oscillations in natural circulation boiling loop, Nuclear Engineering and Design 310 (2016) 205–216

Kim, K-Y., Kim, H-Y., Rho, G-H., Sohn, D-S., 2011, Preliminary Estimation of Long-lived Activation Products in the Reactor Structures of SMART, Progress in Nuclear Science and Technology 1 (2011).

Kim J.W., Choi J.S., Kim Y.I., Chung Y.J., PARK G.C. Experimental Study of Thermal Mixing in Flow Mixing Header Assembly of SMART. Nuclear Technology, volume 177 (March 2012), 336-351.

Kim H.K., Kim S.H., Chung Y.J., Kim H.S. Thermal-hydraulic analysis of SMART steam generator tube rupture using TASS/SMR-S code. Annals of Nuclear Energy, volume 55 (2013), 331-340.

Kim K.K., Lee W., Choi S., Kim H.R., Ha J. SMART: The First Licensed Advanced Integral Reactor. Journal of Energy and Power Engineering, volume 8 (2014), 94-102.

Kim Y.S., Bae S.W., Cho S., Kang K.H., Park H.S. Application of direct passive residual heat removal system to the SMART reactor. Annals of Nuclear Energy, volume 89 (March 2016), 56-62.

Kollar, L., "Small Modular Reactors Offer Option for Near-Term Nuclear Power Deployment (IAEA Department of Nuclear Energy)," 16 September 2015,

<https://www.iaea.org/newscenter/news/small-modularreactors-offer-option-near-term-nuclear-power-deployment>. Accessed 16 September 2016.

Koshy, T. *Global Trends, Prospects and Challenges for Innovative SMRs Deployment*. Presentation to Nuclear Power Engineering Committee, IAEA, July 2013.

Laarni, J., Savioja, P., Norros, L., Liinasuo, M., Karvonen, H., Wahlström, M., Salo, L. 2014. *Conducting multistage HFE validations - constructing Systems Usability Case*. ISOFIG/ISSNP 2014, Jeju, Korea, august 24-28, 2014.

Leppänen, J., Hovi, V., Ikonen, T., Kurki, J., Pusa, M., Valtavirta, V. and Viitanen, T. *The Numerical Multi-Physics project (NUMPS) at VTT Technical Research Centre of Finland*. *Ann. Nucl. Energy*, 84 (2015) 55-62

Linik, L., Thomas, G., Bellanger, P., Harné, R. and Matthews, B. *Codes and Methods Applicability Topical Report, NuScale Power, 2015*

Liu, Z., Fan, J., 2014, *Technology readiness assessment of Small Modular Reactor (SMR) designs*, *Progress in Nuclear Energy*, Vol. 70, pp. 20-28 (2014).

Luitjens, J., Wu, Q., Greenwood, S., Corradini, M., *Mechanistic CHF modeling for natural circulation applications in SMR*, *Nuclear Engineering and Design xxx (2016) xxx-xxx (Article in Press)*

Lyman, E. 2013. *Small Isn't Always Beautiful. Safety, Security, and Cost Concerns about Small Modular Reactors*. Union of Concerned Scientists.

Lokhov, A., and Sozoniuk, V., *Small Modular Reactors: Nuclear Energy Market Potential for Near-term Deployment*, OECD 2016 NEA No. 7213, <https://www.oecd-nea.org/ndd/pubs/2016/7213-smrs.pdf>, Accessed November 1, 2016

Maioli, A., Finnicum, D.J., & Kumagai, Y. 2004. *IRIS Simplified LERF Model (INIS-US--0498)*. Americas Nuclear Energy Symposium (ANES 2004); Miami, FL (United States); 3-6 Oct 2004.

Marcel, C.P., Furci, H.F., Delmastro, D.F., Masson, V.P., *Phenomenology involved in self-pressurized, natural circulation, low thermo-dynamic quality, nuclear reactors: The thermal-hydraulics of the CAREM-25 reactor*, *Nuclear Engineering and Design* 254 (2013) 218– 227

Marcel, C.P., Acuna, F.M., Zanocco, P.G., Delmastro, D.F., *Stability of self-pressurized, natural circulation, low thermo-dynamic quality, nuclear reactors: The stability performance of the CAREM-25 reactor*, *Nuclear Engineering and Design* 265 (2013) 232– 243

Martelli, D., Forgione, N., Barone, G., di Piazza, I., *Coupled simulations of the NACIE facility using RELAP5 and ANSYS FLUENT codes*, *Annals of Nuclear Energy* 101 (2017) 408–418

Mazzi, R., "CAREM: An Innovative Integrated PWR," in *18th International Conference on Structural Mechanics in Reactor Technology (SMiRT 18)*, Beijing, China, 2005.

Modro, S.M, et. al., 2013, *Multi-Application of Small Light Water Reactor – Final Report*, Idaho National Engineering and Environmental Laboratory, Idaho, USA (December 2013).

News on Smart, 2016, http://www.smart-nuclear.com/news/n_smart.php

NuScale Power. *NuScale Plant Design Overview, 2014*

Nuclear Energy Insider, “Areva to supply SMR fuel; US’ Vogtle gains permit; China eyes 110 reactors, December 5th, 2015”, <http://analysis.nuclearenergyinsider.com/areva-supply-smr-fuel-us-vogtle-gainspermit-china-eyes-110-reactors>. Accessed 2 October 2016.

NUREG-0711, Rev.3. Prepared by J.M. O’Hara, J.C. Higgins, S.A. Fleger, P.A. Pieringer. 2012. Human Factors Engineering Program Review Model. NRC Job Code N6765.

OECD NEA. 2011. *Current Status, Technical Feasibility and Economics of Small Nuclear Reactors*. Nuclear Development, June 2011.

Oedewald, P., Pietikäinen, E., Reiman, T. 2011. *A guidebook for evaluating organisations in the nuclear industry - an example of safety culture evaluation*. SSM. Available at: <http://www.stralsakerhetsmyndigheten.se/Global/Publikationer/Rapport/Sakerhet-vid-karnkraftverken/2011/SSM-Rapport-2011-20.pdf>

Park, K.B., 2011, SMART, An Early Deployable Integral Reactor for Multi-purpose Applications, INPRO Dialogue Forum on Nuclear Energy Innovations: CUC for Small & Medium-sized Nuclear Power Reactors, 10-14 October 2011, Vienna, Austria. Available at: https://www.iaea.org/INPRO/3rd_Dialogue_Forum/08.Park.pdf

Progress of SMR ACP100 Series. UK in SMR; SMR in UK (2014). <http://www.nuclearinst.com/write/MediaUploads/CNNC.pdf>.

Ramana, M.V., Hopkins, L.B., Glaser, A., *Licensing small modular reactors*, *Energy* 61 (2013) 555-564

^aReyes J. N., NuScale website, <http://www.nuscalepower.com/>, 2012, Accessed on 5 December, 2016

^bReyes J., NuScale Plant Response to Extreme Events. *Nuclear Technology*, volume 178 (May 2012).

Rowinski, M.K., White, T.J., and Zhao, J., “Small and Medium Sized Reactors(SMR): A Review of Technology,” *Renewable and Sustainable Energy Reviews*, volume 44, pp. 643-656, 2015.

Sainati, T., Locatelli, G., Brookes, N., “Small Modular Reactors: Licensing constraints and the way forward, *Energy*”, Volume 82, 15th March 2015, Pages 1092-1095.

Seo, J-T., 2013, *Small and Modular Reactor Development, Safety and Licensing in Korea*, IAEA TWG-LWR, Vienna, June 18-20, 2013.

Sharma, M., Vijayan, P.K., Pilkhwal, D.S., Asako, Y., *Steady state and stability characteristics of natural circulation loops operating with carbon dioxide at supercritical pressures for open and closed loop boundary conditions*, *Nuclear Engineering and Design* 265 (2013) 737– 754

Shi, S., Hibiki, T., Ishii, M., *Startup instability in natural circulation driven nuclear reactors*, *Progress in Nuclear Energy* 90 (2016) 140-150

Shi, S., Ishii, M., *Modeling of flashing-induced flow instabilities for a natural circulation driven novel modular reactor*, *Annals of Nuclear Energy* 101 (2017) 215–225

Shin, Y-H, Choi, S., Cho, J., Kim, J.H., Hwang, I.S., *Advanced passive design of small modular reactor cooled by heavy liquid metal natural circulation*, *Progress in Nuclear Energy* 83 (2015) 433-442

Stacey, K., *Special Report: Modern Energy, Small modular reactors are nuclear energy's future, Scaled-down plants offer price gains over conventional sites, Financial Times, July 26, 2016* <https://www.ft.com/content/bcffe4d2-2402-11e6-9d4d-c11776a5124d>, Accessed on 22 November, 2016

Subki, H. and Reitsma, F., *Advances in Small Modular Reactor Technology Developments. A Supplement to: IAEA Advanced Reactors Information System (ARIS), Vienna, Austria: International Atomic Energy Agency, 2014.* www.iaea.org/NuclearPower/SMR/, Accessed October 2, 2016

Sun, L., Peng, M., Xia, G., Lv, X., and Li, R., *Numerical Study on coolant Flow Distribution at the Core Inlet for an Integral Pressurized Water Reactor, Nuclear Engineering and Technology xxx (2 0 1 6) 1e1 1 (Article in press)*

Surina J. *NuScale Technology & Economic Overview. Powerpoint presentation (Aug 2015).* https://www.iaea.org/NuclearPower/Downloadable/Meetings/2015/2015-08-25-08-28-NPTDS/DAY2/1._NuScale_Power_SMR_-_Simple,_Safe,_Economic.pdf.

Sjövall, H., 2010, "Feasibility studies and bidding process", Presented at: Workshop on experience from construction and regulatory oversight of Nuclear Power Plants, Helsinki/Olkiluoto, 30 Aug - 3 Sep 2010.

Söderholm, K. *Licensing Model Development for Small Modular Reactors (SMRs)- Focusing on the Finnish Regulatory Framework. Acta Universitatis Lappeenrantaensis, 2013.*

Söderholm, K., *The new Nuclear option, A renaissance is at hand: Smaller nuclear reactors could soon come to an industrial site near you, The chemical Engineer, Page 22-25, 2015*

Talabi, S., and Fischbeck, P., *Establishing right-sized SMR-specific emergency planning zones, 4th International Technical Meeting on Small Reactors (ITMSR-4) Delta Ottawa City Centre Hotel Ottawa, Ontario, Canada, 2016, November 2-4*

Thomas, K., *Nuclear Energy Insider, 3D printers could slash SMR lead times from years to months, November 29, 2016, http://analysis.nuclearenergyinsider.com/3d-printers-could-slash-smr-lead-times-years-months?utm_campaign=NEI+14DEC16+Newsletter+A&utm_medium=email&utm_source=Elouqua&elqTrackId=788286bc8c2048158e910f3c7ef06832&elq=12f45aef29de4d128bd05a0f6772f76d&elqaid=24206&elqat=1&elqCampaignId=10982, Accessed on 15 December, 2016.*

Tiippana, P. *Licensing Process in Finland. CNRA International Workshop on "New Reactor Siting, Licensing and Construction Experience" Hosted by the State Office for Nuclear Safety, Prague, Czech Republic, 15-17 September 2010.*

Todreas, N.E. and Kazimi, M.S., *Nuclear Systems I, Thermal Hydraulic Fundamentals, Hemisphere Publishing Corporation, 1990, ISBN 0-89116-935-0 (v. 1).*

TVO, *Olkiluoto 3, http://www.tvoy.fi/OL3_3, Accessed on 12 December, 2016.*

Vijayan, P.K. and Nayak, A.K., *Joint ICTP-IAEA Course on Natural Circulation Phenomena and Passive Safety Systems in Advanced Water Cooled Reactors, 17-21 May 2010*

Vujic, J., Bergmann, R.M., Skoda, R., Miletic, M., *Small modular reactors: Simpler, safer, cheaper?, Energy 45 (2012) 288-295*

Waddington, G., NNL (2014), "Small Modular Reactors (SMR): Feasibility Study", www.nnl.co.uk/media/1627/smr-feasibility-study-december-2014.pdf. Accessed on 3 October, 2016.

WENRA. 2013. *Report: Safety of new NPP designs, Study by Reactor Harmonization Working Group RHWG*. March 2013.

Wolfgang, H., 2013, *Materials for Nuclear Plants, From Safe Design to Residual Life Assessments*, London, Springer (2013).

World Nuclear Association, "Small Nuclear Power Reactors (updated Sept 2016)," <http://www.world-nuclear.org/information-library/nuclear-fuel-cycle/nuclear-power-reactors/small-nuclear-power-reactors.aspx>. Accessed 16 October, 2016.

Xia, G.L., Su, G.H., Peng, M.J., *Analysis of natural circulation operational characteristics for integrated pressurized water reactor*, *Annals of Nuclear Energy* 92 (2016) 304–311

Yin, S., Zhang, Y., Tian, W., Qiu, S., Su, G.H., Gao, X. *Simulation of the small modular reactor severe accident scenario response to SBO using MELCOR code*. *Progress in Nuclear Energy*, Volume 86, January 2016, Pages 87-96, ISSN 0149-1970, <http://dx.doi.org/10.1016/j.pnucene.2015.10.007>.
(<http://www.sciencedirect.com/science/article/pii/S0149197015300871>)

Zhao, P., Li, S., Chen, Z., Zheng, J., Chen, H., *Natural circulation characteristics analysis of a small modular natural circulation lead-bismuth eutectic cooled fast reactor*, *Progress in Nuclear Energy* 83 (2015) 220-228

Zinkle, S.J, Was, G.S, 2013, *Materials Challenges in Nuclear Energy*, *Acta Materialia*, Vol. 61, pp. 735-758 (2013).