



International Energy Agency

Indoor Air Quality Design and Control in Low-Energy Residential Buildings (EBC Annex 68)

**Subtask 4: Current challenges, selected case studies
and innovative solutions covering indoor air quality,
ventilation design and control in residences**

AIVC Contributed Report 19
October 2020



Cover photograph: Sustain Solutions A/S, Copenhagen, Denmark

Photograph on side 93: Gabriel Rojas

Photograph on side 123: Gabriel Rojas

International Energy Agency

Indoor Air Quality Design and Control in Low-Energy Residential Buildings

**Subtask 4: Current challenges, selected case studies
and innovative solutions covering indoor air quality,
ventilation design and control in residences**

AIVC Contributed Report 19

October 2020

Editors

Jakub Kolarik, Technical University of Denmark, Denmark (jakol@byg.dtu.dk)

Gabriel Rojas-Kopeinig, Salzburg University of Applied Sciences, Austria and University of Innsbruck, Unit for Energy Efficient Building, Austria (gabriel.rojas@fh-salzburg.ac.at)

Co-Editors

Carsten Rode, Technical University of Denmark, Denmark (car@byg.dtu.dk)

Daria Zukowska, Technical University of Denmark, Denmark (dz@byg.dtu.dk)

Esfand Burman, University College London (esfand.burman@ucl.ac.uk)

Guangyu Cao, Norwegian University of Science and Technology, Norway (guangyu.cao@ntnu.no)

Kevin Smith, Technical University of Denmark, Denmark (kevs@byg.dtu.dk)

Reviewed by

Arnold Janssens, Ghent University, Belgium (arnold.janssens@ugent.be)

Meli Stylianou, CanmetENERGY, Canada (meli.stylianou@canada.ca)

Michael Donn, Victoria University of Wellington (michael.donn@vuw.ac.nz)

© Copyright the Technical University of Denmark 2020

All property rights, including copyright, are vested in the Technical University of Denmark, Operating Agent for EBC Annex 68, on behalf of the Contracting Parties of the International Energy Agency (IEA) Implementing Agreement for a Programme of Research and Development on Energy in Buildings and Communities (EBC). In particular, no part of this publication may be reproduced, stored in a retrieval system or transmitted in any form or by any means, electronic, mechanical, photocopying, recording or otherwise, without the prior written permission of the Technical University of Denmark.

Published by INIVE EEIG , Lozenberg 7, B-1932 Sint-Stevens-Woluwe, Belgium.

Disclaimer Notice: This publication has been compiled with reasonable skill and care. However, neither the Technical University of Denmark, nor the Contracting Parties of the International Energy Agency's Implementing Agreement for a Programme of Research and Development on Energy in Buildings and Communities, nor their agents, make any representation as to the adequacy or accuracy of the information contained herein, or as to its suitability for any particular application, and accept no responsibility or liability arising out of the use of this publication. The information contained herein does not supersede the requirements given in any national codes, regulations or standards, and should not be regarded as a substitute for the need to obtain specific professional advice for any particular application. EBC is a Technology Collaboration Programme (TCP) of the IEA. Views, findings and publications of the EBC TCP do not necessarily represent the views or policies of the IEA Secretariat or of all its individual member countries.

ISBN 2-930471-58-7

EAN 9782930471587

Participating countries in the EBC TCP: Australia, Austria, Belgium, Brazil, Canada, P.R. China, Czech Republic, Denmark, Finland, France, Germany, Ireland, Italy, Japan, Republic of Korea, the Netherlands, New Zealand, Norway, Portugal, Singapore, Spain, Sweden, Switzerland, Turkey, United Kingdom and the United States of America.

Additional copies of this report may be obtained from: EBC Executive Committee Support Services Unit (ESSU), C/o AECOM Ltd, The Colmore Building, Colmore Circus Queensway, Birmingham B4 6AT, United Kingdom
www.iea-ebc.org
essu@iea-ebc.org

Preface

The International Energy Agency

The International Energy Agency (IEA) was established in 1974 within the framework of the Organisation for Economic Co-operation and Development (OECD) to implement an international energy programme. A basic aim of the IEA is to foster international co-operation among the 30 IEA participating countries and to increase energy security through energy research, development and demonstration in the fields of technologies for energy efficiency and renewable energy sources.

The IEA Energy in Buildings and Communities Programme

The IEA co-ordinates international energy research and development (R&D) activities through a comprehensive portfolio of Technology Collaboration Programmes (TCPs). The mission of the IEA Energy in Buildings and Communities (IEA EBC) TCP is to support the acceleration of the transformation of the built environment towards more energy efficient and sustainable buildings and communities, by the development and dissemination of knowledge, technologies and processes and other solutions through international collaborative research and open innovation. (Until 2013, the IEA EBC Programme was known as the IEA Energy Conservation in Buildings and Community Systems Programme, ECBCS.)

The high priority research themes in the EBC Strategic Plan 2019-2024 are based on research drivers, national programmes within the EBC participating countries, the Future Buildings Forum (FBF) Think Tank Workshop held in Singapore in October 2017 and a Strategy Planning Workshop held at the EBC Executive Committee Meeting in November 2017. The research themes represent a collective input of the Executive Committee members and Operating Agents to exploit technological and other opportunities to save energy in the buildings sector, and to remove technical obstacles to market penetration of new energy technologies, systems and processes. Future EBC collaborative research and innovation work should have its focus on these themes.

At the Strategy Planning Workshop in 2017, some 40 research themes were developed. From those 40 themes, 10 themes of special high priority have been extracted, taking into consideration a score that was given to each theme at the workshop. The 10 high priority themes can be separated in two types namely 'Objectives' and 'Means'. These two groups are distinguished for a better understanding of the different themes.

Objectives - The strategic objectives of the EBC TCP are as follows:

- reinforcing the technical and economic basis for refurbishment of existing buildings, including financing, engagement of stakeholders and promotion of co-benefits;
- improvement of planning, construction and management processes to reduce the performance gap between design stage assessments and real-world operation;
- the creation of 'low tech', robust and affordable technologies;
- the further development of energy efficient cooling in hot and humid, or dry climates, avoiding mechanical cooling if possible;

- the creation of holistic solution sets for district level systems taking into account energy grids, overall performance, business models, engagement of stakeholders, and transport energy system implications.

Means - The strategic objectives of the EBC TCP will be achieved by the means listed below:

- the creation of tools for supporting design and construction through to operations and maintenance, including building energy standards and life cycle analysis (LCA);
- benefitting from 'living labs' to provide experience of and overcome barriers to adoption of energy efficiency measures;
- improving smart control of building services technical installations, including occupant and operator interfaces;
- addressing data issues in buildings, including non-intrusive and secure data collection;
- the development of building information modelling (BIM) as a game changer, from design and construction through to operations and maintenance.

The themes in both groups can be the subject for new Annexes, but what distinguishes them is that the 'objectives' themes are final goals or solutions (or part of) for an energy efficient built environment, while the 'means' themes are instruments or enablers to reach such a goal. These themes are explained in more detail in the EBC Strategic Plan 2019-2024.

The Executive Committee

Overall control of the IEA EBC Programme is maintained by an Executive Committee, which not only monitors existing projects, but also identifies new strategic areas in which collaborative efforts may be beneficial. As the Programme is based on a contract with the IEA, the projects are legally established as Annexes to the IEA EBC Implementing Agreement. At the present time, the following projects have been initiated by the IEA EBC Executive Committee, with completed projects identified by (*) and joint projects with the IEA Solar Heating and Cooling Technology Collaboration Programme by (☼):

- Annex 1: Load Energy Determination of Buildings (*)
- Annex 2: Ekistics and Advanced Community Energy Systems (*)
- Annex 3: Energy Conservation in Residential Buildings (*)
- Annex 4: Glasgow Commercial Building Monitoring (*)
- Annex 5: Air Infiltration and Ventilation Centre
- Annex 6: Energy Systems and Design of Communities (*)
- Annex 7: Local Government Energy Planning (*)
- Annex 8: Inhabitants Behaviour with Regard to Ventilation (*)
- Annex 9: Minimum Ventilation Rates (*)
- Annex 10: Building HVAC System Simulation (*)
- Annex 11: Energy Auditing (*)
- Annex 12: Windows and Fenestration (*)
- Annex 13: Energy Management in Hospitals (*)

- Annex 14: Condensation and Energy (*)
- Annex 15: Energy Efficiency in Schools (*)
- Annex 16: BEMS 1- User Interfaces and System Integration (*)
- Annex 17: BEMS 2- Evaluation and Emulation Techniques (*)
- Annex 18: Demand Controlled Ventilation Systems (*)
- Annex 19: Low Slope Roof Systems (*)
- Annex 20: Air Flow Patterns within Buildings (*)
- Annex 21: Thermal Modelling (*)
- Annex 22: Energy Efficient Communities (*)
- Annex 23: Multi Zone Air Flow Modelling (COMIS) (*)
- Annex 24: Heat, Air and Moisture Transfer in Envelopes (*)
- Annex 25: Real time HVAC Simulation (*)
- Annex 26: Energy Efficient Ventilation of Large Enclosures (*)
- Annex 27: Evaluation and Demonstration of Domestic Ventilation Systems (*)
- Annex 28: Low Energy Cooling Systems (*)
- Annex 29: ☀ Daylight in Buildings (*)
- Annex 30: Bringing Simulation to Application (*)
- Annex 31: Energy-Related Environmental Impact of Buildings (*)
- Annex 32: Integral Building Envelope Performance Assessment (*)
- Annex 33: Advanced Local Energy Planning (*)
- Annex 34: Computer-Aided Evaluation of HVAC System Performance (*)
- Annex 35: Design of Energy Efficient Hybrid Ventilation (HYBVENT) (*)
- Annex 36: Retrofitting of Educational Buildings (*)
- Annex 37: Low Exergy Systems for Heating and Cooling of Buildings (LowEx) (*)
- Annex 38: ☀ Solar Sustainable Housing (*)
- Annex 39: High Performance Insulation Systems (*)
- Annex 40: Building Commissioning to Improve Energy Performance (*)
- Annex 41: Whole Building Heat, Air and Moisture Response (MOIST-ENG) (*)
- Annex 42: The Simulation of Building-Integrated Fuel Cell and Other Cogeneration Systems (FC+COGEN-SIM) (*)
- Annex 43: ☀ Testing and Validation of Building Energy Simulation Tools (*)
- Annex 44: Integrating Environmentally Responsive Elements in Buildings (*)
- Annex 45: Energy Efficient Electric Lighting for Buildings (*)

- Annex 46: Holistic Assessment Tool-kit on Energy Efficient Retrofit Measures for Government Buildings (EnERGo) (*)
- Annex 47: Cost-Effective Commissioning for Existing and Low Energy Buildings (*)
- Annex 48: Heat Pumping and Reversible Air Conditioning (*)
- Annex 49: Low Exergy Systems for High Performance Buildings and Communities (*)
- Annex 50: Prefabricated Systems for Low Energy Renovation of Residential Buildings (*)
- Annex 51: Energy Efficient Communities (*)
- Annex 52: ☀ Towards Net Zero Energy Solar Buildings (*)
- Annex 53: Total Energy Use in Buildings: Analysis and Evaluation Methods (*)
- Annex 54: Integration of Micro-Generation and Related Energy Technologies in Buildings (*)
- Annex 55: Reliability of Energy Efficient Building Retrofitting - Probability Assessment of Performance and Cost (RAP-RETRO) (*)
- Annex 56: Cost Effective Energy and CO2 Emissions Optimization in Building Renovation (*)
- Annex 57: Evaluation of Embodied Energy and CO2 Equivalent Emissions for Building Construction (*)
- Annex 58: Reliable Building Energy Performance Characterisation Based on Full Scale Dynamic Measurements (*)
- Annex 59: High Temperature Cooling and Low Temperature Heating in Buildings (*)
- Annex 60: New Generation Computational Tools for Building and Community Energy Systems (*)
- Annex 61: Business and Technical Concepts for Deep Energy Retrofit of Public Buildings (*)
- Annex 62: Ventilative Cooling (*)
- Annex 63: Implementation of Energy Strategies in Communities (*)
- Annex 64: LowEx Communities - Optimised Performance of Energy Supply Systems with Exergy Principles (*)
- Annex 65: Long-Term Performance of Super-Insulating Materials in Building Components and Systems (*)
- Annex 66: Definition and Simulation of Occupant Behavior in Buildings (*)
- Annex 67: Energy Flexible Buildings (*)
- Annex 68: Indoor Air Quality Design and Control in Low Energy Residential Buildings
- Annex 69: Strategy and Practice of Adaptive Thermal Comfort in Low Energy Buildings
- Annex 70: Energy Epidemiology: Analysis of Real Building Energy Use at Scale
- Annex 71: Building Energy Performance Assessment Based on In-situ Measurements
- Annex 72: Assessing Life Cycle Related Environmental Impacts Caused by Buildings
- Annex 73: Towards Net Zero Energy Resilient Public Communities
- Annex 74: Competition and Living Lab Platform
- Annex 75: Cost-effective Building Renovation at District Level Combining Energy Efficiency and Renewables

- Annex 76: ☀ Deep Renovation of Historic Buildings Towards Lowest Possible Energy Demand and CO₂ Emissions
- Annex 77: ☀ Integrated Solutions for Daylight and Electric Lighting
- Annex 78: Supplementing Ventilation with Gas-phase Air Cleaning, Implementation and Energy Implications
- Annex 79: Occupant-Centric Building Design and Operation
- Annex 80: Resilient Cooling
- Annex 81: Data-Driven Smart Buildings
- Annex 82: Energy Flexible Buildings Towards Resilient Low Carbon Energy Systems
- Annex 83: Positive Energy Districts
- Annex 84: Demand Management of Buildings in Thermal Networks
- Annex 85: Indirect Evaporative Cooling
- Annex 86: Energy Efficient Indoor Air Quality Management in Residential Buildings

Working Group - Energy Efficiency in Educational Buildings (*)

Working Group - Indicators of Energy Efficiency in Cold Climate Buildings (*)

Working Group - Annex 36 Extension: The Energy Concept Adviser (*)

Working Group - HVAC Energy Calculation Methodologies for Non-residential Buildings

Working Group - Cities and Communities

Working Group - Building Energy Codes

Summary

The objective of Subtask 4 in the IEA EBC Annex 68 was to integrate knowledge and results from remaining Subtasks and present them in the context with current knowledge. The focus of the Subtask 4 was on practitioners dealing with ensuring high Indoor Air Quality (IAQ) in modern low-energy residences, the demands and challenges they meet during daily work. This especially includes architects and ventilation designers, facility managers, property developers and employees of public authorities. This publication is a result of Subtask 4's work. It brings a collection of 24 "case studies" related to IAQ design and control in Low-Energy Residential Buildings. By a "case study" we mean a real life construction project, laboratory investigation or a simulation study that provides innovative approach. The case studies were selected to give the practitioners new insights, inspiration and motivation to go along new paths leading to sustainable and comfortable homes of the future. The report is organized into three main chapters: "Ways to design residential ventilation in the future" and "Towards better performance and user satisfaction". The descriptions of case studies are accompanied by "lessons learned" sections aiming directly at practical utilization of results as well as recommended future reading section providing the most important references.

Table of contents

1	Introduction	10
1.1	About IEA EBC Annex 68	11
1.2	About Subtask 4 and this report	12
2	How do we design residential ventilation today? What are current challenges?	16
2.1	Review of national requirements and guidelines	16
2.2	Stakeholder survey	20
2.3	Further reading	26
2.4	References	26
3	Ways to design residential ventilation in the future	29
3.1	Alternative ducting options for balanced mechanical ventilation systems in multifamily housing	29
3.2	Ambient air filtration in highly energy efficient dwellings with mechanical ventilation	33
3.3	Development of a compact ventilation system for facade integration	37
3.4	Volatile Organic Compounds (VOC) exposure due to Floor heating systems versus Radiator heating	40
3.5	Control strategies for mechanical ventilation in Danish low-energy apartment buildings	43
3.6	Response of commercially available Metal Oxide Semiconductor Sensors under air polluting activities typical for residences	47
3.7	Impact of multi zone air leakage modelling on ventilation performance and indoor air quality assessment in low-energy houses	51
3.8	Towards a better integration of indoor air quality and health issues in low-energy dwellings: Development of a performance-based approach for ventilation (PhD thesis)	54
3.9	List of key pollutants for design and operation of ventilation in low-energy housing	58
3.10	Definition of a Reference Residential Building Prototype for Evaluating Indoor Air Quality and Energy Efficiency Strategies	61
3.11	Temperature dependent emissions of Volatile Organic Compounds from building materials	66
3.12	Detailed modelling of Indoor Air Quality to improve ventilation design in low energy houses	69
3.13	Mechanical ventilation system in deep energy renovation of a multi-story building with prefabricated modular panels	71
3.14	Simplifying Mechanical Ventilation with Heat Recovery systems: Assessing the extended cascade ventilation and active overflow concept	76

3.15	Design of room-based ventilation systems in renovated apartments	80
3.16	Introduction to the Coupled Heat, Air, Moisture and Pollutant Simulation (CHAMPS) modeling platform	84
4	Towards better performance and user satisfaction	94
4.1	House owners' experience and satisfaction with Danish Low-energy houses - focus on ventilation	94
4.2	Development and test of quality management approach for ventilation and indoor air quality in single-family buildings	99
4.3	Applications of the Promevent Protocol for ventilation systems inspection in French regulation and certification programs	102
4.4	Long-term durability of humidity-based demand-controlled ventilation: results of a ten years monitoring in residential buildings	105
4.5	Practical use of the Annex 68 Indoor Air Quality Dashboard	108
4.6	Performance evaluation of Mechanical Extract Ventilation (MEV) systems in three 'low-energy' dwellings in the UK	113
4.7	Indoor air quality in low energy dwellings: performance evaluation of two apartment blocks in East London, UK	116
4.8	Continuous-commissioning of ventilation units in multi-family dwellings using controller data	119
5	Conclusions and outlook	124
5.1	References	127
6	Acknowledgments	128
7	Contributors	129

1 Introduction

“Low-energy buildings” or maybe more precisely “highly energy efficient buildings” have been designed, constructed and researched for almost half a century. In the beginning, the buildings were erected for the purpose of demonstration and research, as pilot projects and case studies. Nowadays, energy efficient buildings are an everyday reality in architectural & design firms, at building sites, but also in the lives of ordinary people. We are constructing most of our current buildings as what we have been calling “low-energy buildings” over the past decades. Additionally, many existing buildings are renovated to get close to a low-energy standard.

This not only relates to offices or public buildings, as residential buildings also follow some sort of low-energy standard. It is now well known that low-energy buildings have some common characteristics. They are very airtight and typically have mechanical ventilation, enabling heat recovery. They are highly insulated and equipped with high performance glazing. They are equipped with several technical systems that ensure good indoor environmental quality. These usually include heating, solar shading and perhaps cooling systems. In the case that the aforementioned features are not designed properly, they bring along challenges, which were not known during the “pre-low-energy building” era. Namely, high airtightness without sufficient ventilation provisions can be associated with low indoor air quality (IAQ), i.e. high levels of gaseous and particulate pollutants in the indoor air.

Insufficient ventilation can also lead to increased levels of air humidity, resulting in an increased prevalence of house dust-mites and in some cases higher risk of mold growth contained within or on building materials. Pollutants in the indoor environment can originate from ambient and indoor sources. Building materials emit and absorb certain chemical compounds and humidity. The emissions from building materials and furniture and other inventory can be effectively eliminated using “source control”. This means careful selections of materials during both construction and furnishing. Labeling schemes exist in several European countries that support selection of non-polluting materials.

Occupants and occupant activities, such as cooking, cleaning or washing clothes, also generate air contaminants and humidity. It is well proven that properly designed, installed and operated ventilation systems can deal with these challenges and provide good IAQ. However, many buildings suffer from poorly designed and incorrectly installed and commissioned technical installations. In offices and public buildings, the facility management usually takes care of faults, but in residences, the malfunction often remains undiscovered for a long time. This leads to increased energy use, but maybe most importantly, to worsening of the indoor environment. It has been shown in many scientific studies that low-IAQ affects not only the human comfort through lower perceived air quality but also the occupant’s health through irritation of mucous membranes, sleepiness, headaches or sore throats, etc. Pollutants that are present in the indoor air can have both acute and chronic effects and can lead to serious health problems like allergies and asthma, diseases of cardiovascular systems and cancer. The fact that most people spend 80-90% of their time indoors pronounces the importance of ensuring high IAQ in buildings.

Energy efficiency and healthy indoor environment may seem to be contradictory goals, but many building projects around the world have shown the opposite. Namely, that it is possible to both build energy efficient buildings and provide excellent indoor environmental quality. National standards and various guidelines are available to support the proper design of mechanical ventilation systems (see Chapter 2.1) to help ensure high

IAQ. However, within a survey (see Chapter 2.2) stakeholders also report problems and barriers encountered during design, installation, commissioning or during operation of mechanical ventilation systems. For example, issues addressing the design process, duct routing, high capital costs, poor installation or commissioning practices and lack of maintenance have been reported in the survey. Many completed and ongoing research projects have investigated or are investigating these issues and possible solutions. Their results are presented and discussed at scientific conferences around the world. Dozens of papers in peer reviewed journals are published every year on the subject. A small portion of these results are finding their way to those that need it most, i.e. practitioners that design, build and operate our buildings. This report's main aim is to help keep practitioners updated about recent findings, trends and applications. The work of IEA EBC Annex 68 included a broad range of topics related to IAQ in low energy residences. The subtasks focused on the definition of IAQ metrics, characterization of pollution loads and their dependency on thermal and moisture conditions as well as on tools for numerical modeling or practical case studies. The aim of this report is to strengthen the connection between theory and practice by presenting examples of potential solutions to the challenges of ensuring high IAQ in future residences. All this should be understandable for practitioners, i.e. different stakeholders that in their daily work deal with IAQ in residences. The present report offers a brief guided tour through the results of projects, conducted as a part of particular subtasks, complemented with examples of other relevant case-studies and research projects that address the current state of the art in design and operation of systems that provide high IAQ in residences.

1.1 About IEA EBC Annex 68

The overall objective of the IEA EBC Annex 68 was to provide a useful scientific basis for optimal and practically applicable design and control strategies for better Indoor Air Quality (IAQ) in residential buildings. These strategies were intended to ensure minimal possible energy use. Consequently, IEA EBC Annex 68 was focused on low-energy residential buildings.

There exist numerous national definitions and concepts describing low-energy. Some, for example focus on the renewable energy production on-site and not only discuss the reduction of energy use. All definitions have in common that a low-energy building should achieve better or significantly better energy performance compared to a traditional contemporary building practice to reduce the use of fossil fuels, such as oil, gas and coal. In some countries or regions, low-energy buildings are defined by the building codes or in relation to the energy standard. A building, which can be classified as low-energy in one country may use more energy than a standard building from another neighboring country. In addition, over time, standards have improved and what were low-energy standards some years ago may be standard today. In the present project, a building is considered as a low-energy building when it has a better energy performance than the typical new building following the minimum standards defined in building regulations at a given time and country.

The aim of IEA EBC Annex 68 was to gather the existing data and provide new data on pollution sources in buildings, to model the indoor hygrothermal conditions, air quality and thermal systems, and to find the methods to optimize ventilation and air-conditioning.

The work of the IEA EBC Annex 68 was organized into five subtasks (Figure 1-1): **Subtask 1** was focused on setting up the metrics to assess the performance of low-energy buildings with regards to indoor air quality, combining the aspirations to achieve very high energy performance without compromising indoor environmental quality. **Subtask 2** gathered the existing knowledge and provided new data about indoor air

pollutants in relation to combined heat, air and moisture transfer. **Subtask 3** identified and developed modelling tools that can assist designers and managers of buildings in accounting for IAQ. **Subtask 4** focused on integrating knowledge from previous subtasks with the existing state of the art for both research and practice. **Subtask 5** conducted field measurements to examine and optimize different control and design strategies.

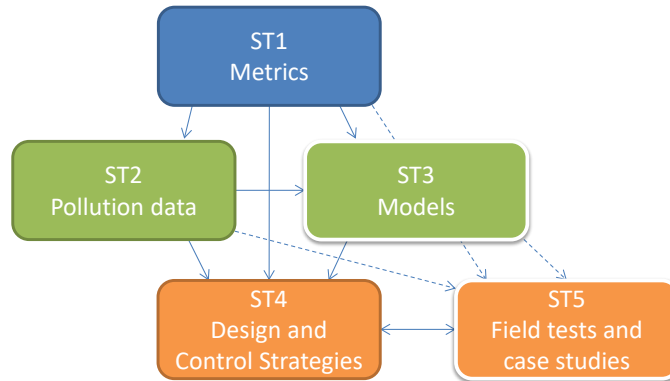

Figure 1-1: Schematic overview of the subtasks in IEA EBC Annex 68 and their interrelations.

1.2 About Subtask 4 and this report

The first three subtasks of the Annex 68 focused on particular aspects related to designing and operating energy efficient buildings while ensuring high IAQ – evaluation metrics, indoor air pollution data or modelling approaches. The objective of Subtask 4 was to set the individual “puzzle pieces” into context. To gather the results and approaches of the other subtasks and present them in the context of existing knowledge. This subtask originally aimed to devise optimal and practically applicable design and control strategies. However, as the project progressed, it became clear, that it was impossible as well as impractical to come up with a specific set of “recommended strategies”. It seemed more appropriate to present the whole variety of different approaches that exists in the practice of all project participants involved in the subtask. It was decided to keep the focus on energy efficient and comfortable mechanical ventilation in airtight, low-energy residences.

Transition from theory to practice

The theory for how to obtain a high IAQ is in principle clear and straightforward. There exist international standards, national standards and building codes as well as many brochures, guidebooks and thematic web pages. However, what is the transition of all this knowledge into practice? How do these theories project into the daily life of architects and engineers? This transition, illustrated in Figure 1-2, was addressed by performing a literature review and a series of interviews among key stakeholders. The results, which are presented in detail in the second chapter, helped to describe the structure of requirements posed on residential ventilation systems across the different European countries. The stakeholder survey helped to identify implementation barriers and operational challenges related to mechanical ventilation. Despite the fact that the survey included 44 interviews from six European countries, it cannot be considered representative for the whole of Europe. The results indicate that there exists a knowledge gap between “written knowledge” and how things actually work in practice. This can be related to the design, installation, commissioning and operation of ventilation systems.

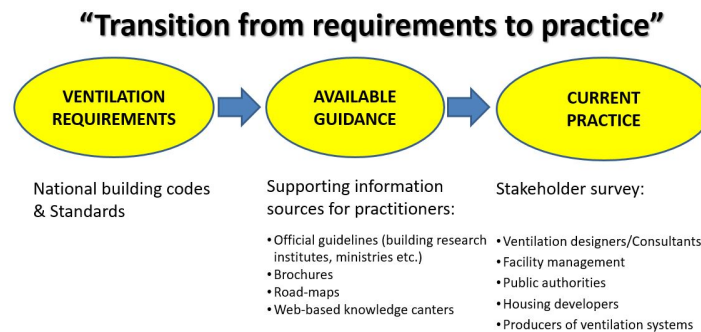

Figure 1-2: Intended transition from requirements to practice.

Overcoming knowledge gaps can be difficult. There exist certain work routines in the daily life of ventilation designers. National standards and requirements are interpreted in a certain way; the future building owner usually does not have special requirements regarding ventilation systems. Commissioning and maintenance in residential applications are often influenced by tight budgets. In the case of commercial buildings, voluntary certification schemes help to involve the building owner. It is the building owner who usually comes with wishes to fulfil a particular certification level. It adds prestige and helps to acquire future tenants. The same model is rarely applicable in residential projects. Here, a good example in the form of a case study, which clearly describes obtained benefits, can help to escape from established routines.

Inspiration for design and operation

The third and fourth chapter of this report are built up as a series of case studies that relate to design (Chapter 3) and operation (Chapter 4) of ventilation in low-energy residences. A **case study**, in the context of this report, should not be understood only as a description of a finished project (i.e. a building or a system that has been built and evaluated). A case study is simply an integrated piece of information relating to a research study, building project or methodological approach that can provide an innovative insight for the reader.

Each case study is presented using a fixed structure comprising:

Objectives, description and methods – briefly presents the background, aim and main methodology used in the case.

Main results and findings – this section documents how the objectives were fulfilled.

Conclusions and lessons learned – represents a direct connection between the case study and practice. It addresses issues that practitioners can directly transfer into their daily practices, if they find the case study relevant.

Further reading – this section is actually a simplified reference section. Despite the fact that each case study has its own reference section presenting cited literature, the *Further reading* section presents one, most important source for further reading that provides additional information regarding the case study.

Table 1-1 presents an overview of topics and challenges addressed in the report (Chapters 3 and 4) and their relation to the different phases in the design, construction or operation process of a ventilation system. The addressed topics are marked with different colours while the different phases are classified in columns.

It is not the intention that this report should be read from the beginning until the end. The authors expect rather selective reading based on the immediate interests of the reader. Designers who consider a sensitivity analysis related to internal loads in multifamily houses will seek a different case study than a contractor trying to find space for ventilation in renovated apartments. The authors hope to give inspiration, show direction or even encourage readers to get in contact with the authors to find new ways to provide better IAQ in modern, low-energy residences.

Target audience

The target audience is every stakeholder involved in enabling better IAQ in new and renovated residences. This especially includes **architects, ventilation designers, facility managers, property developers** and employees of **public authorities**.

Table 1-1 Overview about topics/challenges addressed and their relation to design, construction and operation in Chapters 3 and 4.

Chapter	Case study	Design			Construction, Commissioning & Operation	
		Assessment methods	Assessing ventilation concepts	Novel ventilation solutions	Quality assurance	Assessing in-use performance
3.1	Alternative ducting options for balanced mechanical ventilation systems in multifamily housing					
3.2	Ambient air filtration in highly energy efficient dwellings with mechanical ventilation					
3.3	Development of a compact ventilation system for facade integration					
3.4	Volatile Organic Compounds exposure due to Floor heating systems versus Radiator heating					
3.5	Control strategies for mechanical ventilation in Danish low-energy apartment buildings					
3.6	Response of commercially available Metal Oxide Semiconductor Sensors under air polluting activities typical for residences					
3.7	Impact of multi zone air leakage modelling on ventilation performance and indoor air quality assessment in low-energy houses					
3.8	Towards a better integration of indoor air quality and health issues in low-energy dwellings					
3.9	List of key pollutants for design and operation of ventilation in low-energy housing					
3.10	Definition of a Reference Residential Building Prototype for Evaluating Indoor Air Quality and Energy Efficiency Strategies					
3.11	Temperature dependent emissions of Volatile Organic Compounds from building materials					
3.12	Detailed modelling of Indoor Air Quality to improve ventilation design in low energy houses					
3.13	Mechanical ventilation system in deep energy renovation of a multi-story building with prefabricated modular panels					
3.14	Simplifying Mechanical Ventilation with Heat Recovery systems					
3.15	Design of room-based ventilation systems in renovated apartments					
3.16	Introduction to the Coupled Heat, Air, Moisture and Pollutant Simulation CHAMPS modeling platform					
4.1	House owners' experience and satisfaction with Danish Low-energy houses - focus on ventilation					
4.2	Development and test of quality management approach for ventilation and indoor air quality in single-family buildings					
4.3	Applications of the Promevent protocol for ventilation systems inspection in French regulation and certification programs					
4.4	Long-term durability of humidity-based demand-controlled ventilation: results of a ten years monitoring in residential buildings					
4.5	Practical use of the Annex 68 Indoor Air Quality Dashboard					
4.6	Performance evaluation of Mechanical Extract Ventilation (MEV) systems in three 'low-energy' dwellings in the UK					
4.7	Indoor air quality in low energy dwellings: performance evaluation of two apartment blocks in East London, UK					
4.8	Continuous-commissioning of ventilation units in multi-family dwellings using controller data					

- Addressed topics:**
- Health & Comfort
 - Spatial requirements
 - Cost & Energy consumption
 - Refurbishment
 - Commissioning
 - Quality of installation
 - User satisfaction

2 How do we design residential ventilation today? What are current challenges?

Daria Zukowska, Gabriel Rojas, Esfand Burman, Gaelle Guyot, Maria del Carmen Bocanegra-Yanez, Jelle Laverge, Guangyu Cao and Jakub Kolarik

This chapter first reviews the ventilation requirements and available guidelines for practitioners dealing with ventilation in seven European countries. The countries had chosen to participate in the research project. The review is not therefore representative of all European countries. Subsequently, interviews with relevant expert groups in these countries were carried out. Chapter 2 is adapted from an article published by Subtask 4 in the International Journal of Ventilation (Zukowska et al., 2020).

2.1 Review of national requirements and guidelines

A review of the national building regulations and standards in Austria, Belgium, Denmark, Estonia, France, Norway and the United Kingdom (UK) was conducted and reported by Zukowska et al. (2020). The review focused on ventilation requirements with special attention being paid to key aspects, such as recommended ventilation systems (if any), background and nominal ventilation rates, supply and extract airflows from habitable rooms, bathrooms, toilets and kitchens, state-of-the-art system typology, requirements for heat recovery, specific power input (SPI) and demand controlled ventilation (DCV). Actual requirements regarding residential ventilation in the seven countries investigated are listed in Table 2-1.

Mechanical ventilation is not expressly required in the building regulations of any of the seven countries, and the recommendations prioritize neither mechanical ventilation (MV) nor natural ventilation (NV) or airing. All countries have requirements for nominal ventilation rates (see Table 2-1), however, the requirements vary among the countries and are for some given as air change rate (ACH), while for others as airflows dependent on the number of occupants, floor area, number of habitable rooms or number of bedrooms only. It is clearly stated only in the Belgian and French regulations that mechanical ventilation is not allowed to be switched off completely. In Norway, Austria and Estonia, it is allowed to reduce the airflow below the nominal airflow during non-occupancy and in France, Belgium and Estonia it is allowed in case of a DCV system. Only the Danish regulations state that mechanical air supply can be replaced by airflows through windows, outdoor air valves, etc. in the summer period, however, the minimum airflow rate has to be ensured. All seven national building codes set requirements for minimum exhaust rates from wet rooms. Dependent on the country, either a kitchen hood integration in MV is required or it has to work as a separate system (exhaust to the outside or just recirculation). Requirements related to heat recovery in new mechanical systems, including minimum efficiency, apply only to Denmark, Norway and the UK, and will be introduced in the future Estonian regulations. The Belgian, French and Estonian legislations do not specify maximum values for the specific power input (SPI) for MV (Commission Delegated Regulation (EU) No 1254/2014). However, the energy use by the ventilation fans is taken into account in the French and Belgian energy performance calculations, while in Estonia the recommendation to maximum SPI values are given in a guidebook for ventilation design in nZEBs.

Additionally, the Annex 68 participants reviewed 33 guidelines for practitioners from the seven countries. Target groups of the guides are mostly heating, ventilation and air-conditioning (HVAC) engineers, consultants and architects followed by housing developers, the construction industry and private owners. The review of the guidelines is included in Zukowska et al. (2020).

Table 2-1 Summary of requirements to residential ventilation in new residences. Based on: ¹OIB-Richtlinie 3 (2019), note that the previous version (2015) required MV if natural ventilation could not ensure healthy IAQ, ²ÖNORM H 6038 (2014), ³NBN D 50-001 (1991), ⁴Energiebesluit 19/11/2010 (2010), ⁵BR18 (2019), ⁶Estonian legal acts 11.12.2018 no. 63 (2018), ⁷Working draft for requirements for building indoor environmental quality and airing (2015), ⁸EVS-EN 16798-1:2019, ⁹Arrêté 24.03.82 (1983), ¹⁰Arrêté 26.10.2010 (2010), ¹¹CCFAT (2015), ¹²TEK17 (2017), ¹³HM Government (2010), ¹⁴BRE (2012), ¹⁵The Scottish Government (2015). Legend: E&W - England & Wales, S – Scotland, EP – Energy Performance.

Country	Austria	Belgium	Denmark	Estonia	France	Norway	UK
Natural ventilation (NV)/airing*	Allowed	³ Allowed if dedicated NV ⁵ Allowed system. Only window airing not allowed	⁵ Allowed	⁶ Allowed	⁹ Allowed but rarely compliant with ¹⁰ EP regulation for new dwellings. ⁹ Only window airing not allowed	Allowed	¹³ E&W: Allowed ¹⁵ S: Not suitable if airtightness < 5 m ³ /h/m ² (50 Pa)
Mechanical ventilation (MV)	¹ Not required	³ Recommended only when n ₅₀ < 3h ⁻¹ (MVHR recommended only if n ₅₀ < 1h ⁻¹)	⁵ MVHR recommended	⁶ MVHR promoted; other ventilation strategies allowed if energy, IAQ and thermal comfort req. are met	DCV-MEV or MVHR required to reach the target of the ¹⁰ EP regulation for new dwellings. MSV not allowed	¹² MVHR recommended	^{13, 15} MEV MVHR recommended
Heat recovery	None (local req. to receive subsidies)	³ Recommended only when n ₅₀ < 1h ⁻¹	⁵ Required Decentralized ≥ 80%; Centralized ≥ 67%	⁶ Not mandatory but required to fulfil energy req.	⁹ No requirement but reward in the ¹⁰ EP calculation	¹² Required ≥ 80%	¹⁴ Not mandatory (recommended min. 66%)
MV system allowed to be switched off	Not addressed	³ Not allowed	⁵ Not allowed, except outside heating season if nominal vent. rate is ensured through windows, air valves, etc.	Not addressed	⁹ Not allowed	Not addressed	Not addressed
Kitchen hood integration to MV system	² Not integrated into MVHR	³ Not addressed	Not addressed; ⁵ Mechanical and adjustable kitchen hood connected to the outside required	Not addressed; ⁷ Integration into MVHR allowed; Min. exhaust 25 l/s	Not addressed in the airing regulation ⁹ but kitchen hood other than recirculation rarely compliant with ¹⁰ EP regulation	Not addressed; ¹² Basic ventilation rate 10 l/s	Not addressed; ¹³ Min. exhaust 30 l/s (adjacent to hob, intermittent)

Nominal ventilation rate**	² Bedrooms: min. 5.6 l/s/pers. Living room: 8.3 l/s (or 4.2 l/s/pers.); Overflowing air can be accounted for	³ 1 l/s/m ² for the dry spaces, with specific minimum rates per type of room	⁵ 0.3 l/s/m ² heated floor area	⁶ SFH: 0.42 l/s/m ² (≥ 120 m ²) 0.5 l/s/m ² (<120 m ²) MFH: 0.5 l/s/m ² ⁷ Bedroom, living room: >15 m ² : 14 l/s; ≤15 m ² : 12 l/s; Bedroom: <11 m ² : 8 l/s	⁹ Function of number of main rooms and wet rooms (3 rooms: 8.4 l/s in bathroom, 4.2 l/s in other wet rooms, 12.5 l/s/l/s/pers. when in use with possibility to increase to 29.2 l/s in kitchen)	¹⁰ 0.33 l/s/m ² (in use) (bedroom at least 7.2)	¹³ E&W: min. 0.3 l/s/m ² floor/n. of bedrooms (3 bedrooms: 21.1 l/s) ^S : spec. by min. area of vent. opening
Minimum ventilation rate**	² Min. 0.1 l/s/m ² required during non-occupancy	⁴ DCV: never below 10% of the nominal flow rate	⁵ Min. 0.3 l/s/m ² heated floor area	⁸ 0.05-0.1 l/s/m ² during non-occupancy ⁶ DCV: min. 0.15 l/s/m ² during occupancy	⁹ Function of number of “main rooms” (3 rooms min. 20.8 l/s, 4.2 l/s if DCV)	¹² Min. 0.19 l/s/m ² during non-occupancy	¹³ Min. 0.3 l/s/m ² internal floor area
SPI (specific power input)***	² ≤1.62 kW/(m ³ /s)	⁴ No requirement but reward in the EP calculation	⁵ System for one residential unit ≤ 1.0 kW/(m ³ /s); System for multi-storey residential units ≤ 1.5 kW/(m ³ /s); MEV ≤ 0.8 kW/(m ³ /s)	No mandatory; Recommendation for nZEB ventilation design ≤ 1.5 kW/(m ³ /s)	⁹ No requirement but reward in the ¹⁰ EP calculation	¹² ≤ 1.5 kW/(m ³ /s)	¹⁴ Recommended values: MEV ≤ 0.8 kW/(m ³ /s), Balanced whole-house MV ≤ 2.0 kW/(m ³ /s)
Controls	² DCV recommended; Min. 3 levels for fan speed required	³ All types of controls allowed that do not completely shut down the mechanical parts. ⁴ Types of DCV addressed only in the EPB regulations	⁵ DCV may be used; Background vent. rate has to be ensured	^{6,7} DCV may be used ⁷ Background vent. rate has to be ensured and CO ₂ < 1200 ppm; if RH > 65% in wet rooms, the min. extract vent. rates must be met	¹¹ DCV often used and must go through an agreement procedure with IAQ performance indicators (CO ₂ cumulative exposure and condensation risk)	Not addressed	¹³ DCV/ manual; RH contr. req. in wet rooms; Trickle ventilators controlled by occupants

*Airing is defined as a renewal of air by opening of windows, while natural ventilation (NV) is defined as ventilation designed solely on the effect of wind and the stack effect through dedicated openings, i.e. excluding infiltration (EN 15665:2009; CEN/TR 14788:2006).**Nominal and minimum ventilation rates are recalculated to l/s from the units stated in the specific national regulations. Minimum ventilation rates are the minimum required airflows to be ensured at any time – for some countries specified as background ventilation or as minimum required ventilation rates during non-occupancy time.***SPI-values are recalculated to kW/(m³/s) from the units stated in the specific national regulations.

2.2 Stakeholder survey

Gathering information about current practices in design, operation and commissioning of residential ventilation systems was based on semi-structured interviews (44 in total) performed in 2017 in the seven countries participating in Annex 68: Austria (6), Belgium (10), Denmark (5), Estonia (4), France (5), Norway (7) and the UK (7). Five different interview templates were used dependent on the target group of stakeholders to be interviewed: Ventilation designers/consultants, Facility management companies / Building administration, Public authorities, Housing developers and Producers of ventilation systems. The first part of each interview was focused on the stakeholders' opinion regarding state-of-the-art ventilation systems installed in low-energy dwellings. The second part focused on barriers and problems during design, commissioning, operation and maintenance as well as on key changes in legislation, technical measures, financial incentives, market requirements and outreach programs that stakeholders believed were needed to provide high IAQ in energy efficient homes. The results of the survey are reported in detail in Zukowska et al. (2020), while a short summary is included in this publication. The survey provides a valuable snapshot of current practices and insights into potential barriers, however, due to the relatively low number of responses from each country, the results can only be treated as trends seen in the countries.

2.2.1 Mechanical ventilation in low energy dwellings – current practice

With respect to types of ventilation systems, the interviews revealed that mechanical ventilation (MV) systems are dominant in low energy dwellings, and with heat recovery in most countries. In Austria, natural ventilation (NV) and mechanical exhaust (MEV) systems are receiving comparable attention. In Belgium, NV is barely applied due to problems with achieving the required airflows. Mechanical supply ventilation (MSV) is not popular for practical reasons and concerns with moisture management of the façade in a pressurized dwelling. MEV is being pushed out of the market by MVHR in low energy dwellings, however, it is still installed in many new apartments and dwellings and it is commonly used in renovated constructions. DCV MEV was mentioned by most of the Belgian stakeholders as the dominant type of MEV, having low electricity demand and therefore able to follow the energy performance requirements. However, the price of such systems catches up with the price for MVHR, especially if equipped with many sensors. A hybrid system, i.e. periodic switching between natural and mechanical ventilation, is not yet approved in the Belgian energy performance regulations. In France, exhaust-only humidity-based DCV systems including humidity-sensitive trickle ventilators and extract devices seem to be the state of the art in new (low-energy) residential buildings. The dominance of MVHR systems is obvious in Scandinavian countries and for dwellings with air permeability lower than $5 \text{ m}^3/\text{h}/\text{m}^2$ (50 Pa) in the UK. Generally, centralized air handling systems are often used in social apartments, because inhabitants are not interested in maintaining a decentralized system and it is more expensive to service several individual units.

In the interviews from Estonia, the separated exhaust system for a kitchen hood was mentioned. Most of the respondents from Austria referred to the use of recirculating hoods. In contrast to that, the Norwegian stakeholders noted that it is common to connect the kitchen hood to the ventilation system. Where a separate fan is used, a pressure-sensor is applied to ensure balanced ventilation. The Danish designers referred to the integration of a kitchen hood to a MV system as well as to installation of a kitchen hood as a separate device connected directly to the outside. This illustrates that both approaches are applied in Denmark. The Belgian stakeholders referred to all three solutions for a kitchen hood but prioritized separate systems.

Based on the survey, it can be concluded that heat recovery in residential MV systems is ensured mainly by a counter-flow plate heat exchanger or a cross-flow heat exchanger. Heat recovery is not required in the Belgian building regulations. However, balanced MV systems without heat recovery are no longer installed or found on the Belgian market, which could be indicative of the effect of energy regulations on provisions of ventilation. The Norwegian, Danish, Belgian, France and the UK designers stated that in their systems fresh air is supplied into bedrooms and living rooms and extracted from bathrooms, toilets and kitchens (i.e. a cascade system). When designing/implementing balanced systems in Austria, the so-called extended cascade systems seem to be preferred, where fresh air is supplied into bedrooms and extracted from wet rooms and the kitchen. The living room is purely treated as an overflow zone, and in this way the total number of supply air terminals and supply air rate are reduced.

Application of DCV appears to be rare in the countries participating in the survey, except in France and Belgium. In France, the reference ventilation system in new (low-energy) residential buildings is a humidity-based DCV system including fully mechanical air inlets in the dry rooms and exhaust units in the wet rooms. When balanced ventilation is used, airflows are generally constant but occupants have the option to boost the kitchen exhaust unit. Typical control consists of a user-operated switch that allows changing the amount of the supplied air in relation to the user activity in a dwelling: “away”, “normal occupation”, “boost”, etc. Based on the survey in Belgium, a typical DCV MEV system is equipped with motion and/or moisture sensors in wet spaces, while more advanced systems also have CO₂ sensors in dry spaces. Occupants can influence the airflows only in cases with decentralized ventilation units (typically 3 levels of fan speed). In the case of MV, CAV systems are the most common solution for apartments, while VAV systems based on CO₂ or moisture sensors are seldom installed. A designer from Austria noted that DCV for the residential housing sector does not prevail on the market because of higher costs. Technical problems with the positioning of sensors were mentioned, and the only reasonable approach, the placement of a sensor in each room, increases both the cost and complexity of the system. A Norwegian housing developer mentioned the possibility to adjust the airflow in MV systems manually with three levels by the user in decentralized systems, while in the case of centralized systems, occupants seldom can do any adjustments. There can be a switch on the kitchen hood and an “indirect control” in a bathroom, either by a humidity-controlled valve or an on/off switch. Both developers and designers from the UK mentioned a manual switch or humidity-based boost modes for a bathroom and kitchen. They also mentioned that users can switch their system off, but they are encouraged by developers and installers not to do so. This topic seems also to be important for Danish designers who pointed out that in some systems with a simple “on/off” control, especially centralized ventilation systems, the off does not actually mean that there is no airflow through the system, because this is not allowed according to the building regulations.

Answers to the question regarding minimum required ventilation rates and IAQ in dwellings indicated that the stakeholders were mostly aware of the lower limits for ventilation airflows imposed by particular building codes.

The Danish, Norwegian, French, Belgian, Austrian and Estonian designers typically use circular steel galvanized ducts and occasionally in case of limited space more expensive rectangular steel ducts. In the UK, rectangular and flat oval plastic ducts are typically used to maximize the floor-to-ceiling height and due to lower price compared to steel ducts.

Based on the interviews from all seven countries it can be concluded that it is a common practice to place silencers at supply and extract ducts from AHUs. The designers from Denmark, Norway and Austria mentioned the use of additional silencers between rooms, and additionally, the Danish designers recommend silencers at extract ducts from bathrooms and kitchens.

The designers from Austria, Norway and Belgium mentioned filtration class F7 (fine filters; according to EN 779:2012) for the ambient air and filtration class G4 (coarse filters; EN 779:2012) for the extract air in residential MV.

2.2.2 Barriers and problems

Barriers and problems identified in the survey were categorized based on the building's procurement stage: design (incl. decision making, concept design and detail design), construction (incl. installation and commissioning) and post-handover (incl. operation and maintenance). The main problems along with the number of times each item was raised in the interviews carried out in each country are listed in Table 2-1. All collected responses regarding the barriers and problems are published by Zukowska et al. (2020).

During the design phase, the investment required to provide whole-house mechanical ventilation along with spatial and maintenance requirements of these systems are among the key concerns. For MVHR systems specifically, several stakeholders pointed out that the capital cost required is notably higher than for conventional ventilation systems, defined as the most used systems in each country, such as extract air ventilators in humid rooms, exhaust-only systems or natural ventilation. Furthermore, MVHR systems require more space and duct routing, which can be challenging, even more during building renovation. Other difficulties have also been raised by some interviewees: positioning the units to minimize noise and finding appropriate locations for ambient air intake and exhaust outlets. Increased complexity of MVHR systems due to auxiliary systems for frost or fire protection were also mentioned. Referring to the design process of MV in general, a lack of project-specific planning was raised by two stakeholders from France.

Concerning the construction stage, non-compliance with regulatory requirements due to poor system installation and the quality or lack of commissioning were raised as a common concern. Indeed, several interviewees noted shortcomings in the skillset of installers who are often not up to date regarding the latest ventilation and energy efficiency requirements. Lack of training was also highlighted together with the complexity of some systems.

Noise and system maintenance after building handover was a key problem raised in most countries. Lack of clear instructions about system operation and maintenance requirements, in user manuals and during building handover, including the changing of filters, was a major issue. Accessibility is also a key consideration for decentralized systems where MVHR units are installed inside apartments and access for regular maintenance might be difficult. Additionally, interviewees reported that unless there is a follow-up service contract in place, which is mostly applicable to apartment blocks with centralized systems, key maintenance requirements may not be met in practice, as occupants are not well briefed about these requirements and the consequences of poor maintenance. Draughts, operational failures and perceived cost of operation, which in extreme cases had led to occupants turning off their systems, were among other problems identified in the survey.

Table 2-2 Barriers against and problems associated with mechanical ventilation of low-energy dwellings identified in the survey. The numbers indicate the frequency each item was raised in the interview. The numbers within brackets provide the number of interviews collected in each country.

Stage	Barrier or problem	Austria (6)	Belgium (10)	Denmark (5)	Estonia (4)	France (5)	Norway (7)	UK (7)	Total (44)
Design	Spatial requirements & duct routing	3	8	4	1	1	6	1	24
	High capital cost of MVHR systems	4		2	1	2		1	10
	Coordination within all design stakeholders (and customer)		5					1	6
	Complexity of MVHR (incl. auxiliary systems, e.g. frost / fire protection)			1	1	1			3
	Difficult to find an appropriate location for exterior in-/outlets		2				1		3
	Difficult to position the units to minimise noise						1	1	2
Construction	Poor quality in system installation & commissioning/ rare			1		5		3	9
	Lack of qualified/experienced installers and lack of quality	1	2					1	4
	Balancing and adjustment of flow rates		1				1	1	3
	Designers are often not involved in commissioning			1			1		2
Post-handover	Maintenance issues	2	4	3		1	3	3	16
	Noise	4	2		2		1	2	11
	No proper support for tenants / Lack of occupant knowledge	1	1	2	1				5
	Draughts / covering grids		2	1	1				4
	Odours		1		1				2

2.2.3 Potential improvements

Legislative pushes: A list of the key legislative requirements and improvement opportunities identified by the stakeholders, which could push mechanical ventilation implementation and enhance its performance can be found in Table 2-3. The key emerging themes are as follows:

- a) More flexibility in building codes and standards incl. a more holistic approach that allows for trade-offs.
- b) The necessity of a coordinated approach to energy efficiency and IAQ.
- c) Control mechanisms required to ensure good implementation and operation.

As for the post-handover phase, a respondent in France drew an analogy between the mandatory requirements for maintenance of heating systems in France and most European countries, where building owners are legally responsible for annual service and maintenance of these systems, and maintenance of MVHR systems. Currently, the responsibility for maintenance of mechanical ventilation systems in dwellings is not well-defined (e.g. MVHR filter replacement).

Technical pushes: Stakeholders suggested that training and accreditation of installers of ventilation systems would be necessary to improve the quality of installations and avoid problems such as excessive air leakage, unbalanced systems, draughts, noise and unnecessarily high energy consumption of the fans. Furthermore, it was stated that it is important to keep the design as simple as possible, and at the same time flexible for user control. However, a ventilation producer from Belgium stated that manual control is never used because occupants do not have the “natural sensors” to control IAQ. An interviewee in Denmark, on the other hand, pointed out that better IAQ performance in some circumstances may be achieved by refined zonal control and increasing the number of sensors. This shows that finding the right balance between system complexity and IAQ performance objectives seems challenging and may be very much country and even project dependent. It is also important to identify the risk factors and failure modes of a design strategy and specify appropriate mitigation measures throughout the building procurement process.

Financial incentives pulls: Government subsidy, grants for specific systems or insurance incentives for system maintenance can be very effective to increase MV implementation. An Austrian stakeholder estimated that around 50% of the multi-family housing projects in Tirol, western Austria, utilize balanced ventilation systems with heat recovery thanks to additional housing subsidies available for these systems. However, the absence of financial support is seen as positive by one stakeholder in Belgium, who reported that “awareness among the general public is too small for a financial stimulus to be enough to convince people to invest in IAQ/ventilation”.

Market pulls: Calls for quality labels for ventilation systems, more building products with low emissions, and potential market interventions to balance energy effectiveness and the cost of installation were among the key market requirements identified in the survey. Increasing occupant awareness about IAQ and ventilation is also an issue of concern. A producer of ventilation systems in Estonia also suggested that there must be a level playing field in the market. This producer provided additional measures for heat recovery and frost protection in cold climates whereas their competitors do not necessarily consider these problems and the potential consequences. Stricter regulatory requirements may lead to improvements in system performance and fairer market competition.

Outreach programs: Clearer guidance on IAQ from governments, feedback to designers about the actual performance of systems accompanied by education to architects on the need of careful planning of ventilation

systems in early design stages were identified as key outreach measures required to facilitate the use of these systems. Outreach campaigns to improve the understanding of building administrators and occupants about the benefits of mechanical ventilation should follow. These stakeholders should also receive more information on how to maintain and operate ventilation, especially in the context of low-energy buildings.

Table 2-3 Potential improvements in legislation and standardization expressed in this survey.

Country	Improvement opportunities in legislation and standardization
Austria	<ul style="list-style-type: none"> • <u>Design</u> <ul style="list-style-type: none"> – Further relaxing/adjusting the current requirements of ÖNORM H 6038 (2014)¹ – Make Passive House standard mandatory / accept PHPP² calculation in standards • <u>Construction (system installation/commissioning/quality control)</u> <ul style="list-style-type: none"> – Make adjustment of ventilation rates based on actual use rather than nominal occupancy during commissioning
Belgium	<ul style="list-style-type: none"> • <u>Design</u> <ul style="list-style-type: none"> – More flexibility in European standard to account for specific regional differences – Some harmonisation between countries, being careful with 'one size fits all' solutions • <u>Construction (system installation/commissioning/quality control)</u> <ul style="list-style-type: none"> – Quality assurance program / more enforcement³ – Proactive rather than reactive quality control, e.g. putting requirements in contract rather than just measurement report after building completion
Denmark	<ul style="list-style-type: none"> • <u>Design</u> <ul style="list-style-type: none"> – Update/improve the IEQ standards for dwellings – Set out requirements for ventilation control • <u>Construction (system installation/commissioning/quality control)</u> <ul style="list-style-type: none"> – Set out detailed commissioning requirements • <u>Post-handover (operation & maintenance)</u> <ul style="list-style-type: none"> – Strengthen requirements for training of maintenance/operation personnel and for training material
Estonia	<ul style="list-style-type: none"> • <u>Construction (system installation/commissioning/quality control)</u> <ul style="list-style-type: none"> – Need for a control mechanism to ensure compliance with requirements • <u>Post-handover (operation & maintenance)</u> <ul style="list-style-type: none"> – Define legislative requirements for system maintenance in apartments
France	<ul style="list-style-type: none"> • <u>Design</u> <ul style="list-style-type: none"> – IAQ should get same priority as energy performance • <u>Construction (system installation/commissioning/quality control)</u> <ul style="list-style-type: none"> – Verification of ventilation performance at commissioning stage⁴ • <u>Post-handover (operation & maintenance)</u> <ul style="list-style-type: none"> – Mandatory requirements for maintenance of ventilation systems

- Norway**
- Design
 - More options in the design phase regarding the requirements for energy efficiency and indoor air quality, i.e. allow for natural ventilation in new dwellings
 - Promote assessment methods such as BREEAM-NOR (2016) for residential buildings by Norwegian Green Building Council
 - Change regulations to cover protection against overheating
 - Energy labelling should be less technical than required by TEK10 (2010) and include more general aspects such as daylight
 - Construction (system installation/commissioning/quality control)
 - Adjust ventilation rates based on actual needs
 - Set out requirements for checking heat exchangers and supply air temperatures
-

- UK**
- Design
 - Holistic and coordinated approach to energy & IEQ in policy making
 - Update the Approved Document Part F (HM Government 2010)⁵ and harmonise it with international guidelines
 - Prioritise IAQ and effective ventilation
 - Construction (system installation/commissioning/quality control)
 - Strengthen the requirements for system installation & commissioning
 - Improve the arrangements for compliance check to reduce non-compliance
-

¹The Austrian standard covering balanced ventilation for residential buildings. In general, the latest revision (2014) received positive feedback during these interviews.

²PHPP – Passive House Planning Package

³Since January 2016 a ventilation auditor has to be appointed and the flow rates have to be read and measured. Most interviewees perceived this as a positive change in the new legislation.

⁴A recent project proposed a normalised protocol for system installation check: www.promevent.fr

⁵A second-tier document to the Building Regulations that sets out the ventilation requirements for buildings in England and Wales.

2.3 Further reading

Zukowska, D., Rojas, G., Burman, E., Guyot, G., Bocanegra-Yanez, M.D.C., Laverge, J., Cao, G., & Kolarik, J. (2020). Ventilation in low energy residences – a survey on code requirements, implementation barriers and operational challenges from seven European countries. *International Journal of Ventilation*.

2.4 References

Arrêté 24.03.82 (1983). Arrêté du 24 mars 1982 relatif à l'aération des logements. JORF 15 novembre 1983.

Arrêté 26.10.2010 (2010). Arrêté relatif aux caractéristiques thermiques et aux exigences de performance énergétique des bâtiments nouveaux et des parties nouvelles de bâtiments, JO 27 octobre 2010.

BR18 (2019). The Danish Building Regulations. Ministry of Transport, Construction and Housing. Copenhagen, Denmark.

BRE (2012). The Government's Standard Assessment Procedure for Energy Rating of Dwellings, BRE, Watford, UK.

BREEAM-NOR (2016). BREEAM-NOR New Construction 2016. Technical manual. Norwegian Green Building Council, Oslo, Norway.

CCFAT (2015). VMC Simple Flux hygroréglable - Règles de calculs pour l'instruction d'une demande d'avis techniques - GS14.5 - Equipements / Ventilation et systèmes par vecteur air, Marne la Vallée, France.

CEN/TR 14788:2006. Ventilation for buildings. Design and dimensioning of residential ventilation systems. Technical Report, European Committee for Standardization, Brussels, Belgium.

Commission Delegated Regulation (EU) No 1254/2014 of 11 July 2014 supplementing Directive 2010/30/EU of the European Parliament and of the Council with regard to energy labelling of residential ventilation units. Journal of the European Union.

EN 15665:2009. Ventilation for buildings. Determining performance criteria for residential ventilation systems. European Committee for Standardization, Brussels, Belgium.

EN 779:2012. Particulate air filters for general ventilation - Determination of the filtration performance. European Committee for Standardization, Brussels, Belgium.

Energiebesluit 19/11/2010 (2010). Vlaams Energiebesluit van 19 november 2010, bijlage V en IX. Vlaams Regering.

Estonian legal acts 11.12.2018 no. 63 (2018). Minimum requirements for energy performance of buildings. Minister of Economic Affairs and Infrastructure. (in Estonian: Ettevõtlus- ja infotehnoloogiaministri määrus nr 63 (11.12.2018). Hoone energiatõhususe miinimumnõuded)

EVS-EN 16798-1:2019. Energy performance of buildings - Ventilation for buildings - Part 1: Indoor environmental input parameters for design and assessment of energy performance of buildings addressing indoor air quality, thermal environment, lighting and acoustics - Module M1-6. Estonian Centre for Standardisation.

HM Government (2010). The Building Regulations 2010. Ventilation. Approved document F: F1 Means of ventilation (2010 edition incorporating 2010 and 2013 amendments).

NBN D 50-001 (1991). Ventilation systems for housings. Belgian Institute for Normalization (BIN), Brussels, Belgium.

OIB-Richtlinie 3 (2019). Hygiene, Gesundheit und Umweltschutz. Richtlinien des Österreichischen Instituts für Bautechnik, Wien, Austria.

ÖNORM H 6038 (2014). Ventilation and air conditioning plants - Controlled residential ventilation including heat recovery - Planning, installation, operation and maintenance. Austrian Standards Institute, Wien, Austria.

TEK10 (2010). Norwegian regulations on technical requirements for construction works. Norwegian Building Authority, Oslo, Norway.

TEK17 (2017). Norwegian regulations on technical requirements for construction works. Norwegian Building Authority, Oslo, Norway. <https://dibk.no/byggereglene/byggteknisk-forskrift-tek17/> (accessed 28.1.2019)

The Scottish Government (2015). Scottish building regulations: Technical Handbook - Domestic. Edinburgh, UK.

Working draft for requirements for building indoor environmental quality and airing (2015). (in Estonian: Hoone sisekliima ja õhustuse nõuded). To be implemented 2021.

Zukowska, D., Rojas, G., Burman, E., Guyot, G., Bocanegra-Yanez, M.D.C., Laverge, J., Cao, G., & Kolarik, J. (2020). Ventilation in low energy residences – a survey on code requirements, implementation barriers and operational challenges from seven European countries. *International Journal of Ventilation*.

3 Ways to design residential ventilation in the future

This section provides examples of research projects and case studies dealing with new approaches relevant to the design of ventilation systems as well as IAQ in general. Issues like alternative duct routing options in renovated apartment buildings, compact façade or room-based ventilation units represent issues met by many practitioners in their daily life. The general IAQ-related issues are represented by topics like VOC emissions related to the types of heating systems, temperature-dependent emissions or identification of key pollutants in low-energy housing. Utilization of modelling tools for improved design is also addressed in this chapter.

3.1 Alternative ducting options for balanced mechanical ventilation systems in multifamily housing

<i>Gabriel Rojas, Rainer Pfluger</i>								Addressed topics: ■ Health & Comfort ■ Spatial requirements ■ Cost & Energy consumption ■ Refurbishment ■ Commissioning ■ Quality of installation ■ User satisfaction	
Assessment methods		Assessing ventilation concepts		Novel ventilation solutions		Quality assurance		Assessing in-use performance	

3.1.1 Project objectives, description & methodology

Duct routing often poses a great challenge when planning the installation of a mechanical ventilation system with heat recovery (MVHR). This is particularly true for retrofits, where the necessary space for supply and exhaust ducts was originally not accounted for. If the floor plan allows, a false ceiling can be installed in the hallway and/or the bathroom of the apartment enabling the installation of the ducts, the silencers and the flow control valves (in the case of a centralized system) or the MVHR unit for the apartment. However, in practice this solution is often difficult to implement, resulting in a cost-intensive installation and operation, e.g. due to the need to install many fire dampers and suspended ceilings. Spatial requirements and duct routing has been identified as one of the barriers for widespread implementation of MVHR in various countries (see Chapter 2). As a consequence, many housing refurbishment projects opt for the installation of an exhaust air system (if space for the exhaust ducting exists), giving away



Figure 3-3 View of supply air ducts being routed on exterior wall prior to installing new insulation layer.

the potential for substantial energy savings by heat recovery. Another ductless alternative is the use of room-based decentralized ventilation units. However, it does not enable a cascading airflow through the dwelling from bedrooms (and living rooms) towards wet rooms, thus resulting in a lower ventilation efficiency (nearly twice the flow rate is required). In general, these alternatives often fall short also in terms of thermal or acoustic comfort (e.g. sound emission of the units and reduction of sound insulation of the exterior walls by multiple wall openings) as compared to a cascading MVHR system. Often they also lack the possibility to install good air

filters (like ISO ePM1 50%). Several research projects have investigated various alternative ventilation concepts with heat recovery that are minimally invasive and minimize ducting, e.g. the use of active overflow elements (Noflatscher, 2018) or push-pull ventilators (Wirnsberger and Krause, 2018). The presented approach also avoids ducting within the dwelling, while allowing the installation of a centralized MVHR unit and the implementation of a cascading airflow through the dwelling. It has been applied in several refurbishment projects by the social housing company “Neue Heimat Tirol” in Innsbruck, (Music, 2018). More details about the refurbishment project can be found at <https://passivehouse-database.org> under the project ID's 5673, 5674, 5675, 5676 and 5676.

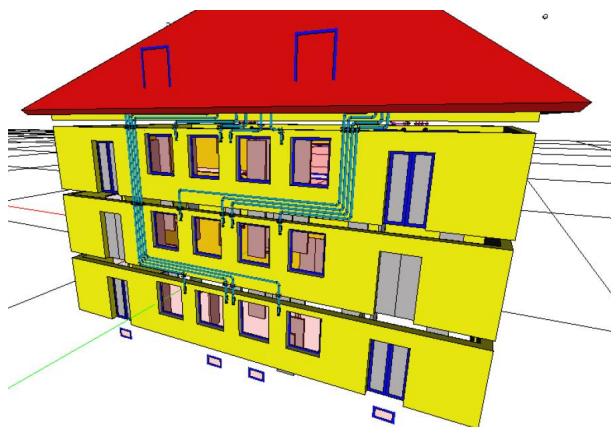

Figure 3-4 sketch of one of the case studies installing the supply and extract air ducts in the exterior wall insulation. Source: (Music 2018).

3.1.2 Main results and findings

The principal idea of this ducting solution is simple: install the central ventilation unit in the attic and run the supply and extract air ducts down into each apartment and each room on the outside of the external walls through the insulation layer (see Figure 3-1). This approach requires a core hole in each room where air is supplied or extracted. However, it has several advantages:

- No duct routing within the apartments
- Makes the use of centralized MVHR units economically and technically feasible, which is considered advantageous in terms of maintenance/accessibility
- Simple fire protection measures, i.e. few fire dampers are required, reducing maintenance costs.

To fully exploit the advantages of this approach all bedrooms and wet rooms should have access to an exterior wall where ducts can be integrated. Ideally, the supply air rooms are on one side and the extract air rooms on the other side, e.g. see Figure 3-3. In the presented case studies, the 7 cm diameter ducts were installed within the existing cork insulation layer (6 cm). They were covered by the new 20 cm thick EPS insulation layer. However, an existing insulation layer is not a prerequisite, since the slots for the ducts could also be included within the new insulation layer. Basic calculations suggest the remaining insulation thickness should be roughly $>2/3$ of the total insulation layer to avoid significant heat losses. Some projects investigated the use of pre-

formed EPS elements to ease the integration of air ducts in the insulation layer (Hauser and Kaiser, 2013; Schwerdtfeger, 2018).

When routed through the interior of the building, fire safety codes in Austria (and other countries) prescribe the installation of fire dampers, whenever the ducting penetrates walls of declared fire compartment zones. Such dampers are costly and need regular inspection. Their easy accessibility often poses a major issue for property managers, if they are installed in the false ceiling within the flat. In the presented case study these issues are minimized since the ducting is routed on the exterior walls. The MVHR unit was placed within a fire protected housing only needing four (easily accessible) fire dampers at its penetration points, see Figure 3-4. From there the supply and extract air ducts are split and routed to the exterior wall. After the splitting, manual flow valves and silencers were installed, see Figure 3-5. The ambient and exhaust air ducts were insulated and routed as short as possible to appropriate locations for air intake and exhaust.

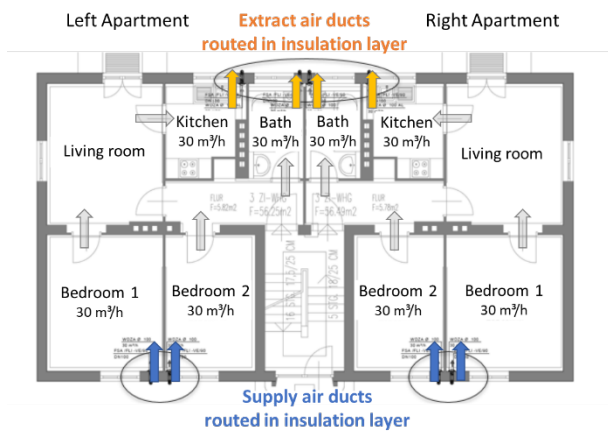

Figure 3-5 Floor plan of one of the case studies where all supply and extract air ducts are integrated in the external wall insulation. Note that the living rooms are ventilated with overflowing air (extended cascade principle).



Figure 3-6 Central unit with fire protected housing and fire dampers at the top. The fire protected maintenance cover at the front is not mounted at the moment.

3.1.3 Conclusions, lessons learned for practice

This case study presents an attractive alternative for routing the supply air and extract air ducts for centralized MVHR during a deep energy retrofit of multifamily housing. The main advantage is the fact that no ducting is needed within the dwelling, thus saving space and minimizing disturbance of dwelling occupants. The layout of these case study buildings allowed very simple planning, in terms of fire protection in particular, and resulted in a smooth installation process. Due to its simple and low tech design, manual flow regulation valves, few fire dampers, no false ceilings, etc., the costs for the entire MVHR system could be kept at roughly €2500 per apartment, which is less than half of the costs for installing the MVHR system in comparable projects. As it worked well for deep retrofit, this concept could also be adapted for new buildings. Up until now, it was only applied for centralized MVHR. The University of Innsbruck is preparing a system for a decentralized version (one unit per

dwelling) with less effort yet for fire protection. The unit will be placed in a way to allow maintenance work to be performed from the staircase.



Figure 3-7 Supply air ducts in attic with flow regulation dampers, silencers and penetration to the outside of the exterior wall.

3.1.4 Further reading

Music, Admir. 2018. “Luftverteilung: Erschließung Über Die Fassade - Erfahrungen Aus Dem Forschungsprojekt Sinfonia (A).” In *AKKP 54: Neue Konzepte Der Kontrollierten Lüftung: Fassadenintegrierte Lüftung*, ed. Wolfgang Feist. Darmstadt, Germany: Passive House Institute, 127–35.

3.1.5 References

Hauser, Gerd, and Jan Kaiser. 2013. “Dämmstoffintegrierte Kanäle Für Zentrale Lüftungsanlagen Mit Wärmerückgewinnung.” *Bauphysik* 35(6): 367–76.

Noflatscher, Lukas. 2018. “Aktive Überströmer - Messtechnische Untersuchung Und Auswertung Einer Komfortlüftungsanlage Mit Aktiven Überströmern Zur Stufenweisen Sanierung.” University of Innsbruck.

Schwerdtfeger, Peter. 2018. “Luftverteilung: Erschließung Über Die Fassade. Erfahrungen Aus Dem Projekt Nauheimer Straße.” In *AKKP 54: Neue Konzepte Der Kontrollierten Lüftung: Fassadenintegrierte Lüftung*, ed. Wolfgang Feist. Darmstadt, Germany: Passive House Institute, 137–50.

Wirnsberger, Markus, and Harald Krause. 2018. “Lüftungseffektivität Und Thermische Behaglichkeit von Pendellüftern in Der Wohnraumlüftung.”

3.2 Ambient air filtration in highly energy efficient dwellings with mechanical ventilation

<i>Gabriel Rojas</i>									
<div style="float: right;"> Addressed topics: Health & Comfort Spatial requirements Cost & Energy consumption Refurbishment Commissioning Quality of installation User satisfaction </div>									
Assessment methods		Assessing ventilation concepts		Novel ventilation solutions		Quality assurance		Assessing in-use performance	

3.2.1 Project objectives, description & methodology

Nowadays, highly energy efficient buildings have very airtight building envelopes and use mechanical ventilation systems to ensure sufficient air exchange. For example, the Passive House standard, a certification scheme for very energy efficient buildings, requires the installation of mechanical ventilation with heat recovery (MVHR) (PHI n.d.). When using MVHR, fresh air is supplied into bedrooms (and living rooms). The same amount of air is extracted from the wet rooms, i.e. kitchen, bathroom and toilet, and exhausted to the ambient air once it has passed through the heat exchanger. In European homes with MVHR, no air is recirculated within the dwelling (in contrast to North American homes). To protect the heat exchanger from fouling, filters are needed. For this purpose, a rather coarse filter class, e.g. G4 or equivalent, is sufficient. To reduce the exposure of the occupants to outdoor-originated particulate matter (PM), many MVHR units use a higher class filter for the supply air. For example, the Passive House standard requires the use of a supply air filter with an efficiency rating according to EN 779 (EN 2012) of F7 or higher. Note, that typically the supply air filter is positioned at the ambient air intake, and in this way, it also protects the ventilation system from fouling. Since the potential health effects of fine and ultrafine particle exposure are receiving growing attention, the question arises what filter class should be recommended for highly airtight homes with MVHR. Is the current Passive House requirement reasonable or would it make more sense to recommend a higher or lower filter class? What is the effective filtration performance, i.e. the effective occupant exposure, and what are the associated energy costs?

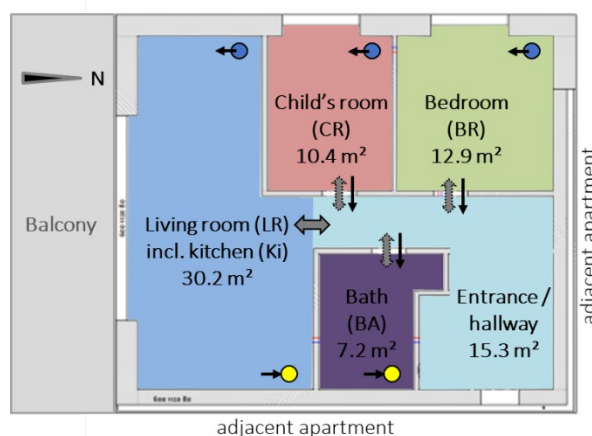

Figure 3-8 Sketch of the simulated floor plan representing a typical new Austrian residential dwelling.

To answer these questions a number of issues have to be considered: e.g. in-/exfiltration through the building envelope, particle deposition (e.g. gravitational settling, adhesion) and opening of doors and windows by the occupants influence the indoor particle concentration. Additionally, indoor particle sources like cooking (considered the major indoor source) can substantially contribute to occupant exposure.

To estimate exposure depending on the outdoor concentration, cooking activity and ventilation concept, a computer simulation study was performed. A model representing a typical Austrian residential dwelling with two bedrooms was implemented incorporating all of the aforementioned aspects. Part of the challenge is that particles of different sizes behave very differently, so that the entire relevant particle size spectrum has to be modelled and the respective model parameters have to be provided as size-dependent. The necessary parameters were extracted from reports and publications of other experimental studies (Liu and Nazaroff 2003; Riley et al. 2002; Shi 2012). A sensitivity analysis was performed for relevant model parameters to ensure that a small variation on the assumed parameters will not totally change the results and therefore the conclusions, see (Rojas 2019) for more details.

3.2.2 Main results and findings

The results show that an F7 filter (according to EN 779, roughly equivalent to MERV13 according to ASHRAE Standard 55.2 or ePM1>50% according to ISO 16890) reduces the average PM_{2.5} exposure of a person (that is home all day) to outdoor-originated particles by 67% compared to outdoor air. This comes at a relatively low additional electrical energy consumption (the extra fan power needed to overcome the flow resistance created by the filter). In comparison, the use of a lower class filter like an M5 (equivalent to MERV9/10) or a higher class filter like F9 (equivalent to MERV15) would reduce the exposure by 26% or 79%, respectively. See the triangles/dashed line in Figure 3-7. However, depending on the outdoor air PM concentration and the level of cooking activities by the occupants, the exposure to indoor generated particles might become a substantial or even dominant fraction of the total PM exposure. To assess the exposure to cooking related PM, different cooktop ventilation strategies (no cooker hood, a recirculating cooker hood with carbon filter and an extracting cooker hood) were simulated. When operating extracting cooker hoods in airtight buildings the inflow of make-up air has to be provisioned, e.g. by a dedicated make-up air opening or an open window. This is the reason that the use of an extracting device is not necessarily beneficial when the outdoor concentration is high or moderate and the particle generation from cooking is low or moderate. However, for low outdoor air concentrations, the use of an extracting cooker hood will greatly reduce exposure to particles from cooking, in particular for strongly emitting activities like frying.

3.2.3 Conclusions, lessons learned for practice

This is a simulation study and therefore its results are affected by assumed boundary conditions. Nevertheless, this study gives insights and trends for exposure to PM in highly energy efficient homes, which help the selection of sensible PM filtration systems. The results confirm that the use of an F7 filter (equivalent to ePM1 50% or MERV13) makes sense as a general precautionary recommendation since the relation between exposure reduction and associated energy penalty is good. The results also show that for outdoor air concentrations as typically encountered in urban areas in well-developed countries (labelled “low” in this study, see also (WHO 2016)), the total PM exposure may be dominated by indoor sources like cooking. Here, effective measures, like the use of extracting cooker hoods, are recommendable for high cooking activities. For locations with moderate or high outdoor PM concentrations, as often encountered in Asian cities (WHO 2016), the use of higher filter classes like F9 or equivalent are recommended. They will further reduce the exposure to outdoor-originated PM. In these cases, the use of extracting cooker hoods may not be advisable due to the introduction of outdoor particles with the make-up air. For conditions with high outdoor PM concentrations and high cooking

source strength as often encountered in Asian households, a need for new product developments, such as recirculating cooker hoods or make-up air openings with particle filtration, has been identified.

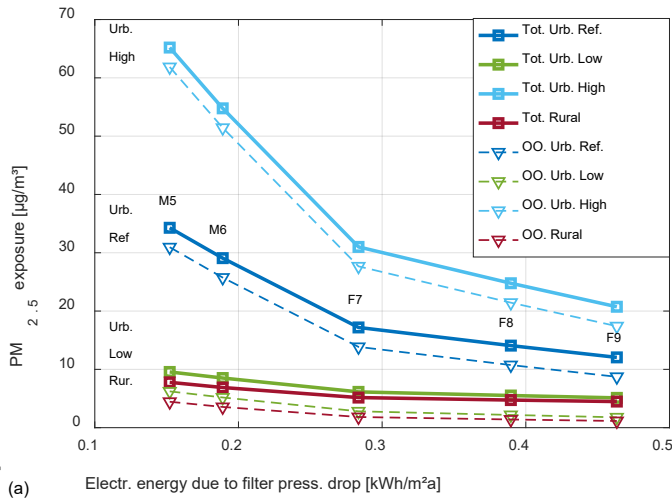

Figure 3-9 Average PM_{2.5} exposure of a person staying home all day as a function of electric energy consumption of the fan due to the pressure drop of the filter. “Urb. High” represents highly polluted areas with daily means of ~80 µg/m³, “Urb. Ref” moderately polluted areas with means of ~40 µg/m³ and “Urb. Low” low polluted urban areas with a daily mean ~8 µg/m³. The dashed line/triangle show the exposure to outdoor-originate PM.

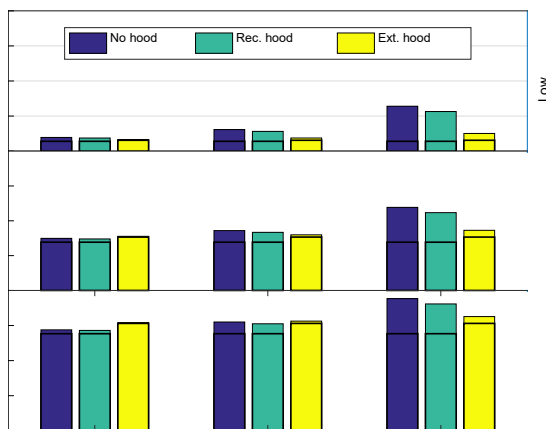

Figure 3-10 Average PM_{2.5} exposure of a person staying home all day for different outdoor concentrations, different cooking source strength and different cooktop ventilation strategies (no hood, recirculating hood and extract hood). Horizontal lines show exposure to outdoor-originate PM.

3.2.4 Further reading

Rojas, Gabriel. 2019. “Ambient Air Filter Efficiency in Airtight, Highly Energy Efficient Dwellings – A Simulation Study to Evaluate Benefits and Associated Energy Costs.” in *AIVC Proceedings*, p.920. AIVC.

3.2.5 References

- EN. 2012. “EN 779:2012 Particulate Air Filters for General Ventilation - Determination of the Filtration Performance.”
- Liu, De Ling and William W. Nazaroff. 2003. “Particle Penetration through Building Cracks.” *Aerosol Science and Technology* 37(7):565–73.
- PHI. n.d. “About Passive House - What Is a Passive House?” Retrieved September 29, 2018 (https://passiv.de/en/02_informations/01_what_is_passive_house/01_what_is_passive_house.htm).
- Riley, William J., Thomas E. McKone, Alvin C. K. Lai, and William W. Nazaroff. 2002. “Indoor Particulate Matter of Outdoor Origin: Importance of Size-Dependent Removal Mechanisms.” *Environmental Science and Technology* 36(2):200–207.
- Shi, Bingbing. 2012. “Removal of Ultrafine Particles by Intermediate Air Filters in Ventilation Systems - Evaluation of Performance and Analysis of Applications Ventilation Systems.” Chalmers University of Technology, Göteborg, Sweden.
- WHO. 2016. “Concentration of PM2.5 in Nearly 3000 Urban Areas, 2008-2015.” Retrieved May 9, 2019 (http://gamapserver.who.int/mapLibrary/Files/Maps/Global_pm25_cities_2008_2015.png).

3.3 Development of a compact ventilation system for facade integration

<i>Christoph Speer</i>									
<div style="float: right;"> Addressed topics: Health & Comfort Spatial requirements Cost & Energy consumption Refurbishment Commissioning Quality of installation User satisfaction </div>									
Assessment methods		Assessing ventilation concepts		Novel ventilation solutions		Quality assurance		Assessing in-use performance	

3.3.1 Project objectives, description & methodology

To ensure adequate air quality, ventilation is necessary in new and refurbished buildings. Mechanical ventilation systems with heat recovery enable a controlled air exchange and reduce the energy loss simultaneously. Options for small space-saving solutions are often lacking, especially for refurbishments. The Counterflow Heat Recovery Fan (CHRF) was developed, to construct a compact and space-saving ventilation system. The key component of the CHRF is one rotating crossflow fan, which generates both airflows (outdoor/supply and extract/exhaust air). The ventilation system is divided into two levels. Supply and extract air are placed in the first level, outdoor and exhaust air in the second level. Extract and outdoor air enter radially through the crossflow fan, perform a level change inside the fan and are blown out again radially. The construction model and the prototype are shown in Figure 3-9, the flow pattern of the ventilation system is shown in Figure 3-10 (left). The used crossflow fan fulfils two functions, generating supply and exhaust airflows as efficient as possible and acting as a highly efficient counter-flow heat exchanger. Therefore, different possible concepts were considered. For the first prototype, the space between the fan blades was filled with a porous foam to perform the heat recovery. In the most advantageous concept, the space is filled with horizontal thin plates to reduce the flow resistance combined with a large available surface for heat recovery. These two concepts are shown in Figure 3-10 (right). A Computational Fluid Dynamics (CFD) model was created (Figure 3-9) with the space between the fan blades being modelled as porous foam (Figure 3-10, right). The simulation results were compared with the measurement results of the constructed prototype to evaluate the CFD-model.

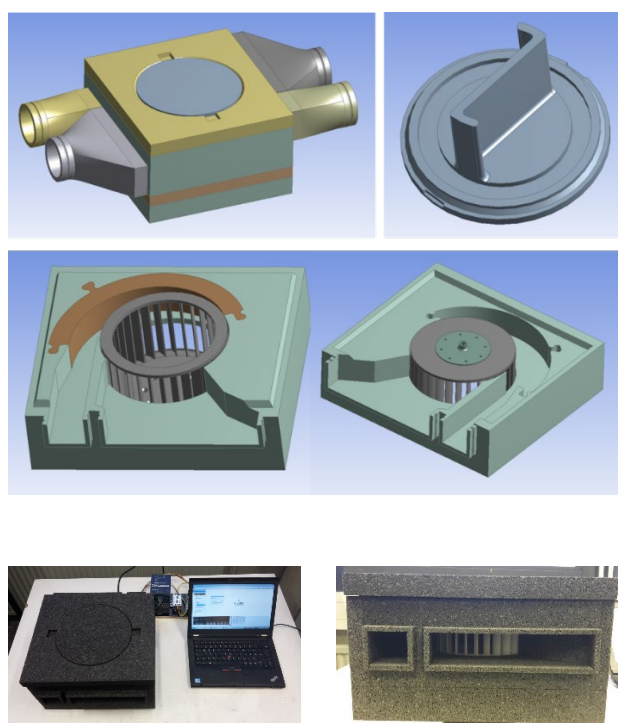

Figure 3-11 Construction model (top) and prototype (bottom) of the CHRF (Counterflow Heat Recovery Fan); (Speer and Pfluger 2017).

3.3.2 Main results and findings

The developed CHRF has a height of 15 cm and a diameter of 19 cm. The achieved flow rates, with an external pressure drop of 50 Pa at each in-/outlet and a rotational speed of 900 rpm, is in the range of 25 to 35 m³/h and changes linearly with the rotational speed. For an optional cooling mode, the top cover with separating plate of the two airflows inside the fan can be removed, so that the air intake is arranged axially. In this case, all flow paths could be used for supply air, and flow rates of 250 to 300 m³/h can be reached at a rotational speed of 900 rpm. For this scenario, the porous elements were removed (to bypass heat recovery). Due to its slim design, the CHRF unit can be integrated into the building envelope, thus saving space in the building. In Figure 3-11 a concept for the wall-integrated installation of the CHRF is presented. The outdoor air intake is arranged through a gap below the windowsill, whereas the exhaust air outlet is in the window reveal (on one side of window). Filter replacement and maintenance are performed by folding or removing the windowsill.

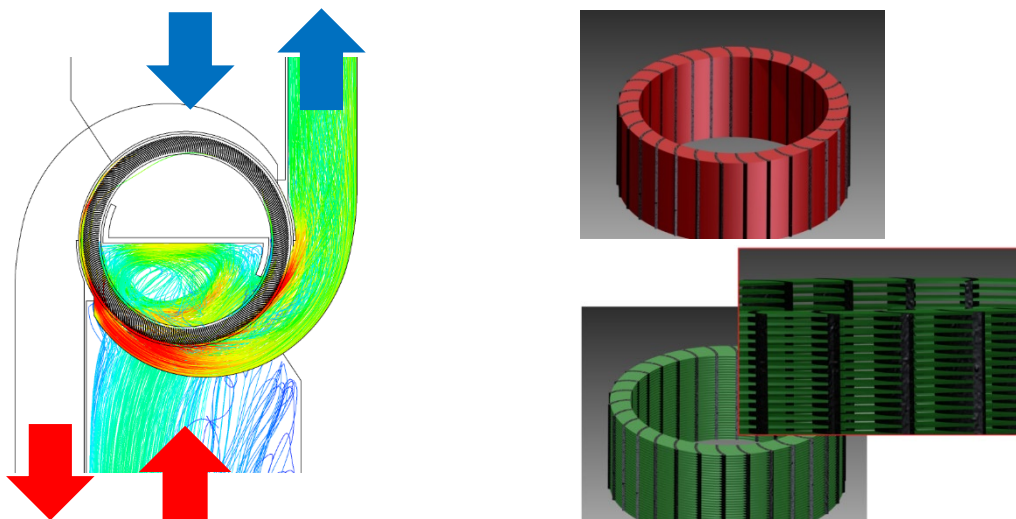

Figure 3-12 Flow conduction of the extract/exhaust airflow (left) (Speer et al. 2016) and the two rotor concepts with porous foam and horizontal plates (right) (Speer 2015a).

3.3.3 Conclusions, lessons learned for practice

The developed CHRF prototype delivers good simulation and measurement results in terms of airflow rates. Further laboratory measurements for the heat recovery rate and internal leakage are required to ensure comprehensive functionality. Due to its compactness, this concept is a promising solution for implementing façade integrated MVHR systems in energy efficient buildings. It can be scaled up to higher flow rates without increasing the system thickness. Another advantage of this concept is the potential to use it as a traditional crossflow fan with no heat recovery but high flow rates for cooling purposes. The constructive details to allow an easy switch between heat recovery and cooling mode still have to be developed. All development steps, starting from the conceptual design, the simulation-based optimization, the mechatronic implementation, to the production and measurement of the prototypes, are described in the thesis of Speer (2015b).

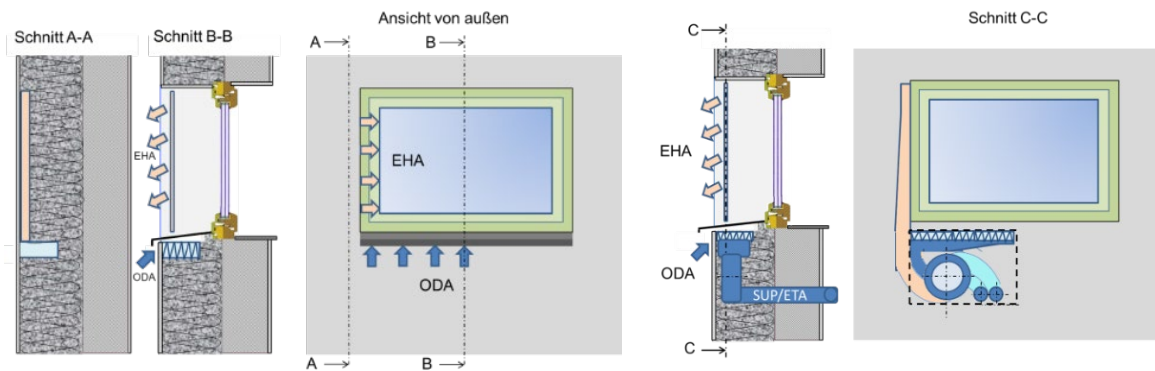

Figure 3-13 Sections and exterior view: Wall integration of the system within the insulation, outdoor air intake below the window sill, exhaust air outlet in the reveal, filter replacement and maintenance are done by folding the window sill (Speer et al. 2015).

3.3.4 Further reading

Speer, C. (2015c). Simulation und Entwicklung eines hocheffizienten Wärmerückgewinnungsventilators. University Innsbruck, doctoral thesis, 2015.

3.3.5 References

Speer, C., Pfluger R. (2017). Development and measurement results of a compact Counterflow Heat Recovery Fan for single/double room ventilation. AIVC Conference Proceedings p.439-446, Nottingham

Speer, C., et al. (2016). Development of a modified concept and acoustic measurements of the Counterflow Heat Recovery Fan. Indoor Air 2016 Proceedings (The 14th international conference of indoor air quality and climate).

Speer, C. (2015a). Rotor Concepts For The Counterflow Heat Recovery Fan. Conference Proceedings: 17th International Conference on Sustainable Building – ICSB. 1795-1798

Speer, C. et al. (2015b). Entwicklung und messtechnische Untersuchung eines dezentralen kompakten Wärmerückgewinnungsventilators. Bauphysik 37, H. 3, p.179-185.

3.4 Volatile Organic Compounds (VOC) exposure due to Floor heating systems versus Radiator heating

<i>Klaas De Jonge, Arnold Janssens, Jelle Laverge</i>									
<div style="float: right;"> Addressed topics: Health & Comfort Spatial requirements Cost & Energy consumption Refurbishment Commissioning Quality of installation User satisfaction </div>									
Assessment methods		Assessing ventilation concepts		Novel ventilation solutions		Quality assurance		Assessing in-use performance	

3.4.1 Project objectives, description & methodology

The influence of temperature and humidity has been recognized from the very beginning of research concerning emissions of Volatile Organic Compounds (VOC) from building materials. The emission rate of VOCs is mostly dependent on the diffusivity of the material. This characteristic depends on the structure of the material and the transport behavior of the VOC molecule in the gaseous state. If the temperature rises, the energy in the system will rise and diffusivity will go up, transport to the surface of the material will be easier, which will result in higher emission rates.

This influence of temperature is often neglected in VOC emission models for simulation studies. Instead, the emission rates of VOCs are assumed to be constant. The values chosen for this assumption are the measured emission rates of a sample after 3, 7 or 28 days in a small emission test chamber at a constant temperature of 296.15K (23°C) and constant Relative Humidity (RH) of 50%.

In newly built or renovated houses, the traditional radiator heating is being replaced by floor heating systems. These systems activate the floor so that it acts as the emitting body for heat. The floor is heated directly and radiates that heat to the space. The objective of this case study was to check to what extent the use of a floor heating system, which supplies the heat to the floor (VOC emitting material) directly, influences the VOC exposure of the occupants compared to the traditional radiator heating.

To do so, a CONTAM model of the Belgian reference apartment is adapted to include a dynamic formaldehyde emission model, which takes into account the influence of temperature and humidity on the emissions. This model of the reference apartment has been used in research by Laverge and Janssens concerning system analysis and optimization (Laverge and Janssens 2010, Laverge and Janssens 2013). The formaldehyde model was derived from literature and combined recent work by different authors (Liang et al. 2016, Zhang et al. 2007, Xiong et al. 2013).

A family with one working adult, one stay-at-home adult and 2 children going to school are virtually occupying the apartment. The occupancy profiles of the different occupants are derived from a large investigation

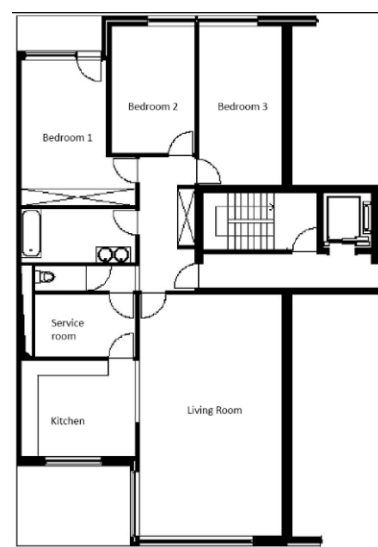

Figure 3-14 – Floor plan of Belgian reference apartment for ventilation system simulation.

concerning the average time use of a Belgian person. The simulated family can be regarded as the ‘average Belgian family’. Within this apartment and with the same occupancy, 2 x 2 cases were compared. The first two use a Belgian standard balance ventilation system, i.e. system D with both mechanical supply and exhaust with radiators or floor heating. The second set of cases has the same system D ventilation but is demand-controlled, so it is referred to as D+ ventilation. The supply airflow rates for this system are room specific and proportional to the local CO₂ concentration. The exhaust airflow rates are the same in all exhaust spaces and are proportional to the room with the highest relative humidity.

The two heating systems are implemented in a straight forward manner. For both heating systems, the system switches on if someone is present in the house and switches off when the last person has left. In the case of radiator heating, the temperature of the floor (input for VOC emission model) is assumed to be the same as the room air. For the floor heating system, the system is assumed to be climate controlled. If the heating system is on, the temperature of the floor is inversely proportional to the outside temperature. At a minimum of 265.15K (-8°C) outside temperature, the floor will have a maximum temperature of 308.15K (35°C). An outside temperature of -8°C is rare in Belgium so the 35°C will not be reached regularly. The ‘floor temperature’ is the temperature inside the material. The floor surface temperature will be lower.

3.4.2 Main results and findings

The results show a significant impact of the chosen heating system on the exposure to VOCs. The higher temperatures occurring in the floor heating system will result in higher emission rates, which is reflected in the level of VOC exposure for the occupant. Figure 3-13 shows the relative difference in exposure to VOCs for the adult with floor heating compared to the system without floor heating on a winter day. For both system D and D+, the exposure to VOCs related to the use of floor heating could be more than 4 times higher than the exposure when radiator heating is used.

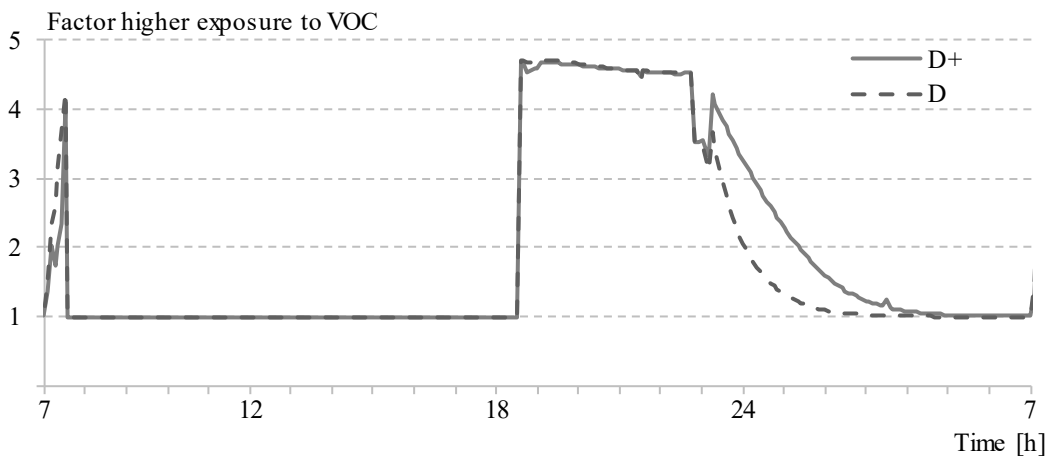

Figure 3-15 - Graphs showing the relative difference in VOC exposure throughout one day during winter (Exposure to VOC with floor heating system / Exposure to VOC with radiator heating) of a simulated Belgian working adult for both investigated ventilation systems (D and D+).

3.4.3 Conclusions, lessons learned for practice

Although these results are preliminary and further investigation is necessary, there are some things that can be concluded based on these results. The use of a floor heating system will contribute significantly to the exposure to VOCs. This is because the wooden flooring material, which is a known big contributor of VOCs to the indoor environment, is heated to temperatures exceeding the temperatures of the floor when radiator heating is used, so VOC emissions are enhanced. Floor heating systems working with a lower temperature regime will lower this difference and will, in the end, result in less exposure to VOCs.

The results show that when floor heating is being used, extra caution should be made about the choice of materials for the construction and finishing of floors, with a preference for low VOC materials. Although the choice of radiator heating above floor heating seems obvious based on these results, the advantages of using floor heating on a system level should not be overlooked.

3.4.4 Further reading

K. De Jonge, “The impact of demand controlled ventilation on indoor VOC exposure in Belgian dwellings,” Master dissertation, Ghent University, 2018

3.4.5 References

J. Laverge and A. Janssens, “Optimization of design flow rates and component sizing for residential ventilation,” *Build. Environ.*, vol. 65, pp. 81–89, Jul. 2013.

J. Laverge and A. Janssens, “Residential ventilation system optimization using Monte-Carlo and genetic algorithm techniques,” in *ASHRAE IAQ, 16th Conference, Proceedings*, 2010.

W. Liang, M. Lv, and X. Yang, “The combined effects of temperature and humidity on initial emittable formaldehyde concentration of a medium-density fiberboard,” *Build. Environ.*, vol. 98, pp. 80–88, Mar. 2016.

Y. Zhang, X. Luo, X. Wang, K. Qian, and R. Zhao, “Influence of temperature on formaldehyde emission parameters of dry building materials,” *Atmos. Environ.*, vol. 41, no. 15, pp. 3203–3216, May 2007.

J. Xiong, W. Wei, S. Huang, and Y. Zhang, “Association between the Emission Rate and Temperature for Chemical Pollutants in Building Materials: General Correlation and Understanding,” *Environ. Sci. Technol.*, p. 130709124156006, Jul. 2013.

K. De Jonge, “The impact of demand controlled ventilation on indoor VOC exposure in Belgian dwellings,” Master dissertation, Ghent University, 2018.

3.5 Control strategies for mechanical ventilation in Danish low-energy apartment buildings

<i>Jakub Kolarik, Johan Bojsen, Mathias J. Larsen, Daria Zukowska</i>									
<div style="float: right;"> <p>Addressed topics:</p> <ul style="list-style-type: none"> Health & Comfort Spatial requirements Cost & Energy consumption Refurbishment Commissioning Quality of installation User satisfaction </div>									
Assessment methods		Assessing ventilation concepts		Novel ventilation solutions		Quality assurance		Assessing in-use performance	

3.5.1 Project objectives, description & methodology

The Danish building regulations (DTCHA 2018) as well as regulations in other European countries emphasize energy efficient construction. This leads to strict requirements regarding primary energy use for both the non-residential and residential sectors. At the same time, the building regulations demand ventilation rates that ensure indoor air quality and avoid problems with moisture. The application of the aforementioned requirements in newly constructed residences leads almost exclusively to the application of mechanical ventilation with heat recovery (Bocanegra-Yanez et.al. et al. 2017). At the same time, these systems still meet a certain hesitation in the general public, mainly due to operation-related problems like noise, draught and increased electricity bills (Chendari et al. 2016, Bocanegra-Yanez et.al. et al. 2017). The application of suitable control strategies for these systems is therefore becoming increasingly important.



Figure 3-16 City quarter Nordhavn in Copenhagen, Denmark.

The objective of the project was to utilize a dynamic building simulation program to investigate ten different ventilation control strategies applicable in low-energy residencies (Kolarik et al. 2019). A sensitivity analysis was conducted to explore the influence of various input parameters. One strategy used a constant air volume (CAV) ventilation rate. The remaining strategies used variable air volume (VAV) control, in which the ventilation rate was adjusted according to different indoor environmental quality (IEQ) parameters (temperature, carbon dioxide concentration, relative humidity) i.e. demand control was implemented. The parameters were measured either in the exhaust duct or in specific rooms of the apartment. The investigated strategies were evaluated according to primary energy use and IEQ they provided. The degree hour approach according to EN 15251 (CEN 2007) was applied to evaluate IEQ. The weighted average of degree hours for temperature, CO₂ concentration and relative humidity was used as common IEQ index (*I_{IEQ}*). The project focused on future residential buildings. Therefore, a 94 m² dwelling in a low-energy apartment block placed in Nordhavn (Figure 3-14) near Copenhagen, Denmark was used as a case study (Figure 3-15). It was constructed to meet the Danish nearly-zero-energy building class called 2020 (DTCHA 2018).

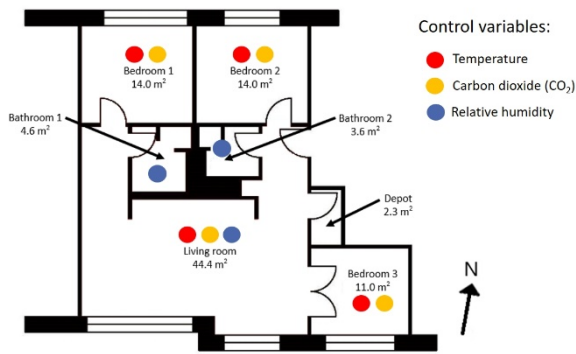

Figure 3-17 Floorplan of the case study apartment.

Ten input parameters were considered for the sensitivity analysis: heating setpoint, occupancy, window opening, internal heat gain, internal moisture gain, window area, solar heat gain coefficient, solar shading and night ventilation by windows in bedrooms.

The sensitivity analysis was based on the so-called Morris method (Morris 1991). The range of five values-levels for each input parameter was determined using a probability density function. Altogether 1100 simulations were conducted using randomly selected combinations of levels for all input parameters.

3.5.2 Main results and findings

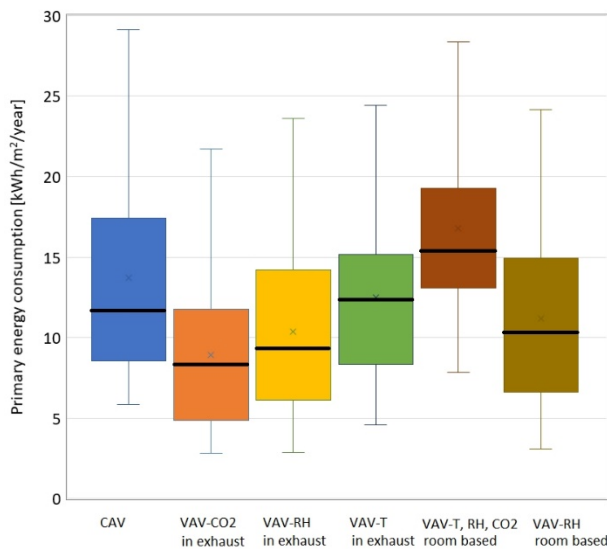

Figure 3-18 Primary energy consumption for selected control strategies; black horizontal lines indicate median.

Figure 3-16 presents the results of the sensitivity analysis regarding primary energy use. The influence of input parameter variations is represented by the colored area of each box, which corresponds to 50% of the results for each strategy; whiskers indicate the minimum and maximum primary energy use. Black lines indicate the central tendency-median values. Room based control with all sensor types led to the highest primary energy use, but the size of the interquartile range (height of the coloured box) indicating the spread of the primary energy use caused by variation of inputs was the smallest. The constant air volume ventilation had the third-highest median primary energy use and the largest spread of data suggesting that it was the least robust with respect to the variation of inputs. Further analysis revealed that the window opening had a large influence on primary energy use, overheating, air quality and relative humidity levels. The setpoint for space heating had the largest influence on primary energy use.

Figure 3-17 presents the results in relation to IEQ. The room-based ventilation using all sensors ensured the best IEQ. However, it was at the expense of high primary energy use. Additionally, higher installation costs would need to be considered in the case of such a system. The control strategy with a humidity sensor in the exhaust duct, which is typically used in Danish residential ventilation today, had the second-lowest primary energy use. Its IEQ related performance was slightly below average. The strategy with the locally placed relative humidity sensors (bathroom and kitchen-living room) seems to be an interesting alternative as it provided improved IEQ - mainly with respect to lower CO₂ concentrations, while still having relatively low primary energy use. Constant air volume ventilation provided the second best IEQ, but its median primary energy use was the third-highest and had the largest spread.

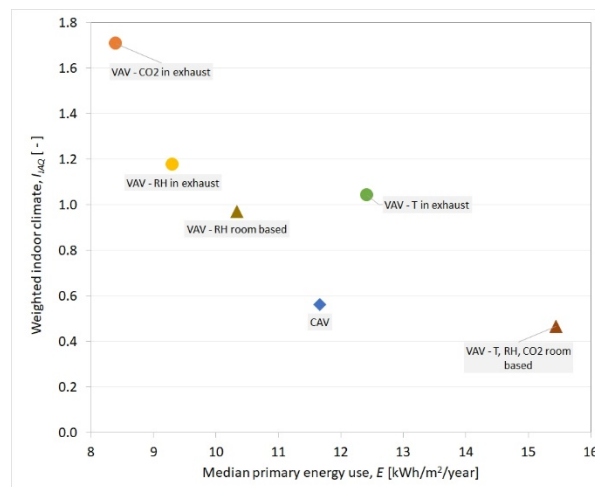

Figure 3-19 Comparison of selected ventilation strategies; higher weighted indoor climate index IIEQ indicates more hours outside comfort limits.

3.5.3 Conclusions, lessons learned for practice

Advanced room based demand-controlled ventilation strategies provide high indoor environmental quality, but their excellent performance can be accompanied by increased energy use. Temperature based control strategies do not seem to provide IEQ benefits that could compensate for increased energy use. Constant air volume ventilation is the simplest and cheapest strategy, which showed credible results for IEQ while having moderate energy use. At the same time, when applying a constant air volume strategy, the largest variability of performance due to changes in input values can be expected. Humidity-based control strategies seem to provide an acceptable combination of IEQ and energy-related performance.

3.5.4 Further reading

Kolarik, J., Zukowska-Tejsen, D., Bojsen, J., Larsen, M. J. 2019. Sensitivity analysis of control strategies for mechanical ventilation in low-energy residences. In proceedings of 10th Int. Conference on Indoor Air Quality, Ventilation and Energy Conservation in Buildings, Bari, Italy

3.5.5 References

del Carmen Bocanegra-Yanez, M., Rojas, G., Zukowska-Tejsen, D., Burman, E., Cao, G., Hamon, M., Kolarik, J. 2017. Design and operation of ventilation in low energy residences – A survey on code requirements and building reality from six European countries and China. In proceedings of 38th AIVC Conference, Nottingham, United Kingdom

DTCHA 2018. The building regulations - BR18. Danish Transport, Construction and Housing Authority <http://byggningsreglementet.dk/> (visited January 2019)

Chendari, B., Carrilho, J. D., da Silva M. G. 2016. Towards sustainable, energy-efficient and healthy ventilation strategies in buildings: A review. *Renewable and Sustainable Energy Reviews* 59, 1426-1447

CEN 2007. EN 15 251 Indoor environmental input parameters for design and assessment of energy performance of buildings addressing indoor air quality, thermal environment, lighting and acoustics. European Committee for Standardization. Brussels, Belgium

Kolarik, J., Zukowska-Tejsen, D., Bojsen, J., Larsen, M. J. 2019. Sensitivity analysis of control strategies for mechanical ventilation in low-energy residences. In proceedings of 10th Int. Conference on Indoor Air Quality, Ventilation and Energy Conservation in Buildings, Bari, Italy

Morris, M.D. 1991. Factorial sampling plans for preliminary computational experiments. *Technometrics*, 33(2), 161–174

3.6 Response of commercially available Metal Oxide Semiconductor Sensors under air polluting activities typical for residences

<i>Jakub Kolarik, Nadja L. Lyng, Rossana Bossi, Thomas Witterseh, Kevin M. Smith and Pawel Wargocki</i>					Addressed topics: Health & Comfort Spatial requirements Cost & Energy consumption Refurbishment Commissioning Quality of installation User satisfaction				
Assessment methods		Assessing ventilation concepts		Novel ventilate solutions		Quality assurance		Assessing in-use performance	

3.6.1 Project objectives, description & methodology

Demand Controlled Ventilation (DCV) is based on the adjustment of airflows according to demand determined by indoor air quality (IAQ), thermal environment, etc. Sensors measuring CO₂ are mostly utilized to determine IAQ. However, these sensors are rather expensive and their operation is energy demanding, so continuous connection to the electricity grid is inevitable. Many practitioners also mention issues with the long-term stability of CO₂ sensors. Their signal drifts away from the calibration curve and the automatic baseline reset is not considered good practice. Moreover, CO₂ concentration is a good surrogate of pollutants emitted by humans, but it does not take into account other pollutants, like for example, chemicals emitted from cooking, cleaning or building materials. Metal Oxide Semiconductor (MOS) sensors measuring Volatile Organic Compounds (VOC) seem to offer a cheaper and energy efficient alternative to the currently used sensors (Herberger and Ulmer 2012). They are sensitive to a broad range of compounds, and thus ventilation can also be triggered in cases of emission of pollutants that are undetectable by standard CO₂ sensors. Their lower price means that DCV ventilation could be applied also in projects where the high price of sensors as well as installation costs disqualifies DCV with traditional sensors. Although all of the above-mentioned arguments speak for MOS VOC sensor technology, recent research shows that the simple replacement of CO₂ sensors with VOC sensors is not enough to achieve the desired effect (De Sutter et al. 2017, Kolarik 2014). Kolarik (2014) showed that using VOC measurement would trigger increased ventilation in contradiction to CO₂ measurement for 11% of the occupied time. De Sutter et al. (2017) point out high variability of the VOC signal as well as a challenge in the definition of setpoint values.

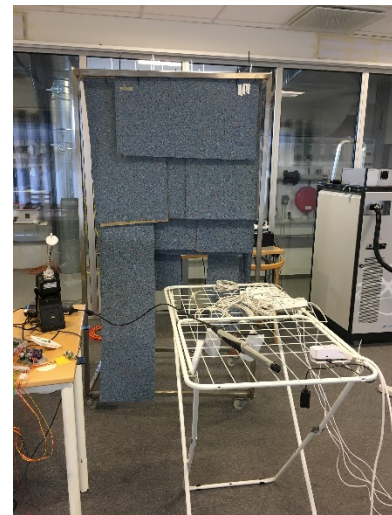

Figure 3-20 Experimental set-up with sensors and linoleum as a pollution source.

The objective of the project, which was a collaboration between the Technical University of Denmark, Danish Technological Institute and Aarhus University, was to study the response of commercially available MOS VOC sensors to pollutants emitted during typical activities in residences.

The activities included cooking, cleaning, painting, emission from linoleum and emission of human bioeffluents. Additionally, an emission of ethanol was tested. This exemplified a rather strong emission of a single compound, which could be used as a reference. The study was conducted in the so-called EnergyFlexOffice (EFO) at the Danish Technological Institute (Figure 3-18), which is a field laboratory originally designed to mimic an office environment. The test room used for experiments had a floor area of 31.5 m² and height 2.6 m. It was mechanically ventilated at constant air-change of approx. 0.5 h⁻¹. The temperature and relative humidity were kept constant at 23 °C and 50% respectively. Besides the MOS VOC sensors, the VOC emitted into the test room were continuously measured by the precise analytical instrument Proton Transfer Reaction-Time of Flight-Mass Spectrometer (PTR-ToF-MS), which can detect real-time VOC concentrations down to the ppb range. The PTR-ToF-MS measurements were used to determine an aggregated Total Volatile Compounds signal (TVOC_{PTR-TOF-MS}), which was compared to MOS VOC signals.

Table 3-4 Overview of tested sensors; price level per sensor:
* - <10 EUR, ** <100 EUR, *** - >100 EUR.

Sensor	Output signal [unit]	Sensing range	Auto-calibration (price level)
A	CO ₂ equivalent [ppm] TVOC [ppb]	400-2000 ppm 0-1000 ppb	Yes (**)
B	CO ₂ equivalent [ppm] TVOC [ppb]	450-2000 ppm 125-600 ppb	Yes (**)
C	0 – 5 [V]	10-300 ppm NH ₃ 10-1000 ppm C ₆ H ₆ 10-300 ppm Alcohol	No (*)
D	0-10 [V]	0-100 % air quality	Yes (***)
E	0-10 [V]	0-100 % air quality	Yes (***)

Table 3-1 shows an overview of the tested sensors. Four of them were equipped with an embedded algorithm for so-called auto-calibration. The precise logic of the algorithm was proprietary, however, a general functionality was to use the lowest measured concentration over a longer period as a “clean air” baseline. Sensors A and B were able to provide digital output and were integrated in a Cloud-connected data logger. Sensors C, D and E provided

analogue output (voltage) and were therefore connected to a laboratory data logger.

3.6.2 Main results and findings

Figure 3-19 illustrates the relative nature of the MOS VOC sensor measurement. The response of two sensors from different producers was similar in concentration pattern but differed in absolute values of measured concentration. Similar results were observed for all studied sensors. To eliminate the effect of relative measurement, the MOS VOC sensor signals were normalized using the so called min-max feature scaling, which brings each particular signal into a range [0, 1]. Figure 3-20 presents signals from all tested sensors as well as the TVOC_{PTR-TOF-MS} signal in its normalized form during cleaning. It can be clearly seen that all sensors detected the pollution peak, but the behaviour of the sensor signals after the activity was finished was rather diverse. Sensors A, B and D followed the TVOC_{PTR-TOF-MS} signal, and thus their response seemed to be in line with the analytical measurements. The signal from sensor E did not decay at the same rate as TVOC_{PTR-TOF-MS}. Signal C decayed but then increased again. It was not possible to determine the reason for this secondary increase. No other pollution source was present in the test room. Furthermore, none of the compounds identified by the PTR TOF MS measurements had a similar pattern as the signal C. The correlation between particular MOS VOC sensor signals and TVOC_{PTR-TOF-MS} was investigated for all tested activities using the Pearson correlation coefficient.

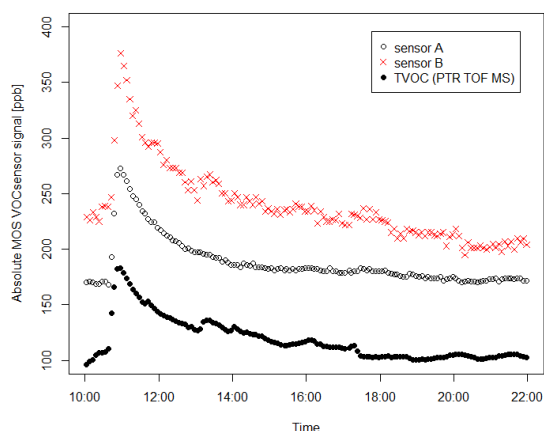

Figure 3-21 Activity: cleaning with detergent; MOS VOC signal from sensors A and B compared with TVOC_{PTR-TOF-MS}.

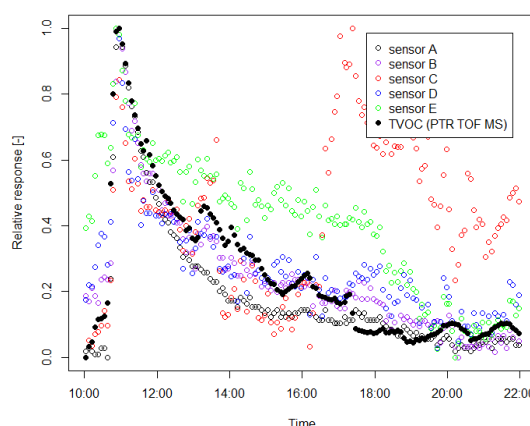

Figure 3-22 Activity: cleaning with detergent; normalized MOS VOC signals compared with TVOC_{PTR-TOF-MS}.

Table 3-2 summarizes correlation coefficients for the tested activities. It can be seen that generally the signal from the MOS VOC sensors was in a good correlation with TVOC_{PTR-TOF-MS} signal, which suggests that MOS VOC sensors were able to detect the pollution emitted during the activities. The active layer of sensor A was most probably poisoned during the painting activity as it produced a constant signal at the higher end of its measuring range. Sensor C showed the worst correlation in general and one can speculate whether it was influenced by the absence of an auto-calibration algorithm or just more generally by low production quality that enabled a sensor price under 10 EUR per piece.

3.6.3 Conclusions, lessons learned for practice

Table 3-5 Values of Pearson correlation coefficient for representing correlation between TVOC_{PTR-TOF-MS} signal and signal from MOS VOC sensors; values >0.7 indicate large correlation, values <0.3 indicate low correlation.

Activity / Sensor	A	B	C	D	E
Cleaning	0.95	0.96	0.04	0.89	0.80
Linoleum	0.97	0.97	0.57	0.85	0.75
Bioeffluents	0.91	0.82	0.80	0.94	0.98
Painting	-0.07	0.98	0.98	0.97	0.92
Cooking	0.98	0.97	-0.39	0.93	0.89
Clean. w/o detergent	0.86	0.97	0.76	0.81	0.21
Ethanol	0.93	0.95	0.95	0.85	0.91

The study has showed that MOS VOC sensors were able to detect pollution emitted during different activities like cleaning, human presence (human emitted gases, so-called “bioeffluents”), painting or cooking. In the majority, the signal produced by the MOS VOC sensors could be correlated with measurements from highly precise laboratory equipment representing an aggregated VOC concentration in the

room. The cheapest tested sensor had the worst performance. Due to the fact that MOS VOC sensors measure the relative change of VOC concentrations in their surroundings, it is difficult to compare absolute values of concentrations measured by several sensors. For the same reason, it is difficult to define a clear set-point that would be applicable for a demand-control ventilation system. Normalization of the sensor signal seems to be a way forward; however, such an approach is suitable rather for reverse analysis of measured data than for real-

time control of ventilation. The auto-calibration algorithms embedded in some of the sensors are supposed to ensure a “baseline” determined using the lowest measured concentration over a certain (sufficiently long) period. However, they cannot determine whether the baseline conditions truly represent “clean air”. This would need to be ensured by the operator of the ventilation system. The current study as well as up to date research suggests that ventilation control strategies would need to be redefined or, at least, significantly adjusted for use of MOS VOC sensors. Results suggest that MOS VOC sensors could be complementary to traditional sensors used for DCV. Their task would be to indicate “pollution events” that would otherwise go “under the radar” of CO₂ sensors. This would enable additional ventilation when emissions of VOC are not driven by a human presence. A typical example could be the increased ventilation in an office building when the cleaning personnel is at work while regular occupants are not present.

3.6.4 Further reading

Kolarik, J., Lyng Lyng, N., Laverge, J. 2020 Metal Oxide Semiconductor sensors to measure Volatile Organic Compounds for ventilation control. Report from the AIVC Webinar: "Using Metal Oxide Semiconductor (MOS) sensors to measure Volatile Organic Compounds (VOC) for ventilation control", held on September 4, 2018, Air Infiltration and Ventilation Centre, www.aivc.org

3.6.5 References

Herberger, S., Ulmer, H. 2012. Indoor Air Quality Monitoring Improving Air Quality Perception. *Clean-Soil Air Water*, 40 (6), 578-585

Kolarik, J. 2014. CO₂ Sensor versus Volatile Organic Compounds (VOC) sensor – analysis of field measurements and implications for Demand Controlled Ventilation. In proceedings of Indoor Air 2014, Hong-Kong, China

De Sutter, R., Pollet, I., Vens, A., Losfeld, F. and Laverge, J. 2017. TVOC concentrations measured in Belgium dwellings and their potential for DCV control. In Proceedings of 38th AIVC Conference, 6th TightVent Conference, 4th Venticool Conference Ventilating healthy Low-energy buildings, pp 889–896

3.7 Impact of multi zone air leakage modelling on ventilation performance and indoor air quality assessment in low-energy houses

<i>Gaëlle Guyot, Hugo Geoffroy, Michel Ondarts, Léna Migne, Mallory Bobee, Ariane Lesage, Evelyne Gonze and Monika Woloszyn</i>						Addressed topics: 			
Assessment methods		Assessing ventilation concepts		Novel ventilation solutions		Quality assurance		Assessing in-use performance	

3.7.1 Project objectives, description & methodology

As airtightness is recognized as an essential issue for low energy dwellings, it is nowadays often included in energy-performance (EP) calculations, often through single zone models with uniform air leakage. Because more consideration is often given to energy performance than to indoor air quality issues, air leakage through internal partitions is often disregarded. Thus, additional studies are needed to check these current assumptions. The objective of this study is to investigate the impact of air leakage through the building envelope and through internal partitions on indoor air formaldehyde concentrations.



Figure 3-23: Picture of the studied house.

The studied building is a 2 stories-low-energy brick house equipped with a balanced ventilation system, located near Chambéry, France (Figure 3-21).

A measurement campaign was conducted in order to quantify and finely describe envelope and internal partitions air leakage (Guyot et al. 2016). The envelope airtightness was $n_{50}=1.5 \text{ h}^{-1}$ and internal partitions walls (excluding internal doors) were measured as rather airtight, with a median value of $q_{50}=0.8 \text{ m}^3 \cdot \text{h}^{-1} \cdot \text{m}^{-2}$. Formaldehyde concentrations were investigated using numerical modelling with CONTAM software. We used a multi zone model for the dwelling (each room was one zone), with a 10 minutes time step over the heating period, with meteorological data of a typical year in Lyon.

Four cases of detail in modelling air leakage were simulated and compared: airtight envelope (case a), evenly distributed envelope air leakage (case b), uneven envelope air leakage (case c) and uneven external and internal air leakage (case d). With case a, we calculated airflows due to mechanical ventilation only. Cases b, c and d used experimental data on air leakage performed on this low energy house.

In order to further study the impact of internal partition air leakage, we defined and compared four other cases taking into account measured values and input values proposed in (Guyot et al. 2016) for heavy and wood structures.

Internal doors were assumed to be closed to not underestimate occupant exposure, especially during night periods, and doors' undercuts were modelled separately, as they are not included in the internal air leakage.

The ventilation system is supposed to provide regulatory compliant airflows: 135 m³/h for a six-room house, with 2 bathrooms (30 m³/h) and 2 toilets (15 m³/h). This accounts for a dwelling air change rate (ACR) of 0.4 h⁻¹. Regulations require that kitchen exhaust should be able to switch from a base airflow of 45 m³/h to a peak airflow of 135 m³/h. We studied two types of constant airflow ventilation: exhaust-only and balanced ventilation.

We used a multi-zonal modelling approach with three levels of emissions (4.5, 12.0 and 23.6 µg h⁻¹·m⁻²), to calculate IAQ metrics based on formaldehyde. The three selected metrics were calculated in each zone: the average concentration in each zone, the ratio between this average concentration and the limit value (ELV) of 9 µg·m⁻³ (Cony Renaud Salis et al. 2017) and the percentage of time exceeding the ELV.

3.7.2 Main results and findings

The analysis of results shows that whatever the case and whatever the ventilation system, average formaldehyde concentrations were higher than the selected threshold of 9 µg·m⁻³, except for the lower emission rate of 4.5 µg·h⁻¹·m⁻². We must here specify that the French regulatory threshold is higher: 30 µg·m⁻³ since January 2015, but should become 10 µg·m⁻³ in 2023. Moreover, emission rates were estimated on a small sample including only 10 houses. Performing the calculation on a larger sample could lead to different emission rates and thus different results.

We also observe that balanced ventilation gives lower concentrations than the equivalent exhaust-only ventilation providing the same exhaust airflow of 135 m³·h⁻¹. For instance, for the lower emission rate, ELV was never exceeded with the balanced ventilation, whereas it was exceeded in four zones more than 30% of the time with the exhaust-only ventilation, including a room for 70% of the time.

In the studied house, we can also observe that using an unevenly distributed envelope airtightness had a strong impact (up to 52%) on formaldehyde concentrations with exhaust-only ventilation but also an impact (up to 18%) with balanced ventilation. With an exhaust-only ventilation system, the impact of using internal partitions' air leakage reached up to 20%. With balanced ventilation, the impact was very light (up to 3%) because of the lower pressure differences between zones. This also suggests that the impact of modelling doors' undercuts might be light with such a ventilation system, since we can get the same order of magnitude from the size-of-path between an undercut and a leak in an internal partition (Guyot et al. 2016).

3.7.3 Conclusions, lessons learned for practice

The conclusions are that it seems relevant to use detailed data on envelope airtightness to assess ventilation performance at the design stage of a building. Indeed, impacts on average formaldehyde concentrations can reach 52% with exhaust-only ventilation and 18% with the equivalent balanced ventilation. Taking into account detailed data on internal partitions' air leakage seems worthwhile with an exhaust-only ventilation system but not necessary with balanced ventilation systems. Such results must be confirmed through the on-going modelling study concerning other metrics based on other parameters (PM_{2.5}, humidity, CO₂).

As a general perspective, we need to obtain more emission rates in the literature on formaldehyde but also on other pollutants of concern as particulate matter, at a house scale.

3.7.4 Further reading

Guyot, G., H. Geoffroy, M. Ondarts, L. Migne, M. Bobee, A. Lesage, Monika Woloszyn, and Evelyne Gonze. 2019. “Impact of Multizone Air Leakage Modelling on Ventilation Performance and Indoor Air Quality Assessment in Low-Energy Houses.” *Building Simulation Journal*.

3.7.5 References

Cony Renaud Salis, Louis, Marc Abadie, Pawel Wargocki, et Carsten Rode. 2017. « Towards the Definition of Indicators for Assessment of Indoor Air Quality and Energy Performance in Low-Energy Residential Buildings ». *Energy and Buildings* 152 (octobre): 492-502. <https://doi.org/10.1016/j.enbuild.2017.07.054>.

Guyot, Gaëlle, Jérémy Ferlay, Evelyne Gonze, Monika Woloszyn, Pierre Planet, et Thibaud Bello. 2016. « Multizone air leakage measurements and interactions with ventilation flows in low-energy homes ». *Building and Environment* 107 (octobre): 52-63. <https://doi.org/10.1016/j.buildenv.2016.07.014>.

3.8 Towards a better integration of indoor air quality and health issues in low-energy dwellings: Development of a performance-based approach for ventilation (PhD thesis)

Gaëlle Guyot									
<div style="float: right;"> Addressed topics: Health & Comfort Spatial requirements Cost & Energy consumption Refurbishment Commissioning Quality of installation User satisfaction </div>									
Assessment methods		Assessing ventilation concepts		Novel ventilation solutions		Quality assurance		Assessing in-use performance	

3.8.1 Project objectives, description & methodology

In future building regulations 2020, building performance is going to be extended to global performance, including indoor air quality (IAQ). In the energy performance (EP) field, successive regulations pushed for a "performance-based" approach (Spekkink 2005), Figure 3-22, based on an energy consumption requirement at the design stage. Nevertheless, ventilation regulations throughout the world are still based on prescriptive approaches, setting airflows requirements. This thesis should develop a performance-based approach to ensure that ventilation is designed to avoid risks for occupants' health.

Given the European context with the generalization of nearly zero energy buildings, envelope airtightness is often included in EP-calculations, frequently through single-zone models with uniform air leakage. Because more consideration is often given to EP rather than to IAQ, the impact of several zones interconnected by unevenly distributed leaks, on the envelope and internal partition walls, is a rarely investigated issue. We propose to study it in this thesis.

As a result, the two objectives of this PhD thesis could be summarized:

1. Quantify impacts of multizone modelling taking into account the uneven distributions of envelope and internal partition walls air leakage on the ventilation performance assessment,
2. Develop a performance-based approach for ventilation to be used at the design stage of a low energy house.

"Turn left at the next traffic lights, then take the fourth street to the right, go right ahead at the first roundabout, turn to the right at the second roundabout and keep the left lane, then turn"



Spekkink, D. 2005. Key note presentation on PeBBu, CIB Conference, Helsinki, 2005

"To the airport!"



Spekkink, D. 2005. Key note presentation on PeBBu, CIB Conference, Helsinki, 2005

Figure 3-24 Illustration of (a) a prescriptive approach; (b) a performance-based approach. Source: (Spekkink, 2005).

3.8.2 Main results and findings

Firstly, we conducted an experimental study on multizone (internal partition walls and external walls) air leakages of 23 detached houses and developed an innovative database. The analysis of this database reveals that internal air leakage can become significant at door undercuts and that the type of building structure has a great influence. We proposed air leakage values and dispersion input data (interquartile ranges) for multizone IAQ models. Then, through the multizone modelling of a low-energy house case study, we quantified the impacts of these air leakage distribution data on IAQ. We modelled CO₂, humidity and formaldehyde with two types of ventilation (exhaust-only or balanced). We highlighted strong impacts and concluded that detailed air leakage distributions should be used in IAQ performance assessment methods.

An extensive review of work combined with complementary analysis allowed us to come up with the development of a performance-based approach for house ventilation to be used at the design stage in regulatory calculations. We selected the use of five relevant IAQ performance indicators, based on CO₂, formaldehyde and PM_{2.5} exposures, and RH-based indicators assessing both condensation (high relative humidity) and health risks (high and low humidity). We proposed also that pollutant emission data and occupancy schedules be used. Lastly, we described the multizone modelling rules, the physical models and associated assumptions and the boundary conditions.

Importantly, we demonstrated that our proposed performance-based method was applicable, applying it to a low-energy house case study. We assumed being at the design stage of a house which should comply with a hypothetical regulation, requiring IAQ performance indicators and associated thresholds. We also demonstrated how such an approach could help at the design stage in key choices, such as the type of structure (regarding its impact on air leakage distributions), the type of ventilation system and the level of pollutant emissions. Indeed, in the studied case, only the balanced ventilation combined with the low or medium-emission class of formaldehyde emissions allowed us to fulfil the IAQ requirements. We showed also that such an approach could help in ventilation design, notably the distribution of the air inlets and/or outlets, or even the airflows, to secure the fulfilment of IAQ requirements.

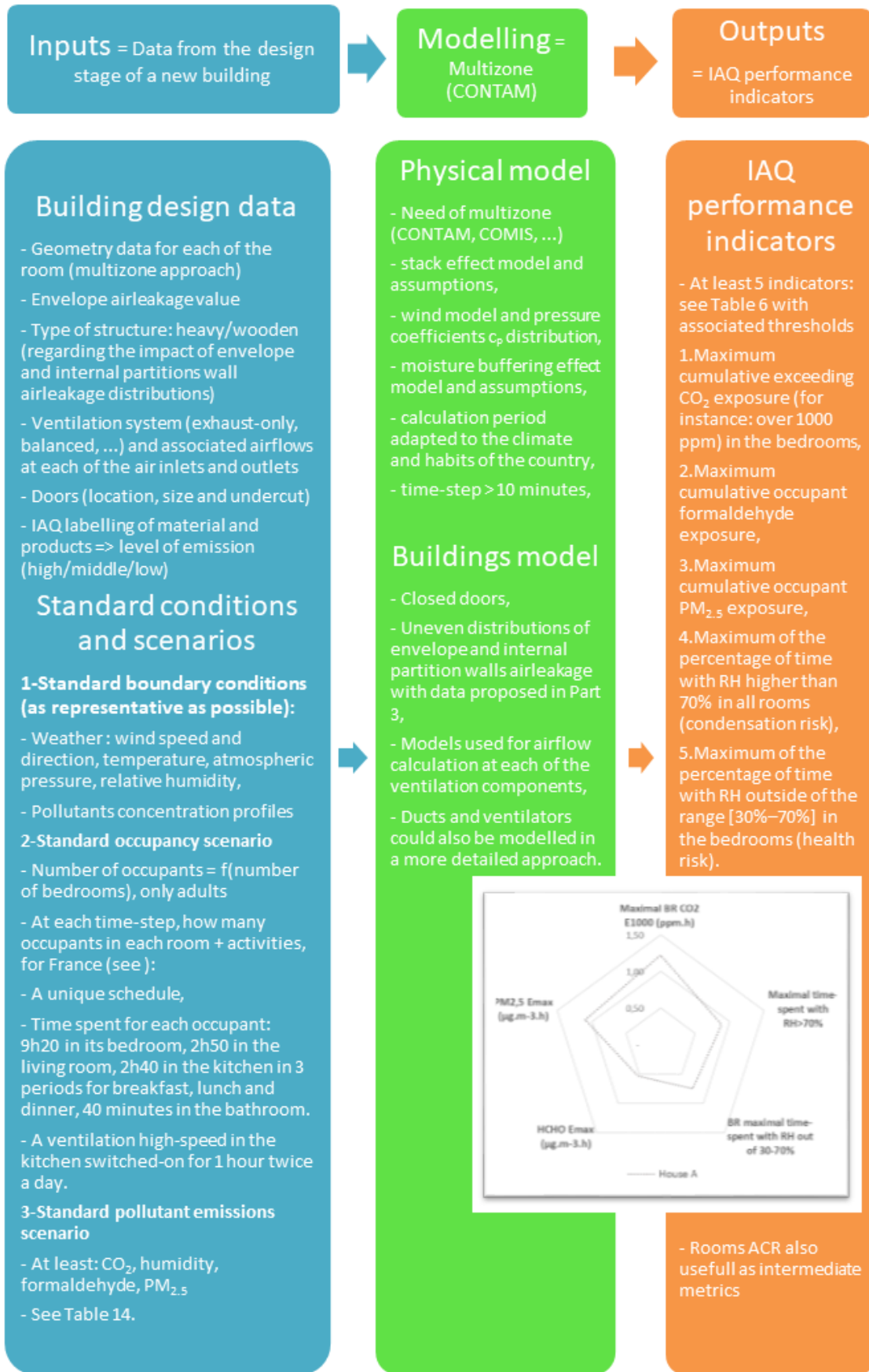

Figure 3-25 Overview scheme illustrating the proposed performance-based approach for ventilation.

3.8.3 Conclusions, lessons learned for practice

Several limitations and perspectives could be highlighted. Facing a lack of data on pollutant emissions rates at the building scale, it was not possible to include peak exposure and PM_{2.5} in our approach, but it should be definitively completed later, as soon as additional data are published. We showed that the proposed performance-based approach for ventilation was already applicable in houses equipped with constant-airflow reference ventilation systems. The next step is to check the applicability of the method when applied to smart ventilation systems, as the humidity-based system is a reference system in France.

From a general perspective, it would now be suitable to study how such a performance-based method at the design stage of a building could be combined with IAQ or in-situ measurements of airflows to secure the performance at initial commissioning and sustainably for the whole residential building life. Lastly, ventilation performance has been restricted to IAQ performance in this work. It is necessary to extend our method to the global performance of a building, including the energy performance issue, the indoor environment quality (not only IAQ but also comfort), life-cycle and environmental performance.

3.8.4 Further reading

Guyot, Gaëlle. 2018. “Towards a Better Integration of Indoor Air Quality and Health Issues in Low-Energy Dwellings: Development of a Performance-Based Approach for Ventilation.” PhD Thesis, Le Bourget du lac: Université Savoie Mont Blanc.

3.8.5 References

Guyot, G., 2018. Towards a better integration of indoor air quality and health issues in low-energy dwellings: Development of a performance-based approach for ventilation (PhD Thesis). *Energétique et Génie des procédés*. Université Savoie Mont Blanc, Université Grenoble Alpes.

Spekkink, D., 2005. Key note presentation on Performance-Based Building (PeBBu), in: CIB Conference. Helsinki, Finland

3.9 List of key pollutants for design and operation of ventilation in low-energy housing

<i>Marc Abadie</i>									
<div style="float: right;"> Addressed topics: Health & Comfort Spatial requirements Cost & Energy consumption Refurbishment Commissioning Quality of installation User satisfaction </div>									
Assessment methods		Assessing ventilation concepts		Novel ventilation solutions		Quality assurance		Assessing in-use performance	

3.9.1 Project objectives, description & methodology

Annex 68 Subtask 1 aimed at setting up the metrics to assess the performance of low-energy buildings with respect to indoor air quality, combining the aspirations to achieve very high energy-performance without compromising indoor environmental quality. The report has been edited in 2017 (Abadie and Wargocki, 2017). An extended abstract, summarizing the main findings of the 1st Subtask, has been published in 2019 (Abadie et al, 2019). Our approach can be summarized as follows. In the first phase, we selected target indoor air pollutants, i.e. pollutants listed by cognizant authorities as being harmful to humans during short-term (<24h) or long-term (>week) exposures. Then we checked whether these compounds were measured by published studies in residential environments and at concentrations that exceed the levels identified in the first phase. In a second phase, we reviewed previously proposed IAQ metrics to identify the different approaches used in the past and to judge whether any of them would be useful to define the best science-based indices for evaluation of IAQ. We proposed IAQ sub-indices based on acute and chronic effects as the ratio of the concentrations to the guideline levels; for chronic effects, we also proposed the DALY approach (Disability-Adjusted Life Years) as an IAQ index. As for the multipollutant index, we proposed the maximum of the calculated indices acknowledging limitations and inaccuracies introduced by aggregation methods. Finally, the value of the index, or set of sub-indices, for IAQ ultimately needs to be weighed against the additional use of energy needed to improve IAQ in comparison with current standard practice.

This case study summary aims at presenting one of the main results of Subtask 1 i.e. the list of key pollutants to be considered in low-energy buildings. As previously mentioned, pollutant concentrations can be compared with the relevant Exposure Limit Values (ELVs) for short- and long-term exposure to judge potential health impacts. Cognizant health authorities establish ELVs nationally and internationally. The levels may be significantly different for the same pollutant and the same exposure time depending on the criteria used by the committees setting the guideline values. To come up with a unique value for each pollutant, we chose the minimal value among ELVs suggested by health agencies from around the world. The pollutants with ratios (measured average concentrations / ELV) higher or close to 0.1 (Figure 3-24) were considered to be pollutants with the potential risk for health and relevant to IEA EBC Annex 68. Although ratios lower than 1.0 should mean no harm, it was decided to use a safety factor of 10 (this is why the ratio of 0.1 was used). This approach ensures that minimal risk is present.

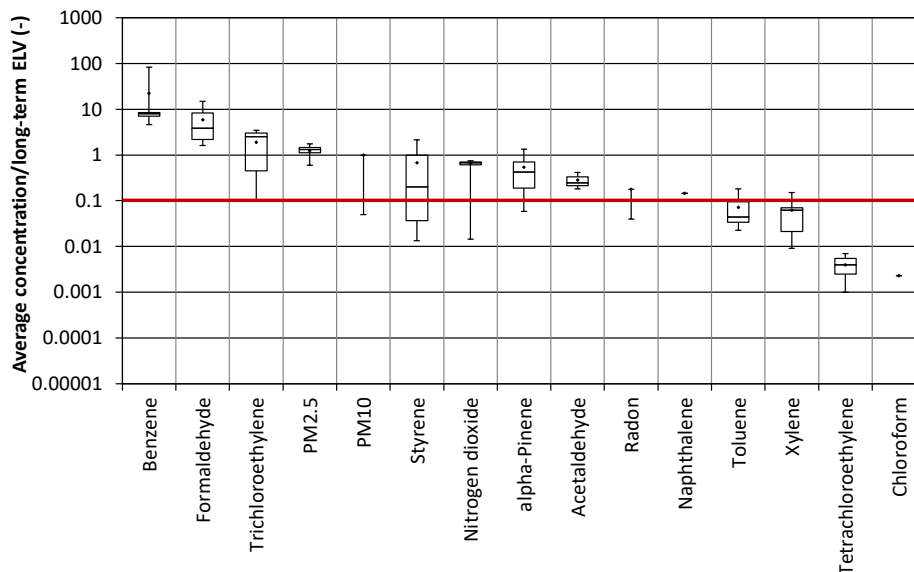

Figure 3-26 Ratio of annual average concentration measured in low-energy buildings to their respective ELVs for long-term exposures.

3.9.2 Main results and findings

By comparing long- and short-term ELVs and the data for concentrations of pollutants, we ended up with a shortlist of 14 pollutants, namely acetaldehyde, α -pinene, benzene, carbon dioxide, formaldehyde, naphthalene, nitrogen dioxide, PM₁₀ (particulate matter <10 μ m), PM_{2.5}, radon, styrene, toluene, trichloroethylene and TVOC. We acknowledge that the data can be collected with different accuracies and with different sampling methods but we were not able to make any adjustments for this because of the lack of information. Two contaminants not measured in low-energy buildings were also added: acrolein considered as a pollutant with very high priority (Kirchner et al, 2006; Logue et al, 2011) and mould as an indicator for dampness that has been correlated to adverse effects on human health (WHO, 2010). Table 3-3 presents the list of key pollutants obtained with this methodology.

3.9.1 Conclusions, lessons learned for practice

Our study resulted in the list of 16 relevant pollutants together with their ELV addressing both long-term and short-term exposures. We are aware that the high number of key pollutants can be a challenge in the design process. It should be pointed out, that our approach was conservative (use of minimum international ELV and Average concentration/ELV ratio > 0.1). As a result, a more pragmatic way for design would be to limit this list to the pollutants of higher priority (those with Average concentration/ELV ratio > 1). The list can thus be reduced to benzene, formaldehyde, trichloroethylene and PM_{2.5} (adding mould and acrolein for security as no data are available to apply the same methodology) for long-term exposure and only PM_{2.5} for short-term exposure. In this way, only PM_{2.5} concentration is required on a 24 h-basis and VOC concentrations only needs to be evaluated over longer periods to assess IAQ.

Table 3-6 Pollutants relevant within the scope of IEA EBC Annex 68; concentration is given in $\mu\text{g}/\text{m}^3$ except for carbon dioxide which is in ppm, radon which is in Bq/m^3 , and mould given in CFU/m^3 .

Pollutants	Long-term exposures		Short-term exposures	
	ELV*	Averaging period	ELV*	Averaging period
Acetaldehyde	48	1 year	-	-
Acrolein	0.35	1 year	6.9	1 h
α -pinene	200	1 year	-	-
Benzene	0.2	whole life	-	-
Carbon dioxide	-	-	1000	8 h
Formaldehyde	9	1 year	123	1 h
Naphthalene	2	1 year	-	-
Nitrogen dioxide	20	1 year	470	1 h
PM10	20	1 year	50	24 h
PM2.5	10	1 year	25	24 h
Radon	200	1 year	400	8 h
Styrene	30	1 year	-	-
Toluene	250	1 year	-	-
Trichloroethylene	2	whole life	-	-
TVOC	-	-	400	8 h
Mould	200	1 year	-	-

* See report for references of ELVs (Abadie and Wargocki, 2017).

3.9.2 Further reading

Abadie, M., Wargocki, P. (2017). CR 17: Indoor Air Quality Design and Control in Low-energy Residential Buildings- Annex 68 | Subtask 1: Defining the metrics. AIVC Contributed Report 17, 116p.

3.9.3 References

Abadie, M., Wargocki, P., Rode, C., Zhang, J. (2019). Proposed Metrics For IAQ in Low-Energy Residential Buildings. ASHRAE Journal, 61(1), 4p.

Kirchner, S., Arene, J.F., Cochet, C., Derbez, M., Duboudin, C., Elias, P., Gregoire, A., Jedor, B., Lucas, J.P., Pasquier, N., Pignernet, M., Ramalho, O. (2006). Campagne nationale logements: état de la pollution dans les logements français. Report, CSTB/DDD/SB – 2006-57, 165p.

Logue, J.M., Price, P.N., Sherman, M.H., Singer, B.C. (2011). A Method to Estimate the Chronic Health Impact of Air Pollutants in U.S. Residences. Environmental Health Perspectives, 120 (2), 216-222.

WHO. (2010). WHO guidelines for indoor air quality: dampness and mould. Report for the project WHO guidelines for indoor air quality, 248p.

3.10 Definition of a Reference Residential Building Prototype for Evaluating Indoor Air Quality and Energy Efficiency Strategies

<i>Jensen Zhang, Zhenlei Liu</i>									
<div style="float: right;"> <p>Addressed topics:</p> <ul style="list-style-type: none"> Health & Comfort Spatial requirements Cost & Energy consumption Refurbishment Commissioning Quality of installation User satisfaction </div>									
Assessment methods		Assessing ventilation concepts		Novel ventilation solutions		Quality assurance		Assessing in-use performance	

3.10.1 Project objectives, description & methodology

Many energy efficiency strategies have been used to improve the energy performance of residential buildings, and many models have been developed for building energy performance and IAQ simulations. However, there is a lack of a systematic and unified approach to evaluating the effectiveness of indoor air quality (IAQ) and energy efficiency strategies at the same time. To evaluate the energy efficiency and indoor air quality of residential buildings, a standard reference is needed to represent a typical design and operation condition for the local climate and construction practice as the basis for comparisons. In Annex-68 Subtask 2, a procedure for defining such a reference has been developed, and a common exercise conducted to evaluate the procedure. In this section, we summarize the method and procedure and discuss how the reference building can be used to evaluate the IAQ and energy efficiency strategies in residential building design and operations. We use the standard reference specifications defined for single-family houses in the Northeast Region of the US as an example for illustration. The method and procedure, however, may be adjusted and applied to establish a reference building for other regions or countries (See Subtask 2 Report for details).

Reference house design specification and baseline model for energy performance.

Residential house designs can vary significantly and it is difficult (if not impossible) to define a reference that is representative for all. Therefore, the reference house should be defined to reflect the local practice that is in compliance with local building code and regulations. For example, we chose a two-storey single-family house design at Syracuse, NY, USA as an illustrative case in cold climate, representing a typical practice in the Northeast Region of U.S. The house has 3 bedrooms, 2 bathrooms, a living/family room, a dining room and a kitchen, which is a typical design for small single-family houses (Figure 3-25).

Based on the review and analysis of the Building America benchmark house (Wilson et al. 2014) definition and the relevant ASHRAE Standards 90.2 and 62.2 (ASHRAE 2007, ASHRAE 2007), which specify minimum requirements for energy and acceptable indoor air quality, respectively), we specified the building materials, HVAC system settings, equipment settings and occupancy schedule. We simulated the energy performance of four cases (with/without natural ventilation, with/without lighting control) by using the software Designbuilder/Energy+. The case without natural ventilation and lighting control was selected as the reference house (baseline model) since it is the most typical operating condition in the Northeast region of U.S. for which the reference house was defined. The case with natural ventilation was simulated as follows: For the heating season, it was activated when the outdoor temperature was above 20.6 °C (0.6 °C or 1 °F above heating setpoint). For the cooling season, it was activated when the outdoor temperature was less than 25 °C (0.6 °C or 1 °F below cooling setpoint) (Wilson et al. 2014). When it was activated, an additional 5.4 ACH was infiltrated

and exfiltrated in the house. This was estimated assuming that 20% of the maximum openable area for windows was open on each façade and on each floor (Wilson et al. 2014) and the power-law model was as a function of used to calculate the flow rate as a function of the pressure difference across the window opening induced by the wind (thermal buoyancy was neglected) (Deru et al. 2003). More details can be found in Subtask 2 final report Case1. The lighting control was simulated as follows: the lighting is controlled by the setpoint of lighting level and the availability of natural daylight. The overhead lights dim continuously from the maximum light output to minimum light output as the daylight illuminance increases. The corresponding electrical power required for artificial lighting decreases accordingly.

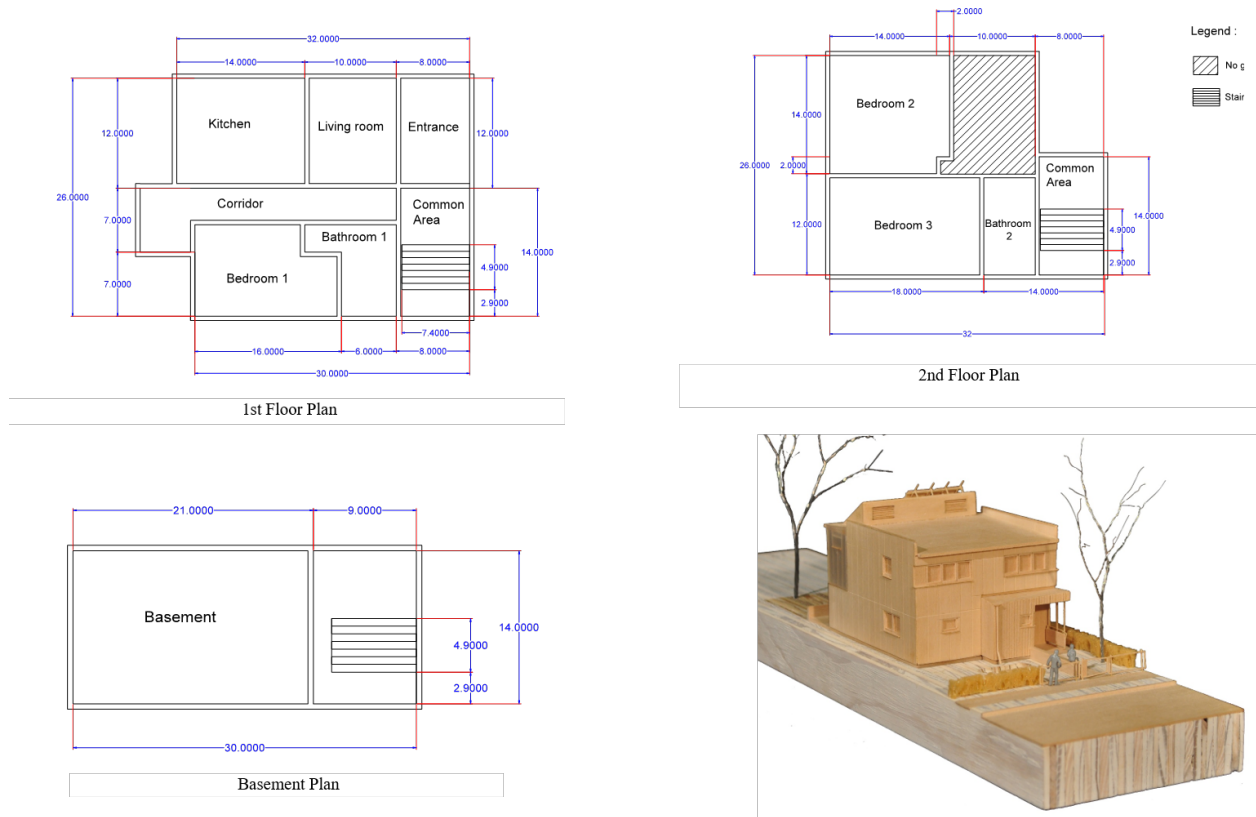

Figure 3-27 Local Reference House for Syracuse, New York State, U.S.

Pollution load specification and IAQ evaluation. To analyze the indoor air quality for the reference house, we have proposed three specification methods for constant pollutant loads and two methods for time-dependent pollutant loads, and applied IAQX1.1 (United States Environmental Protection Agency 2005) to implement a single zone IAQ model to evaluate the resulting pollution levels in the house:

Constant pollutant load:

- 1) Threshold concentration limits, material quantity and ventilation rate defined for the California Department of Public Health - CDPH (California Department of Public Health 2017) reference house were used to determine the emission factors for the materials used in the house with the assumption that each material should contribute no more than 50% of the total pollution load for a given compound.
- 2) Threshold emission factor limits in emission standards for low-emission materials are assumed as the emission factors for the respective type of materials used in the house.
- 3) Measured material emission factors (EF) from standard testing at a specified time point are used as the emission factors for the respective type of materials used in the house.

Variable pollutant load over time:

- 4) Empirical model representation of material emission test data: EF(t).
- 5) Mechanistic model (e.g., the diffusion model) representation of material emission test data, which is used to determine the emission factors for any given compound of interest under given thermal environmental conditions.

The emission factors from any of the above methods multiplied by the amount of respective materials used in the reference house provide an estimate of the pollution loads (emission rates) indoors for IAQ evaluations for the reference house.

Methods 1-4 above can be used to represent the IAQ performance under design condition. We simulated the concentrations of target contaminants included in the IAQ Metric proposed by the IEA Annex 68 Subtask using the single-zone model assuming all materials or material assemblies direct emit the VOCs into the space as the “worst” case scenario.

Method 5 enables the IAQ analysis with variable temperature or relative humidity conditions as in real field conditions as illustrated in Subtask 3, which would allow more accurate estimation of the emission rates. A key to applying this method is the availability of the emission model parameters for typical materials. In Subtask 2, we developed a standard procedure to estimate the parameters of the diffusion model from the data obtained from the standard chamber tests of material emissions. And in Subtask 3, a similarity approach has been developed to estimate the model parameters from the moisture transport and storage properties of building materials and the properties of volatile organic compounds (VOCs) of interest.

3.10.2 Main results and findings

Energy performance. According to the simulation results from the Designbuilder/E+, the baseline model energy consumption intensity is the highest in the four situations mentioned above, which is 134.07 kWh/m² per year including heating, cooling, ventilation, lighting and appliances such as refrigerator, dishwasher, clothes washer and dryer, electric range, excluding heating from wood stoves. However, this is still 23% less than the 2005 Energy Consumption Density for Detached Single-family Houses reported (173.50 kWh/m²) in U.S. (US. Energy Information Administration 2005), indicating the standard practice established by the Building America Program should result in more energy-efficient buildings as intended (Figure 3-26). The results show that with the lighting control on, there was a slight increase in heating energy because of less heat was released from the artificial lighting due to shorter period of on time, while there was a reduction in lighting energy consumption as expected. Heating energy was not affected by natural ventilation since more air was brought into the house for improving IAQ only when the outside temperature was higher than the heating set-point temperature.

IAQ Evaluation. According to IAQ simulation results, Method 1 assumes that each material should contribute no more than 50% of the total allowed pollution load. If more than two types of materials emit the same compound, the resulting indoor concentration would exceed the CDPH threshold value. A proposed adjustment to the CDPH approach for our study purpose would be to limit contribution from each material type to be 1/n-th of the total allowable load, where n is the number of materials that emit the same compound. For Methods 2 and 3, the concentration of air in the reference house depends on the material type and amount of materials used. In the cases of constant pollutant loads, the “worst” case scenario can predict the IAQ performance for different material selection and house design strategies (Figure 3-27).

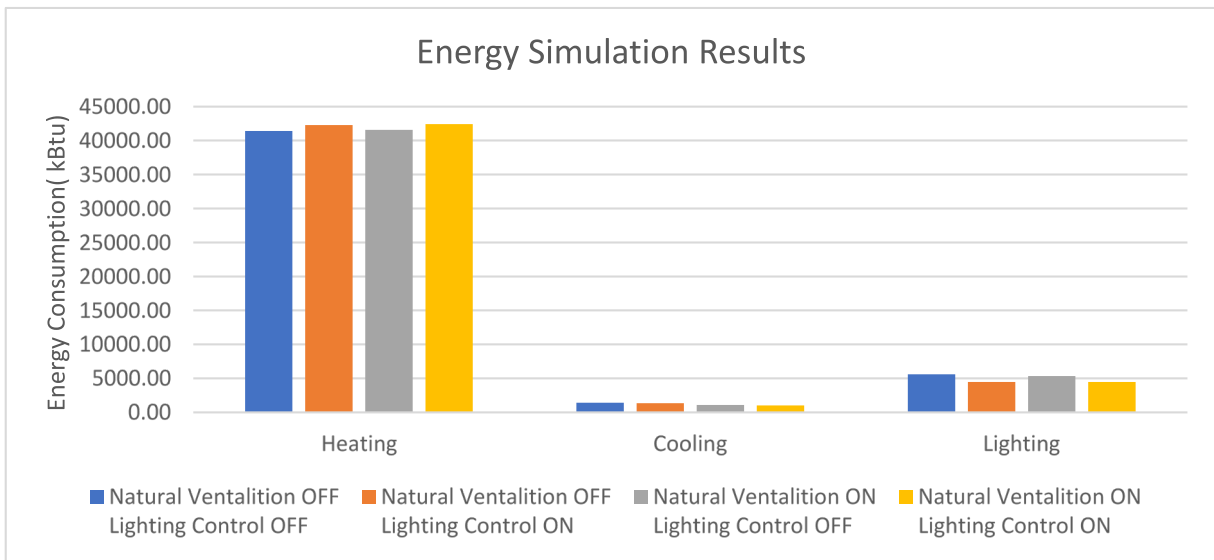

Figure 3-28 Results of Annual Energy Consumption Simulation Simulation (Reference conditions: 0.34 ACH total, 0.14 ACH mechanical, 0.20 ACH air-infiltration, heating setpoint: 20.0 °C cooling setpoint: 25.6 °C, number of occupants is 2.64, assuming 2 adults and 1 child. Unit conversion: 1 BTU = 0.00029 kW*h).

Method 4 uses empirical models to estimate the decay of emission rates over time and hence can reflect the “Age effect” of the material if applied with IAQx1.1. Application of Method 5 for pollution load estimation requires the use of the mechanistic model such as the CHAMPS-BES or Delphin 6, and can assess how the temperature and relative humidity would affect the indoor VOC concentrations and hence the indoor air quality.

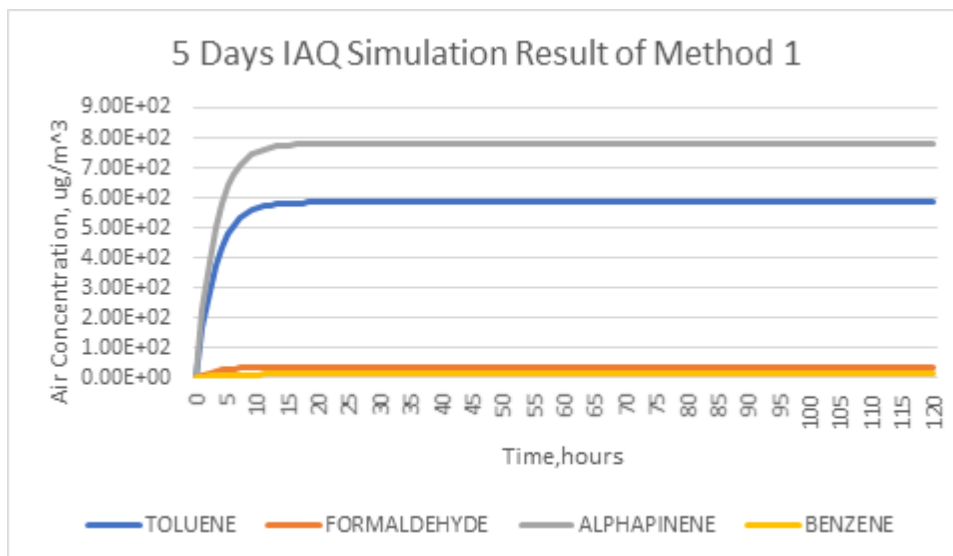

Figure 3-29 Results of IAQ Simulation (Simulated conditions: ventilation rate=0.34 ACH, emission rates: toluene= 66.74 mg/h, formaldehyde=4.01 mg/h, alpha-pinene = 88.97 mg/h, benzene = 1.33 mg/h).

3.10.3 Conclusions, lessons learned for practice

The method and procedure developed may be applied to define reference houses for other parts of U.S. and world considering the local minimum standards for energy, ventilation, indoor concentration thresholds and limits for emission factors. With the local reference house defined, the effectiveness of energy efficiency or IAQ strategies can be represented as the percent improvement over the local references, and thus facilitate a unified approach for comparative studies. It should be noted that the above analysis is limited to the pollutants emitted from building materials. The general approach may be extended to the analysis of other pollutants of different origins such as outdoors, human occupants and activities by determining their pollution loads for indoors and accounting for the additional source or sink processes (e.g., deposition for particles, and chemical reactions for reactive compounds such as O₃). Further such work is needed so that all the pollutants selected from Subtask 1 of Annex-68 (see Chapter 3.9) can be addressed in the near future. As soon as local references are established, a particular building design project can be assessed using the local reference. That will give the designers and architects a possibility to optimize their design. The local authorities will get the tool for assessment of competing projects as well as a benchmarking tool.

3.10.4 Further reading

Zhenlei Liu, Rui Zhang, Tim Stenson, Adib Rais, Wenhao Chen, and Jianshun Zhang. 2017. Definition of a Reference Residential Building Prototype for Evaluating IAQ and Energy Efficiency Strategies. Healthy Building 2017. September 2-5. Tainan, Taiwan.

3.10.5 References

E Wilson, C. Engebrecht Metzger, S. Horowitz, R Hendron, National Renewable Energy Laboratory (2014), Building America House Simulation Protocols

ASHRAE Standards 90.2 Energy-Efficient Design of Low-Rise Residential Buildings (2007)

ASHRAE Standard 62.2 Ventilation and Acceptable Indoor Air Quality in Low-Rise Residential Buildings (2010)

United States Environmental Protection Agency (2005), IAQX 1.1-- Indoor air quality simulation tool

California Department of Public Health (2017), Standard Method for The Testing and Evaluation of Volatile Organic Chemical Emissions from Indoor Sources Using Environmental Chambers Version 1.2

US. Energy Information Administration (2005), Residential Energy Consumption Survey: Energy Consumption and Expenditures Tables, revised 2009

M. Deru, P. Burns. (2003) Infiltration and Natural Ventilation Model for Whole-Building Energy Simulation of Residential Buildings. United States.

3.11 Temperature dependent emissions of Volatile Organic Compounds from building materials

<i>Weihui Liang</i>									
<div style="float: right;"> Addressed topics: Health & Comfort Spatial requirements Cost & Energy consumption Refurbishment Commissioning Quality of installation User satisfaction </div>									
Assessment methods		Assessing ventilation concepts		Novel ventilation solutions		Quality assurance		Assessing in-use performance	

3.11.1 Project objectives, description & methodology

The effects of temperature and humidity on volatile organic compound emissions have been reported widely in literature, especially for formaldehyde. Figure 3-28 illustrates the long-term indoor formaldehyde emissions from a medium-density fiberboard (MDF) in the full-scale experimental house. Indoor temperature and humidity conditions in the full-scale experimental house were changing with time. Due to the combined effects of temperature and humidity on formaldehyde emissions, the measured formaldehyde concentration changed with the annual cycle, as higher concentrations occurred in summer and lower concentration occurred in winter. The comparison between the emission models with the long-term formaldehyde emission data could also be observed in Figure 3-28. The effects of temperature and humidity are not considered in Huang and Haghghat’s model (Huang and Haghghat 2002), and the simulated formaldehyde concentration is decreasing with time. The big difference was observed between the simulation results and measurement data in this occasion.

3.11.2 Main results and findings

To consider the effects of temperature and humidity on pollutant load estimations, the dynamic mass transfer emission model is suggested to be used, in which the initial emittable concentration (C_0), diffusion coefficient (D_m) and partition coefficient (K) are changing with temperature and humidity (Liang et al. 2016a). The simulation result is presented in the black line in Figure 3-28. The comparison between the simulation result and measurement data indicate that this model could consider the effects of temperature and humidity on material emissions very well. The accuracy of this model is relatively good.

The correlations between C_0 , D_m and K with temperature and humidity are deduced by other studies (Huang et al. 2015; Liang et al, 2016b; Deng et al. 2009; Zhang et al. 2007). The constants of each correlation are necessary inputs in the emission model application. The most widely used method to obtain the constants of these correlations is to measure the pollutant emissions under different temperature and humidity conditions in the controlled dynamic environmental chamber, then to regress the emission parameters based on the measured data in each measurement scenario. However, the environmental chamber measurements are time consuming, which needs several days for each scenario, resulting in weeks of measurement for each building material. Moreover, as the constants of the correlation between emission parameters and temperature and humidity are different for different materials, a lot of effect need to be putted into the establishment of the emission database for the common building materials.

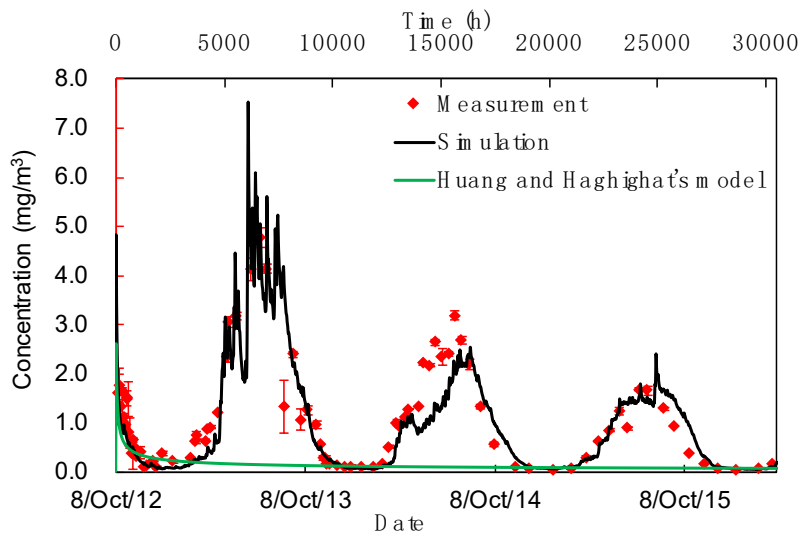

Figure 3-30 Comparisons between the emission models with the long-term formaldehyde measurement data in the full-scale experimental house.

3.11.3 Conclusions, lessons learned for practice

This work illustrates how temperature and humidity dependent pollutant emission models can be implemented in building simulation. As shown for formaldehyde, this effect can have a substantial impact on indoor air quality and should be taken into account when designing buildings and ventilation. Further work is needed to establish emission databases that also cover other pollutants and building materials.

3.11.4 Further reading

Liang W, Lv M, Yang X. The combined effects of temperature and humidity on initial emittable formaldehyde concentration of a medium-density fiberboard. *Building and Environment*, 2016b, 98:80-88.

3.11.5 References

Deng Q, Yang X, Zhang J. Study on a new correlation between diffusion coefficient and temperature in porous building materials. *Atmospheric Environment* 2009; 43:2080–2083.

Huang H, F Haghghat. Modelling of volatile organic compounds emission from dry building materials. *Building and Environment*, 2002, 37(12):1349-1360.

Huang S, Xiong J, Zhang Y. Impact of temperature on the ratio of initial emittable concentration to total concentration for formaldehyde in building materials: Theoretical correlation and validation. *Environmental Science & Technology* 2015; 49:1537–1544.

Liang W, Lv M, Yang X. An improved mass transfer model for simulating formaldehyde emissions from a medium-density fiberboard (MDF) in actual buildings. *Proceedings of Indoor Air 2016 Gent, Belgium, 2016.7.03-7.08*

Zhang Y, Luo X, Wang X, Qian K, Zhao R. Influence of temperature on formaldehyde emission parameters of dry building materials. *Atmospheric Environment* 2007; 41:3203–3216.

3.12 Detailed modelling of Indoor Air Quality to improve ventilation design in low energy houses

<i>María del Carmen Bocanegra-Yáñez</i>									
<div style="float: right;"> Addressed topics: Health & Comfort Spatial requirements Cost & Energy consumption Refurbishment Commissioning Quality of installation User satisfaction </div>									
Assessment methods		Assessing ventilation concepts		Novel ventilation solutions		Quality assurance		Assessing in-use performance	

3.12.1 Project objectives, description & methodology

This study aimed to assess the impact that pollutant sources and ventilation strategies have on the distribution of pollutants in low energy houses through a case study. A model was created and calibrated based on monitored data from a Passivhaus development in Scotland. Source emission models were implemented in ESP-r using published literature, with release rates as a function of temperature and humidity. Scenarios including mechanical ventilation with heat recovery (MVHR), natural and hybrid ventilation, with different control strategies, were defined and compared in terms of energy demand and indoor air quality (IAQ) (Figure 3-29).

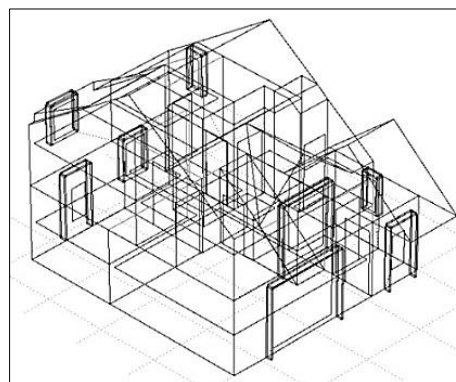

Figure 3-31 3D-sketch of the simulated case study.

3.12.2 Main results and findings

A comparison of trickle vents with continuous mechanical extract ventilation (MEV) against MVHR showed that MVHR increased the ventilation rate 2.5 times on average. This value would vary for a different climate or building type but it is a significant increase and illustrates one of the problems of MEV, as the minimum required ventilation rates cannot always be achieved due to the intrinsic variability of climate conditions and opening regimes. The impact that this increased ventilation rate had on IAQ is also very noteworthy, decreasing the peak CO₂ concentration in the main bedroom from almost 6000 ppmv when trickle vents and MEV were used and indoor doors remained shut, to slightly above 1000 ppmv when MVHR was used. Regarding formaldehyde, results showed that the average formaldehyde concentration decreased from 0.264 mg/m³ (almost eight times the recommended limit by the WELL Standard), when trickle vents and MEV were used and indoor doors remained shut, down to 0.04 mg/m³ when MVHR was used and doors were open. This situation was similar in the case of PM_{2.5} and PM₁₀, with average concentrations decreasing more than 30% when MVHR was used. It should be noted, that higher ventilation rates (as provided in this case study by the MVHR system) might result in periods with dry air, in particular in regions with cold and dry winters. Previous studies have reported on this supply air dilemma. Demand-control ventilation or the use of ventilation systems with enthalpy recovery can help to avoid this dilemma.

3.12.3 Conclusions, lessons learned for practice

The modelling study described in this paper demonstrates the potential for integrated detailed modelling to investigate design solutions of ventilation for providing good IAQ, considering spatial and temporal variations in temperature, humidity, airflow, multiple contaminants and their interactions. The main conclusion arising from the scenario analysis is that, contrary to the usual assumption of even distribution of the indoor environmental conditions, there can be significant variations in the internal distribution. Therefore, a simple one-zone model simulation could provide misleading results as it could predict acceptable average indoor conditions for the whole building. Results showed that the use of MVHR could improve the overall IAQ in the building if operated and maintained properly. However, optimal ventilation rates would be case-specific. It was also worth noting that indoor door opening generally improves IAQ.

3.12.4 Further reading

Bocanegra-Yanez, M.C. (2018). “Detailed simulation of the indoor environment to aid ventilation system design in low energy houses”. PhD Thesis, University of Strathclyde.

3.13 Mechanical ventilation system in deep energy renovation of a multi-story building with prefabricated modular panels

<i>Targo Kalamees, Ülar Palmiste, Anti Hamburg</i>					Addressed topics: ■ Health & Comfort ■ Spatial requirements ■ Cost & Energy consumption ■ Refurbishment ■ Commissioning ■ Quality of installation ■ User satisfaction				
Assessment methods		Assessing ventilation concepts		Novel ventilation solutions		Quality assurance		Assessing in-use performance	

3.13.1 Project objectives, description & methodology

This case study is a review of a mechanical heat recovery ventilation system (MVHR) with ducting integrated into prefabricated multifunctional modular panels (PMMP) that were installed to a multi-story apartment building which was renovated into a nearly-zero energy building (nZEB) (Figure 3-30). This is one of the first deep energy renovations in the Baltic and Nordic region that has been designed to correspond to the nZEB energy requirements of new buildings.

Renovation of the existing residential building stock is a key factor to achieve EU’s energy efficiency targets, but currently, the renovation rate of existing buildings is only 1–2% per year. The European building sector lacks a large-scale renovation process and a systematic approach to increasing the renovation rate toward nZEBs at reasonable costs. The EU funded Horizon 2020 project ‘MORE-CONNECT’ (www.more-connect.eu) has been launched to develop and demonstrate an innovative solution to standardize and industrialize renovation process by the utilization of prefabricated multifunctional renovation elements which have the potential to reduce costs and renovation time, reduce disturbance to occupants and, at the same time, enhance quality and performance in terms of energy efficiency, building physics and indoor environmental quality.

One of the major challenges while performing modular renovation is to find space for the installation of mechanical ventilation equipment and ducting due to the limited area for dedicated technical spaces and shafts in the existing buildings.

The objective of the Estonian pilot project was the utilization of PMMPs for the renovation of the dormitory building according to the best construction practice with energy efficiency solutions and renewable energy technologies. The primary energy use target after the renovation was $\leq 100 \text{ kWh}/(\text{m}^2/\text{year})$; the indoor climate target was category II according to the standard EN15251. The tasks to be researched concerning ventilation



Figure 3-32 The Estonian pilot project: before and after.

were (i) two different ventilation solutions: apartment-based balanced mechanical MVHR and centralized balanced MVHR, (ii) heat losses of the ducts inside the insulation layer and (iii) frost formation on the heat exchanger. The research on the installed ventilation systems is in progress.

The research object is a five-story student dormitory that is representative of the typical multi-family residential buildings that were mass-produced between 1960-1990 in the former Soviet Union countries and Eastern Europe. The dormitory was built in 1986 using large prefabricated concrete panel elements, the building has a rectangular floor plan with 2 staircases and 80 apartments. The pilot building has problems typical to many other older buildings: high energy consumption, insufficient indoor air quality, overheating during winter and unsatisfactory thermal comfort. The ventilation system in the building before the renovation was a natural passive stack ventilation: the introduction of fresh outdoor air to the living space was designed as infiltration through the slits around untightened wooden window frames, and natural exhaust from the kitchen and sanitary rooms was achieved using central ventilation shafts to the roof level. The pre-renovation total delivered annual energy based on measurements with category III indoor climate was 214 kWh/(m²year).

The pilot project includes a host of measures: hygrothermal measurements and analysis of moisture conditions, prefabricated highly-insulated facade and roof modular renovation elements, full repair of indoor areas, rebuilding of balconies, insulation of cellar constructions and the full modernization of heating and ventilation systems. After the renovation, an online questionnaire was conducted to study occupant satisfaction with the renovation’s effect on indoor environmental quality.

3.13.2 Main results and findings

The deficit of space for ventilation ducts in the pilot building was solved with the integration of air supply ducts into the thermal insulation layer of the modular panels during the prefabrication phase (Figure 3-31). That ensures an accurate installation of the panels to the existing building facade with minimal time consumption. Also, such duct placement does not require indoor space, and installation can be completed with minimal internal construction work. Two approaches to duct design are possible - separate vertical ducts to apartments or a main vertical riser duct with horizontal branches to apartments. The choice of the design depends on the duct sizing because placing the ducts inside the insulation layer of an external envelope reduces the U-value, which means that the ducts should not be too large or else the insulation layer must be sufficient. Questionnaire results of occupant satisfaction with renovation effect on IAQ are presented in Figure 3-32.

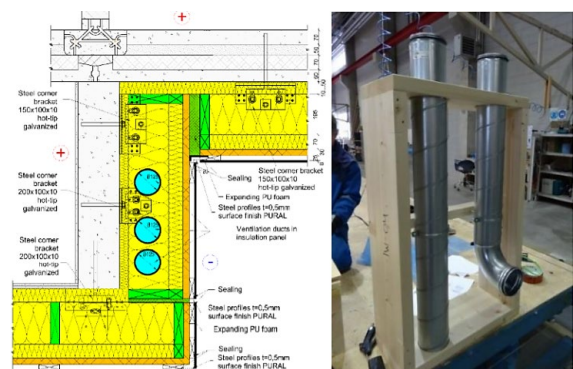

Figure 3-33 Ventilation ducts inside the prefabricated modular panel.

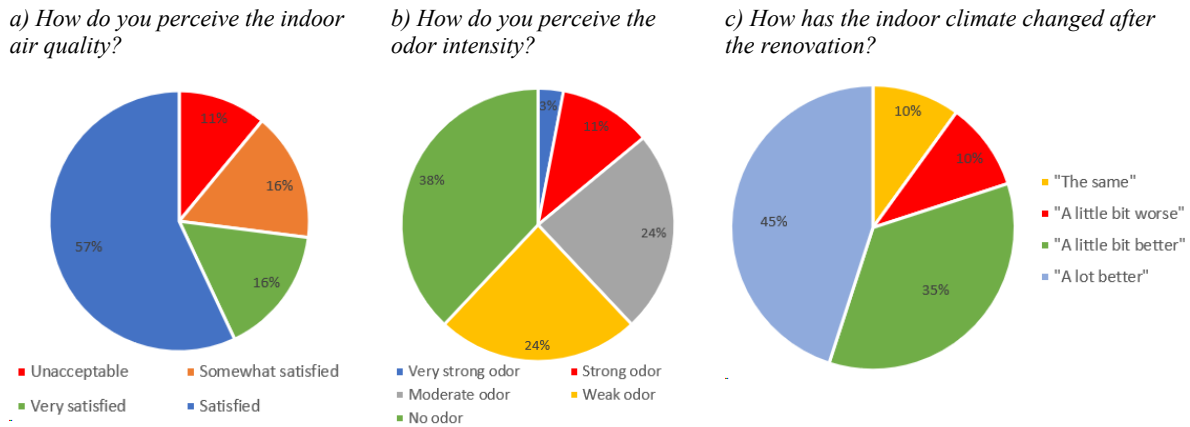

Figure 3-34 Results of the occupant satisfaction survey after the renovation: a) and b) are occupant perception of indoor climate after the renovation (37 people answered), c) perceived effects of renovation on indoor climate according to occupants who lived in the building before and after the renovation (20 people answered).

Figure 3-33 illustrates results regarding primary energy. The measured primary energy use before the renovation was 302 kWh/(m²·a) and after renovated 147 kWh/(m²·a). As the designed primary energy consumption was 95 kWh/(m²·a), the performance gap between measured and designed primary energy consumption is 34%. If the renovated building would be used according to design methodology, the nZEB target (PE ≤ 100 kWh/(m²·a)) can be achieved.

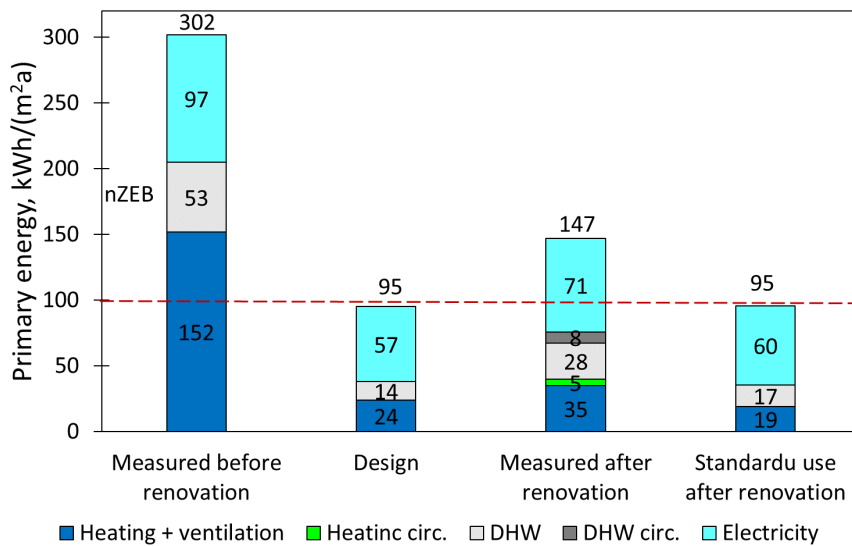

Figure 3-35 Primary energy use.

3.13.3 Conclusions, lessons learned for practice

Conclusions. The application of prefabricated multifunctional modular panels (PMMP) was proven to be an effective solution for the renovation of concrete large panel buildings to achieve targeted indoor environmental quality and up-to-date nZEB requirements in a cold and humid climate. The analysis, design, construction and

other activities of the integrated nZEB process provided a unique experience showing the weak links in the renovation process and gave the insight to prevent major faults in the next pilots.

Practical implications. (i) The modular retrofitting of buildings enables the placement of the ventilation ducts in the external insulation layer during the manufacturing phase, which ensures higher building quality and speed. (ii) In the case of centralized mechanical ventilation, the ducts must reach each of the apartments and the insulation thickness serves as a limiting factor, therefore separate ducts are a better solution due to their smaller duct size. (iii) The allowed air velocity in the ducts outside the building envelope can be increased compared to the situation when they are placed inside the rooms. (iv) The supply air must be heated more due to cooling which occurs in the ducts. (v) The interaction between the design process and the construction work at the building site has a critical importance to achieving the initial renovation energy efficiency and indoor environmental quality targets. (vi) The installation of the wooden modular elements indicated the need for a substantial thorough initial work (“measure twice and cut once”) and a deeper focus on moisture safety issues, such as incorporating hygrothermal modelling into design practice, selection of suitable vapor barrier depending on the initial moisture content (smart vapour retarder with changing vapour permeability, OSB or PE-foil) and insulation and wind barrier layers with high thermal resistance and vapour permeability.

The study showed that the building itself is built well but at the same time, if the existing heating pipe losses, DHW losses and real user behaviour are added to the calculation, then it is not possible to reach the nZEB energy performance. This means that energy performance methodology for standard use must also be developed to better take into account the user behaviour.

3.13.4 Further reading

Pihelo, P., Kalamees, T., & Kuusk, K. (2017). NZEB Renovation with Prefabricated Modular Panels. In *Energy Procedia* (Vol. 132, pp. 1006–1011).

Pihelo, P., Kalamees, T. (2019). Commissioning of moisture safety of nZEB renovation with prefabricated timber frame insulation wall elements. *Wood Material Science & Engineering*. <https://doi.org/10.1080/17480272.2019.1635206>

Hamburg, A., Kuusk, K., Mikola, A., Kalamees, T. (2019). Realisation of energy performance targets of an old apartment building renovated to nZEB. Submitted to *Energy* in June 2019.

3.13.5 References

Kalamees, T., Pihelo, P., & Kuusk, K. (2017). Deep energy renovation of old concrete apartment building to nZEB by using wooden modular elements. In *23. Internationales Holzbau Forum (IHF 2017)*. 7-8.12.2017 Garmisch-Partenkirchen, Germany (pp. 317–325).

Kuusk, K., Kalamees, T., & Pihelo, P. (2016). Experiences from Design Process of Renovation of Existing Apartment Building to nZEB. In *Proceedings of the 12th REHVA World Congress, CLIMA 2016*, 22-25 May 2016, Aalborg, Denmark.

Mesila, K. (2018). Liginullenergiahooneks renoveeritud ühiselamu soojuskadude analüüs. (Master thesis)

MORE-CONNECT. Development and advanced prefabrication of innovative, multifunctional building envelope elements for modular retrofitting and smart connections. <https://www.more-connect.eu> (accessed June 18, 2019)

Pihelo, P., Kalamees, T., & Kuusk, K. (2017). nZEB Renovation of Multi-Storey Building with Prefabricated Modular Panels. IOP Conference Series: Materials Science and Engineering, 251, 012056.

Pihelo, P., Lelumees, M., & Kalamees, T. (2016). Influence of Moisture Dry-out on Hygrothermal Performance of Prefabricated Modular Renovation Elements. In Energy Procedia (Vol. 96, pp. 745–755).

Zemitis, J., Borodinecs, A., Geikins, A., & Kalamees, T. (2016). Ventilation System Design in Three European Geo Cluster. Energy Procedia, 96(October), 285–293.

3.14 Simplifying Mechanical Ventilation with Heat Recovery systems: Assessing the extended cascade ventilation and active overflow concept

<i>Gabriel Rojas</i>									
<div style="text-align: right;"> Addressed topics: Health & Comfort Spatial requirements Cost & Energy consumption Refurbishment Commissioning Quality of installation User satisfaction </div>									
Assessment methods		Assessing ventilation concepts		Novel ventilation solutions		Quality assurance		Assessing in-use performance	

3.14.1 Project objectives, description & methodology

Mechanical ventilation with heat recovery (MVHR) is able to provide good IAQ while ensuring high energy efficiency in temperate, cold and arctic climates. However, conventional ventilation concepts for MVHR require supply or extract air ducting leading to each room of the dwelling. This is true for centralized systems (one MVHR unit for several apartments) as well as decentralized systems (one unit for each apartment). A possible alternative is the use of room-based MVHR-systems. However, the use of one supply and extract air point per room has some inherent disadvantages in terms of energy use. Furthermore, it can exaggerate low indoor air humidity issues in climates with dry and cold winters, e.g. in central Europe.

Therefore, this study assesses two lesser-known ventilation concepts that are suitable for centralized and decentralized MVHR systems and have the potential to reduce the required ducting within a dwelling. The so-called “extended cascade ventilation” principle was first documented in Swiss projects (Fraefel 1999) and systematically investigated in an Austrian research project (Sibille et al. 2013). It is based on the simple idea to omit the supply air opening in the living room, provided that the floor plan permits. In (Sibille and Pfluger, 2013) it was concluded that many modern floor plans are such, that the overflowing air from the bedrooms will have to pass the living room zone on the way to the extract air rooms. Besides saving ducting, a silencer and an outlet, the air is most effectively used and the total air exchange rate can be reduced compared to the standard layout with supply air for the living room (Figure 3-34).

The so-called “active overflow” ventilation principle provides a possible solution for refurbishment projects where it is not possible to route air ducting into each supply air room, i.e. bedrooms. Instead, one active overflow element (AOE) and one passive overflow element are installed in each room. It will move air from the connecting room, e.g. corridor or living room, into the room in question and back out. In its minimal form, such AOE consists of a sound protected passage, a silent fan, and a control mechanism that ensures the fan is only running when the door of that room is closed. The AOE is often integrated into the door itself, which can simplify the refurbishment process (Rojas, Rothbacher, and Pfluger 2012). The connecting room, i.e. the corridor or living room, has to be well ventilated by the MVHR system. Extract air rooms should be connected to the MVHR via conventional ducting, which is usually not a problem (e.g. within a suspended ceiling).

This work evaluates the ventilation performance of these two ventilation concepts in terms of indoor air quality and energy use by applying the assessment metrics and simulation models developed within this IEA EBC Annex 68 to a typical Austrian apartment. The long-term exposure to formaldehyde (FA), PM10 and PM2.5 and the short-term exposure to CO₂, FA, PM₁₀ and PM_{2.5} are evaluated. The temperature and humidity dependence of the emission rate of FA from building materials is taken into account. Sources and sinks for humidity, CO₂ and size-resolved particulate matter from indoor (cooking, occupants) and outdoor origin are also modelled in detail as described in (Rojas 2019). It is important to note that outdoor concentration is modelled constant with a PM_{2.5} concentration of 40 µg/m³, representing a medium polluted city on an international scale. The calculations are performed within the simulation software CONTAM for calculating airflows and contaminant concentrations and within the simulation software Dynbil, a dynamic building energy simulation software. Using co-simulation techniques the temperatures determined in Dynbil are used as input in CONTAM and the resulting airflows are provided back to Dynbil as input.

The reference apartment represents a typical Austrian new apartment with two bedrooms and a total of 76 m² floor area. It is modelled in Passive House standard, i.e. with an airtightness value of 0.6 h⁻¹ at 50 Pa, highly insulated walls and triple glazing.



Figure 3-36 Schematic sketch of the simulated ventilation concepts. Top: Reference MVHR, Center: extended cascade ventilation, Bottom: active overflow concept.

3.14.2 Main results and findings

The results show that the investigated ventilation concepts perform well compared to the reference MVHR or the extract air system. They outperform the extract air system for PM_{2.5} exposure due to the use of ambient air filters (Figure 3-35). An exception is the formaldehyde exposure in the living room. Here, slightly higher formaldehyde concentration can be expected with the extended cascade principle, due to the reduced total air exchange rate (Figure 3-35). The evaluation shows no exceedance of the short-term exposure limits of the four investigated pollutants for the MVHR systems, but an exceedance in the bedroom of the eight-hour CO₂ concentration average in 30 % of the (occupied) time for the extract air system. The active overflow concept is less effective in terms of ventilation efficiency compared to a cascading ventilation, as it mixes the air between all rooms (except extract air rooms). The total air exchange has to be set higher than for the other systems, potentially leading to lower indoor air humidity in winter.

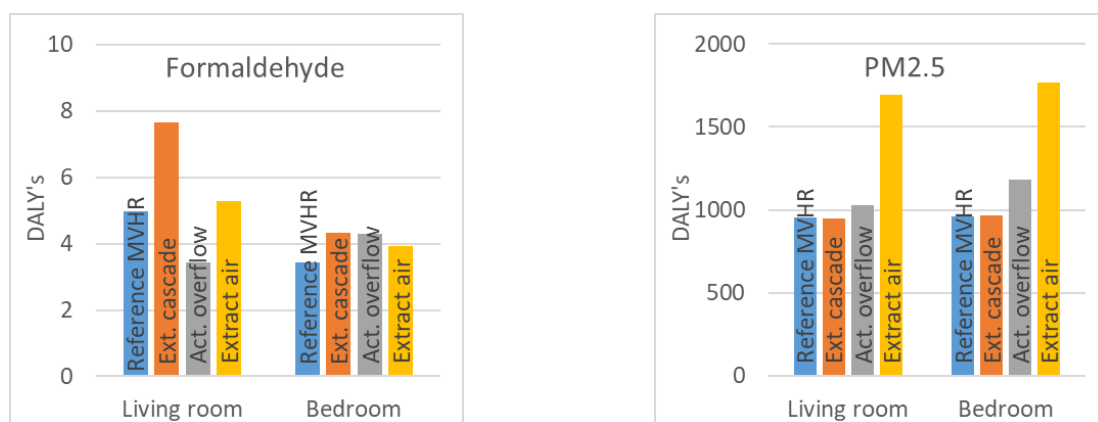

Figure 3-37 Performance of investigated ventilation concepts in terms of long-term exposure of formaldehyde (top) and PM_{2.5} (bottom) in living room and bedroom quantified in terms of Disability adjusted life years (DALY's).

3.14.3 Conclusions, lessons learned for practice

This is a simulation study and therefore its results are affected by assumed boundary conditions. They might not reflect realistic boundary conditions for certain countries or regions. However, it allows an assessment and direct comparison of different ventilation concepts, in particular two concepts that aim to simplify the implementation of MVHR systems in new and refurbished energy efficient buildings. The so-called extended cascade ventilation and active overflow concept have been already implemented in several case studies, and housing developers have shown interest for a wide-spread implementation. This study shows that they perform well in terms of indoor air quality and energy efficiency (not presented here) compared to state of the art in low-energy housing. A wide-spread measurement campaign is still need to empirically validate these results.

3.14.4 Further reading

Rojas, Gabriel. 2020. “Final report: IEA EBC Annex 68: Raumluftqualitätsoptimierte Planung und Betriebsführung von energieeffizienten Wohngebäuden.” in www.nachhaltigwirtschaften.at (to be published).

3.14.5 References

Fraefel, Rudolf. 1999. Die Wohnungslüftung Im MinEnergie Haus, Planungshilfe Für Baufachleute. Zürich.

Rojas, G, Mattias Rothbacher, and Rainer Pfluger. 2012. “Overflow Elements: Impacts on Energie Efficiency, Indoor Air Quality and Sound Attenuation.” In 33rd AIVC and 2nd TightVent Conference, , 96–100.

Rojas, Gabriel. 2019. “Ambient Air Filter Efficiency in Airtight, Highly Energy Efficient Dwellings – A Simulation Study to Evaluate Benefits and Associated Energy Costs.” In 40th AIVC Conference, AIVC, 920–31.

Sibille, Elisabeth et al. 2013. “‘Doppelnutzen’ - Komfort- Und Kostenoptimierte Luftführungskonzepte Für Energieeffiziente Wohnbauten [Final Report: Extended Cascade Ventilation - ‘Double Use’].”

3.15 Design of room-based ventilation systems in renovated apartments

<i>Kevin M. Smith, Jakub Kolarik</i>					Addressed topics: 				
Assessment methods		Assessing ventilation concepts		Novel ventilation solutions		Quality assurance		Assessing in-use performance	

3.15.1 Project objectives, description & methodology

The project aimed to investigate room-based demand-control of ventilation in renovated apartments in Denmark. In a test building, all apartments received an air-handling unit with heat recovery. Four of the apartments received a distribution box-manifold (Figure 3-36) to control the supply airflows to bedrooms and living rooms. Rather than use dampers to throttle and control airflows, the distribution boxes use four small fans along with pressure differential sensors to monitor the pressure rise of each fan. During the commissioning process, the installer varies the fan signals and measure the resulting pressure rise to construct a system curve for each fan. The curves provide an airflow and resistance at each fan signal. To maintain the validity of these system curves, which give precise control over the airflows, the system requires a constant pressure of 0 Pa ahead of the fans in the distribution box. This way, the pressure rise from each fan only overcomes the downstream losses in the duct, diffuser and overflow vent. To achieve this in practice, the entry chamber of the distribution box is left open to the corridor during commissioning. This provides a direct bypass of airflow and ensures 0 Pa ahead of the fans. Consequently, the system curve of the main air-handling unit is also only valid for 0 Pa inside the entry chamber of the distribution box. To maintain this condition during operation, the requested airflow from the main air-handling unit must equal the sum of the requested airflows from the individual fans of the manifold. As long as the controller maintains this equality, the system does not create an imbalance of supply and exhaust for changing airflows.

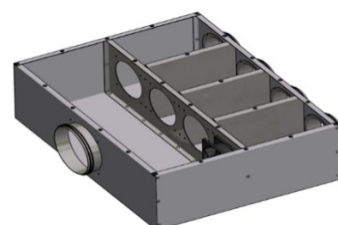

Figure 3-38 Drawing of the distribution manifold.

The described system could use manual controls or a schedule to control the individual airflows to each room, but the project sought to automate demand-control using wireless sensor modules that could measure CO₂ concentration, relative humidity and temperature in each room. The demand-control algorithm sought to limit these sensed variables to appropriate levels according to category II indoor climate in the EN standard 15251 (EN/ISO 2007). The algorithm uses proportional control for CO₂ since the outdoor concentration remains nearly constant. For humidity- and temperature-based demand-control, the algorithm checks for drying and cooling capacity respectively before ramping airflows according to demand. To ensure drying capacity, the algorithm checks that the outdoor absolute humidity is at least 3 g(H₂O)/kg(air) dryer than the indoor air. If satisfied, the controller ramps airflows between 8 g(H₂O)/kg(air) to 12 g(H₂O)/kg(air). The algorithm determines the demand for airflow in each room according to all three sensed variables (i.e. CO₂ concentration, humidity and

temperature) and takes the maximum. The controller sends the signal to each fan in the distribution box. The algorithm sums the required airflows and requests an equal amount from the main air-handling unit.

The project sought to test the system in simulations by constructing a model of the renovated apartments in the software IDA-ICE (Equa 2019). Figure 3-37 shows the floorplan in the software. The maximum available supply airflow to each room was 20 L/s in the simulations. For such airflows, a typical door restricts airflows, so the installers chose to use an overflow vent in the doorframe, as shown by Figure 3-38. The manufacturer of the vent provides airflow data at various pressure losses, as shown by Table 3-4.

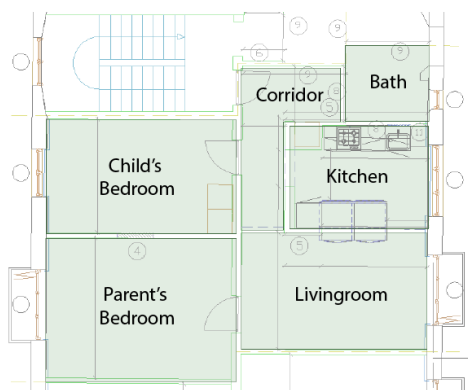

Figure 3-39 Floorplan of the demonstration site.

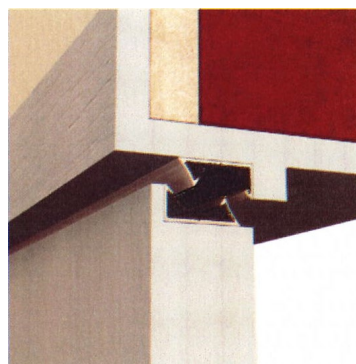

Figure 3-40 Image from the manufacturer of the overflow door vent installed in the renovation.

Table 3-7 Manufacturer data for the overflow door vent.

Pressure across door [Pa]	Airflow per unit length [(L/s)/m]
1	5
2	7
10	15
20	22

3.15.2 Main results and findings

The room-based demand-control algorithm maintained the desired level of indoor climate concerning CO₂ concentration, humidity and temperature in the simulated apartment. It also maintained adequate balance between supply and exhaust airflows. Figure 3-39 shows the annual duration curves of CO₂ concentrations in all rooms. Table 3-5 shows the calculated annual energy consumption at three constant ventilation rates, which provides a reference for comparison. The reference apartments have a constant ventilation rate of 35 L/s with a measured fan energy consumption of roughly 306 kWh. Comparatively, Table 3-6 shows the simulated energy consumption of the room-based demand-controlled system. The total annual consumption is 109 kWh, which represents annual energy savings of 64%. The fans in the manifold account for less than 7% of the total energy consumption.



Figure 3-41 Annual development of CO₂ concentrations.

The total annual consumption is 109 kWh, which represents annual energy savings of 64%. The fans in the manifold account for less than 7% of the total energy consumption.

Table 3-8 Fan energy of reference CAV system.

Air change rate [h-1]	Ventilation rate [L/s]	Specific fan power [J/m3]	Fan energy [kWh]
0.5	21.3	430	80
0.82	35	1000	306
1	42.7	1400	520

Table 3-9 Room-based demand-controlled system.

Target of pressure rise from fan	Annual Energy [kWh]	Average airflow [L/s]	Maximum airflow [L/s]
AHU	103.8	13.8	25.6
Child's bedroom	0.2	2.9	7.2
Adults' bedroom	5.8	6.3	18.0
Living room	1.0	3.7	14.3
Total	109		

3.15.3 Conclusions and lessons learned for practice

The case study demonstrated a concept for room-based demand-controlled ventilation in renovated apartments. This included a process for commissioning and controlling the system to appropriately balance supply and exhaust airflows. The system ensured adequate indoor climate using demand control, according to measurements of temperature, relative humidity and CO₂ concentrations in each room. Simulations demonstrated potential fan energy savings of 64% compared to the reference constant air volume system while improving indoor climate. The simulations predicted excessive infiltration heat loss with closed interior doors, despite the use of overflow vents. With insufficient leakage area between zones, rooms may experience over- or under-pressure, which drives infiltration. The simulations predicted 18% higher infiltration heat losses with the chosen overflow vent. It is therefore important ensure that the installed overflow vent offers minimal resistance to airflows.

3.15.4 Further reading



Smith, K. & Kolarik, J. 2019. Simulations of a novel demand-controlled room-based ventilation system for renovated apartments. In Proceedings of IAQVEC 2019, 10th international conference on indoor air quality, ventilation & energy conservation in buildings, Bari, Italy.

3.15.5 References

EN/ISO 2007. EN/ISO 15251:2007 - Indoor environmental input parameters for design and assessment of energy performance of buildings addressing indoor air quality, thermal environment, lighting and acoustics, Brussels, Belgium.

Equa, 2019. IDA Indoor Climate and Energy, Version 4.8 SP1, www.equa.se (visited October 2019), EQUA Simulation AB, Solna, Sweden

3.16 Introduction to the Coupled Heat, Air, Moisture and Pollutant Simulation (CHAMPS) modeling platform

<i>Stephan Hirth, Andreas Nikolai and John Grunewald</i>					Addressed topics: 				
Assessment methods		Assessing ventilation concepts		Novel ventilation solutions		Quality assurance		Assessing in-use performance	
									

3.16.1 Project objectives, description & methodology

As part of the work under Subtask 3 of Annex 68, a CHAMPS modeling platform (Figure 3-40) was set up. The focus of this multiscale and multidisciplinary modeling platform is on integration and the use of free solvers developed in the scientific community. These solvers deal with building processes related to air, light, energy, HVAC operation, moisture and pollutants.

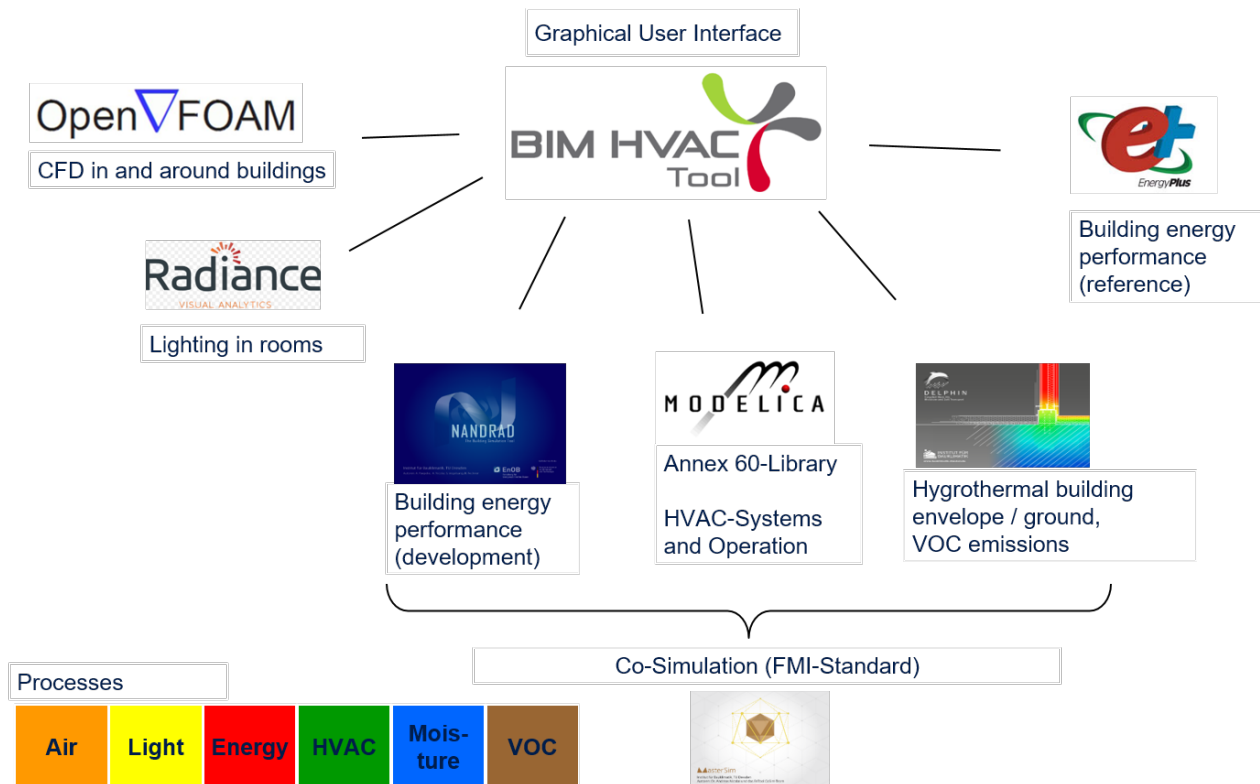

Figure 3-42 Multi-scale and multi-disciplinary CHAMPS modeling platform.

The simulations can be set up using the graphical user interface BIM HVAC Tool, jointly developed by Tian Building Engineering and the TU Dresden, Institute of Building Climatology, which greatly facilitates pre- and post-processing. While all solvers are free programs, the BIM HVAC Tool is the only commercially distributed software on the CHAMPS modeling platform.

During the course of the Annex 68 project, the developmental work focused on the implementation of diffusion and emission of pollutants in DELPHIN6. Another important aspect was the development of coupling technologies to support co-simulation. Finally, an extensive gap analysis and two common exercises revealed further implementation demand and the necessity of quality assurance management. In the following sections, several application examples demonstrate the broad range of topics and scenarios that can already be addressed by using single or coupled tools from the CHAMPS modeling platform.

3.16.2 Main results and findings

CHAMPS application example 1: University Campus TU Dresden

A first application example of the CHAMPS simulation platform comes from a so-called EnEff-Campus project for energy analysis (tools used are Radiance, EnergyPlus, NANDRAD, DELPHIN, POSTPROC). As can be seen in Figure 3-41, the Campus of the Dresden University of Technology serves as a study object.

The overall objective of the project was to draw up an energy development plan with short-, medium- and long-term measures to reduce energy consumption on the campus. These included the development of an optimized energy supply strategy, taking into account the urban context, the scientific monitoring of practical reconstruction measures and the testing of innovative energy management systems. On the basis of a detailed analysis of the current status, a development concept for the energy supply of the campus and the energetic upgrading of the buildings as well as their networking regarding the heating and cooling supply was developed.

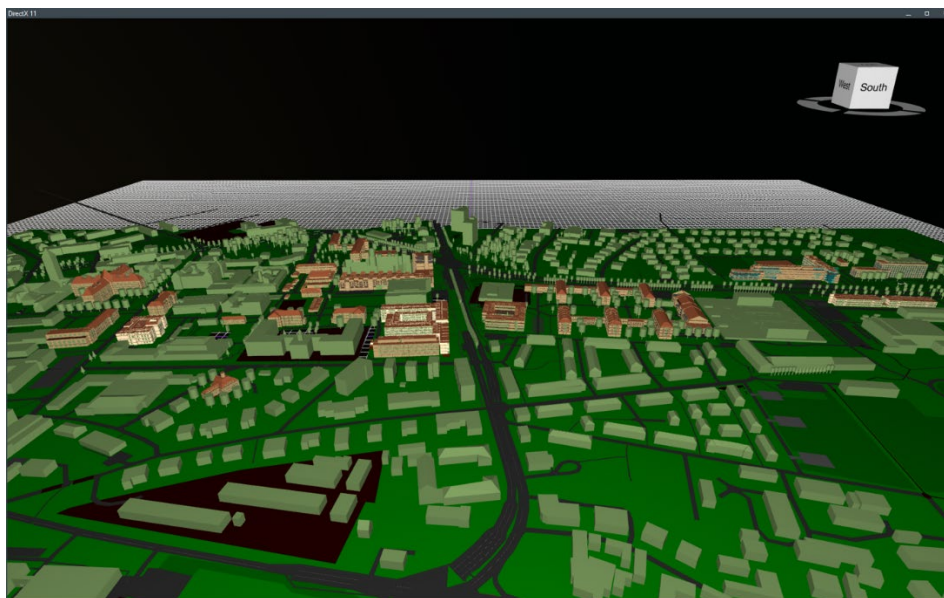

Figure 3-43 Illustration from a tool in the CHAMPS modelling platform, which on a community scale highlights building complexes that can be simulated for their Combined Heat, Air, Moisture and Pollutant conditions, including an energy performance assessment. Source: TU Dresden.

To this end, full-scale building models have been created on the basis of existing CAD plans. One research question was to examine the sensitivity of the simulated energy consumption (heating energy vs. electricity) as a function of the level of detail (e.g. number of modeled / merged zones). One lesson learned was that in office buildings a minimum level of detail must be maintained in order to keep the ratio of heating energy to electricity

within a realistic range. Due to the increased lighting demand in merged zones, the power consumption can be overestimated and the heating energy underestimated if the level of detail is too low.

CHAMPS application example 2: Whole building energy analysis in the City of Geretsried

A second application example shows the achieved progress of the platform in the area of practice integration (tools used are Radiance, EnergyPlus, NANDRAD, POSTPROC). In the frame of the research project +EQ-Net, a residential area in the city center of Geretsried in Germany was examined (Figure 3-42). Energy concepts were developed by means of variant studies / scenarios that evaluated the energetic self-sufficiency and grid compatibility of the whole building. The framework conditions of the pilot project were:

- Planned new building for multi families with additional commercial units
- Variant study in the early planning phase
- Energy concept for self-sufficient supply of heat and electricity
- Creation of a certificate for a positive energy balance (+Energy) throughout the year

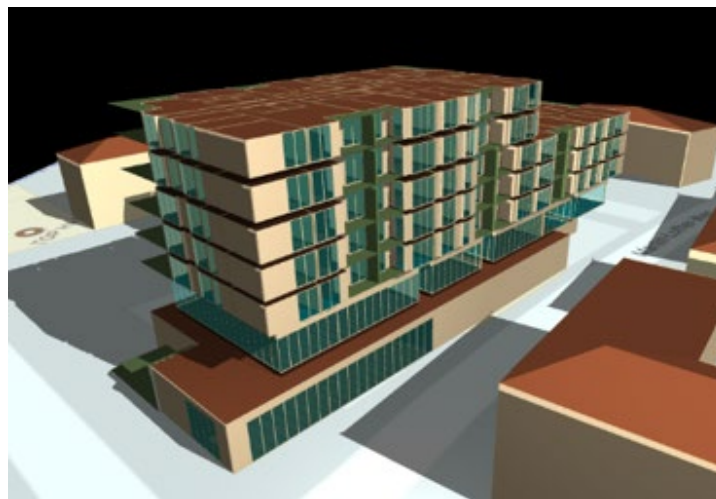

Figure 3-44 Simulation model of a residential and commercial building in the City of Geretsried, Germany.

During the project, models with varying degree of detail were created. Simplified models in the beginning of the project phase contained combined zones. However, these models are conditionally suitable for a study of thermal comfort since mathematically averaged values, over a large area of merged zones, have little or no significance. Therefore, refined models with more detailed representations of thermal zones have emerged. Furthermore, the designs have been adapted or changed according to the progress in the planning process. It could be shown that tools from the CHAMPS modeling platform can already be successfully used in practice and can keep pace with planning progress.

CHAMPS application example 3: Coupled plant and single-zone model

The third application example demonstrates newly developed technology in the coupling of building and plant models (Figure 3-43) that supports integral planning including very different domains in the field of building performance simulation. One important topic was the development of a largely automated and script-supported

workflow that addresses the creation of so-called Functional Mockup Units (FMUs) according to the Functional Mock-up Interface (FMI) standard¹ and the definition of coupling scenarios (Figure 3-43).

The application of co-simulation technology will only be effective in practice and in the academic environment if the effort for the definition and implementation, including the evaluation, remains within a reasonable and economically justifiable frame. This includes also the time spent on troubleshooting. A reduction of this processing effort is strongly linked to the respective procedure and the question to be worked on, the development of an adapter and wrapper technology. Adapters and wrapper-models significantly simplify connecting FMUs with hundreds of input/output variables.

For the efficient use of the coupling technology, the FMU import procedure had to be improved. The idea was that FMU and connector models (*AmbientConditions-Adapters*) would be wrapped together in a Modelica model. The wrapper models are Modelica models, so they can easily be generated automatically via script or as part of the export. With NANDRAD, the number of interfaces depends on the building model, specifically the number of zones and the respective zone IDs, so that the wrapper must be created appropriately for each FMU export. To automate this, the generated Modelica source code was analyzed and a template for automatic replacement of the FMU-specific connectors was created. The NANDRAD FMU export source code has now been extended to fill this template project specific. This allows the wrapper to be created automatically with the FMU, simplifying the import procedure and linking.

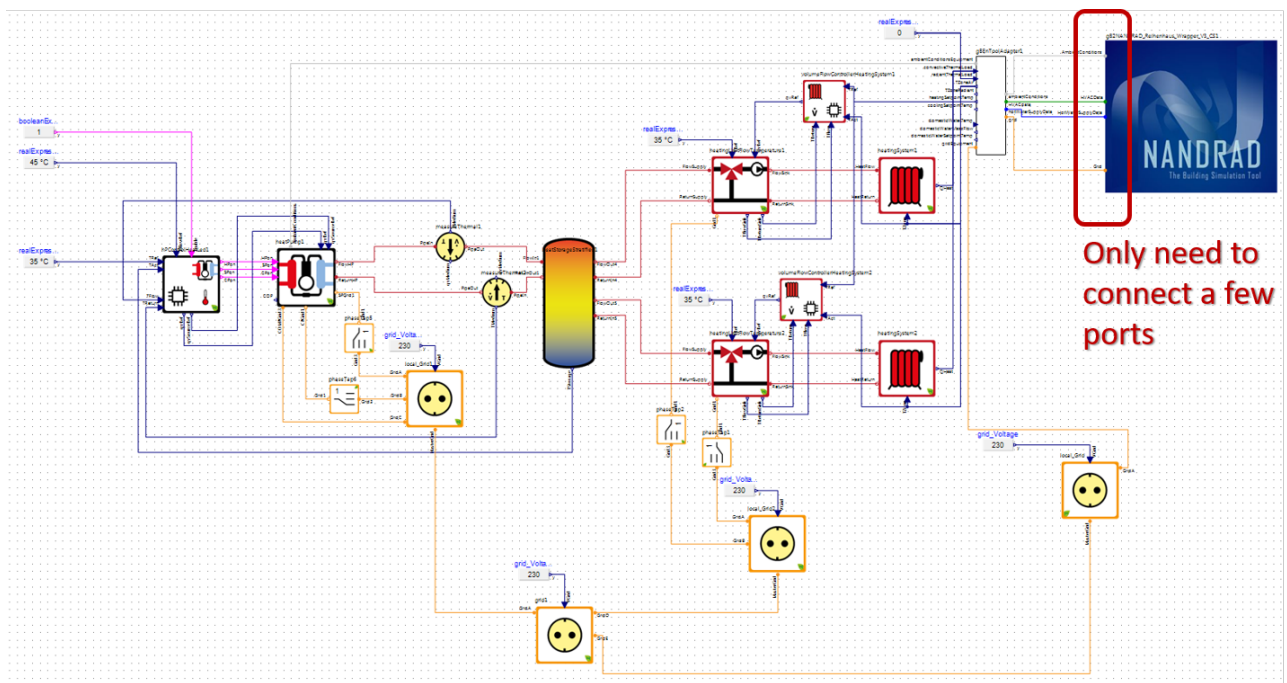

Figure 3-45 Co-simulation of a plant model and a building model by using Modelica and NANDRAD - Use of adapter models simplifies setup of co-simulation scenario.

¹ The FMI standard is a tool independent standard to support both model exchange and co-simulation of dynamic models using a combination of xml-files and compiled C-code. Homepage of the FMI standard: <https://fmi-standard.org>

CHAMPS application example 4: Soil heat collector simulation

The fourth application example demonstrates the use of the CHAMPS modeling platform in a simulation of renewable heat sources (Figure 3-44). The simulation of the hygrothermal behavior of the ground including ice formation makes it possible to describe very precisely and to optimize the operation of ground heat exchangers installed in a depth of 2-5 m. At the surface, the data from the test reference year (TRY) of the German Weather Service is used that includes temperature, relative humidity, direct radiation, diffuse radiation, atmospheric counter radiation and hourly precipitation for a representative year. The average terrestrial heat flux from the earth's interior can also be taken into account.

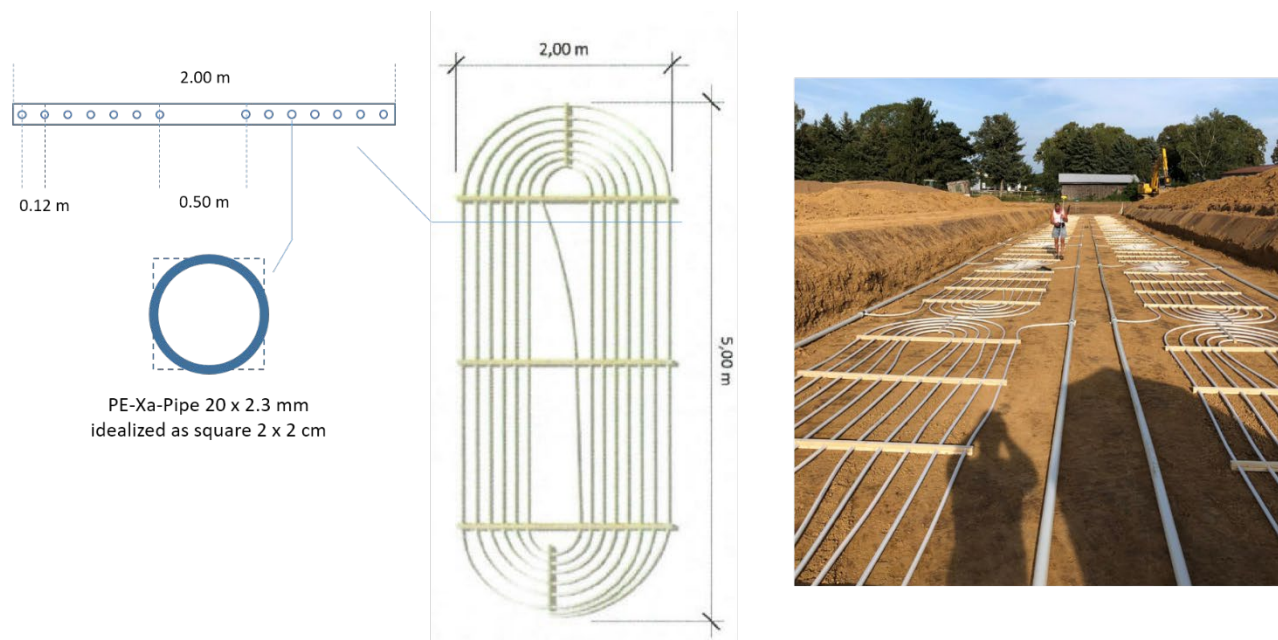

Figure 3-46 Single soil heat collector (middle) that can be combined to collector fields (right).

Starting from an undisturbed earth temperature field (no operation in the first year of the simulation), the courses of the ground temperatures in selected positions are evaluated in the following nine years of operation. The moisture content of the soil is an important factor that contributes significantly to the functioning of the system. The water in the soil itself has a high heat storage capacity and the periodic ice formation contributes to the amount of heating and cooling energy that can be delivered from the ground source. If underground ice is formed by harvesting more heating energy in wintertime, additional cooling energy can be provided in summer, which supports the regeneration of the collector fields and provides a bidirectional seasonal shift of energy.

This requires the coupling of DELPHIN6 for high-performance simulation of large problems with the Modelica AixLib² for dynamic simulation of district networks. Both programs must support the FMI standard 2.0. In addition, the development of the simulation master MASTERSIM³ was necessary that coordinates the run of the co-simulation.

² AixLib is a Modelica model library for creating building and system simulations. The library is being developed at the E.ON Energy Research Center, Chair for Building and Indoor Climate Technology at RWTH Aachen University. Download link: <http://ibpsa-germany.org/wordpress/tools>

³ MASTERSIM is a free tool to coordinate co-simulation. Download link: <http://ibpsa-germany.org/wordpress/tools>

3.16.3 Conclusions and lessons learned for practice

Huge intelligence and financial resources have been invested in creating simulation codes and tools. However, most existing building simulation tools remain at the research or "in-house" level. Thus, they are not widely used in construction practice. The main tasks of the CHAMPS platform are to promote the practice of integration of simulation tools and to facilitate complex practical planning tasks by supporting interdisciplinary teamwork.

An increased use of simulation tools has already been observed in practice. This goes hand in hand with the general trend of digitization of our society and in particular of the construction sector. The responsibility of researchers in technical fields such as building physics and indoor air quality today is not just to provide good research results. They are also responsible for the transfer of knowledge, which means that the usability of the research results must be ensured. This is only possible if the researchers themselves are also working on practical projects to see where the weak points of their tools are and how to improve them.

It is not uncommon for researchers to "shoot beyond the target" during development. The direct feedback with the practice can help to avoid the implementation of unnecessary functions. The increasing practice integration helps, as the example of the CHAMPS platform demonstrates, to formulate research questions in a more precise and practical way. Digitalization in construction thus contributes to improving resource efficiency.

3.16.4 Further reading

The available free solvers on the CHAMPS-platform are:

- **OpenFOAM**⁴ is the free, open source CFD software developed primarily by OpenCFD Ltd since 2004. It has a large user base across most areas of engineering and science, from both commercial and academic organizations. OpenFOAM has an extensive range of features to solve anything from complex fluid flows involving chemical reactions, turbulence and heat transfer, to acoustics, solid mechanics and electromagnetics. OpenFOAM is professionally released every six months to include customer sponsored developments and contributions from the community. It is independently tested by ESI-OpenCFD's Application Specialists, Development Partners and selected customers, and supported by ESI's worldwide infrastructure, values and commitment.
- **Radiance software**⁵ is a distributed raytracing package developed by Greg Ward Larson, then at the Lawrence Berkeley National Laboratory (LBNL) in Berkeley, California. Radiance is currently the most powerful and robust system for computing the effects of architectural lighting and *daylighting*, and can output images in photorealistic (or rather "photo accurate", as its author claims) quality. Consequently, the special image format used does not store subjective "*brightness*" values, but the actual *luminance* on all visible surfaces. Apart from that, Radiance can compute *illuminance* values at arbitrary points in space, which is useful to determine *daylight factors* and illuminance levels on the *workplane*.
- **NANDRAD**⁶ is a modern building energy simulation platform for the dynamic analysis of the energy efficiency of a building. It is actively developed at the TU Dresden, Institute of Building Climatology especially for calculation of complex and large buildings, and to handle the large amount of data for such

⁴ <https://openfoam.com/>

⁵ <https://windows.lbl.gov/software/radiance>

⁶ <https://bauklimatik-dresden.de/nandrad/index.php>

building sizes. At the same time, the integrated physical models are quite detailed, which is meaningful for a dynamic description of the building behavior. In particular, massive construction form in the European area are well represented by spatially discretized constructions.

The resulting physical models place high demands on the numerical integration engine. Hence, the NANDRAD solver was specifically developed and optimized for building energy simulation and uses state-of-the-art technology in embedded numerical algorithms.

Besides intern equipment and control models, NANDRAD supports runtime simulation coupling based on the Functional Mockup Interface (FMI), Standard 2.0. Through this it is possible, to combine detailed equipment/HVAC system models and components, mostly on the supply side, from specialized simulation tools/libraries (e.g. Modelica) with the NANDRAD building energy simulation.

- **DELPHIN**⁷ is a comprehensive numerical simulation tool for the combined heat, air, moisture, and matter (e.g. salt) transport in porous building materials. DELPHIN supports runtime simulation coupling based on the Functional Mockup Interface (FMI), Standard 2.0. For further information, see subsection see subsection 3.2.3 “Co-Simulation with DELPHIN6”. DELPHIN is actively developed at the TU Dresden, Institute of Building Climatology.
- **EnergyPlus**^{TM8} is a whole building energy simulation program that engineers, architects, and researchers use to model both energy consumption - for heating, cooling, ventilation, lighting and plug and process loads - and water use in buildings. EnergyPlus is a console-based program that reads input and writes output to text files. It ships with a number of utilities including IDF-Editor for creating input files using a simple spreadsheet-like interface, EP-Launch for managing input and output files and performing batch simulations, and EP-Compare for graphically comparing the results of two or more simulations.
- **Modelica Annex 60 Library**⁹ is a free library that provides basic classes for the development of Modelica libraries for building and community energy and control systems. The intent of the library is that classes of this library will be extended by implementations of Modelica libraries that are targeted to end-users. Hence, this library is typically not used directly by end-users, but rather by developers of libraries that will be distributed to end-users. For more information, see subsection see subsection 3.1.3 “Annex 60 cooperative buildings library development”.
- **MASTERSIM**¹⁰ is an FMI Co-Simulation master and programming library. It supports the Functional Mockup Interface for Co-Simulation in Version 1.0 and 2.0. Using the functionality of Version 2.0, it implements various iteration algorithms that rollback FMU slaves and increase the stability of coupled simulations. MASTERSIM is actively developed at the TU Dresden, Institute of Building Climatology. The MASTERSIM installers are being hosted on SourceForge.
- **POSTPROC**¹¹ The scientific post-processing software was developed specifically for analyzing simulation results of our software DELPHIN, THERAKLES, NANDRAD and MASTERSIM, primarily focusing on time-dependent/dynamic data. However, due to its flexible data interface, it can be used for many other purposes

⁷ <https://bauklimatik-dresden.de/delphin/index.php>

⁸ <https://energyplus.net/>

⁹ <http://www.iea-annex60.org/news.html#modelica-annex-60-library-released>

¹⁰ <https://bauklimatik-dresden.de/mastersim/index.php?aLa=en>

¹¹ <https://bauklimatik-dresden.de/postproc/index.php>

like processing of measurement data and results of other simulation models. POSTPROC is actively developed at the TU Dresden, Institute of Building Climatology.

During the course of the Annex 68 project, the developmental work focused on the implementation of diffusion and emission of pollutants in DELPHIN6. Another important aspect was the development of coupling technologies to support co-simulation. The following scientific publications, research and technical reports are available about MASTERSIM:

- Nicolai, A.; *Co-Simulations-Masteralgorithmen - Analyse und Details der Implementierung am Beispiel des Masterprogramms MASTERSIM*, 2018¹²
- Nicolai, A.; *Co-Simulation-Test Case: Predator-Prey (Lotka-Volterra) System*, 2018, Technical Report¹³
- Nicolai, A. and Paepcke, A.; *Co-Simulation between detailed building energy performance simulation and Modelica HVAC component models*, 2017, 12th International Modelica Conference, Prague¹⁴
- Nicolai, A., Paepcke, A. and Hirsch, H.; *Robust and accurate co-simulation master algorithms applied to FMI slaves with discontinuous signals using FMI 2.0 features*, 2019, 13th International Modelica Conference, Munich¹⁵
- Nicolai, A.; *Validierung des Co-Simulations-Masterprogramms MASTERSIM*, 2019, Technical Report¹⁶

Finally, an extensive gap analysis and two common exercises revealed further implementation demand and the necessity of quality assurance management. In the following sections, several application examples demonstrate the broad range of topics and scenarios that can already be addressed by using single or coupled tools from the CHAMPS modeling platform.

3.16.5 References

Baetens, R., De Coninck, R., Jorissen, F., Picard, D., Helsen, L., & Saelens, D. (2015). *Openideas-an open framework for integrated district energy simulations*.

Berger, J., Mazuroski, W., Oliveira, R. C. L. F., & Mendes, N. (2018). Intelligent co-simulation: neural network vs. proper orthogonal decomposition applied to a 2D diffusive problem. *Journal of Building Performance Simulation*, 11(5), 568-587.

Burhenne, S., Wystreil, D., Elci, M., Narmsara, S., & Herkel, S. (2013). *Building performance simulation using Modelica: analysis of the current state and application areas*. Paper presented at the 13th Conference of International Building Performance Simulation Association, Chambéry, France, August.

Grunewald, J., Stockinger, V., Weiß, D., Blaich, L., Nicolai, A., & van Treeck, C. (2015). Neue Anforderungen an Planungswerkzeuge für Energie⊕-Siedlungen und-Quartiere. In *Bauphysik-Kalender 2015*.

¹² Full text pdf version available under: [Nicolai MasterSim Algorithmus.pdf](#)

¹³ Full text pdf version available under: [Nicolai MasterSim ErrorTests with Lotka Volterra Model.pdf](#)

¹⁴ Full text pdf version available under: [Nicolai Modelica NANDRAD CoSim 2017.pdf](#)

¹⁵ Full text pdf version available under: [Nicolai et al 2019 ModelicaConference.pdf](#)

¹⁶ Full text pdf version available under: [Nicolai Validierung des CoSimulations Masterprogramms MasterSim.pdf](#)

Stratbücker, S., van Treeck, C., Bolineni, S. R., Wölki, D., & Holm, A. (2011). *A co-simulation framework for scale-adaptive coupling between heterogeneous computational codes*. Paper presented at the 12th International Conference on Air Distribution in Rooms (Roomvent), Trondheim, Norway.

van Treeck, C., & Rank, E. (2007). Dimensional reduction of 3D building models using graph theory and its application in building energy simulation. *Engineering with Computers*, 23(2), 109-122.

Wetter, M. (2011). Co-simulation of building energy and control systems with the Building Controls Virtual Test Bed. *Journal of Building Performance Simulation*, 4(3), 185-203.

Wetter, M., van Treeck, C., & Hensen, J. (2013). New generation computational tools for building and community energy systems. Energy in Buildings and Communities Programme. IEA EBC Annex, 60.



4 Towards better performance and user satisfaction

Current efforts towards sustainability and energy effective buildings are accompanied by a large focus on the design phase. Many standards, guidelines and tools have been developed to support that life-phase of buildings and their installations. However, it is the operational phase, which in the end decides whether what was designed will be sustainable and provide an adequate indoor environment for occupants. Recently, there is an increased awareness regarding building operation, but design still receives the most attention.

The following chapter presents case studies and research projects focused on existing buildings and systems and their operation, control and performance assessment. This includes results from a house-owner satisfaction survey, development and testing quality management methodology for IAQ in single-family houses as well as assessment of long-term durability of ventilation devices. Further topics include performance evaluation of ventilation in low energy residences as well as the practical use of the IAQ Dashboards developed by Subtask 1 of the IEA EBC Annex 68.

4.1 House owners’ experience and satisfaction with Danish Low-energy houses - focus on ventilation

<i>Henrik N. Knudsen</i>					Addressed topics: 				
Assessment methods		Assessing ventilation concepts		Novel ventilation solutions		Quality assurance		Assessing in-use performance	

4.1.1 Project objectives, description & methodology

The purpose of this study was to evaluate house owners’ experience and satisfaction with the first Danish detached low-energy single-family houses, built according to energy class 2015 before these supplementary requirements became standard for new buildings (Figure 4-1). The yearly energy demand for heating, ventilation, cooling and hot water for a residential low-energy class 2015 house should be less than $(30 + 1000 / Ae)$ kWh/m², where Ae is the heated floor area. A questionnaire survey was carried out among owners of newly built energy class 2015 houses. It included i.a. questions on their overall satisfaction, and more specifically their satisfaction with the indoor climate (temperature, draught, air quality, noise and daylight), their experience with the technical installations, their airing behaviour in winter and their heat consumption. 370 out of 869 house owners answered the questionnaire, corresponding to a response rate of 43%. The average floor area of the houses was 186 m², 65% had a heat pump, 94% were heated by floor heating and 76% had a balanced mechanical ventilation system with heat recovery.



Figure 4-47 A typical new Danish low-energy house.
The house is more complicated to operate than an older house due to the larger number of technical installation.

4.1.2 Main results and findings

The majority (93%) of the house owners would recommend others to live in a low-energy house. Overall, they rated it to have been a positive experience to move into and live in their new low-energy houses. Important reasons formulated by the house owners themselves were (among other things) good indoor climate and low energy and operating costs. A majority of the house owners perceived the various indoor climate parameters temperature, draught, air quality, noise and daylight to be better (84%, 85%, 84%, 67% and 77% of house owners respectively) in their new low-energy house compared with the conditions in their former dwelling.

More than 90% of the house owners found that the indoor climate was generally satisfactory in summer (93%) and in winter (94%). Temperature conditions were experienced by 84% as satisfactory in winter, while 73% experienced satisfactory temperature conditions in summer. The temperature was found by 4% to be unsatisfactory in winter, compared with 12% in summer. Dissatisfaction was caused by temperature conditions that were too hot in summer. Large windows facing south were mentioned as the reason for the high summer temperatures. It is worth mentioning, that some house owners commented that they also experienced that it was hot in the summer in their former non-low-energy house. Only a few house owners (2-3%) experienced problems with draught and 94% and 96% never experienced problems with draught in winter or summer.

The air quality was perceived as satisfactory by 88% in winter, while 90% perceived it as satisfactory in summer. Only 4% found the air quality unsatisfactory in winter against 3% in summer. To a modest extent, it gave rise to dissatisfaction that the air felt dry in winter daily by 7% and weekly by 11%.

In winter, most people (74%) never perceived problems with noise from the ventilation system, and noise conditions were perceived as satisfactory by 84%. However, 13% perceived annoying noise in the bedroom. In summer, it can be useful to use night ventilation (by-pass heat recovery) to cool down the house. Therefore, it is important to focus on noise reduction in the ventilation system and especially at inlets (and outlets) in bedrooms and children's rooms. The house owners' comments included the ventilation system and heat pump as sources of noise, but in most cases, it was not considered as a big problem but rather something "you could

live with in light of the perceived advantages”. It was stated by 57% that there was no nuisance from noise in any room.

House owners were asked whether they had received sufficient information on how the various technical installations in their house worked. Nearly two-thirds found that they had enough information, while about one third (38%) did not find that they had received sufficient information. Among the latter group of house owners, 83% lacked information on the ventilation system, 49% lacked information on the heating system, 47% lacked information on the heat pump and 31% lacked information on solar cell systems for electricity generation, see Figure 4-2.

House owners were also asked whether they had experienced, what they themselves would categorize as, small or severe problems with the technical installations. Severe problems had been experienced by 9% in winter and 6% had experienced severe problems in summer. Small problems were experienced by 31% in winter and by 24% in summer. The house owners' comments elaborated on the problems, and the recurrent problems were related to the ventilation system, heating system and heat pump immediately upon moving into their new house. Compared with previous similar studies, problems with technical installations and design have decreased. However, there is a need for continuous focus on the commissioning of new, and not necessarily thoroughly tested, high-performance installations and new designs to achieve both low energy consumption and satisfied house owners. It is also worth mentioning that some house owners mentioned that their floor heating system was "slow" and could be difficult to use, but it was emphasized that there was a more constant temperature in the house.

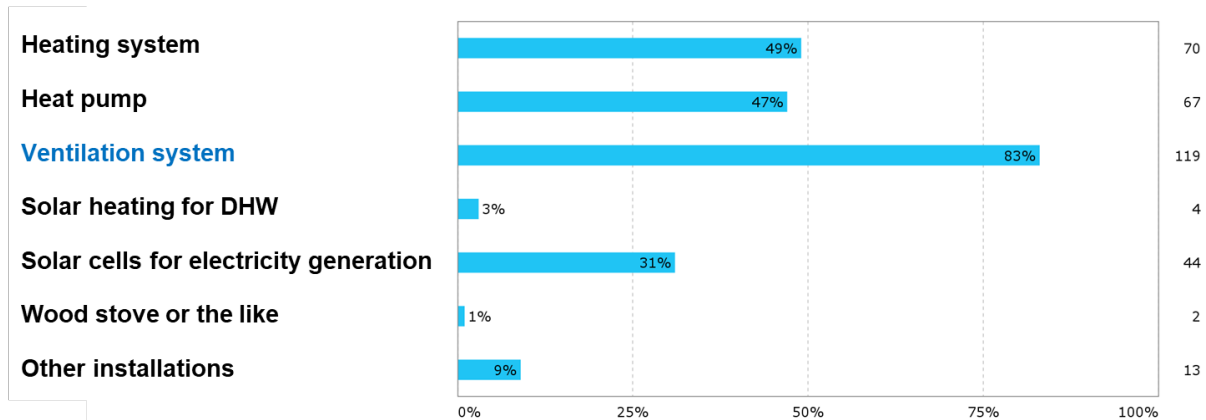

Figure 4-48 About one-third of the house owners did not find that they had received enough information on how the technical installations work. The figure shows their answers to the question “Which of the following installations are you lacking information about?”

Even though the majority of the houses have a balanced mechanical ventilation system, it is seen that most people are still airing out in the winter by opening windows, especially in the daytime, see Figure 4-3. Nearly one third never opens windows at daytime, while about two thirds never open windows in the night. Half of the occupants open and close windows occasionally during the day. As reasons for opening windows, the occupants mention that it is to ventilate, to get fresh air and to cool down especially the bedroom and for airing out the bathroom.

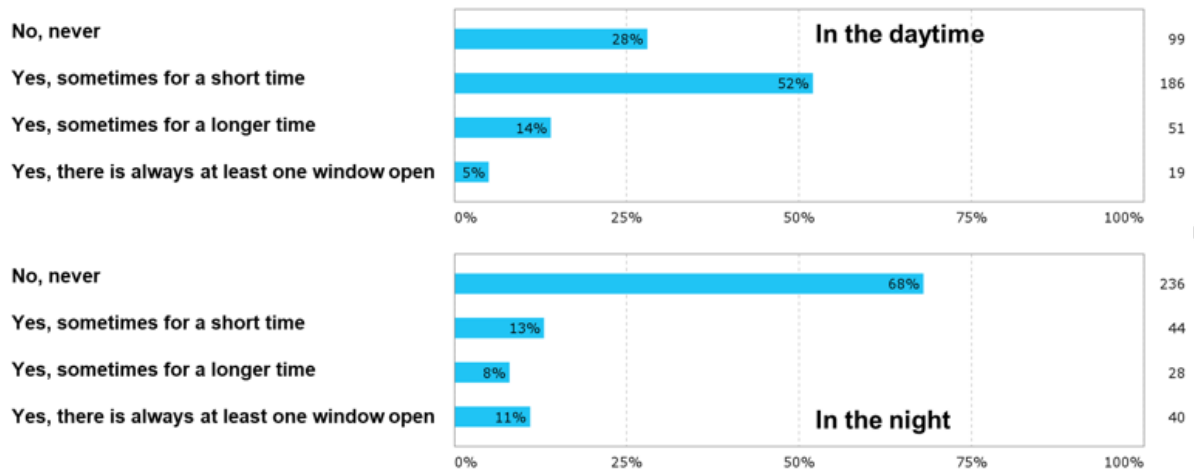

Figure 4-49 Answers to the question “Do you open windows in winter?”

4.1.3 Conclusions, lessons learned for practice

The majority of house owners were satisfied with their low-energy houses, and they can recommend others to live in such houses.

Generally, house owners perceived the indoor climate as satisfactory and as better than in their former older and not low-energy dwelling.

To help ensure satisfaction among owners of new modern low-energy dwellings it is recommended to:

- Avoid launching new installations and new designs in dwellings to achieve a low energy consumption, without first thoroughly testing them for unwanted side effects. Focus on e.g. annoying noise from ventilation systems and heat pumps especially in bedrooms and children’s rooms is recommended.
- Apply robust and easy-to-use technical installations that are operational at the time of moving into the house.
- Minimise problems with high indoor temperatures during summer, by e.g. considering the effect of large windows facing the sun, use of solar shading and bypassing heat recovery in the ventilation system. Provide documentation at the design stage of the indoor temperature in summer by a simulation tool.
- Give a thorough introduction on how it is intended to operate and maintain the technical installations. This will help occupants to understand how their behaviour can support the automatic regulation for the benefit of both the indoor climate and energy consumption.
- Consider bedrooms/children’s rooms as critical rooms because they are occupied for a long time and because e.g. noise, as well as the temperature, are critical parameters for ensuring a good sleep quality.

4.1.4 Further reading

Knudsen, HN 2019, House owners' experience and satisfaction with Danish low-energy houses - focus on ventilation. In CLIMA 2019 - Proceedings of 13th REHVA World Congress, paper 400, CLIMA 2019, Bucharest, Romania.

4.1.5 References

Knudsen, HN and Kragh, J. (2014). Evaluation of energy classes 2015 and 2020 in BR10: Experiences among owners of new low-energy single-family houses and experience of stakeholders in the construction industry. Publisher SBi, 164 pages. (Sbi 2014: 7), (In Danish).

Knudsen, H.N. and Kragh, J. (2015). House owners' experience and satisfaction with Danish low-energy houses. Proceedings of Healthy Buildings, Eindhoven.

Knudsen, H.N., Mortensen, L.H. and Kragh, J. (2015). Satisfaction with indoor climate in new Danish low-energy houses. Proceedings of 7th Passivhus Norden conference: Sustainable Cities and Buildings, Copenhagen.

4.2 Development and test of quality management approach for ventilation and indoor air quality in single-family buildings

<i>Sandrine Charrier, Gaëlle Guyot, Romuald Jobert, François-Rémi Carrié, Claire-Sophie Coeudevez</i>					Addressed topics: 				
Assessment methods		Assessing ventilation concepts		Novel ventilation solutions		Quality assurance		Assessing in-use performance	

4.2.1 Project objectives, description & methodology

The “VIA-Qualité” project (2013-2016) aims at developing quality management (QM) approaches on ventilation and indoor air quality (IAQ), for low-energy, single-family buildings. The French experience on regulatory envelope air leakage QM approaches (Charrier et al., 2013) helped to structure QM approaches on ventilation and IAQ. The first step of the “VIA-Qualité” project was to analyse current building performance, regarding ventilation systems and IAQ, and point out ventilation systems actual dysfunctions and the main steps that had failed and caused them (Guyot et al, 2017). As a consequence, the second step of the “VIA-Qualité” project aims at proposing QM approaches on ventilation and IAQ. Indeed, the implementation of QM tools to better practices at every stage of the construction could avoid many dysfunctions.

The first part of the paper deals with the development of QM approaches on ventilation and IAQ. It presents the structuration of the QM approaches, and the three main tools implemented: the first one is dedicated to the single-family house builders, the second tool is composed of technical drawings, for the workers, and the third tool is dedicated to the final users. The second part of the paper presents the evaluation of the QM approach implementation by two French builders on eight low energy houses. First, the way the two builders were guided by the “VIA-Qualité” partners is presented. Then, the results of the application of the QM approaches on eight low-energy dwellings are presented.

4.2.2 Main results and findings

In a QM approach, we must know, at any stage, “who does what”, “how”, “when” and which document will trace each action. Thanks to the above-described analysis of current building performance, we have been able to identify main actors, depending on the stage of the conception. The main protagonists (“who”) acting in the conception and installation of ventilation systems are: the client, the QM approach headmaster, the engineering department salesperson, the engineering department, the site supervisor and craftsmen. Moreover, for each type of failure observed, we analysed who should have acted to avoid it (“what”).

Then, the main stages of a building conception and construction (“when”) that have been noticed are the following: preliminary studies, engineering studies, beginning of the construction, dwelling construction, dwelling commissioning and dwelling life and maintenance.

Thus, the first step of the QM approach structuration has been to create a QM board, detailing, at each stage of a building conception and construction, for each actor, the list of actions (“what”): processes to be applied

and examples of documents that could trace their application. In addition, processes and document descriptions have been implemented to help builders to implement their QM approaches. A synthesis of the processes and documents chronology is presented in Figure 4-4.

This QM approach structuration led to the identification of 3 main tools: a single-family house *builder’s guide*, a *craftsmen guide* and a final *user’s guide*, which are described in this paper.

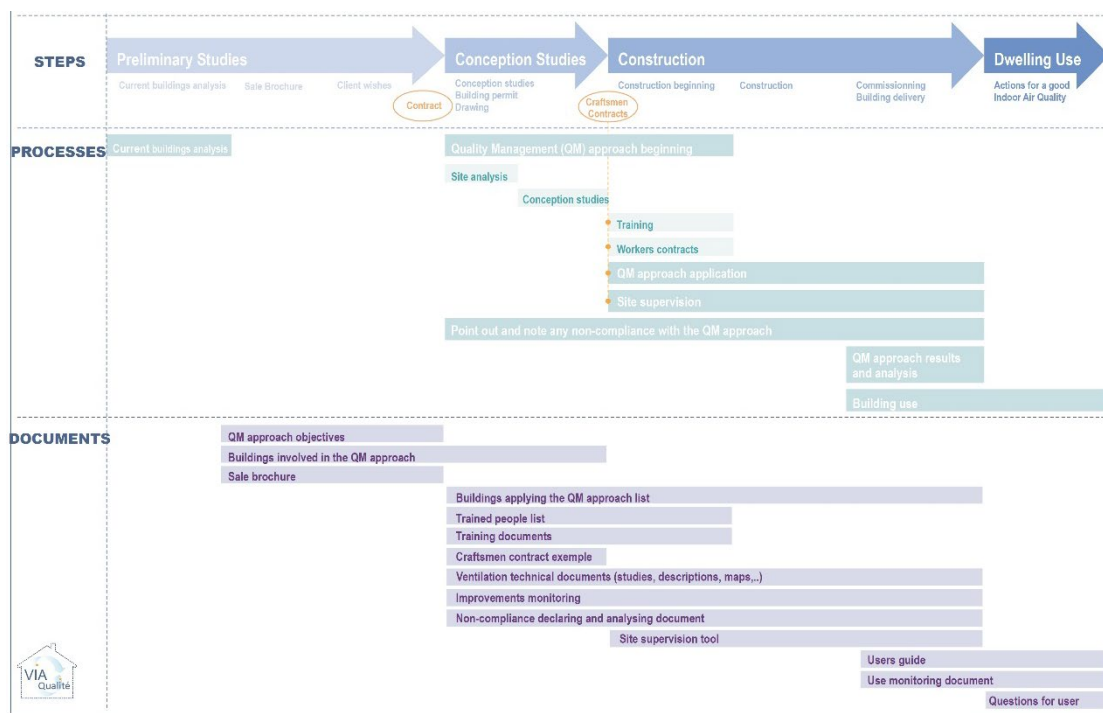

Figure 4-50 Examples of processes and documents that could be implemented for a QM approach.

Two developing companies focused on single-family houses proposed to apply the main steps and tools of the proposed QM approaches on eight single-family dwellings. The “VIA-Qualité” partners guided builders on their implementation and application and, then, measured and analyzed ventilation systems and IAQ performances. The two volunteer builders were chosen as they had a certified QM approach on building airtightness, validated by a national framework of the French Ministry for Ecology. They were aware of QM approaches structuration and organization. This paper describes: the sample selection and description, the way builders implemented the QM approaches steps and tools, including builders and craftsmen guides, the measurement campaign and results of QM approach implementation and the feedback.

4.2.3 Conclusions, lessons learned for practice

The “VIA-Qualité” project aimed at proposing the main steps of quality management approaches on ventilation and indoor air quality, and at testing them on eight single-family dwellings. The validation of the approaches has not been possible, because of different time non-matching issues and others.

Nevertheless, the proposition and application of the QM approaches enabled to point out the main steps in the QM approaches implementation and application. Moreover, it enabled to highlight key rules that had not been identified at the beginning.

Thus, the main steps in a QM approach on ventilation and IAQ are: conception, training, involvement and site supervision. The main tools that appeared useful for builders are (Cerema website, 2018):

- a guide for single-family builders, that explains how to implement a QM approach on ventilation and IAQ,
- a guide for installers composed by technical drawings,
- a guide for the final user,
- and for builders: a simplified calculation drop tool and a site supervision document.

The “VIA-Qualité” project enabled to begin a global questioning of the quality of ventilation systems and indoor air quality in French practices. It enabled to define responsibilities, key rules and key steps. In addition, it implemented guides and tools that will help any professional to get better. French professionals are quite new to these subjects, but we can expect a future involvement as much as it occurred for the quality of building airtightness 10 years ago.

4.2.4 Further reading

Charrier, S., G. Guyot, R. Jobert, F. R. Carrié, and CS. Coeudevez. 2018. “Development and Test of Quality Management Approach for Ventilation and Indoor Air Quality in Single-Family Buildings.” In *Smart Ventilation for Buildings*. Juan les Pins, France.

4.2.5 References

Charrier S, Ponthieux J, Huet A (2013). Airtightness quality management scheme in France: assessment after 5 years operation, 34th AIVC Conference, Athens, Greece, 2013,

Guyot, G., Melois, A., Bernard, A.-M., Coeudevez, C.-S., Déoux, S., Berlin, S., Parent, E., Huet, A., Berthault, S., Jobert, R., Labaume, D., 2017. Ventilation performance and indoor air pollutants diagnosis in 21 French low energy homes. *International Journal of Ventilation* 0, 1–9. <https://doi.org/10.1080/14733315.2017.1377393>

Cerema website, 2018, <https://www.cerema.fr/fr/actualites/qualite-ameliorer-qualite-installations-ventilation-air-0>

4.3 Applications of the Promevent Protocol for ventilation systems inspection in French regulation and certification programs

<i>Adeline Bailly Mélois, Laure Mouradian</i>									
<div style="float: right;"> Addressed topics: Health & Comfort Spatial requirements Cost & Energy consumption Refurbishment Commissioning Quality of installation User satisfaction </div>									
Assessment methods		Assessing ventilation concepts		Novel ventilation solutions		Quality assurance		Assessing in-use performance	

4.3.1 Project objectives, description & methodology

For many years, checks and measurements to assess the functioning of buildings’ ventilation systems have been performed according to various protocols (e.g. standards, guides, certification requirements). Moreover, the uncertainty of the measurements results has most of the time not been evaluated. To make these practices more uniform and to improve the reliability of the inspection of ventilation systems, eight French organizations have conducted the Promevent project (2014-2017) (Bailly and Lentillon 2014, Bailly Mélois et al. 2017). The objective of the Promevent project was to propose a protocol to assess the quality of the residential mechanical ventilation system, including specifications for visual checks and measurements with acceptable uncertainties. This protocol and its practical guide were published (in French) in 2017.



4.3.2 Main results and findings

The Promevent protocol (Figure 4-5) applies to new dwellings, both single-family houses, and multi-family buildings, equipped with a balanced ventilation system or an exhaust-only humidity demand-controlled ventilation system. It proposes a methodology in 4 steps (consistent with EN 14134 and EN 16798-17):

- pre-check (mandatory),
- functional checks (optional),
- functional measurements at air terminal devices: airflow measurement and static pressure measurement (optional),
- special measurement: ductwork airtightness measurement (optional).



Figure 4-51 Cover of the Promevent protocol.

It also proposes a methodology for sampling the buildings, the dwellings or the systems, and gives guidelines for the report. A ventilation system inspection performed according to the Promevent protocol includes at least a pre-

check (analysis of documents before the check), and one of the three next steps. The paper explains each of the four steps and what the operator has to do when they perform a ventilation system inspection according to the Promevent protocol.

During the different steps of the Promevent project, a very large group of professionals have been consulted: the French Ministry in charge of Construction and the French Environment and Energy Management Agency (ADEME), but also from various associations or federations representative of the industry, builders, measurers, certification organisations, standardization organisations, training organisations, etc. Due to this consultation, the Promevent protocol is very widely accepted and it is becoming the national reference for inspection of mechanical ventilation systems in dwellings.

In a regulatory context, the Promevent protocol has to be applied in two situations. First, when the design energy consumption of a building is 20% below the regulatory limit (40% for office buildings), an exemption from local building regulations, such as maximum building height, may be granted, allowing the construction of a bigger building. To obtain this bonus, the building has to respect two criteria among three: one is about greenhouse gas emission, the second one relates to the valorization of the construction waste, and the last one requires specific choices of material regarding the impact on the indoor air quality and the quality of the ventilation system. In this last case, an inspection of the ventilation system has to be performed according to the Promevent protocol (JOFR, October 2016). At the end of 2016, another regulatory document was published and refers to the Promevent protocol. This text targets that public buildings should be exemplary from an energy and environmental point of view, which have to respect two criteria among the three. One of the criteria requires that the ventilation is controlled according to the Promevent protocol (JOFR, December 2016). These two regulatory actions are too recent to allow to collect feedbacks from the applications of the Promevent protocol.

So far, most of the inspections of residential ventilation systems are performed in order to obtain an Effinergie label. Effinergie is a French association which proposes certification for energy efficiency initiatives in new and renovated buildings (Carrié and Dervyn, 2017). With its first labels, Effinergie has promoted the importance of building airtightness. Since 2012, the association has engaged in the quality of ventilation systems and requires functional checks and ductwork airtightness measurements for its new labels. More specifically, these requirements are mandatory to obtain Effinergie+ certification, which has been given to 13,153 dwellings (data from June 2018). Since the publication of the Promevent protocol, Effinergie decided to replace its own protocol with the Promevent protocol. Then, for each dwelling candidate for an Effinergie label, an independent and state-approved (Charrier et al., 2017) measurer has to verify the quality of the ventilation system according to the Promevent protocol. Other methods and reference documents are being modified or will be modified to integrate the Promevent protocol. For example, the reference document of the French national indoor air quality observatory (OQAI) refers to the Promevent method and the checklists for ventilation system inspection therein. As well, the certification body CERQUAL Qualitel Certification has included the Promevent protocol in its reference document.

In order to raise awareness among ventilation professionals, the Promevent protocol has been included in the Praxibat training course. Praxibat is a national training plan regarding buildings' energy efficiency. It includes 203 technical facilities in France, with 74 dedicated to ventilation. The ventilation training lasts 3 days and includes theoretical parts to understand the different types of ventilation systems as well as practical parts to learn how to install a ventilation system and how to verify it. The Promevent protocol will also be presented in a MOOC dedicated to indoor air quality and buildings ventilation.

Finally, the Promevent protocol has been used during the reviewing of the European standard prEN 14134 Ventilation for buildings - Performance testing and installation checks of residential ventilation systems. The method and its checklists were used as the starting point of the draft document, modified and completed to match with the scope of the European standard.

4.3.3 Conclusions, lessons learned for practice

The Promevent research project finally resulted in a reliable and robust reception protocol for residential ventilation systems. This has been achieved in line with the European standard guidelines for inspection of ventilation systems. A large part of the work consisted in working on the uncertainties related to the measurement of flow rates and pressures at the air terminal devices, taking into account both the uncertainty related to the equipment and the uncertainty related to the measurement method. A guidebook has been edited complementary to the protocol in order to explain and illustrate each point.

The Promevent protocol is widely used in certification programs for mechanical ventilation systems installed in residential buildings and new research programs concerning natural ventilation systems and non-residential buildings.

4.3.4 Further reading

Bailly Melois, A., and L. Mouradian. 2018. “Applications of the Promevent Protocol for Ventilation Systems Inspection in French Regulation and Certification Programs.” In *Smart Ventilation for Buildings*. Juan les Pins, France.

4.3.5 References

Bailly, A., and Lentillon, C. (2014). PROMEVENT: Improvement of protocols measurements used to characterize ventilation systems performance. 35th AIVC Conference, Poznań, Poland, 24-25 September 2014.

Bailly Mélois, A., Rousseuw, E., Caré, I., and Carrié, F.-R. (2017). Assessment of airflow measurement uncertainty at terminal devices. 38th AIVC Conference, Nottingham, UK, 13-14 September 2017.

Carrié, F.-R., and Dervyn, Y. (2017). The Effnergie approach to ease transitions to new regulatory requirement. Qualicheck Fact sheet #45.

Charrier, S., Mélois A., and Carrié, F.-R. (2017). Ductwork airtightness in France: regulatory context, control procedures, results. Qualicheck Fact sheet #54.

French Regulation - JORF (2016). Arrêté du 12 octobre 2016 relatif aux conditions à remplir pour bénéficier du dépassement des règles de constructibilité prévu au 3° de l'article L. 151-28 du code de l'urbanisme. JORF n°0242 du 16 octobre 2016 - texte n° 16.

French Regulation - JORF (2016). Décret n° 2016-1821 du 21 décembre 2016 relatif aux constructions à énergie positive et à haute performance environnementale sous maîtrise d'ouvrage de l'Etat, de ses établissements publics ou des collectivités territoriales. JORF n°0298 du 23 décembre 2016 - texte n° 59.

4.4 Long-term durability of humidity-based demand-controlled ventilation: results of a ten years monitoring in residential buildings

<i>Elsa Jardinier, François Parsy, Gaëlle Guyot, Stéphane Berthin</i>					Addressed topics: 				
Assessment methods		Assessing ventilation concepts		Novel ventilation solutions		Quality assurance		Assessing in-use performance	

4.4.1 Project objectives, description & methodology

Historically born 35 years ago in the context of an energy crisis, humidity-controlled mechanical exhaust ventilation (RH-MEV) was designed to protect the buildings from condensation induced by tighter building constructions and lower indoor temperatures, while limiting the heat losses due to ventilation. RH-MEV is a Demand Control Ventilation (DCV) system adjusting the airflows according to the estimated needs of the building and its occupants, with a direct relative humidity (RH) measurement in both the wet and dry rooms. The extensions and retractions of a hygroscopic fabric modify the cross-section of inlets and outlets upon hygrometric changes in their environment without the need for motors or electronic sensors (Figure 4-6). Its simple and reliable components and principle of operation allow its robustness, low cost and ease of installation. This last aspect is of tremendous importance, knowing that non-compliance to ventilation systems installation rules are observed in 50% to 65% of the controlled dwellings (ADEME, 2016). As a result, and pushed by the energy performance regulation, this system has been the most widely installed in new French dwellings in the past 10 years (Bailly, G.Guyot and Leprince 2016).



Figure 4-52 Humidity sensible exhaust unit.

In this paper, the studied ventilation system includes a fan, ductwork and as an air terminal devices, humidity-sensitive fully-mechanical air inlets in the dry rooms and humidity sensitive fully-mechanical exhaust units in the wet rooms. Toilets are equipped with an occupancy sensor controlling the self-adjusting exhaust unit. Energy savings have been estimated at about 30% to 50% of the heating energy compared to constant airflow MEV (Savin and Bernard 2009).

This chapter presents a 10 years follow-up study on large-scale monitoring of thirty new occupied apartments (1 to 4 bedrooms) in two residential buildings equipped with this RH-MEV system (see Table 4-1), which extended from 2007 to 2009 in Paris and Lyon, France. The aim was an on-field evaluation of the RH-MEV components and systems in terms of energetic performance and indoor air quality, over two heating seasons (2007-2009). During the construction phase, measuring equipment was installed in the ventilation terminals as well as in the rest of the building. The equipment included Indoor Air Quality (IAQ) sensors in different rooms

of each dwelling (temperature, humidity, and CO₂), as well as pressure and volume flow sensors for monitoring the ventilation system.

Table 4-10 Characteristics of the instrumented buildings.

Site	Height	Type of dwellings	Air permeability	Monitored
Paris	8 floors	1 to 5 main rooms	$q_{4Pa-surf} = 1.07 \text{ m}^3/\text{h}/\text{m}^2 @ 4 \text{ Pa}$ $n_{50} = 1.51 \text{ ACH} @ 50 \text{ Pa}$	19 dwellings
Lyon	6 floors	2 to 5 main rooms	$q_{4Pa-surf} = 0.64 \text{ m}^3/\text{h}/\text{m}^2 @ 4 \text{ Pa}$ $n_{50} = 0.94 \text{ ACH} @ 50 \text{ Pa}$	10 dwellings

4.4.2 Main results and findings

The initial 2007 to 2009 project showed:

- Good IAQ in terms of CO₂ and humidity provided by the ventilation system, despite the over-occupation of some apartments. These results showed the system's appropriate reaction to human occupation resulting from a good correlation between CO₂ and airflows.
- In-situ energy savings on heat losses of 30 % on average compared to constant airflows from the French regulation.
- Good agreement of the heat loss measurements with the simulation models used for the French DCV technical agreements.

Ten years later the data acquisition system was turned back on to assess the ventilation system behaviour/performance after a prolonged in-situ functioning period. The preliminary results show:

- At start-up, more than 80 % of the sensors are still in working condition.
- Using this rough data, the average in-situ drift of the hygroscopic devices after 9 years of operation is estimated below $\pm 1.5 \text{ \%RH}$ and is lower than the announced accuracy of the electronic humidity sensors at installation ($\pm 1.8 \text{ \%RH}$).
- The observed drift of volume flows in some of the exhaust units is typical in the absence of maintenance.
- The battery of the presence-based toilet exhaust is often (90 %) fully discharged.

4.4.3 Conclusions, lessons learned for practice

This type of humidity-based ventilation offers good performance regarding humidity and CO₂ based IAQ indicators, including for high occupation rates.

The robustness of this type of demand-controlled ventilation seems also very high, with a priori good performances observed ten years later, despite a lack of cleaning and maintenance.

These first promising results on the durability of the RH-MEV systems performance need to be confirmed by a new on-going project which shall include:

- The collection of the ventilation devices for a full quality control before and after the recommended cleaning.
- The collection of the metrology sensors for re-calibration and drift-correction on the measurements.
- A new set-up for each apartment including particle sensors to follow the latest interests of IAQ research.

4.4.4 Further reading

Savin, J-L., and A-M. Bernard. "'Performance" project : Improvement of the ventilation and building air tightness performance in occupied dwellings in France." AIVC. Berlin, 2009

4.4.5 References

ADEME. "VIA-Qualité Guide pratique à destination des constructeurs de maisons individuelles." 2016.

Bailly, A., G.Guyot, and V. Leprince. "Analyse of about 90 000 Airtightness Measurements Performed in France on Residential and Non-Residential Buidings from 12008 to 2014." Proceedings IAQ 2016 Defining Indoor Air Quality : Policy, Standars and Best Practices. AHSRAE - AIVC. Alexandria, 2016.

Savin, J-L., and A-M. Bernard. "'Performance" project : Improvement of the ventilation and building air tightness performance in occupied dwellings in France." AIVC. Berlin, 2009.

4.5 Practical use of the Annex 68 Indoor Air Quality Dashboard

<i>Marc Abadie</i>								Addressed topics: 	
Assessment methods		Assessing ventilation concepts		Novel ventilation solutions		Quality assurance		Assessing in-use performance	

4.5.1 Project objectives, description & methodology

IEA Annex 68 Subtask 1 aimed at setting up the metrics to assess the performance of low-energy buildings in regards to indoor air quality (IAQ), combining the aspirations to achieve very high-energy performance without compromising indoor environmental quality (Abadie and Wargocki, 2017). Our approach can be summarized as follows. In the first phase, we selected target indoor air pollutants, i.e. pollutants listed by cognizant authorities as being harmful to humans during short-term (<24h) or long-term (>week) exposures. Then we checked whether these compounds were measured by published studies in residential environments and at concentrations that exceeded the levels identified in the first phase. In a second phase, we reviewed previously proposed IAQ metrics to identify the different approaches used in the past and to judge whether any of them would be useful to define the best science-based indices for evaluation of IAQ. We proposed IAQ sub-indices based on acute (short-term) and chronic (long-term) effects as the ratio of the concentrations to the guideline levels; for chronic effects, we also proposed the DALY approach (Disability-Adjusted Life Years) as an IAQ index. As for the multipollutant index, we proposed the maximum of the calculated indices acknowledging limitations and inaccuracies introduced by aggregation methods. Finally, the value of the index, or set of sub-indices, for IAQ ultimately needs to be weighed against the additional use of energy needed to improve IAQ in comparison with current standard practice.

The present case study summary aims at illustrating the use of the IAQ dashboard in the design state of a project. Figure 4-7 presents the graphical representation of IAQ indices along with energy consumption. All indices for single pollutants are seen for long-term (LT) and short-term (ST) effects using two approaches (based on Exposure Limits and DALY). Energy consumption is displayed in the lower right corner.

As an example, we use the time-varying pollutant concentrations obtained by Cony-Renaud-Salis et al (2018 and 2019) by numerical simulations by coupling a building energy simulation software with a multizone indoor air quality and ventilation program. The case study is a two-story low-energy house (Figure 4-8) with one living room and three bedrooms located in La Rochelle, France (small city, low pollution). See the references for more details regarding wall compositions, furniture quantity and everyday objects such as books, shoes, computers, TV monitor, etc. Ventilation rates have been calculated according to the French standards (180 m³/h during 30 min. at noon and 19:30, 105 m³/h otherwise).

The goal of this study is to evaluate the IAQ of three possible solutions of ventilation systems commonly found in French residential buildings using the IAQ dashboard: natural ventilation using vertical ducts for extraction (NAT), self-regulated exhaust (EXH) and balanced mechanical ventilation (BAL). We considered here 9 out of the 16 target pollutants identified in Subtask 1: acetaldehyde, acrolein, benzene, formaldehyde, nitrogen dioxide, particulate matter (PM_{2.5}, PM₁₀), styrene and toluene. The time-varying pollutant concentrations have

been integrated according to the occupancy schedule in order to calculate the exposure to each pollutant during one week in winter.

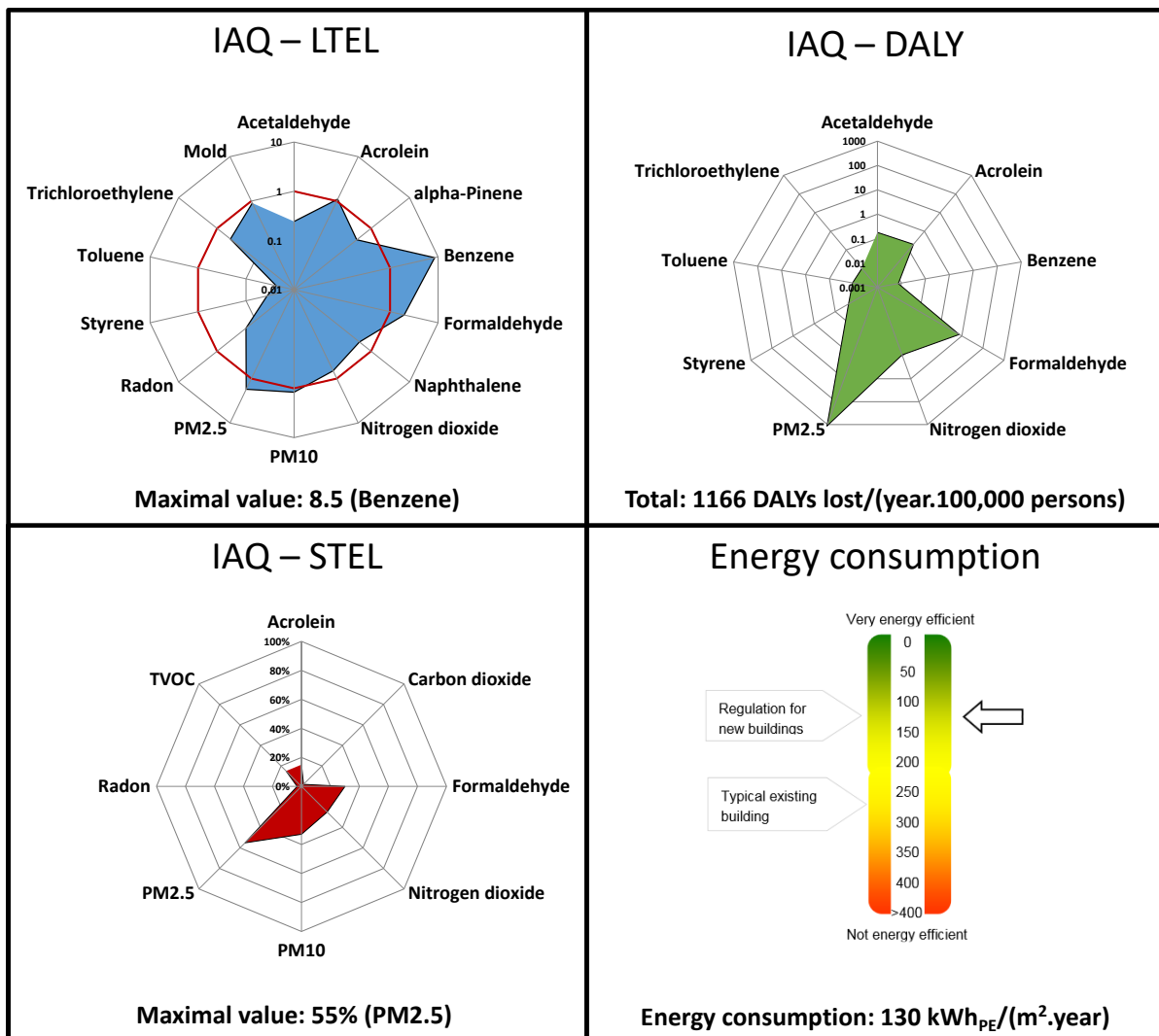

IAQ-LTEL is for Indoor Air Quality – Long-Term Exposure Limit, **IAQ-STEL** is for Indoor Air Quality – Short-Term Exposure Limit and **IAQ-DALY** is for Indoor Air Quality – Disability-Adjusted Life Years.

Figure 4-53 IAQ/Energy dashboard for low-energy residential buildings (data represented here are just for display and do not represent actual situation).

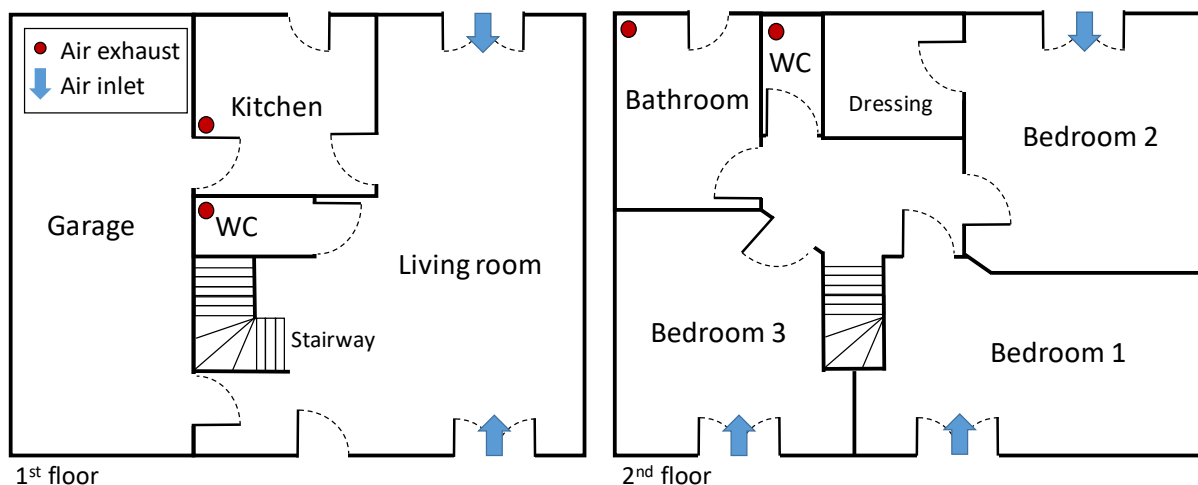

Figure 4-54 Building design.

4.5.2 Main results and findings

Among the four quadrants of the IAQ dashboard, only the one relative to Long-Term Exposure Level, called IAQ-LTEL in Cony-Renaud-Salis et al (2017), is represented here because no energy consumption calculation has been carried out here (fourth quadrant). There is no exceedance of short-term exposure levels (third quadrant) and the DALY representation (second quadrant) does not allow a clear comparison between the cases. Figure 4-9 presents the IAQ-LTEL for the three ventilation systems compiled in one graph to ease the comparison. Overall, the results obtained by these numerical simulations confirmed the trend observed with real experimental data such as those used in Subtask 1: LTEL is higher than 1 (i.e. pollutant concentration higher than the Exposure Limit Value) for acrolein, benzene, formaldehyde, nitrogen dioxide and particulate matter ($PM_{2.5}$, PM_{10}) and lower than 1 for the other pollutants. In this example, benzene is identified as the pollutant of higher index; actions to improve the IAQ should then focus on reducing indoor benzene sources that are here the building materials. Regarding the performance of the three ventilation systems, it should be noted that, even if the systems were sizing (ducts and fans) with the same objective in terms of exhausted airflow rates, the simulation results show 20% higher airflow rates for the balanced system compared to the self-regulated exhaust; those for the natural ventilation system tend to be the lowest. This fact explains why the LTEL for pollutants of only indoor emissions (acetaldehyde, acrolein, benzene, formaldehyde, styrene and toluene) is lower for the BAL and higher for the NAT systems. The role of the filtration regarding the BAL system is clearly observed for $PM_{2.5}$ and PM_{10} ($PM_{2.5}$ LTEL values are 0.6, 1.1 and 1.2 for BAL, EXH and NAT systems, respectively). Outdoor gaseous pollutant concentration (nitrogen dioxide) is almost not affected by the ventilation systems.

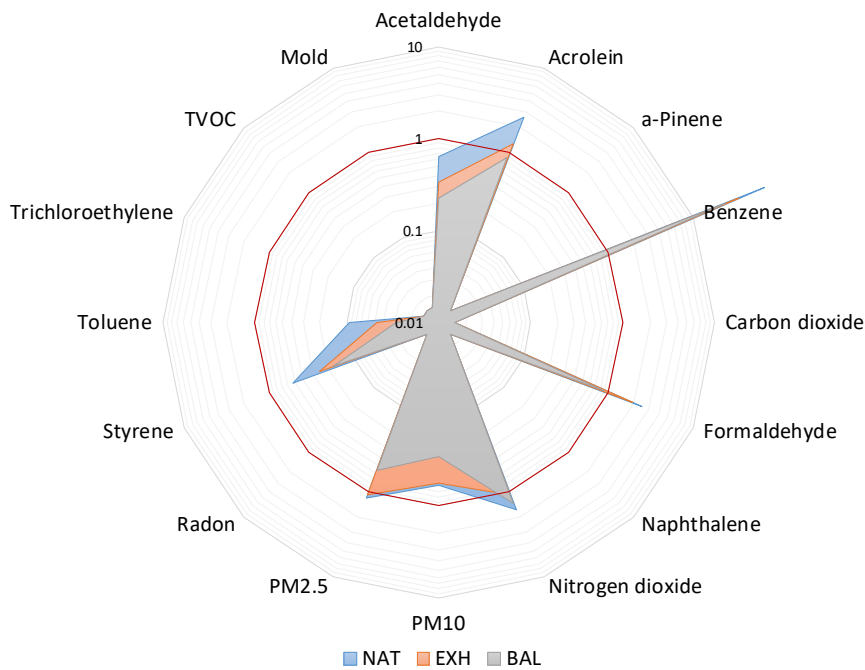

Figure 4-55 IAQ-LTEL for the three studied ventilation systems.

4.5.3 Conclusions, lessons learned for practice

This exercise shows that, for the ventilation cases studied here that comply with ventilation regulations in terms of permanent airflow rates, the assessment of system performance can be limited to the long-term LTEL index. Its value for PM_{2.5} demonstrates that a 50% IAQ improvement can be achieved with a balanced system compared to other ventilation systems.

4.5.4 Further reading

Abadie, M., Wargocki, P. (2017). CR 17: Indoor Air Quality Design and Control in Low-energy Residential Buildings- Annex 68 | Subtask 1: Defining the metrics. AIVC Contributed Report 17, 116p.

4.5.5 References

Abadie, M., Wargocki, P. (2017). CR 17: Indoor Air Quality Design and Control in Low-energy Residential Buildings- Annex 68 | Subtask 1: Defining the metrics. AIVC Contributed Report 17, 116p.

Cony-Renaud-Salis, L., Abadie, M., Wargocki, P., Rode, C. (2017). Towards the definition of indicators for assessment of indoor air quality and energy performance in low-energy residential buildings, *Energy and Buildings*, 152, 492-502.

Cony-Renaud-Salis, L., Ramalho, O., Abadie, M. (2018). Development of a Numerical Methodology to Assess Indoor Air Quality in Residential Buildings, *Proceedings of the 15th Conference of the International Society of Indoor Air Quality & Climate (ISIAQ)*, July 22 to 27, Philadelphia, USA.

Cony-Renaud-Salis, L., Belhaj, N., Ramalho, O., Abadie, M. (2019). Analysis of the need of detailed modelling for the assessment of indoor air quality in residential buildings. Proceedings of 13th REHVA World Congress CLIMA 2019, May 26 to 29, Bucharest, Romania.

4.6 Performance evaluation of Mechanical Extract Ventilation (MEV) systems in three ‘low-energy’ dwellings in the UK

Robert Lowe, Hector Altamirano-Medina, Jez Wingfield, Lai Fong Chiu, Esfand Burman					Addressed topics: 				
Assessment methods		Assessing ventilation concepts		Novel ventilation solutions		Quality assurance		Assessing in-use performance	

4.6.1 Project objectives, description & methodology

This project investigated the performance of two mid-terrace and one end of terrace houses completed in 2012 in Southampton, UK (Figure 4-10). The project was carried out in two phases: 1) Post construction and early occupation, 2) performance in-use and post-occupancy.

These houses were built as part of a wider regeneration scheme that in its first phase entailed the erection of 168 dwellings formed of several terraces of townhouses and apartment blocks, together with the construction of the first of the two energy centres and its associated heating network. The target air permeability for the houses was 6 m³/hr/m² at 50 Pa pressure difference, and ventilation was provided using a centralised continuous Mechanical Extract Ventilation (MEV) system. Air is extracted via an MEV fan unit located in the loft through ceiling mounted air valves in the wet rooms (kitchen, toilet, & two bathrooms). The kitchens are fitted with a filtered re-circulating cooker hood above the hob. Fresh air is also provided by closable trickle vents integrated into the window frames. The trickle vents are of the low profile type with the external vent slot concealed between the top of the casement and the window frame. The fan speeds are set by two potentiometers accessible on the outside of the unit casing (one for trickle and one for boost) which should make it relatively easy to adjust and commission the system. The investigations covered a review of design and construction documents, in situ measurements of building fabric heat loss and the flow rates achieved through the MEV system in trickle and boost modes, occupant satisfaction and feedback, and the performance of the district-heating scheme. The focus of this summary report is on the key findings related to the performance of MEV systems.



Figure 4-56 Outside view of the monitored dwellings.

4.6.2 Main results and findings

The MEV systems in these dwellings were designed by the building services sub-contract designer to be compliant with the requirements of the Approved Document Part F 2006. The designed trickle and boost flow rates for the monitored dwellings were provided on the engineering drawings and are given in Table 4-2.

Table 4-11 Design flow rates for MEV system in the monitored dwellings.

Room	Design trickle extract flow rate (l/s)	Design boost extract flow rate (l/s)
Kitchen	11	13
W/C ground floor	5	6
Bathroom 1st floor	7	8
Bathroom 2nd floor	7	8
TOTAL	30	35

The total air extract rate at the design trickle setting was just under 0.5 air changes per hour. No commissioning certificates or any other test data were provided by the project team for the test dwellings or indeed any other dwellings on the development. There was no requirement to provide mechanical ventilation system commissioning certificates under the Part F 2006, although they would have been required had the system been designed under Part F 2010. An examination of the installation of the MEV system found that the duct runs from the fan unit to the vents in the house and the terminal ridge vents were installed according to drawings provided by the building services designer. However, whilst the terminal duct running to the ridge vent was fully insulated, the ducts running in the loft to the vents in the houses were not. This could give rise to condensation within the ducts, which could run back to the house vents or pool at low points. It was also noted that there was extensive use of flexi-duct in the loft, especially at the connections to the fan unit. Whilst it is normal to use a small amount of flexible duct to make connections, the amount observed was excessive and had been laid in such a way as to form tight bends, which would cause back pressure on the system and reduce the system performance compared to design assumptions. An examination of the flexible connections between the rigid duct and the ceiling vents showed that in many cases the flexible duct was constricted and not properly aligned (Figure 4-11), which would increase back pressure and reduce system efficiency. It was also noted that the MEV boost mode in the WC and bathrooms, which was triggered by the lights switch, did not have an over-run function, and the system would revert to trickle mode when the light switch was turned off. A humidistat would ensure that boost mode operated for a long enough period after the bathroom was vacated and the light turned off to clear moisture e.g. from a shower. However, humidistat controls should only be used in wet rooms (baths, shower, utility) and not WCs where odour control is the main issue (Part F 2010).

Table 4-3 provides the total trickle and boost extract rates measured from the MEV systems as part of the investigations.

Table 4-12 Measured total extract rates in the monitored dwellings.

Dwelling	Total trickle extract flow rate (l/s)	Total boost flow rate (l/s)
Mid-terrace House 1	12	35
Mid-terrace House 2	12	30
End of Terrace House	2	24

The measurement data suggest that the installed MEV systems are unlikely to have been commissioned or balanced in accordance with the design targets and consequently would fail to meet the performance requirements. The measured trickle flow rates were much lower than the design rates. This could have a

significant effect on the air quality, condensation and risk of mould growth depending upon the air-tightness of the fabric.



Figure 4-57 Extract terminals with diffusers removed showing constrictions in flexible ducting.

4.6.3 Conclusions, lessons learned for practice

Measurements of low extract rates from the mechanical ventilation systems, coupled with observations of poorly installed ductwork, suggest that some MEV systems may fail to deliver their designed performance. The consequence of this is that the air quality in some low energy dwellings may not be as good as expected and that there could be longer-term issues with condensation and mould growth. These problems could be attributed to a mixture of issues such as poor installation practice, inadequate commissioning processes, and a general lack of understanding by the project team about the important influence that mechanical ventilation systems can have on indoor air quality and energy performance. The requirement to provide mechanical ventilation system commissioning certificates came into force in England and Wales after the inception of Part F 2010, in support of the updated Building Regulations 2010 (regulation 42). If the commissioning is done properly and the identified faults are corrected, this can help improve the commissioning process and provide necessary information about the system performance to building users.

4.6.4 Further reading

Innovate UK. (2013). Centenary Quay Fabric and District Heating Performance Study , Phase 1 : Post construction and early occupation, Building Performance Evaluation programme, Domestic Buildings. London: Innovate UK.

Innovate UK. (2014). Centenary Quay Fabric and District Heating Performance Study , Phase 2 : In-use performance & post occupancy evaluation, Building Performance Evaluation programme, Domestic Buildings. London: Innovate UK.

4.6.5 References

Office of Deputy Prime Minister, 2006. Approved Document Part F, Means of ventilation (2006 edition).

HM Government, 2010. Approved Document Part F, Means of ventilation (2010 edition).

4.7 Indoor air quality in low energy dwellings: performance evaluation of two apartment blocks in East London, UK

<i>Esfand Burman, Clive Shrubsole, Samuel Stamp, Dejan Mumovic, Mike Davies</i>					Addressed topics: 				
Assessment methods		Assessing ventilation concepts		Novel ventilation solutions		Quality assurance		Assessing in-use performance	

4.7.1 Project objectives, description & methodology

The aim of this project was to evaluate the energy and indoor air quality (IAQ) performance in a new residential development comprising two apartment blocks in East London. These apartments were completed in December 2014 and January 2015. Block A is a 13-storey building; Block B has 9 floors. They are located next to each other and close to two main roads in the London Borough of Tower Hamlets in East London (Figure 4-12). There are 98 flats and maisonettes (two-storey apartments) in these blocks. Building fabric U values are around 40% better than the limits prescribed by the 2013 edition of the Building Regulations in England (e.g. U value of 0.19 W/m²K for external walls against 0.35 W/m²K set out as the limiting value). The buildings were also designed with a target air permeability of 2-3 m³/hr./m² at 50 Pa pressure difference, which is significantly lower than 10 m³/hr./m² limit set out in the Building Regulations. Consequently, mechanical ventilation with heat recovery (MVHR) was specified to ensure adequate background ventilation is provided to these apartments. The air is continuously drawn from the wet rooms (kitchens, bathrooms, and toilets) and replaced by fresh air supplied to habitable rooms. The ventilation rate is controlled based on the humidity level. Up to 95% of heat in extract air can be recovered in the heat recovery unit. A summer by-pass mode ensures there is no heat recovery during summer and hot periods whilst fresh outdoor air provided to the dwellings is still filtered. Heating is provided by a district-heating scheme that is currently gas-fired with provisions for integration of a combined heat and power (CHP) plant in future. There is no mechanical cooling.



Figure 4-58 External view of the apartments.

The following investigations were planned with a specific focus on indoor air quality in sample dwellings:

1. **Active monitoring of IAQ:** Five sample apartments were selected for detailed analysis of IAQ to meet the minimum sampling requirement of 5% of zones in large buildings in EN 15251. IAQ sensors were installed to measure the concentration levels of CO₂, PM_{2.5} and NO₂ in living rooms and kitchens of the apartments during typical weeks in the heating season (February-March 2018) with 5-minute

frequency.¹⁷ CO₂ levels were also monitored in one bedroom. CO₂ concentrations are often used as a proxy for IAQ in the UK construction sector. PM_{2.5} and NO₂ were identified as pollutants with a risk of high concentration in new low energy dwellings in the IEA EBC Annex 68 programme with significant health impacts, and are also of great interest in London due to major outdoor sources for these pollutants. Concentrations of these pollutants were compared against the recommended limits provided in BS EN 15251 and WHO guidelines.

2. **Passive Sampling for IAQ:** the diffusive sampling method, in accordance with ISO 16017, was used to measure the average concentrations of volatile organic compounds (VOCs) with a risk of concentrations higher than long-term/chronic exposure limit values (ELVs) in new low energy dwellings. Concentration levels of benzene, formaldehyde, trichloroethylene, styrene, naphthalene, toluene, and tetrachloroethylene were measured in the living room, kitchen and one bedroom of the sample apartments during the same weeks active monitoring took place. Passive tubes and absorbent pads were also installed outdoors to identify the indoor/outdoor trends and sources. Finally, to give context to the IAQ monitoring results, a perfluorocarbon tracer (PFT) gas method was used to infer the average air exchange rates in the monitored zones of the sample apartment.

4.7.2 Main results and findings

The local outdoor PM_{2.5} levels are often higher than the WHO guideline for the annual mean (10 µg/m³). However, indoor concentrations in most spaces are kept below the guideline limit most of the time. Whilst outdoor levels are again often higher than the WHO annual mean (40 µg/m³, 21 ppb), indoor NO₂ levels are generally lower than this limit, except in the kitchens of two apartments. Indoor NO₂ levels are generally well below the WHO hourly guideline limit of 200 µg/m³ (105 ppb). In addition to the effect of outdoor sources, PM_{2.5} and NO₂ levels in apartments could be increased by internal sources especially in the kitchens. Table 4-4 reports the results of passive sampling for two apartments in the sample. These apartments were selected for reporting as the active monitoring results pointed to potential ventilation issues in these apartments. Furthermore, this selection allows a cross-comparison of the dispersion of pollutants in the lowest (ground floor) and highest (9th floor) height in the sample and between different building orientations.

The VOCs with concentration levels higher than the recommended long-term ELVs are highlighted in bold. While high concentrations of Naphthalene could be a specific problem in Apartment 3 related to occupant behaviour (e.g. smoking or use of chemical insecticides/pest control), concentrations of Benzene and Formaldehyde in both apartments are significantly higher than the respective ELVs. Measurements of outdoor concentrations confirm that benzene is driven by outdoor sources, whereas formaldehyde levels are driven by internal sources. It should be noted that the ELVs set out by IEA EBC Annex 68 are generally the most stringent values found in the field. For example, while formaldehyde concentrations in the sample apartments in this project are higher than the ELV chosen by IEA EBC Annex 68, they are generally lower than what is currently demanded by the WELL Building Standard (33.7 µg/m³). There is no ELV defined for formaldehyde in the current version of Approved Document Part F that sets out the requirements for building ventilation in England (HM Government, 2013). The results presented in Table 4-4 therefore point to the gap between IAQ performance observed in these apartments and the best practice available.

¹⁷ Measurement accuracies: CO₂: ± 50 ppm, PM_{2.5}: 0.84 coincidence probability at 10⁶ particles/L; 0.24 coincidence probability at 500 particles/L, NO₂: < ±0.5 ppm

Table 4-13 Passive sampling results for Apartments 3 and 4 (typical weeks in heating season).

VOC concentration ($\mu\text{g}/\text{m}^3$) & Air Change rates per Hour for each zone	APT. 3 (Block A, 9th Floor, North/West orientation)			APT. 4 (Block B, Ground Floor, South/East orientation)			IEA EBC Annex 68 Long Term ELV
	Living room	Kitchen	Sample bedroom	Living room	Kitchen	Sample bedroom	
Benzene	1.3	1.0	1.2	1.5	2.1	1.6	0.2
Formaldehyde	29.25	26.87	29.53	21.23	31.35	27.44	9
Trichloroethylene	<0.5	<0.5	<0.5	<0.5	<0.5	<0.5	2
Styrene	1.5	2.2	3.0	0.8	0.7	1.7	30
Naphthalene	5.4	5.4	5.0	0.9	0.9	1.3	2
Toluene	2.7	2.9	3.1	2.2	2.6	2.4	250
Tetrachloroethylene	0.6	<0.6	<0.6	1.5	1.2	1.8	100
ACH (PFT measurements)	0.50	0.52	0.76	1.02	1.14	0.6	n/a

4.7.3 Conclusions, lessons learned for practice

Air filtration in the installed MVHR units appears to be effective. High-grade particle filters and carbon filters can be used in polluted areas to protect building users against outdoor pollution. The ventilation rates inferred from PFT measurements are also generally consistent with the minimum ventilation requirements set out in the UK Building Regulation, although the MVHR system is only partially responsible for air exchange, and other factors such as natural ventilation (via window opening) are also effective. Enhanced ventilation beyond the regulatory requirements by adjusting the fan speed in the MVHR to its boost or maximum flow rate can help reduce formaldehyde levels, although this can also increase the concentrations of outdoor driven pollutants such as benzene as well as energy use. A trade-off based on an assessment of the health impacts of these pollutants may inform the ventilation strategy. However, a more fundamental solution in future projects is to improve source control of materials and furniture (e.g. Medium Density Fibreboards) used in the building to keep formaldehyde levels low.

4.7.4 Further reading

Burman, E., Shrubsole, C., Stamp, S., Mumovic, D., & Davies, M. (2018). Design and operational strategies for good Indoor Air Quality in low-energy dwellings: performance evaluation of two apartment blocks in East London, UK. the 7th international Building Physics Conference (IPBC 2018). Syracuse, USA.

4.7.5 References

HM Government, 2013. Approved Document Part F, Means of ventilation (2010 edition, incorporating 2010 and 2013 amendments).

International Well Building Institute, 2014. The Well Building Standard, Version 1.0.

4.8 Continuous-commissioning of ventilation units in multi-family dwellings using controller data

<i>Kevin Smith, Christian Anker Hviid, Jakub Kolarik</i>					Addressed topics: ■ Health & Comfort ■ Spatial requirements ■ Cost & Energy consumption ■ Refurbishment ■ Commissioning ■ Quality of installation ■ User satisfaction		
Assessment methods	Assessing ventilation concepts		Novel ventilation solutions		Quality assurance	Assessing in-use performance	

4.8.1 Project objectives, description & methodology

When installing or operating a residential air-handling unit (AHU) with a counter-flow plate heat exchanger, one usually has access to its operational data through a display unit. The same data may be available through a building management system (BMS). The data typically includes several air temperature measurements as well as the opening positions of motorised valves and dampers. With only this data, one can estimate several performance indicators, such as the likely balance of airflows and the appropriateness of the supply air temperature set-point, which controls the bypass of heat recovery. This case study briefly explains the assumptions that allow us to infer useful information from the data during the heating season. It also presents sample data from 17 apartments.

In a renovation project, all 17 apartments received AHUs with counter-flow plate heat exchangers. The AHUs were connected to the internet via an Ethernet cable, and the 5-minute-interval data was made available through the manufacturer’s web portal. The data included measurements of air temperatures before and after the heat exchanger in both airstreams, the relative humidity in the extract air and the position of the bypass damper. The temperatures were labelled ‘outdoor’, ‘extract’, ‘supply’ and ‘exhaust’. If an AHU includes a heating or cooling coil, the data will include another temperature measurement before the coil, often labelled ‘heat exchanger’. The data may also show the damper position for the heat exchanger bypass as well as the valve opening position for the heating coil if one exists. Logged data improves the reliability of the proposed indicators, but one can apply these methods to current data from the display unit of a typical AHU if they are mindful of its limitations. Figure 4-13 shows an example of such data.

The first performance indicator concerns the balance of airflows. It seeks to detect large differences between supply and exhaust, which could indicate excessive air leakages or improper commissioning. If the mass flowrates of the supply air and exhaust air are equal, the temperature increase in the supply air will equal the temperature decrease in the exhaust air, but this is only true under certain conditions. The heat exchanger data must show 0% bypass, which means that neither airflow bypasses the heat exchanger. One may assume that



Figure 4-59 Photo of an AHU display that shows temperature measurements in the supply and exhaust.

the bypass damper is closed if the heating coil is active and the outdoor temperature is above 0°C, but this depends on well-functioning controls. Furthermore, one can reduce the error of the indicator by ensuring dry conditions inside the heat exchanger. For this, one must compare the temperature of the exhausted air to the dew-point temperature of the extracted air (based on measurements of temperature and relative humidity). If the heat exchanger cools the exhaust below its dew-point, there will be condensation inside the heat exchanger, which releases heat and affects the accuracy of the indicator.

In the example from Figure 4-13, the bypass damper is likely closed because the heating coil is active and the outdoor temperature is above 0°C. The detailed BMS data could verify this. In the example, the heat exchanger increases the supply air temperature by 17°C (22.1°C - 5.1°C) and decreases the exhaust air temperature by 13°C (23.2°C - 10.2°C). If the airflows were equal, the temperature increase of the supply air would approximately equal the temperature decrease of the exhaust air. The difference implies that the airflows are unbalanced. However, condensing vapour could affect these temperatures. To discount this possibility, one must verify that the exhaust temperature (e.g. 10.2°C) remains higher than the dew-point temperature of the extract air. In the example, the extract temperature is 23.2°C, so the extract relative humidity must be less than 44% to have a dew-point temperature of less than 10.2°C. With many AHUs, it will be possible to obtain the measured relative humidity of the extract air because it is often used for humidity-based control.

Additionally, the ratio of the temperature changes is inversely proportional to the ratio of mass flow rates, as shown in the equation below, where T is temperature, \dot{m} is mass flow, ρ is density and Q is airflow.

$$\frac{(T_{supply} - T_{outdoor})}{(T_{indoor} - T_{exhaust})} = \frac{\dot{m}_{exhaust}}{\dot{m}_{supply}} = \frac{\rho_{exhaust}}{\rho_{supply}} \cdot \frac{Q_{exhaust}}{Q_{supply}}$$

The dry air densities deviate by less than 4% in the applicable temperature range (i.e. $1.00 < \rho_{exhaust}/\rho_{supply} < 1.04$), and the airflows should be balanced (i.e. $Q_{exhaust} = Q_{supply}$) according to most building regulations. Therefore, one can quickly assess the balance of airflows ($Q_{exhaust}/Q_{supply}$) from the temperature changes of both airflows ($(T_{supply} - T_{outdoor})/(T_{indoor} - T_{exhaust})$).

The second performance indicator concerns the set-point temperature of the supply air. With a set-point that is too high, the AHU over-utilises the heating coil, which reduces controllability of zone heating. In excess, this could cause the occupants to open their windows to reject excess heat, which adds unnecessary heat loss. With a set-point that is too low, the AHU partially bypasses heat recovery, which increases heating consumption unnecessarily. Therefore, a helpful indicator compares the use of the heating coil to the use of the bypass damper. The optimal set-point would minimise both the valve opening position of the heating coil and the opening percentage of the bypass damper. With logged data, one can plot these values as time-series analysis or calculate average values for a known period of the heating season. Some AHUs set the supply temperature according to different outdoor temperatures. In this case, it may be wiser to plot the valve and damper positions against the outdoor temperatures to analyse the appropriateness of each set-point.

4.8.2 Main results and findings

The indicators were visualised in Power BI, which is a business analytics tool that is useful for constructing reports and dashboards. In both cases, the dashboard included a slider to adjust the start and end date. For the first indicator, which estimates the balance of airflows, the authors applied several filters to improve accuracy. The filters only considered data with a closed bypass damper, dry heat recovery, nominal ventilation rates and outdoor temperatures below 12°C. The cooler outdoor temperatures ensured sufficient magnitude of

the temperature changes. Figure 4-14 shows the indicator for 17 apartments from November 1st 2018 to March 1st 2019, where 1.0 represents balanced airflows and less than 1.0 represents insufficient supply airflow or excessive exhaust airflow. From an energy perspective, having slightly less supply airflow than exhaust airflow (i.e. a balance indicator slightly less than 1.0) may be reasonable since mechanically-driven infiltration partially offsets wind-driven infiltration. Furthermore, some error is expected from the commissioning process as well as measurement error. Therefore, the authors regard any value between 0.9 and 1.05 as satisfactory. Only four of the apartments had indicators in this range. Twelve of the apartments had indicators below 0.85, and four of these were 0.7 or less, which represented an airflow imbalance of at least 30%. These imbalances were likely due to air leakage in the ducts or AHUs. The manufacturer of the AHUs stated that their seals may have been damaged during delivery, which could explain the wide variance between apartments that were commissioned with similar processes.

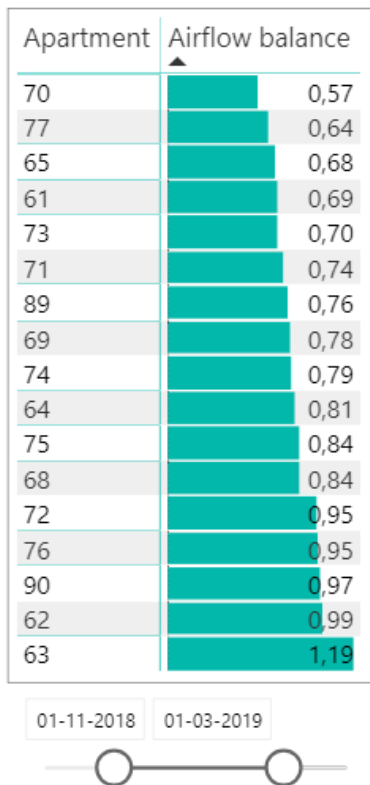

Figure 4-60 Airflow balance in 17 apartments based on the ratio of temperature changes in the AHUs. 1.0 indicates perfect balance.

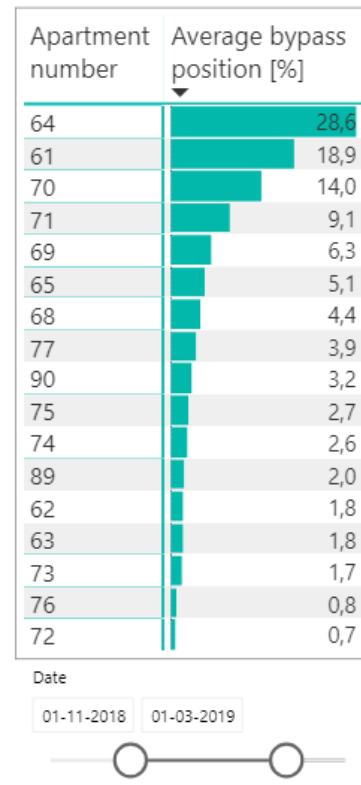

Figure 4-61 Average bypass position from November to February in 17 AHUs.

The authors used the second indicator to assess the supply temperature set-points during the same period. The AHUs did not include heating coils, so the authors only analysed the bypass of heat recovery. Figure 4-15 shows the average positions of the bypass dampers for the same 17 apartments after filtering out conditions with sub-zero outdoor temperatures. 12 of the 17 apartments had an average bypass position of 5.1% or less, which the authors regard as reasonable but also improvable. The four apartments with average positions greater than 9% should be further investigated. It is worth noting that all apartments showed higher levels of bypass during the previous heating season. After observing this, the authors instructed the property manager to take corrective action and increase the supply temperature set-points. This was an obvious measure as the

excessive bypass contributed to unnecessary heat loss. In cases of extremely excessive bypass, it may be wise to consider the extract temperature set-point (also known as the cooling set-point in AHUs without a cooling coil). Some AHUs bypass heat recovery for extract temperatures above a set-point to avoid overheating. If the occupant's local heating set-point exceeds the extract temperature set-point, the AHU will bypass heat recovery constantly, which is the worst possible outcome. To correct this, one can increase the extract temperature (or cooling) set-point during the heating season to reduce unnecessary bypass.

4.8.3 Conclusions, lessons learned for practice

One can utilise the data from a typical air-handling unit with heat recovery to indicate the approximate balance of airflows during the heating season. As demonstrated by the case study, this can indicate air leakages or improper commissioning continuously. One can employ the same dataset to analyse the appropriateness of temperature set-points in the air-handling unit. As shown by the case study, this can indicate excessive bypass of heat recovery or excessive use of the heating coil. These indicators showed very clearly which air-handling units required further inspection due to poor performance. The indicators are quite simple to construct, and they help to continuously monitor and improve ventilation performance during the heating season.

4.8.4 Further reading

Brinch, Ch. H. (2020). Performance analytics and ongoing commissioning of residential ventilation and heating systems. MSc Thesis. Technical University of Denmark, Department of Civil Engineering, Kgs. Lyngby, Denmark

Smith, K. et al. (2021). Continuous-commissioning of mechanical ventilation with heat recovery using controller data. To be submitted in late-2020.

4.8.5 References

Smith, K. et al. (2021). Continuous-commissioning of mechanical ventilation with heat recovery using controller data. To be submitted in late-2020.



5 Conclusions and outlook

In light of the fact that modern society needs to strengthen its efforts to cope with the challenge of climate change, future buildings must be extremely energy efficient. The necessary strong reduction of heat losses through the building envelope will require that it is highly airtight, and the strong reduction of ventilation losses will necessitate, at least in countries with moderate and cold climates, the utilization of energy efficient mechanical ventilation systems.

The results of a review of national requirements and practitioner guidelines in seven European countries are presented in the second chapter of this report. They are in line with earlier reviews by Dimitroulopoulou (2012) and Chenari et al. (2016). Dimitroulopoulou (2012) points out that ventilation is perceived as an important component of a healthy dwelling and that ventilation requirements receive significant attention in European building regulations. Additionally, the results of the present review show that mechanical ventilation systems seem to be already dominant in newly built low-energy residential buildings. At the same time, the legislation in these countries still allows for natural ventilation. The condition is that both requirements for ventilation rates and energy performance requirements are fulfilled. This can be a challenge, mainly in countries with moderate and cold climatic conditions. Therefore, in such countries, mechanical ventilation systems with heat recovery are well accepted. Moreover, financial incentives often exist in these countries to support such systems. Chenari et al. (2016) refer in their review to hybrid ventilation as an energy efficient alternative to natural ventilation. This approach represents countries with warmer climates, where different types of hybrid systems seem to be preferred over heat recovery ventilation.

A definition of nominal ventilation rate, to ensure continuous removal of indoor pollutants has been established in all the investigated countries. In some of the countries, it is permitted to reduce the nominal ventilation rate when a dwelling is unoccupied or if demand control is applied. Demand control is generally not required, and it seems to be rarely used in practice due to the higher costs and complexity. However, there are countries (France and Belgium), where demand-controlled exhaust-only ventilation dominates the market due to its reported simplicity and cost-effectiveness in comparison to balanced systems with heat recovery.

A stakeholder survey including forty-four interviews with practitioners from seven European countries provided an insight into current practices concerning design and operation of residential ventilation. More importantly, it also highlighted which barriers and challenges practitioners meet. The initial costs of mechanical ventilation systems was one of the most frequently mentioned barriers, followed by increased spatial requirements for ventilation units and ducting, which are not only relevant for renovation projects necessarily. Designers need to “fight” for every cubic meter of space in new building designs as well. Other common issues were raised such as a lack of qualified installers, inadequate commissioning leading to non-compliance with regulatory requirements and problematic maintenance. Regarding the operation of mechanical ventilation in residences, the crucial problems identified were noise and perceived cost of operation. To overcome the aforementioned barriers, several potential improvements were identified within this stakeholder survey. Legislation, standards and building codes should be more flexible and have a more holistic approach that also allows for trade-offs. A coordinated approach to energy efficiency and indoor air quality (IAQ) was also considered vital, followed by legislative mechanisms to ensure good implementation and operation of mechanical ventilation systems. However, improved and strengthened legislation is not

the only thing needed to solve the current challenges. A number of technical pushes and financial incentives were suggested. Training and accreditation of installers of ventilation systems are necessary to improve the quality of installation and commissioning. This would eliminate problems such as excessive air leakage, unbalanced systems, draughts, noise and poor energy efficiency. Seppänen et al. (2012) discovered that balancing of ventilation systems was required in the national building codes of 14 out of 16 surveyed countries. However, there was a control mechanism to ensure that the balancing is actually done in only six of those countries. This report also states noise as a common problem, which receives too little attention. The results in the present survey indicate that this is still an important aspect that needs proper consideration during design.

According to the stakeholders interviewed in the survey, governmental subsidies, grants targeted for specific types of systems as well as insurance incentives related to system maintenance could also form effective tools to overcome the financial barrier. Nevertheless, the survey indicates that they should go hand in hand with outreach programmes increasing general awareness. The financial stimulus may not be sufficient if building owners are not informed about the importance of ventilation for IAQ.

The third and fourth chapter of this report contain altogether twenty-two contributions by researchers from several European countries, the USA and China describing research as well as practical projects focused on high air quality and energy efficient ventilation in modern residences. Ten contributions have a main focus on comfort and health. Most of those contributions represent research efforts focused on understanding mechanisms of emissions and transport of pollutants. Despite the large amount of research focused on that topic, only a few research results have been directly transferred into practice. Available emission models can provide good predictions. However, they are often only valid for simplified boundary conditions, and the accurate estimation of pollutant emissions under real-life conditions still requires further research and development. The presented case studies represent attempts to characterize emissions of particular pollutants dependent on temperature and humidity levels, which are some of the most influencing factors in reality. The prediction of pollutant emission and pollution transport is however only “one side of the coin”. The other is the assessment and evaluation of existing conditions. What should be measured and how to be able to assess whether a specific apartment building, house or a dormitory provides “healthy” air to its occupants? Most of the European countries have building codes prescribing mandatory ventilation rates, some even include limit emission values for the most dangerous pollutants. Mandatory ventilation rates can be applied during the design, but verification of appropriate ventilation during operation is not common at all. Case studies representing the Annex 68 IAQ metric approach developed within the project’s Subtask 1 (Salis et al. 2017) represent a suggestion of how the IAQ assessment can be done in the future. The so-called IAQ dashboard integrates both short term and long-term health effects of selected target pollutants and puts them in context with energy consumption. The aforementioned approach anticipates that measurements of target pollutants will be conducted in the dwelling/building. Such measurements are not a common practice at present, but as IAQ receives increased attention, it is probably reasonable to expect that such measurements become part of the post-occupancy evaluation in the near future.

Four case studies represent innovative ventilation solutions. It is interesting to mention that two of them represent room-based ventilation systems. Room-based ventilation seems to be able to address some of the important challenges mentioned by European practitioners. Especially space requirements for ducting in the case of renovations and issues with demand control, and to some extent also price related issues. However, many currently available solutions may bring more problems than solutions. These include mainly inefficient heat recovery, the sensitivity of the units to outside pressure conditions and noise. A study by

Mikola et al. (2019) can be used as an example of research addressing these challenges. The case studies presented in Chapters 3.3 and 3.15 of this report also represent projects aiming to solve the aforementioned problems, so the advantages of room-based ventilation could be fully exploited. Also, the remaining innovative solutions aim to address the challenges mentioned by the practitioners with a main focus on spatial requirements.

Case studies addressing commissioning and the quality of installations describe the French approach to the problem, which implements the Promevent protocol (see Chapter 4.3). On a European level, the QUALICHeCK project completed in 2017 and the continuing knowledge exchange platform (QUALICHeCK 2019) are important to mention, because they have focused on reliability of the Energy Performance Certificate declarations and, more importantly in the context of IAQ, the quality of the installation works particularly concerning ventilation and airtightness. The project showed that even appropriate commissioning is not enough to ensure optimum performance during the whole lifetime of the ventilation system. In the future, as an appropriate follow-up, so-called continuous commissioning will be needed to ensure that the performance does not degrade during a system's lifetime. This is a special challenge for residential systems. Tight project budgets do not allow the installation of building management systems, so the building operators do not have the possibility to observe the system's performance. Moreover, in many cases, there is no "building operator" and tenants are self-responsible for a change of filters and the service of their ventilation system. Only one case study that focused directly on continuous commissioning has been included in this report, but from discussions at scientific conferences, as well as from interviews conducted with practitioners it is clear that this topic will receive much more attention in near future.

Seppänen et al. (2012) have previously concluded that the importance of detailed design, correct installation and appropriate maintenance of residential ventilation is still often underestimated. Additionally, it is somewhat believed that users/occupants do not consider ventilation to be something worthy of special attention, which limits their interest in system operation and maintenance. This may be true when there are no problems with ventilation, but as soon as the malfunctioning ventilation influences occupants' comfort, they seem to be very keen to take action. Unfortunately, many times this action leads to blocking of ventilation openings or even switching off the system, which is likely due to lack of awareness and an absence of relevant technical information. A Danish case study presented in this report represents a unique dataset summarizing occupant experiences with low-energy residences. The case study highlighted important observations and recommendations regarding ventilation, despite its much broader original focus. The highlights are likely the need for robust and well-tested systems as well as thorough introductions and instructions for occupants.

Design of residential ventilation using advanced simulation tools still seems to be in its infancy. There are many tools capable of IAQ-oriented design, but there are also many factors that play against their application in practice, particularly for residential building design. The most important factors are likely the size and corresponding budget of a project, time constraints and a lack of designers that can use the simulation tools. Subtask 3 of Annex 68 showed that the currently available simulation tools, and especially their integrated use through co-simulation, enable performance-based design, including aspects of IAQ in addition to energy efficiency and thermal comfort. At the same time, one needs to be aware of the fact that limitations still exist, especially for modelling of pollutant emissions and their dependency on other indoor environmental parameters like temperature or humidity. Several included case studies demonstrate the use of simulation tools for the design of residential ventilation, but they present research studies rather

than real design projects. The most important challenges in the future seem to be the transfer of knowledge into practice and the increased awareness of advantages related to simulation-based design.

The overall objective of IEA EBC Annex 68 was to provide a scientific basis for optimal and practically-applicable design and control strategies for better IAQ in residential buildings. The specific scientific results obtained in the particular subtasks can be found in their final reports, scientific papers and other publications collected at the project webpage (www.iea-ebc-annex68.org). This report aimed to bring scientific results, as interesting applications and novel solutions, closer to practitioners. While there is no doubt that high IAQ and high energy efficiency can go hand in hand, open questions remain on how to foster a widespread implementation in new and refurbished residential buildings. This report highlights the challenges to achieve high IAQ and, at the same time, presents exemplary solutions to overcome them.

5.1 References

- Dimitroulopoulou, C. 2012 Ventilation in European dwellings: A review *Build. Environ.* 47 109–25
- Chenari, B., Dias Carrilho, J. and Gameiro Da Silva, M. 2016 Towards sustainable, energy-efficient and healthy ventilation strategies in buildings: A review *Renew. Sustain. Energy Rev.*
- Cony Renaud Salis, L., Abadie, M., Wargoeki, P. and Rode, C. 2017 Towards the definition of indicators for assessment of indoor air quality and energy performance in low-energy residential buildings *Energy Build.*, Vol. 152, 492-502
- Mikola, A., Simson, R. and Kurnitski, J. 2019 The impact of air pressure conditions on the performance of single room ventilation units in multi-story buildings *Energies*, 12, 2633
- QUALICHeCK 2019 QUALICHeCK Platform - Towards better quality and compliance, <http://qualicheck-platform.eu> (visited september 2019)
- Seppanen, O., Brelih, N., Goeders, G., Litiu, A. 2012 Existing buildings, building codes, ventilation standards and ventilaiton in Europe, *HealthVent – Health-Based ventilaiton guidelines for Europe*, Brussels, Belgium

6 Acknowledgments

The authors would like to thank all Annex 68 participants for sharing their time and experience, providing data and reviewing the present document.

Marc Abadie would like to acknowledge the French Environment and Energy Management Agency (ADEME) for the financial support (convention n°1504C0157).

Targo Kalamees, Ülar Palmiste and Anti Hamburg would like to acknowledge the Estonian Centre of Excellence in Zero Energy and Resource Efficient Smart Buildings and Districts, ZEBE, grant TK146 funded by the European Regional Development Fund for supporting the presented project. In addition they would like to acknowledge personal research funding grant PRG483, Moisture safety of interior insulation, constructional moisture and thermally efficient building envelope as well as EU funded Horizon 2020 project “Development and advanced prefabrication of innovative, multifunctional building envelope elements for modular retrofitting and smart connections (MORE-CONNECT)”.

Jakub Kolarik, Kevin M. Smith and Nadja L. Lyng would like to acknowledge The Danish Energy Technological Development and Demonstration Program (EUDP) for support of their research. Nadja L. Lyng would like to additionally acknowledge Danish Landowners Investment Fund.

Gabriel Rojas would like to acknowledge the Austrian Research Promotion Agency (FFG) for financial support within the framework of the IEA Research Cooperation programme, implemented on behalf the Austrian Ministry for Transport, Innovation and Technology.

7 Contributors

Table 7-1 Summary of all persons that contributed to this report and their affiliations.

Name	Affiliation
Adeline Bailly Mélois	Cerema, BPE Research team 46 rue St Théobald, F-38080, L'Isle d'Abeau, France
Andreas Nikolai	Technical University of Dresden, Institute of Building Climatology, Dresden, Germany
Anti Hamburg	Department of Civil Engineering and Architecture, Tallinn University of Technology, Estonia
Ariane Lesage	Cerema, BPE research team, 46 rue St Théobald, F-38080, L'Isle d'Abeau, France
Arnold Janssens	Ghent University, Research group of building physics, Belgium
Bob Lowe	UCL Energy Institute, The Bartlett School of Environment Energy and Resources, University College London
Carsten Rode	Technical University of Denmark, Department of Civil Engineering, Kgs. Lyngby, Denmark
Christian Anker Hviid	Technical University of Denmark, Department of Civil Engineering, Kgs. Lyngby, Denmark
Christoph Speer	University of Innsbruck, Institute for Structural Engineering and Material Sciences, Unit for Energy Efficient Buildings, Innsbruck, Austria
Claire-Sophie Coeudevez	MEDIECO Conseil & Formation , 355 Allée Jacques Monod, 69800 Saint Priest, France
Clive Shrubsole	UCL Institute for Environmental Design and Engineering, the Bartlett School of Environment Energy and Resources, University College London
Daria Zukowska	Technical University of Denmark, Department of Civil Engineering, Kgs. Lyngby, Denmark
Dejan Mumovic	UCL Institute for Environmental Design and Engineering, The Bartlett School of Environment Energy and Resources, University College London
Elsa Jardinier	AERECO SA 62 rue de Lamirault – Collégien 77615 Marne la Vallée Cedex, France
Esfand Burman	UCL Institute for Environmental Design and Engineering, the Bartlett School of Environment Energy and Resources, University College London
Evelyne Gonze	Univ. Grenoble-Alpes, Univ. Savoie Mont Blanc, CNRS, LOCIE, 73 000 Chambéry, France
François Parsy	AERECO SA 62 rue de Lamirault – Collégien 77615 Marne la Vallée Cedex, France

IEA EBC Annex 68 – SUBTASK 4: Strategies for design and control of buildings

François-Rémi Carrié	International Cooperation for energy Efficiency (ICEE), 93 rue Molière , 69003 Lyon, France
Gabriel Rojas	Salzburg University of Applied Sciences, Smart Building Unit, Austria & University of Innsbruck, Institute for Structural Engineering and Material Sciences, Unit for Energy Efficient Buildings, Innsbruck, Austria
Gaëlle Guyot	Cerema, BPE research team, 46 rue St Théobald, F-38080, L'Isle d'Abeau, France/ Univ. Grenoble-Alpes, Univ. Savoie Mont Blanc, CNRS, LOCIE, 73 000 Chambéry, France
Guangyu Cao	Norwegian University of Science and Technology, Norway
Hector Altamirano-Medina	UCL Institute for Environmental Design and Engineering, The Bartlett School of Environment Energy and Resources, University College London
Henrik N. Knudsen	Aalborg University, Department of the Built Environment, Copenhagen, Denmark
Hugo Geoffroy	Univ. Grenoble-Alpes, Univ. Savoie Mont Blanc, CNRS, LOCIE, 73 000 Chambéry, France
Jakub Kolarik	Technical University of Denmark, Department of Civil Engineering, Kgs. Lyngby, Denmark
Jelle Laverge	Ghent University, Research group of building physics, Belgium
Jensen Zhang	Syracuse University, Mechanical & Aerospace Engineering, Syracuse, USA
Jez Wingfield	UCL Energy Institute, The Bartlett School of Environment Energy and Resources, University College London
Johan Bojsen	Technical University of Denmark, Department of Civil Engineering, Kgs. Lyngby, Denmark
John Grunewald	Technical University of Dresden, Institute of Building Climatology, Dresden, Germany
Kevin M. Smith	Technical University of Denmark, Department of Civil Engineering, Kgs. Lyngby, Denmark
Klaas De Jonge	Ghent University, Research group of building physics, Belgium
Lai Fong Chiu	UCL Energy Institute, The Bartlett School of Environment Energy and Resources, University College London
Laure Mouradian	CETIAT, 25 av des Arts – BP52042, 69603 Villeurbanne Cedex, France
Léna Migne	Univ. Grenoble-Alpes, Univ. Savoie Mont Blanc, CNRS, LOCIE, 73 000 Chambéry, France
Mallory Bobee	Univ. Grenoble-Alpes, Univ. Savoie Mont Blanc, CNRS, LOCIE, 73 000 Chambéry, France
Marc Abadie	LaSIE Research Laboratory (UMR CNRS 7356), University of La Rochelle, France

IEA EBC Annex 68 – SUBTASK 4: Strategies for design and control of buildings

María del Carmen Bocanegra-Yáñez	University of Strathclyde, Department of Mechanical and Aerospace Engineering, Glasgow, United Kingdom
Mathias J. Larsen	Technical University of Denmark, Department of Civil Engineering, Kgs. Lyngby, Denmark
Michael Davies	UCL Institute for Environmental Design and Engineering, The Bartlett School of Environment Energy and Resources, University College London
Michel Ondarts	Univ. Grenoble-Alpes, Univ. Savoie Mont Blanc, CNRS, LOCIE, 73 000 Chambéry, France
Monika Woloszyn	Univ. Grenoble-Alpes, Univ. Savoie Mont Blanc, CNRS, LOCIE, 73 000 Chambéry, France
Nadja L. Lyng	Danish Technological Institute, Buildings & Environment, Taastrup, Denmark
Pawel Wargocki	Technical University of Denmark, Department of Civil Engineering, Kgs. Lyngby, Denmark
Rainer Pfluger	University of Innsbruck, Institute for Structural Engineering and Material Sciences, Unit for Energy Efficient Buildings, Innsbruck, Austria
Robert Lowe	UCL Institute for Environmental Design and Engineering, the Bartlett School of Environment Energy and Resources, University College London
Romuald Jobert	CEREMA, Research team BPE, L'Isle d'Abeau, France
Rossana Bossi	Aarhus University, Department of Environmental Science - Atmospheric Measurements, Roskilde, Denmark
Samuel Stamp	UCL Institute for Environmental Design and Engineering, The Bartlett School of Environment Energy and Resources, University College London
Sandrine Charrier	DGAC/SNIA, 82 rue des Pyrénées, 75970 Paris Cedex 20, France
Stephan Hirth	Technical University of Dresden, Institute of Building Climatology, Dresden, Germany
Stéphane Berthin	AERECO SA 62 rue de Lamirault – Collégien 77615 Marne la Vallée Cedex, France
Targo Kalamees	Department of Civil Engineering and Architecture, Tallinn University of Technology, Estonia
Thomas Witterseh	Danish Technological Institute, Buildings & Environment, Taastrup, Denmark
Ülar Palmiste	Department of Civil Engineering and Architecture, Tallinn University of Technology, Estonia
Weihui Liang	Nanjing University, School of Architecture and Urban Planning, Nanjing, China
Zhenlei Liu	Syracuse University, Mechanical & Aerospace Engineering, Syracuse, USA