



Cost-effectiveness Analysis of the Dental RECUR Pragmatic Randomized Controlled Trial: Evaluating a Goal-oriented Talking Intervention to Prevent Reoccurrence of Dental Caries in Children

Ezeofor Victory¹ · Edwards T. Rhiannon¹ · Burnside Girvan² · Adair Pauline³ · Pine M. Cynthia^{3,4,5}

Accepted: 31 January 2022 / Published online: 17 March 2022
© The Author(s) 2022

Abstract

Background The formation of dental caries is the most common chronic disease in children, and is preventable. The oral health-related quality of life has an immense impact on an individual's daily functioning, well-being or overall quality of life.

Objectives This study aims to investigate the cost effectiveness of the Dental RECUR Brief Negotiated Interview for Oral Health (DR-BNI). This 30-minute therapeutic “talk” by a dental nurse with a parent/guardian was compared with a placebo-controlled intervention in preventing reoccurrence of dental caries in children who have had a primary tooth extracted.

Methods An economic model was developed to simulate the clinical progression of dental caries among children who have previously had a primary tooth extracted. The analysis was conducted using the UK NHS perspective. The main outcome was the incremental cost-effectiveness ratio (ICER) based on the quality-adjusted life years (QALYs). Estimates of costs and probabilities were obtained from the DR-BNI multicentre randomised controlled trial (RCT), while QALY values were obtained from published literature. Univariate and probabilistic sensitivity analyses were conducted to assess the uncertainty of the result and robustness of the model. Affordability and risk-aversion of the intervention were investigated to help decision makers make the best possible choices.

Results With an intervention cost of £6.47, the results from the RCT showed the healthcare cost for the DR-BNI intervention was £115.90 per child while the control had a healthcare cost of £119.46 per child. The QALYs gained for the prevention of reoccurrence of dental caries was higher in the DR-BNI intervention arm by 0.023 QALYs; thus, the DR-BNI was the dominant intervention. At willingness to pay threshold of £3500/QALY gained, a maximum probability of being cost effectiveness is achieved at 86%. The secondary analysis showed a cost-savings of £20.94 per participant for the prevention of at least one filling or extraction. Affordability results showed that the DR-BNI programme is affordable to the UK health system at a moderately low budget.

Conclusions This study shows the proactive talking intervention to have a very moderate cost and to be effective in providing better health related quality-of-life gains. The intervention is cost savings with a dominant ICER even with a 200% increase in the cost of intervention. The NHS will be providing better oral health for children at a better net monetary benefit-to-risk ratio by adopting the DR-BNI intervention in preventing the reoccurrence of dental fillings and extractions for each participant.

Trial Registration: This trial was registered prospectively on 27th September 2013 with the trial registration number ISRCTN 24958829.

1 Background

Tooth decay, also known as dental caries, manifests as damage to teeth due to acids produced by the bacteria in dental plaque, which turns dietary sugars to acid. It is one of the most prevalent diseases globally [1] affecting 60–90% of children and the majority of adults [2]. Untreated tooth decay (dental caries) in children is the tenth most prevalent disease worldwide, affecting 621 million children globally [3]. In a study conducted by Abanto et al. [4], the severity of dental caries showed a negative impact on the total score and

✉ Ezeofor Victory
v.ezeofor@bangor.ac.uk

¹ Centre for Health Economics and Medicines Evaluations, Bangor University, Bangor, UK

² Department of Health Data Science, University of Liverpool, Liverpool, UK

³ School of Psychology, Queen's University, Belfast, UK

⁴ Salford Royal NHS Foundation Trust, Salford, England

⁵ Kippax Design Ltd, Colchester, Essex, UK

Key Points for Decision Makers

The DR-BNI programme provides a dominant intervention in preventing dental reoccurrence in children; thus, saving NHS resources.

The DR-BNI provides more benefits to risk compared with the standard care treatment.

The moderately low intervention cost of the DR-BNI gives a higher percentage of affordability with respect to budget constraints.

subscales on family activity, parental emotions and financial burden.

In the UK alone, nearly one-third of children aged 5 years, and almost a half of 8-year-olds, have experience of caries [5]. Dental caries impacts children's lives in many ways. In a UK child dental health survey conducted in relation to the most common symptoms, 18% of 12-year-olds and 15% of 15-year-olds reported pain and previous experience of toothache [6]. Children from more deprived and low-income quintiles have a higher prevalence and severity of dental caries [7]. A study by Sarri et al. [8] on dental neglect in deprived areas in the UK discovered that four in ten adolescents experienced dental prevention neglect and five in ten experienced dental treatment neglect. In some areas in the UK, there has been a reported decrease in prevalence of active dental caries and caries experience between 2003 and 2013 even in deprived areas [9]; however, this reported decrease occurred following a change from negative to positive parental consent for dental epidemiological surveys in England and Wales.

Although it is hoped that the introduction of fiscal changes in the taxation of sugar levels in soft drinks may reduce the consumption of some sugars in children and young people [10], much remains to be done, as prevalence is high for a disease that is preventable. Public Health England (2017) has published *Delivering Better Oral Health*, evidence-based guidance for primary dental care identifying that prevention of dental caries depends on control of dietary sugar and twice-daily toothbrushing with fluoridated toothpastes [11]. The guidance includes effective clinical preventive procedures of fluoride varnish applications and fissure sealants. In England, guidance has also been published for dental commissioners to provide a framework for the Starting Well Core programme, which aims to improve dental attendance for pre-school children and the delivery of preventive care [12]. Despite National Institute for Health and

Care Excellence (NICE) guidance recommending that all children should attend the dentist at least once a year [13], reports from UK NHS digital records reveal that only 58.2% of children were seen by a dentist in 2017, with a modest increase to 58.6% in 2018 [14]. There were 11.4 million courses of treatment delivered to children during 2017–2018 [14]. During 2015–2016, around £73 million in child General Dental Service (GDS) fees was authorised in Scotland, which was the highest ever recorded [15]. Treatment of caries is expensive and lifelong; since past caries experience is the strongest predictor of future caries, it is essential that more effective preventive methods be found for both primary and secondary prevention. Therefore, it has become paramount that a comparative analysis of the treatments in relation to cost and resource allocation is investigated.

There is an increasing policy and academic interest in asset-based approaches (a combination of human, social and physical capital) as a means to develop and deliver interventions for improving health and reducing health inequalities [16]. Economic evaluation provides justifiable methods of comparative analysis between healthcare intervention in competition for resources allocation [17, 18, 39]. An economic evaluation applying decision analytic modelling techniques helps to quantify and synthesise data on cost, benefit, disease progression and utility values [38]. The American Academy of Paediatrics defines child health as 'the social, physical and emotional functioning of the child and when indicated, his or her family...therefore, measurement of health-related quality of life (QoL) must be from the perspective of the child and the family' [4]. Oral Health-Related Quality of Life (OHRQoL) is a multidimensional construct that corresponds to the impact of oral health or diseases on an individual's daily functioning, well-being or overall QoL [19, 20].

This study focused on a preventive intervention rather than a treatment intervention. There have been no economic evaluations investigating dental reoccurrence in children using a goal-oriented "talking" therapy. The aim of this study was to compare the cost effectiveness of the Dental RECUR Brief Negotiated Interview for Oral Health (DR-BNI) and a placebo control intervention in preventing dental reoccurrence in children who have previously had a primary tooth extracted. The placebo-controlled intervention comprised a parent-nurse conversation about the child's future tooth eruption plus standard care [22]. The placebo-control contained no discussion on caries prevention. Both interventions (conversations between parent and dental nurse) were delivered in the secondary care centres that children were attending for extraction of primary teeth. Following extractions, children in both groups were advised to attend their child's dental practice as usual.

2 Methods

A decision-tree model was developed to simulate the transition in reoccurrence of dental caries in children who have had a primary tooth extracted. The evaluated cost effectiveness of the DR-BNI in comparison to the control intervention was conducted using Microsoft Excel for Office 365. The structure and parameters of the tree were determined by the data obtained from the Dental RECUR trial [22] and published literature. The base branches from the decision node in the tree represented an intervention delivered to the parent of the child with dental caries while other branches accounted for the health state pathways. A schematic diagram of the decision tree is presented in Fig. 1, which exemplifies the life-course approach that could be taken to analyse different interventions to prevent dental caries reoccurrence.

The analysis was based on a two-arm multicentre randomized controlled trial (RCT) with blinded outcome assessment and a 2-year post-intervention follow-up [22]. The DR-BNI intervention was a 30-min conversation between a dental nurse and a parent, or caregiver, of child patients involved in the study. This therapeutic conversation focused on keeping the newly erupting dentition healthy going forward by setting specific preventive goals which were identified and chosen by the parent in a structured conversation with the trained dental nurse. These goals were based on behaviour change techniques using a non-judgemental, empathic approach and based on best evidence for preventing dental caries [11]. This “talking” intervention had a 6-segment structure and was developed by a clinical and health psychologist [22]. A review appointment was made with the child’s general dental practitioner, who was advised to treat the child as being at high caries risk. The placebo control contained information that was structured around concepts of growing up, shedding and growing new teeth, descriptions and illustrations; there was no discussion on caries prevention, but advice was given to visit a general dental practitioner (GDP) as usual. National guidelines for GDPs require that preventive advice is given for children at risk to dental caries. A full description of the trial can be obtained from the main paper [22].

The interventions were delivered by dental nurses, employed on average at NHS Band 4 [23]. The population included in the study comprised children aged 5–7 years of age who were scheduled to have at least one tooth extraction under general anaesthesia, inhalation sedation or local anaesthesia due to dental caries in 12 centres across the UK [22]. In total, 80 % ($n = 193$) of participants received a final dental assessment two years after extraction of their primary teeth. During this period, the majority of children had re-attended the practice of the referring general dental

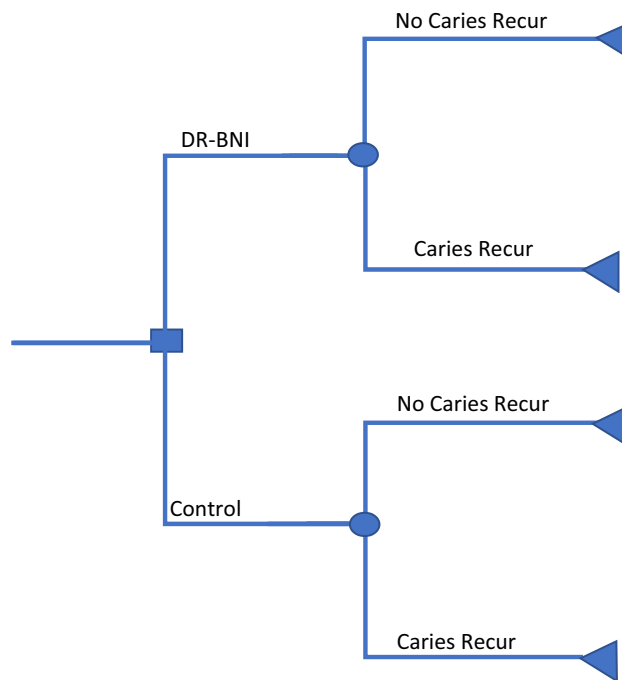

Fig. 1 Schematic diagram of the decision tree model of the dental caries re-occurrence intervention in children. DR-BNI Dental RECUR Brief Negotiated Interview for Oral Health, Recur Reoccurrence

practitioner (61 %, $n = 119$ in DR-BNI group; 64 %, $n = 122$ in the placebo control group) who provided treatment data.

The model constructed was both a deterministic and probabilistic decision model. For the probabilistic analysis, a distribution was used to represent the possibility of events occurring.

The primary outcome measure for this analysis study was presented as the incremental cost per QALY gained (also known as the incremental cost-effectiveness ratio [ICER]).

In analysing the trial data, any visit involving fissure sealants, fillings or extractions was regarded as a treatment visit. If any two visits were less than 60 days apart, both visits were considered part of the same course of treatment. For two visits that were more than 90 days apart, they were considered different courses of treatment, while for visits between 60 and 90 days apart the following criteria were used to identify whether these should be treated as separate courses of treatment:

If the second visit included a history examination, it was considered a different course of treatment

If the second visit was not a treatment visit, it was considered a different course of treatment

If the second visit was a treatment visit and did not include a history and examination, it was considered as part of the same course of treatment.

The analysis was examined using the UK National Health Service (NHS) perspective. The cost of treatment is classified into Bands 1–3 of Units of Dental Activity (UDAs) in England; while in Scotland and Northern Ireland, the dentists' payment system is a mix of capitation payments and Item of Service charges (see Table 1) [24–26]. Band 1 treatment is quantified as 1 UDA and valued between £20–35.

For Band 2 it has a value of 3 UDAs and Band 3 has a value of 12 UDAs [27]. This analysis applied an average UDA value of £28. All costs were values used in 2020 or inflated to the year 2020 as reported in the UK unit cost of health and social care [55]. Two main classes of cost were considered: the treatment cost and the cost of delivering the intervention. The treatment costs are directly associated with the dental service offered to the children by the dentist/GP during the trial period while the delivery cost comprised the cost incurred in setting up and delivering the intervention (see Table 1).

Table 1 Description of fees for dental treatment in Primary Dental Care in the UK and description of costs of training for interventions in the Dental RECUR trial

Parameters	Description of fees in £ (sterling) in UK			Dental payment system
	England	Scotland	Northern Ireland	
<i>Treatment cost</i>				
Band 1	22.7	Fee-for-item	Fee-for-item	National Services Scotland 2016 [15]
Band 2	62.1			
Band 3	269.3			
Examination	Band 1	9.40–29.15	8.79–27.64	
One x-ray	Band 1	4.55–9.65	4.30	
Two x-rays	Band 1	6.40–19.00	6.13	NHS 2017 [24]
Fissure sealant	Band 1	9.15		
Amalgam filling	Band 2	9.95–25.50	9.39–24.15	
White filling	Band 2	18.75	18.40–46.74	NI direct government services [26]
Root filling molar	Band 2	112.50	105.90	
Root filling premolar	Band 2	63.45–73.25	59.29–68.74	
Root filling incisor or canine	Band 2	53.75	50.33	
Referral	Band 1	16.25		NHS 2018 [40]
Simple extraction	Band 2	9.15–55.25	8.68–52.36	
Surgical extraction	Band 2	24.95–57.25	24.15–59.83	
Oral hygiene	Band 1	4.48		
Dietary advice	Band 1	4.48	4.48	
Antibiotic	Band 2	14.60	14.60	
<i>General cost per hour</i>				
Cost of doctor's visit (with qualification)	£35			Curtis and Burns 2019 [41]
Cost of clinical psychologist	£29.48			Royal College of Nursing 2020 [23]
Dental nurse	£12.93			Royal College of Nursing 2020 [23]
<i>Training cost</i>				
Days of training		DR-BNI 12 days	Control 6 days	Pine et al, 2020 [22]
Mean travel cost of clinical psychologist	100			
Total number of nurses trained	30			
Duration of training		6 h	5 h	
Individual practice duration	6 h			
Material/equipment	£50			
Cost of miscellaneous per nurse	£10			
Average cost of intervention delivery per dental nurse		£301.65	£222.83	

Data from the trial were applied to extrapolate evidence for this analysis, Table 5 shows the summary of the number of treatments and the number of participants involved in the treatment

Likewise, a summary of the total cost of each treatment type is given in Table 2. These cost values were classed into treatment course and applied to conduct further analysis.

The DR-BNI RCT did not collect Health-related Quality of Life (HRQoL) values because the two commonly used measures of HRQoL were designed for use with children aged >7 years and were not appropriate for the 5- to 7-year participants in the current study. Specifically, the European QoL 5-Dimension youth (EQ-5D-Y) was designed for children aged 8–15 years and the Child Health Utility 9 Dimension (CHU-9D) was designed for children aged 7–11 years. No direct QALY values were available, but estimates were obtained from the literature [28–30] and apply similar methodology as obtained from Claxton et al (2014), where a missing tooth or dental caries impacts the QoL [30]. Estimates of utility values of acute otitis media were adopted. For no caries reoccurrence, utility value of 0.96 was used while the value of 0.88 was adopted for caries reoccurrence. Though proxy QALYs from the literature were used we would expect QALYs to be higher for the no caries reoccurrence group. The utility values adopted in this study fall within the acceptable range as can be seen in Nguyen et al.

Table 2 Total cost for each treatment in the trial data

Treatment	DR-BNI	Control
History examination	3645.72	3259.83
Dietary advice	4149.32	3890.66
Oral hygiene instruction	4349.14	4004.16
Fluoride varnish	3613.78	3336.90
Fissure salant	585.80	681.00
Filling	1358.02	2848.42
Extracted	310.50	310.50
X-ray	113.50	68.10
Antibiotics	62.10	310.50
Referral	249.70	158.90
GMP visits	2310.00	3115.00

DR-BNI Dental RECUR Brief Negotiated Interview for Oral Health, *GMP* general medical practitioner

Table 3 Mean (SE) output values for each treatment arm of the decision-tree parameter

	DR-BNI	Control	Source(s)
Cost of no. caries recur	£121.43 (17.20)	£105.00 (16.51)	Pine et al. [22]
Cost of caries recur	£113.57 (13.92)	£132.40 (13.62)	
Probability of no. caries	0.74	0.63	
Utility for no caries recur ^a	0.96 (0.01)	0.96 (0.01)	Oh et al. [28], Coco [29], Claxton et al. [30]
Utility for caries recur ^a	0.88 (0.01)	0.88 (0.01)	

DR-BNI Dental RECUR Brief Negotiated Interview for Oral Health, *QALYs* quality-adjusted life years, *SE* standard error

^aAll probabilities and QALYs values were adjusted to 2 years, matching the follow-up period in the analysis

[43]. The utility values are shown in Table 3. All QALY values were adjusted to cover the follow-up period while the transition probabilities and costs were obtained from the data set at end of the follow-up. A course of treatment and recovery is <90 days for dental caries, but 2 years in the intervention programme; thus, in accordance with NICE guidance [49–51], a discount rate of 3.5% for cost and effect was applied. A univariate sensitivity analysis was performed by varying the annual discount rate from 0–6% to assess the robustness of the base-case result.

The deterministic analysis investigated the values applied to the model using point estimates; hence, ameliorating the impact of extreme values. The one-way sensitivity analyses were conducted to factor in variability in the results by applying a range to individual parameters (see Table 6 in “Appendix”). High impacting parameters were examined within acceptable ranges and the results summarised using the tornado diagram (Fig. 2).

The probabilistic sensitivity analysis was conducted to investigate the uncertainty of the input parameters by assigning probability distribution to the parameters [31]. The costs were assigned a gamma distribution while the QALYs and probabilities were assigned a beta distribution (see Table 7 in “Appendix”). For the multi-way sensitivity analysis, a Monte-Carlo simulation was conducted [31, 32] with 5000 iterations from which the ICER was evaluated. The values of the various iterations are plotted and shown on the cost-effectiveness plane. Cost-effectiveness acceptability curve (CEAC) was generated to show the probability of the DR-BNI being cost effective at various values of willingness to pay (WTP) threshold. Affordability constraints of joint distribution of the simulated incremental cost and health benefit are investigated using the theory and methodology detailed by Sendi et al. [52, 53]. Affordability curves were also plotted for various budget constraint (or resource allocation constraints) and analysed as a function of the cost-effectiveness ratio [52, 53]. Further investigations into the risk-aversion analysis for both the DR-BNI intervention programme and the standard care programme were also examined using the same methodology as Sendi et al. [53,

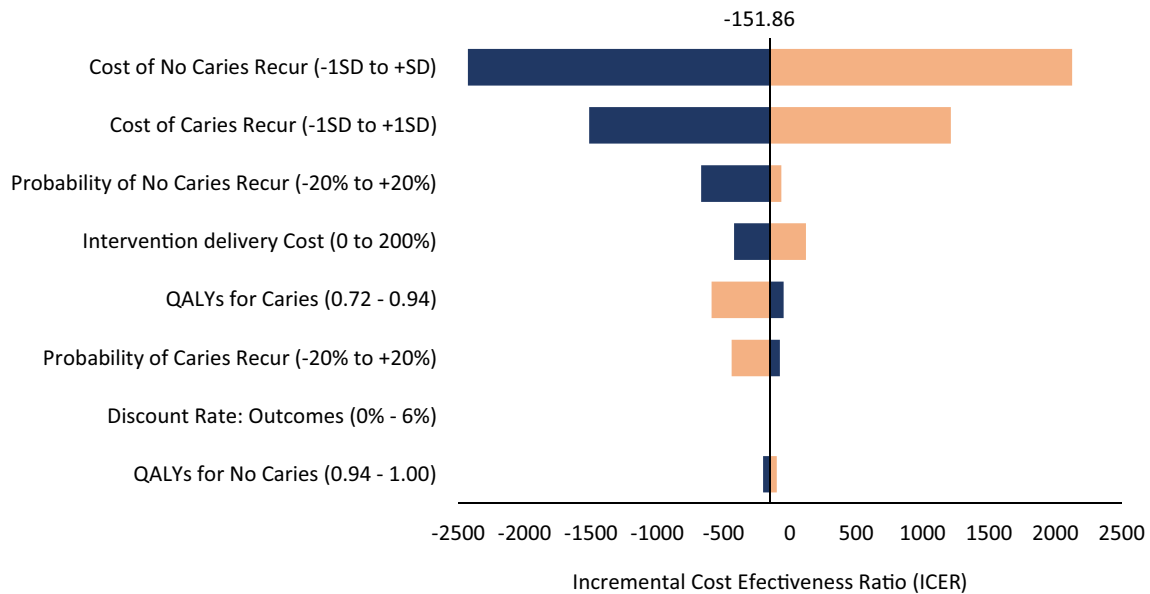

Fig. 2 Tornado diagram for univariate sensitivity analyses with a dominant ICER value for cost, QALY values, probabilities, intervention delivery cost and discount rate. *DR-BNI* Dental RECUR Brief

Negotiated Interview for Oral Health, *ICER* incremental cost-effectiveness ratio, *QALY* quality-adjusted life year

54] to determine the benefit-to-risk ratio towards the cost as a budgetary constraint. The cost-effectiveness risk-aversion curves (CERACs) are plotted using the results derived from the risk-aversion analysis. From the 2019 UK national statistics, the population of 8-year-olds is estimated to be under 7.2 million. A cohort of 3.6 million (50% of 8-year-olds) was adopted for the affordability and risk-aversion analysis, since a survey by Steele et al. [5] reports that almost half of 8-year-olds have experience of caries. The sensitivity of the result was examined using high impacting parameters to probe the robustness of the model. The results obtained provides decision makers with the necessary evidence in making the best resource allocation [17, 38].

3 Results

3.1 Base Case

The odds of new caries experience occurring were reduced by 51% in the DR-BNI group as compared with the control group; there was a 29% decrease in the relative risk (RR) [22]. Table 4 shows the main results of the cost-effectiveness analysis derived from the deterministic model, with the ICER from the mean cost and QALYs associated with each intervention. With an intervention cost of £6.47, the total healthcare cost from the DR-BNI intervention was £115.90 and the healthcare cost from the control arm was £119.46, while the QALYs values were 1.82 and 1.80, respectively. From Table 4, the results show that the cost

Table 4 Base case results for the cost-effectiveness analysis for costs and QALY gains

	Cost (£)	Incremental cost	QALYs	Incremental QALYs	ICER (cost/QALY)
DR-BNI	115.90	-£3.56	1.82	0.023	Dominant
Control	119.46		1.80		

DR-BNI Dental RECUR Brief Negotiated Interview for Oral Health, *ICER* incremental cost-effectiveness ratio, *QALY* quality-adjusted life year

from the DR-BNI intervention was lower than the cost of treatment of the control arm. Though the QALY value at each health state is equivalent, the total QALY gained from the DR-BNI intervention was higher than the control arm. The ICER value of the DR-BNI intervention is dominant in comparison to the standard care. This result is not just below the recommended NICE threshold [33] of £20,000–£30,000/QALY, it also saves resources and cost to the NHS.

3.2 Sensitivity Analyses

The univariate sensitivity analysis showed the variability of the ICER as a parameter change over a range of values. With a variation of a 200% increase in the intervention cost, the tornado plot (Fig. 2) shows the DR-BNI intervention to still be cost effective in comparison to the control with a value of £119.11/QALY. Two other high-impact parameters in the

model were the probabilities of transiting to different oral health state, and the costs associated with each health state. From the tornado diagram, the change in the cost of no caries recurring with \pm one standard deviation (SD) generated a variation of a dominant ICER value for the DR-BNI for the lower limit and an ICER value of £2125.93/QALY for the upper limit. For a change in the cost of patients with caries recurrence, a dominant ICER for the DR-BNI with minus one SD but an ICER of £1211.87/QALY for plus one SD. Changes in the ICER value are observed when the probability transition are varied by $\pm 20\%$, but the result still remains dominant in favour of the DR-BNI intervention.

The various QALY values were also investigated for variability, a value range of 0.72–0.94 for patients with recurrence of dental caries, while for patients with no caries, recurrence had values ranging from 0.94 to 1. The variability in the QALY values and discount rate of the outcome had little but no significant change in the ICER result.

Further univariate sensitivity analysis of the ICER was investigated for the lower and upper bound confidence interval around the point estimate of the RR of progression to dental caries state. At the lower bound RR of 0.53 the ICER value remains dominant in favour of the DR-BNI and for the upper bound RR of 1.05 the ICER value is £1077/QALY. As shown in Fig. 3, we see the ICER values for various RRs of progression have a nonlinear relationship which tends to infinity as the RR tends to one, for RR values less than one, the ICER value is dominant.

Figure 4 is a cost-effectiveness plane showing 5000 simulated ICER iterations for the DR-BNI versus control intervention using the probabilistic sensitivity analysis. The simulated ICERs are scattered over the four quadrants of the planes suggesting that there are occasions where the control intervention might be more cost effective. The south-east and north-east quadrants of the cost-effectiveness plane are the more densely populated of the four quadrants. This indicates that the DR-BNI intervention was the more dominant or cost effective of the two interventions on most occasions.

Figure 5 shows the CEAC plot for the DR-BNI and the control intervention. The curves show the probability of each intervention being cost effective at different levels of WTP per QALY gained. At no point in time did any of the interventions generate a 100% probability of being cost effective. The DR-BNI CEAC curve plateaus at WTP of £3500 per QALY gain with an approximate probability of 0.86 (see dotted line, Fig. 5). At WTP threshold of £0/QALY the ICER value has a probability of approximately 60% being cost effective. At the higher WTP threshold of £20,000/QALY gain the probability of the DR-BNI programme being cost effective is 86% (see dotted line Fig. 5).

3.3 Affordability and Risk-aversion Analysis

The CEAC curve provides a visual summary of the uncertainty about cost effectiveness but does not investigate this in relation to potential resource constraints [52]. Affordability

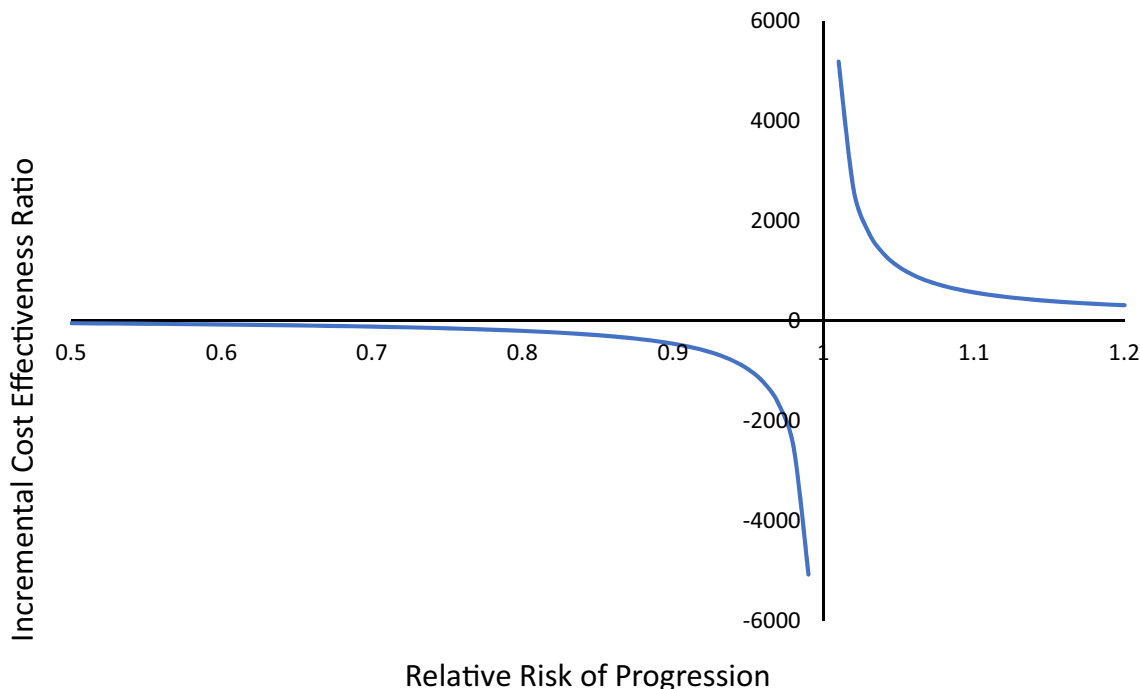

Fig. 3 Sensitivity analysis of the incremental cost-effectiveness (ICER) ratio to the relative risk of progression to dental caries

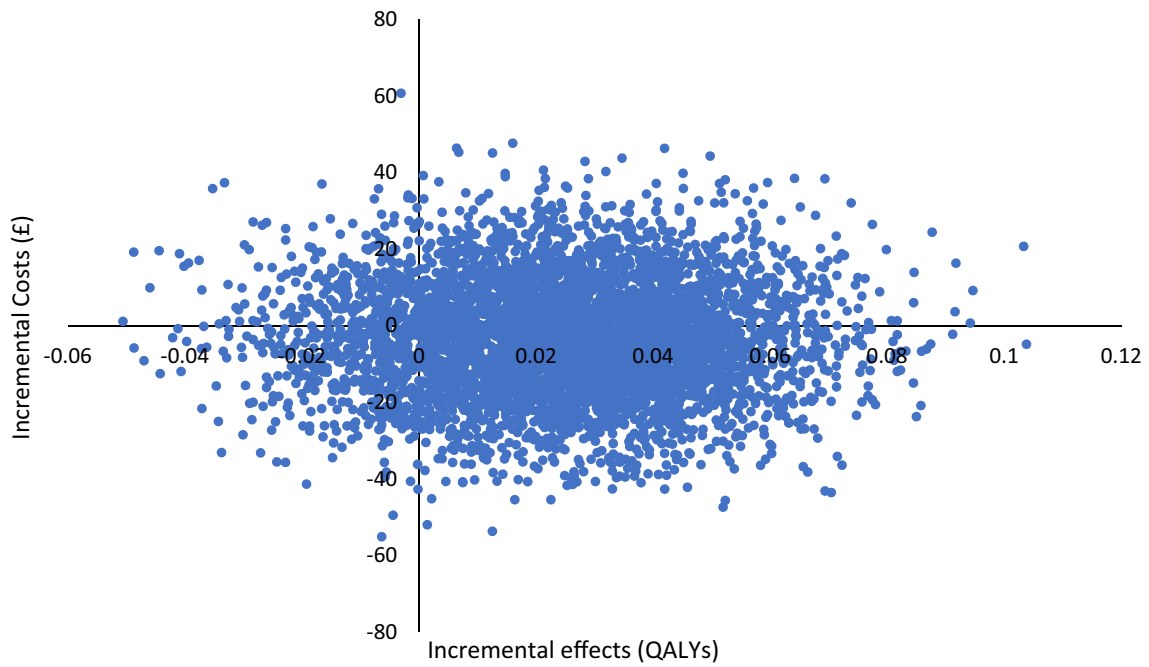

Fig. 4 Cost-effectiveness plane for dental caries recurrence in children

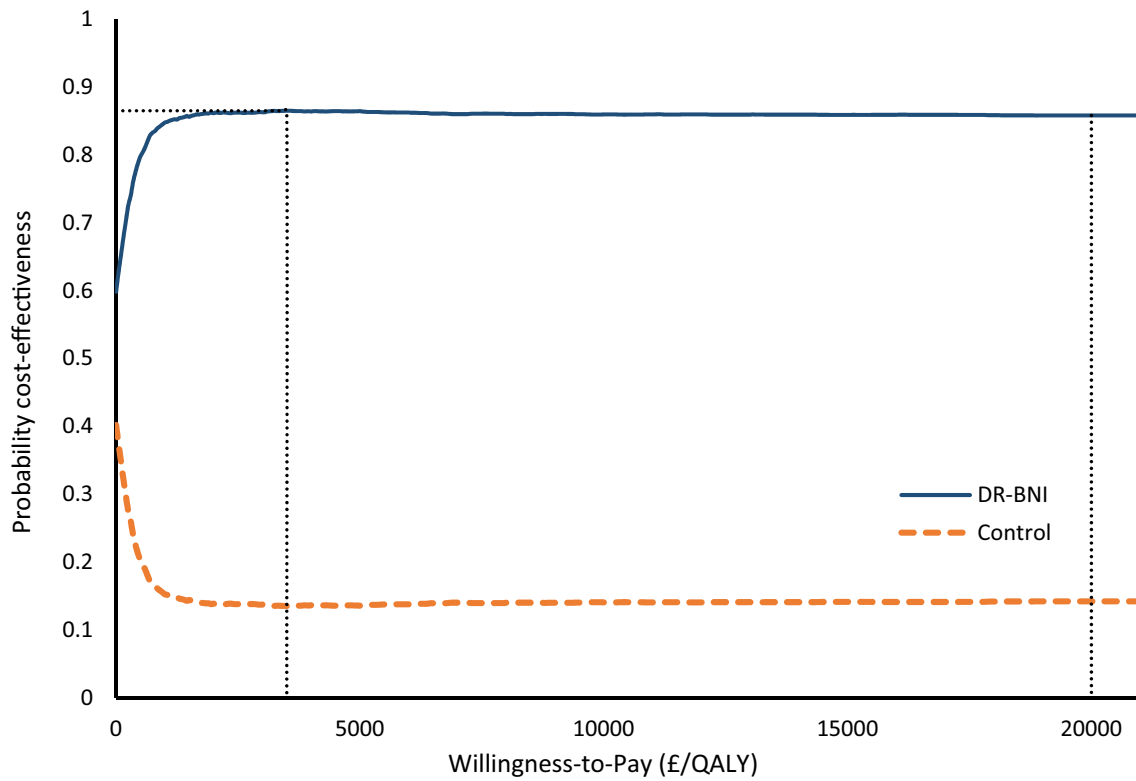

Fig. 5 CEAC from the Monte Carlo (probabilistic) sensitivity analysis with different levels of willingness to pay. Dotted lines represent the WTP threshold values at £3500 and £20,000 per QALY gain.

CEAC cost-effectiveness acceptability curve, QALY quality-adjusted life year, WTP willingness to pay

curves were generated to investigate the probability of the cost and effect with reference to specific budget constraints on the DR-BNI intervention. From Fig. 6, the probability of the DR-BNI intervention being affordable is 60% at no extra budget. As the budget increases the probability of the DR-BNI being affordable also increases. At a budget constraint of £36 million the probable affordability is 81%. An affordability of 100% probability is reached at a budget constraint of £234 million.

Further analyses investigated the combined impact of the cost-effectiveness and the affordability constraints at various WTP threshold for the DR-BNI intervention programme at different budget levels in Fig. 7. Each curve in the plot represents the probability of the DR-BNI intervention programme being cost effective and affordable at various WTP thresholds and various budget constraints. This figure shows that at a programme budget of £18 million the probability that the DR-BNI programme is both cost effective and affordable is peaked at 67 % at WTP threshold of £150/QALY gain, but gradually settles to 62 %. The higher the programme budget the higher the probability of being cost effective and affordable. The upper curve shows that at a programme budget of £234 million (no budget constraints) the corresponding probability of simultaneously being cost effective and affordable peaks at 86 % at the WTP threshold of £3500/QALY gained. For any programme budget equivalent or above the

“no budget constraints” (£234 million) the probability of the cost-effectiveness affordability curve will be the same as upper curve shown in Fig. 7. The “no budget constraint” curve in Fig. 7 is the same as the CEAC curve in Fig. 5, this curve does not attain a 100 % probability.

To inform a risk-averse decision maker, a computation of the risk-averse impact of each intervention arm for all possible WTP threshold value is plotted as a cost-effectiveness risk-aversion curve (CERAC) (see Fig. 8). From Fig. 8 it is observed that for all threshold values, the DR-BNI intervention offers more net monetary benefit (NMB) per unit of bad risk for all WTP threshold. The benefit-to-risk ratio is observed in the difference between the CERAC curves representing each intervention programme. The CERAC cuts the x-axis when the expected NMB exceeds zero.

Secondary results from baseline parameters are shown in Table 5. It is observed that DR-BNI had 217 dental visit and control had 215 visits. Thus, there was a higher proportion of dental visits to number of participants in the DR-BNI group in comparison with the control group (with a difference of 0.26). The case was different with the reported visits to the general medical practitioner (GMP), the DR-BNI group reported fewer visits (0.60 visits per participant) than in the control group (0.68 visits per participant). There was more progression to fillings and extractions in the control intervention than in the DR-BNI intervention. The results

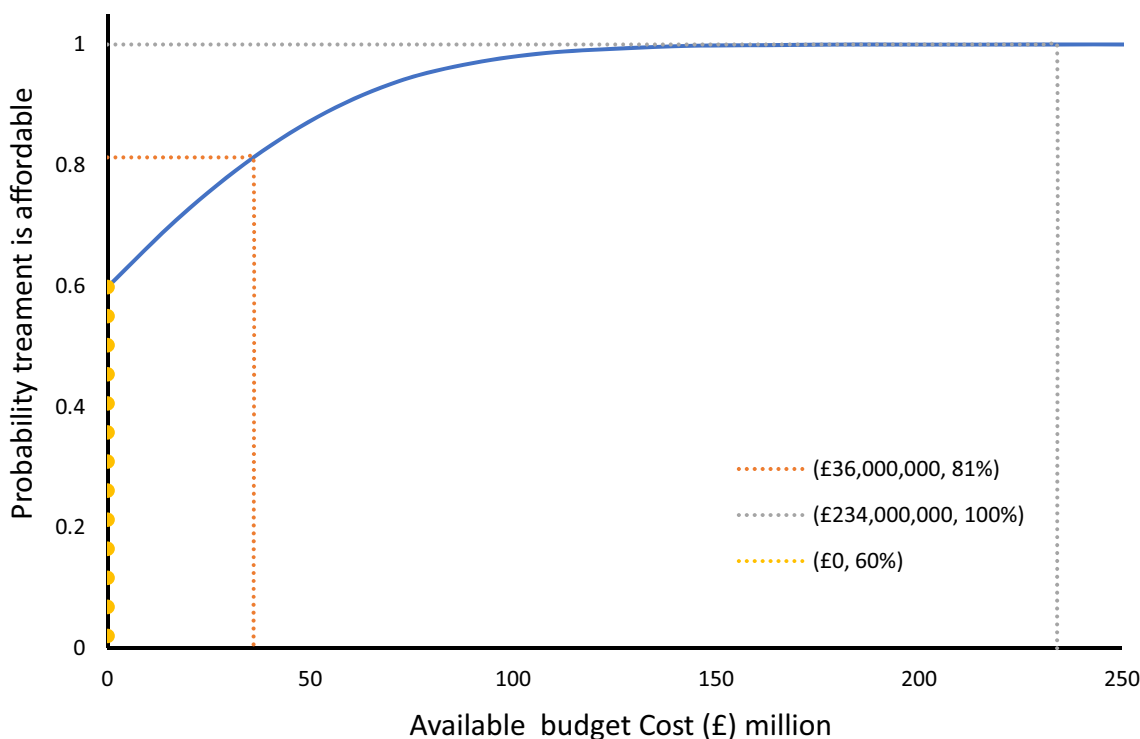

Fig. 6 An affordability curve showing the probability that the intervention is affordable (for 3.6 million children) as a function of the budget constraint

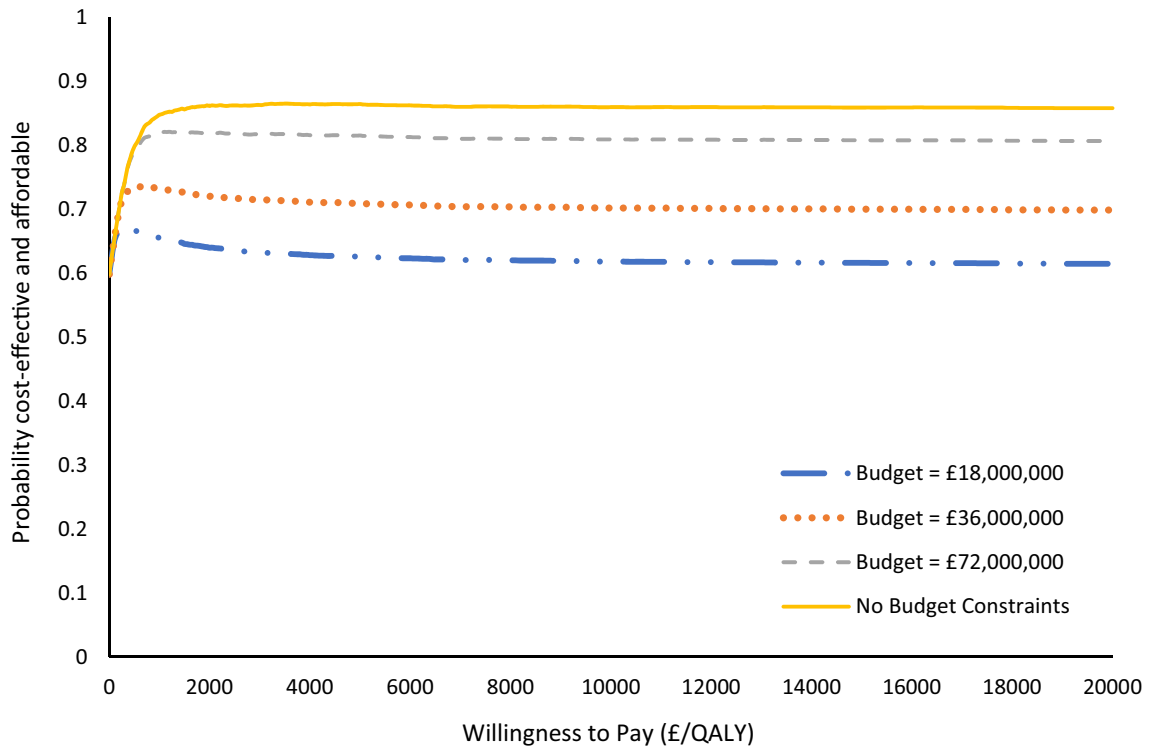

Fig. 7 Cost-effectiveness affordability curve showing the various probabilities of the DR-BNI intervention being simultaneously cost effective and affordability (for 3600,000 children) at different willing-

ness to pay threshold and budget constraints. *DR-BNI* Dental RECUR Brief Negotiated Interview for Oral Health, *QALY* quality-adjusted life year

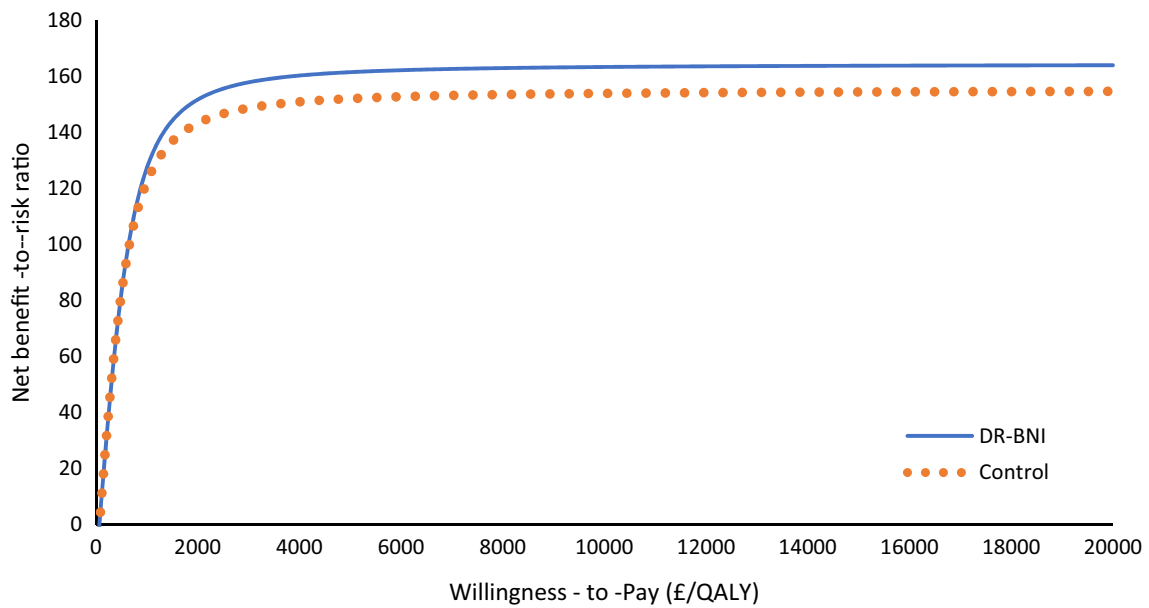

Fig. 8 The CERAC for DR-BNI intervention and standard care shows that the net benefit-to-risk ratio for DR-BNI is always preferred to standard care intervention for all the threshold ratios. *CERAC* cost-

effectiveness risk-aversion curve, *DR-BNI* Dental RECUR Brief Negotiated Interview for Oral Health, *QALY* quality-adjusted life year

Table 5 Number of visits and dental treatment provided during the 2-year trial period

	Number of cases (number of participants involved)	
	DR-BNI (<i>n</i> = 72)	Control (<i>n</i> = 78)
Visits to dentist	217	215
Only 1 visit	15	22
2 or more visits	57	56
Visits to GMP	43 (20)	53 (27)
Fillings and extraction	27 (21)	51 (36)

DR-BNI Dental RECUR Brief Negotiated Interview for Oral Health, *GMP* general medical practitioner

from Table 5 show that the DR-BNI intervention reduces progression to dental caries reoccurrence. The ratio of children with at least one event (fillings and extraction) in the DR-BNI arm is approximately 29 % and the control arm is 46 %; thus, a difference of 17 per 100 participants. The result from Table 2 supports the results from Table 5, with the control having higher costs for fillings, GMP visits, and antibiotic treatment.

The incremental cost is – £3.56 and the difference in the cases of children with fillings and extractions prevented is – 17 %. The cost-effectiveness ratio for having at least an adverse event (filling and/or extractions) avoided is a cost-savings of £20.94 per participant per event prevented.

4 Discussion

The aim of this pragmatic RCT was to compare the resource allocation towards oral health using two different approaches: the DR-BNI, a goal-oriented 30-minute “talking” approach, which involved discussion on caries prevention with a dental nurse and parent, and a usual care approach, which controlled for the time spent talking to parents in the DR-BNI arm. Both groups of participants were given the same informative leaflet about future tooth eruption. This study investigated the cost effectiveness of DR-BNI in preventing reoccurrence of dental caries in children aged 5–7 years who have had a primary tooth extracted. The results derived from this economic evaluation, conducted from an NHS perspective, alongside the Dental RECUR pragmatic RCT, provide evidence that the DR-BNI intervention is a dominant intervention in comparison to standard care, defined here as time spent talking to parents. The DR-BNI intervention was minimally less expensive, with a reduced mean cost of £3.56 per child.

The DR-BNI is a low-cost intervention (£6.47) that can be accommodated within the dental-care budget for children in the UK. The cost budget per child of the population in the

UK has ranged from £50–£77, and for registered children between £78–£105 per child annually in the past few years [15, 46–48]; this allows for the DR-BNI programme to be implemented with very little or no budget constraints.

The analysis shows that the NHS will be providing better oral health and cost savings in employing its resources towards the DR-BNI goal-oriented intervention. The secondary analysis also shows the DR-BNI to be effective and affirms that the NHS will be saving resources and costs in preventing fillings and extractions in patients with a value of £20.94 per participant for each event avoided. The QALYs gained by preventing reoccurrence of dental caries improves the OHRQoL of these children and thus eases the burden on parents and families [34]. The results obtained from the economic evaluation reaffirms the finding that the intervention of nurses with parents was critical to achieving better oral health in the DR-BNI group [22].

The control arm had a higher cost associated with patients in the “caries” health state while the DR-BNI arm had a higher cost for patients in the “no caries” health state. The cost variation in the two intervention arms can be explained as the DR-BNI had more cost accumulated from dental and other advisory visits while the control had more cost from fillings, extractions and other treatment. The QALY values implemented in both arms of the intervention were the same across health states. The major difference was in the transition probability rates across each health state. This explains the primary result of the DR-BNI having a dominant ICER result and a cost-saving secondary result (£20.94 per participant per case avoided), all in agreement with the results from the two-year clinical trial [22].

In a recent publication, Nguyen et al. [43] explored the impact of fluoride varnish in children using a decision tree and a Markov model. These techniques have been used for different interventions in oral health, but there are no decision models that have investigated the cost effectiveness of a goal-oriented therapeutic “talking” dental caries prevention intervention or compared it with other types of intervention or treatment. Tickle et al. [35] reported that preventive care in oral health seemed reactive to disease patterns [35]. The DR-BNI provides a pro-active and reactive prevention intervention approach.

The DR-BNI builds on studies that have investigated the benefits of educational interventions on oral health [36, 37] by embedding behaviour change techniques using a motivational interviewing approach, which provides a less expensive but more effective preventive approach to oral health. The involvement of parents/caregivers in the DR-BNI intervention seemed to be key and supports the findings of Clarke et al. [34] on the impact and role of parents as drivers of behaviour change within the family, for preventing dental caries through the life course.

The sensitivity analysis showed that varying parameters can have an impact on the cost-effectiveness analysis. The biggest parameters impacting the cost effectiveness were costs associated with the caries/no-caries recurrence group, which at the worst-case scenario remains cost effective. The cost of the intervention has varied and its impact is observed to remain cost effective even at its worst-case; its best-case is dominant in favour of the DR-BNI with a $\pm 200\%$ change. Two other common underlying parameters in both arms of the study; QALY values and transition probabilities were observed to vary the ICER but not change the interpretation of the result. This displayed the robustness and certainty in the process and results derived. Further studies are required to investigate the long-term cost effectiveness of the DR-BNI in comparison to other preventive or treatment interventions of children probably to the age of 18 years, at which time the NHS does not pay (partial/full) for the treatment cost.

5 Strengths and Limitations

This is the first study that investigates the cost effectiveness of the DR-BNI intervention for preventing reoccurrence of dental caries in children who have had a primary tooth extracted. These results will serve as a reference for future studies and a guide for other dental or child-based studies. The parameters such as costs and transition probabilities used in the analysis conducted in this study were informed from the Dental RECUR clinical trial [22], which provide the DR-BNI as a new addition in the preventive dental care literature. The perspective included in the study is the NHS perspective and we believe this to be most appropriate as the NHS covers the cost of treatment for children aged <18 years in the UK. The fact that this trial was undertaken within a well-conducted RCT provides literature for a well-established base case for comparison with other interventions aimed at preventing dental caries. Future research would be beneficial to examine the benefits of applying the DR-BNI intervention in primary care at earlier stages of childhood dental caries to reduce the need for subsequent extractions.

This dataset had no QALY values because at the time the study was conducted there was no preference-based measure of utility for young children. Since then, the CHU-9D has been developed and is increasingly being used in children aged ≥ 7 years [44]; hence, values from published literature were applied to this study. Although publications have shown the positive trends between dental caries and otitis media [45], QALY values from the DR-BNI trial might have varied slightly. This analysis focused on the treatment to

avoid double counting; hence, we adopted QALY values, but further outcomes such as quality-adjusted tooth years (QATYs), number of decayed, missing, and filled teeth (DMFT) can still be investigated in the future.

Another limitation observed during this study was the variation of isolating cost parameters during the sensitivity analysis due to the different treatment modules adopted by England, Scotland and Northern Ireland. In England, in order to vary the cost of one treatment, the costs for the bands should vary, and as each band contains more than one treatment, this produces some complexity.

Another limitation is that this study reflects only the NHS perspective and did not include other forms of cost, which might limit the results. Societal costs such as out-of-pocket costs, productivity loss due to a parent/caregiver accompanying the child, and children missing school for dental visits could impact the outcome of the result as shown in Table 4. It is widely accepted that health is strongly influenced by social, economic conditions and lifestyle choices [16]. With less severe treatment and better health, saved time and resources are channelled to other societal and economic activities that can promote a healthy community. Future studies should include societal costs in order to understand the overall impact of this intervention, not just to the NHS but to the individual families and societies as a whole.

6 Conclusions

Preventable tooth extraction due to dental caries in children costs the NHS £205 million per year in the UK [42]. The DR-BNI intervention offers good value for money in comparison to the control intervention in the dental care of children aged 5–7 years. This analysis also proved that the DR-BNI intervention prevents/reduces the reoccurrence of dental fillings and extraction as an adverse event with a mean cost savings of £20.94 per participant for adverse event prevented. The DR-BNI intervention was dominant for preventing dental caries reoccurrence with ICER values below the NICE threshold of £20,000 to £30,000 even at a worst-case scenario. The impact of a goal-oriented 30-minute therapeutic “talking” intervention between a dental nurse and parent/caregiver should be taken into consideration by policy makers as the evidence indicates it to be cost-saving to the NHS and provide better benefit to risk.

Appendix

See Tables 6, 7.

Table 6 Parameter ranges for the univariate sensitivity analysis

Parameters	Values
QALYs for no caries	(0.94–1.00)
QALYs for caries	(0.72–0.94)
Probability of caries recur	(– 20 to + 20%)
Probability of no caries recur	(– 20 to + 20%)
Intervention delivery cost	(0 to 200%)
Discount Rate: outcomes	(0–6%)
Cost of caries recur	(– 1SD to + 1SD)
Cost of no caries recur	(– 1SD to + SD)

Table 7 Distribution table for the probability sensitivity analysis

Parameters	Mean	Standard error	Distribution
QALYs for no caries recur	0.96	0.01	Beta
QALYs for caries recur	0.88	0.01	Beta
Cost for no caries recur	121.44	17.20	Gamma
Cost for caries recur	113.57	13.92	Gamma
Probability for caries recur (DR-BNI)	0.45	0.06	Beta
Probability for caries recur (control)	0.60	0.06	Beta

Supplementary Information The online version contains supplementary material available at <https://doi.org/10.1007/s40258-022-00720-5>.

Acknowledgements We thank Huw Lloyd-Williams who helped frame this study at its initial stages and Carys Jones for the useful comments and suggestions during this study. Thanks to Catherine Lawrence for assistance with manuscript preparation. Thanks to Louise Brennan, the trial manager and Laura Sutton, the trial statistician for the Dental RECUR trial. The dental teams and families who participated in the Dental RECUR trial are thanked and recognised.

Declarations

Ethics Approval and Consent to Participate This study was approved by the NRES Committee North West – Greater Manchester Central on 19th July 2013 (REC reference: 13/NW/0466). Written parental consent was obtained from parent or legal guardian.

Consent for Publication Not applicable.

Availability of Data and Material Data analysed are obtainable from Tables 1, 2, 3 and 4, and the main paper [22]. The datasets and code used and/or analysed during this current study are available upon request from the corresponding author or the Principal Investigator of DR-BNI multicentre RCT study Cynthia Pine.

Conflict of interest The authors declare no conflict of interest.

Funding This paper presents independent research funded by the National Institute for Health Research (NIHR) under its Research for Patient Benefit (RfPB) Programme (Grant Reference Number

PB-PG-0610-22310). The funder was not involved in the design of the study and collection, analysis, and interpretation of data, or in writing the manuscript. The views and opinions expressed are those of the author(s) and not necessarily those of the NIHR or the Department of Health and Social Care.

Author contributions Trial conception and design: CMP, PA and GB. Data collection and analysis: GB, CMP and PA. Health economic evaluation and interpretation: EV and RTE. Drafted initial manuscript: RTE, VE. Contributions to advance manuscript: ERT, CMP, EV, PA, GB. All authors read and approved the final manuscript. Trial conception and design: CMP, PA and GB. Data collection and analysis: GB, CMP and PA. Health economic evaluation and interpretation: EV and RTE. Drafted initial manuscript: RTE, VE. Contributions to advance manuscript: ERT, CMP, EV, PA, GB. All authors read and approved the final manuscript.

Open Access This article is licensed under a Creative Commons Attribution-NonCommercial 4.0 International License, which permits any non-commercial use, sharing, adaptation, distribution and reproduction in any medium or format, as long as you give appropriate credit to the original author(s) and the source, provide a link to the Creative Commons licence, and indicate if changes were made. The images or other third party material in this article are included in the article's Creative Commons licence, unless indicated otherwise in a credit line to the material. If material is not included in the article's Creative Commons licence and your intended use is not permitted by statutory regulation or exceeds the permitted use, you will need to obtain permission directly from the copyright holder. To view a copy of this licence, visit <http://creativecommons.org/licenses/by-nc/4.0/>.

References

1. Kassebaum NJ, Bernabé E, Dahiya M, Bhandari B, Murray CJ, Marcenes W. Global burden of untreated caries: a systematic review and metaregression. *J Dent Res*. 2015;94(5):650–8.
2. Petersen PE. Challenges to improvement of oral health in the 21st century—the approach of the WHO Global Oral Health Programme. *Int Dent J*. 2004;54(S6):329–43.
3. Knapp R, Gilchrist F, Rodd HD, Marshman Z. Change in children's oral health-related quality of life following dental treatment under general anaesthesia for the management of dental caries: a systematic review. *Int J Pediatr Dent*. 2017;27(4):302–12.
4. Abanto J, Paiva SM, Raggio DP, Celiberti P, Aldrigui JM, Bönecker M. The impact of dental caries and trauma in children on family quality of life. *Commun Dent Oral Epidemiol*. 2012;40(4):323–31.
5. Steele J, White D, Rolland S, Fuller E. Children's Dental Health Survey 2013. Report 4: the Burden of Dental Disease in Children England, Wales and Northern Ireland; 2015.
6. Pitts N, Chadwick B, Anderson T. Children's dental health survey 2013. Report 2: dental disease and damage in children: England, Wales and Northern Ireland. London: Health and Social Care Information Centre. 2015. <https://files.digital.nhs.uk/publicationimport/pub17xxx/pub17137/cdhs2013-report2-dental-disease.pdf>. Accessed 20 Mar 2020.
7. Sofi-Mahmudi A, Moradi S, Salomon-Ibarra CC, Morris J, Ravaghi V. Greater child dental health inequality in England compared to Wales and Northern Ireland, despite lower average disease levels. *Community Dent Health*. 2020;24(37):1–5.
8. Sarri G, Evans P, Stansfeld S, Marcenes W. A school-based epidemiological study of dental neglect among adolescents in a deprived area of the UK. *Br Dent J*. 2012;213(10):E17.

9. Masood M, Mnatzaganian G, Baker SR. Inequalities in dental caries in children within the UK: have there been changes over time? *Commun Dent Oral Epidemiol.* 2019;47(1):71–7.
10. Briggs AD, Mytton OT, Kehlbacher A, Tiffin R, Elhussein A, Rayner M, Jebb SA, Blakely T, Scarborough P. Health impact assessment of the UK soft drinks industry levy: a comparative risk assessment modelling study. *Lancet Public Health.* 2017;2(1):e15–22.
11. England PH. Delivering better oral health: an evidence-based toolkit for prevention, Third edition. 2017. https://assets.publishing.service.gov.uk/government/uploads/system/uploads/attachment_data/file/605266/Delivering_better_oral_health.pdf. Accessed 29 Mar 2020.
12. England NHS. Starting Well Core: 0–2s dental access and prevention framework. 2019. <https://www.england.nhs.uk/wp-content/uploads/2019/09/starting-well-core-0-2s-dental-access-and-prevention-framework-v1.0.pdf>. Accessed 11 Mar 2020.
13. National Institute for Health and Care Excellence (NICE). Dental checks: intervals between oral health reviews. Clinical guideline. 2004. <https://www.nice.org.uk/guidance/cg19>. Accessed 29 Mar 2020.
14. Primary Care Domain, NHS Digital. NHS Dental Statistics, England: 2017–18. Health and Social Care Information Centre. 2018. <https://files.digital.nhs.uk/4F/B3B6FE/nhs-dent-stat-eng-17-18-rep.pdf>. Accessed 16 Mar 2020.
15. National Services Scotland. Dental statistics—NHS treatment and fees. 2016. <http://www.isdscotland.org/Health-Topics/Dental-Care/Publications/2016-09-20/2016-09-20-Dental-Treatments-Fees-Report.pdf>. Accessed 26 Mar 2020.
16. Edwards RT, McIntosh E, editors. *Applied health economics for public health practice and research.* Oxford University Press; 2019.
17. Briggs A, Sculpher M, Claxton K. *Decision modelling for health economic evaluation.* Oxford: Oxford University Press; 2006.
18. Edwards RT, Hounsome B, Linck P, Russell IT. Economic evaluation alongside pragmatic randomised trials: developing a standard operating procedure for clinical trials units. *Trials.* 2008;9(1):64.
19. Masood M, Masood Y, Saub R, Newton JT. Need of minimal important difference for oral health-related quality of life measures. *J Public Health Dent.* 2014;74(1):13–20.
20. Slade GD. *Measuring oral health and quality of life.* Chapel Hill, University of North Carolina, Dental Ecology; 1997. p. 3.
21. Morris S, Devlin N, Parkin D. *Economic analysis in health care.* Hoboken: Wiley; 2007.
22. Pine CM, Adair PM, Burnside G, Brennan L, Sutton L, Edwards RT, Ezeofor V, Albadri S, Curnow MM, Deery C, Hosey MT. Dental RECUR randomized trial to prevent caries recurrence in children. *J Dent Res.* 2020;99(2):168–74.
23. Royal College of Nursing. NHS Pay Scales 2017–18. 2020. <https://www.rcn.org.uk/employment-and-pay/nhs-pay-scales-2017-18>. Accessed 16 Apr 2020.
24. NHS. How much will I pay for NHS dental treatment? 2017. <https://www.nhs.uk/common-health-questions/dental-health/how-much-will-i-pay-for-nhs-dental-treatment/>. Accessed 29 Mar 2020.
25. Statement of dental remuneration. 2019. <https://www.scottishdenタル.org/wp-content/uploads/2019/10/Amendment-No-142-.pdf>. Accessed 29 Mar 2020.
26. NI Direct government services. Health service dental charges and treatments. 2020. <https://www.nidirect.gov.uk/articles/health-service-dental-charges-and-treatments>. Accessed 29 Mar 2020.
27. Watson M. What is a UDA? *Vital.* 2010;7(2):13.
28. Oh PI, Maerov P, Pritchard D, Knowles SR, Einarson TR, Shear NH. A cost-utility analysis of second-line antibiotics in the treatment of acute otitis media in children. *Clin Ther.* 1996;18(1):160–82.
29. Cocco AS. Cost-effectiveness analysis of treatment options for acute otitis media. *Ann Family Med.* 2007;5(1):29–38.
30. Claxton L, Taylor M, Jenks M, Filby A. RX058: Economic Analysis of Oral Health Improvement Programmes and Interventions. Newcastle Upon Tyne Hospital and York Health Economics Consortium External Assessment Centre. 2014. <https://www.nice.org.uk/guidance/ph55/documents/economic-modelling-rx058-economic-analysis-of-oral-health-improvement-programmes-and-interventions4>. Accessed 17 Mar 2020.
31. Edlin R, McCabe C, Hulme C, Hall P, Wright J. *Cost effectiveness modelling for health technology assessment.* Heidelberg: Springer; 2015.
32. Poulouse BK. Decision analysis and cost-effectiveness research. In: *Health services research.* 2020 (pp. 229–236). Springer, Cham.
33. Appleby J, Devlin N, Parkin D. NICE's cost effectiveness threshold; 2007. pp. 358–359.
34. Clarke L, Stevens C. Preventing dental caries in children: why improving children's oral health is everybody's business. *Paediatric Child Health.* 2019;2019:5.
35. Tickle M, Milsom KM, King D, Blinkhorn AS. The influences on preventive care provided to children who frequently attend the UK General Dental Service. *Br Dent J.* 2003;194(6):329–32.
36. Kowash MB, Toumba KJ, Curzon ME. Cost-effectiveness of a long-term dental health education program for the prevention of early childhood caries. *Eur Arch Paediatr Dent.* 2006;7(3):130–5.
37. Holt RD, Winter GB, Fox B, Askew R. Effects of dental health education for mothers with young children in London. *Commun Dent Oral Epidemiol.* 1985;13(3):148–51.
38. Drummond MF, Sculpher MJ, Claxton K, Stoddart GL, Torrance GW. *Methods for the economic evaluation of health care programmes.* Oxford: Oxford University Press; 2015.
39. Dimick JB, Lubitz CC. An introduction to health services research. In: *Health Services Research 2020* (pp. 3–9). Springer, Cham.
40. NHS. What is included in each NHS dental band charge? 2018. <https://www.nhs.uk/common-health-questions/dental-health/what-is-included-in-each-nhs-dental-band-charge/>. Accessed 26 Mar 2020.
41. Curtis LA, Burns A. Unit costs of health and social care. Personal social services research unit, Kent, UK. 2019. <https://www.pssru.ac.uk/pub/uc/uc2019/community-based-health-care-staff.pdf>. Accessed 29 Mar 2020.
42. Mick A. Counting the cost of Tooth extraction. British Dental Association. 2018. <https://bda.org/news-centre/blog/counting-the-cost-of-tooth-extractions>. Accessed 19 Nov 2020.
43. Nguyen TM, Tonmukayakul U, Warren E, Cartwright S, Liew D. A Markov cost-effective analysis of biannual fluoride varnish for preventing dental caries in permanent teeth over a 70-year time horizon. *Health Promot J Austr.* 2020;31(2):177.
44. van Ijzendoorn MH, Bakermans-Kranenburg MJ. Problematic cost-utility analysis of interventions for behavior problems in children and adolescents. *New Dir Child Adolesc Dev.* 2020;2020(172):89–102.
45. Nelson S, Nechvatal N, Weber J, Canion S. Dental caries and ear infections in preschool-aged children. *Oral Health Prevent Dentistry.* 2005;3:3.
46. Kelly E, Lee T, Sibietta L, Waters T. *Public spending on children in England: 2000 to 2020.* London: Institute for Fiscal Studies. 2018.
47. National Services Scotland. Dental statistics—NHS treatment and fees. 2019. <https://www.isdscotland.org/Health-Topics/Dental-Care/Publications/2019-09-17/2019-09-17-DentalFees-Report.pdf>. Accessed 14 Oct 2021.
48. Northern Ireland Statistics and Research Agency—General dental statistics for Northern Ireland. 2020. <https://hscbusiness.hscni.net/>

- [pdf/General%20Dental%20Statistics%20Publication%20201920%20-%20Revised.pdf](#). Accessed 14 Oct 2021.
49. Rawlins MD, Dillon A. NICE comes of age. *Significance*. 2020;17(2):38–41.
 50. Claxton K, Paulden M, Gravelle H, Brouwer W, Culyer AJ. Discounting and decision making in the economic evaluation of health-care technologies. *Health Econ*. 2011;20(1):2–15.
 51. National Institute for Health and Care Excellence. NICE article [PMG9]—Guide to the methods of technology appraisal 2013. 2013. <https://www.nice.org.uk/guidance/pmg9/resources/guide-to-the-methods-of-technologyappraisal-2013-pdf-2007975843781>. Accessed 14 Oct 2021.
 52. Sendi P, Briggs AH. Affordability and cost-effectiveness: decision-making on the cost-effectiveness plane. *Health Econ*. 2001;10(7):675–80.
 53. Sendi P, Matter-Walstra K, Schwenkglenks M. Handling uncertainty in cost-effectiveness analysis: budget impact and risk aversion. In: *Healthcare*. 2021. (vol. 9, No. 11, p. 1419). Multidisciplinary Digital Publishing Institute.
 54. Sendi P. Dealing with bad risk in cost-effectiveness analysis: the cost-effectiveness risk-aversion curve. *Pharmacoeconomics*. 2021;39(2):161–9.
 55. Curtis LA, Burns A. Unit costs of health and social care. personal social services research unit, Kent, UK. 2019. <https://www.pssru.ac.uk/pub/uc/uc2019/sources-of-information.pdf>. Accessed 29 Mar 2020.