

Optical fiber-based heavy metal detection using the Localized Surface Plasmon Resonance technique

Papiya Dhara*, Rahul Kumar, Leonardo Binetti, Hien T Nguyen, Lourdes S Alwis, Tong Sun and Kenneth T V Grattan

Abstract— An innovative, reflection-based localized surface plasmon resonance (LSPR) fiber-optic sensor has been developed and demonstrated to detect the concentration of several heavy metal lead ions in an aqueous solution. By using a self-assembling technique, gold nanoparticles (Au NPs) have been immobilized on an optical fiber surface and functionalized with 1,1-Mercaptoundecanoic acid (MUA; HS(CH₂)₁₀CO₂H) in order to make the fiber selective to each the important heavy metal ion, Pb²⁺ or Cd²⁺. The concentration of the heavy metal then can be determined from the link between binding rate and the shift of the LSPR resonance wavelength. The Pb²⁺ ion sensitivity of the sensor thus created has been determined to be 0.28 nm/mM, with a typical response time of 30 seconds. Importantly, the probe has been shown to be reversible through a simple process involving the use of Ethylenedinitrilotetraacetic acid (EDTA;(HO₂CCH₂)₂NCH₂CH₂N(CH₂CO₂H)₂) chelator to remove the bound heavy metal ion.

Index Terms— Optical fiber sensor, Gold nanoparticles, Heavy metal sensor, Localized surface plasmon resonance, Lead-chelator.

I. INTRODUCTION

CONTAMINATION of water by heavy metal ions (especially mercury, cadmium, and lead) can cause serious environmental problems and human and animal health problems because of their acute, chronic toxicity to biological organisms [1]. Therefore, sensors to detect heavy metal ions in an aqueous solution are particularly needed to protect the environment. In this regard, spectroscopic-based techniques such as atomic absorption spectroscopy and inductively coupled plasma spectroscopy are amongst the most commonly used methods [2-3]. However, the well-known drawbacks of spectroscopic techniques, such as portability of the equipment (and thus use outside the laboratory), the initial cost of a sensitive spectrometer and onerous sample preparation methods have seen the emergence of new techniques based on nanotechnology. A number of nanoparticle-based heavy metal techniques have been reported in the last two decades and

among the varieties of nanoparticles available, gold nanoparticles (Au NPs) offer unique advantages in terms of a high Refractive Index (RI)-sensitive Localized Surface Plasmon Resonance (LSPR) peak, coupled to resistance to oxidation, ease of fabrication and well-understood surface chemistry [4,5]. Mishra *et al.* have, for example, incorporated poly-(n-vinyl-2-pyrrolidone) ((C₆H₉NO)_n) as a capping agent to create a LSPR-based mercury ion sensor [6]. Similarly, Youngjin Kim *et al.* have demonstrated a colorimetric sensor using the aggregation of 11-Mercaptoundecanoic acid (MUA; HS(CH₂)₁₀CO₂H) functionalized Au NPs in presence of heavy metal ions [7].

Coating Au NPs on an optical fiber (OF) to create a simple-to-fabricate, yet effective sensor probe offers several advantages, including ease of remote sensing capabilities, a potentially high signal-to-noise ratio and resistance to electromagnetic interference. As a result, several Au NPs coated optical fiber LSPR-based metal ion sensor designs have been explored in the literature [8-14]. For instance, monoclonal antibodies on Au NPs coated OFs have been shown to have an affinity towards the Pb²⁺- Ethylenedinitrilotetraacetic acid (EDTA;(HO₂CCH₂)₂NCH₂CH₂N(CH₂CO₂H)₂) complex. Even though the sensor can detect at the parts per billion (ppb) level, the steps involved to prepare a reliable sensor and implement an effective detection system are quite complicated and thus usually time consuming for the operator.

The key novelty in the work comes from targeting ease of manufacture, creating a simple, portable and robust LSPR-based OF sensor, operating in reflection mode and designed to detect the heavy metals Pb²⁺ or Cd²⁺ is reported. The focus in this work is on Pb²⁺ and Cd²⁺ because these are some of the most harmful, yet common heavy metals found polluting water, often from industrial 'run-off', in the developing world. The problem is particularly acute in India, the home of the lead author, and this is the major reason for developing a sensor of this type. Recognizing the importance of dealing with sensor cross-sensitivity, prior to fabrication the key issue of potential heavy

Corresponding author: P. Dhara(papiyadharaismpolito@gmail.com). "P. Dhara and R. Kumar contributed equally."

Kenneth TV Grattan acknowledges the support of the George Daniels Educational Trust and both he and Tong Sun acknowledge funding from the Royal Academy of Engineering.

P Dhara is with Department of Physics, Adamas University, Kolkata, India, 700126 (email: papiyadharaismpolito@gmail.com)

R. Kumar, H. Nguyen, T. Sun and K. Grattan are with the Department of Electrical and Electronics Engineering, City, University of London, EC1V 0HB, UK (e-mail: Rahul.Kumar@city.ac.uk; Hien.Nguyen@city.ac.uk; T.Sun@city.ac.uk; K.T.V.Grattan@city.ac.uk.)

L Binetti and L Alwis is with Edinburg Napier University (email: L.Binetti@napier.ac.uk; l.alwis@napier.ac.uk)

metal ion cross-sensitivity has been examined, at different concentrations of lead nitrate solutions, in MUA modified Au NP coated OFs. Thus, the MUA-functionalized LSPR probes created were dipped in different, known concentrations of aqueous solutions of lead nitrate. Arising from the binding of the Pb^{2+} -COOH (carboxyl) group, a change in amplitude as well as the resonance frequency is seen, this being indicative of the change in the concentration of the Pb^{2+} or Cd^{2+} ions studied. The reversibility of the probe has been verified by removing the attached heavy metal ions from the OF, by dipping it into the EDTA chelator and then inserting it into the Cd^{2+} ion solution.

II. METHODOLOGY

A. Chemicals and Apparatus

The following chemicals used were purchased from Sigma-Aldrich: gold chloride hydrate ($\text{HAuCl}_4 \cdot 3\text{H}_2\text{O}$), sodium citrate tribasic dehydrate ($\text{Na}_3\text{C}_6\text{H}_5\text{O}_7 \cdot \text{H}_2\text{O}$), 3-aminopropyl trimethoxysilane (APTMS; $\text{H}_2\text{N}(\text{CH}_2)_3\text{Si}(\text{OCH}_3)_3$) 97%, Lead nitrate ($\text{Pb}(\text{NO}_3)_2$), MUA, EDTA. In addition, Methanol (CH_3OH ; Analytical Reagent Grade), Hydrogen Peroxide (H_2O_2 ; 37%) solution and Sulphuric acid (H_2SO_4 ; 95% Laboratory Reagent Grade) were purchased from Fisher Scientific. Silver paint was purchased from e-bay. The chemicals were used as received.

The multimode optical fiber used, type FT1000UMT, was purchased from Thorlabs.

B. Characterization Instruments

The UV-visible spectrum of the synthesized Au NP was obtained using a LAMBDA 35 UV/VIS spectrometer (Perkin Elmer Inc.), allowing monitoring over the wavelength range from 400 nm to 800 nm (in steps of 1 nm). Transmission Electron Microscope (TEM) images were taken at an accelerating voltage of 80 kV and giving 400k magnification. Energy Dispersive X-Ray Analysis (EDAX) was done using a device sourced from Oxford Instruments.

A tungsten halogen light source, (type LS-1) and a Maya-type 2000PRO were used as the source and the detector respectively, to allow the response of the coated fiber to be acquired. Both components were purchased from Ocean Optics.

C. Synthesis of Au NPs

The Au NPs were synthesized by reducing the gold ions present in gold chloride hydrate acid with the help of citrate ions, following the steps described in previous work reported in the literature [15]. The approach used 20 mL of 1.0 mM $\text{HAuCl}_4 \cdot 3\text{H}_2\text{O}$ which was placed in a 50 ml round bottom flask and heated until a rolling boil was achieved. While stirring at 900 rpm, 2 mL of the 1% solution of sodium citrate tribasic dehydrate was rapidly added. This solution was then stirred for a further 10 mins, before removing the external heating. At the end of this step, the color of the solution was cardinal red, as expected, due to the formation of the Au NP colloid, as illustrated in Fig. 1(a).

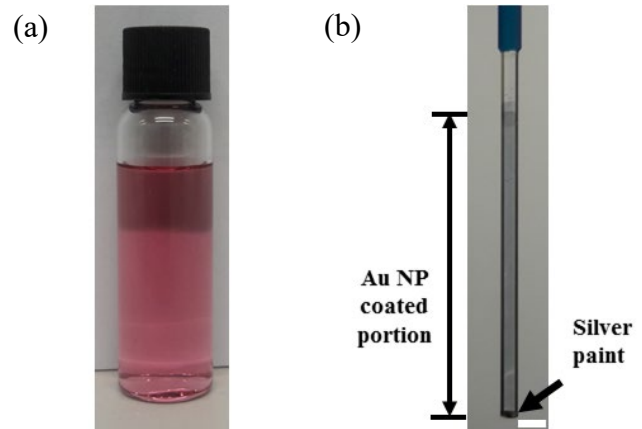

Fig.1 (a) Colloidal Solution (b) Image of the Au NP coated fiber, where the coating area is clearly visible. The white bar at the bottom right represents the reference scale (1 mm).

D. Sensor Preparation Process

The synthesized Au NPs were then coated on the optical fiber sample discussed, where a diameter of $\sim 1000 \mu\text{m}$ was used (as this large diameter provides a greater coating surface area), in that way to create the sensor probe used in this work. Before the coating was carried out, both ends of the fiber were carefully polished and at one end 2 cm of polymer jacket and the cladding was carefully removed. After that removal of the cladding, the Au NPs were coated on the cleaned fiber, using the steps described in literature [16]. This process can be summarized as follows: the fiber was washed and hydroxylized with Piranha solution, following which it was cleaned several times in running distilled water and then sonicated in distilled water to ensure complete removal of the last traces of the piranha solution. After drying the fiber in an oven for 1 hour at 120°C , the unclad fiber section was functionalized with APTMS solution in methanol (5% v/v) for 4 hours. This step was followed by washing the functionalized area with methanol and in the end by using distilled water. The fiber was placed in an oven at 100°C , overnight, to dry it completely. The next day the functionalized part of the fiber was dipped in synthesized Au NP solution for 6 hours to create a stable and uniform coating, as illustrated in Fig. 1(b).

The Au NP immobilized area is made selective to the heavy metal ions by using MUA as a cross-linker. MUA has two terminal functional groups, one being the thiol group and another being the carboxyl group. The thiol group (one of the two terminal functional groups) in the MUA becomes attached to the Au NPs via a strong Au-S covalent bond, whereas its other terminal group stays unattached ('dangling'). This dangling carboxyl group, chemically bound with heavy metals ions, thus makes the fiber selective to the heavy metal ions present in the solution. The MUA is coated on the fiber following the steps described in the literature [17]. In summary, the sensor probe was incubated in 0.3mM aqueous solution of MUA containing an equivalent amount of sodium hydroxide for 1 hour in at 50°C , where a water bath was used to maintain the

> REPLACE THIS LINE WITH YOUR PAPER IDENTIFICATION NUMBER (DOUBLE-CLICK HERE TO EDIT) <

constant temperature. After the unbound MUA had been removed in ethanol, the fiber was thoroughly rinsed with distilled water and dried using hot air from a heat gun.

The functionalization of the heavy metal on the MUA-Au NP-coated fiber was performed by dipping the optical fiber in a given heavy metal solution for 1 hour. After this, the fiber was taken out of the solution and dried using the air from the heat gun. The schematic of the steps described are shown in Fig. 2.

After the functionalization was completed, the fiber was coated with silver paint at the distal end to create a sensor used in reflection mode, in that way allowing the light to interact twice over the length of the immobilized area effectively, thus increasing the interaction time with the attached heavy metal ions.

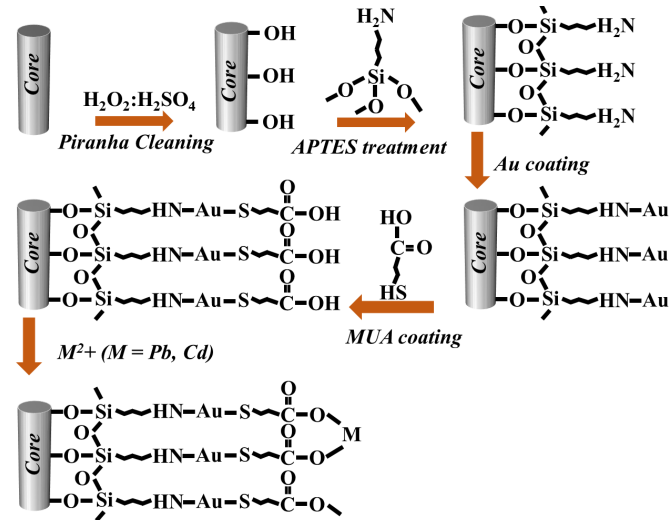

Fig.2. Schematic of the processes involved in the sensor preparation.

E. Characterization Setup for Solution Refractive Index and Heavy Metal detection

A schematic of the experimental set up developed is shown in Fig. 3. The broadband tungsten light source used was connected to one end of 1x2 fiber coupler (Ocean Optics, dia. ~ 600 μ m). The other two ends of the fiber coupler were connected to the spectrometer and the Au NP-coated fiber, where due to the presence of the silver coating at the tip of the Au NP-coated fiber, the spectrometer was able to collect the reflected light. The real time absorbance spectrum observed over the wavelength range from 400 to 900 nm (and taken with step sizes of 1 nm) was monitored and recorded on the PC used. The spectrum of the bare (not Au NP-coated) 1000 μ m fiber was used as the basis of creating the background signal.

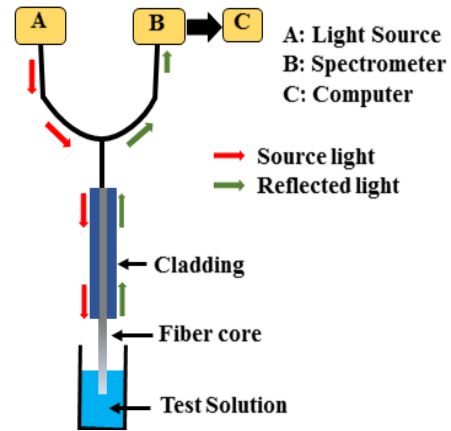

Fig.3. Schematic of the experimental setup used for the characterization of the Au NP coated fiber

F. Modeling technique

The Mie scattering matrix elements, assuming uniform spherical Au NPs, were calculated for the wavelength varying from 400nm to 800nm at step size of 1nm using home-made code written in Matlab. The code was developed and benchmarked following the techniques and results given by Bohren & Huffman in Appendix A [18]. In this work, the refractive index (RI) of gold used was calculated by interpolating the data given by Johnson & Christy [19]. The RI of medium surrounding the Au NPs was taken as 1.33 (i.e. of pure water).

III. RESULTS AND DISCUSSION

A. Characterization of Au NP

The UV-VIS spectrum of the colloidal solution obtained shows a LSPR peak at a wavelength of 524 nm, as illustrated in Fig. 4. The presence of only one LSPR peak in the entire spectrum confirms the colloidal particle to be symmetric. The modelled spectrum matches well with the experimentally obtained absorption spectrum for Au-NP of radius = 44 nm, as shown in Fig. 4. The slight mismatch between the experimental and the modeled spectrum is due to the assumption of uniform spherical Au-NP particles in the modeling. The TEM image of synthesized Au NP is shown in the inset of Fig. 4. It can be seen for the image that particles are approximately spherical.

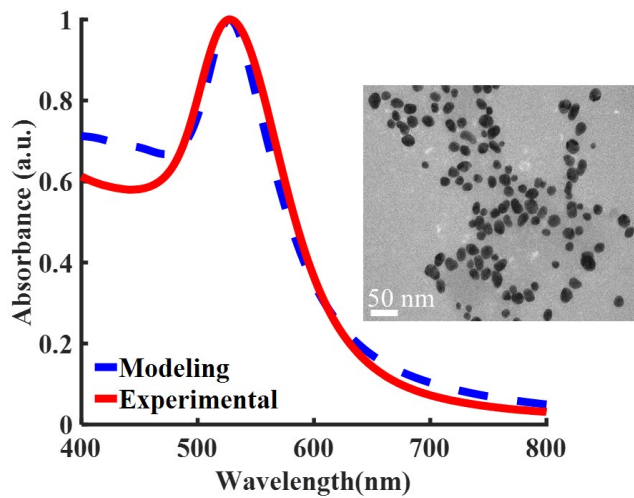

Fig.4 Characterization of the Au NPs. (a) Experimental UV-VIS spectrum obtained, with superimposed results of a model based on Mie scattering. Inset: TEM image of Au NP.

B. Refractive index response of Au NP-coated fiber probe

The successes in creating the coating layer was ensured by measuring its response to solutions of known and varying RI. The LSPR peak, occurring at a wavelength of 524 nm shows a red shift, as shown in the Fig. 5(a). Through a linear fitting of the red shift of the LSPR, the sensitivity of the probe was calculated to be 240 nm/RIU. Furthermore, the absorbance increases with increase in the RI, as shown in the Fig. 5(b).

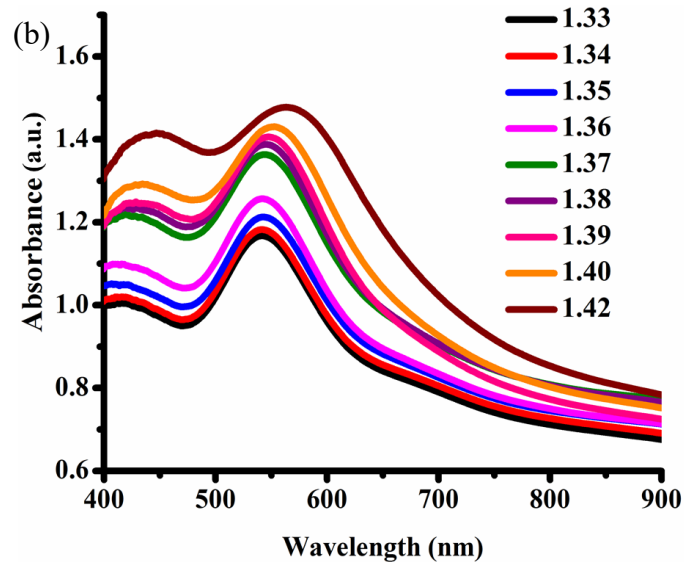
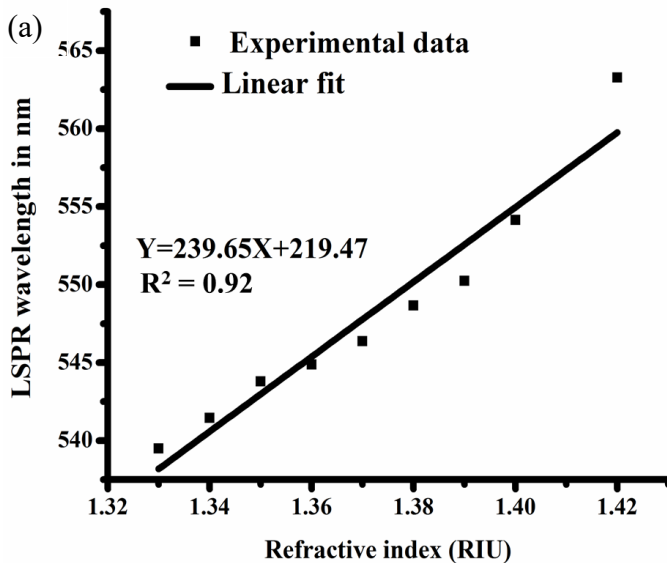

Fig.5. (a) Shift in LSPR wavelength in different refractive index media. (b) Response of Au NP-coated fiber to increase in absorbance with increase in RI.

C. Heavy metal ion detection ability of Au NP-coated fiber

The heavy metal detection ability of the Au NP-only coated fiber was evaluated by measuring its response in aqueous Lead Nitrate (LN) solutions of different concentrations (ranging from 0.67mM to 30 mM). In a way that is similar to the MUA-Au NP coated fiber, the Au NP-coated probe was inserted into the solution and left undisturbed for 1 hour. After that hour was completed, the probe was taken out and dried using the air from the hot air gun. Fig. 6 shows the response of the fiber, both when in the solution and when the probe was taken out and dried (i.e. in air). It can be seen that the response of the Au NP-coated fiber, in the case of being dipped into LN solutions, exactly matches the absorption spectrum obtained in distilled water (i.e. where there is no lead nitrate). A similar result was observed when the fiber was dried, after taking it out from the LN solution. These results show that the RI of the LN solutions used does not change with the concentration of Pb^{2+} ions. The RIs of various concentrations of LN solution were also calibrated with the use of an Abbe refractometer. The results indicate that, within the experimental error, all the solutions showed an RI of 1.33, as would be expected for an aqueous solution. Further, no change in the absorption spectrum, even after drying the fiber in air, shows that Pb^{2+} ions cannot be immobilized on the Au NPs coated fiber without presence of a linker. This therefore confirms that the fiber was coated with MUA.

> REPLACE THIS LINE WITH YOUR PAPER IDENTIFICATION NUMBER (DOUBLE-CLICK HERE TO EDIT) <

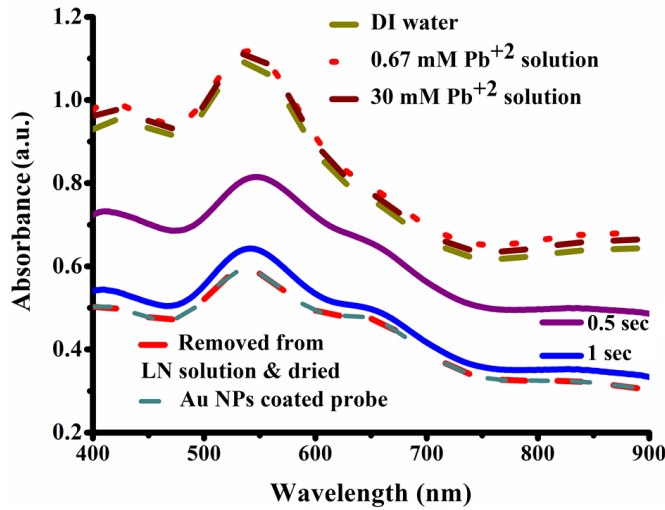

Fig.6. Response of Au NP-coated fiber in different concentrations of Lead Nitrate (LN) solution.

D. Lead ion detection using MUA-incorporated Au NP coated fiber

The comparison of the absorbance spectra of the MUA-Au NP-coated fiber with (only) the Au NP-coated fiber is shown in Fig.7. It can be seen that in the case of the MUA-Au NP fiber, there is a red shift in the spectrum. The observation of such a change indicates the successful immobilization of the MUA on the fiber. The sharp broadening of the absorbance spectra due to the inclusion of the MUA is seen, this likely resulting from the presence of covalent bonding between the carboxyl group of the MUA and the gold particles, where the carboxyl group acts as the ‘anchor’ for the immobilization of a heavy metal ions (such as Pb^{2+}), on the Au NP surface. This is evident from the presence of high percentage of carbon, oxygen and lead obtained in the EDAX analysis carried out on the portion (highlighted in Fig. 8) of the Au-MUA coated fiber after being immobilized in LN solution. The presence of 21.5% of Pb^{2+} shows the successful immobilization of lead on the fiber.

Figure 9(a) and 9(b) respectively shows the absorbance spectra of the MUA-Au NP-coated fibre in different concentration of LN solution when probe is inside the solution and when it is taken out of solution, afterward dried completely. It can be seen from the Fig. 9(a) that the LSPR absorbance peak remains unchanged during the incubation of the LSPR probe, which remains in a LN solution, of different concentration. However, the change in position of LSPR peak is quite evident when the probe is removed from the solution and afterwards dried and monitored in air, as shown in Fig. 9(b). As can be seen from the results shown in Fig. 9(c), an increase in the Pb^{2+} ion concentration (to 100 mM) results in the LSPR wavelength being red shifted from 551.7nm to 578.9nm. The slope of the linear fitting of LSPR red shift gives the Pb^{2+} ion sensitivity

0.28nm/mM.

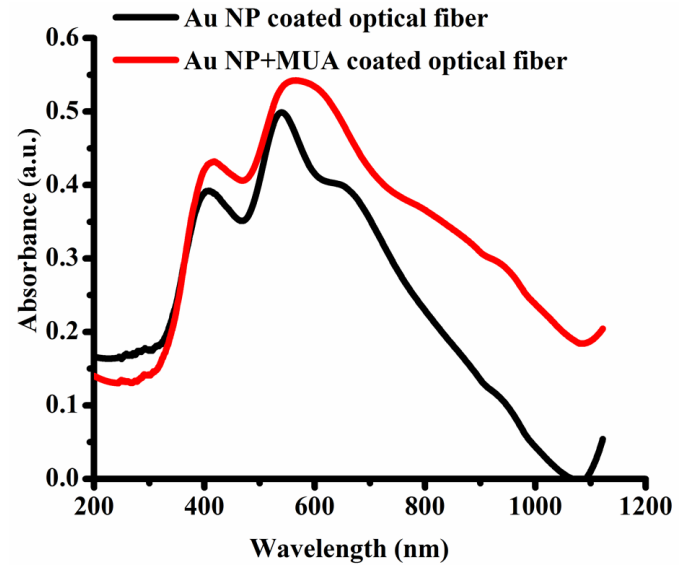

Fig.7. Absorbance spectrum of Au NP-coated fiber before and after coating with MUA.

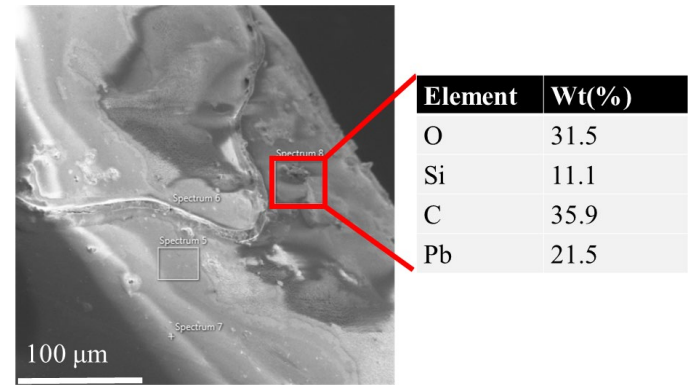

Fig.8. SEM image of Au-MUA-coated fiber after immobilization in Lead Nitrate (LN) solution. The table shows the EDAX analysis of the highlighted section.

Previously it had been noted that the refractive index variation of the lead nitrate solution, due to the change in its concentration, was relatively insignificant (the refractive index of the Pb^{2+} solution was noted to vary slightly – by less than 0.006, creating a range from 1.330 to ~1.336 – due to the change of the concentration from 0.67mM to 150mM). Such a refractive index change was within the measurement error of the Au NP RI sensor probe. Therefore, the recorded spectra from the Au NP-MUA probe were similar, whether the lead nitrate solution or Deionized Water (DI) were used. When the Au NP-MUA coated probes were removed from the lead nitrate solution, it was very clear that some Pb^{2+} ions had been immobilized by use of the MUA carboxyl group. Subsequently,

when the Pb^{2+} ion-immobilized probes were dried in air, an RI change due to Pb^{2+} contact was observed. Therefore, the red wavelength shift seen from the LSPR spectra in air is a consequence of the Pb^{2+} ion detection ability of the sensor, through the Au NP-MUA-incorporated LSPR optical fiber probe developed.

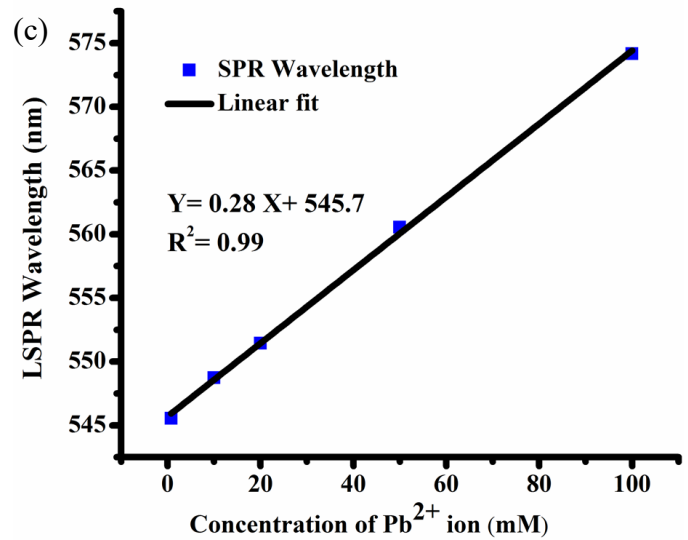
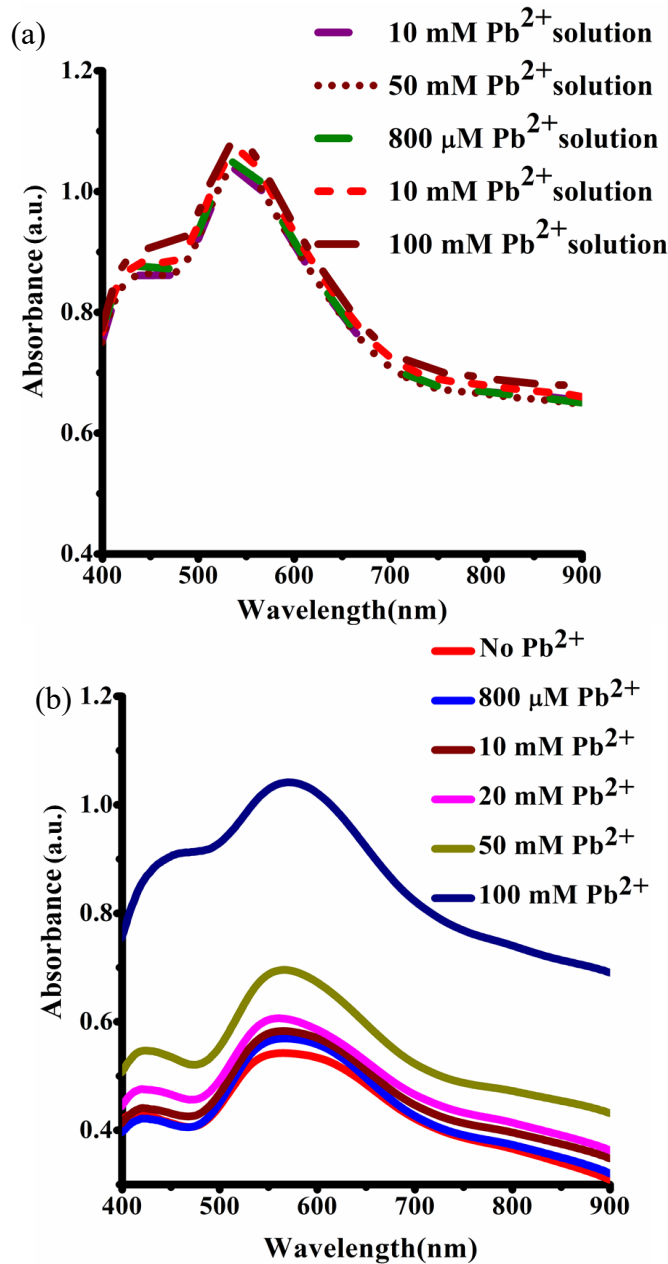

Fig.9. Response of MUA-coated fiber in (a) the Lead Nitrate (LN) solution (b) After removed from LN solution, dried and monitored in air (c) Pb^{2+} concentration versus LSPR wavelength

E. Stability of sensor: Longer-term monitoring with the LSPR Au NP-MUA incorporated optical fiber probe

The performance of the EDTA-washed Au NP-MUA coated fiber had been studied over a period of 17 hours, by dipping it in 100 μM Pb^{2+} aqueous solution. No shift of the absorbance peak with the low concentrations of Pb^{2+} solution (similar to that in air) was observed, as shown in Fig. 10. This shows the limit of detection of low concentrations of Pb^{2+} ions.

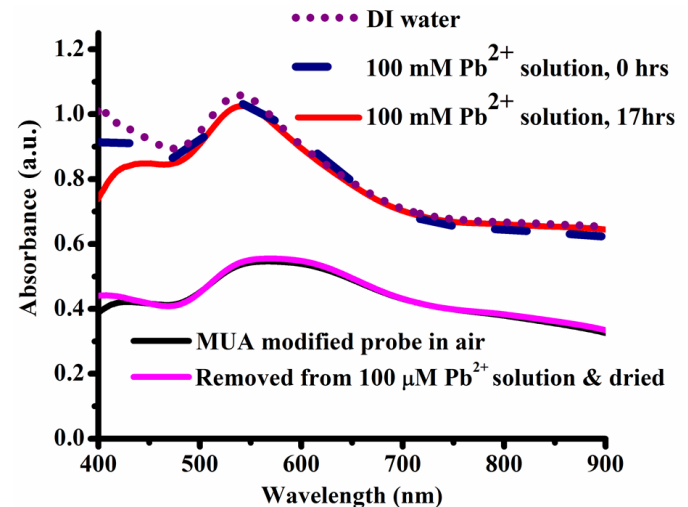

Fig.10. Long term response of Au NP-MUA coated fiber.

F. Reversibility of the sensor: Cadmium ion detection

The reversibility of the EDTA-washed Au NP-MUA coated

fiber probe was examined by dipping it in a 10mM cadmium acetate aqueous solution. The initial absorbance spectra of the sensor in air during detection of Pb^{2+} and Cd^{2+} differed, which may have arisen because of the degradation of the Au NP-MUA chemical bonding. Fig. 11 shows the small wavelength shift (a few nanometers) in the detection of 10mM Pb^{2+} or Cd^{2+} ions. Thus the sensor was seen as capable of detecting the two heavy metals considered, simultaneously, with almost the same sensitivity for each, and this result should be taken into consideration when using the probe.

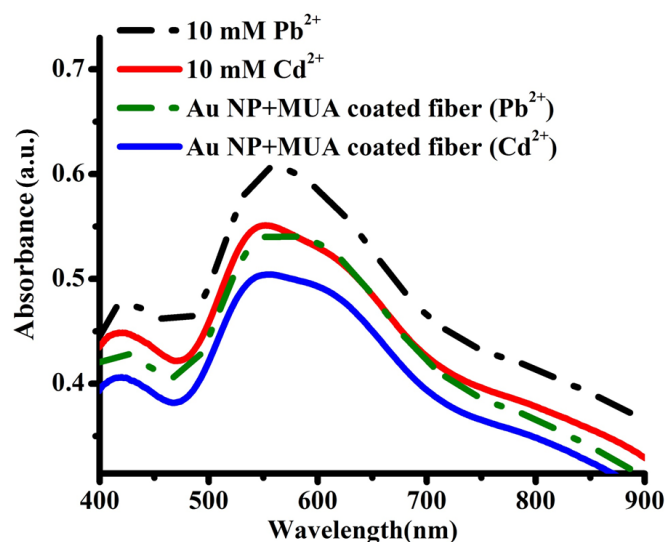

Fig.11. Reversibility of response shown by detection of cadmium ion.

G. Performance Comparison with prior work

In this work, we obtained the sensitivity 0.28 nm/mM and limit of detection of 800 μ M (65 ppm) of Pb^{2+} ions. In comparison to earlier reported limit of detection values of heavy metal ions, such as 0.36 μ M for Pb^{2+} [5], 0.1 μ M for Hg^{2+} ions [6], 25 μ M Hg^{2+} + 79 μ M Cu^{2+} [13], our reported value is slightly higher. However, the real strength of our sensor lies in its reusability, portability, mechanical robustness, ease of fabrication and low-cost setup because it does not need expensive and bulky source, detector, collimator, lenses, fusion splicer, etc.

IV. CONCLUSION

In this work, the design and application of a gold-nanoparticle coated (Au NP) optical fiber LSPR sensor has been demonstrated, this having been functionalized with MUA to immobilize the heavy metals, lead and cadmium. In calibrations carried out, the Pb^{2+} ion sensitivity recorded was 0.28 nm/mM (with a very similar response for the Cd^{2+} ion). This study represents early stage research carried out to establish the principle of creating a heavy metal sensor of this type by using such a coated optical fiber design. Further work

is continuing to increase the sensitivity from the millimole range, through optimizing parameters such as the gold nanoparticle size, the MUA drying temperature and the MUA concentration.

REFERENCES

- [1] United states environmental protection agency: Children's Health Month: EPA Offers nearly \$30 million to Support Cleaner Water and Air for America's Schoolchildren, October, 2018[Online]Available: <https://www.epa.gov/newsreleases/childrens-health-month-epa-offers-nearly-30-million-support-cleaner-water-and-air>
- [2] Yu, C., Guo, Y., Liu, H., Yan, N., Xu, Z., Yu, G., Fang, Y. and Liu, Y., 2013. Ultrasensitive and selective sensing of heavy metal ions with modified graphene. *Chemical Communications*, 49(58), pp.6492-6494.
- [3] Wang, C. and Yu, C., 2013. Detection of chemical pollutants in water using gold nanoparticles as sensors: a review. *Reviews in Analytical Chemistry*, 32(1), pp.1-14.
- [4] Newman, J.D.S., Roberts, J.M. and Blanchard, G.J., 2007. Optical organophosphate sensor based upon gold nanoparticle functionalized fumed silica gel. *Analytical chemistry*, 79(9), pp.3448-3454.
- [5] Nawi, N.M., Abdullah, S. and Bakar, A.A.A., 2014, September. Gold nanoparticles/graphene oxide/polyaniline nanocomposites film as sensitive LSPR-based sensor for Pb (II) ions detection. In 2014 IEEE 5th International Conference on Photonics (ICP) (pp. 188-190). IEEE.
- [6] Misra, N., Kumar, V., Goel, N.K. and Varshney, L., 2015. Radiation synthesized poly (n-vinyl-2-pyrrolidone)-stabilized-gold nanoparticles as LSPR-based optical sensor for mercury ions estimation. *Journal of Nanoparticle Research*, 17(7), p.279.
- [7] Kim, Y., Johnson, R.C. and Hupp, J.T., 2001. Gold nanoparticle-based sensing of "spectroscopically silent" heavy metal ions. *Nano Letters*, 1(4), pp.165-167.
- [8] Klimant, I. and Otto, M., 1992. A fiber optical sensor for heavy metal ions based on immobilized xylenol orange. *Microchimica Acta*, 108(1-2), pp.11-17.
- [9] Lin, T.J. and Chung, M.F., 2008. Using monoclonal antibody to determine lead ions with a localized surface plasmon resonance fiber-optic biosensor. *Sensors*, 8(1), pp.582-593
- [10] Bharadwaj, R. and Mukherji, S., 2014. Gold nanoparticle coated U-bend fibre optic probe for localized surface plasmon resonance-based detection of explosive vapours. *Sensors and Actuators B: Chemical*, 192, pp.804-811.
- [11] Lin, T.J. and Chung, M.F., 2009. Detection of cadmium by a fiber-optic biosensor based on localized surface plasmon resonance. *Biosensors and Bioelectronics*, 24(5), pp.1213-1218.
- [12] Ho, T.C., Jafri, M.Z.M., San, L.H. and Chong, M.Y., 2012, July. Detection of heavy metal ions in aqueous solution using fiber optic sensor. In 2012 International Conference on Computer and Communication Engineering (ICCCCE) (pp. 267-270). IEEE.
- [13] Bhavsar, K., Hurston, E., Prabhu, R. and Joseph, G.P., 2017, June. Fibre optic sensor to detect heavy metal pollutants in water environments. In OCEANS 2017-Aberdeen (pp. 1-4). IEEE.
- [14] Raghunandhan, R., Chen, L.H., Long, H.Y., Leam, L.L., So, P.L., Ning, X. and Chan, C.C., 2016. Chitosan/PAA based fiber-optic interferometric sensor for heavy metal ions detection. *Sensors and Actuators B: Chemical*, 233, pp.31-38.
- [15] McFarland, A.D., Haynes, C.L., Mirkin, C.A., Van Duyne, R.P. and Godwin, H.A., 2004. Color my nanoworld. *Journal of Chemical Education*, 81(4), p.544A.
- [16] Cao J., Tu, M.H., Sun, T. and Grattan, K.T., 2013. Wavelength-based localized surface plasmon resonance optical fiber biosensor. *Sensors and Actuators B: Chemical*, 181, pp.611-619.
- [17] Cao, J., Galbraith, E.K., Sun, T., Grattan, K.T.V., 2012. Effective surface modification of gold nanorods for localized surface plasmon resonance-based biosensors. *Sensors and Actuators B-Chemical*, 169, pp.360-367.
- [18] Bohren, C.F. and Huffman, D.R., 2008. *Absorption and scattering of light by small particles*. John Wiley & Sons.
- [19] Johnson, P.B. and Christy, R.W., 1972. Optical constants of the noble metals. *Physical review B*, 6(12), p.4370.