

Calm Displays and Their Applications

Making Emissive Displays Mimic Reflective
Surfaces Using Visual Psychophysics,
Light Sensing and Colour Science

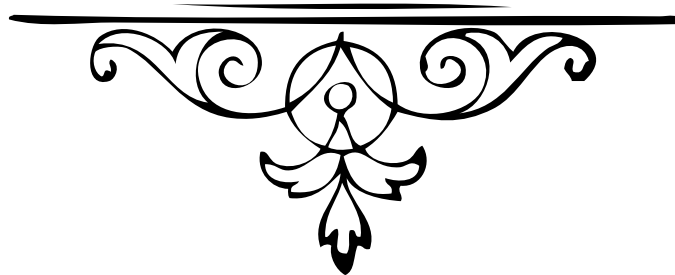

Jan Kučera

A thesis submitted in partial fulfilment of the degree of
Doctoral of Philosophy in Computing Science

School of Computing, Newcastle University

March 2020

Abstract

Our environment is increasingly full of obtrusive display panels, which become illuminating surfaces when on, and void black rectangles when off. Some researchers argue that emissive displays are incompatible with Weiser and Seely Brown's vision of "calm technology", due to their inability to seamlessly blend into the background. Indeed, Mankoff has shown that for any ambient technology, the ability to move into the periphery is the most relevant factor in their usability. In this thesis, a background mode for displays is proposed based on the idea that displays can look like an ordinary piece of reflective paper showing the same content.

The thesis consists of three main parts. In the first part (Chapter 4), human colour matching performance between an emissive display and reflective paper under chromatic lighting conditions is measured in a psychophysical experiment. We find that threshold discrimination ellipses vary with condition ($16.0 \times 6.0 \Delta E_{ab}$ on average), with lower sensitivity to chroma than hue changes. Match distributions are bimodal for some conditions. In the second part (Chapter 5), an algorithm enabling emissive displays to look like reflective paper is described and evaluated, giving an average error of $\Delta E_{ab} = 10.2$ between display and paper. A field study showed that paper-like displays are more acceptable in bedrooms and that people are more likely to keep them always on than normal displays. Finally, the third part (Chapter 6) concerns the development and four-week trial of a paper-like display application. Using the autobiographical design method, a system for sharing bedtime with a remote partner was developed. We see that once unobtrusive, display systems are desired for use even in spaces like bedrooms.

Paper-like displays enable both emerging and existing devices to move into the periphery and become "invisible", and therefore provide a new building block of calm technology that is not achievable using simple emissive displays.

to whomever it may concern

Acknowledgements

I am indebted to my supervisors, James Scott, Patrick Olivier and Anya Hurlbert for their support, patience and guidance. If I have learned anything about doing research, it is thanks to them.

Special thanks to Kateřina Machová for her consultations in statistical matters.

Table of Contents

| | |
|--|-----------|
| Chapter 1. Introduction | 1 |
| 1.1 The Calm Technology | 2 |
| 1.2 Research Questions..... | 4 |
| 1.3 Contributions | 6 |
| 1.4 Thesis Structure | 7 |
| | |
| Chapter 2. Introduction to Colorimetry | 8 |
| 2.1 Light | 8 |
| 2.1.1 Blackbody | 9 |
| 2.1.2 Sources of light | 11 |
| 2.1.3 Standard illuminants | 12 |
| 2.2 Human Eye | 13 |
| 2.3 Early colour matching experiments | 17 |
| 2.4 CIE XYZ Colour Space | 20 |
| 2.5 Additive Colour Spaces for Emissive Mediums (RGB)..... | 24 |
| 2.5.1 Gamut | 24 |
| 2.5.2 Transformation | 26 |
| 2.5.3 Compadding | 27 |
| 2.6 Subtractive Colour Spaces for Reflective Mediums (CMYK) | 29 |
| 2.6.1 Hexagonality of the gamut..... | 31 |
| 2.7 Perceptually Uniform Colour Spaces (LUV, LAB) | 34 |
| 2.7.1 CIELUV | 34 |
| 2.7.2 CIELAB | 35 |
| 2.8 Ordered Colour Sets..... | 38 |
| 2.8.1 Munsell..... | 39 |
| 2.8.2 RAL | 39 |
| 2.9 Physiological Colour Space (DKL) | 41 |
| 2.10 Summary..... | 43 |
| | |
| Chapter 3. Principles of Current Display and Sensing Technology, Materials and Equipment Used | 44 |
| 3.1 Light sensing technology..... | 44 |
| 3.1.1 Photodiodes | 44 |

| | | |
|---|--|-----------|
| 3.1.2 | Colour Filtering..... | 45 |
| 3.2 | Sensors used in this work..... | 46 |
| 3.2.1 | CS-2000 Spectroradiometer | 46 |
| 3.2.2 | TCS34725 RGB Sensor | 47 |
| 3.2.3 | MTCSiCF XYZ Sensor | 48 |
| 3.3 | Display Technology | 49 |
| 3.3.1 | Liquid Crystal Displays (LCD)..... | 49 |
| 3.3.2 | Light-Emitting Diodes (LED) | 51 |
| 3.3.3 | Electronic Paper Displays (EPD)..... | 52 |
| 3.4 | Displays Used in This Work..... | 54 |
| 3.4.1 | Fujitsu-Siemens Q584 Tablet | 54 |
| 3.5 | Lights Used in This Work..... | 55 |
| 3.5.1 | LT-01 Spectrally Tunable Lights..... | 55 |
| 3.5.2 | LLC010 Iris Philips Hue Lights | 56 |
| Chapter 4. Cross-Media Colour Matching Experiment: Study of Human Vision under Extreme Lighting Conditions | | 60 |
| 4.1 | Experiment Set-up | 60 |
| 4.1.1 | Display | 61 |
| 4.1.2 | Paper | 62 |
| 4.1.3 | Lights..... | 64 |
| 4.2 | Observers | 68 |
| 4.3 | Experiment Procedure..... | 68 |
| 4.3.1 | Navigating the Colour Space | 69 |
| 4.3.2 | Starting Points | 72 |
| 4.3.3 | User Experience | 74 |
| 4.3.4 | System Design | 77 |
| 4.4 | Results | 77 |
| 4.4.1 | Bimodality in Conditions | 79 |
| 4.4.2 | Matching Performance | 85 |
| 4.4.3 | Consistency of Observers | 88 |
| 4.4.4 | Discrimination Ellipses..... | 90 |
| 4.4.5 | Hue vs Chroma Sensitivity | 93 |
| 4.4.6 | Luminance and Chroma Relationship..... | 95 |
| 4.4.7 | Colour Naming | 98 |
| 4.5 | Summary..... | 100 |

Chapter 5. Paper-like Displays: Algorithm Design, Implementation and Evaluation 101

| | | |
|-------|---|-----|
| 5.1 | Related Work | 102 |
| 5.1.1 | Information Displays in the Periphery | 102 |
| 5.1.2 | Colour Matching | 102 |
| 5.1.3 | Responding to Ambient Illumination..... | 103 |
| 5.2 | Algorithm design | 104 |
| 5.2.1 | Establishing Working Colour Spaces | 105 |
| 5.3 | Calibration Process | 108 |
| 5.3.1 | Brightness Calibration..... | 108 |
| 5.3.2 | Chromaticity Calibration | 110 |
| 5.4 | Colour Matching..... | 110 |
| 5.4.1 | Chromaticity Matching..... | 111 |
| 5.4.2 | Brightness Matching..... | 111 |
| 5.4.3 | Desaturation in the Dark..... | 112 |
| 5.4.4 | Negative Brightness..... | 112 |
| 5.5 | Light Sensor..... | 113 |
| 5.5.1 | RGB Sensor Requirements | 114 |
| 5.5.2 | Final Hardware Design..... | 114 |
| 5.6 | Lab Evaluation..... | 118 |
| 5.6.1 | Measurement Set-up | 118 |
| 5.6.2 | Results..... | 121 |
| 5.7 | Field Evaluation | 123 |
| 5.7.1 | Study Design | 124 |
| 5.7.2 | Data Gathered | 125 |
| 5.7.3 | Results..... | 126 |
| 5.8 | Bedroom Environment | 129 |
| 5.8.1 | Lighting Data | 129 |
| 5.8.2 | Appropriateness of Displays..... | 131 |
| 5.8.3 | Types of Content..... | 131 |
| 5.8.4 | Other Environments..... | 132 |
| 5.9 | Discussion..... | 133 |
| 5.9.1 | Building Calm Devices | 133 |
| 5.9.2 | Limitations | 133 |
| 5.9.3 | Recommendations to Device Manufacturers | 134 |
| 5.10 | Summary..... | 135 |

| | |
|--|------------|
| Chapter 6. Bedtime Window: Connecting Bedrooms of Long-Distance Couples | 136 |
| 6.1 Related Work..... | 137 |
| 6.1.1 Long-Distance Relationships | 137 |
| 6.1.2 Inking..... | 143 |
| 6.1.3 ABD as a Research Method..... | 147 |
| 6.2 Autobiographical Design..... | 148 |
| 6.2.1 Origin and Consent..... | 148 |
| 6.2.2 Autobiographical Set-up | 151 |
| 6.2.3 Rapid Prototyping | 151 |
| 6.2.4 Long-term Usage..... | 154 |
| 6.2.5 Limitations of the ABD | 161 |
| 6.3 Final System Design for Field Study..... | 161 |
| 6.3.1 System Architecture | 161 |
| 6.3.2 Slow Photo Stream | 163 |
| 6.3.3 Inking..... | 163 |
| 6.3.4 Light | 164 |
| 6.3.5 Status and Feedback..... | 164 |
| 6.3.6 Other Controls..... | 165 |
| 6.3.7 Differences from ABD | 165 |
| 6.4 Field Study..... | 166 |
| 6.4.1 Study Design | 166 |
| 6.4.2 Participants | 167 |
| 6.4.3 Data Gathered | 167 |
| 6.4.4 Results..... | 168 |
| 6.5 Discussion..... | 182 |
| 6.5.1 Further Recommendations for ABD | 182 |
| 6.5.2 Implications for System Design..... | 183 |
| 6.5.3 Limitations and Future Work | 186 |
| 6.6 Summary..... | 187 |
| Chapter 7. Conclusion..... | 188 |
| 7.1 Future work..... | 189 |
| 7.1.1 Bedtime Window..... | 189 |
| 7.1.2 Paper-like Algorithm | 190 |
| 7.1.3 Future Work in Vision Science | 194 |
| 7.2 Responding to Research Questions..... | 195 |
| 7.3 Applications in Other Domains | 196 |
| 7.4 Summary..... | 197 |

| | |
|---|------------|
| References | 198 |
| Appendix A. Philips Hue Analysis | 226 |
| A.1 Point Accuracy | 226 |
| A.2 Stabilization Time | 228 |
| A.3 Gamut Estimation | 229 |
| Appendix B. LED Channel Values | 231 |
| Appendix C. Display's Chromatic Uniformity..... | 232 |
| Appendix D. Colour Matching Experiment Documents | 233 |
| D.1 Information Sheet | 233 |
| D.2 Consent Form | 234 |
| D.3 Instructions to Participants | 235 |
| D.4 Demographic Questionnaire | 236 |
| Appendix E. Paper-like Displays Study Documents | 237 |
| E.1 Call for Participants | 237 |
| E.2 Consent Form | 238 |
| E.3 Information Sheet | 239 |
| E.4 Progression Instructions..... | 243 |
| E.5 Study Plan | 244 |
| E.6 Interview Questions Plan | 245 |
| E.7 Recollection Sheet Week 1 | 246 |
| E.8 Recollection Sheet Week 2..... | 247 |
| Appendix F. Bedtime Window Study Documents | 248 |
| F.1 Recruitment Page | 248 |
| F.2 Pre-screening Questionnaire..... | 250 |
| F.3 Consent Form | 251 |
| F.4 Information Sheet | 252 |
| F.5 Initial Interview Supplemental Questionnaire | 261 |
| F.6 Final Interview Supplemental Questionnaire | 263 |

Appendix G. Paper-like Display Manual Calibration 265

G.1 Display Primaries 265

G.2 Linear Brightness Calibration 266

G.3 Chromaticity Calibration..... 267

List of Tables

| | |
|---|-----|
| Table 3.1. CS-2000 measuring tolerances, based on 10 measurements (from specification). | 47 |
| Table 3.2. Display specification according to the LCD panel datasheet | 55 |
| Table 3.3. LT-01 packet structure for setting LED channels power values..... | 56 |
| Table 3.4. Philips Hue gamut coordinates in xy..... | 57 |
| Table 4.1. Fujitsu tablet gamut specified vs measured. | 62 |
| Table 4.2. List of RAL sheets used in the experiment..... | 63 |
| Table 4.3. List of CIE 1931 coordinates used to generate the illumination conditions | 67 |
| Table 4.4. L as function of 8-bit achromatic sRGB values. | 71 |
| Table 4.5. Cross-media colour matching trial counts..... | 77 |
| Table 4.6 Observers ordered left to right by the date and time they did the experiment..... | 82 |
| Table 4.7. Per condition white card matching performance..... | 85 |
| Table 4.8. Effect of averaging method. | 86 |
| Table 4.9. Effect of colour matching function choice..... | 87 |
| Table 4.10. Effect of excluding observers based on various criteria | 90 |
| Table 4.11. Threshold ellipses in the CIE LAB space based on PCA results of confident matches. | 91 |
| Table 4.12. Area comparison of selected ellipses | 93 |
| Table 4.13. Chroma vs hue span of confident matches in CIELAB space..... | 94 |
| Table 4.14. Luminance difference of confident matches and linear regression analysis..... | 96 |
| Table 4.15. PCA ellipses for additional, fixed luminance confident matches | 97 |
| Table 4.16. Achromatic colour naming summary..... | 99 |
| Table 5.1. Paper-like displays algorithm pseudo-code..... | 107 |
| Table 5.2. Average number of pictures remembered. | 129 |
| Table 5.3. Display content suggested by 12 participants..... | 132 |
| Table 6.1. Bedtime Window field study participants overview..... | 167 |
| Table 0.1. Philips Hue gamut lines and points analysis..... | 229 |

List of Figures

| | |
|---|----|
| Figure 1.1. The number of displays in our environment is growing. | 1 |
| Figure 1.2. Public displays in Sprinkles Gelato. | 4 |
| Figure 1.3. Bedroom with Philips Hue lighting. | 5 |
| Figure 2.1. Spectral power distribution of the CIE standard illuminant D65. | 9 |
| Figure 2.2. Blackbody radiation for selected temperatures. | 11 |
| Figure 2.3. Light reflected from a surface. | 12 |
| Figure 2.4. Physiology of the human eye. | 14 |
| Figure 2.5. Rods and cones fundamentals. | 15 |
| Figure 2.6. Fovea and distribution of photoreceptors. | 16 |
| Figure 2.7. Macula regions and density. | 17 |
| Figure 2.8. Spectral colours and 3 primaries as of 1926. | 19 |
| Figure 2.9. Colour matching results by Guild and Wright. | 20 |
| Figure 2.10. CIE 1931 2° XYZ (solid) and CIE 1964 10° XYZ (dashed) colour matching functions. | 21 |
| Figure 2.11. CIE 1931 xy chromaticity diagram. | 22 |
| Figure 2.12. Stiles & Burch individual 10° colour matching functions. | 23 |
| Figure 2.13. Additive colour mixing. | 24 |
| Figure 2.14. Photos of a typical pixel grids. | 24 |
| Figure 2.15. RGB colour space. | 25 |
| Figure 2.16. Selection of standardised RGB primaries. | 25 |
| Figure 2.17. Non-linearity in perception and corrections. | 28 |
| Figure 2.18. Subtractive colour mixing. | 29 |
| Figure 2.19. Enlarged photo of a printed image, showing CMYK halftone patterns. | 30 |
| Figure 2.20. SWOP CMYK colour space compared to sRGB. | 30 |
| Figure 2.21. Additive and subtractive mixing of spectra. | 31 |
| Figure 2.22. Unit triangle of imaginary primaries in the CIE 1931 xy chromaticity diagram. | 31 |
| Figure 2.23. Yellow and magenta combined using additive (left) and subtractive (right) models. | 33 |
| Figure 2.24. Hexagonal gamut in a subtractive model. | 33 |
| Figure 2.25. MacAdam ellipses of chromaticity discrimination. | 35 |
| Figure 2.26. sRGB gamut in CIELAB space. | 37 |
| Figure 2.27. Perceptual uniformity of CIELAB. | 38 |

| | |
|---|----|
| Figure 2.28. Munsell Book of Color (marketing photo). | 39 |
| Figure 2.29. RAL DESIGN SYSTEM <i>plus</i> | 40 |
| Figure 2.30. Second-stage colour encoding as per DKL space. | 42 |
| Figure 2.31. DKL colour space..... | 42 |
| Figure 3.1. Unfiltered photodiode sensitivity by material. | 44 |
| Figure 3.2. Interference filter..... | 45 |
| Figure 3.3 Interference filter performance based on angle of incidence. Adapted from [110]...... | 46 |
| Figure 3.4. CS-2000 schematic (adapted from its instruction manual) | 47 |
| Figure 3.5. TCS34725 sensor..... | 48 |
| Figure 3.6. TCS3472 spectral responsivity..... | 48 |
| Figure 3.7. MTCSiCF sensor..... | 49 |
| Figure 3.8. The principle of a liquid crystal display. | 50 |
| Figure 3.9. The principle of an electrophoretic display. | 53 |
| Figure 3.10. EPD vs OLED colour gamut..... | 53 |
| Figure 3.11. Measured characteristics of Fujitsu tablet display. | 55 |
| Figure 3.12. Spectra of 13 individual LED channels..... | 56 |
| Figure 3.13. Philips Hue lights spectral measurement set-up..... | 58 |
| Figure 3.14. Philips Hue lights spectra for red, green blue and white settings..... | 58 |
| Figure 4.1. Colour matching experiment set-up..... | 61 |
| Figure 4.2. Uniformity of display's visible area..... | 62 |
| Figure 4.3. Spectral reflectance of RAL sheets used in the experiment. | 63 |
| Figure 4.4. Interpolated uniformity of reference paper sheet..... | 64 |
| Figure 4.5. Experiment conditions compared to display and lights gamut. | 67 |
| Figure 4.6. Spectral radiance from white card under 9 test illuminations. | 68 |
| Figure 4.7. Xbox One controller schema..... | 70 |
| Figure 4.8. Minimum change in L needed to change any of 8-bit sRGB values | 72 |
| Figure 4.9. Randomized starting points. | 73 |
| Figure 4.10. Software screens for commencing an experiment session. | 75 |
| Figure 4.11. Software screens for commencing a trial and performing the colour matching task..... | 75 |
| Figure 4.12. Additional software screens..... | 76 |
| Figure 4.13. All winter white paper sheet matches (1031) in CIE LAB space. | 78 |
| Figure 4.14. Bimodality in yellow and daylight yellow matches..... | 79 |

| | |
|---|-----|
| Figure 4.15. Bimodality in yellow and daylight yellow matches by observers..... | 79 |
| Figure 4.16. All matches of 19 colour-coded observers. CIELAB space..... | 80 |
| Figure 4.17. Linear regression results for significance of clusterering on the greenness of matches . | 81 |
| Figure 4.18. Yellow condition with L matching function shifted | 82 |
| Figure 4.19. Yellow matches of observers..... | 82 |
| Figure 4.20. Two top consistent participants from different clusters repeating the experiment..... | 83 |
| Figure 4.21. All winter white paper sheet matches (1031) in CIE LAB space | 84 |
| Figure 4.22. Effect of colour matching functions on the blue condition. | 87 |
| Figure 4.23. The matches of the most (left) and least (right) consistent observers | 88 |
| Figure 4.24. Observer's session duration vs matches standard deviation from observer's average. . | 89 |
| Figure 4.25. Cumulative performance (left) and its standard deviation (right) | 89 |
| Figure 4.26. Threshold ellipses in the CIE LAB space based on PCA results of confident matches... | 91 |
| Figure 4.27. Threshold ellipse size as a function of chroma. | 92 |
| Figure 4.28. Comparison of our cross-media matching ellipses (red) versus Luo and Rigg..... | 92 |
| Figure 4.29. Matching results in the DKL space..... | 93 |
| Figure 4.30. Chroma to hue discrimination thresholds ratio (correlation 0.82). | 95 |
| Figure 4.31. Luminance variance in all matches, in CIELAB space using LCh _{ab} (polar) projection... | 95 |
| Figure 4.32. Luminance difference in confident matches based on chroma in CIELAB space. | 96 |
| Figure 4.33. Initial fixed luminance data. | 97 |
| Figure 4.34. Most common colour names per all paper and light conditions..... | 98 |
| Figure 4.35. Cumulative stacked colour naming as a function of trial durations | 99 |
| Figure 5.1. Demonstration of paper-like technology under different lighting conditions. | 101 |
| Figure 5.2. Schematic overview of the paper-like algorithm..... | 105 |
| Figure 5.3. RGB sensor pseudo-primaries..... | 106 |
| Figure 5.4. Brightness calibration data, including “negative brightness” | 108 |
| Figure 5.5. Chromaticity calibration data..... | 110 |
| Figure 5.6. Prototype sensing using ISL29125 with an improvised diffuser..... | 114 |
| Figure 5.7. Custom-built USB dongle with 4-channel (RGB+clear) TCS34725 light sensor..... | 115 |
| Figure 5.8. Angular response of TCS3472 (from its datasheet). | 115 |
| Figure 5.9. Angular response automated measurement. | 116 |
| Figure 5.10. Light sensor design..... | 116 |
| Figure 5.11. Causes of flicker..... | 117 |

| | |
|--|-----|
| Figure 5.12. Quantitative evaluation setup | 119 |
| Figure 5.13. Gamut sampling | 120 |
| Figure 5.14. Overall distribution of the measured colour distances | 121 |
| Figure 5.15. Distribution of differences between the display and paper | 122 |
| Figure 5.16. An example of the deployed device in-situ..... | 124 |
| Figure 5.17. Paper-like field study overview. | 126 |
| Figure 5.18. Percent of the nights on which individual participants kept the display on..... | 127 |
| Figure 5.19. Was the display distracting? | 127 |
| Figure 5.20. Were you able to see the content when you glanced at it? | 128 |
| Figure 5.21. Within-subjects content visibility scoring of paper-like display..... | 128 |
| Figure 5.22. Examples of images used during the study | 129 |
| Figure 5.23. The light level during a typical 24-hour period | 129 |
| Figure 5.24. Distribution of illuminance values measured. | 130 |
| Figure 5.25. Applied chromaticity results. | 130 |
| Figure 5.26. Are calm displays more appropriate for bedroom use?..... | 131 |
| Figure 5.27. Would you want a display like this in your bedroom long-term?..... | 131 |
| Figure 5.28. Within-subjects' scoring on the desirability of having paper-like | 131 |
| Figure 6.1. Overview of Bedtime Window as presented during recruiting participants..... | 137 |
| Figure 6.2. First collaborative drawing interfaces overlaying a video..... | 146 |
| Figure 6.3. Two deployment configurations at remote partner during ABD..... | 160 |
| Figure 6.4. Overall Bedtime Window schema. | 162 |
| Figure 6.5. Inking packet (80 bytes)..... | 163 |
| Figure 6.6. System usage during the study. | 168 |
| Figure 6.7. System reception questions..... | 169 |
| Figure 6.8. Feature importance question..... | 170 |
| Figure 6.9. Slow photo stream questions. | 171 |
| Figure 6.10. Remote presence questions. | 172 |
| Figure 6.11. Examples of relationship maintenance..... | 174 |
| Figure 6.12. Examples of relationship maintenance | 174 |
| Figure 6.13. Examples of crowded communication | 175 |
| Figure 6.14. Examples of heavy inking | 176 |
| Figure 6.15. Situated inking: framing the scene..... | 176 |

| | |
|---|-----|
| Figure 6.16. Bedtime questions | 179 |
| Figure 6.17. Relationship questions | 180 |
| Figure 7.1. Analogue prototype of the paper-like response | 191 |
| Figure 7.2. Paper-like display algorithm running on a secondary desktop screen..... | 193 |
| Figure 0.1. Philips Hue LLC010 gamut points | 227 |
| Figure 0.2. Requested vs final point distance distribution | 227 |
| Figure 0.3. Requested vs final point distance by colour requested. | 228 |
| Figure 0.4. Philips Hue stabilization time. | 229 |
| Figure 0.5. Details of gamut corners requested-final point mappings. | 230 |

Chapter 1. Introduction¹

It is truth universally acknowledged, that today, displays are almost everywhere. In the streets, under water, in space, homes, schools and offices; in your pockets and perhaps also on your wrists. Chances are you are reading this on one. Moreover, based on the trends in the past hundred years, we will only keep adding more and more displays to our environment.



Figure 1.1. The number of displays in our environment is growing.

Unfortunately, our attention as human beings is finite and limited [1], and when something grabs our attention, we need to interrupt our activity to attend to it, and then spend extra time re-establishing the previous context and thoughts [2]. Displays in particular seem to be especially culpable in this regard, with some researchers arguing that displays are distracting and attention grabbing practically at any time [3].

A tempting solution might be to turn all the displays off. Ironically, that does not make them magically disappear from our environment, they only contaminate it with black rectangles instead (as in Figure 1.1). In public spaces where millions of displays are competing for our attention, turning them off might result in lower advertising revenue and public's perception of failure of the display owners leading to bad reputation [4]. In our personal spaces, it means disconnecting

¹ Parts of this thesis motivation and background were presented at Ubicomp doctoral colloquium [199] and UbiTention workshop [196].

ourselves from information, work, and entertainment, sometimes even friends and families. Can we do better? Is there a third option beyond having displays either on or off?

Displays have become ubiquitous in quantity but not in quality.

1.1 The Calm Technology

In his *COMPUTER FOR 21ST CENTURY* article [5], Mark Weiser presents his vision of invisible computing, which he called ubiquitous computing, in which the computers themselves vanish into the background. He talked about hundreds of computers in a room being used unconsciously to accomplish everyday tasks. Although his vision was about interaction and everyday use, he suggested several technical goals needed to be achieved to realise: “*cheap, low-power computers that include equally convenient displays, a network that ties them all together, and software systems implementing ubiquitous applications*”. [5, p. 100]

In his later article, *DESIGNING CALM TECHNOLOGY*, Weiser and Seely Brown further expanded on human oriented aspects of the technology, introducing the notion of calm technology. “*A calm technology will move easily from the periphery of our attention, to the center, and back*” [6]. *Periphery* here means what we are attuned to without attending explicitly, and calm technology enables the periphery to be informing without overburdening [6]. In a household, a calendar on a wall would be an example of calm technology. It stays in the periphery where it can be ignored by the user, while providing information at a glance. Any user can easily put it in the foreground of their attention and start interacting with it. By contrast a digital picture frame would be an example of technology that is not calm, because it is not able to move to the periphery. It is a glowing display, that does not blend into the environment and cannot be easily ignored by the user, as has been already reported in previous work [7].

Making technology calm was once viewed as a prerequisite to fulfilling Weiser’s grand vision of “computing everywhere”. Several years later, researchers in the field started to express concerns about Weiser’s notion of calmness. Rogers [8] suggested that people do not want calm technologies, and proposed new agenda of engaging experiences instead. Bell and Dourish argued in 2007 that Weiser’s vision can never come true, mainly because it carries unattainable assumptions about the underlying infrastructures of such technologies [9]. Abowd on the other hand argued in 2012 that we have already reached this vision and it’s time to move on [10]. The research, I would argue, has indeed moved on. Researchers keep coming up with new applications,

experiences and form factors, and the ubiquity agenda has mostly transformed into sensing users and inferring their behaviour and needs.

Recently, calm technology as described by Weiser – or more precisely the ‘disappearing’ part of it – has come back into focus for several researchers. Brown’s Anthropology Based Computing [1] and Bakker’s Peripheral Interaction [11] base their research and designs on psychological models of attention and peripheral information processing. Amber Case has given numerous talks and has organized a workshop on designing calm technologies; disseminating Weiser’s ideas to general public and industry as well as to the academic community.²

Weiser and Seely Brown have, in fact, specified three signs of calm technology [6]:

1. easily moves from centre to periphery and back;
2. enhances peripheral reach (brings more details into the periphery);
3. locatedness (tunes into what is happening, has just happened and will happen).

Both academic research and commercial solutions have come up with many types and forms of content that address the peripheral reach and locatedness. However, moving into the periphery of attention or the environment (the ‘disappearing’) remains a challenge. Three ways to measure calmness have been proposed in the literature so far: a radar chart by Riekki et al. [12], CALMatrix by Brown et al. [13], and a Goal-Question-Metric method by Carvalho et al. [14]. Riekki evaluates availability, timing and interaction, Brown the cognitive load of tasks and Carvalho timing, necessity and relevancy of interruptions, focusing mostly on technology in the form of applications. Specially, whether the technology as a physical artefact is capable of blending into the environment or not does not affect any of the existing metrics of calm technology, despite the fact that avoiding displays is one of Case’s main principles of designing calm technology [3].

Indeed, as we discussed above, while new display technologies continue to be invented, the user interaction paradigm has changed little since the first displays emerged: users have to deal with either glowing screens or pieces of black surface. Most mobile displays can be quite unpleasant to use, if not dazzling, at night, as they are rarely optimized for viewing under such conditions. [15] When a TV is switched off, it doesn’t magically disappear from the room. These properties of

² She also maintains <http://calmtech.com/> website hosting the original papers of Weiser & Seely Brown and transforming their ideas into new product designs.

displays are now so expected (and tolerated) that researchers deploying devices to domestic environments don't even consider it worth mentioning in their publications.

The aim of this thesis is to challenge the idea that displays can't be calm and explore what happens when they become calm.

1.2 Research Questions

Although displays might seem ubiquitous nowadays, there are places where they are rarely found. For example, many people find it uncomfortable to have always-on, emitting displays in their bedrooms. Yet, people value and place printed digital photos in their bedrooms [16]. In theatres and cinemas, people are annoyed by glowing screens from mobile phones, yet the ability for audience to interactively participate in the shows has been sought for decades [17]. In churches, using modern technologies might seem inappropriate. Yet technology has the power to attract young and connect contemporary issues with historical embodiments [18].

Even in more traditional environments, displays recently started to be used as decorative elements replacing traditional artwork (for a simple example, see Figure 1.2). As a personal project, Clay Bavor created digital “canvas”, basically an iMac display hidden behind a wooden frame [19]; as a commercial product, in 2019 Samsung launched The Frame with an Art Mode, a quantum dot TV with customizable frame³. They both use brightness sensors to adjust the display's brightness.



Figure 1.2. Public displays in Sprinkles Gelato. Bristol, UK (2019, photo by author).

On the other hand, programmable or user adjustable colourful lighting is also becoming popular. The ‘smart’ lights market is predicted to grow from \$13.4 billion in 2020 to \$30.6 billion by 2025

³ <http://www.samsung.com/us/televisions-home-theater/tvs/the-frame/art-mode/>

[20]. As a consequence, home environments are being filled with unprecedented, extremely chromatic colours and simple brightness adaptation can no longer hide displays in the environment.



Figure 1.3. Bedroom with Philips Hue lighting. Note the frames on the wall (posted on reddit.com⁴ in 2019).

Hopefully this thesis offers a solution for these very dark and/or very chromatic conditions, allowing displays to become natural, non-distracting parts of both home and work environments, enabling new applications and experiences in places where display presence is currently challenging, if not inappropriate.

The research questions are therefore stated as follows:

- How can we make current displays calm, blend naturally into the environment, but stay useful and valuable when not used?
- Can we make displays just as unobtrusive as paper or other physical materials, yet retain their information flow qualities and interactivity?
- How do humans perceive colour differences between emissive and reflective surfaces, and under non-standard lighting conditions?
- What new applications and experiences can such displays bring to us?

⁴ <http://www.reddit.com/r/philipshue/comments/cdsny5/>

1.3 Contributions

The main contributions of the work presented in this thesis include:

1. a series of cross-media colour matching experiments under extremely chromatic conditions,
 - a. demonstrating higher sensitivity of observers to colour differences for less saturated colours than for highly chromatic colours (chapter 4.4.2),
 - b. establishing the discrimination thresholds for colour differences between emissive and reflective media (4.4.4),
 - c. demonstrating higher sensitivity of observers to changes in hue than to changes in chroma (4.4.5) and the role of luminance in compensating for the differences (4.4.6),
 - d. showing that human observers can perform good matches under extremely chromatic illumination without complete adaptation (4.4.7);
2. an algorithm that allows any emissive display to match a reflective surface in colour and brightness using a built-in or an off-the-shelf RGB sensor,
 - a. enabling the use of display technologies in challenging spaces that traditionally avoid emissive screens (5.7),
 - b. demonstrating that existing emissive displays can already become inobtrusive and part of the calm technology vision and designs (5.9.1);
3. a system for connecting bedrooms of long-distance couples based on long-term autobiographical design (ABD),
 - a. expanding the emerging literature documenting ABD methods, with unprecedented, recorded history from the origin to the end of the system (6.2),
 - b. exploring the bedroom as an environment for interactive technology, showing that systems with full-featured display and touch interfaces can become invisible and desirable in bedrooms (6.4.4.1),
 - c. evaluating a slow photo-stream as a method to balance privacy and remote presence, showing that it can achieve the qualities of previous always-on video channels (6.4.4.2),
 - d. introducing collaborative drawing experience in home environment for everyday communication with novel paradigms of interaction (6.4.4.3),
 - e. allowing to share bedtime, falling asleep and waking up, showing that partners value spending this time together (6.4.4.4).

A brief overview of the bedroom environment in terms of lighting conditions that technology designers might need to consider is presented (5.8.1), and the work also includes technical recommendations for building paper-like displays (5.5.1, 5.9.3), for researchers employing ABD (6.5.1), and system designers considering incorporating the new communication features (6.5.2).

1.4 Thesis Structure

Chapter 2 contains an introduction to colour science for readers less familiar with the field, how we currently understand light and colour perception, as well as a description of all colour spaces used throughout the thesis.

Chapter 3 is a technical chapter describing the principles of sensing and displaying light and colour using current technology, as well as introducing all materials and equipment used throughout the thesis.

Chapter 4, Chapter 5 and Chapter 6 are the core contributions of this thesis. Since the presented studies are from different scientific fields, existing literature and related work is reviewed in the individual chapters.

In Chapter 4, a visual psychophysical experiment is designed and described that seeks answers about human colour vision in the cross-media scenario of matching display and paper under various chromatic conditions. Results from this study contribute to the current knowledge and problems in colour vision and also provide us with data that can be used for evaluating a computer algorithm performing the same matching task.

Chapter 5 proposes a paper-like display algorithm – an algorithm that uses an off-the-shelf colour sensor to make a common LCD screen mimic a sheet of paper. The algorithm is evaluated both quantitatively and qualitatively in a two-week A/B field study.

Chapter 6 demonstrates a practical application that paper-like displays enable in the bedroom environment, in this case connecting partners in a long-distance relationship during bedtime. The system is designed using an autobiographical design method and then evaluated in four-week field deployment into remote partners' bedroom.

Finally, Chapter 7 summarizes the most important findings from the studies described above and offers some possible directions for future research in calm displays and calm technologies in general.

Chapter 2. Introduction to Colorimetry

In order to be able to sense the environment and to manipulate a display so that it looks convincing to users, we need to have a basic understanding of human perception of light and colours. Such understanding would also allow us to compare and evaluate the performance of various systems involving human vision.

As we will see in this chapter, colours and colour spaces have been subjects of great interest of study for hundreds of years. Nowadays, colorimetry and colour space standards are managed by the International Commission on Illumination (CIE⁵), using models and metrics under very strict lighting and viewing conditions – conditions that are less and less applicable in contemporary home environments as already suggested in the introduction.

This chapter gives a short introduction into colorimetry and human vision, reviews the past work on colour-matching experiments and describes the colour spaces that are used in this thesis. Many colour spaces have been defined in the past and new ones are still being invented; even limiting ourselves to the basic ones used in this work leaves us with a considerable amount of spaces: RGB for displays, CMYK for materials printed on paper, CIELAB for approximately uniform human perceptual colour matching, RAL based on it for standardised paper colours, DKL for physiological insights into the results, CIELUV for the display algorithm, and XYZ connecting them all together.

2.1 Light

Until the 19th century, most of the theories suggested that light was composed of particles, an idea also supported by Newton in his *OPTICKS* treatise in 1704 [21], despite some of the known phenomena, such as diffraction and refraction, being unexplainable by particles and giving birth to a few wave theories of light before [22]. It wasn't until J.C. Maxwell – following the work of Michael Faraday – published his famous paper in 1865 [23], and Heinrich Hertz confirming his theory with experiments, that light has been accepted to be a form of electromagnetic radiation; the same radiation that powers radio or microwaves, as Hertz later discovered.

One of the fundamental properties of a wave is its frequency of oscillation, and electromagnetic waves of all frequencies form the *electromagnetic spectrum*. In colorimetry, it is customary to

⁵ Commission Internationale de l'Eclairage

measure waves by their wavelength λ instead, i.e. the distance they travel in one second in vacuum,

$$\lambda = \frac{c}{f}, \quad (2.1)$$

where f is the wave frequency in Hz, and c the speed of light in vacuum, 299 792 458 m/s.

We can measure the radiant energy of the electromagnetic radiation emitted or reflected per unit time (*radiant flux*) per unit solid angle (*radiant intensity*) per unit projected area, called the *radiance*, in $\frac{W}{sr \cdot m^2}$. If we take the radiance per unit frequency or wavelength, we get the *spectral radiance*. An example of a typical spectral radiance of daylight can be seen on Figure 2.1.

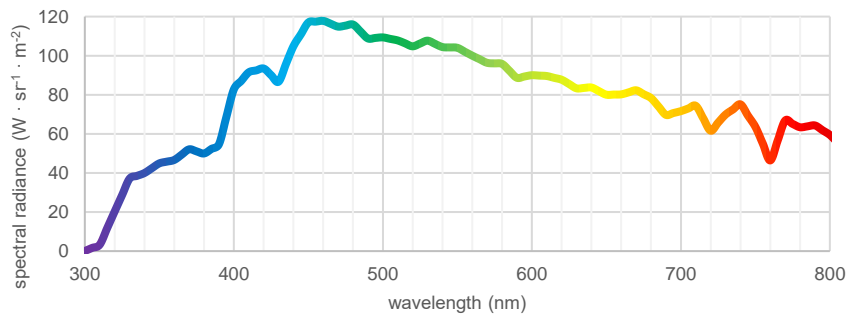

Figure 2.1. Spectral power distribution of the CIE standard illuminant D65. Data from [24].

2.1.1 Blackbody

Imagine now a physical body that absorbs all electromagnetic radiation, regardless of frequency or angle of incidence, while keeping a constant temperature. Such body is called the *blackbody*, and in order to stay in thermal equilibrium, it must emit radiation at the same rate it absorbs it. Following the equations of Maxwell, Rayleigh derived⁶ the radiated energy as a function of wavelength, i.e. the spectral radiance as what we now call the Rayleigh-Jeans law,

$$R(\lambda, T) = 2 \frac{c}{\lambda^4} kT, \quad (2.2)$$

where c is the speed of light in vacuum, λ the wavelength, k the Boltzmann constant and T is the constant temperature of the black body in kelvins. However, while the Rayleigh-Jeans law fits the experimental measurements of low frequency radiations, it suggests that as the wavelength gets shorter and shorter, the emitted energy should approach infinity, a consequence whose significance was pointed out by Albert Einstein in 1905, and what has become known as the

⁶ Interested reader can find the derivation of Rayleigh-Jeans law e.g. in [21, p. 311] or at [HyperPhysics](#).

*ultraviolet catastrophe*⁷. Einstein, independently with Max Planck, concluded that the radiation energy must be quantized, commencing the field of quantum physics [25]. Planck basically guessed (and Einstein later proved) the correct formula for blackbody spectral radiance, which is

$$R(\lambda, T) = 2h \frac{c^2}{\lambda^5} \cdot \frac{1}{e^{\frac{hc}{\lambda kT}} - 1}, \quad (2.3)$$

with symbols as above and h being the Planck constant. The light quanta have later become known as *photons*. The fact that light exhibits properties of waves as well as of particles is known as the wave-particle *duality of light*. As traditionally put, light behaves as a wave when it propagates and like a particle when it is detected, but in fact both properties co-exist simultaneously, as can be demonstrated experimentally [26]. For more detailed information on various light behaviours, see e.g. [27].

The concept of blackbody is important in colorimetry because the radiation from the Sun, the largest source of light in nature that has been around for millions of years of evolution, is well approximated by the blackbody radiation described above, and so is the thermal radiation of many everyday objects (all matter with temperatures above absolute zero emits spontaneous electromagnetic radiation⁸). As objects heat up and reach temperatures around 800 K (500 °C), the emitted radiation becomes visible as light – first of red colour, and as the temperature increases further, it reaches white around 6500 K and becomes blue thereafter, as one can experience when observing a fire. The effective temperature of Sun’s photosphere is 5778.22 K [28]; see $R(\lambda)$ of selected temperatures in Figure 2.2.

⁷ Term first used by Paul Ehrenfest [4, p. 52]. Other discrepancies arose in explaining the photoelectric effect.

⁸ More precisely, all baryonic matter, which includes all matter composed of atoms but excludes e.g. electrons.

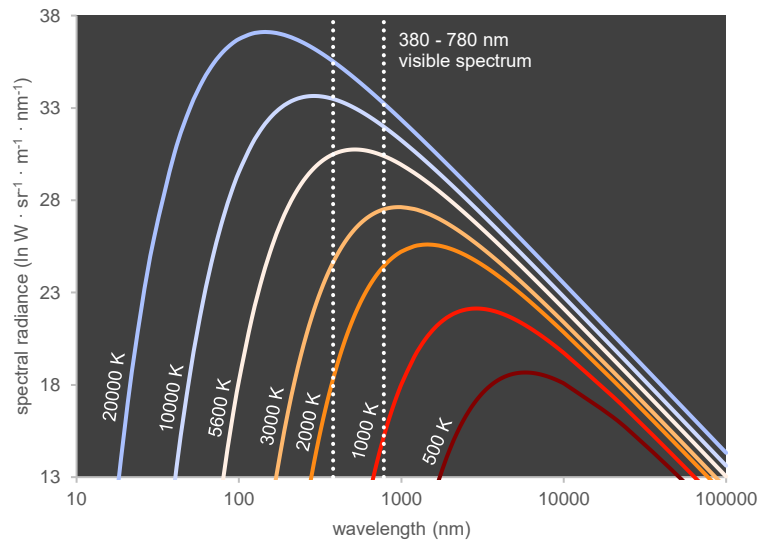

Figure 2.2. Blackbody radiation for selected temperatures.

The range of all colours that can be produced by blackbody radiation is called the *Planckian locus*. We define the *colour temperature* of a light source to be the temperature of a blackbody radiating light of the same perceived colour. Such definition is only meaningful for colours exactly on the Planckian locus; to account for other colours we can also define the *correlated colour temperature* (CCT), as a temperature of a blackbody whose perceived colour is ‘nearest’ to the given stimulus. The meaning of ‘nearest’ is non-trivial and will be explained later in chapter 2.6.1. It bears noting though, that even the concept of CCT is not recommended to be used for colours that are ‘too far’ from the Planckian locus [29, p. 67], as ambiguities could appear.

2.1.2 Sources of light

As electromagnetic radiation, light is always caused by an accelerating electric charge. There are primary sources of lights that create the light they emit (such as lightning), and there are secondary sources of light that reflect, or diffuse light received from a primary source (such as a banana).

Primary light sources can be divided into incandescent, where light is caused by a thermal radiation as discussed above (i.e. blackbody, candle, lightbulb etc.), and into luminescent, where light is emitted by different means unrelated to heat (for example gas discharge lamps, lasers, phosphorescence etc.). In this work, we are only concerned with daylight, which is modelled by the blackbody radiation, and light emitted by light-emitting diodes (LED), which are used in artificial lights as well as emissive displays, and will be described later in chapter 3.3. A brief overview of

other most common light sources can be found e.g. in [30], detailed physical and chemical background of sources of colour and light are available in a classic text by Kurt Nassau [31].

We have seen how light – an electromagnetic radiation – is characterized by the spectrum radiance, i.e. the amount of energy as a function of wavelength. When light falls on a surface, some of the light gets reflected, turning the surface into a secondary light source. Different surfaces reflect light in different ways, and one of the characteristics we are interested in is the spectral reflectance, i.e. the relative amount of energy that gets reflected by a surface as a function of wavelength. A typical spectral reflectance of a banana is depicted on Figure 2.3 left.

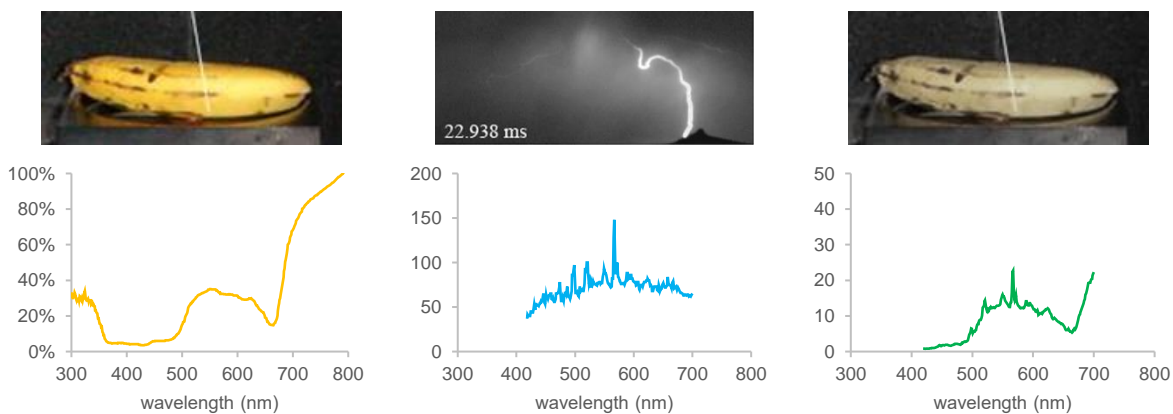

Figure 2.3. Light reflected from a surface. Left: an example of spectral reflectance of a surface (banana). Photo and data from [32]. Centre: an example of spectral radiance of a primary source (lightning). Photo and data from [33]. Right: spectral radiance of reflected light is a multiplication of the previous two.

To get the spectral radiance of reflected light $R(\lambda)$, i.e. how a banana looks like under lightning, the irradiance of the light $I(\lambda)$ needs to be pointwise multiplied by the reflectance of the banana $S(\lambda)$:

$$R(\lambda) = S(\lambda) \cdot I(\lambda). \quad (2.4)$$

2.1.3 Standard illuminants

It is clear now that even for reflecting surfaces, the final spectral radiance directly depends on the light source and its spectrum, and that when we need to reproduce a stimulus of a particular surface, we need to be able to reproduce the light source too. Theoretical light sources defined by their relative spectral radiance only (i.e. not absolute energy values) are called *illuminants*. CIE now defines two standard illuminants, CIE standard illuminant A and CIE standard illuminant D65.

CIE standard illuminant A is intended to represent typical, domestic, tungsten-filament lighting. Its relative spectral radiance is that of a blackbody radiator at a temperature of approximately 2 856 K. It should be used in all applications involving the use of incandescent lighting.

CIE standard illuminant D65 is intended to represent average daylight and has a correlated colour temperature of approximately 6500 K. It should be used in all applications requiring representative daylight, although variations in the relative spectral radiance depending on season, time of day and geographical locations are known. In 2008, CIE also defined an indoor version of D65, the ID65, which is filtered by the transmission of window glass [30, p. 95].

While illuminant A is defined analytically using Planck's law (2.3), the D65 illuminant is tabulated in the standard [34]. Introduction to other non-standard illuminants can be found in [29, p. 38]. In all our experiments and for the rest of the thesis, we will be using the D65 illuminant as our reference source of light. Its relative spectral radiance can be seen on Figure 2.1.

2.2 Human Eye

Light enters the human eye through a pupil, surrounded by iris, and a lens, that projects it onto the retina (see Figure 2.4). The retina consists of nerves and several layers of various cells, most importantly the photosensitive rods and cones, which are in the layer furthest away from the light entrance, and several features of interest, such as the blind spot where the nerves exit the eye, or macula lutea (also known as yellow spot) containing the fovea⁹ responsible for sharp colour vision with the highest density of cones.

⁹ In this work, fovea refers to fovea centralis, containing foveola in its centre.

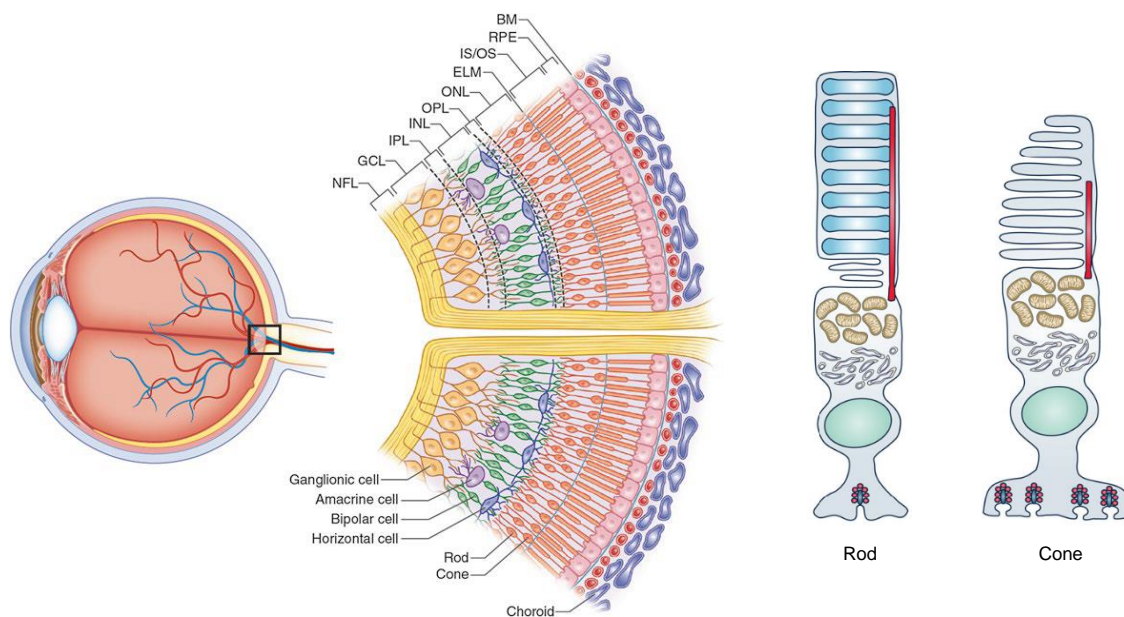

Figure 2.4. Physiology of the human eye. Left: overview of the eye and layers of retina. Right: photoreceptors. Reprinted by permission from Springer Nature Customer Service Centre GmbH: Springer Nature [Hydroxychloroquine and Chloroquine Retinopathy](#) by David J. Browning © 2014. Photoreceptors adapted from [35], © 2016 The Authors. The Journal of Physiology.

There are two types of photosensitive cells (photoreceptors), rods and cones, named by the shape of their outer segments. Rods are typically two to three magnitudes more sensitive than cones and can signal the absorption of a single photon [36]. They are a later evolutionary development from cones, used for vision under very low light (*scotopic vision*) [35]. All rods have the same spectral sensitivity function, peaking around 504 nm (see the spectral sensitivity plot on Figure 2.5), therefore they can provide only achromatic vision. There are about 80-120 million rods in each eye, but none in the fovea [37, p. 103, 38, p. 87, 39].

Cones require more light to activate, but they are also faster to adapt to changes and hence provide better temporal resolution and movement detection. They are used under bright, daily conditions (*photopic vision*). Most importantly, people with normal vision have cones with three types of pigments, each pigment responding to different wavelengths differently. We call such vision *trichromatic* and the people *trichromats*. The *S-cones* are most sensitive to short wavelengths, peaking around 445 nm, the *M-cones* in the middle peaking around 543 nm and the *L-cones*'s sensitivity reaching the longest wavelengths, with a peak around 566 nm [40, p. 327] (see their relative spectral sensitivities¹⁰ on Figure 2.5).

¹⁰ Although often referred to as spectral sensitivities, they are in fact not sensitivities in any physiological sense. These functions have been derived from colour matching experiments, see [41, 42] for details. *Cone fundamentals* (or matching functions) is a more accurate name.

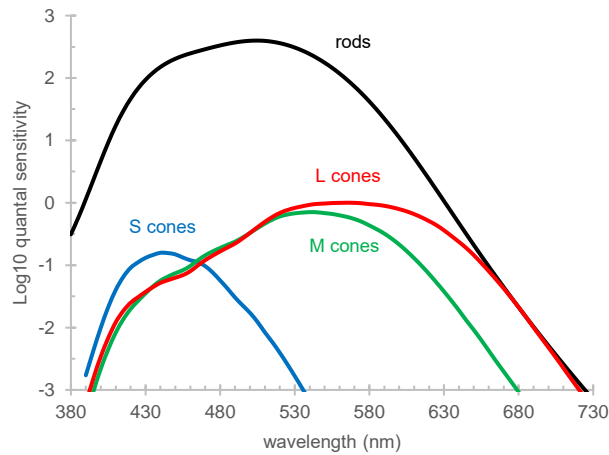

Figure 2.5. Rods and cones fundamentals. Data from cvrl.org.¹¹

There are about 4-7 millions cones in an eye [37, 38, p. 88], but they are not distributed uniformly. The mean ratio of L to M cones is 2:1 [41], and only about 7 % of the total number of cones are S-cones (their density is never higher than 12 %). Moreover, S-cones are missing from the very centre of fovea [42, p. 614], the *foveola*.

At this point, we can define *visible light*, based on the spectral sensitivities of human photoreceptors. CIE sets the visible range of electromagnetic waves to 380 nm to 780 nm. Children and young people can see wavelengths at least as short as 310 nm, but as the eye ages, the violet response decreases as the internal lens yellows. Shorter wavelengths (ultraviolet) are absorbed by the cornea and lens [43, p. 231]. It has also been shown that the human eye can see wavelengths at least as long as 1064 nm [44, p. 341]. Longer wavelengths (infrared) are invisible because the photons don't have sufficient energy to cause a molecular change in the photoreceptors.

The most acute spatial and colour vision comes from the fovea, about 1.5 mm wide area in macula, a pigmented area near the centre of the retina. The acuity is achieved in several ways:

- a) it forms a depression in the retinal surface, shifting most of the retina layers to the sides, so that the light hits photoreceptors directly (see Figure 2.6 left);
- b) it contains the highest density of cones (~200 000 cones/mm² on average [37]) that are, unlike elsewhere, as thin as rods (see Figure 2.6 bottom right);

¹¹ Relative levels are based on Dr. Stockman's educated guess (private communication).

- c) it contains the highest ratio of ganglion cells per each cone that connect them to the nervous system, 2:1 to at least 1° of the field of vision and 1:1 out to 5° , while the ratio reaches 1:2 at 10° and drops up to 1:20 at 50° of eccentricity [45, p. 9]¹².

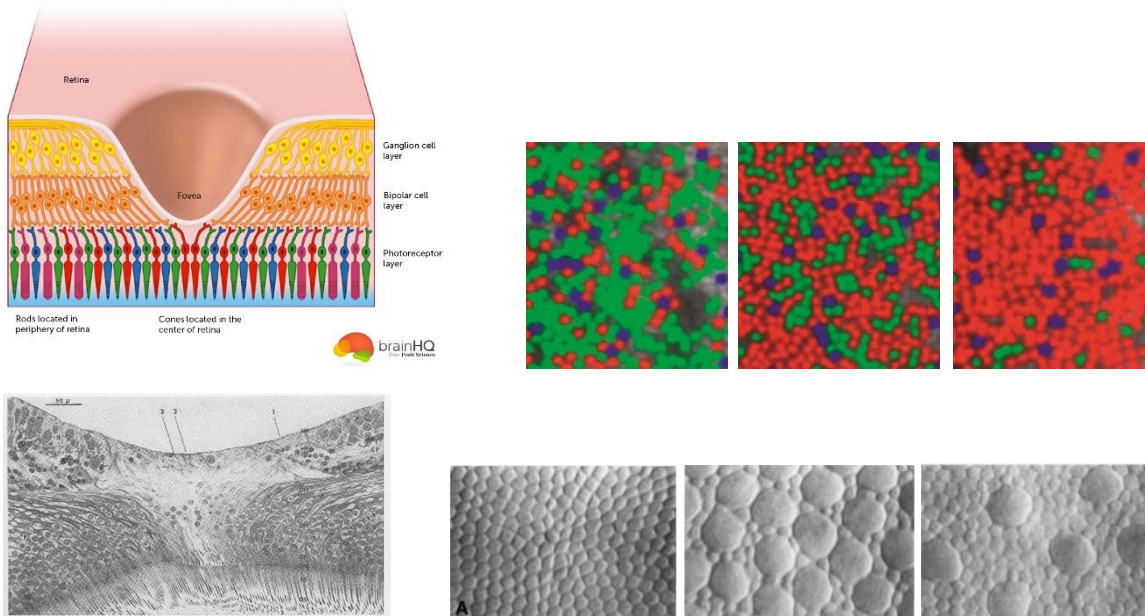

Figure 2.6. Fovea and distribution of photoreceptors. Left: Human fovea overview and section through its centre (reprinted from [46, p. 153]). Top right: Cone patterns in retina from 3 different subjects (adapted from [47, p. 32]). Bottom right: Photoreceptors patterns at different locations in retina (a) small cones only in the centre of fovea (b) 1.35m from the centre and (c) 8mm from the centre, large cones and small rods (adapted from [37, p. 502]).

In the context of this work, there are three important aspects of the foveal area. First, it is important to note that the distribution of cones and rods and their counts as well as ratios in the eye vary significantly between individuals (see Figure 2.6 top right) [37, 42, 46]. Second, the size of the high acuity foveal area needs to be considered. The whole macula covers 17° of the view, the fovea covers 5.2° and the very centre around 1° (see Figure 2.7 left). Strasburger et al. refers to *foveal vision* as that below 2° eccentricity and *peripheral vision* for anything outside 2° eccentricity [48, p. 3]. Finally, as we noted above, the macula is a pigmented area. The spectral density of the pigment is shown on Figure 2.7 right, peaking at 460 nm, and most notably reducing the sensitivity of the macular region to the short wavelengths (blue light). It is believed that this mechanism minimises the chromatic aberration, further contributing to the acuity of the vision in this area. Again, the density of the pigment varies significantly between individuals and it is also connected with the iris colour [49].

¹² And private communication with Dr. Curcio.

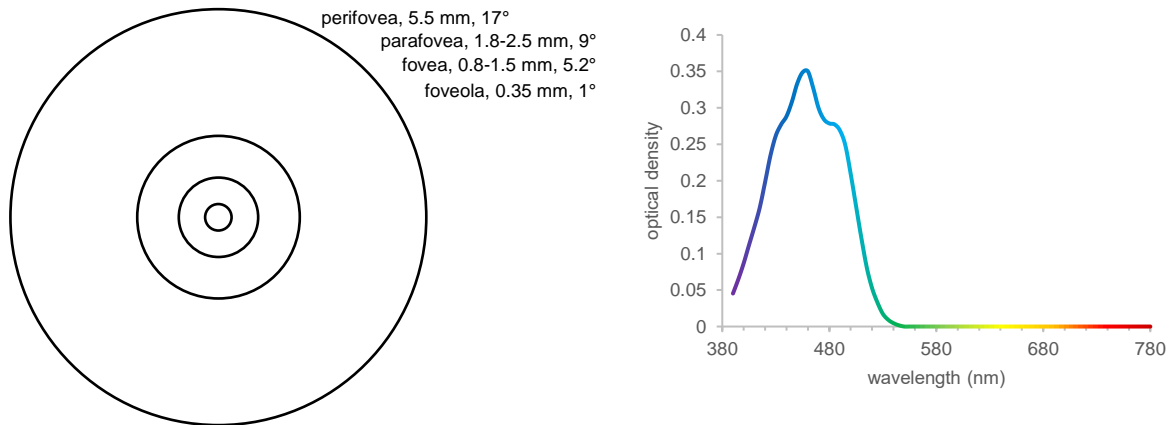

Figure 2.7. Macula regions and density. Left: macula regions 1:1, based on [48, p. 3]. Right: macula pigment density, data from cvrl.org.

2.3 Early colour matching experiments

The cone fundamentals as presented in the previous chapter were not obtained until the end of the 20th century using colour matching experiments of observers with colour vision deficiencies (i.e. having various types of cones not working) by Stockman et al. [50, 51]. In 1802, Thomas Young first proposed that colour is perceived through three primary colour sensors, more or less excited by wavelengths around their peak sensitivity [52, p. 21], and together with Hermann Helmholtz later suggested that these primaries are red, green and violet [53, p. 291].

Maxwell was the first one suggesting the primaries are red, green and blue [54, p. 74] in 1860 and the first one who plotted the colour spectrum on a triangle, claiming all other colours can be achieved as a linear combination of any three points containing the colour in question. He invented an instrument in which observers would see, using one eye through a slit, a bipartite field showing sunlight reflected from a white paper, in one part of the field directly, in the other part as a mixture of three primaries¹³ as the light passed through adjustable slits and become recombined through prisms. An operator adjusts the slits following observer's call for more or less red, blue or green. When no difference between the two fields could be observed, the observer had to look away for some time to relieve the strain on the eye and look again.

Note that in this experiment, only a white colour was being matched, using different combinations of spectral colours. From the resulting set of linear equations, Maxwell could deduce the points of the spectral colours in respect to his primaries. Some of them turned out to have negative

¹³ He selected his primaries based on Fraunhofer's lines (i.e. visible intensity drops in the spectrum due to atmosphere) that had good separation and perceived low variance of colour, see [33, p. 69] for details.

coordinates being outside of the primaries triangle, but he explained there is no physical interpretation of such values. Maxwell reported on two participants, himself and his wife Katherine, and noticed differences in their vision of colours, which he attributed to the differences in macular pigment. He also performed the experiment with a colour-blind person.

Following Maxwell, few scientists tried to establish the cone fundamentals through matching experiments: Donders in 1881 [55], König with Dieterici in 1893 [56], and Abney in 1905 [57]. They used similar apparatus, additively mixing selected parts of the spectra with not very controlled light conditions – the light source was either direct sunlight or a gas lamp, they had different reference points and primaries and “utterly neglected the luminosity aspects of the problem” [58, p. 88, 59, p. 548]. All of them were the only trichromat participants of their studies, some including observations of one or two colour-blind people too.

Finally, Herbert Ives pointed out in 1915 that any set of three primaries can be easily transformed to another three primaries using matrix multiplication, and once the points of spectral colours are known in respect to one set of primaries, there are known for any other set of primaries [60]. He made some corrections to König’s data [61, p. 150] and later E.A. Weaver managed to bring König’s and Abney’s data to a common denominator by appropriate calculations [59, p. 548].

In *THE PRESENT STATUS OF VISUAL SCIENCE* of 1922, Leonard T. Troland, appointed by the Optical Society of America (OSA) as a chairman of the Colorimetry Committee calls for “careful and systematic redetermination of the three-color excitation curves for the normal eye” [58, p. 87].

In 1926, John Guild from the National Physical Laboratory (NPL) described the requirements, procedures and an instrument for colour matching experiments suitable for standardisation work, for the first time specifying a white light, with spectrum of blackbody radiation at a temperature of 5000 K [62, p. 117]¹⁴. His instrument, a “trichromatic colorimeter”, could match an emissive light coming from the source with another light source, as well as light reflected from an object’s surface. Knowing that any three primaries can be used to produce any colour, his primaries are obtained through Wratten filters¹⁵ (rather than mechanically blocking parts of diffracted spectrum) and mixed using a rotating prism. In order to match colours outside of the primaries’ triangle (see Figure 2.8), Guild described how the colour to be matched needs to be desaturated by some other

¹⁴ At that time, such a laboratory source was not available, and filtering lower temperature sources was specified.

¹⁵ Manufactured by Kodak, now licensed to Tiffen.

colour, and that regardless of what colours are chosen as primaries, there will always be colours outside the triangle. Simplified, when e.g. a very yellow light needs to be matched by combining red, green and blue lights, the blue light might need to be added to the yellow light instead, in order for a match to be possible using the red and green lights.

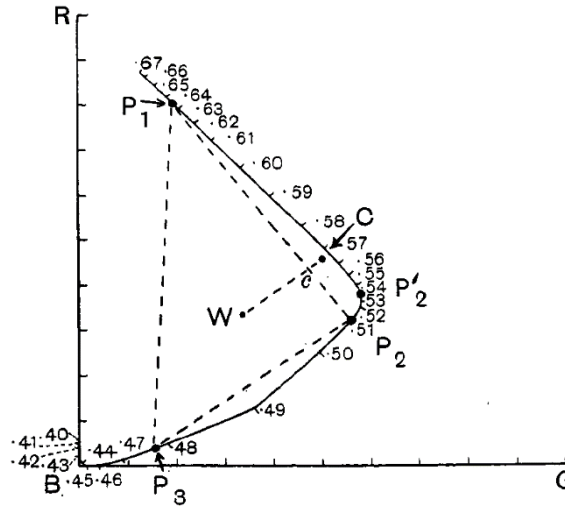

Figure 2.8. Spectral colours and 3 primaries as of 1926. P₁, P₂ and P₃ arbitrary, fully saturated primaries, W white, C the point to be matched, c the closest point to C that can be matched with the primaries directly, in fact by mixing P₁ and P₂ only. C needs to be matched by subtracting (i.e. desaturating) colour from the specimen. Reprinted from [62, p. 107].

In 1927-8, W. David Wright, a young student at Imperial College, received a grant for further colour vision research and came up with a colorimeter of his own, using spectral primaries (chosen to make the triangle as large as practically possible). He did a colour matching experiment with 10 unspecified observers, using a square field of view divided into two equal rectangles, subtending approximately 2° at the eye, to ensure only the fovea is involved in the colour matching, and matching the same white reference light, conditions in agreement with Guild's proposals [63].

It turned out that Guild had done his own colour matching experiment at the NPL in 1929, which he didn't publish because of the low number of observers involved. However, after Wright recalculated his results to Guild's primaries in 1930 [64], he was encouraged by the close agreement of the two datasets, despite using completely different instruments, to publish his results too. He had 7 observers (named in the paper), one of which was female [61].

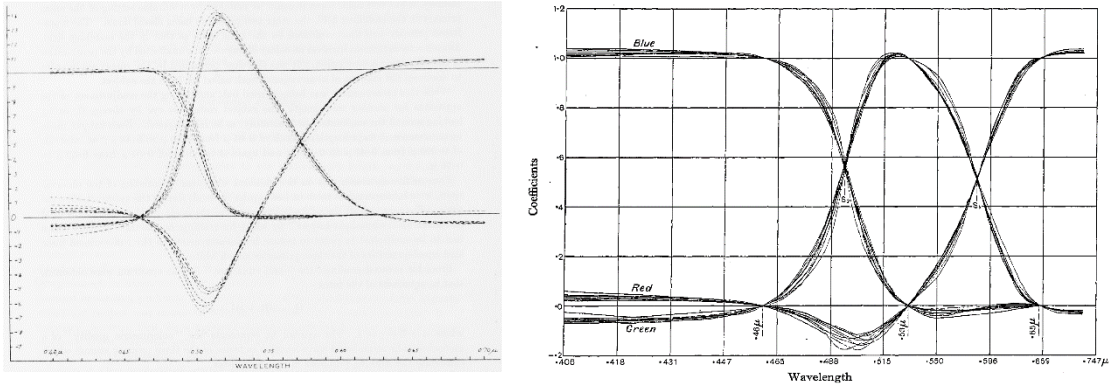

Figure 2.9. Colour matching results by Guild and Wright. The curves show the ratio of red, green and blue lights needed to match a spectral colour of given wavelength. Note 1) the variance between individual observers 2) the negative values, most notably of the red curve around 500 nm, meaning the red light had to be added to the spectral colour being matched. Reprinted from [61] and [65], respectively.

Individual matching results of the Guild & Wright observers can be seen on Figure 2.9. This was a great opportunity to standardise the “normal eye”, the *standard observer* as we know it today, since the CIE committee meeting was due very shortly, in 1931 (next meeting would be four years later). Unfortunately, we can cover only few of the many interesting events of the above history that are relevant to this work; interested readers are encouraged to read the thrilling story as recollected by Dr. Wright himself in 1981, e.g. in [29, pp. 9-23].

2.4 CIE XYZ Colour Space

The red, green and blue curves, in literature usually referred to as $\bar{r}(\lambda)$, $\bar{g}(\lambda)$, $\bar{b}(\lambda)$ *colour matching functions* (CMF) of 17 observers as determined by Guild and Wright experiments became the basis of the first standardized colour space in 1931. Guild argued for primaries that can be easily reproduced in a lab environment, but as we have seen above, that involves negative values for many colours, which was deemed unacceptable for commerce and industry at that time [29, p. 19]. As a compromise, Guild’s primaries were used to define the standard observer, however, a new coordinate system was then defined that transforms the visible tristimulus values into all-positive system. There were additional practical requirements on the transformation, which, together with the details of its derivation, can be found e.g. in [66]. The final transformation is as follows:

$$\begin{bmatrix} \bar{x}(\lambda) \\ \bar{y}(\lambda) \\ \bar{z}(\lambda) \end{bmatrix} = \begin{bmatrix} 0.49 & 0.31 & 0.20 \\ 0.17697 & 0.81240 & 0.01063 \\ 0.00 & 0.01 & 0.99 \end{bmatrix} \cdot \begin{bmatrix} \bar{r}(\lambda) \\ \bar{g}(\lambda) \\ \bar{b}(\lambda) \end{bmatrix}. \quad (2.5)$$

The transformed 1931 2° standard observer colour matching functions are plotted in Figure 2.10.

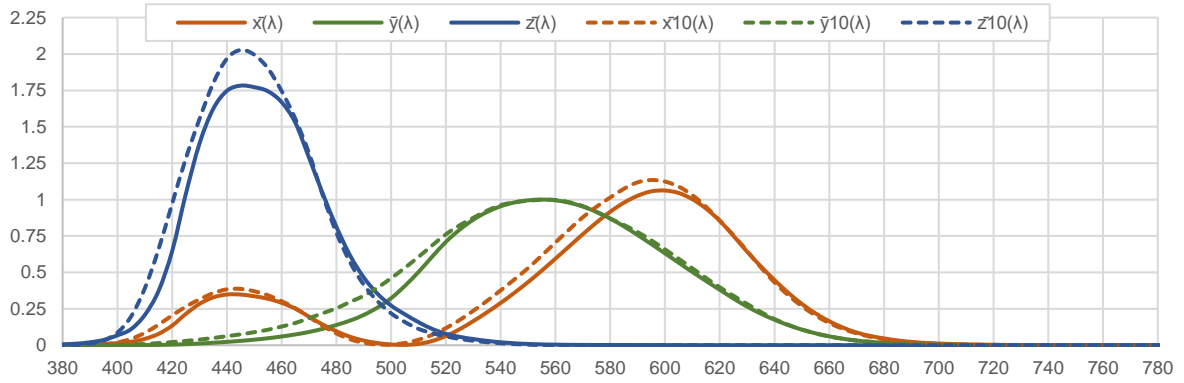

Figure 2.10. CIE 1931 2° XYZ (solid) and CIE 1964 10° XYZ (dashed) colour matching functions.

For any light with spectral irradiance $S(\lambda)$, we get the XYZ values by integrating point-wise multiplication with the colour matching functions:

$$\begin{aligned}
 X &= K_m \int_0^{\infty} S(\lambda) \cdot \bar{x}(\lambda) \, d\lambda \\
 Y &= K_m \int_0^{\infty} S(\lambda) \cdot \bar{y}(\lambda) \, d\lambda \\
 Z &= K_m \int_0^{\infty} S(\lambda) \cdot \bar{z}(\lambda) \, d\lambda,
 \end{aligned} \tag{2.6}$$

where $K_m = 683 \text{ lm/W}$ is the maximum value of the luminous efficacy of radiation¹⁶.

One of the other requirements imposed on the transformation is that one of the coordinates, Y , will be identical to what was then believed to be the spectral sensitivity of human perception of brightness, commonly denoted as $V(\lambda)$, standardized already in 1924. As a consequence, the two remaining coordinates carry all the chromatic information, which allows us to plot *chromaticity diagrams*. Taking

$$\begin{aligned}
 x &= \frac{X}{X + Y + Z} \\
 y &= \frac{Y}{X + Y + Z}
 \end{aligned} \tag{2.7}$$

we get the CIE 1931 xyY colour space with the chromaticity diagram depicted in Figure 2.11. Note that there is no black – the brightness is in the third dimension. It is also important to realize perceptual uniformness was not a goal for the XYZ transformation, and indeed the distances

¹⁶ It requires 1/683 Watts to produce one lumen of light at 555 nm, which is the wavelength to which the human eye is most sensitive.

between colours on Figure 2.11 do not represent the perceptual differences between them, see chapter Figure 2.25 for evaluation of this space on perceptual uniformness.

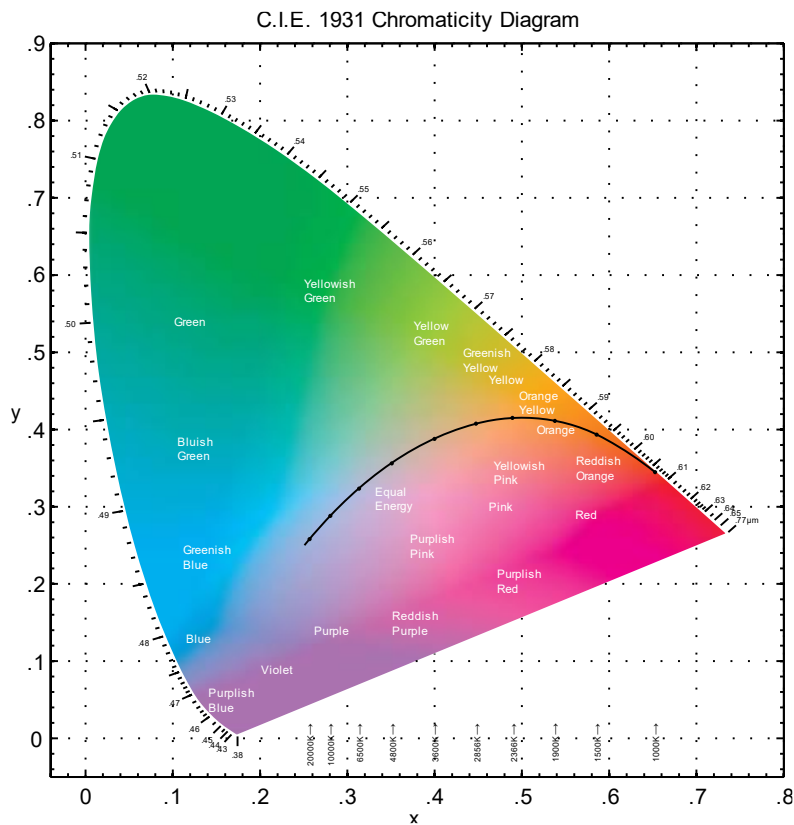

Figure 2.11. CIE 1931 xy chromaticity diagram. Spectral, i.e. monochromatic colours are at the boundary of the horseshoe, the colours of blackbody radiation are showed by the black curve inside. Colours outside of this area are imaginary and cannot be produced by any physical means. CC-BY-SA Paulschou at en.wikipedia.

The colour matching functions as standardised in 1931 were not without problems. In 1951, Judd reported that the standard observer seriously underestimates human sensitivity in the blue region below 460 nm and published new matching functions correcting for the error. In 1978, Vos suggested further corrections in the red to infrared region [67].

Motivated by doubts expressed by Judd and other discrepancies, the desire to have larger matching field than 2° and, importantly, the ability to measure the matching colours directly with the invention of spectroradiometer, W.S. Stiles set to undergo new set of colour matching experiments with around 50 observers [68]. After a pilot study with 10 participants in 1955, the CIE deemed the 2° data to be insufficiently different to justify changes in the standard. Nonetheless, the 10° data differed sufficiently to motivate further investigation [69].

Stiles published results of 49 observers (15 females) in 1959 [70], from which, partly together with data of 27 observers (23 females) of Sveranskaya [71], the CIE established the *CIE 1964 standard*

colorimetric observer subtending 10° field of view¹⁷. The colour matching functions of the 10° observer can be seen in Figure 2.10. Again, the individual differences are quite significant, see Figure 2.12.

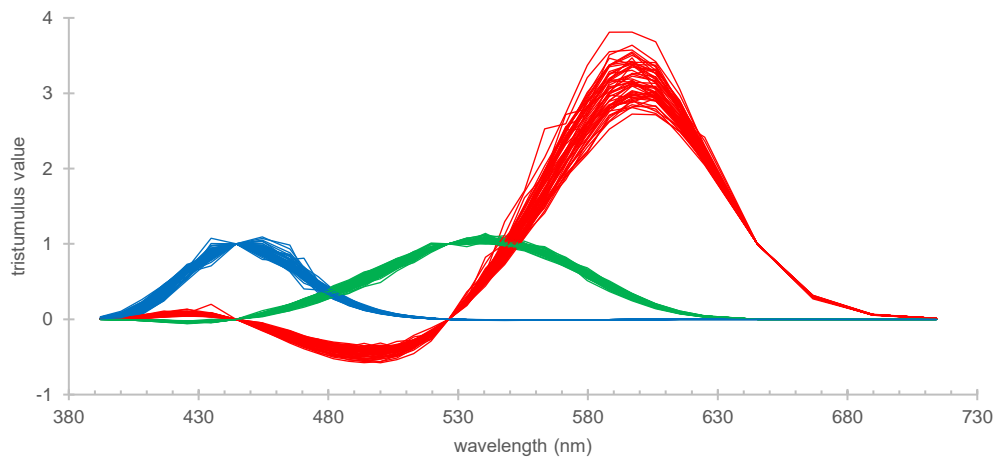

Figure 2.12. Stiles & Burch individual 10° colour matching functions. Corrected by Stockman, data from cvrl.org.

Recently, Stockman & Sharpe have derived physiologically relevant matching functions, based on the spectral sensitivities of L, M and S cones [72, 73]. Based on the Stiles 10° data only¹⁸, the authors were able to separate the L and M cones with further matching experiments with observers with colour vision deficiencies, and with known genotypes¹⁹. CIE endorsed the functions as *CIE physiologically-relevant LMS fundamental colour matching functions* in 2006 and ratified them as standard in June 2019.

XYZ is an essential imaginary colour space through which all other colour spaces are derived. It was constructed as a practical transformation of colour matching functions (of which there are many derivations), integrating light stimuli over the visible range of visible spectrum. Despite the colour matching functions of 1931 and 1964 being outdated and inept for any modern colorimetric work, they nevertheless remain very popular in the industry [74, p. 18]. However, recent technology advances and explorations of more monochromatic light sources for consumer products

¹⁷ Both Stiles and Sveranskaya actually either disregarded or blocked the central $1-2^\circ$ of view, so the macular density will be underestimated in the 10° CMF [69, p. 2504].

¹⁸ Even for 2° CMFs — Stiles' 2° data using only 10 participants would unlikely cover the individual variability [50, p. 1714]. The experimental data of Sveranskaya are believed to be polluted by rod sensations as the experiment has been carried out at low intensities [69, p. 2511], and rendered the CIE 1964 CMF unfit.

¹⁹ Each human cone pigment is encoded by a separate gene, and different variations of pigments exists among observers (most notably alanin- and serin-coded variants of L cone pigment). Colour blind observers can only provide insights into normal vision if their pigment corresponds to those of normal vision. The genotype of observers in previous studies was unknown. For more details, see e.g. [70].

(e.g. quantum dots, laser displays, etc.) are rendering limits of these functions beyond acceptable even in the commercial sector, see e.g. ISSUES IN COLOR MATCHING at the SMPTE conference in 2012 [75].

2.5 Additive Colour Spaces for Emissive Mediums (RGB)

All emissive sources of light, such as monitors, TVs or LCDs use additive colour mixing in the same way as we have described for the colour matching experiments above. When all primaries, usually red, green and blue, are combined, they create white (see Figure 2.13), when none of them is active, there is no light and the source remains black. Rather than mixing the lights directly over each other, screens use grids of small pixels ideally so small that the human vision cannot distinguish them, and the light is “mixed” at the retina. A few examples of common pixel arrangements are shown in Figure 2.14.

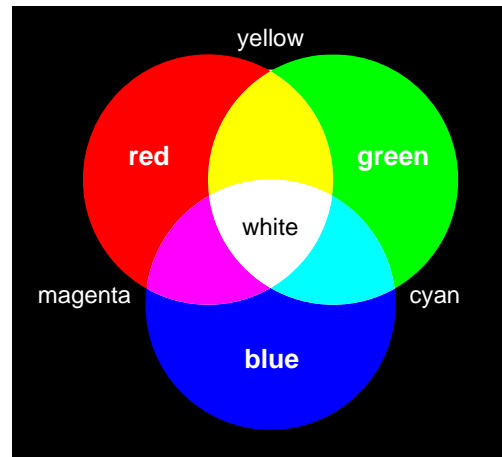

Figure 2.13. Additive colour mixing



Figure 2.14. Photos of a typical pixel grids. TV (left), CRT screen (middle) and LCD (right). Adapted from [76], photo CC-BY Girish Dalvi.

2.5.1 Gamut

The range of colours a device can display, known as its *gamut*, depends on which primaries it uses. The red, green and blue lights form a triangle on the chromaticity diagram, and all colours inside the triangle can be achieved as a combination of the primaries. The RGB colour space describes the amount of each primary needed to reproduce a colour, where $rgb=0,0,0$ is black and $rgb=1,1,1$ is white. The RGB space can be represented by a unit cube, see Figure 2.15.

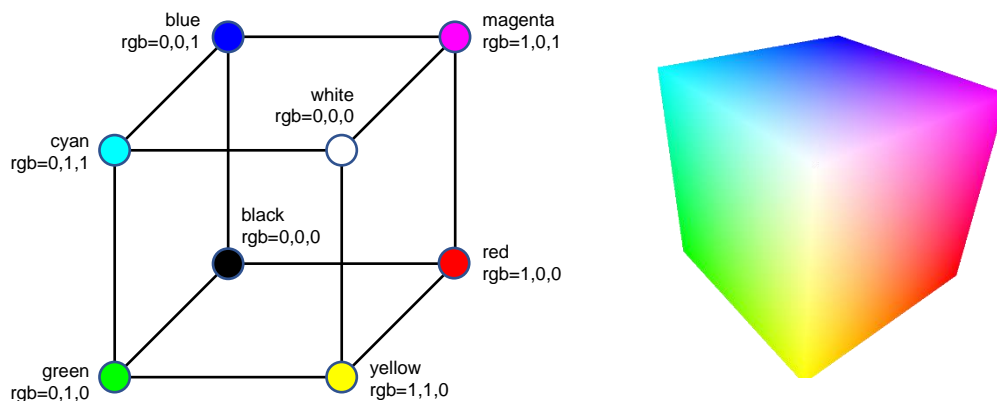

Figure 2.15. RGB colour space. Parallel (left) and perspective (right) projections. Generated using OpenGL by supplementary code to [77].

The fundamental difference between RGB and XYZ space is that RGB is *device dependent*, i.e. the same RGB values mean different colours when displayed by different devices, depending on the colours of the three primaries. Some sets of primaries have been standardised and might be well known to the reader, such as sRGB or Adobe RGB, see Figure 2.16. The sRGB standard, created by HP and Microsoft in 1996, based on CRT monitors and RGB primaries of a standard for high-definition television²⁰, is still in wide-spread usage today. It covers around 35 % of all visible colours.

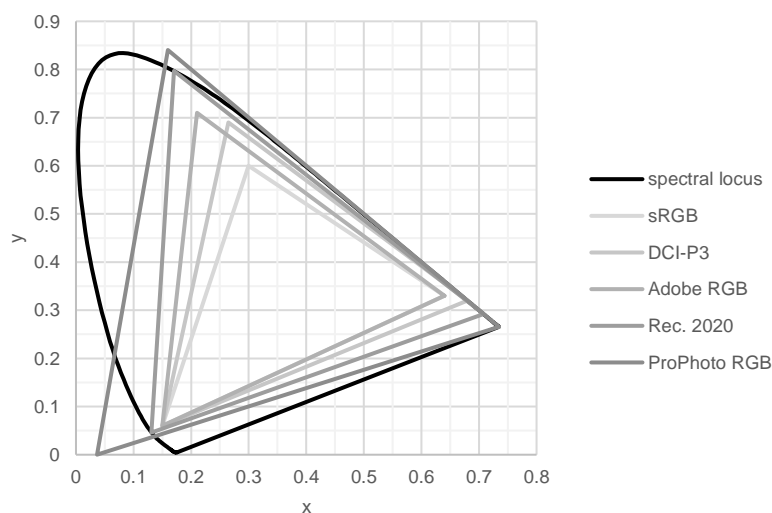

Figure 2.16. Selection of standardised RGB primaries.

²⁰ ITU-R BT.709-6 [73]. The original sRGB proposal is available at <http://www.w3.org/Graphics/Color/sRGB>.

2.5.2 Transformation

Transforming between XYZ and RGB is a matter of 3×3 matrix multiplication,

$$\begin{bmatrix} X \\ Y \\ Z \end{bmatrix} = [M] \begin{bmatrix} r \\ g \\ b \end{bmatrix} \text{ and } \begin{bmatrix} r \\ g \\ b \end{bmatrix} = [M]^{-1} \begin{bmatrix} X \\ Y \\ Z \end{bmatrix}, \quad (2.8)$$

where $[X \ Y \ Z]^T$ is the colour coordinate in XYZ, $[r \ g \ b]^T$ is the colour coordinate in linear RGB and $[M]$ is a 3×3 matrix,

$$[M] = \begin{bmatrix} a_{11} & a_{12} & a_{13} \\ a_{21} & a_{22} & a_{23} \\ a_{31} & a_{32} & a_{33} \end{bmatrix}. \quad (2.9)$$

Being an affine transformation, as long as coordinates of any 3 unique points are known in both XYZ and RGB spaces, matrix $[M]$ can be found by solving 3 sets of 3 linear equations. Following Cramer's rule, we find the determinant

$$D = \begin{vmatrix} r_1 & g_1 & b_1 \\ r_2 & g_2 & b_2 \\ r_3 & g_3 & b_3 \end{vmatrix} \quad (2.10)$$

and then

$$a_{11} = \frac{\begin{vmatrix} X_1 & g_1 & b_1 \\ X_2 & g_2 & b_2 \\ X_3 & g_3 & b_3 \end{vmatrix}}{D} \dots a_{12} = \frac{\begin{vmatrix} r_1 & X_1 & b_1 \\ r_2 & X_2 & b_2 \\ r_3 & X_3 & b_3 \end{vmatrix}}{D} \dots a_{33} = \frac{\begin{vmatrix} r_1 & g_1 & Z_1 \\ r_2 & g_2 & Z_2 \\ r_3 & g_3 & Z_3 \end{vmatrix}}{D}, \quad (2.11)$$

Specially, imagine we measure a display showing full red, green and blue colours with a spectrophotometer to obtain the corresponding XYZ values.

Then

$$D = \begin{vmatrix} 1 & 0 & 0 \\ 0 & 1 & 0 \\ 0 & 0 & 1 \end{vmatrix} = 1 \quad (2.12)$$

and

$$a_{11} = \begin{vmatrix} X_1 & 0 & 0 \\ X_2 & 1 & 0 \\ X_3 & 0 & 1 \end{vmatrix} = X_1 \dots a_{33} = \begin{vmatrix} 1 & 0 & Z_1 \\ 0 & 1 & Z_2 \\ 0 & 0 & Z_3 \end{vmatrix} = Z_3, \quad (2.13)$$

hence

$$[M] = \begin{bmatrix} X_1 & X_2 & X_3 \\ Y_1 & Y_2 & Y_3 \\ Z_1 & Z_2 & Z_3 \end{bmatrix}. \quad (2.14)$$

Note that the white colour produced by $r = g = b = 1$ is in general arbitrary. If a particular white is desired, the matrix M needs to be adapted using *chromatic adaptation transform (CAT)*, so that (2.8) produces the desired white coordinate in XYZ (known as *reference white*). Some of the common transforms include von Kries, Bradford, or those used in CIE colour appearance models. For their definition and comparison, see e.g. [78].

In practice, $[M]$ matrices are specified directly as part of the standard. For example, in the case of sRGB,

$$[M] = \begin{bmatrix} 0.4124 & 0.3576 & 0.1805 \\ 0.2126 & 0.7152 & 0.0722 \\ 0.0193 & 0.1192 & 0.9504 \end{bmatrix} \quad (2.15)$$

with D65 as the reference white.

2.5.3 Companding

Working with common RGB spaces requires dealing with non-linearities in the system. Human perception follows Weber-Fechner's law [79]²¹, in which the just discriminable difference is proportional to the baseline stimulus intensity. In another words, larger changes in brightness are needed at higher brightness levels to evoke the same perceived difference as smaller changes at lower brightness. By purely engineering luck, the CRT screens have non-linear response that roughly compensates for the non-linearity of human perception²² (see Figure 2.17). This is usually denoted as the display device's *gamma*, coming from the non-linearity relationship of

$$v = V^\gamma \quad (2.16)$$

where V is the input (e.g. voltage) and v is the output (e.g. light intensity). A typical value of gamma for a PC monitor is 2.2²³.

²¹ English translation of the relevant sections is available online at <https://psychclassics.yorku.ca/Fechner/>.

²² LCDs on the other hand have to simulate this non-linearity. See L^* in chapter 2.6.1 for the human perception of brightness.

²³ By default, Apple screens used the gamma value of 1.8 until v10.6 Snow Leopard.

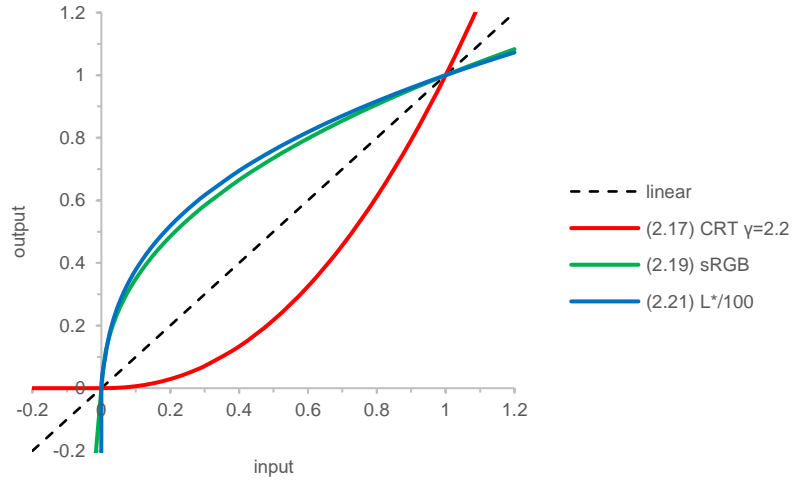

Figure 2.17. Non-linearity in perception and corrections. Blue: human perception as defined in CIELAB (see below). Red: CRT monitor opto-electronic transfer non-linearity. Green: sRGB companding function.

When limited precision is used to encode images, e.g. a byte for RGB values of 0-255, values would be wasted on resolution in the high range that we cannot see, and not enough values would be available for the sensitive low range. To avoid this issue, *gamma correction* is applied to the data. In case of the gamma equation above (2.16), it would be

$$V = \sqrt[\gamma]{v} = v^{1/\gamma}, \quad (2.17)$$

where v is any of red, green or blue values in linear RGB and V is the encoded value. We call this process gamma compressing and the operation of a display device as gamma expanding, which is where the portmanteau of *companding* comes from.

For sRGB, the companding function is defined as

$$V = \begin{cases} 12.92v & v \leq 0.0031308 \\ 1.055v^{1/2.4} - 0.055 & \text{otherwise} \end{cases} \quad (2.18)$$

with the inverse of

$$v = \begin{cases} V/12.92 & V \leq 0.04045 \\ \left(\frac{V + 0.055}{1.055} \right)^{2.4} & \text{otherwise} \end{cases} \quad (2.19)$$

All RGB values in this thesis denoted as R, G, B refer to 0-255, gamma compressed values, while values denoted as r, g, b refer to the linear RGB values ranging from 0.0 to 1.0²⁴.

2.6 Subtractive Colour Spaces for Reflective Mediums (CMYK)

Reflected colours, such as those printed or painted, use subtractive mixing, similar to how colour filters interact when blocking light. When all primaries, in case of the printing press usually cyan, magenta and yellow²⁵, are combined, all light is absorbed, creating black (see Figure 2.18), when none of them is present, no light is absorbed, leaving the source (such as a white paper) unaffected.

When light falls onto a surface with yellow pigment, the pigment absorbs wavelengths of all but the yellow colour, which is reflected to the observer. Colour filters work on a similar principle, a yellow filter lets only yellow colour through, appearing yellow to the observer. As more pigments or filters are overlaid over each other, other components of the light can be further removed, but never added back²⁶.

Analogically to displays, printing also takes advantage of the resolution capabilities of the human eye, by printing small dots of primary colours over each other to create combinations of other colours (halftoning), see Figure 2.19. The process of decomposing a desired colour into CMYK values is called colour separation and it is a non-trivial problem. An overview of existing methods for colour separation can be found in [80].

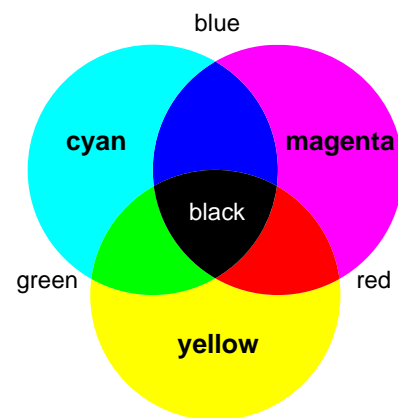

Figure 2.18. Subtractive colour mixing

²⁴ Unless otherwise noted, the primaries are sRGB primaries. A colour space with the same primaries as sRGB but linear values exists, named scRGB, also designed by HP and Microsoft. As a compromise ensuring backward compatibility with sRGB, the practical implementation has some undesirable properties (80% of values are imaginary colours, it doesn't cover the whole colour spectrum, uses negative coordinates), but those are of no concern to the theoretical principles here. scRGB is standardised as IEC 61966-2-2:2003.

²⁵ In early history of colour science, red, yellow and blue were the designated primary colours (also known as the RYB colour model), which would correspond to magenta, yellow and cyan in contemporary print, sometimes called “process red”, “process yellow” and “process blue”, respectively. In print, black (K) pigment is usually added as another “primary”, in order to save colour ink, improve the blackness and avoid misalignment issues.

²⁶ Special pigments, such as fluorescent ones, can absorb one wavelength and emit different one, effectively changing colour of the light, but we would treat those as emissive sources.

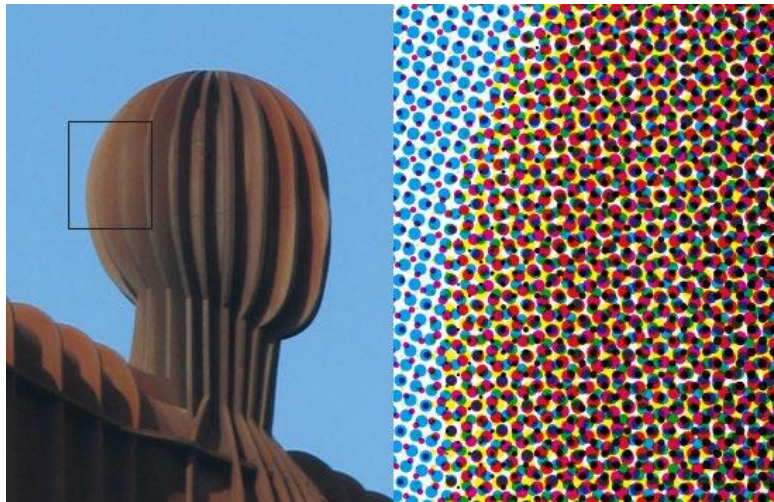

Figure 2.19. Enlarged photo of a printed image, showing CMYK halftone patterns.

Image © Tinstar Design Ltd tinstar.co.uk / graphic-design-employment.com with permission by N. Beresford-Davies.

Like in the case of RGB, CMYK colour space is device-dependent: the coordinates are relative to their primaries, typically ranging from 0 to 100, and several standards exist to define the primaries as well as a particular paper medium. Unlike RGB, the CMYK standards are territorial for historical reasons (e.g. SWOP in USA, Fogra in Europe, Japan Color etc.), although most of the industry is now working towards common ISO 12467 [81]. The subtractive model does not behave linearly and there is no simple mathematical model for converting between CMYK and the other colour spaces. In practice, the conversion is done using large lookup tables based on measurements of printed samples of various pigment mixtures.

The difference between RGB and CMYK gamuts (see an example in Figure 2.20) makes it very difficult to reproduce on paper what is seen on the screen, and typically the colours in a digital picture need to be either all scaled or clipped to fit within the printer gamut. These techniques and the complex printing technology in general are unfortunately beyond the scope of this work, but it is important to realize how fundamentally different the colour composition between emissive and reflective media is.

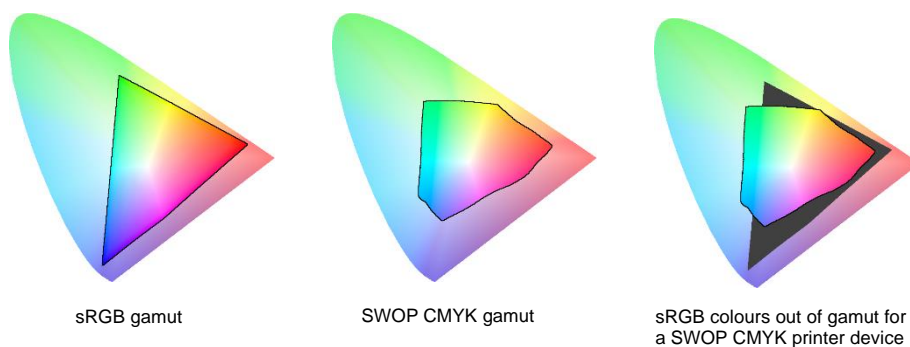

Figure 2.20. SWOP CMYK colour space compared to sRGB projected onto xy chromaticity diagram.

Rendered using ColorThink Pro 3.0.5 (SWOP TR001 CHROMiX mdGCR300 and sRGB IEC61966-2.1 profiles).

2.6.1 Hexagonality of the gamut

In additive mixing, the spectra of two light sources are added to each other, while as discussed above, parts of light are removed from the source in the subtractive mixing. We have also seen in chapter 2.1.2 that this principle of light being reflected from a surface corresponds to multiplication of the spectra. For a more illustrative example of the principle, see Figure 2.21.

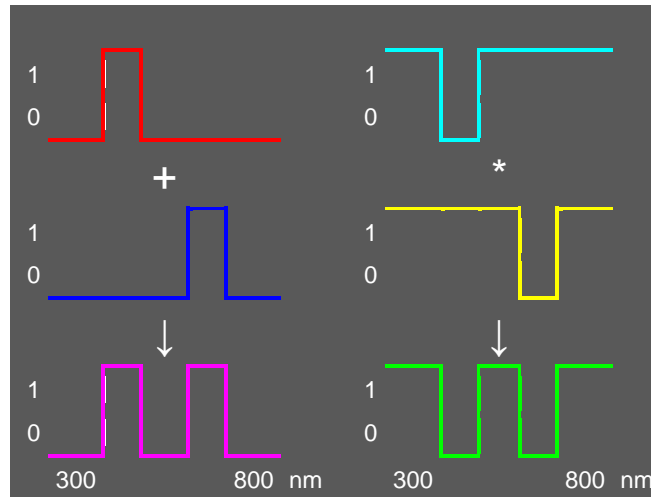

Figure 2.21. Additive and subtractive mixing of spectra. Left: additive mixing corresponds to summing spectra. Right: subtractive mixing corresponds to multiplication of spectra.

Let's imagine we have a colour whose spectra integrates to 1 for the respective colour matching functions, e.g. an imaginary red that has $X = \int_0^\infty S(\lambda) \cdot \bar{x}(\lambda) d\lambda = 1$ and $Y = Z = 0$. Similarly, we define imaginary green with XYZ coordinates of $[0 \ 1 \ 0]$, imaginary blue of $[0 \ 0 \ 1]$, etc. Plotting these imaginary primaries in the 1931 chromaticity diagram yields a unit triangle as depicted in Figure 2.22.

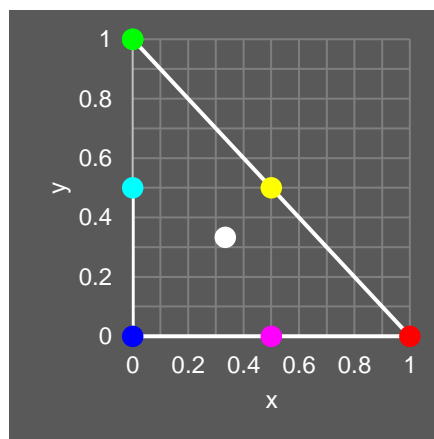

Figure 2.22. Unit triangle of imaginary primaries in the CIE 1931 xy chromaticity diagram.

The imaginary white created this way has XYZ values of [1 1 1] and therefore it is the equal energy white, $x = \frac{X}{X+Y+Z} = \frac{1}{3}$, $y = \frac{1}{3}$. Let us now look at how for example the imaginary yellow [1 1 0] and magenta [1 0 1] colours mix in both additive and subtractive models.

In the additive model, we simply add the spectra and therefore also the XYZ values, yielding XYZ of [2 1 1] and the chromaticity coordinates of $x = 0.5$, $y = 0.25$. Note that this point is, as expected, the midpoint on the line connecting the yellow and magenta colours. In the subtractive model, we multiply the XYZ values, yielding XYZ of [1 0 0], which corresponds to the imaginary red point (cf. Figure 2.18), outside of the CMY triangle.

If we gradually change from the yellow and magenta colours to the equal energy white, we can see that in the subtractive model, the mixed colour will always be on the right side of the yellow-magenta line: Let $[X_y Y_y Z_y] = [1 1 p]$ be a yellow colour \mathcal{Y} and $[X_{\mathcal{M}} Y_{\mathcal{M}} Z_{\mathcal{M}}] = [1 p 1]$ a magenta colour \mathcal{M} , $0 \leq p \leq 1$. For both \mathcal{Y} and \mathcal{M} ,

$$x = \frac{X}{X + Y + Z} = \frac{1}{2 + p}. \quad (2.20)$$

For the mixed colour, we get the same value in the additive model,

$$x_{add} = \frac{X_y + X_{\mathcal{M}}}{X_y + X_{\mathcal{M}} + Y_y + Y_{\mathcal{M}} + Z_y + Z_{\mathcal{M}}} = \frac{2}{4 + 2p} = \frac{1}{2 + p}, \quad (2.21)$$

i.e. a point always on the vertical line connecting the yellow and magenta colours (see Figure 2.23 left).

For the subtractive model, we get

$$x_{sub} = \frac{X_y X_{\mathcal{M}}}{X_y X_{\mathcal{M}} + Y_y Y_{\mathcal{M}} + Z_y Z_{\mathcal{M}}} = \frac{1}{1 + 2p}. \quad (2.22)$$

Since $\frac{1}{1+2p} > \frac{1}{2+p}$ for $0 \leq p < 1$, we showed that $x_{sub} > x_{add}$ when mixing \mathcal{Y} and \mathcal{M} . In other words, the subtractively mixed red is always further away from white than the additively mixed red (see Figure 2.23 right compared to left).

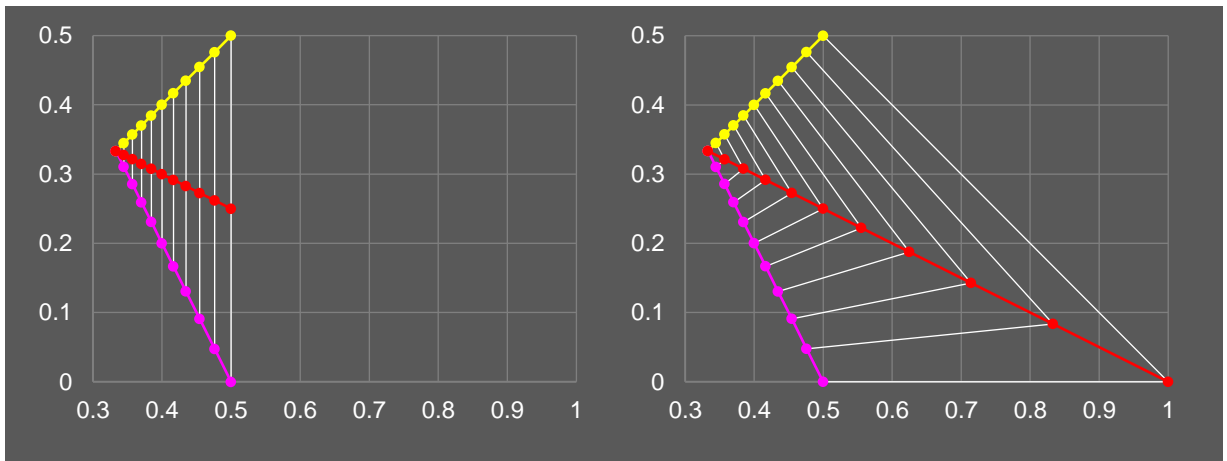

Figure 2.23. Yellow and magenta combined using additive (left) and subtractive (right) models. Imaginary primaries in the CIE 1931 xy chromaticity diagram, p in steps of 0.1.

Similar relationship can be derived for all the primaries (in fact, the distribution of points on the line going from white to the mixed colour at $p = 0$ is always the same, in both mixing strategies). As a consequence, the subtractive gamut tends to have a hexagonal rather than a triangular shape, see Figure 2.24.

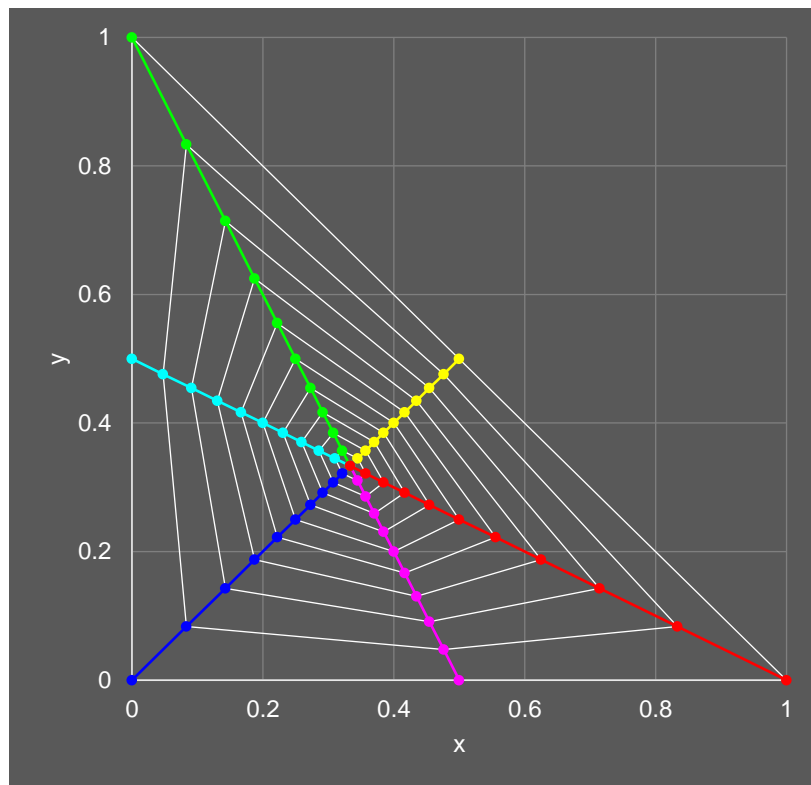

Figure 2.24. Hexagonal gamut in a subtractive model. Imaginary CMY primaries producing RGB colours, CIE 1931 xy chromaticity diagram, p in steps of 0.1.

2.7 Perceptually Uniform Colour Spaces (LUV, LAB)

None of the colour spaces introduced so far are perceptually uniform, i.e. the same distances in the colour space do not correspond to the same perceptual differences between colours. The history of perceptually uniform metrics and colour spaces is rich and beyond scope of this introduction, and can be found in more detail e.g. in [82]. We will focus shortly on the two spaces standardised by CIE in 1960 resp. 1976 that we use further in the work.

2.7.1 CIELUV

In 1937, D.L. MacAdam has taken on the suggestion of D.B. Judd to construct a perceptually uniform chromaticity diagram by projective transformation of the XYZ space. Judd based his uniform scale on many various experimental data collected by others [83, p. 72], and MacAdam matched his results with explicit transformation formulæ [84, p. 298]. MacAdam's transformation, with slight modification²⁷, became the $L^*u^*v^*$ space recommended by CIE as CIELUV. For a colour of $[X \ Y \ Z]^T$ values and reference white of $[X_r \ Y_r \ Z_r]^T$ values in the XYZ colour space, we get the colour $[L^* \ u^* \ v^*]^T$ coordinates of the colour in CIELUV space as follows:

$$L^* = \begin{cases} 116\sqrt[3]{y_r} - 16 & y_r > \epsilon \\ \kappa y_r & \text{otherwise} \end{cases} \quad (2.23)$$

$$u^* = 13L^*(u' - u'_r) \quad (2.24)$$

$$v^* = 13L^*(v' - v'_r)$$

where

$$u' = \frac{4X}{X + 15Y + 3Z} = \frac{4x}{-2x + 12y + 3} \quad (2.25)$$

$$v' = \frac{9Y}{X + 15Y + 3Z} = \frac{9y}{-2x + 12y + 3}$$

u'_r and v'_r are coordinates of the white point transformed as per (2.25), $y_r = \frac{Y}{Y_r}$ and

$$\epsilon = 216/24389 \quad (2.26)$$

$$\kappa = 24389/27. \quad (2.27)$$

²⁷ Original MacAdam's equations transformed x and y chromaticity coordinates into u and v in 1960, the slight modification resulted in $u' = u$ and $v' = 1.5v$ coordinates in 1976 and the u^* and v^* coordinates incorporate a reference white point.

The chromaticity diagram defined by u' and v' in (2.25) is as perceptually uniform as any projective transformation of the xy diagram can possibly be [85, p. 150], yet it is clear that it is nowhere near ideal.

MacAdam collected about 20,000 colour matching values for 25 conditions from one observer and fitted them with ellipses²⁸, which illustrate the perceptual non-linearity of both the xy diagram (Figure 2.25 left) and the improved $u'v'$ diagram (Figure 2.25 right).

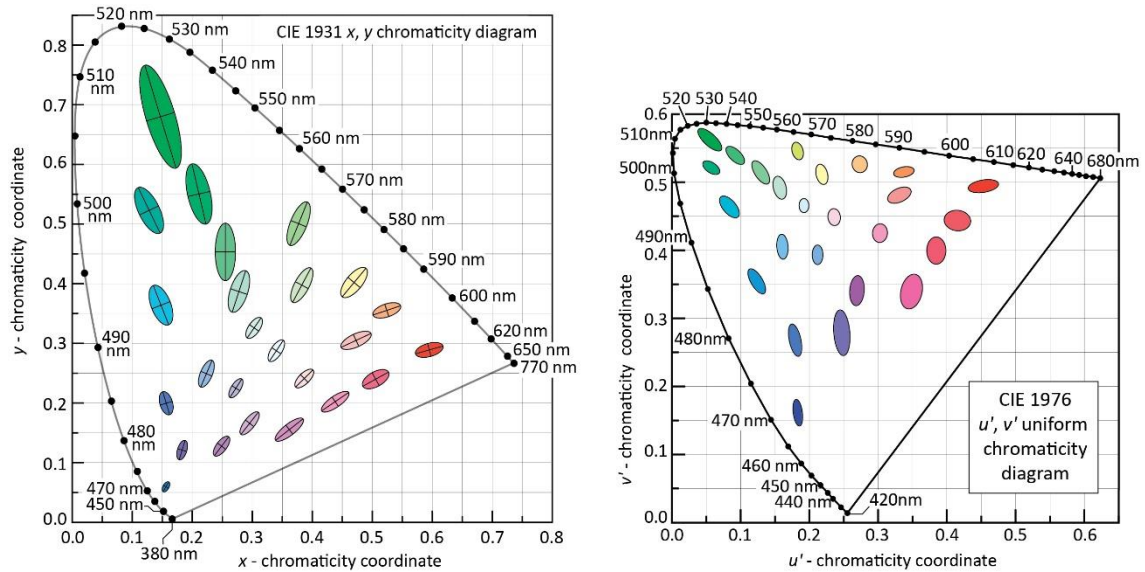

Figure 2.25. MacAdam ellipses of chromaticity discrimination. Left: in CIE 1931 chromaticity diagram. Right: in CIE 1976 uniform chromaticity scale diagram (right). Ellipses axes are ten-times their actual size. Figures kindly provided by E.F. Schubert from [86].

2.7.2 CIELAB

By the 1960s, there were many new colour matching data as well as competing colour difference formulæ and the industry desperately needed harmonization in quality control [87, pp. 228-9]. It became clear that any perceptually uniform colour space (which would also provide a metric for perceptual colour differences) must be non-linear.

In 1976, the CIE simplified one of the more popular colour difference formulæ (Adams-Nickerson²⁹) and recommended the CIELAB space as a non-linear alternative to CIELUV. For a colour of $[X \ Y \ Z]^T$ values and reference white of $[X_r \ Y_r \ Z_r]^T$ values in the XYZ colour space, we get the colour $[L^* \ a^* \ b^*]^T$ coordinates of the colour in CIELUV space as follows:

²⁸ The colour matching task was comparing two colours in a hemi-field. One half was a fixed colour, and the other half was a colour adjusted by the observer, trying to move it from various direction to the reference colour in one dimension, along lines in the CIE 1931 xy chromaticity diagram.

²⁹ Adams suggested a colour difference formula based on fitting the Munsell colours (see below) and Nickerson extended it into a 3D space known as ANLAB [78]. For the simplification steps from ANLAB to CIELAB see e.g. [261].

$$L^* = 116f_y - 16 \quad (2.28)$$

$$a^* = 500(f_x - f_y) \quad (2.29)$$

$$b^* = 200(f_y - f_z)$$

where

$$f_t = \begin{cases} \sqrt[3]{t_r} & t_r > \epsilon \\ \frac{\kappa t_r + 16}{116} & \text{otherwise} \end{cases}, t \in \{x, y, z\} \quad (2.30)$$

ϵ and κ are defined as above in (2.26) and (2.27) respectively, $y_r = \frac{Y}{Y_r}$, $x_r = \frac{X}{X_r}$ and $z_r = \frac{Z}{Z_r}$.

Note that the L^* is computed the same in both CIELUV and CIELAB colour spaces.

Furthermore, polar coordinates were defined as follows:

$$C_{ab}^* = \sqrt{a^{*2} - b^{*2}} \quad (2.31)$$

$$h_{ab} = \tan^{-1} \frac{b^*}{a^*} \quad (2.32)$$

where C is chroma, the distance from the reference white point in the a^*b^* plane (e.g. less green vs more green) and h is the hue angle (e.g. green vs red). There is also saturation, which is the chroma divided by luminance:

$$s_{ab} = C_{ab}^* / L^* \quad (2.33)$$

The CIELAB space has a non-trivial shape that is challenging to internalize (see Figure 2.25).

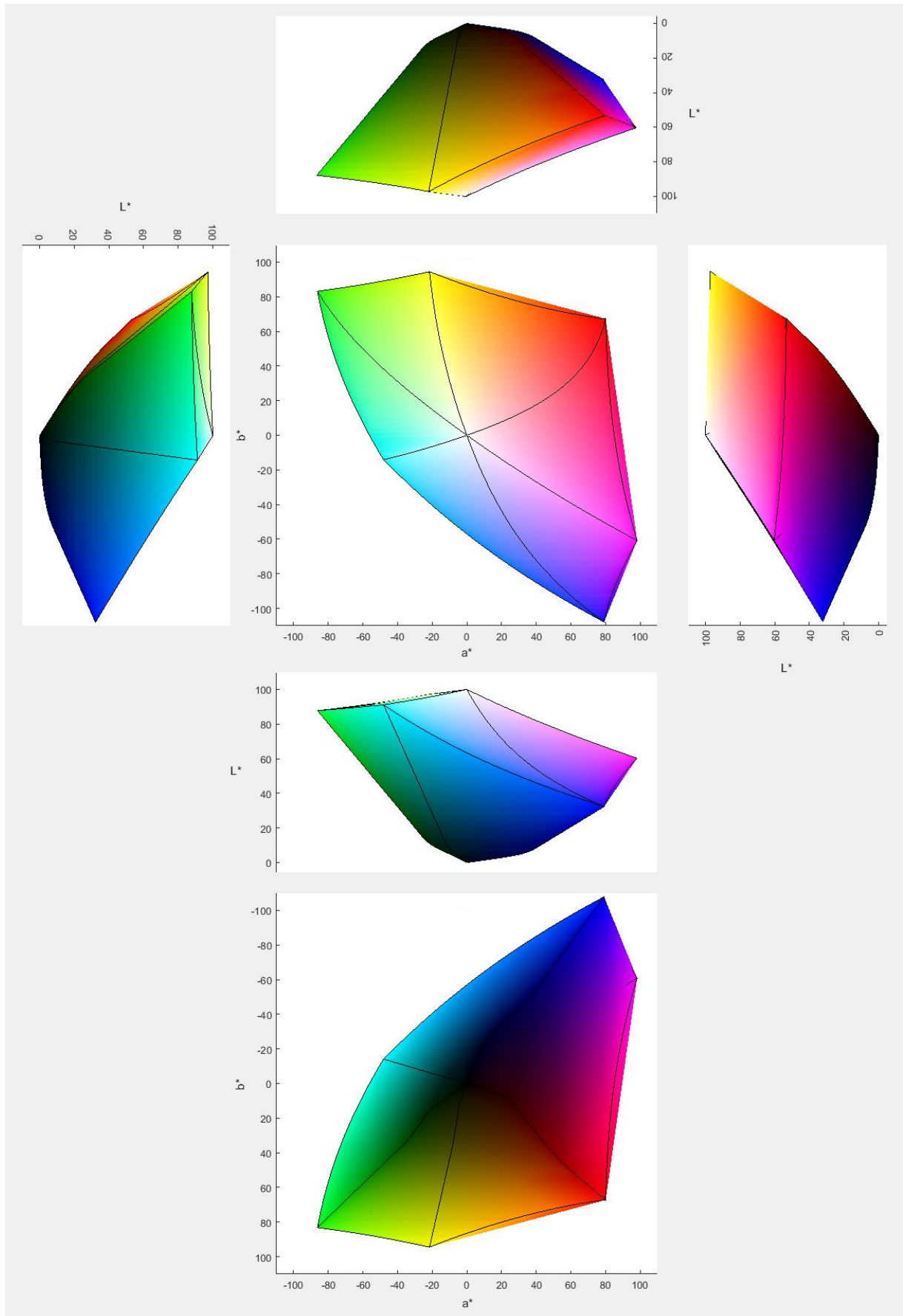

Figure 2.26. sRGB gamut in CIELAB space. Black lines connect white and black points with red, green, blue, cyan, magenta and yellow vertices. Generated by author based on script by Steve Eddins [88].

After the CIE recommendation, several new datasets were produced to evaluate how perceptually uniform the CIELAB space is. Some of these results are shown in Figure 2.27. Should the space be uniform, we would expect regular circles on the left and straight lines on the right. Notice especially that the blue area is skewed towards bottom right.

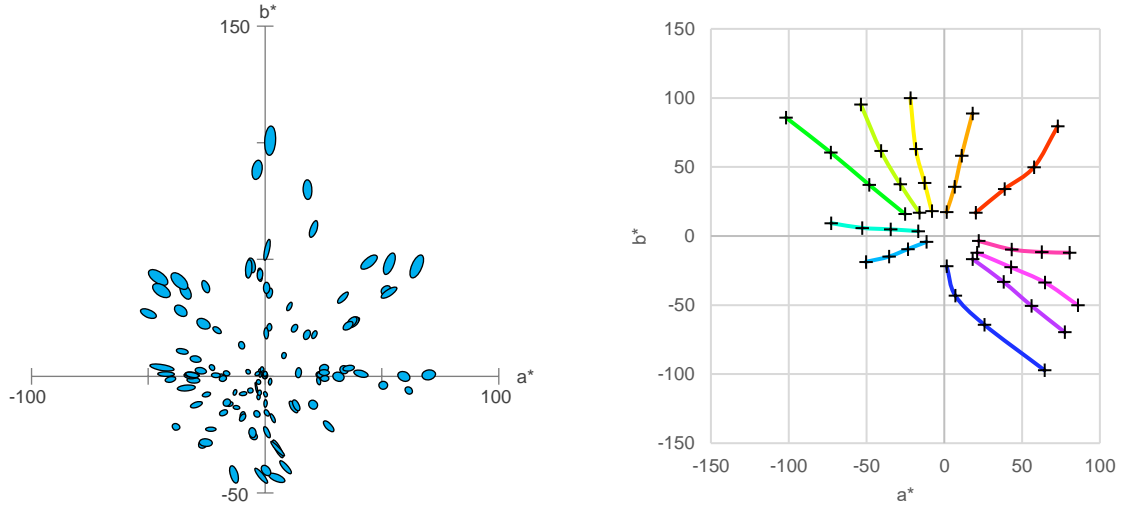

Figure 2.27. Perceptual uniformity of CIELAB. Left: discrimination ellipses based on data by Luo et al. [89]. Right: lines of constant hue based on data by Hung & Berns [90].

It should be noted that CIELUV and CIELAB were both recommended as a provisional step towards solving the problem of perceptual colour difference only, however, despite the non-uniformities hinted above, the CIELAB has since become the universally adopted colour space to measure colour differences [91, p. 81]. The colour difference is measured as the Euclidean distance between two colours:

$$\Delta E_{abL}^* = \sqrt{(L_1^* - L_2^*)^2 + (a_1^* - a_2^*)^2 + (b_1^* - b_2^*)^2}. \quad (2.34)$$

Sometimes we might be interested in chromatic difference only, ignoring the luminance component:

$$\Delta E_{ab}^* = \sqrt{(a_1^* - a_2^*)^2 + (b_1^* - b_2^*)^2}. \quad (2.35)$$

A common misconception is that CIELUV should be used for emissive surfaces while CIELAB was designed for object surface colours. However, there was no evidence for such distinction and CIE did not make any recommendations in this respect either [92].

2.8 Ordered Colour Sets

Apart from the analytical, continuous colour spaces described above, several bodies defined and standardised their discrete sets of colours, mostly to fulfil the needs of industry. For example,

customers value having the spare car parts painted with the same colour as the rest of their car, and this similarly holds for all variety of industries, including printing press, painting bridges, producing textiles etc.

2.8.1 Munsell

After the first attempts of Tobias Mayer and J.H. Lambert in the second half of the 18th century [93, pp. 8-9], many tried to tackle the problem of systematically ordering colours – among others a painter, chemist, mathematician, physicist, architect and psychologist, but it wasn't until the first decade of the 20th century that a visually uniform system was presented by A.H. Munsell, after he conceived the novel idea of chroma, i.e. change of chromatic intensity while keeping the



Figure 2.28. Munsell Book of Color (marketing photo).

lightness constant. Munsell was an artist, and he was looking for tools for teaching students the concepts of colour balance, complementary and contrasting colours, harmonious colour combinations, and colour schemes to use in painting [94]. His ordering, that later became the *Munsell Book of Color* (see Figure 2.28), is still in wide use today. It is based on decimal system, with 5 principal and 5 intermediate hues. Any colour is determined by H^V_C : the hue, value and chroma.

For the printing and textile industry, the leading system is Pantone. In 1963, Lawrence Herbert introduced the Pantone Matching System after acquiring the printing business from a company he was working at in New Jersey [95]. Unlike the other systems described here, Pantone actually licenses instructions on how to produce the colours as a combination of few base pigments, and it also includes special colours such as metallic or fluorescent. Colours are numbered sequentially and therefore referred to using a code that doesn't necessarily give much insight into the nature of the colour, for example 16-1546 (since the set of base pigments changed over time).

2.8.2 RAL

In our cross-media colour matching study, we will use a system called RAL DESIGN SYSTEM *plus*. The RAL German Institute for Quality Assurance and Certification was founded as non-profit association in 1925, focusing on regulating and standardising the German industries. They

published the first binding standards with a collection of the 40 most used colours two years later [96], and introduced the RAL DESIGN SYSTEM based on the cylindrical representation of the CIELAB colour space in 2007 (an illustrative depiction of the colours can be seen on Figure 2.29). A colour is defined using Hue, Lightness and Chroma values, as defined by CIE:

$$C_{ab}^* = \sqrt{a^{*2} + b^{*2}} \quad (2.31)^\dagger$$

$$h_{ab} = \tan^{-1} \frac{a^*}{b^*} \quad (2.32)$$

With the same lightness value as in the LAB space, this space is called as LCh_{ab}. An analogical space can be also constructed from the LUV space, called LCh_{uv}. These spaces also define saturation as chroma over lightness,

$$s_{ab} = \frac{C_{ab}^*}{L^*}. \quad (2.33)$$

The colour is denoted by a code in the form of RAL HHH LL CC, where HHH is the hue in degrees, LL is the lightness, and CC is the chrome. RAL has also assigned a unique name to all of their 1825 colours, in English, German, Chinese, French and Russian. For example, RAL 030 40 60 is *Emperor cherry red*.

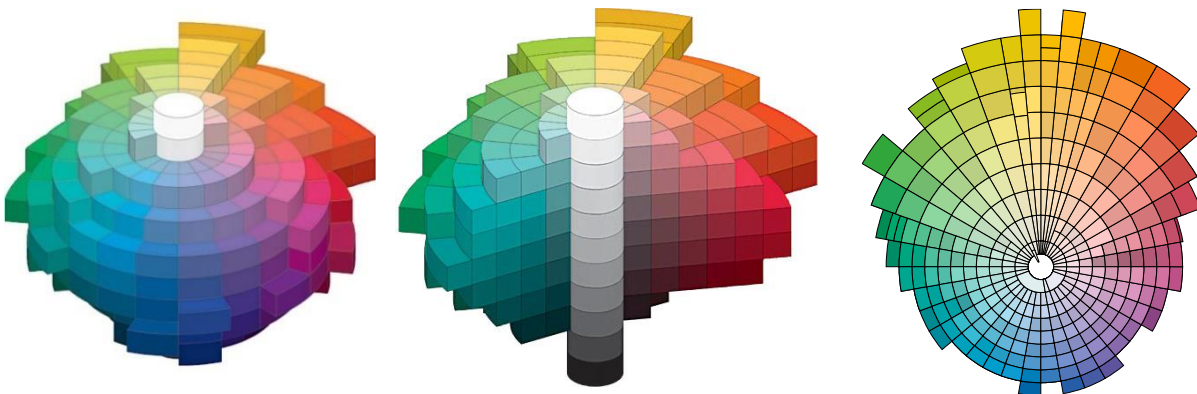

Figure 2.29. RAL DESIGN SYSTEM *plus*. Left and middle: marketing images³⁰ (a selection of colours). Right: top view of all colours, generated by author.

The RAL provides A4 paper sheets for all their colours and these were directly used in the study in Chapter 3. This system is a natural choice for its direct connection to the CIELAB colour space, and not only does it allow for easy reproducibility of the experimental set-up, but also provides direct comparability to any new results based on this system.

³⁰ <https://www.ral-farben.de/content/anwendung-hilfe/ral-design-system.html>

The colours are defined under D65 illuminant, standard 10° observer and controlled using a d/8° instrument geometry³¹. Unfortunately, the institute declined to disclose the absolute tolerance values of their quality assurance process, other than that they vary across the space.

2.9 Physiological Colour Space (DKL)

Higher levels of processing by the visual system, beyond the retina, are generally out of scope for this work; interested readers can refer for example to the HANDBOOK OF OPTICS [97]. However, we shall briefly mention the earliest stages of processing.

Colour vision research has been historically dominated by two theories, *trichromacy* and *colour opponency*. We have introduced trichromatic vision in 2.2 as colour vision underpinned by the responses of three cone types, i.e. the S, M and L cones. This theory suggests that colour vision is fully circumscribed by the independent responses of the individual cone types, similar to how we defined the XYZ colour space as an integration over three colour matching functions.

In 1878, Ewald Hering published a new theory based on colour opponency [98]. He noticed that we cannot perceive some of the colours at the same time. For example, we can perceive reddish-blue and reddish-yellow colours but not yellowish-blue. He postulated that colour perception is based on three fundamental pairs: dark ↔ light, red ↔ green and blue ↔ yellow. While the trichromatic model was straightforward and simple to use, more and more discrepancies and questions that the model cannot explain have arisen over time [99, p. 385]. In the 1950s, Hurvich & Jameson tried to address the puzzling questions using colour opponency, reinvigorating research interest in that model [99]. DeValois et al. then demonstrated colour opponency in primates using electrophysiological measurements [100], and today the colour opponency model is no longer questioned [101].

The modern model of the colour opponent theory is illustrated in Figure 2.30. In what is also known as “second-stage” colour encoding, the input from L, M and S cones is added and subtracted to form the achromatic luminance channel and two chromatic cone-opponent channels.

³¹ as per private communication with RAL Colour Lab

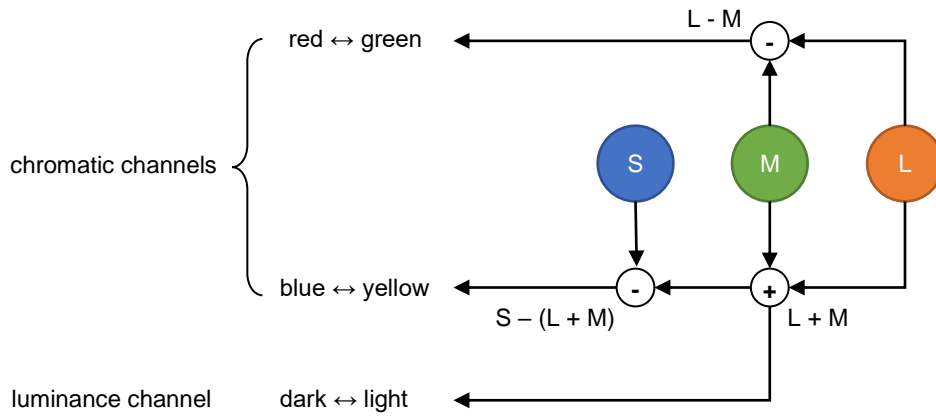

Figure 2.30. Second-stage colour encoding as per DKL space. Note that recent literature suggested that S interlaces with L and M cones individually as well [91, p. 21].

In 1984, Derrington, Krauskopf and Lennie introduced a colour space based on these fundamental signals, commonly referred to as the DKL space [102]. Similar to the CIELAB space, the space has two chromatic (red-green and yellow-blue) axes and one luminance axis. However, unlike CIELAB, DKL space is based on the physiological responses: the isoluminant plane contains all colours that induce the same neural response on the luminance channel pathway. An illustration of the space layout is given in Figure 2.31.

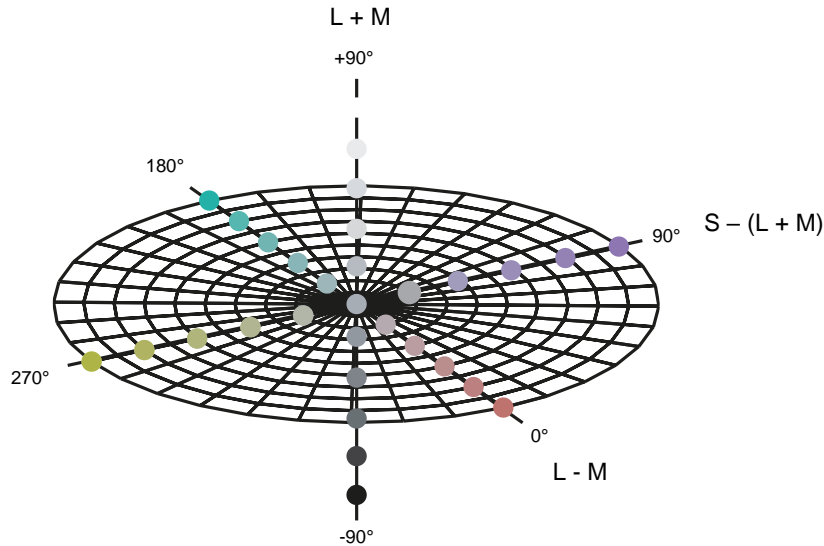

Figure 2.31. DKL colour space. Adapted from [97], originally by Caterina Ripamonti.

In this thesis, DKL space was used as derived by D.H. Brainard [103]. Coordinates of both the stimulus and the surrounding background are required. Let $[P_L P_M P_S]^T$ be the respective excitation levels of the L, M and S cones of the stimulus, and $[P_{L0} P_{M0} P_{S0}]^T$ of the background.

These can be obtained either by direct integration of the spectra using cone fundamentals [104], or by transforming XYZ coordinates using the matrix derived by Smith & Pokorny [105, p. 557]:

$$\begin{bmatrix} P_L \\ P_M \\ P_S \end{bmatrix} = \begin{bmatrix} 0.15516 & 0.54308 & -0.03287 \\ -0.15516 & 0.45692 & 0.03287 \\ 0.00000 & 0.00000 & 0.01608 \end{bmatrix} \cdot \begin{bmatrix} X \\ Y \\ Z \end{bmatrix} \quad (2.36)$$

The transformation to the DKL space is then defined as

$$\begin{bmatrix} L + M / k_{lum} \\ L - M / k_{RG} \\ S - (L + M) / k_{BY} \end{bmatrix} = \begin{bmatrix} 1 & 1 & 0 \\ 1 & -\frac{P_{L0}}{P_{M0}} & 0 \\ -1 & -1 & \frac{P_{L0} + P_{M0}}{P_{S0}} \end{bmatrix} \cdot \begin{bmatrix} P_L - P_{L0} \\ P_M - P_{M0} \\ P_S - P_{S0} \end{bmatrix}, \quad (2.37)$$

where k_{lum} , k_{RG} and k_{BY} are constants that define the contrast metric. A natural choice for k_{lum} is such that $L + M$ expresses the luminance contrast. On the other hand, there is no natural choice for k_{RG} and k_{BY} and different authors define it differently [103, p. 571]. We will follow the convention described by Brainard, but since the scaling is generally arbitrary, special care needs to be taken when comparing data from various sources.

2.10 Summary

In this chapter, we have reviewed the literature leading to our current understanding of light and basic principles of human vision. We have discussed the seminal colour-matching work leading to standardised colour spaces and the idea of a standard observer with colour matching functions that are an average of several observers' matches.

We have described several derived colour spaces used later in this thesis, most importantly the additive RGB for emissive displays, the subtractive CMYK for printed or painted media, and two perceptually uniform ones – CIELUV that maintains additivity, allowing for linear interpolation by the paper-like algorithm, and CIELAB for evaluating perceptual differences and human colour matching performance.

Chapter 3. Principles of Current Display and Sensing Technology, Materials and Equipment Used

This chapter provides an overview and principles of current display and light sensing technology relevant to the work in this thesis, as well as reference for materials and equipment used in experiments and studies presented in later chapters.

3.1 Light sensing technology

When sensing light, we are concerned about two aspects. one is measuring the amount of light, the other one its colour.

3.1.1 Photodiodes

Diodes are semiconductors, where a material with extra free electrons (n-type for being negatively charged) meets a material with deficiency of electrons (p-type for being positively charged), forming a p-n junction. In the region where the two types of semiconductor meet, the depletion layer, the free electrons fill the deficiencies (holes), effectively creating a nonconductive barrier preventing the rest of the material to do the same. Filling deficiencies means that electrons in higher energy antibonding orbitals take place in the lower energy bonding orbitals³².

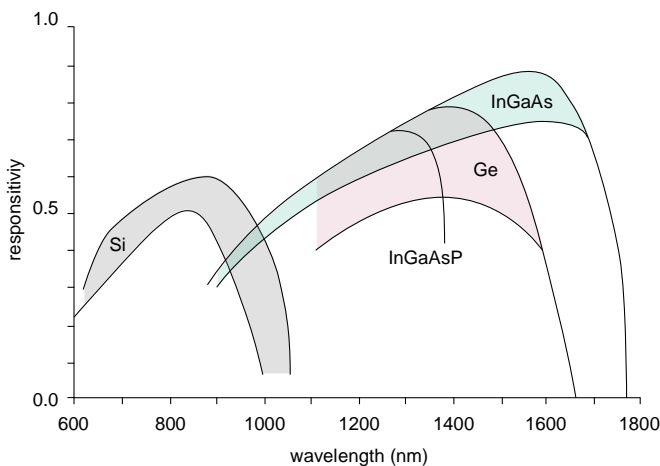

Figure 3.1. Unfiltered photodiode sensitivity by material. Adapted by D. Ali from [279], unsourced.

In the case of photodiodes, light penetrates into the depletion layer where the energy of photons is absorbed, ideally putting the electrons back onto the higher orbitals, setting them free again, and therefore letting the electric current flow, effectively making the diode conductive. The more light, the more electrons are separated and larger current flows through the diode, which can be electrically measured. If the

wavelength of the light is too long, there isn't enough energy to push electrons into higher energy levels, and if it is too short, it gets absorbed too fast near the material surface, without much effect on the depletion region [106, p. 326].

³² Sometimes also called conduction energy levels and valence energy levels, respectively.

A few observations that are relevant to our discussion: since the principle of operation is using the energy of light to move electrons to different atomic orbitals, there is an intrinsic spectral sensitivity distribution that depends on the semiconductor materials used (see Figure 3.1 for an illustration). Second, heat is another source of energy that the electrons can absorb, and therefore affects the photodiode properties. For the best, well defined performance, the sensor should be kept at stable temperature, the lower temperature the less thermal noise is present in the data.

3.1.2 Colour Filtering

Optical filters are generally divided into two categories, absorption filters and interference filters (less common are filters based on birefringence and scattering).

Absorption filters are usually in the form of coloured glass, gelatine or liquid solutions. As briefly mentioned in the section about subtractive colour spaces 2.6, the light of desired colour is simply passed through, while the rest is absorbed and transformed into another form of energy, usually heat. The chemical principles of absorption are out of scope for this thesis and can be found e.g. in [31]. Absorption filters are generally used in cameras and RGB sensors, where a pattern of red, green and blue filters are covering the photodiodes, and the full colour is reconstructed by combining the filtered measurements (see e.g. [107]).

The important aspects are that the absorption effect only depends on the material thickness, not angle of incidence, that the absorption filters tend to let through wide range of wavelengths and that we are limited with what colours can be filtered based on what materials we have available. Most notably, colour matching functions of human vision cannot be approximated with current materials. An example of spectral sensitivity of an RGB sensor using absorption filters is listed below in Figure 3.6. As a consequence, common commercial cameras are unable to capture colours the same way people perceive them.

More advanced filters are based on interference, where the light is repeatedly reflected within a very narrow cavity, also known as Fabry-Pérot cavity or *etalon* (see Figure 3.2). When light falls on a plane-parallel plate coated with semi-transparent but highly reflective layer (such as silver or aluminium), there are multiple reflections that for some wavelengths cancel each other out, and for others amplify. In particular, for reasons explained e.g. in [108, p. 323], there are sharp

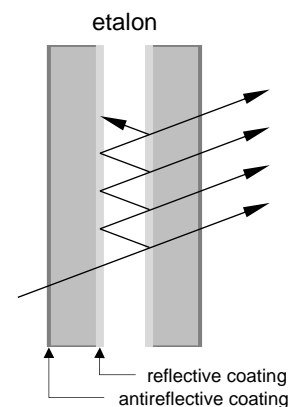

Figure 3.2. Interference filter.

transmission maxima at $\lambda_0^{(m)} = 2nt/(m - \phi/\pi)$ nm, where t is the plate thickness, n its refractive index, ϕ phase shift at reflection, and m an integer (called the *order of interference*). For dielectric materials, the phase shift is zero and the optimal cavity thickness for transmission of wavelength λ_0 is $\lambda_0/2$. However, for larger angles of incidence, the peak wavelength shifts towards shorter wavelengths and the selectivity decreases. An example of measured commercial interference filter characteristics is shown in Figure 3.3, while the exact calculations can be found e.g. in [109, pp. 283-288].

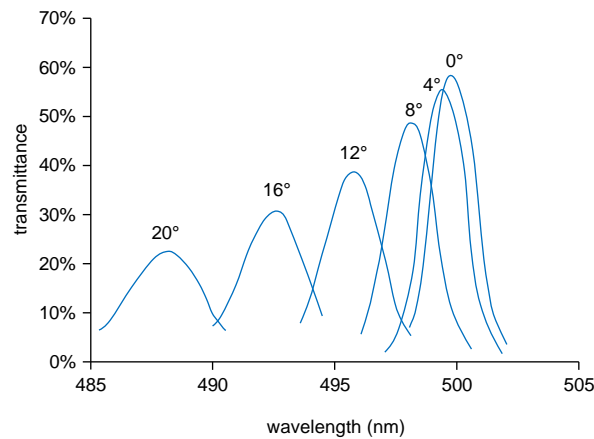

Figure 3.3 Interference filter performance based on angle of incidence. Adapted from [110].

The key take-away is that with interference filters, we can design sensors with arbitrary spectral response, however, we are limited to very narrow incidence angles.

3.2 Sensors used in this work

3.2.1 CS-2000 Spectroradiometer

Colorimetric measurements were done using Konica Minolta's spectroradiometer CS-2000, firmware version 1.12.0000, factory calibrated in March 2014. The spectroradiometer measures spectral radiance reflected $L_e(\lambda)$ from a surface in the range from 380 nm to 780 nm with resolution of 1 nm.

When the light enters the objective lens, it passes through a hole in the aperture mirror to an optical fiber where it is repeatedly reflected, making it uniform. Parallel rays of light aligned by a

collimator then reach the diffraction grating, where the light is dispersed according to wavelength and finally focused using a condenser lens onto a one-dimensional sensor array of 512 pixels (see Figure 3.4). The array is kept at constant temperature using a Peltier cooler irrespective of the ambient temperature to improve accuracy and reduce noise, requiring 20 minutes of warm-up time before using the instrument.

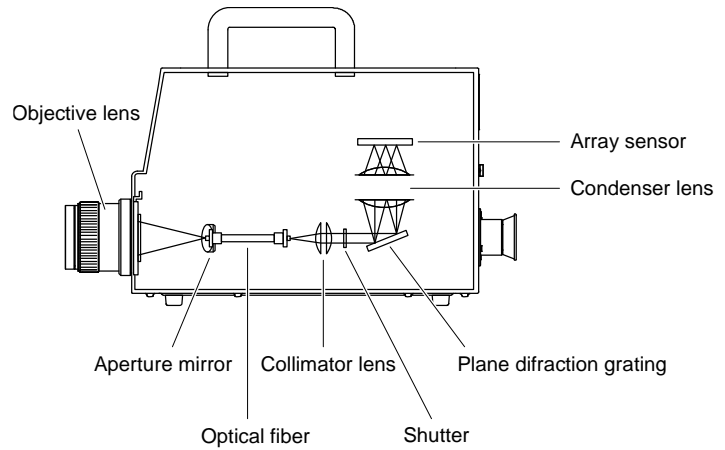

Figure 3.4. CS-2000 schematic (adapted from its instruction manual)

The measuring tolerance for conditions in this work (1° measuring angle, $> 5 \text{ cd/m}^2$) are summarized in Table 3.1.

| | CIE 1931 x CIE 1931 y Luminance | | |
|----------------------|---------------------------------|-------------|------------|
| Accuracy | ± 0.0015 | ± 0.001 | $\pm 2 \%$ |
| Repeatability | ± 0.0004 | ± 0.004 | 0.15% |

Table 3.1. CS-2000 measuring tolerances, based on 10 measurements (from specification).

Ten control measurements of the point at the centre of the screen of a Fujitsu tablet (3.4.1) showing the gamut corners (RGBCMY), full white, D65 white and all light conditions were taken at full brightness, yielding maximum difference of $\Delta x = 0.00039$, $\Delta y = 0.00026$, $\Delta Y = 0.72\%$, using the CIE 2012 2° color matching functions, corresponding to the maximum difference of $\Delta a^* = 0.176$, $\Delta b^* = 0.415$, $\Delta L^* = 0.281$. Therefore, any values in the CIE LAB space coming from spectra measured by CS-2000 are only valid up to about one decimal point.

3.2.2 TCS34725 RGB Sensor

All systems in this thesis use the TCS34275 colour sensor by ams AG³³ with configurable gain and integration time. The sensor contains 3×4 photodiode array composed of red-filtered, green-filtered, blue-filtered and clear (unfiltered) photodiodes, hence providing RGB channels as well as a clear one for overall luminance. In addition, the photodiodes are coated with an infrared blocking filter. The schematic diagram of the sensor and photodiode array is in shown in Figure 3.5.

³³ <http://www.ams.com/TCS34725>

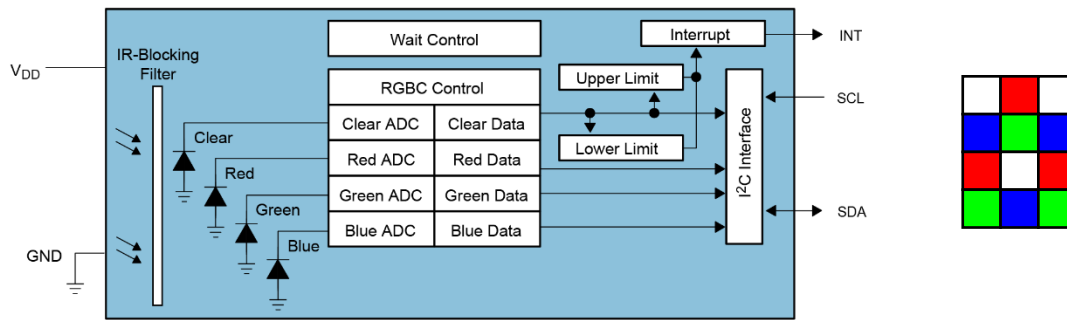

Figure 3.5. TCS34725 sensor. Left: functional block diagram. Right: photodiode array arrangement. Adapted from its datasheet.

The most important feature of the sensor is that each colour channel has its own 16-bit analog-to-digital converter (ADC) and they operate simultaneously, avoiding reading false colours (see 5.5.1 for details).

The spectral responsivity of the sensor based on data provided by the manufacturer is plotted in Figure 3.6.

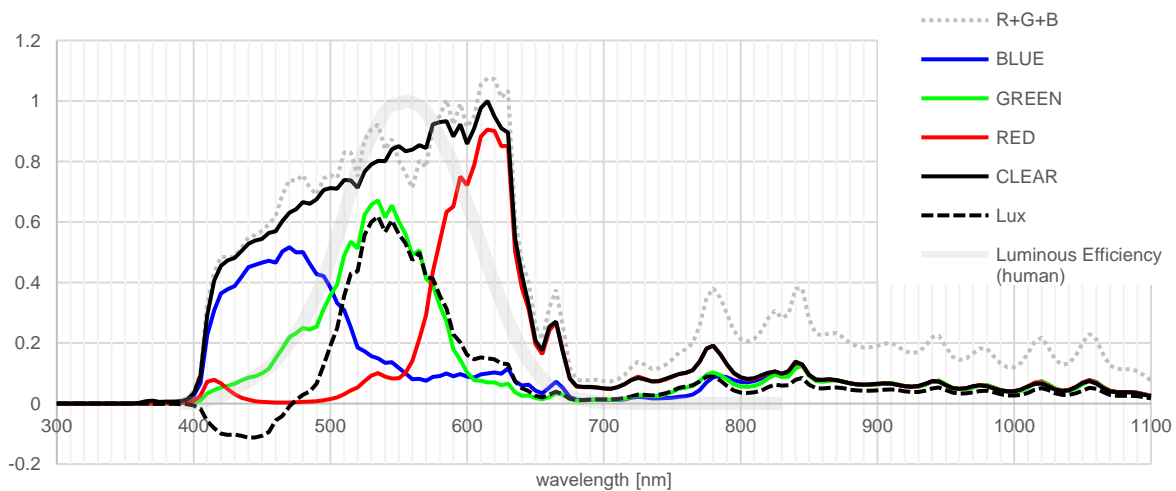

Figure 3.6. TCS3472 spectral responsivity. Illuminance (lux) values as computed based on the formula in sensor's Application Note [111].

The cost of this sensor was around 3 EUR per piece at the time of purchase.

3.2.3 MTCSiCF XYZ Sensor

For quick colorimetric evaluations when the spectroradiometer was not available, the MTCSiCF JENCOLOR® True Color sensor by MAZeT GmbH was used, by means of their MTCS-C3 sensor

board which combines the sensor with MCDC04 16-bit ADC converters³⁴. The functional block diagram combining the sensor and ADC converter and the sensor's 19×3 photodiode array are in Figure 3.7.

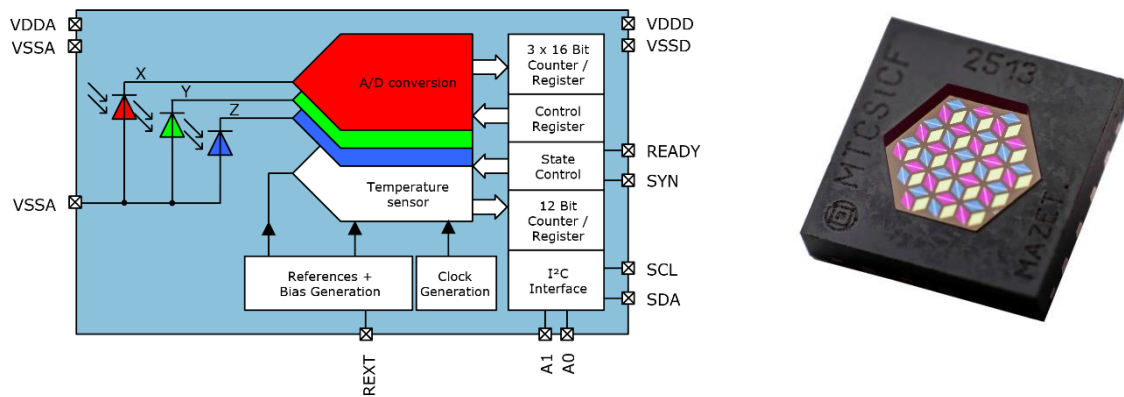

Figure 3.7. MTCSiCF sensor. Left: Equivalent True Color sensor block diagram (from AS73211 datasheet). Right: MTCSiCF photodiode array arrangement.

Like the RGB sensor, MTCS-C₃ has synchronous ADC per each channel, configurable integration time and sensitivity. This sensor uses dielectric spectral filters to match the response CIE 1931 colour matching functions (Figure 2.10) based on interference. While that provides response corresponding to human perception of colours, the downside is that the angle of incidence of the light must be below 10°, otherwise the diverted beam would cause filter shifts. Based on the drawings from manufacturer, John Helmes from Microsoft Research designed and 3D printed an optical cover for me ensuring the limited angle of incidence.

The cost of the combined AS73211 sensor was around 15 EUR per piece at the time of writing.

3.3 Display Technology

This section provides a brief overview of several contemporary display technologies relevant to this thesis (namely LCD, LED, and EPD). For older technologies such as cathode-ray tube (CRT), the book COLOR IN ELECTRONIC DISPLAYS [112] might be of an interest to readers.

3.3.1 Liquid Crystal Displays (LCD)

Liquid crystals were discovered in the late 19th century, with applications in displays arising at the beginning of 1970s³⁵. Liquid crystal is a material mesophase between solid and liquid, where

³⁴ MAZeT has been acquired by ams in 2016. The sensor was available as AS73210, the sensor board as AS73210-AS89010-C3. These have been replaced with a single-chip solution AS73211 that MAZeT had been developing under the name MTCS-CDCAF, with different photodiode arrangement.

³⁵ For the history of liquid crystal discovery, see e.g. <http://personal.kent.edu/~mgu>.

molecules still have freedom to move but they have a preferred orientation (inter-molecular forces tend to keep them aligned [113]). Typically, as the temperature cools down, both orientation and position of the molecules gets fixed, up to the point where the material turns crystalline solid.³⁶

For the applications in displays, two observations were critical. First, polarization of light (i.e. the orientation of transversal wave oscillation) can follow the orientation of the molecules, and second, the molecules' orientation preferences can be overridden with an electrical field. In other words, liquid crystals allow us to build an electronic switch that either keeps or changes the light polarization. Using polarization filters and colour filters, we can then build a full colour display as illustrated in Figure 3.8.

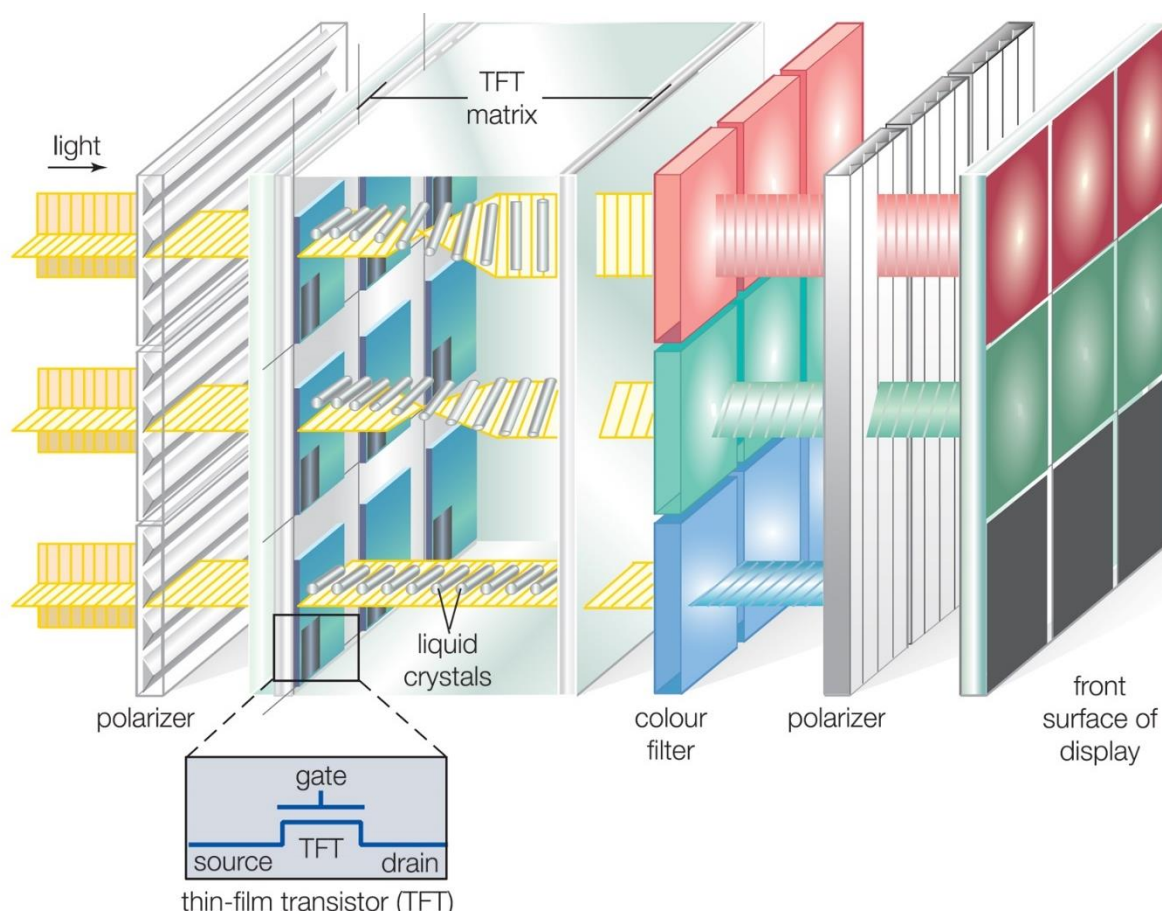

Figure 3.8. The principle of a liquid crystal display. Reproduced from [114], © 2010 Encyclopædia Britannica, Inc.

For transmissive LCDs, a constant source of white light is needed – the backlight. As technology evolves, this could be a cold-cathode fluorescent lamp, white LEDs, quantum dots and so on.

Applying linear polarizing filter results in e.g. horizontally polarized light that enters two parallel

³⁶ Such liquid crystals are called *thermotropic*, which are the ones used in most LCDs [243, p. 60]. In other types, the material phase can be affected by different factors, such as adding solvents.

planes containing cylinder-shaped³⁷ liquid crystals. In this case, the surface of the planes is treated in a way that the molecules prefer horizontal alignment on the left side and vertical alignment on the right side, therefore creating a uniformly distributed spiral that is capable of changing the polarization of light into vertical. The light can then fully pass through a vertical polarization filter and through red, green or blue colour filter, form a pixel of a display. When an electronic field is applied to the liquid crystal, it breaks the structure of the molecular spiral and the light passes unchanged with horizontal polarization which is then completely blocked by the vertical polarization filter (illustrated with the blue beam in Figure 3.8).

There are several ways in which molecules can be arranged and their orientation changed as a result of applying an electrical field; IPS (in-plane switching) is one of them. For in-depth details about LCD technology, [115] is a highly recommended reading.

In the context of this thesis, there are few important observations. Unlike other display technologies, liquid crystal displays work on the principle of subtracting light from the backlight. In particular, black is achieved by blocking all the backlight using electric power. As a consequence, the power consumption is the same or worse when displaying black compared to displaying white, and black is not true black as full light still falls on the filters that leak some of the light through. We can also imagine that it takes time for the molecules to rearrange themselves back to their preferred orientation. Finally, there is a trade-off between colour gamut and luminance: in order to increase gamut, the colour filters would have to let through narrower bands of light, effectively decreasing the total amount of light the display emits.

3.3.2 Light-Emitting Diodes (LED)

The first visible light-emitting diode (red) was realized in 1960s [116, p. 137], but it wasn't until 1993 that the first blue LED was prototyped and manufactured [117, p. 16], which is the prerequisite to both white LEDs and full-colour LED displays³⁸.

Like photodiodes discussed in 3.1.1, LEDs are diodes with a p-n junction of materials with extra free electrons and with deficiency of electrons. In the depletion layer, the free electrons fill the deficiencies, creating a nonconductive barrier. In this case, however, we apply external electric potential to the diode, which keeps taking away electrons from the p-type material and injecting

³⁷ The elongated molecules used in displays are in fact not of a cylindrical shape, but they can be treated as such since they spin around their axis very fast [244, p. 1].

³⁸ For history of LED development, see e.g. [249].

more free electrons into the n-type material, allowing the electrons to keep crossing the barrier and fill the deficiencies.

The key property here is that filling deficiencies means that electrons in higher energy antibonding orbitals take place in the lower energy bonding orbitals, and the excess energy must be released. In normal diodes, it is in the form of heat, in LEDs, the energy difference is so high that the emitted energy is in the form of visible light. In fact, the wavelength of the emitted light is directly related to the energy difference between free electrons and bonded electrons:

$$\lambda = \frac{hc}{E} \quad (3.1)$$

where h is the Planck constant, c is the speed of light in vacuum and E is the energy difference (i.e. the energy of emitted photon) in eV.

The semiconductor physics is beyond the scope of this thesis, interested readers can find an easy introduction in [118], a practical level of detail in [31] and in-depth reference in [106]; however, there are a few takeaway points for the purpose of our discussion. First, the colour of the light depends on the energy levels of atom orbitals, which not only means that it depends on the physical material used in the LED, but also that there is only a limited set of colours we can produce this way. Most notably, there are no currently known materials that would directly produce bright green light in the range of 530-570 nm, also known as the *green gap* [119, p. 264]³⁹. Unlike in LCD where colour is procured by relatively wide colour filters, LEDs emit light directly, with a very narrow band of wavelengths⁴⁰. As a consequence, LED can provide much higher colour gamut and also save power when emitting less light.

3.3.3 Electronic Paper Displays (EPD)

A natural choice when trying to mimic a reflective surface would be a truly reflective display, also called e-ink or electronic paper display. Like LCDs, their development started in the 1970s,

³⁹ Notice the gap in the spectra of tunable LED lights used in this thesis, Figure 3.12. Another option to create green LEDs is to use blue light with phosphor that re-emits it at higher wavelengths. However, these are usually much less saturated in colour (have wider spectrum). For recent developments on the green gap, see e.g. [250].

⁴⁰ Except for laser LEDs that use resonance, the light from LED is not strictly monochromatic; first due to the materials used in their construction and second due to slight variations in the energy differences between the two levels [93, p. 50] (also see [30, pp. 44-45]).

however, it was struck with several problems [39, p. 2408]. The effort was renewed in 1997 by E Ink Corporation, but the market adoption is still minimal⁴¹.

A few electronic paper technologies are being developed: electrophoretic that uses electric charge to move small coloured particles (see Figure 3.9), electrowetting which moves coloured oil within water, electrofluidic that uses pressure to move coloured pigment dispersion, and electrochromic that relies electrochemical reactions in the material.⁴² Note that some of these technologies are not even available as commercial displays on the market [39, p. 2493], the electrophoretic micro capsules with coloured particles are used in 90 % of all electronic paper products [120, p. 463]. One advantage of these displays is that they require electrical power only to change the content of the display, not to sustain it (they are *bi-stable*).

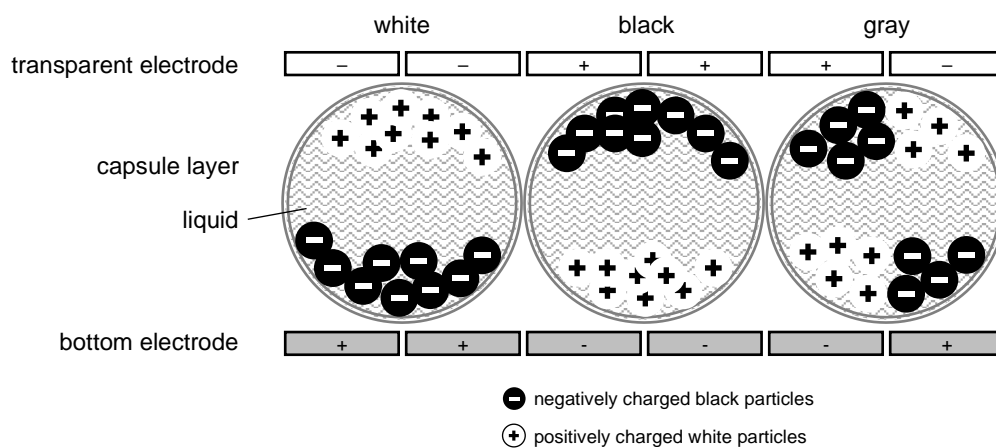

Figure 3.9. The principle of an electrophoretic display. The particles are already pre-charged and electric power is used to attract them to one side or another. Adapted from [120].

However, they also have serious drawbacks. Most of the displays on the market are one colour, usually black, and although the research of full coloured e-ink displays is producing first products, the colour range of the commercially available displays is still nowhere near the emissive ones (see e.g. Figure 3.10)⁴³. Since physical particles need to travel some distance in a liquid, the display refresh rate is very slow, from tens to a few

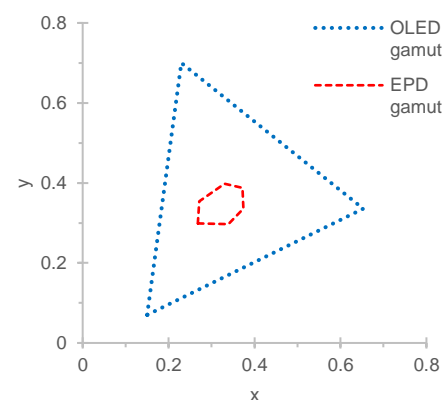

Figure 3.10. EPD vs OLED colour gamut. In CIE 1931 xy coordinates. Adapted from [96].

⁴¹ In 2019, the global display market was valued at \$18.0 billion [252] while the EPD market was valued at \$2.6 billion [253], making it about 2.2 %.

⁴² For more details on these technologies, see e.g. [94].

⁴³ A representative of E Ink Corporation told me at embedded world 2019 that this is unlikely to improve as there is no market demand for colour e-ink displays. Another manufacturer was questioning the use cases for colour displays too.

hundreds of milliseconds [39, p. 2411]. Another problem is *ghosting*. The voltage is used to move particles from their previous location to a new one, but the uncertainty of where the particles currently are increases over time, resulting in ghosts of previous images being visible. The solution is to bring the particles to a known state every now and then (or before every new image if the controller does not keep track), typically by flashing the display through full black-white-black cycle. Together with the slow refresh rate, this makes EPDs unusable not only for video but also for basic user interaction such as cursor movement, scrolling, zooming etc.

It should be also mentioned that displays that are both transmissive and reflective⁴⁴, or that can switch between these two mechanisms are being developed [121], but their availability and adoption is even smaller than of the electronic paper displays.⁴⁵ While there is no reason why the technical challenges above could not be overcome in the future (given sufficient market demand), this thesis focuses on the ubiquitous emissive screens, arguing that any of the million cheap emissive displays already deployed in the world can turn into a paper-like display now, with all the advantages of fast response and wide colour gamut.

3.4 Displays Used in This Work

3.4.1 Fujitsu-Siemens Q584 Tablet

The main display used in all experiments and deployments was a screen of a high-end Fujitsu Siemens Stylistic® Q584 Tablet PC driven by Intel HD Graphics display adapter. As per Fujitsu support service, the tablet contains an LCD panel made by Panasonic, model number VVX10T025J00. It is a 10.1" in-plane switching (IPS) display with 2560×1600 pixels resolution and pixel density of 300 ppi, each pixel being $28.25 \times 84.75 \mu\text{m}$. Typical viewing angle is 160° in both horizontal and vertical directions and the maximum brightness is 400 cd/m^2 . Further specification can be found in Table 3.2. The datasheet states it takes about 10 minutes for the display to reach stable conditions.

⁴⁴ Sometimes called *transflective*.

⁴⁵ For description of various transflective and upc, see e.g. [88].

| | Symbol | Minimum | Typical | Maximum | Unit |
|---------------------------------|-------------------|---------|---------|---------|-------------------|
| Contrast ratio | CR | | 1000 | | |
| Response time | $T_r + T_f$ | | | 30 | ms |
| Brightness of white | B_{wh} | 280 | 400 | | cd/m ² |
| Brightness of uniformity | $B_{uni}(9point)$ | 65 | | | % |
| Colour chromacity (CIE) | Red | x | 0.612 | 0.642 | 0.672 |
| | | y | 0.315 | 0.345 | 0.375 |
| | Green | x | 0.271 | 0.301 | 0.331 |
| | | y | 0.600 | 0.630 | 0.660 |
| | Blue | x | 0.119 | 0.149 | 0.179 |
| | | y | 0.055 | 0.085 | 0.115 |
| | White | x | 0.279 | 0.309 | 0.339 |
| | | y | 0.309 | 0.339 | 0.369 |
| NTSC | | | 72 | | % |
| Gamma | | | 2.2 | | |

Table 3.2. Display specification according to the LCD panel datasheet, measured in a dark room with CS 1000A spectroradiometer in the centre of the display area.

The display has a backlight unit consisting of 48 white LEDs, 6 diodes per string, 8 strings in total. The PWM frequency ranges from 100 Hz to 5 kHz with duty cycle from 1 % to 100 %. The screen filter provides red, green and blue channels. The spectral response of the individual channels fully activated can be seen on Figure 3.11, together with the display gamut measured for all boundary sRGB values.

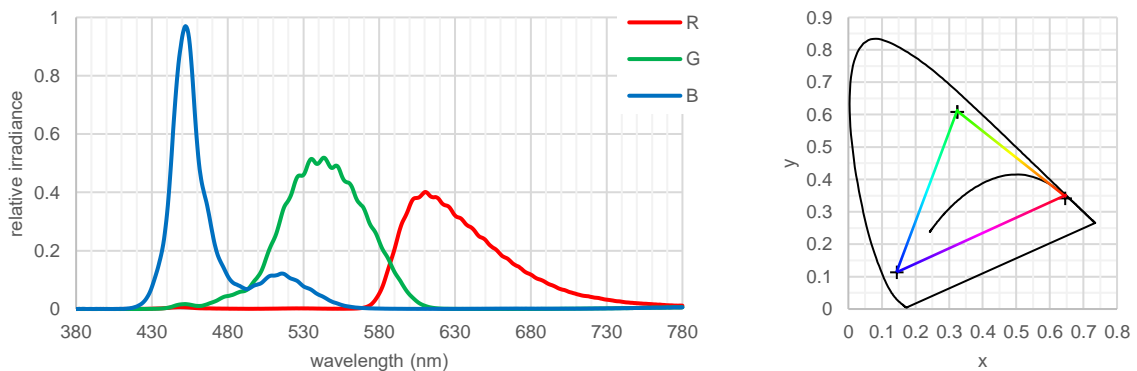

Figure 3.11. Measured characteristics of Fujitsu tablet display. Left: spectra of RGB display individual channels at their maximum values, normalized to blue. Right: display gamut in CIE 1931 2° model.

3.5 Lights Used in This Work

3.5.1 LT-01 Spectrally Tunable Lights

For colorimetry experiments, spectrally tunable, multi-channel solid state lighting was used, manufactured by Ledmotive (prototype model LT-01). Each luminaire contains 12 unique LED

channels⁴⁶, each driven by an independent circuit individually controlled via USB. The desired illumination is generated by setting weights for the individual LED channels, which are 12-bit numbers that control the electrical current going to the LEDs. Each LED channel emitted light with different spectrum and peak wavelength, together covering the whole visible spectrum (see Figure 3.12 for the spectral characteristics). The set of the illuminants that can be produced, i.e. the lights' gamut, is then a linear combination of the spectra of the individual LED channels.

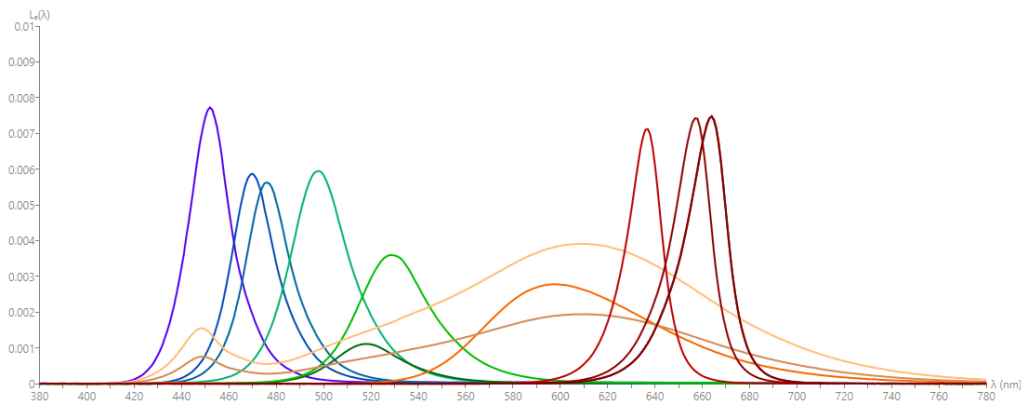

Figure 3.12. Spectra of 13 individual LED channels in LT-01 illuminator at their maximum intensity.

The lights were controlled directly from the study software using virtual serial port (115200 baud rate, no parity, 8 data bits, 1 stop bit). The packet structure to set all LED channels to given power levels is described in Table 3.3.

| | | | | | | | |
|------|---------|-------------------------|-------------------------|-----|--------------------------|--------------------------|------|
| STX | command | 1 st channel | 1 st channel | ... | 16 th channel | 16 th channel | ETX |
| 0x02 | 0x69 | [15:8] | [7:0] | | [15:8] | [7:0] | 0x03 |

Table 3.3. LT-01 packet structure for setting LED channels power values.

3.5.2 LLC010 Iris Philips Hue Lights

Philips Hue is a consumer product line of colour changing LED lamps, introduced by Philips Lighting in October 2012⁴⁷. The *white and colour ambience* product range allows users to change the light to an arbitrary colour, potentially providing an interesting and affordable alternative to spectrally tunable lights. 'Smart lights' have since become widely popular – Philips Hue lights are in their 4th generation and following their success, many other companies have joined the market, such as Belkin, Elgato, GE, Hive, Ikea, LIFX, LightWaveRF, Osram, TP-Link or WIZ [122, 123, 124]. The consequences for researchers are twofold. First, the range of light that technology is exposed to in an environment, especially home, is much wider; it is no longer enough to make a display

⁴⁶ Channels 8 and 10 (in the yellow area) only differ in radiometric power.

⁴⁷ <http://www.meethue.com/>

match a warm or cold white. Second, users are now able to produce saturated colours themselves, without specialized training. In the paper-like display system presented in this thesis, we take advantage of the latter to solve the former (see 5.3 for details).

Philips Hue lights are also becoming popular in the academic research in HCI [125], ubiquitous computing [126], affective computing [127], smart homes [128], workspace lighting [129], security [130], healthcare [131], qualitative methods [132] etc., yet to the best of my knowledge, there hasn't been any publication depending on achieving specific colours or evaluating the lights from a colorimetric perspective.

The Hue lights come in three different gamuts, denoted A, B and C (see Table 3.4 for comparison of the gamuts). The lights used throughout this thesis are model Iris, model number LLC010 (swversion 66013452), with 210 lm of flux and gamut A, which contains the most saturated colours of the three.

| Gamut | A | | B | | C | |
|-------|--------|--------|-------|-------|-------|-------|
| | x | y | x | y | x | y |
| red | 0.704 | 0.296 | 0.675 | 0.322 | 0.692 | 0.308 |
| green | 0.2151 | 0.7106 | 0.409 | 0.518 | 0.17 | 0.7 |
| blue | 0.138 | 0.08 | 0.167 | 0.04 | 0.153 | 0.048 |

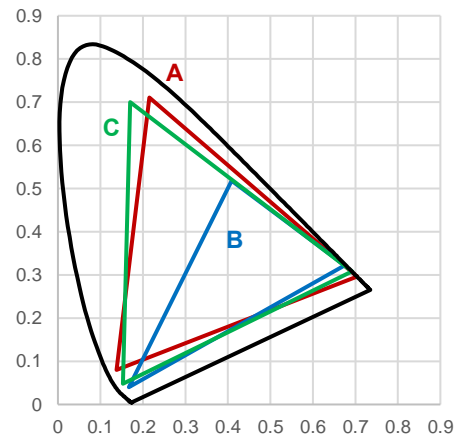

Table 3.4. Philips Hue gamut coordinates in xy. Data provided by Philips to developers, using CIE 1931 2° CMFs.

The lights are controlled via ZigBee Light Link (ZLL), so users typically need to use a Hue Bridge (swversion 01018228) that provides a HTTP API to control the lights over TCP/IP network. The API supports setting the colour by means of either brightness (1-254) and either hue (0-65535) and saturation (0-254), which are relative to the hardware, or absolute CIE xy coordinates (decimal

floating point). The number, type and colour of LEDs in the lights are not published, and neither is the algorithm transforming given xy coordinates into their power levels and back⁴⁸.

The light spectrum for the three gamut corners and a white (meaning hue=0, saturation=0) measured by CS-2000 of a calibration tile according to the setup in Figure 3.13⁴⁹ is plotted in Figure 3.14, clearly showing the light contains red, green and blue LEDs, with their peaks at 633 nm, 520 nm and 466 nm, respectively.



Figure 3.13. Philips Hue lights spectral measurement set-up.

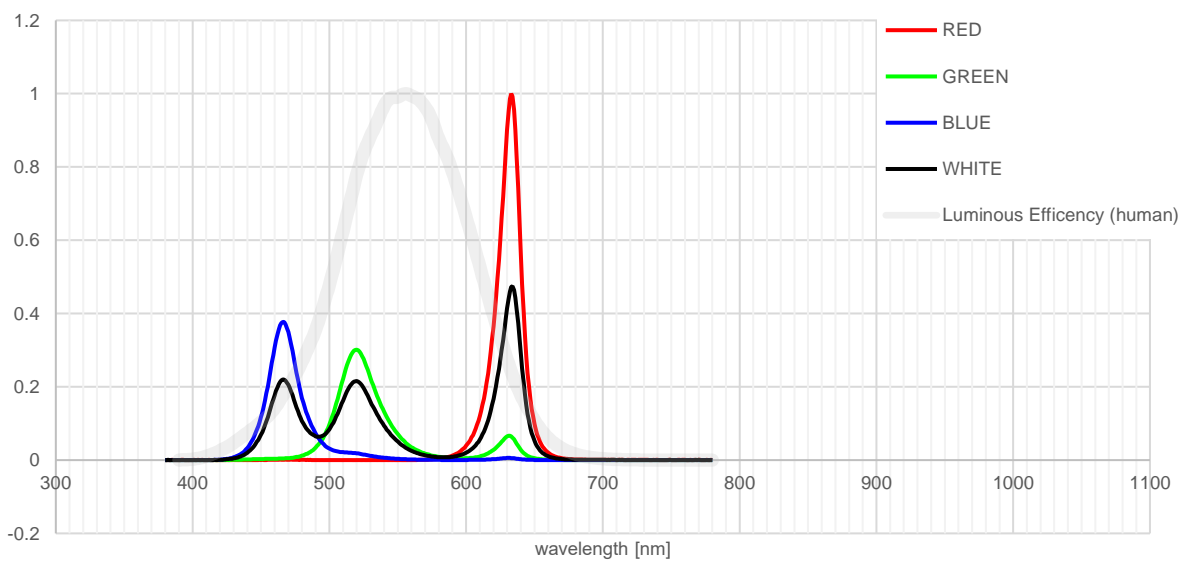

Figure 3.14. Philips Hue lights spectra for red, green blue and white settings. Measured, normalized to red.

⁴⁸ In fact, this algorithm differs depending on the swversion, at least between 66009461 and 66013452 which among others fixed a mapping errors discovered during the testing conducted in this thesis.

⁴⁹ As this was my first encounter with the colorimetric equipment and procedures, I am grateful to Stacey Aston for her help with setting up and obtaining these measurements.

The RGB LEDs cannot be controlled directly through the bridge; the firmware in the lightbulb tries to achieve the given xy coordinates to the best of its abilities, but it is also able to report the xy coordinates of the current light shown. That raises two questions: how well it is able to fulfil the requested colour, and how long does it take to reach the final value. For answers to these questions, please refer to the in-depth analysis in Appendix A.

Chapter 4. Cross-Media Colour Matching Experiment: Study of Human Vision under Extreme Lighting Conditions⁵⁰

The goal of the thesis is to propose a way of making displays calm by allowing them to physically blend into the environment. The hypothesis is that if a display surface behaves like a reflective surface such as paper – which we perceive as inherently calm – in the way it reacts to the environment, it will gain some of these inherent calm qualities.

In the next chapter, we will design an algorithm that tries to perform this very task. The fundamental question that arises is how precise such algorithm has to be in order for users to not see a difference between display and paper? In this chapter, we will conduct a psychophysical experiment to look into what people consider to be a colour match between display and a paper.

4.1 Experiment Set-up

Observers viewed the display and the paper side by side in an enclosed booth of $78 \times 100 \times 77$ cm dimensions. For the illustration of the set-up, please refer to Figure 4.1. The interior of the booth had white painted walls with two multi-channel LED lamps at the top pointing downwards. The booth had a rectangular viewing aperture of 13.5×9 cm, inset 26 cm from the front side. The aperture restricted the observers' view to only a 50 by 30 cm portion of a fronto-parallel surface inserted in front of the back wall of the booth. This surface was covered with a black background, on which two stimuli were placed: the display and the paper, the visible surfaces of each being 13.1×13.1 cm in size, subtending 10° each. The observers could only see the black background, display on the left and paper on the right, having centres 20 cm apart from each other. Observers viewed the scene in a dark room, from a distance of about 75 cm (supported by a fixed chin rest).

⁵⁰ The study and some of the results were presented in [201], [290] and Colour 2019 conference in Leeds.

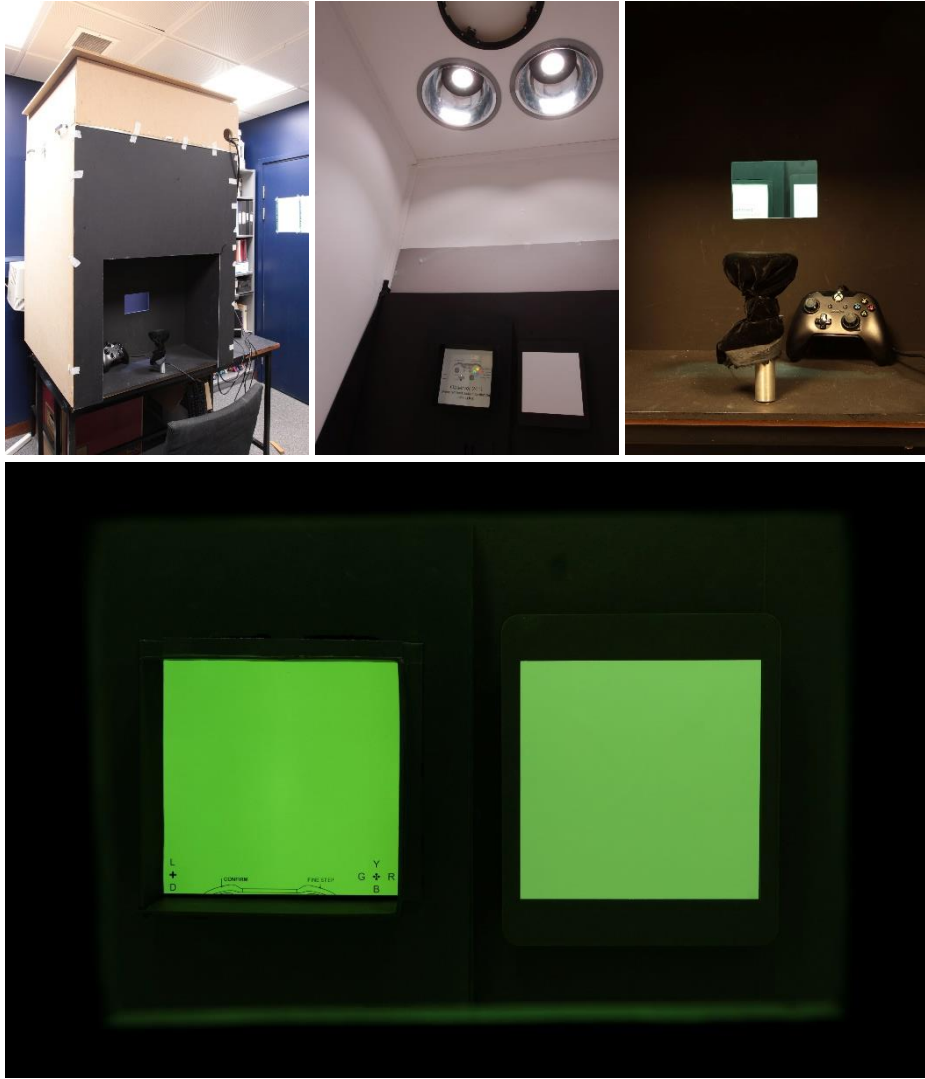

Figure 4.1. Colour matching experiment set-up. Dark room with experiment booth (top left), booth interior with LED lamps (top), chin rest with controller (top right), observer's view – aperture with shaded display on the left, paper sheet on the right (bottom).

4.1.1 Display

The display used was a screen of the Fujitsu tablet as introduced in 3.4.1. The tablet was positioned in portrait mode and only the central square of 13.1×13.1 cm of the screen was visible to observers (roughly corresponding to $[20, 240]$ – $[790, 990]$ pixels area⁵¹). The remainder was blocked using black core 1.4 mm strong mount board. A rectangular standing shade made from the same mount board was fixed to the border of the visible area, preventing direct light from the LED lamps to reach the screen surface.

⁵¹ The notation is [left, top]–[right, bottom], where $[0, 0]$ is the top left corner of the display in portrait mode.

The real gamut of the display as measured is in Table 4.1.

| | | Symbol | Minimum | Typical | Maximum | Measured |
|---------------------------------|-------|--------|---------|---------|---------|--------------|
| Colour chromaticity (CIE) | Red | x | 0.612 | 0.642 | 0.672 | 0.647 |
| | | y | 0.315 | 0.345 | 0.375 | 0.342 |
| | Green | x | 0.271 | 0.301 | 0.331 | 0.305 |
| | | y | 0.600 | 0.630 | 0.660 | 0.632 |
| | Blue | x | 0.119 | 0.149 | 0.179 | 0.148 |
| | | y | 0.055 | 0.085 | 0.115 | 0.089 |
| | White | x | 0.279 | 0.309 | 0.339 | 0.318 |
| | | y | 0.309 | 0.339 | 0.369 | 0.346 |

Table 4.1. Fujitsu tablet gamut specified vs measured.

The uniformity of the visible area⁵² of the display was measured using CS-2000 (3.2.1) on regular grid of 7×7 points, at multiples of 100 px. For luminance, the uniformity was consistent across all conditions, ranging from 92.8 to 93.2 % in the CIE LAB space, spanning ΔL^* of 7.2 on average (see Figure 4.2 left for details). For chromaticity, the uniformity varied from condition to condition (listed in 4.1.3.2 below). Yellow was the most uniform condition, spanning Δa^* of 2.6 and Δb^* of 5.3, while blue was the least uniform one, spanning Δa^* of 4.5 and Δb^* of 10.9. For an average chromatic difference from mean, see Figure 4.2 centre and right, for a per-condition overview see Appendix C.

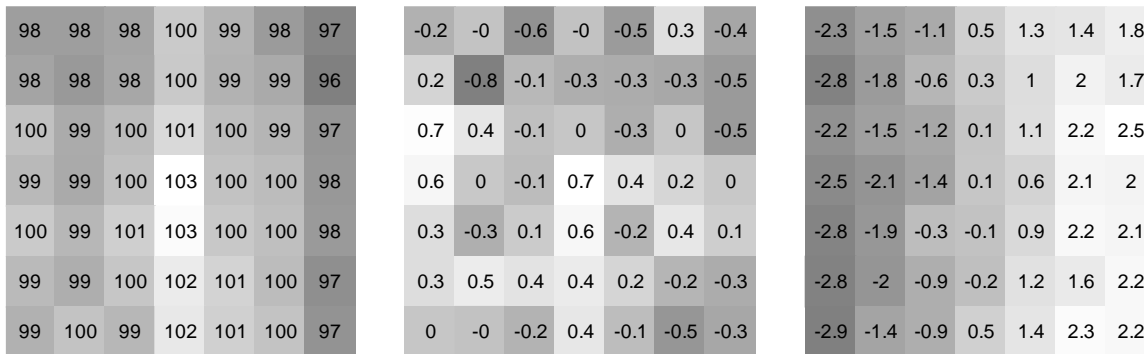

Figure 4.2. Uniformity of display's visible area for brightness (L^* values, left) and chromaticity differences from the mean value (a^* centre, b^* right), averaged across all conditions. Shading exaggerated for illustrative purposes.

All experiments and measurements were done with the backlight set to its maximum.

4.1.2 Paper

For proper colorimetric evaluation, the paper stimuli were constructed from standardised sheets from the RAL DESIGN SYSTEM *plus*. The use of standard sheets not only helps other researchers to

⁵² Uniformity is defined as the minimum measured value divided by the maximum measured value.

reproduce the experiment, but also allows new results to be obtained in a systematic manner. The A4 sheets have been cut into 13.1×13.1 cm squares and put on a black foam core so that the paper and display surfaces were at the same distance from the observer. For the experiments described in this thesis, three different paper sheets were used (listed in Table 4.2, for their spectral characteristics, see Figure 4.3).



| | RAL colour code | alternative name | light reflectance value |
|---|-----------------|------------------|-------------------------|
|  | 000 90 00 | winter white | 76.51 |
|  | 070 80 40 | apricot yellow | 59.01 |
|  | 340 80 20 | bonbon rose | 58.19 |

Table 4.2. List of RAL sheets used in the experiment.

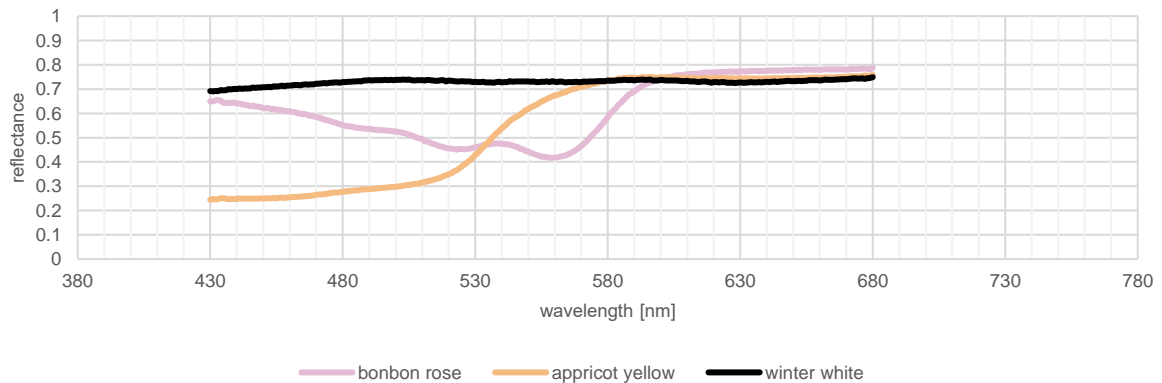

Figure 4.3. Spectral reflectance of RAL sheets used in the experiment. Measured under D65 light, cropped to 430–680 nm for accuracy due to spectral limits of the light source.

The winter white is the most reflective achromatic card available. For the follow-up experiments, 23 sheets of other colours, uniformly spaced across hue and several chroma values were measured. However, due to the nature of the experimental conditions (i.e. requiring as chromatic illumination as possible), most of the colours reflected from the sheets were out of the gamut for the display. The apricot yellow card was chosen for two reasons. First, the yellow-orange range of hues is available in wide range of chroma and high lightness (as can be seen in Figure 2.29), of which all fall in gamut of the display with enough margin. Second, as we will see later, the results exhibited an interesting pattern for the yellow light conditions, and the choice of the apricot yellow sheet allowed us to explore this area further in the follow-up experiment. The bonbon rose sheet was chosen because it is 90° from the apricot yellow in hue, with its chroma still within gamut of the display.

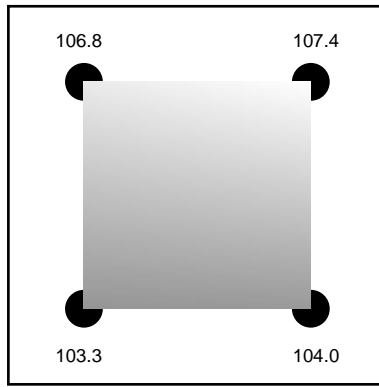

Figure 4.4. Interpolated uniformity of reference paper sheet (L^* values) with indicated measurement points. Shading exaggerated for illustrative purposes.

Uniformity for the paper (due to illumination from top) was 96.2 % for luminance in the CIE LAB space, spanning ΔL^* of 4.1. The chromaticity values spanned Δa^* of 0.08 and Δb^* of 0.65.

4.1.3 Lights

The illumination source used is a spectrally tunable light by Ledmotive as discussed in 3.5.1. Two of their prototype luminaires LT-01 illuminated the experimental both from the top, from 70 cm above the top edge of stimuli. Any given colour needs to be represented as a linear combination of the spectra of the individual LED channels.

4.1.3.1 Spectral decomposition

Finlayson et al. [133] showed how to describe almost the entire set of spectra that correspond to a given colour specified by its tristimulus coordinates, i.e. a set of metamers. Any colour within the gamut can be expressed as practically an infinite number of channel combinations (metamers), so further constraints need to be specified to produce a deterministic, well-defined spectral representation for a given colour.

In this experiment, we are interested in the smoothest spectrum possible, since that most resembles naturally occurring light [133]. Smoothness can be defined in several ways; in the existing colorimetry literature, it is usually expressed using total variation [134, 133, 135]. Intuitively, total variation is a measure of how much a function changes on an interval, which can be formally defined as the largest sum of differences on any division \mathcal{P} of the interval $[a, b]$, where $S(\lambda)$ is the spectral power distribution:

$$TV_b^a(S) = \sup_{\mathcal{P}} \sum_{i=0}^{n_{\mathcal{P}}-1} |S(\lambda_{i+1}) - S(\lambda_i)| \quad (4.1)$$

For monotonic functions, the interval with the biggest difference is the whole interval and the total variation is the difference between the function values at the interval boundary points. Conversely, for non-monotonic functions, the biggest sum of differences is achieved by dividing the interval into parts where the function is monotonic.

If the function is differentiable and piece-wise continuous (which we expect for a natural spectral radiance function), an equivalent definition is to sum up the amount of change in every point of the function (i.e. gradients),

$$TV_b^a(S) = \int_a^b |S'(\lambda)| d\lambda, \quad (4.2)$$

provided that $S'(\lambda)$ is Riemann integrable⁵³.

However, as can be seen from the intuition above, the total variation of a monotonic function depends only on its values at two boundary points. In particular, a linear function and a staircase function, for example, might have the same total variance, while we clearly prefer the former as smoother.

In order to resolve this issue, C. van Trigt [134] suggested squaring the derivative. That way, large changes are penalized more than small changes, and the problem then becomes one of minimizing the quadratic variation. Formally, from a set of all possible spectral representations $S_i(\lambda)$ for a single given colour, we are looking for the one that satisfies

$$\min_i \int_{\lambda} \left(\frac{dS_i(\lambda)}{d\lambda} \right)^2 d\lambda. \quad (4.3)$$

Note that for continuous non-negative functions such as spectra, this metric is equivalent to a one using arc length of the function curve

$$\min_i \int_{\lambda} \sqrt{1 + S_i'(\lambda)^2} d\lambda, \quad (4.4)$$

since adding a constant and applying square root does not affect ordering of the metamer set in respect to these two metrics. Length of curve distinguishes various monotonic functions intuitively, and, as well as the total variation, reaches minimum for constant functions.

⁵³ Equivalence of these two definitions is non-trivial and generally omitted from the literature. An approachable proof can be found in C. Heil's lecture notes on real analysis, to be published in chapter 5.5 of [12].

Aston [136], following Li & Luo [137], shows, that solving (4.3) is equivalent to solving

$$\min_{\mathbf{w}} \|\mathbf{DAw}\|^2 = \min_{\mathbf{w}} (\mathbf{w}^T \mathbf{A}^T \mathbf{D}^T \mathbf{DAw}), \quad (4.5)$$

where \mathbf{w} is the specified vector of weights for individual LED channels, \mathbf{A} is a matrix representing the spectral radiance functions (metamers among which we look for the minimum in columns, sampled function values in rows), \mathbf{D} a constant matrix, under the condition

$$6.83 \times \mathbf{R}^T \mathbf{Aw} = \begin{bmatrix} X \\ Y \\ Z \end{bmatrix} \quad (4.6)$$

where \mathbf{R} is a matrix representing the colour matching functions and $[X \ Y \ Z]^T$ the desired colour (for more details, see [136]). A MATLAB script written by Michal Mackiewicz and others [133] was used to solve this optimization problem for the CIE 2012 2° CMF using quadratic programming.

Dr. Gaurav Gupta performed the lights calibration and generated the experiment conditions.

4.1.3.2 Experiment conditions

Since we are interested in colour matching performance under chromatic illuminations, we would like the light conditions to be as chromatic as possible. The boundaries to that requirement are determined by the gamut of the lights as well as the gamut of the display that needs to be able to match them. We also want to allow observers to comfortably approach the target colour from all directions of the colour space. Therefore, the light conditions were determined as follows:

1. Red, green and blue: generated by moving the Yxy primary tristimulus coordinates of the corresponding R, G, and B primaries of the display towards equal energy white by 25 %.
2. Yellow, cyan and magenta: corresponding to the geometrical midpoints of the points above.
3. White: D65 illuminant chromaticity coordinates.
4. Daylight yellow and daylight blue: corresponding to 2650K and 10000K on the Planckian locus, respectively. Both the yellow and daylight yellow conditions lie on the line connecting green and red colours above in the chromaticity diagram.

Considering the gamut of the lights, the Y coordinate was arbitrarily fixed to 50.0 for all light conditions. The exact condition target coordinates are shown in Table 4.3; see Figure 4.5 for light conditions in comparison to the display's gamut.









| Condition name | x | y | Y |
|---|--------|--------|------|
|  red | 0.5358 | 0.3333 | 50.0 |
|  green | 0.3333 | 0.5358 | 50.0 |
|  blue | 0.2058 | 0.2058 | 50.0 |
|  cyan | 0.2733 | 0.3933 | 50.0 |
|  magenta | 0.4008 | 0.2658 | 50.0 |
|  yellow | 0.4383 | 0.4383 | 50.0 |
|  white | 0.3127 | 0.3290 | 50.0 |
|  daylight yellow | 0.4634 | 0.4107 | 50.0 |
|  daylight blue | 0.2807 | 0.2942 | 50.0 |

Table 4.3. List of CIE 1931 coordinates used to generate the illumination conditions. See Appendix A for the corresponding LED channel settings.

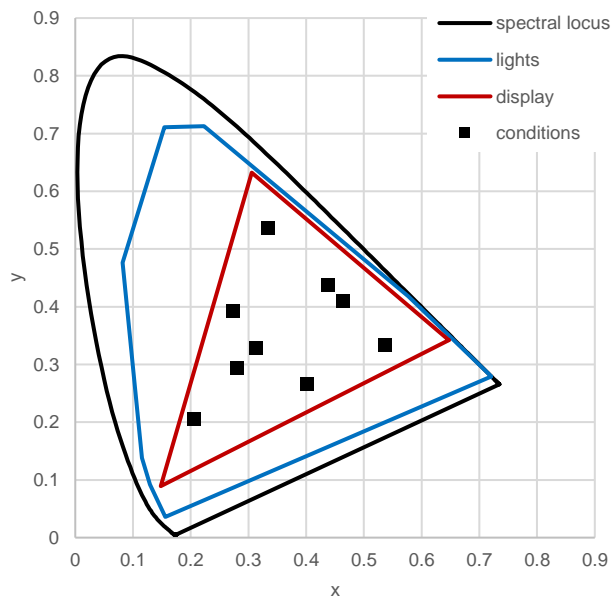

Figure 4.5. Experiment conditions compared to display and lights gamut.

The lights were calibrated using Konica Minolta’s spectroradiometer CS-2000 (3.2.1). Radiance measurements of individual LED channels were taken from a polymer white reflectance tile placed at the position of the paper sheets, and these basis functions were used in the spectral decomposition algorithm described above to produce the desired light colours. The final light spectra of individual light conditions can be seen in Figure 4.6.

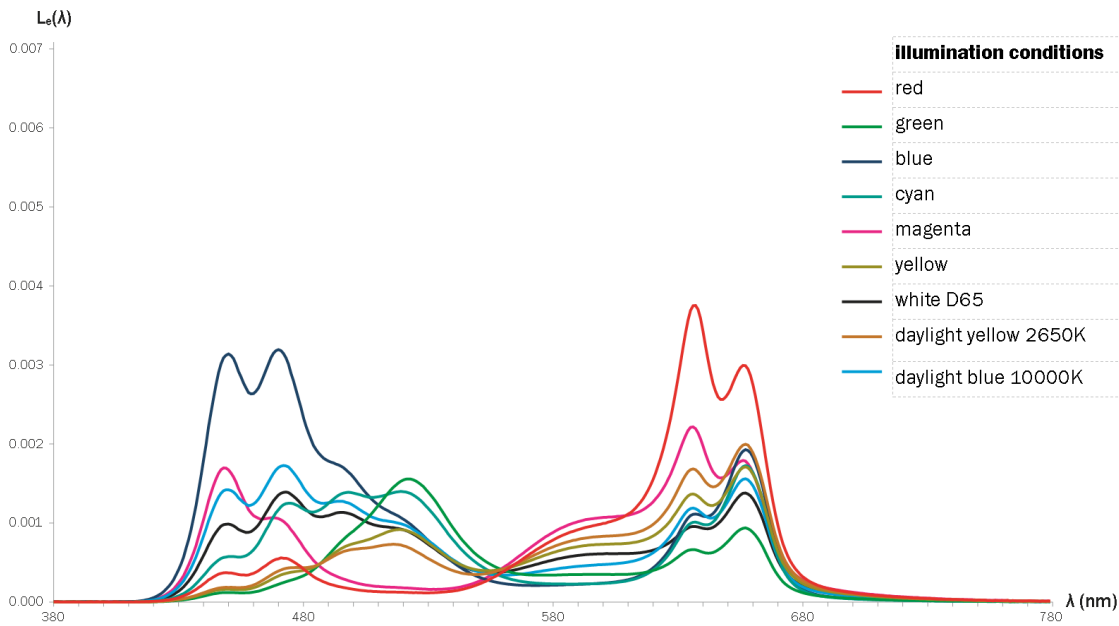

Figure 4.6. Spectral radiance from white card under 9 test illuminations.

4.2 Observers

In total, 25 observers were recruited (12 male, 13 female, aged 18 to 38 with median of 27) using e-mail advertisement across an HCI department, word of mouth and the School of Psychology Research Participation Scheme. Each observer was given an information sheet with details about the study and provided written consent for participation in the study and basic demographic information.

Among the observers, 16 self-identified as Caucasian, the remaining ethnicities being Arab, Asian, Greek, Indian and mixed. Observers also self-reported eye colour, with 13 reporting brown, 7 blue, 2 each grey and green, and one black. Since the experiment involved manipulating a handheld controller and colour naming, we enquired about handedness (6 observers were left-handed, one ambidextrous and the rest right-handed) and observers' first language (13 observers reported English).

Three observers finished the experiment for all three paper sheet conditions, four observers finished the experiment with the winter white and apricot yellow paper sheets only, 16 observers did only the winter white paper sheet and 2 observers did only the apricot yellow condition; see Table 4.5 for number of participants per each condition.

4.3 Experiment Procedure

Observers were pre-screened using Ishihara test plates for “red-green” colour vision deficiencies (“blue-yellow” colour vision deficiency is extremely rare [138]). The plates consist of what appears

to be randomly arranged, sized and coloured dots that form different numbers or shapes for people with normal vs. anomalous colour vision, and, for some plates, for distinct types of colour vision deficiencies. Observers are asked to read numbers from the plates under daylight, and, their answers are assessed using standard scoring techniques, the results of which classify observers into types and degrees of colours vision deficiencies. In this study, plates № 1—25 of the 38 plates edition were used. Observers with any colour vision deficiency would have been excluded from the experiment, but all observers exhibited normal trichromatic colour vision (the requirement of no colour vision deficiencies was stated in both the experiment advertisement and the information sheet).

After the colour vision test, observers entered the experiment room and were instructed about the experiment under D65 light. They were taught how to control the display using the provided handheld controller, encouraged to adjust their chair so that they can comfortably rest their chin on a stand and instructed to look at either the display or the paper, not in the middle and not to cross their eyes. The experimenter remained in the dark room at all times during the experiment, and observers were allowed to talk if needed and to ask for help whenever they got stuck with the task.

4.3.1 Navigating the Colour Space

Observers used an Xbox One controller to navigate the CIELAB colour space. In consonance with previous studies [139], pressing various buttons on the controller changed the colour on display in discrete steps (as opposed to continuous change using joysticks). The controller has four buttons on the right side, \textcircled{A} , \textcircled{B} , \textcircled{X} and \textcircled{Y} arranged in a cross, intended to be controlled with the right thumb, and a 4-way directional pad on the left side controlled with the left thumb (see Figure 4.7). Observers could use the buttons to move within the chromaticity plane as traditionally projected, i.e. top button increased the a^* value while bottom button decreased it, and right button increased the b^* value while left button decreased it. Similarly, pressing the directional pad in the upwards direction increased the L^* value and pressing it in the downwards direction decreased it, while the chromaticity stayed constant.

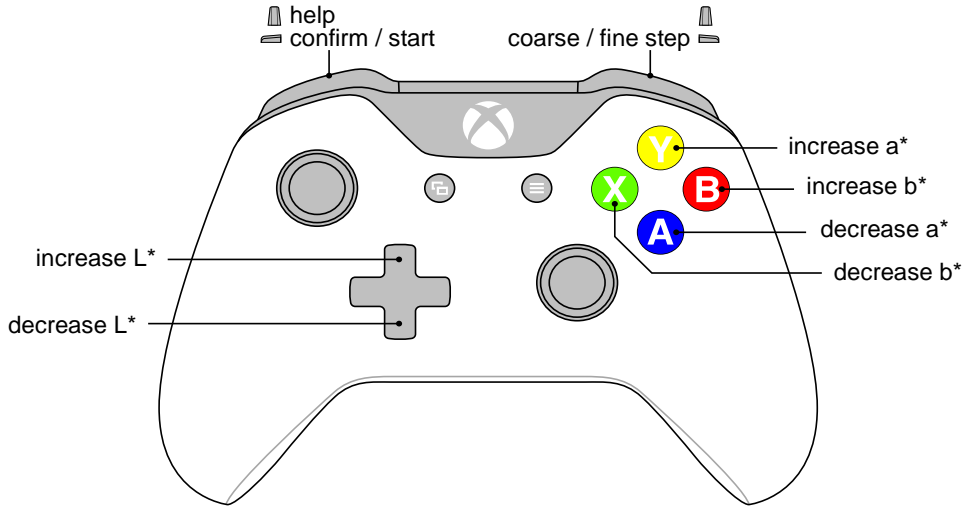

Figure 4.7. Xbox One controller schema and the way observers could control the display. Image based on work by Ratiocinator, with permission.

A non-trained observer wouldn't be able to interpret this terminology, so the display provided hints in more familiar terms, namely “more yellow”, “more green”, “more blue”, “more red”, “darker” and “lighter”. A picture similar to Figure 4.7 was shown until confirmed before each trial of the experiment, and small help with the button assignments was always visible in black colour at the bottom part of the screen whenever the colour matching task was performed, unless the observer switched the help off using the left trigger button (see Figures 4-4 for the user interface available to the observers).

Observers could switch between coarse and fine steps using the right shoulder button. A fine step was defined as the smallest step in the desired direction that would result in any change of the display output in terms of 8-bit sRGB values. In practice, this was achieved by an iterative process, since the colour space is non-linear. First, we need to find the minimum distance ΔE_{ab}^* anywhere along one of the axes in the CIELAB space that results in a change in the sRGB space.

Remembering the Euclidean distance formula

$$\Delta E_{abL}^* = \sqrt{\Delta L^{*2} + \Delta a^{*2} + \Delta b^{*2}}, \quad (2.34)$$

we can see that moving along axes (the only direction in which observers could make steps) means minimizing one of ΔL^* , Δa^* and Δb^* , the other two being zero. All of L^* , a^* and b^* coordinates depend on the lightness, with L having the lowest multiplication constant. Moreover, from the shape of the colour space (refer to Figure 2.26), it is clear that to have any contribution from the chromaticity component, one also needs to change lightness when moving from the black and white corner points. In other words, the ΔE_{ab}^* distance from black $[0 \ 0 \ 0]_{RGB}^T$ to blue $[0 \ 0 \ 1]_{RGB}^T$

is larger than from black to grey $[1 \ 1 \ 1]_{RGB}^T$ because, following the Pythagorean theorem, in both cases, lightness needs to be increased to achieve the value of 1, but for blue, the distance in CIELAB is further increased by moving away from the achromatic axis.

Let's focus on the minimal distance in lightness only then. When transforming from sRGB through XYZ to LAB, the L values are computed in 3 different ways. First, the sRGB values need to be corrected for companding, i.e. linearized with respect to energy (see also chapter 2.5). This splits the range in two parts, linear and non-linear,

$$v = \begin{cases} V/12.92 & \text{if } V \leq 0.04045 \\ ((V + 0.055)/1.055)^{2.4} & \text{otherwise} \end{cases} \quad (2.19)$$

where V resp. v stands for any of the RGB channels (all channels are equal for achromatic colours). The sRGB to XYZ resp. Y transformation is trivial, since, for D65 reference light,

$$Y = 0.2126r + 0.7152g + 0.0722b = 1.000v = v. \quad (2.15)$$

Finally, the XYZ to LAB transformation splits the range in another two parts, linear and non-linear, which after solving for v gives

$$L = \begin{cases} \kappa v & v \leq \epsilon \\ 116\sqrt[3]{v} - 16 & \text{otherwise} \end{cases} \quad (2.23)$$

Evaluating at the boundary values for V and v , we get the segments in Table 4.4. The last column shows how much ΔL is needed to result in a change of 8-bit sRGB value on a display.

| V_8 | $V=V_8/255 \leq$ | $v \leq$ | $L \leq$ | L | dL/dV_8 |
|---------------|------------------|----------|----------|--|---|
| 0-10 | 0.04045 | 0.003135 | 2.8316 | $L \cong 0.2742V_8$ | $L' \cong 0.2742$ |
| 11-23 | 0.09221 | 0.008856 | 8 | $L \cong (0.0634V_8 + 0.8886)^{2.4}$ | $L' \cong (0.01650V_8 + 0.2314)^{1.4}$ |
| 24-255 | 1 | 1 | 100 | $L \cong (1.4151V_8 + 19.8464)^{0.8} - 16$ | $L' \cong 1/(0.761V_8 + 10.6732)^{0.2}$ |

Table 4.4. L as function of 8-bit achromatic sRGB values.

Analytically or from the Figure 4.8 it can be seen that the smallest ΔL needed is in the first, linear segment, and it's approximately equal to 0.2742.

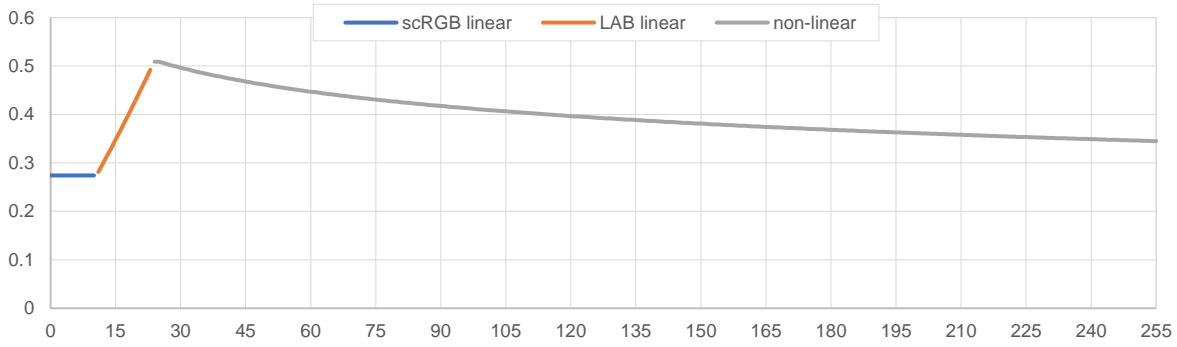

Figure 4.8. Minimum change in L needed to change any of 8-bit sRGB values (reference white independent).

When user presses a button to go in one of the axes directions in the fine step mode, the display would keep adding or subtracting 0.25 to that coordinate in the LAB colour space and converting it to the display's sRGB values until any change has been detected. The new sRGB values were then applied to the display surface without any transition. Note that the sRGB model is used for navigational purposes only; the aim is to make the smallest step the display is physically able to produce in its units, with no expectations about the actual change of colour if it was measured.

For the winter white paper sheet condition, the coarse step was defined as 4 fine steps on a single button press. For the saturated paper conditions, the coarse step was defined as 10 fine steps for reasons discussed in 4.3.2 below. Each trial always started in the coarse steps mode.

Holding the navigational buttons for longer period of time was equivalent to pressing the buttons repeatedly as per the default controller and operating system behaviour. If the observer reached limits of the display gamut, the controller vibrated in response. In such case, the display would be set as close to its gamut limit as possible, regardless of the steps mode.

4.3.2 Starting Points

For the winter white paper sheet condition, the starting points were randomized around the target point. Specifically, for each trial for each participant, two pseudorandom 64-bit floating values were generated and used as elevation and azimuth in CIELAB space to offset the light target coordinates by $\Delta E_{ab}^* = 20$ in a pseudorandom direction⁵⁴. The pseudorandom seed was based on the current system up-time and changed for every experiment session, i.e. the pseudorandom generator was re-initialized for each paper sheet condition. If the generated starting point fell outside of the display gamut, a new starting point was generated. For the winter white paper sheet, all starting points during the course of the experiment can be seen in Figure 4.9 left.

⁵⁴ ISO 15008 [282] recommended distance of $\Delta E_{UV} \geq 20$ when portraying distinct colours on in-vehicle systems.

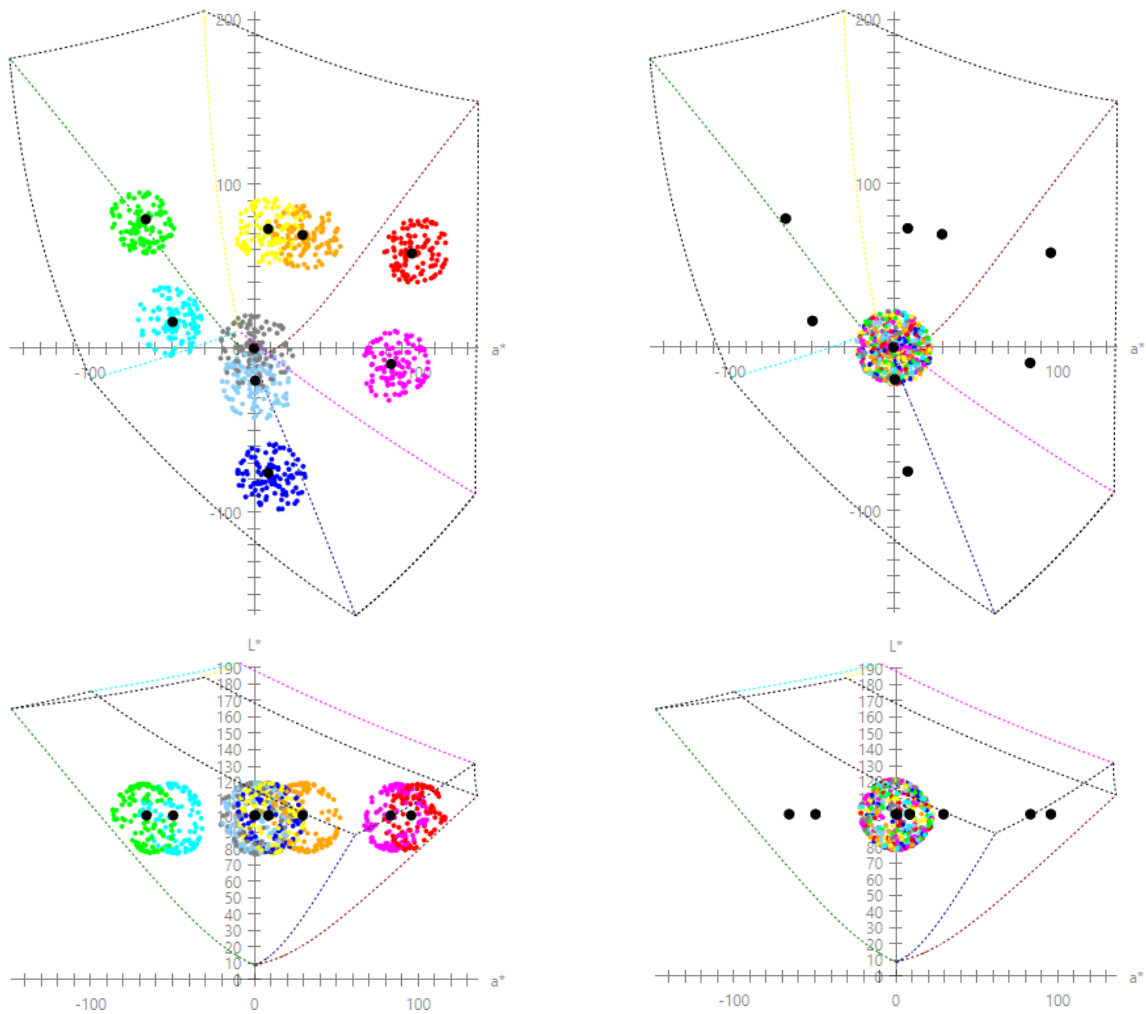

Figure 4.9. Randomized starting points. Left: winter white paper sheet condition. Right: apricot yellow and bonbon rose conditions combined. Data points according to analytical model, 2° CMFs, CIELAB space.

The choice of these starting points was based on notes from the original colour matching experiments by Wright [65]. On page 147, he states:

1. *“It was found impossible to formulate satisfactory rules for the guidance of fresh observers and the difficulty in such cases was largely overcome by a more practised observer making a rough match first.”* In our experiment, the rough match by a more practised observer was substituted by a randomized starting point close to the target colour. Observers were also encouraged to ask for help if they wandered too far away from the target colour and didn’t know how to get back.
2. *“In repeating a match (each colour was matched three times to obtain a mean result) it is only necessary to upset it sufficiently for the match to be perceptibly wrong; to do more than this is a waste of time without any compensating gain in accuracy.”* Wright does not mention who decides that a match is perceptibly wrong, and later literature shows

significant colour perception variation between individual people (e.g. [140, 141]).

Furthermore, during pilot runs of our experiment, observers were sometimes already satisfied with the starting point match and didn't bother trying to adjust the display at all. Therefore, a safe distance from the target colour has been chosen for the starting points.

3. *“Moreover, provided the first match is a reasonably good one, it is easier and appears legitimate to upset and readjust one primary at a time.”* Randomizing only one of the coordinates of the target match has already been criticized by Guild [65, p. 161] and did not seem to be appropriate in our setup where observers adjust the display performing discrete button presses, one coordinate at a time.

It needs to be noted that the starting points were generated on the fly using analytical transformations between sRGB, LAB and Yxy of the target light coordinates calibrated on a white calibration tile for a 2° observer, as opposed to spectral measurements of the light reflected from the paper sheet. This seemed to have produced valid points for the winter white condition (to be expected because of the close similarity between reflectances of the winter white paper and the calibration tile) but of course wouldn't work for the apricot yellow and bonbon rose paper sheets. More importantly, as we will see later in the results, the matches exhibited patterns that could be attributed to the discrepancy between the model predictions and measurements, and, the choice of 2° versus 10° colour matching functions non-trivially affects the target colours. Last, but not least, some observers were satisfied with their matches without taking advantage of the fine steps mode.

To verify that the choice of starting points does not affect the results, the starting points were generated differently for the apricot yellow and bonbon rose paper sheet conditions. Rather than randomizing around the target colour, they were randomized around D65 white (see Figure 4.9 right). To compensate for the larger distance the observer needs to navigate in the colour space in order to reach the target colour, and to further encourage performing fine matches, the coarse step was increased from 4 to 10 fine steps for these two paper sheets.

4.3.3 User Experience

The experiment consisted of a training trial and five blocks (repetitions) of randomized light conditions. After the first two blocks, observers were allowed to take an unlimited time break. Splitting the experiment into repetition blocks rather than randomizing all trials together allows the collection of full data sets even with different numbers of repetitions. The researcher was

present and available to the observer during the whole experiment. The experiment steps were as follows:

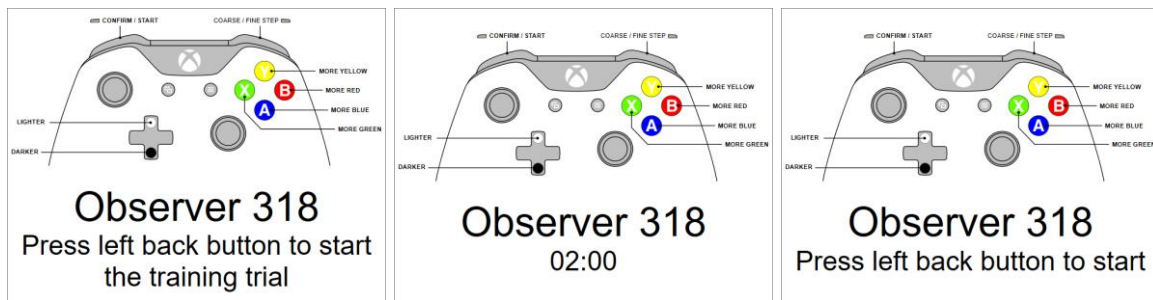

Figure 4.10. Software screens for commencing an experiment session.

1. At the start of the session, lights are set to D65 white and the observer is asked to indicate when they are ready to begin the experiment by pressing a button, while a full controller schema is shown on the screen (see Figure 4.10). The first trial is a training trial under D65 white light that is counted towards the adaptation period. The researcher begins the training trial and explains to the observer how to control the display. The observer then tries to finish the trial. If the training trial has finished within 2 minutes, the observer has to wait the remaining time to complete the adaptation. After the training session is finished, the observer can begin the experiment whenever they feel comfortable.

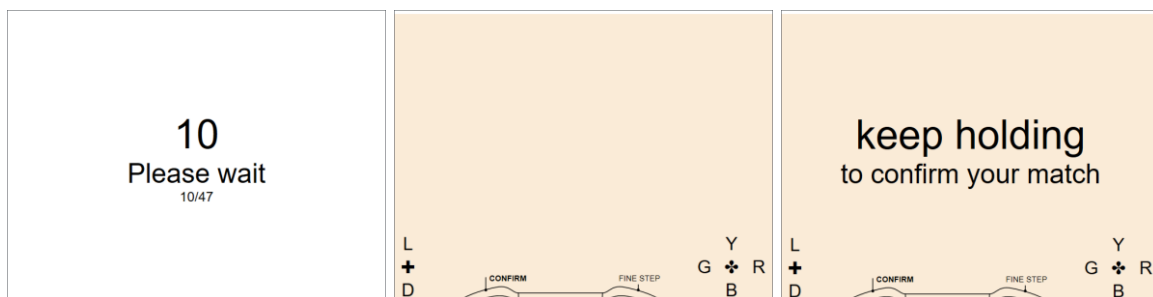

Figure 4.11. Software screens for commencing a trial and performing the colour matching task.

2. At the beginning of each trial, there is a 10 second delay under D65 white light to top-up the observer's adaptation. Then the lights are set to one of the randomized starting points for the given light condition and the observer needs to perform the colour match task while the bottom of the display reminds them of the buttons mapping, in black colour only (see Figure 4.11). When the observer feels they are done with the match, they need to hold a confirmation button for at least one second (pilot runs indicated all confirmations should require holding the button for a period of time to avoid accidental presses).

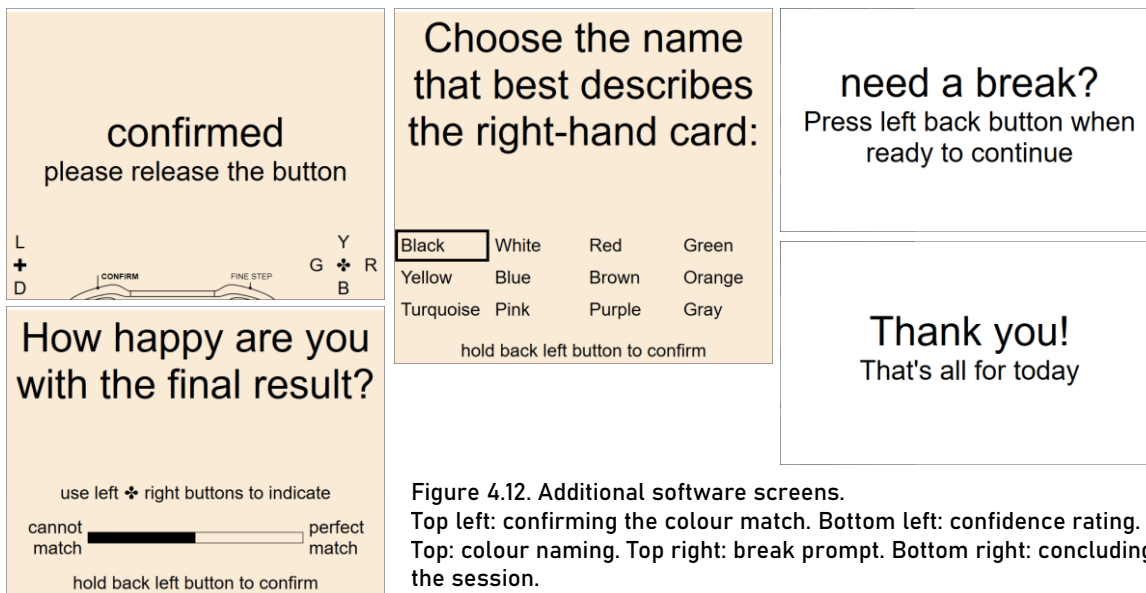

Figure 4.12. Additional software screens. Top left: confirming the colour match. Bottom left: confidence rating. Top: colour naming. Top right: break prompt. Bottom right: concluding the session.

3. After the colour match is confirmed, the observer is asked *how happy they are with the final result* and offered a 11-point scale ranging from *cannot match* to *perfect match*, so that situations where an observer still sees a difference in colour but is unable to find a better match is distinguished from situations where the observer does not see a difference (see Figure 4.12 bottom left). The rating always starts at the midpoint and any button or joystick on the controller indicating left/right could be used to adjust the rating. The observer is required to hold the confirmation button for half a second.
4. After the confidence rating, the observer is asked to perform a colour naming task by *choosing a name that best describes the right-hand card*. A standard set of 11 colour names [142] and an extra one for cyan is presented to the observer to choose from (*black, white, red, green, yellow, blue, brown, orange, turquoise, pink, purple* and *gray*), using any button or joystick on the controller indicating a left/right/top/bottom direction to change the selected name. This screen (see Figure 4.12 top) always started with the previously selected colour name (*black* for the first trial), which might have been source of a bias. The observer is required to hold confirmation button for half a second.
5. After the colour naming, the observer would be immediately presented with the next light condition, continuing with step 2. If all light conditions are exhausted, a new block of randomly ordered light conditions is presented and again, the observer would immediately proceed with step 2. No efforts were made to prevent the last light condition of a block to be different from the first condition of the new block.

6. After the first two blocks were finished, the observer was prompted for a break under D65 white light (see Figure 4.12 top right). It was expected that observers would become faster finishing the trials after two blocks, resulting in the break being approximately in the middle of the session. The break was not enforced and break time was not limited, however, participants could not leave the controlled lighting environment. After confirmation by observer, the experiment resumed with new block of trials with step 2.
7. After all five blocks have been finished, the session ended with a *thank you* screen (Figure 4.12 bottom right).

Observers were never allowed to go back or review their responses. If they realized they made a mistake and reported it to the observer (e.g. “I chose *red* but meant to choose *green*”), this has been noted in the experiment protocol and manually fixed in the data before further processing. However, if they indicated they confirmed a colour match they didn’t mean to, they were instructed to rate it with zero confidence.

All trials with zero match confidence were completely excluded from any further processing.

4.3.4 System Design

The study software was written in C# using Windows Presentation Foundation, running on Windows 10 tablet as discussed in 3.4.1. Any power saving including Display Power Saving Technology was disabled, and the experiment was running with AC power connected and no colour profile corrections. All hardware including the spectrally tunable lights and game controller were interfaced directly from the software, allowing for low latency responses and precise control of timing. Data were logged and initially stored locally on the device, for later transfer.

4.4 Results

A total number of 1575 matches were obtained from 25 observers (13 females, age 18–38, median 27), some of which matched more than one paper sheet, see Table 4.5.



| paper sheet | observers | total matches | valid matches (confidence >0.0) | high confidence (confidence ≥0.9) |
|--|-----------|---------------|------------------------------------|--------------------------------------|
|  winter white | 23 | 1035 | 1031 | 401 |
|  apricot yellow | 9 | 405 | 404 | 150 |
|  bonbon rose | 3 | 135 | 135 | 52 |

Table 4.5. Cross-media colour matching trial counts

All matches with zero confidence (5 in total) were excluded from further analysis. These include unintentionally confirmed matches and matches where observers were nowhere near the target and rejected suggestions from the researcher. Results with confidence ratings 0.9 and 1.0 are considered to be high-confidence results.

Unless noted otherwise, the following analysis is based on 1031 valid matches of the white paper sheet only (by 23 observers). All winter white matches are plotted in Figure 4.13. The spectra of all individual matches were measured from the display, at location [600, 500].

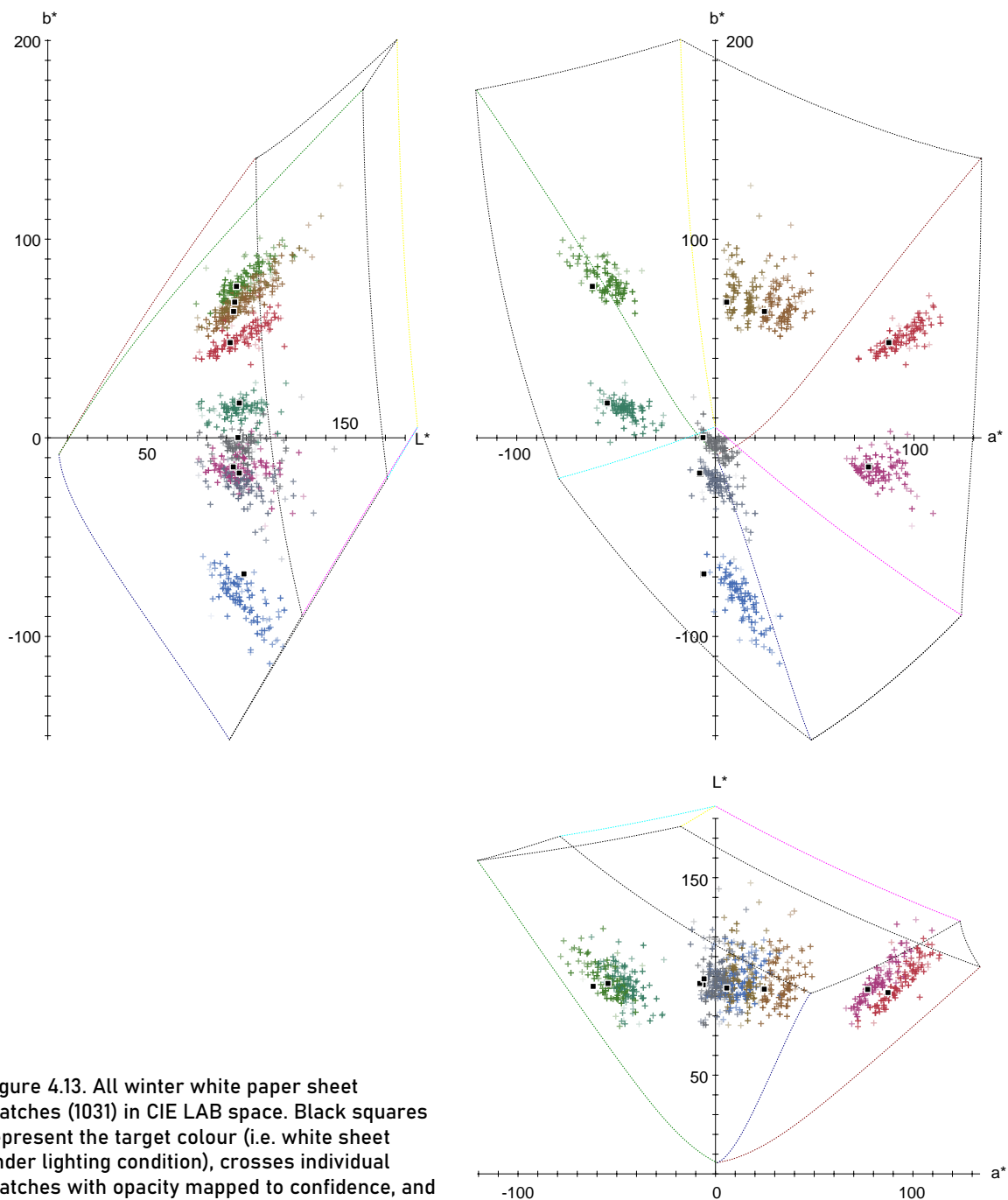

Figure 4.13. All winter white paper sheet matches (1031) in CIE LAB space. Black squares represent the target colour (i.e. white sheet under lighting condition), crosses individual matches with opacity mapped to confidence, and lines represent measured gamut of the display.

4.4.1 Bimodality in Conditions

One of the striking features of the results are the two clearly visible clusters for each of the yellow conditions, as shown in detail in Figure 4.14.

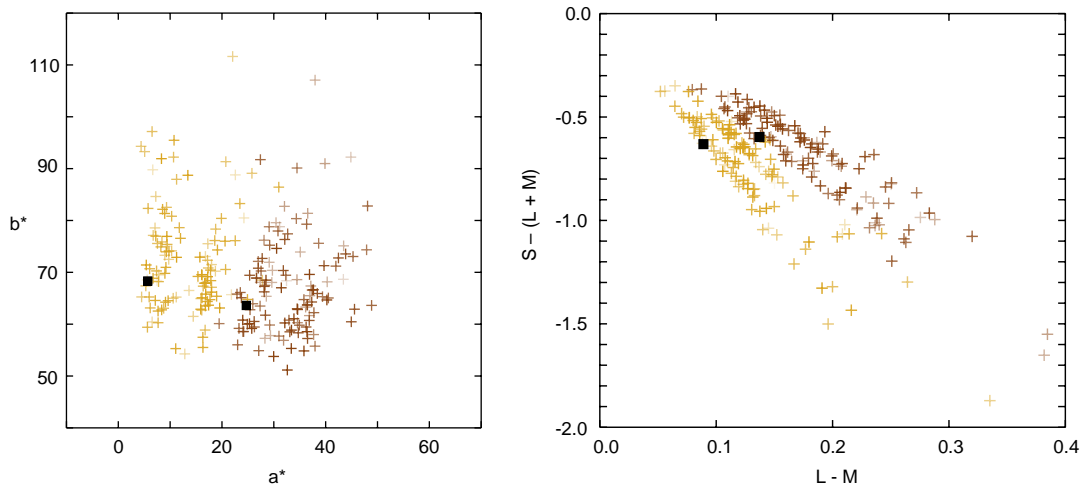

Figure 4.14. Bimodality in yellow and daylight yellow matches. Left: CIELAB space. Right: DKL space.

For most observers, all their matches fall into only one of the clusters, either to the left ones or to the right ones, but the same one in both conditions. After manually labelling the observers based on their yellow condition matches, there were 10 observers whose matches all fell into the left clusters, 9 observers whose all matches fell into right clusters, and 4 observers who had at least one match in the other cluster than the rest of their matches. We will exclude those 4 from the further analysis in this section.

Colour coding the remaining 19 participants based on their matches confirms the classification is consistent for the daylight yellow condition too (viz Figure 4.15).

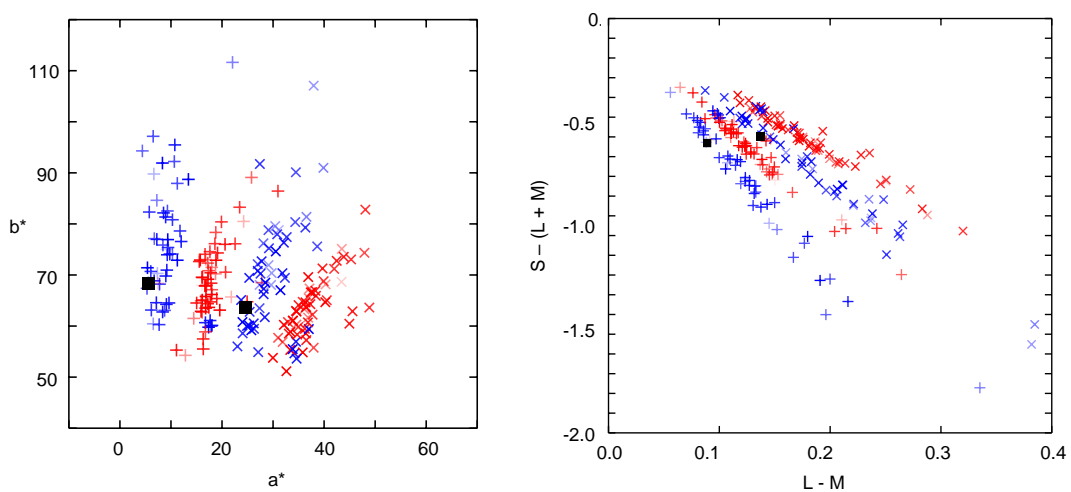

Figure 4.15. Bimodality in yellow and daylight yellow matches by observers. Cross colour: colour-coded observer's cluster (blue: left cluster, red: right cluster), cross orientation: light condition (+ yellow, x daylight yellow). Left: CIELAB space. Right: DKL space.

In fact, this grouping reveals similar tendencies for other conditions, see Figure 4.16.

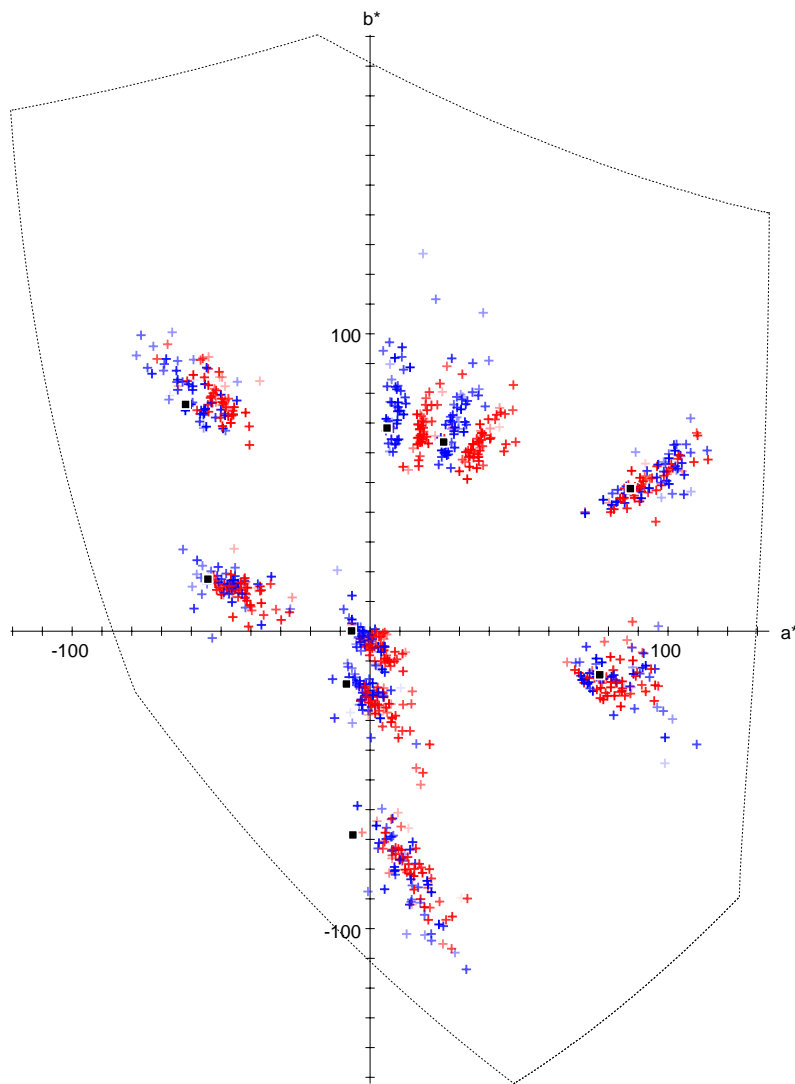

Figure 4.16. All matches of 19 colour-coded observers. CIELAB space.

If we take for each observer their average match over all trials for each condition, and analyse those mean matches in the CIE 1931 xy chromaticity space, the clustering is statistically significant for all but three conditions along the blue – red gamut line, see Figure 4.17.

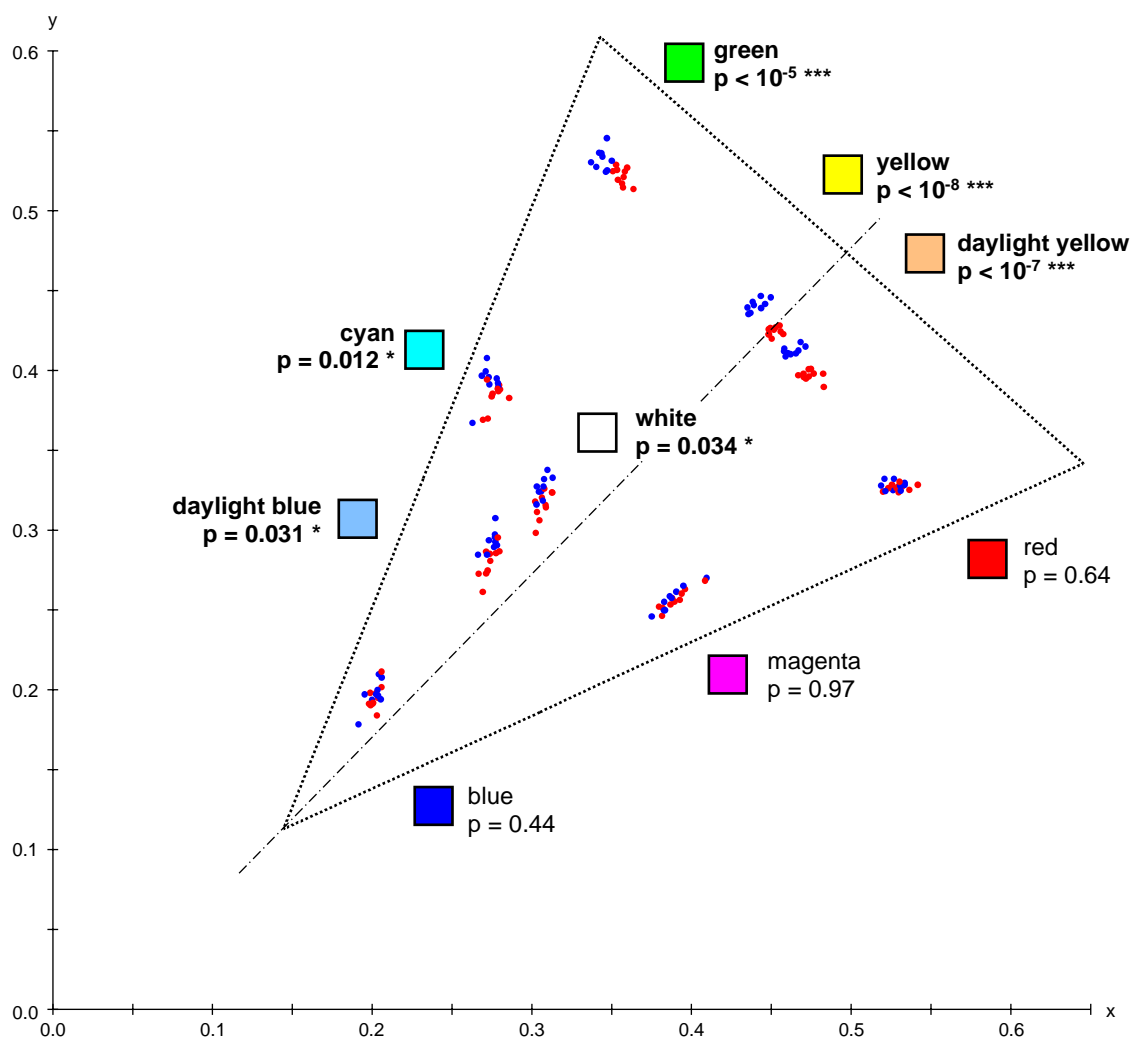

Figure 4.17. Linear regression results for significance of clustering on the greenness of matches the observers produce (distance from the dash-dotted blue–yellow axis)⁵⁵. * $p < 0.05$, *** $p \approx 0$. CIE xy diagram.

There is no obvious explanation behind the two groups. The only demographic variable that shows some correlation with the grouping is self-reported eye colour of observers (blue eyes in blue-coded clusters vs brown eyes in red-coded clusters, $\chi^2=7.13$, $p=0.0075$, $N=17$). The significance of greener matches based on blue vs brown eye colour is similar to above, but eye colour as a factor affecting colour matching is not established in the literature.

Sharpe et al. showed how genotype of observers, most significantly whether alanine or serine amino acid is encoded at position 180 in Xq28 of the X chromosome, affects CMFs [143]. In this study, we did not determine the genotype of observers, however, the effect is usually modelled as a shift of the L matching function by 4 nm. The result of shifting the L function by ± 5 nm⁵⁶ on the matches is shown in Figure 4.18.

⁵⁵ Produced by RStudio 1.2.1335, using `lm(distance ~ condition * cluster)`

⁵⁶ Five nanometres used as a convenience for the CMFs being specified at 5 nm interval.

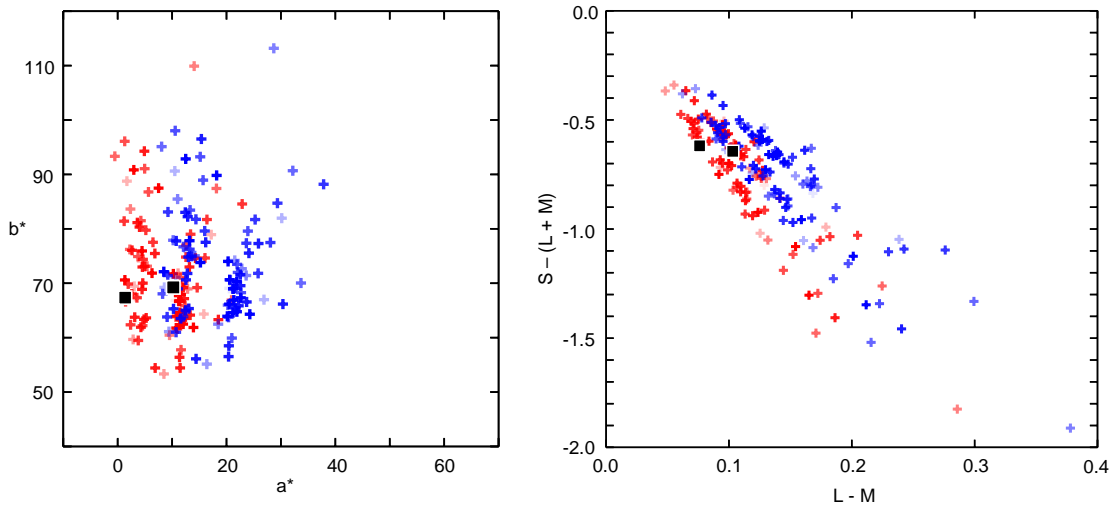

Figure 4.18. Yellow condition with L matching function shifted left (red) and right (blue) by 5 nm. Left: CIELAB space. Right: DKL space.

The simulation suggests that in order to get a convincing alignment of the matches from two clusters by shifting the L matching function, the matching functions of observers from the two groups would have to be around 10 nm apart. While genotype differences are a step in the right direction to explain the clustering, perhaps even to the point where clusters wouldn't be apparent in the results (cf. Figure 4.19), they can't explain the phenomenon fully.

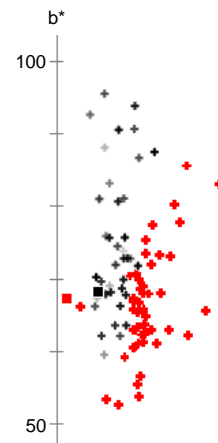

Figure 4.19. Yellow matches of observers in left clusters unmodified (black) and right clusters shifted left by 5 nm (red).

Another possible explanation would be an uncontrolled external factor affecting the experiment set-up, such as temperature, humidity, device stability, etc. For example, a decrease in the power output of one of the red channels in the lights would explain matches moving towards green colours. Such explanation due to an external factor is further supported by the fact that observers belonging to the same cluster also happen to be grouped chronologically in the order they did the experiment (see Table 4.6). In order to verify this hypothesis, the most consistent observer from each cluster fully repeated the experiment on the same day immediately in sequence. Their results are in Figure 4.20.

| | | | | | | | | | | | | | | | | | | | | | | | |
|-------------|----|----|----|----|----|----|----|----|----|----|----|----|----|----|----|----|----|----|----|----|----|----|----|
| Date | 23 | 26 | 27 | 27 | 27 | 28 | 28 | 28 | 28 | 28 | 29 | 29 | 29 | 29 | 29 | 30 | 30 | 30 | 30 | 02 | 03 | 03 | 06 |
| Hour | 19 | 10 | 10 | 14 | 15 | 09 | 12 | 14 | 15 | 17 | 09 | 11 | 13 | 14 | 15 | 09 | 11 | 15 | 17 | 13 | 09 | 17 | 15 |
| Obs. | DA | AD | MW | AA | VL | AW | ES | SR | CC | JG | DP | DG | EF | TZ | NC | VS | TA | CR | SC | FH | NG | JM | JK |

Table 4.6 Observers ordered left to right by the date and time they did the experiment, color-coded per clusters.

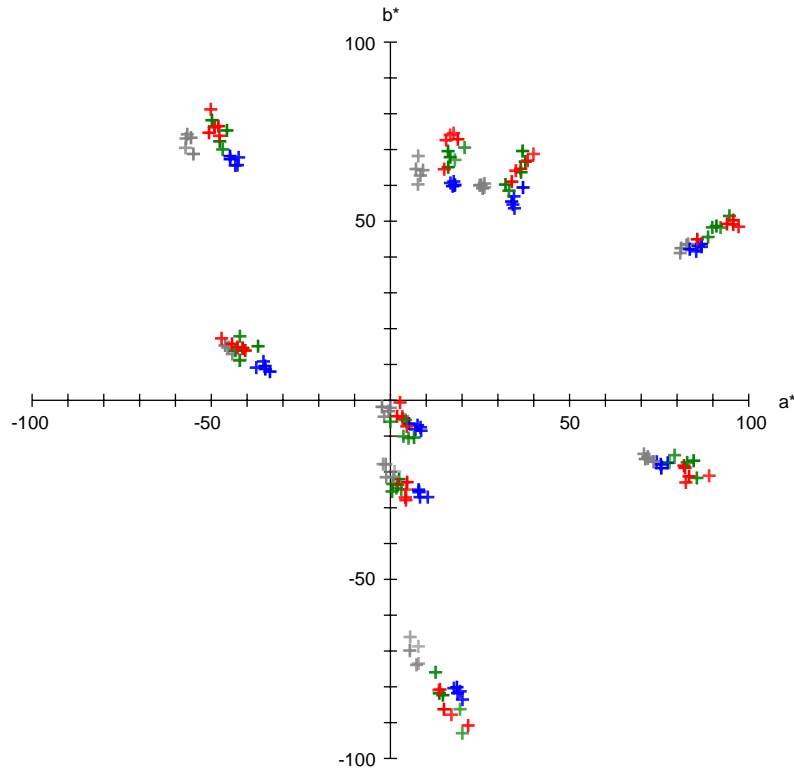

Figure 4.20. Two top consistent participants from different clusters repeating the experiment, CIELAB space. Green—Red correspond to the old and new matches of observer from the right cluster, Grey—Blue correspond to the old and new matches of the observer from the left cluster respectively.

The new set of matches confirms that the bimodalities need to be ascribed to an external factor, since the new matches (blue and red) were in the same group this time. Specifically, the matches originally in the left group (grey) fell into the right group (blue). The matches of the observer in the right group were unaffected. Note, however, that neither of the groups is the “correct” one. We only proved that the grouping has to be attributed to the conditions rather than the observers, and we can arbitrarily choose which one will be the one we align to the other. Figure 4.13—Figure 4.16 clearly suggest that the conditions under which the paper card was measured belong to the left group, and since the paper was measured under the same conditions in which the lights were calibrated⁵⁷, we will align matches to the left group.

Taking the new observer’s average points $[X_i \ Y_i \ Z_i]^T$ per condition and original average points $[X'_i \ Y'_i \ Z'_i]^T$ per condition, we are looking for a transform A mapping one to another, i.e.

$$\begin{bmatrix} X'_i \\ Y'_i \\ Z'_i \end{bmatrix} = A \cdot \begin{bmatrix} X_i \\ Y_i \\ Z_i \end{bmatrix}. \quad (4.7)$$

⁵⁷ The lights were calibrated using CIE 2012 2° colour matching functions, using which the white paper sheet is practically at the origin of LAB, with $a^*=0.8$, $b^*=-0.8$.

This is the same equation as (2.8) and we have already seen how to solve it for three pairs of points in 2.5.2. However, here we have 9 pairs (conditions), so the system is overdetermined. The linear least squares method gives us best fit solution

$$A = \begin{bmatrix} 0.8485766 & 0.1283244 & -0.0023012 \\ -0.1709169 & 1.2134252 & -0.0009859 \\ -0.0485757 & 0.0904530 & 0.9027132 \end{bmatrix}, \quad (4.8)$$

with $R^2 = 0.9987$. Transforming matches of all observers falling into the left cluster (including the four mixed ones whose majority of matches were in the left cluster), we get the final set of matches as plotted in Figure 4.21. All further analysis will be performed on this corrected set of matches.

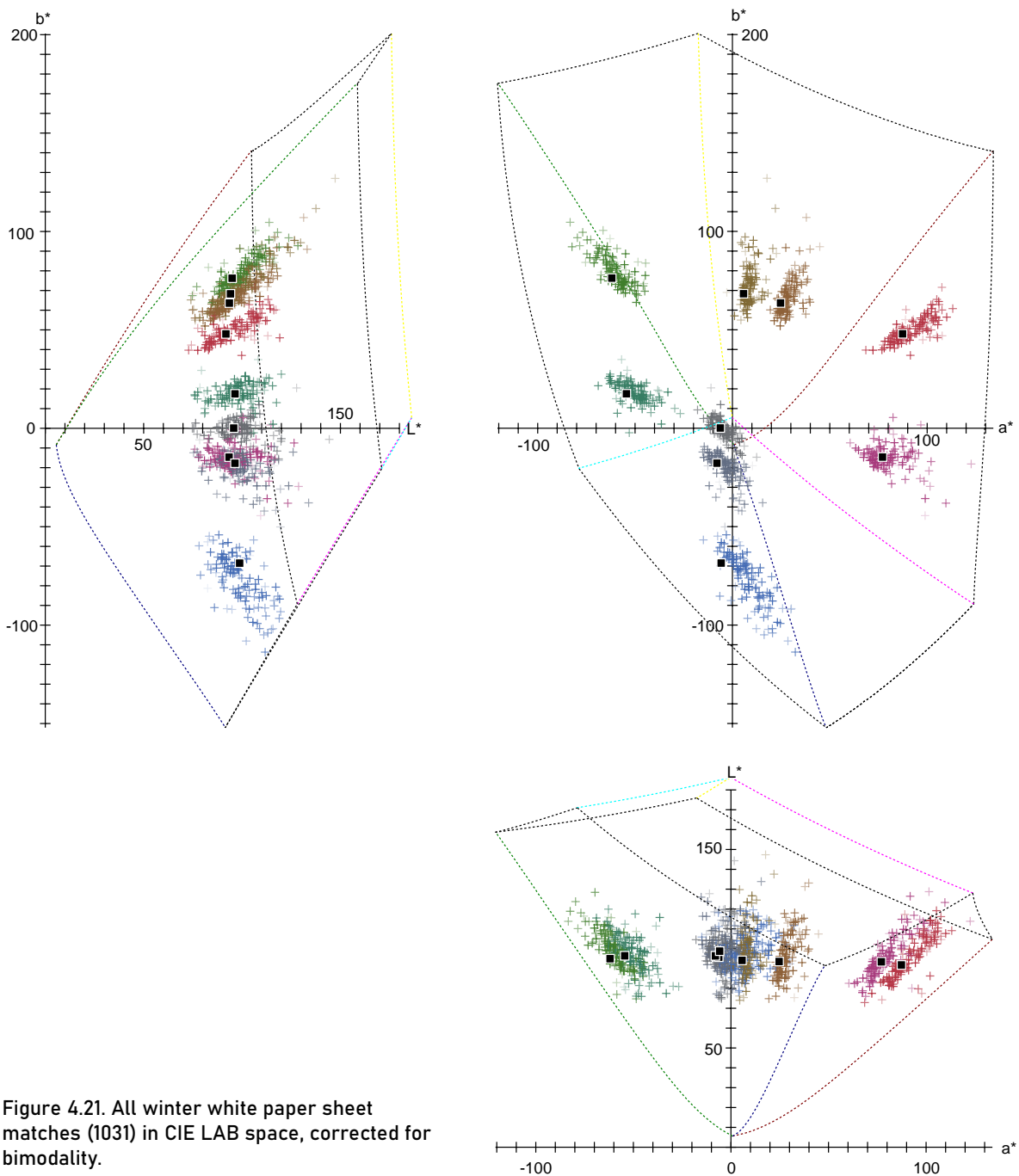

Figure 4.21. All winter white paper sheet matches (1031) in CIE LAB space, corrected for bimodality.

4.4.2 Matching Performance

The average distance between the observer's display setting and the target was $\Delta E_{abL}^* = 10.2$, with white matches being closest at $\Delta E_{abL}^* \cong 7.6$ and blue matches being the furthest outlier at $\Delta E_{abL}^* = 17.9$, see Table 4.7 for individual conditions details.



















| condition | ΔE_{abL}^* to white card | | average observer's | |
|---|----------------------------------|---|--------------------|-------------------|
| | mean | median | σ^{58} | confidence |
|  white | ▼7.65 |  | ▼3.76 | 0.73 |
|  cyan | 8.44 |  | 4.19 | 0.74 |
|  daylight blue | 8.94 |  | 4.16 | ▼0.71 |
|  daylight yellow | 9.10 |  | 4.57 | 0.78 |
|  magenta | 9.45 |  | 4.74 | 0.80 |
|  green | 9.69 |  | 4.37 | 0.75 |
|  yellow | 10.23 |  | 4.23 | 0.76 |
|  red | 10.23 |  | 4.84 [▲] | 0.81 [▲] |
|  blue | 17.92 [▲] |  | 4.08 | 0.74 |
| average | 10.18 | | 4.33 | 0.76 |

Table 4.7. Per condition white card matching performance, ordered by distance of average observer's display setting to the measured white card. Confidence normalized to the maximum of each participant. ▼ minimum, ▲ maximum.

To avoid any doubts, the average distance is calculated as follows:

1. Observer repeats each condition five times and indicates their confidence in the match. The *observer's average for a condition* is the confidence-weighted average of these five points.
2. For each condition, the distance between observer's average for that condition and the paper target colour (measured in the centre of the paper sheet) is computed by means of ΔE_{abL}^* . Let that be the *observer's average distance for a condition*.
3. For each condition, the observer's average distances for that condition are arithmetically averaged across all observers. Let that be the *condition's average distance* (second column in Table 4.7).

⁵⁸ The purpose of this number is relative comparison of how easy the condition was for our observers. It is the observer's standard deviation of matches for given condition, averaged across observers, in ΔE_{abL}^* . The lower the number the more consistent matches were they able to make (i.e. the condition was easier to match).

4. The arithmetical mean of all condition's average distances across all conditions is the final average distance (in the summary row of Table 4.7).

The *standard deviation of matches* is a descriptive statistic describing the distances of individual matches to their (weighted) average.

4.4.2.1 Effect of averaging method

There are several ways how to calculate the confidence-weighted average in step 1. The average can be either computed geometrically in one of the colour spaces, or, since spectra of individual matches were measured, of the spectra themselves. The effect of how the average is calculated on the conditions' and final average distances is shown in Table 4.8.

| method | red | green | blue | cyan | magenta | yellow | white | daylight yellow | daylight blue | average |
|-----------------|-------|-------|-------|------|---------|--------|-------|-----------------|---------------|--------------|
| CIE LAB | 7.65 | 8.44 | 8.94 | 9.10 | 9.45 | 9.69 | 10.23 | 10.23 | 17.92 | 10.18 |
| CIE LUV | 12.25 | 9.25 | 12.47 | 9.77 | 13.61 | 10.41 | 11.47 | 10.95 | 18.88 | 12.12 |
| DKL | 7.84 | 8.42 | 9.25 | 9.48 | 9.86 | 10.01 | 10.78 | 10.53 | 18.35 | 10.50 |
| spectral | 7.84 | 8.42 | 9.25 | 9.48 | 9.86 | 10.01 | 10.78 | 10.53 | 18.35 | 10.50 |

Table 4.8. Effect of averaging method. Rows correspond to the second column in Table 4.7. CIE 2012 10° CMF. Differences over $1 \Delta E_{abL}^*$ highlighted.

In general, the difference between selected spaces (CIELUV as perceptually uniform for emissive surfaces, CIELAB as perceptually uniform for reflective surfaces, cone-opponent DKL space as physiologically based) and the spectral average is below the just noticeable difference. Averaging in the DKL space and spectral averaging yields identical results, and the results are very similar to averaging in the CIELAB space too, with difference in most conditions being below or on borderline of the equipment repeatability. The CIELUV is noticeably different, peaking at $+4.60 \Delta E_{abL}^*$ for red. Nevertheless, the blue condition is consistently and significantly the worst in all methods.

For the rest of the work, averaging in the CIELAB is used due to its perceptual relevance.

4.4.2.2 Effect of colour matching functions

Since both stimuli subtend 10° of view each, the 10° colour matching functions (CMF) should be the best ones available to describe our understanding of colour perception in our study. Let's verify the effect different sets of CMFs have on the results, see Table 4.9.

| CMF | red | green | blue | cyan | magenta | yellow | white | daylight yellow | daylight blue | average |
|--------------------|-------|-------|-------|-------|---------|--------|-------|-----------------|---------------|---------|
| CIE 2012 10° [144] | 10.23 | 9.69 | 17.92 | 8.44 | 9.45 | 10.23 | 7.65 | 9.10 | 8.94 | 10.18 |
| CIE 1964 10° [24] | 10.10 | 10.04 | 16.22 | 8.08 | 9.39 | 10.37 | 7.48 | 8.95 | 8.29 | 9.88 |
| CIE 2012 2° [144] | 10.41 | 14.95 | 12.39 | 17.05 | 9.50 | 12.83 | 13.13 | 10.29 | 12.56 | 12.57 |
| Judd-Vos 2° [67] | 10.74 | 17.61 | 13.64 | 21.82 | 9.37 | 15.53 | 17.08 | 12.80 | 16.57 | 15.02 |
| Judd 2° [83] | 10.72 | 17.73 | 13.60 | 21.91 | 9.35 | 15.62 | 17.01 | 12.88 | 16.53 | 15.04 |
| CIE 1931 2° [24] | 10.37 | 17.08 | 13.13 | 20.99 | 9.44 | 14.69 | 15.82 | 11.97 | 15.20 | 14.30 |

Table 4.9. Effect of colour matching function choice. Rows correspond to the second column in Table 4.7, i.e. the condition's average distance.

The average distance between display setting and paper measurement are indeed lowest for the 10° functions. Nevertheless, the final result is still around 10 ΔE_{abL}^* (if we ignore differences in L^* , we get around 8 ΔE_{ab}^*), confirming that the current CMFs do not generalize to our cross-media chromatic lights conditions.

Second, for 10° CMFs and only for them, the blue condition is significantly worse ($p < 0.001$) than any other condition. For any of the 2° CMFs, blue is ranking in the middle, in fact none of the conditions is significantly worse than the others. The reason for such difference between 2° and 10° CMFs is due to the spectral distribution of the light sources. The predicted appearance (in terms of CIELAB values) of the matches produced by display primaries is less affected by the CMFs than the light reflected from the paper sheets, see Figure 4.22.

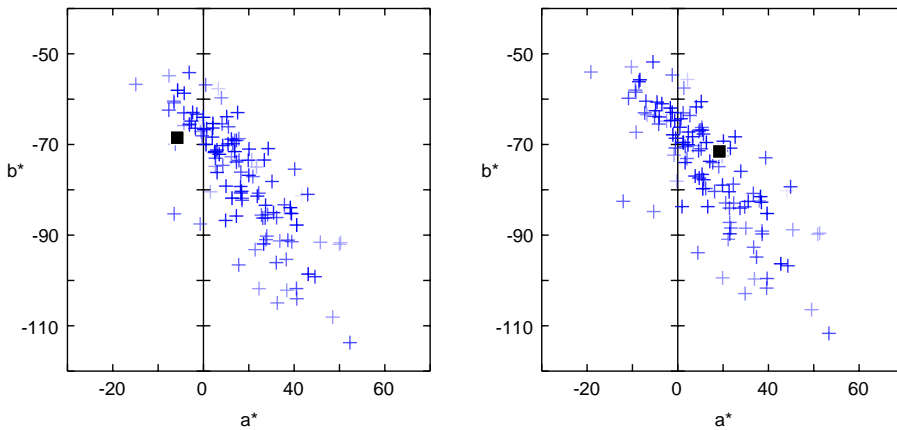

Figure 4.22. Effect of colour matching functions on the blue condition. CIE 2012 CMFs, 10° left, 2° right. Note that the predicted appearance of the paper sheet (black rectangle) differs more than the observers' matches.

As a consequence, the relative order of conditions by observers' performance depends on the choice of CMFs. For example, for the 10° functions, white is the condition where display and paper matches were closest, but it's the magenta condition for all of the 2° CMFs.

4.4.3 Consistency of Observers

Observers varied in consistency, the most consistent observer having a match standard deviation of σ of 1.16, and the least consistent observer a σ of 7.46 in ΔE_{aBL}^* . Their matches are plotted in Figure 4.23 for illustration.

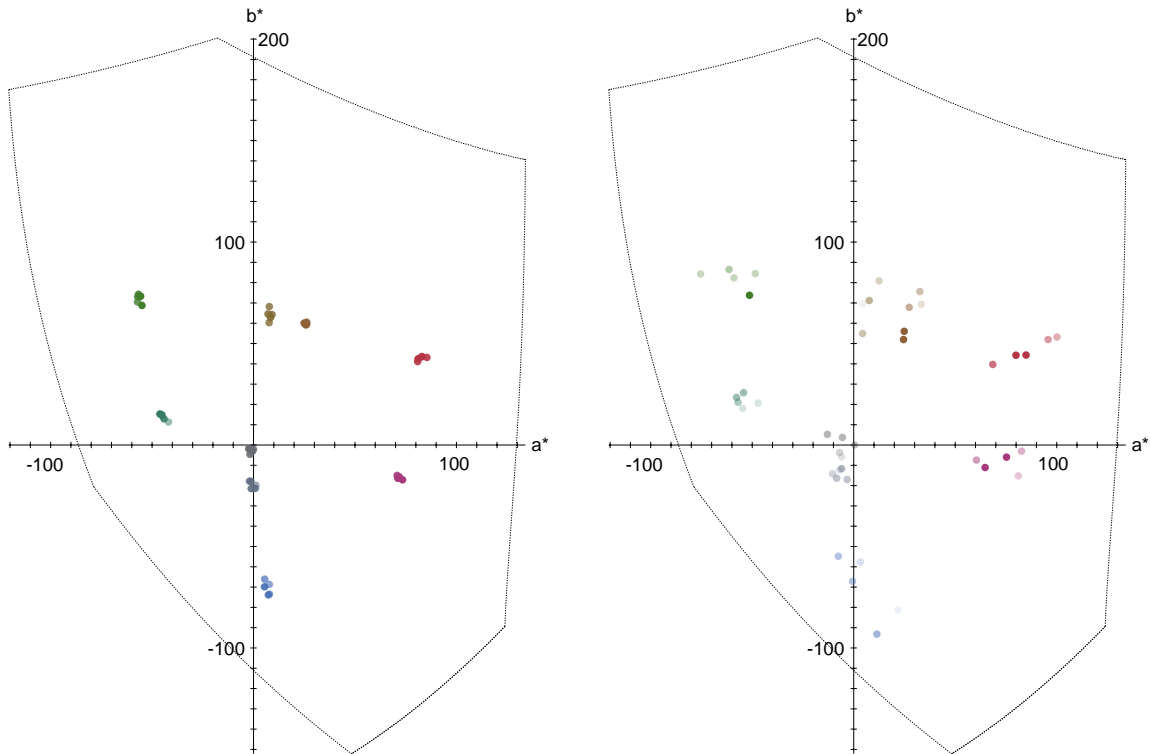

Figure 4.23. The matches of the most (left) and least (right) consistent observers, circles represent individual matches with opacity mapped to confidence.

Where an observer's performance is so poor as to be an outlier, we would be justified in excluding the observer's data. It is also the case that the fastest participants took around 30 minutes while the slowest ones around 90, so another reason for excluding observers with poor performance would be to make the overall experimental conditions more consistent across observers, by keeping the overall duration of light exposure more consistent. Indeed, in general the longer the observers took to complete the experiment the more consistent they were (see Figure 4.24).

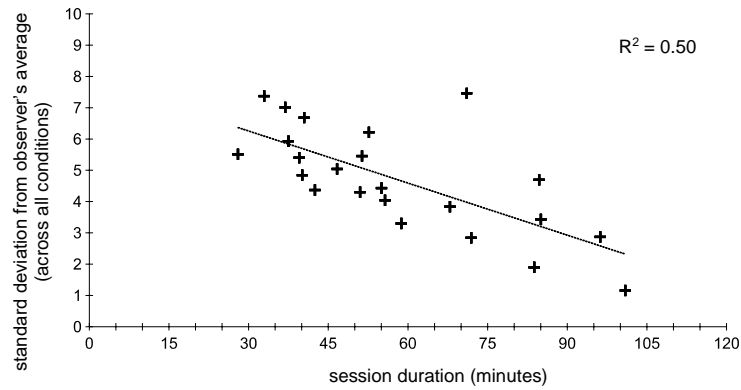

Figure 4.24. Observer's session duration vs matches standard deviation from observer's average.

However, if for each condition we order the observers so that the cumulative average distance from the display to the paper is minimal, for all but one condition there is no clear drop in observers' performance in terms of average distance, only an indication of increase in standard deviation with last two observers, most notably affecting the yellow condition (see Figure 4.25). The blue condition has a visible drop in both performance and consistency for half of the observers, however, the blue condition is also an obvious outlier in performance that can be explained by the poor accuracy and perceptual uniformity of the CIELAB space in that area.

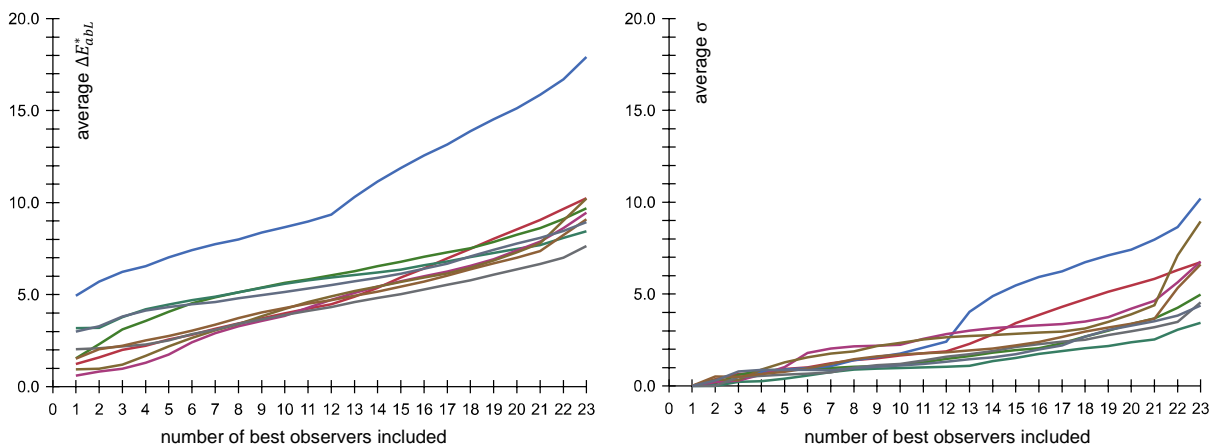

Figure 4.25. Cumulative performance (left) and its standard deviation (right) as observers causing minimal increments are added to the data set (independently for condition), i.e. the right most values on the left chart correspond to the second column in Table 4.7. Note the outlying nature of the blue condition.

To evaluate the effect of “bad” observers on the overall matching performance, several exclusion criteria were considered, such as the time observers took to finish the experiment or consistency of their matches. An overview of the some of the criteria and their effect on the results is in Table 4.10.

| excluding | red | green | blue | cyan | magenta | yellow | white | daylight yellow | daylight blue | average |
|--------------------------------|-------|-------|-------|-------|---------|--------|-------|-----------------|---------------|--------------|
| nobody | 10.23 | 9.69 | 17.92 | 8.44 | 9.45 | 10.23 | 7.65 | 9.10 | 8.94 | 10.18 |
| 2 least consistent | -0.35 | -0.09 | 0.21 | 0.28 | 0.04 | -1.01 | 0.01 | -0.60 | 0.34 | -0.12 |
| 1 observer < 30 min | -0.57 | 0.03 | -0.58 | -0.36 | -0.02 | -1.13 | -0.64 | -0.86 | -0.48 | -0.51 |
| 4 observers < 40 min | -1.62 | -0.46 | -1.50 | -0.27 | -1.37 | -2.87 | -1.31 | -1.83 | -0.95 | -1.35 |
| 8 observers < 45 min | -1.36 | 0.25 | -1.48 | -0.53 | -1.99 | -2.79 | -1.59 | -2.05 | -0.85 | -1.38 |
| half fastest | -3.08 | -0.68 | -4.02 | -1.11 | -2.09 | -3.64 | -2.36 | -2.73 | -1.64 | -2.37 |
| half least consistent | -3.37 | -1.28 | -2.54 | -1.11 | -2.91 | -3.97 | -2.61 | -3.02 | -1.62 | -2.49 |
| half after blue drop | -3.92 | -2.13 | -8.56 | -0.66 | -3.08 | -4.20 | -2.61 | -3.49 | -2.48 | -3.46 |

Table 4.10. Effect of excluding observers based on various criteria, in ΔE_{abL}^* between display setting and target paper match.

As we can see, all of the exclusion criteria result in little difference; the improvement in predicted distance between display settings and target paper matches are below the just noticeable difference of $\Delta E_{abL}^* \approx 2.3$ under strict standard conditions. Even if we employ the radical measure of considering results of only half of the participants (12) that took the longest or that were the most consistent, the improvement is barely noticeable. It is true that half of the observers are responsible for the performance drop in the blue condition from 9.4 to 17.9, but even if we exclude blue condition altogether for all participants, the average improves only from 10.2 to 9.2.

Therefore, there is no basis to exclude any of the participants based on their performance.

4.4.4 Discrimination Ellipses

One of the key results of a colour matching experiment is the size of the area that observers consider to be a match. Assuming Gaussian distribution of the matches, these are usually expressed in the form of ellipses.

For such analysis, we will consider only the confident matches (i.e. with confidence of 0.9 or 1.0) to represent a match and discard all others. In our dataset, 401 out of 1031 matches were confident matches. We are looking for axes of ellipses representing the two directions with the highest variance in the data, where the size of an axis represents the variance value. This problem is solved using principal component analysis (PCA)⁵⁹, with the results shown in Table 4.11 and Figure 4.26.

⁵⁹ The calculation was performed using the Accord.Statistics library, version 3.8.0, part of the Accord.NET Framework (<http://accord-framework.net/>)









| condition | a* | b* | major | minor | angle | area |
|---|--------|--------|-------------|-------------|--------|--------------|
|  red | 90.41 | 48.90 | 10.30 | 2.53 | 30.92 | 81.92 |
|  green | -59.13 | 78.05 | 8.08 | 3.55 | -45.70 | 90.09 |
|  blue | 6.32 | -73.84 | 11.13 | 3.46 | -55.63 | 120.96 |
|  cyan | -50.33 | 18.04 | 8.30 | 3.41 | -30.79 | 88.84 |
|  magenta | 77.66 | -15.35 | 7.42 | 4.33 | -13.92 | 100.87 |
|  yellow | 8.37 | 70.10 | 8.28 | 2.30 | 83.06 | 59.85 |
|  white | -4.43 | -0.64 | 5.99 | 2.43 | -45.63 | 45.69 |
|  daylight yellow | 27.74 | 64.16 | 6.03 | 2.68 | 69.56 | 50.77 |
|  daylight blue | -4.37 | -18.71 | 6.33 | 2.35 | -40.94 | 46.78 |
| average | | | 7.98 | 3.00 | | 76.20 |

Table 4.11. Threshold ellipses in the CIE LAB space based on PCA results of confident matches. Axis lengths (radii) are square roots of eigenvalues, i.e. standard deviations, zero degrees angle corresponds to the horizontal a* axis.

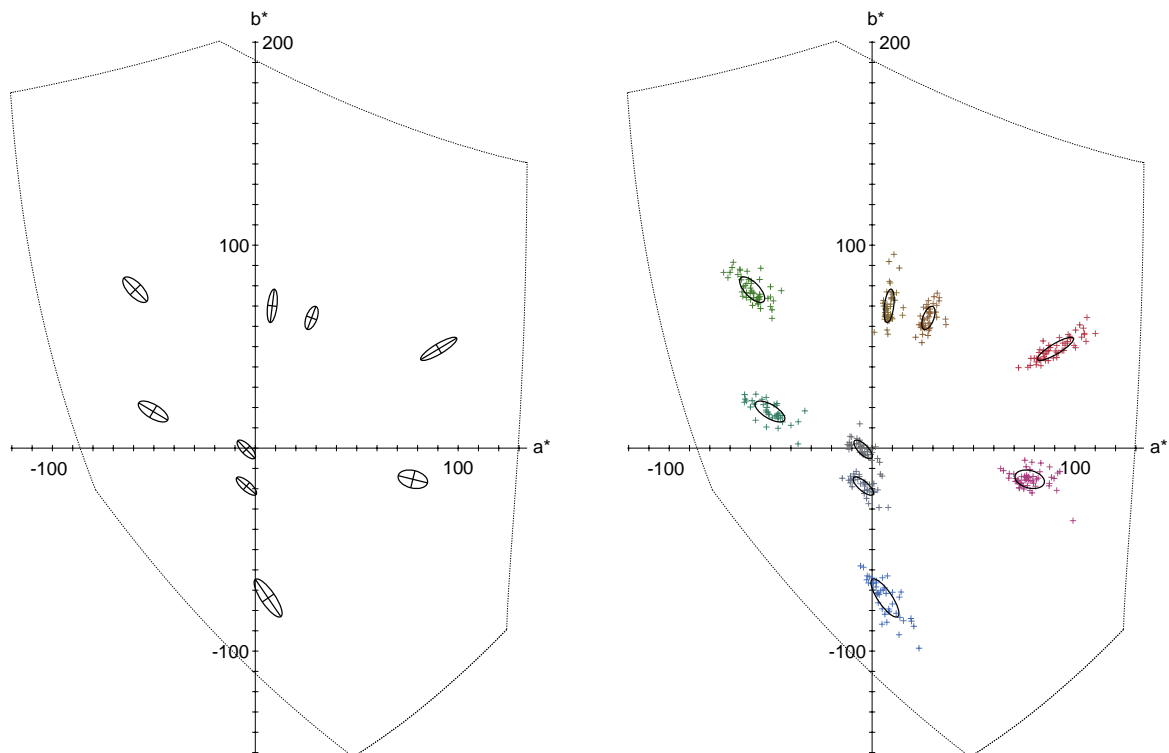

Figure 4.26. Threshold ellipses in the CIE LAB space based on PCA results of confident matches, with (right) and without (left) matches plotted.

On average, the discrimination ellipses are of size $16.0 \times 6.0 \Delta E_{ab}^*$. The smallest ellipse, $12.0 \times 4.9 \Delta E_{ab}^*$ is for the white condition, very closely followed by daylight blue, suggesting that colour discrimination works best for colours close to white, while the extremely chromatic conditions such as green, blue and magenta have ellipses of more than double the area of the white one. The size of ellipses compared to their distance from the origin (i.e. chroma) is plotted in Figure 4.27.

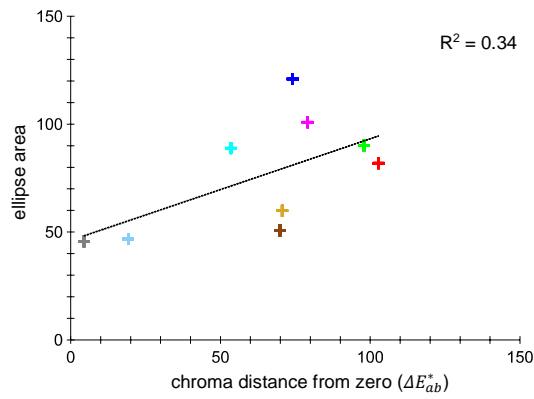

Figure 4.27. Threshold ellipse size as a function of chroma.

Comparing our cross-media discrimination ellipses to datasets of small to medium colour differences of various surface materials and colours under white illumination by Luo and Rigg [89], we see in Figure 4.28 that the ellipses agree in orientation and relative size increase as they increase in chroma, but our ellipses are generally bigger, considerably so for the conditions close to the origin (white and daylight blue).

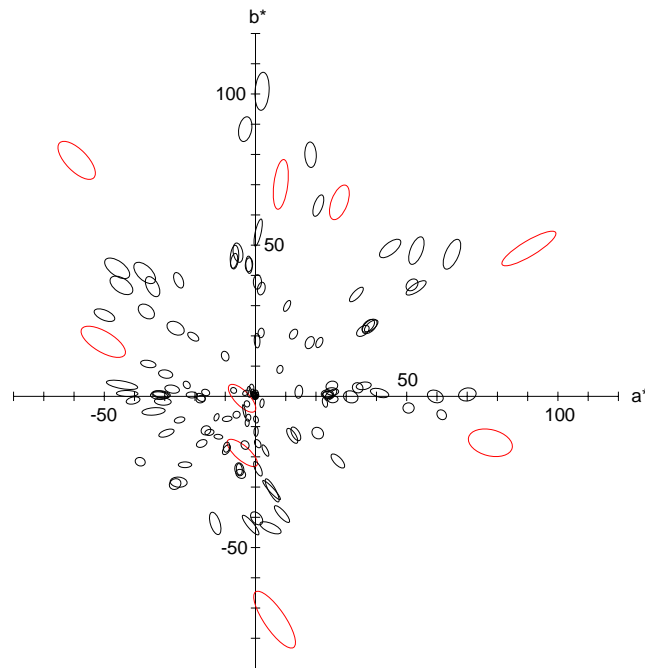

Figure 4.28. Comparison of our cross-media matching ellipses (red) versus Luo and Rigg discrimination ellipses (black) [145] in the CIELAB space. Black ellipses data in CIELAB kindly provided by Dr. Luo.

Numerical comparison for selected conditions with close ellipses available in the prior work is summarized in Table 4.12.





| condition | a* | b* | angle | area | compared to | a* | b* | angle | area | ratio |
|---|--------|--------|--------|-------|-------------|--------|--------|--------|-------|------------|
|  white | -4.43 | -0.64 | -45.63 | 45.69 | FILE=9 | -7.23 | 1.96 | -36.72 | 8.13 | 5.6 |
|  daylight blue | -4.37 | -18.71 | -40.94 | 46.78 | CAD-300 | -3.45 | -16.11 | -57.41 | 9.98 | 4.7 |
|  daylight yellow | 27.74 | 64.16 | 69.56 | 50.77 | RCK19 | 20.78 | 63.08 | 70.75 | 16.43 | 3.1 |
|  cyan | -50.33 | 18.04 | -30.79 | 88.84 | AAK36 | -49.94 | 26.85 | -23.3 | 18.89 | 4.7 |

Table 4.12. Area comparison of selected ellipses to the closest ellipses in Luo et al. [145], as named ibidem.

The study provides the first reflective matching data under such extremely chromatic conditions. For the less chromatic ones where comparison exists, the data suggest that cross-media matching of separated surfaces yields around 5 times larger discrimination ellipses than matching similarly chromatic reflective surfaces under standard strict conditions.

4.4.5 Hue vs Chroma Sensitivity

Another interesting feature of the matching results is the prolonged shape that the matches form, suggesting that observers are more sensitive to the changes in hue than to the changes in chroma. It is even more apparent in the physiological DKL space, see Figure 4.29.

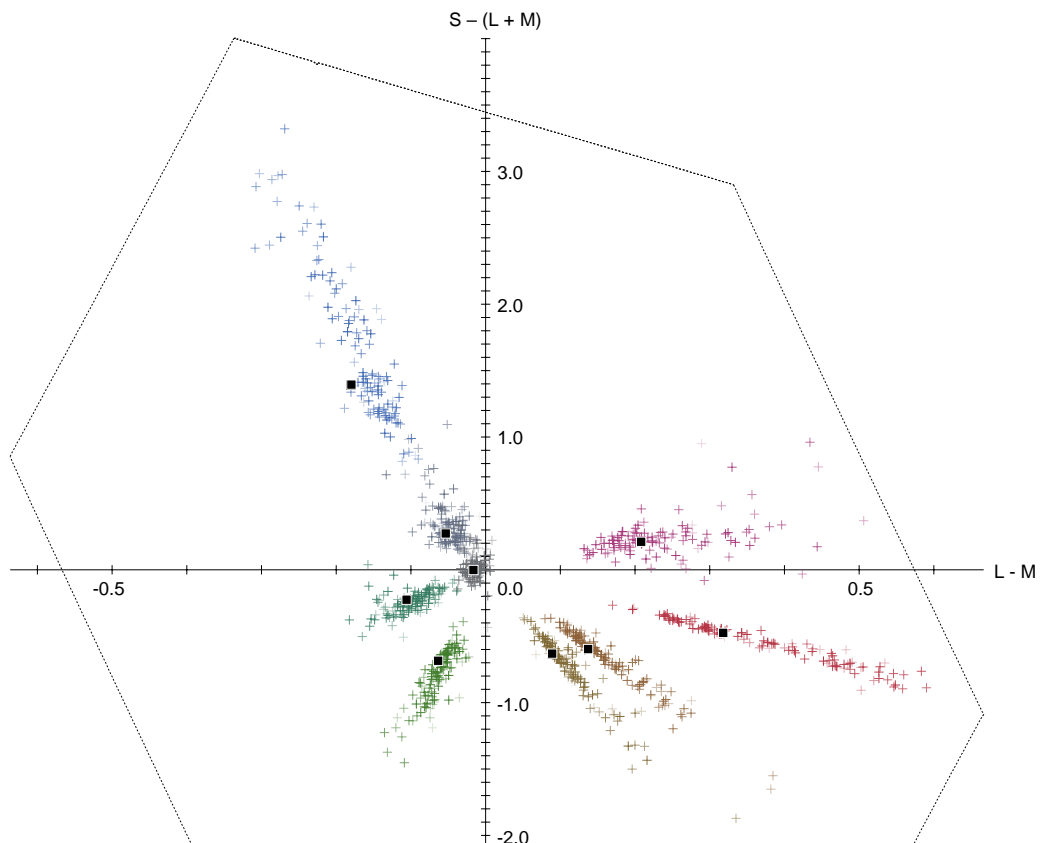

Figure 4.29. Matching results in the DKL space.

The idea that the thresholds for discriminating hue are considerably lower than for discriminating chroma has been already suggested by Judd [146], with the unfortunate corollary that an ‘ideal

colour space', i.e. an Euclidean colour space in which equal distances correspond to equal discriminability, cannot exist. For a comprehensive overview on available data and findings comparing hue, chroma and other differences, the reader is invited to the COLOR SPACE AND ITS DIVISIONS book by Kuehni [87]. Recently, Danilova & Mollon suggested that based on the low-level visual system mechanisms, there is no obvious reason why psychophysical thresholds for hue should be substantially lower than those for chroma, and considered attributing the effect to Mongean noise⁶⁰, since Judd used reflective materials [147]. However, their controlled experiment using 2° stimuli on a CRT display also suggested the effect is real, albeit not to the extent reported by Judd, and that the differences between hue and chroma thresholds disappear for less saturated colours, i.e. colours close to the white point.

The new set of matching data from our experiment provides another view on this effect, in the cross-media conditions. The chroma and hue values that the confident matches span per condition⁶¹ is listed in Table 4.13. Note that due to the distortion of the CIELAB space in the blue area (as can be also spotted in Figure 4.26, the orientation of the ellipse for the blue condition does not align with the definition of hue), the actual difference in chroma vs hue sensitivity will be higher – based on the ellipse eccentricity even higher than for the green condition.









| condition | PCA ellipses | | Confident matches span | | |
|---|--------------|--------------|------------------------|--------------|-------------|
| | major/minor | eccentricity | hue | chroma | C/h |
|  red | 4.07 | 0.97 | 11.34 | 41.59 | 3.67 |
|  green | 2.27 | 0.90 | 17.90 | 33.53 | 1.87 |
|  blue | 3.22 | 0.95 | <u>27.35</u> | <u>42.94</u> | <u>1.57</u> |
|  cyan | 2.44 | 0.91 | 21.52 | 31.60 | 1.47 |
|  magenta | 1.71 | 0.81 | 22.73 | 41.12 | 1.81 |
|  yellow | 3.60 | 0.96 | 15.44 | 39.40 | 2.55 |
|  white | 2.47 | 0.91 | 26.06 | 14.05 | 0.54 |
|  daylight yellow | 2.25 | 0.90 | 14.19 | 25.34 | 1.78 |
|  daylight blue | 2.69 | 0.93 | 25.51 | 16.40 | 0.64 |
| average | | 0.92 | 20.23 | 31.78 | 1.77 |

Table 4.13. Chroma vs hue span of confident matches in CIELAB space. Span values for blue skewed in CIELAB.

⁶⁰ A physical noise present on material surfaces. The theory suggests that since matte surfaces are represented by a distribution of chromaticities rather than a single point, the visual system can recover extra hue information.

⁶¹ Hue span is defined as the arc length between condition matches with minimum and maximum hue angle with the radius of average chroma of those matches, across all participants.

As we can see, the red condition exhibits the highest difference, with observers having $3.67\times$ larger tolerance for differences in chroma than differences in hue, followed by the yellow condition with factor of 2.55. Note that these are the most chromatic conditions, while the conditions around white do not exhibit this 'super-importance of hue' effect (see Figure 4.30), in agreement with the latest results of Danilova & Mollon [148].

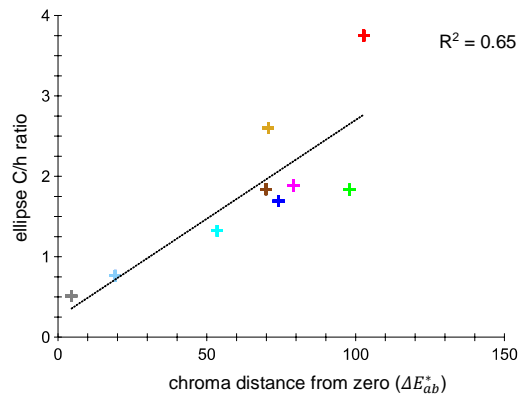

Figure 4.30. Chroma to hue discrimination thresholds ratio (correlation 0.82).

On average, the thresholds for hue discrimination are almost two times lower than for the chroma discrimination. That is more in agreement with Judd than Danilova, however, our viewing conditions resemble more those of Judd, who was more interested in tolerances relevant to industry (binocular viewing, large viewing field, surface materials).

4.4.6 Luminance and Chroma Relationship

In this experiment, observers could also adjust the luminance of the display, and the variance in luminance matches is considerable (average L^* span is 35.9, SD 5.26), see Figure 4.31.

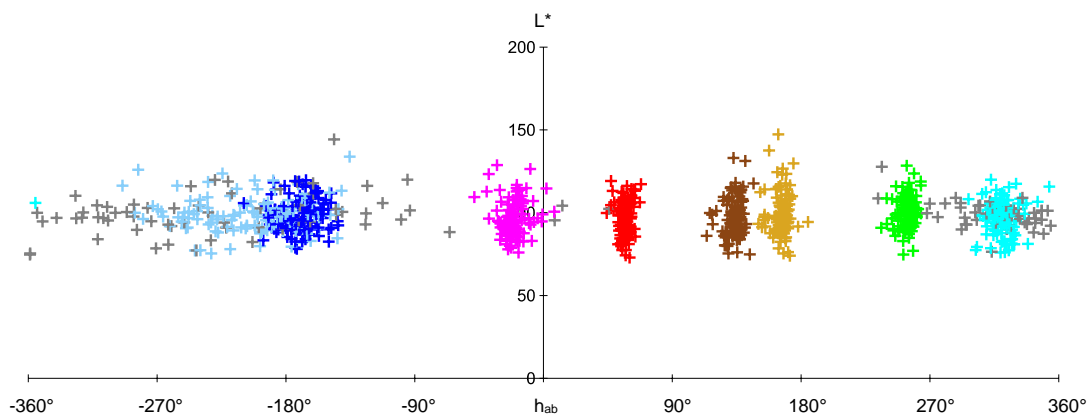

Figure 4.31. Luminance variance in all matches, in CIELAB space using LCh_{ab} (polar) projection.

In fact, the luminance matches are responsible for the spread in the chroma direction, as can be seen in Figure 4.32 and Table 4.14.

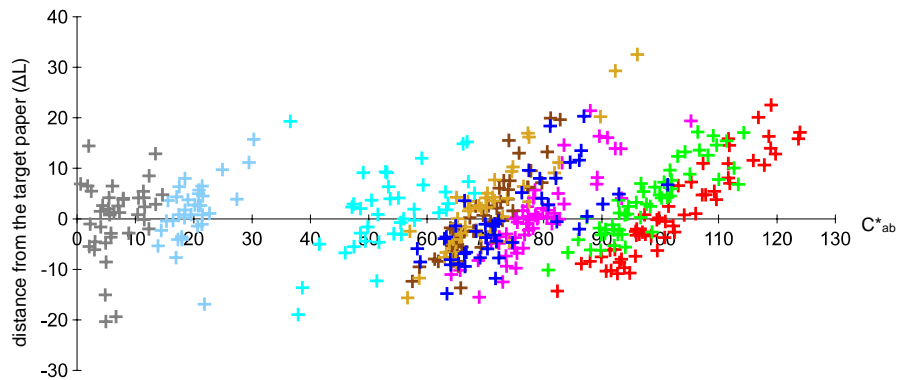

Figure 4.32. Luminance difference in confident matches based on chroma in CIELAB space.

| condition | slope | R ² | correlation |
|-----------------|--------|----------------|-------------|
| red | 0.85 | 0.88 | 0.94 |
| yellow | 1.04 | 0.82 | 0.90 |
| green | 0.78 | 0.79 | 0.89 |
| daylight yellow | 1.17 | 0.78 | 0.88 |
| magenta | 0.93 | 0.74 | 0.86 |
| blue | 0.57 | 0.49 | 0.70 |
| daylight blue | (0.80) | (0.27) | (0.52) |
| cyan | (0.8) | (0.18) | (0.42) |
| white | (0.43) | (0.05) | (0.22) |

Table 4.14. Luminance difference of confident matches and linear regression analysis; ordered by correlation.

In other words, the more observers overshoot the chroma, the more they increased luminance as a form of compensation, and vice versa. It appears that this overshooting error increases with chromaticity of the condition (matches span larger chroma intervals).

In order to verify the hypothesis of effect of the luminance adjustments on the chroma variance, a slight modification of the experiment has been designed in which the display luminance was fixed to match the paper luminance and observers could only adjust the chromaticity.⁶² Two undergraduate students, Kaldora Ibekwe and Stefania-Maria Papadopoulou, collected matching

⁶² Other differences were fixed time of 5 minutes per trial with adaptation to the target colour every 30 seconds, no colour naming and no coarse steps.

data for 6 of the conditions from 49 observers. The initial results available from 41 observers are plotted in Figure 4.33.

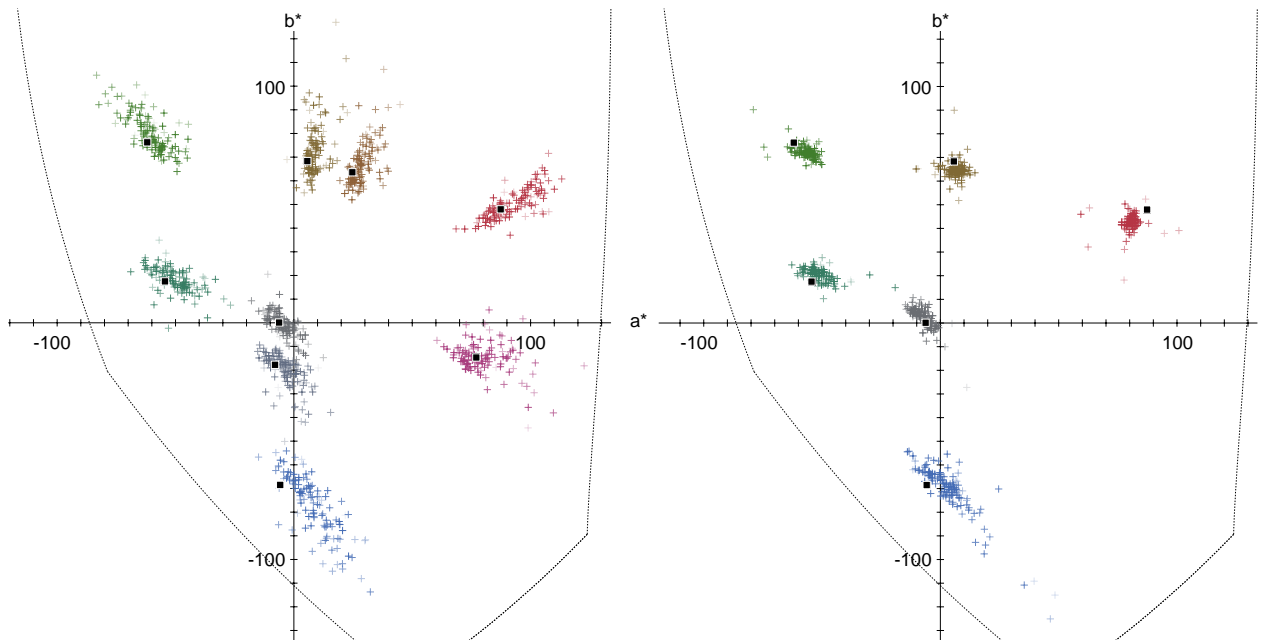

Figure 4.33. Initial fixed luminance data. Right: Additional matches with fixed luminance, in CIELAB space, confidence mapped to opacity. Left: Original experiment data, reprinted from Figure 4.21 for convenience.

Compared to data in Figure 4.23, the green, yellow and red matches are indeed missing the large chroma spread. For the new matches, 410 out of the 695 were with high confidence. PCA analysis of the individual conditions, the hue and chroma span of the matches, and the area comparison to the previous ellipses by Luo and Rigg is summarized in Table 4.15. The area ratio columns are referring to the areas of ellipses with variable luminance to the areas of ellipses with fixed luminance as listed in Table 4.11, and areas of ellipse with fixed luminance to the ones of Luo and Rigg (for their absolute numbers refer to Table 4.12).

| condition | PCA ellipses | | | | | | Confident matches span | | | Area ratio | |
|--|--------------|--------|-------------|-------------|--------|--------------|------------------------|--------------|-------------|------------|------------|
| | a* | b* | major | minor | angle | area | hue | chroma | C/h | 4.4.4 | Luo |
| ■ red | 80.30 | 43.24 | 2.96 | 2.09 | -1.80 | 19.39 | 20.86 | 20.26 | 0.97 | 4.2 | — |
| ■ green | -56.05 | 71.72 | 3.16 | 1.55 | -28.50 | 15.34 | 9.52 | 14.57 | 1.53 | 5.9 | — |
| ■ blue | -0.87 | -66.47 | 7.81 | 2.78 | -45.17 | 68.36 | <u>32.06</u> | <u>24.49</u> | <u>0.76</u> | 1.8 | — |
| ■ cyan | -51.28 | 20.76 | 4.63 | 1.71 | -17.33 | 24.94 | 12.43 | 27.67 | 2.23 | 3.6 | 2.6 |
| ■ yellow | 6.39 | 64.58 | 3.25 | 1.94 | -2.27 | 19.82 | 25.10 | 14.74 | 0.59 | 3.0 | 1.2 |
| white | -7.57 | 2.84 | 3.89 | 1.74 | -44.54 | 21.24 | 24.39 | 12.71 | 0.52 | 2.2 | 1.3 |
| average | | | 4.28 | 1.97 | | 28.18 | 20.73 | 19.07 | 1.10 | 3.4 | 1.7 |

Table 4.15. PCA ellipses for additional, fixed luminance confident matches, with the last column containing comparison to the same ellipses in prior work as in Table 4.12 (N=41 for yellow, blue and white, N=37 otherwise).

This data suggests that without variance in luminance, the confident ellipses become around 3.4× smaller than with adjustable luminance, yet still slightly larger than in the data from pure reflective matching under standard conditions. Red and yellow no longer show higher hue than chroma sensitivity (the ellipses are almost horizontal); the effect slightly decreased for green but increased for cyan.

The results strongly suggest that the large variance in chroma is enabled by observer’s freedom to adjust luminance.

4.4.7 Colour Naming

After each trial, observers were asked to name the colour they were matching (i.e. the colour of the paper card). They had unlimited time for each trial, meaning the level of adaptation, determined by duration of exposure, was not fixed, but might have varied considerably between trials and observers. The most common colour names for all three paper card conditions and all nine light conditions are illustrated in Figure 2.7.

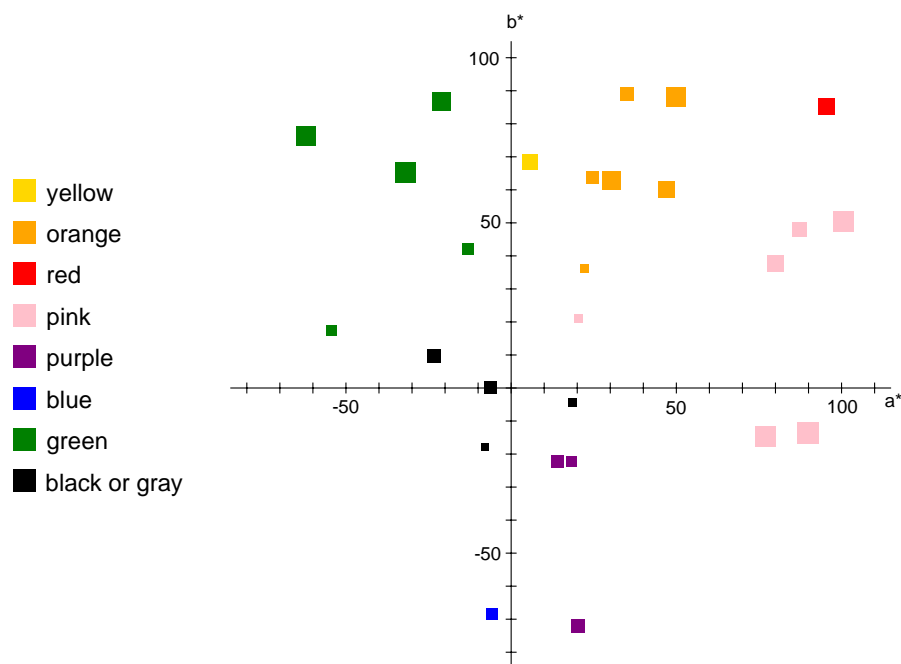

Figure 4.34. Most common colour names per all paper and light conditions. CIELAB space, size corresponds the proportion of the colour name to all colour names for given condition.

All colour naming in relation to trial duration is visualized in Figure 4.35.

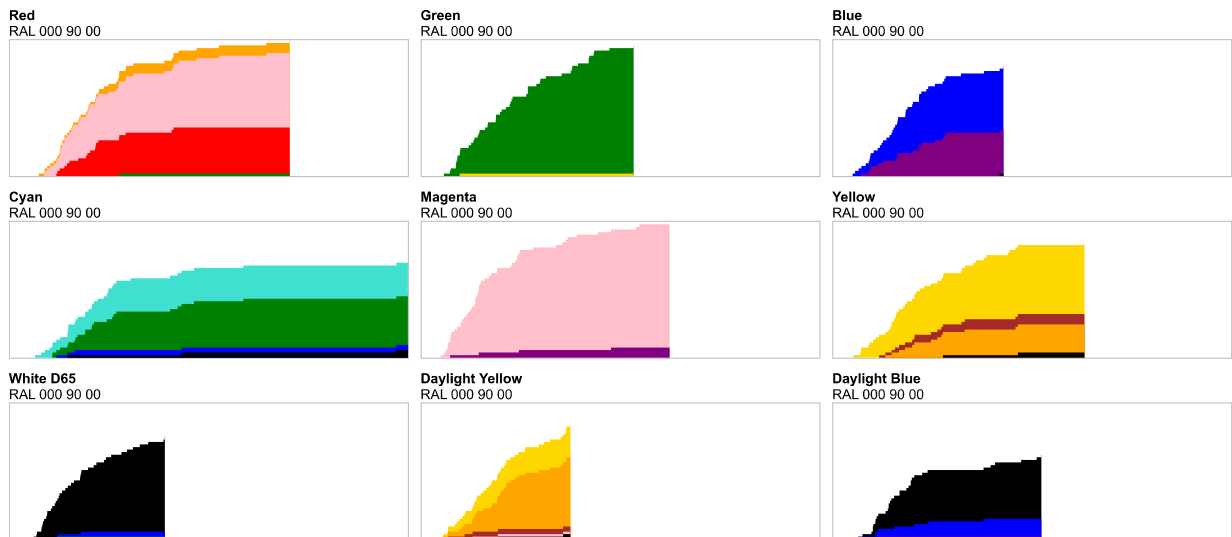

Figure 4.35. Cumulative stacked colour naming as a function of trial durations, winter white paper sheet.

If adaptation to the test illumination were complete, the white paper should appear white, and therefore be named white. We are therefore interested in whether the white paper was named as achromatic or grey, and whether the likelihood of its being named as white or grey increased with the duration of exposure to the test light. Apart from white, only the daylight blue was perceived achromatic in majority of the trials. A few achromatic names also appeared in the blue, cyan and both yellow conditions. The shortest times after which individual conditions were perceived achromatic are listed in Table 4.16.









| condition | shortest time | final proportion |
|---|---------------|------------------|
|  red | — | 0 % |
|  green | — | 0 % |
|  blue | 47.5 s | 8 % |
|  cyan | 29.1 s | 11 % |
|  magenta | — | 0 % |
|  yellow | 72.2 s | 3 % |
|  white | 15.5 s | 91 % |
|  daylight yellow | 50.5 s | 5 % |
|  daylight blue | 13.3 s | 68 % |

Table 4.16. Achromatic colour naming summary.

The observers never fully adapted to non-daylight colours, i.e. red, magenta and green were never called white or grey (the longest trial under these conditions being over 4 minutes long). Note though that a recent experiment of Gupta et al. suggests that adaptation to extreme chromatic

lights continues even beyond 5 minutes, altering the chromaticity that appears neutral to the observer [149].

We also note that observers were able to match the colour of the white card, despite calling it non-white in 88 % trials overall, under chromatic illumination.

4.5 Summary

In this chapter, we were interested in human visual perception of reflective and emissive media and their differences under extreme chromatic conditions. We designed a psychophysical experiment, in which 23 observers matched the colour appearance of a physical paper card to that of a standard emissive TFT display under varying conditions.

We found that the average distance between observers' display setting and target paper colour was $\Delta E_{abL}^* = 10.2$. We established that the discrimination ellipses are of size $16.0 \times 6.0 \Delta E_{ab}^*$ on average, with achromatic colours being more accurately matched than the chromatic colour matches. This result indicates how accurate an algorithm must be in doing the same matching task for users to not perceive a significant difference.

In agreement with some of the previous results, our observers were about twice as sensitive to differences in hue than differences in chroma under our conditions, however, we have also seen this effect to disappear when the luminance is fixed. Observers tended to compensate higher chroma of matches with higher luminance and vice versa.

Finally, observers were able to perform the matching task despite the white paper appearing non-white, and they never adapted to non-daylight lighting conditions.

During the experiment, some participants expressed confusion about which surface is display and which paper, and which surface is the one they are actually adjusting when doing the matches, suggesting that the idea of making an emissive display look like a piece of paper is not unrealistic, despite other differences between the two surfaces such as material structure or specular highlights.

Chapter 5. Paper-like Displays: Algorithm Design, Implementation and Evaluation⁶³

In the previous chapters we have learned that paper and other reflective surfaces absorb and reflect light from a light source, while emissive displays fulfil the function of a light source itself. Without light, paper cannot be seen, neither can it produce wavelengths that are not present in the light source⁶⁴. Display, on the other side, can produce any colour on its own, regardless of the light in its environment.

The premise of this thesis is to realize the idea of moving a display into attentional periphery by developing a technology that would make an emissive display react to the light the same way a normal reflective paper does as much as possible, effectively turning the display in an unobtrusive interactive surface, as can be seen in Figure 5.1.



Figure 5.1. Demonstration of paper-like technology under different lighting conditions. For each condition: Top right: A tablet display as sold, running standard adaptive brightness algorithm of the operating system; Top left: A tablet display with paper-like technology, matching a paper in both brightness and colour; Bottom left: An image printed on a glossy paper using an ink-printer that the display is trying to match; Bottom right: A tablet with paper-like technology matching only brightness but not colour.

In this chapter, we will describe the hardware, algorithm and implementation of the algorithm that the paper-like tablets in Figure 5.1 are running. The calibration procedure requirements and process are discussed, and then we evaluate the algorithm's performance, both quantitatively in colorimetric terms in lab conditions and qualitatively in a real-world scenario, verifying that

⁶³ Parts of this work were published in [172], [189] and [190]. A video overview of the system is available in [172].

⁶⁴ Unless the paper contains special material, whose electrons can emit photons spontaneously for other reasons (luminescence), including re-emitting photons at different wavelengths (fluorescence). Fluorescent additives are often used in common office paper and washing powders to increase whiteness of paper sheets and white clothes by absorbing UV light and re-emitting it as visible blue light.

emissive displays with paper-like technology become acceptable even in such unforgiving environments as peoples' bedrooms.

5.1 Related Work

5.1.1 Information Displays in the Periphery

The ability to present information in a way that is more environmentally integrated has been a long-sought goal in the ubiquitous computing domain. Pousman and Stasko refer to “ambient information systems” and their taxonomy of devices [150] provides many examples of work in the domain. A key common element across these efforts is the transition between users' periphery and focus of attention and back, just as what we saw in Weiser and Seely Brown's idea of “calm technology”. That these displays fade into the background is critical: Mankoff et al. report that an ambient display's ability to move into the periphery was judged to be the most relevant factor in its usability [151].

A large number of ambient information systems in the literature have been built around commodity display panels [7, 152, 153, 154]. In some of these systems, light emission has been shown to interfere with the displays' ability to fade into the background. For example, Consolvo et al. reported that the glow from the CareNet display they deployed disturbed users who were in bed or trying to watch TV [7]. In response to user feedback, Consolvo et al. proposed that their ambient display should automatically dim in response to ambient illumination.

5.1.2 Colour Matching

Colour matching, i.e. the ability to recreate observed colours, is required across fields as diverse as car manufacture [155], fashion [156], industrial design [157], dentistry [158] or augmented reality [159, 160, 161]. The closest colour matching task related this work is the colour appearance modelling [91], which predicts how an image or colour will appear under various lighting conditions. The digital content is then modified so that it appears on the display as it would in the modelled environment, assuming the display is under strictly defined viewing conditions. The difference with paper-like displays is that we will adjust the display properties to target highly variable viewing conditions, relaxing the requirement on a colorimetric match to a specific reference. This allows the display to blend into the background enough to decrease the distracting nature of displays.

5.1.3 Responding to Ambient Illumination

The main motivation for sensing ambient light in the HCI literature is to enhance the display on devices occupying the centre of a user's attention. Adaptive backlighting and colour corrections or transformations have been employed to improve users' viewing experiences on both situated devices [162, 163, 164] and mobile devices [165, 166, 167]. Choi [165] observed a correlation between illuminant colour temperature and user preferred colour temperature and suggested designers to provide users means to adjust the device colour adjustments. Studies on colour adjustments in mobile devices have used prepared bitmaps of white screens or simulated web pages [166], while the paper-like display algorithm proposed here runs in real-time without the need to modify existing applications.

Other authors tried to non-linearly modify the colours of a displayed image [167, 168, 169] in order to make it even more visible or to save power across various luminance levels while retaining acceptable image quality. This work is complimentary to the work in this thesis, as we are trying to address devices in the periphery, while these authors deal with a foreground mode of operation. They could be easily used on the same device simultaneously.

In commercial space, f.lux⁶⁵ is a popular application for adjusting the colour temperature of the display based on location and time of day but not actual lighting conditions. Microsoft's Night light feature in Windows 10 is a similar attempt that switches between normal and warm colours based on the time of the day only, though the switch happens quite abruptly in a short period of time. Apple's TrueTone feature in new iPads employs two light sensors and alters the display to improve colour accuracy and improve readability. Note that none of these features are trying to match environment with chromatic lighting as we discussed in Chapter 1, they only adjust white tone along the Planckian locus curve. Although these efforts adjust luminance and colour of the display in response to external lighting conditions, they are targeted to displays that are being directly attended to, rather than peripheral displays. In the iPad case, since it is battery powered, when the device determines it is not in active use, it goes quickly into low power mode – not calmly fading into the periphery but turning the display off.

A smaller set of projects feature peripheral displays adapting to match ambient illumination. The Video Window [170] was an early implementation of a display that by design coarsely responded to

⁶⁵ <http://justgetflux.com/>

ambient illumination by mirroring the view from a camera mounted outside the house. The fact that the Video Window was responsive to illumination may partially explain why the author did not find the device disruptive in his bedroom.

We have already mentioned Bavor's personal project in the introduction [19]. He blogged about a home-built system making a light emitting screen look like reflective media by using photodiodes to match luminance. In Bavor's implementation, only the luminance is taken into account and color adjustments are hard-coded. Moreover, the calibration must be performed on a per-environment basis and it was only tested in that single environment. In contrast, the paper-like algorithm requires a single, environment-independent calibration step and performs brightness as well as colour corrections. Unlike in his case, comprehensive details about the hardware and software implementation are described in this thesis.

Finally, reflective display technologies, like electronic ink (e-paper), are able to sidestep the problem of illumination mismatch. However, there are significant trade-offs when using these alternative display technologies. E-paper suffers from much slower refresh rate, poor colour reproduction at the best, and higher cost when compared to the LCD or OLED panels running the algorithm described below, providing the illumination matching that e-paper offers. The goal of this work is to show that existing technologies that are already part of our daily lives can have the qualities of the reflective technologies with minimal market penetration.

5.2 Algorithm design

Since the algorithm needs to adjust a display according to lighting conditions in the environment, it needs to know the parameters of the display and continuously sense the light in the environment. At the end of the processing pipeline, the algorithm outputs the required backlight intensity to adjust brightness (if applicable), and values linearly scaling the gamma correction curves of the display device (typically a graphics adapter) to adjust the chromaticity.

In general, during the calibration phase, the user adjusts the display to the desired outputs under series of lighting conditions, and the algorithm remembers these settings with the corresponding sensor inputs (*calibration points*). When in operation, the algorithm receives an input from the sensor, finds the closest calibration points with similar sensor readings and interpolates between the output settings stored at these calibration points.

In bright conditions using a typical LCD screen, brightness and chromaticity adjustments can occur independently. However, when the display technology does not have a backlight control, or when the desired brightness level is below the lowest backlight setting, the gamma scaling factors are further adjusted to achieve this lower brightness, which shall be called the *negative brightness*. For an overview of the algorithm flow, see Figure 5.2.

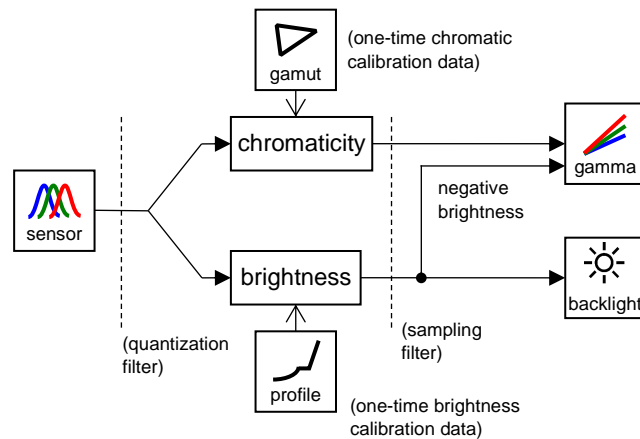

Figure 5.2. Schematic overview of the paper-like algorithm

5.2.1 Establishing Working Colour Spaces

In order to be able to perform linear interpolation between the outputs, we have to choose colour spaces both for the sensor inputs and the desired outputs so that they are additive and perceptually uniform. The display output space is relatively straightforward. For perceptual uniformity, we have CIELAB and CIELUV colour spaces. Since LUV transformations employ subtractions, LAB transformations use divisions and we are especially concerned about very low light conditions, LUV is a better fit from both performance and numerical stability point of view. Moreover, LUV comes with an associated CIE 1976 $u'v'$ chromaticity diagram, which allows us to separate chromaticity and brightness matching, and, while the perceptual uniformity is not perfect, it is the best possible one using linear transformations only, as discussed in 2.7.1.

The situation with sensing part is less clear. Being built on the principles of integrating the light spectra, it is impossible to convert an output from any RGB sensor to the integration output of human colour matching functions. One could use a specialized sensor that has the same spectral characteristics as human vision (e.g. 3.2.3), but these are not commonly available in devices, they are expensive and the current manufacturing technology allows only for a very narrow sensing angles.

However, our algorithm is not concerned about the absolute colorimetric values of the colour sensed, but only about the colour's relative position in the colour space with respect to the sensor's absolute limits. In order to transform RGB values to the $u'v'$ chromacity diagram, coordinates for red, green and blue primaries are needed. The concept of primary colour is not well defined for sensors and can be chosen rather arbitrarily. In this work, we will use the chromaticity diagram's spectral locus corresponding to the peak sensitivity of each of the sensor's channels (in our case, 615 nm, 525 nm resp. 465 nm) as the primaries, as shown in Figure 5.3. This space will be referred to as the $\hat{u}'\hat{v}'$ space as the values are not true $u'v'$ colours in the CIE sense.

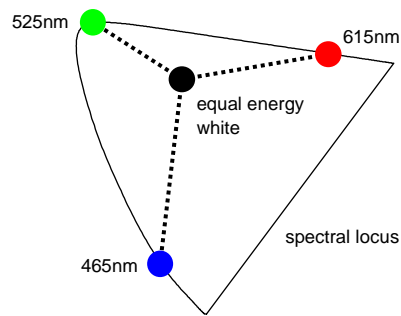

Figure 5.3. RGB sensor pseudo-primaries

The interpolation then happens in the output $u'v'$ space based on relative position of the sensed point in the input $\hat{u}'\hat{v}'$ space. To connect relative positions in these two unrelated colour spaces, barycentric coordinates are used. See the end of Appendix G for a numerical example.

For an algorithmic overview of the process, refer to Table 5.1. We have already discussed the used colour spaces which are characterized by the $RGB \leftrightarrow XYZ$ matrices as explained in section 2.5.2. Description of the individual further stages follows.

1
2 **Prerequisites:**
3 RGBtoXYZ matrix \leftarrow nm peaks of RGB sensor and equal energy white, Y=1
4 XYZtoRGB matrix \leftarrow display gamut coordinates, Y=1
5 calibration points:
6 cut-off and high brightness points for linear positive brightness
7 lookup table for negative brightness
8 sensed $\hat{u}'\hat{v}' \rightarrow \{ \text{desired } u'v', \text{ brightness correction} \}$
9
10 **Sensing:**
11 *inputs: R, G, B, C raw sensor channel readings*
12 *outputs: $\hat{u}'\hat{v}'$ point, luminance*
13
14 drop readings as per quantization filter
15 $\text{normalized}_{R,G,B,C} \leftarrow \text{raw}_{R,G,B,C} / \text{raw}_{\max}$
16
17 $\hat{u}'\hat{v}' \leftarrow$ transform $\text{normalized}_{R,G,B}$ to uv (using RGBtoXYZ \rightarrow xy \rightarrow uv)
18 $\text{luminance}_c \leftarrow \text{normalized}_c$
19
20 **Matching:**
21 *inputs: $\hat{u}'\hat{v}'$ point, luminance*
22 *outputs: normalized R, G, B values, brightness within -1.0..1.0*
23
24 chromaticity:
25 ABC \leftarrow triangle of calibration points enclosing $\hat{u}'\hat{v}'$ point
26 P \leftarrow barycentric coordinates of $\hat{u}'\hat{v}'$ within ABC
27
28 UVW \leftarrow triangle made of desired $u'v'$ points stored at ABC calibration points
29 $u'v' \leftarrow$ barycentric P to orthogonal point using UVW vertices
30
31 R, G, B \leftarrow transform $u'v'$ to RGB (using uv \rightarrow xy \rightarrow XYZtoRGB \rightarrow sRGB)
32
33 brightness:
34 prediction \leftarrow interpolate 2 linear brightness points \leftarrow luminance
35 correction \leftarrow interpolate brightness corrections stored at ABC using P as weights
36 $\text{correction} \leftarrow \text{correction} \cdot \frac{1 + \text{prediction}}{1 + \text{highest brightness}}$
37
38 $\text{brightness} \leftarrow \text{brightnessPrediction} + \text{brightnessCorrection}$
39
40 **Processing:**
41 *inputs: normalized R, G, B values, brightness within -1.0..1.0, raw clear sensor reading*
42
43 desaturate in the dark: (if clear channel \leq 255)
44 weight \leftarrow clear channel / 255
45 R, G, B $\leftarrow \max(R, G, B) - \text{weight} \cdot (\max(R, G, B) - R, G, B)$
46
47 drop results as per sampling filter
48
49 negative brightness: (if brightness $<$ 0.0)
50 R, G, B $\leftarrow R, G, B \cdot (1 + \text{interpolate negative brightness from lookup table})$
51 brightness = 0.0
52
53 hardware gamma LUT \leftarrow R, G, B
54 hardware backlight \leftarrow brightness
55

Table 5.1. Paper-like displays algorithm pseudo-code

5.3 Calibration Process

The attractiveness of the paper-like algorithm lies in the ability to work with any off-the shelf components, whose precise characteristics are often unknown to the end user and therefore have to be established using a one-time calibration step. The calibration procedure does not require any specialised equipment and therefore any widely, already deployed device – be it a phone, tablet, or any device with emissive screen can be turned into a paper-like display as long as it comes with a colour sensor or one can be added it.

Calibration data are required for both chromaticity matching and brightness matching. The calibration step is only required once for each combination of sensor model, its mounting and display panel model. Once acquired, the calibration data can subsequently be shared by any other devices using the same sensor and display combination. The calibration step can be skipped altogether if the sensor’s spectral characteristics matches human vision, the critical data like gamut and luminance are provided by the display panel manufacturer, and the display behaves linearly enough.

5.3.1 Brightness Calibration

Brightness calibration consists of two parts: a positive brightness part controlled using built-in backlight control with linear response, and non-linear, negative brightness part controlled by the same means as chromatic matching, i.e. gamma lookup tables (LUT). Figure 5.4 shows a typical brightness profile of a display, this in particular is of the Fujitsu tablet (3.4.1).

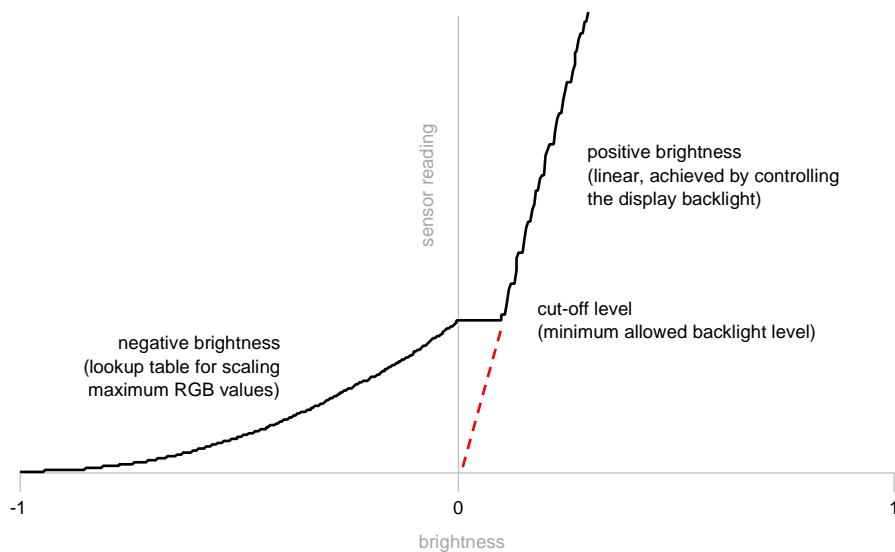

Figure 5.4. Brightness calibration data, including “negative brightness” lower than the minimum backlight level, achieved by using gamma tables to further dim the display.

The backlight controlled linear part (to the right side of “0”) is cut off at the *cut-off level*, a brightness value for which any lower requested value results in the same display output. This is due to the minimum brightness level allowed by OS certifications being usually non-zero, requiring the minimum level to be such that *‘screen contents should be barely visible to the user’*⁶⁶.

Due to linearity of the positive brightness settings⁶⁷, two calibration points are sufficient to capture the display behaviour – at the cut-off level, and at any high brightness setting. The higher the second point is, the less error will be captured. These two points allow appropriate interpolation to the other brightness levels achievable by the backlight, and also accurate extrapolation to the negative brightness levels. Calibration at the cut-off point was achieved by setting the display brightness to this level, changing the ambient illumination so that the display (showing white) looks as bright as a white reflective reference (e.g. paper), and reading out the sensor value. Calibration at the high brightness point consisted of setting the lighting to maximum, and then adjusting the brightness of the display (showing white) so that it matched the reflective reference (the display was capable of producing higher luminance levels than the light source). For more detailed steps on how to perform this calibration, see Appendix G.

Finally, the profile contains a negative brightness curve, which represents the display response when further decreasing the brightness using a multiplicative factor applied to the gamma tables. In this way, brightness levels lower than the cut-off point can be achieved. Since this way of controlling display is non-linear, a lookup table or analytical estimation is required to approximate the display characteristics. In this work, the profile was obtained by placing the RGB sensor directly on the display surface and recording clear-channel sensor readings for brightness levels ranging from 0 to -1.

⁶⁶ see e.g. Remarks in <http://msdn.com/library/jj128356.aspx>. Windows require hardware drivers to be digitally signed by Microsoft, and for that they need to meet minimum requirements and compatibility tests. For more information, refer to Windows Hardware Compatibility Program at <http://docs.microsoft.com/windows-hardware/design/>.

⁶⁷ In general, linear response of the hardware to the brightness settings is not guaranteed, and neither is the sensor required to operate linearly or in units matching to the display brightness. If needed, a lookup table can be employed even for the positive brightness settings, as was indeed the case in early versions of the algorithm. However, all displays used in this thesis (as well as other displays and sensors used during prototyping and demonstrations) turned out to have linear backlight response, and therefore the calibration steps were simplified to take advantage of what appears to be a common behaviour.

5.3.2 Chromaticity Calibration

The chromaticity calibration data consists of the desired display outputs for a set of given sensor readings, including any difference in brightness from what the brightness calibration predicts. The algorithm then interpolates display output from the known points.

In the system used in the studies in this thesis, the set of calibration points includes extremes of the display gamut (i.e. the $u'v'$ coordinates of the red, green and blue primaries of the display), colours midway between them (i.e. cyan, magenta, yellow), and three white points (corresponding to 7000 K daylight, 3200 K incandescent light and centre of the gravity of the gamut, respectively).

The point layout is depicted in Figure 5.5.

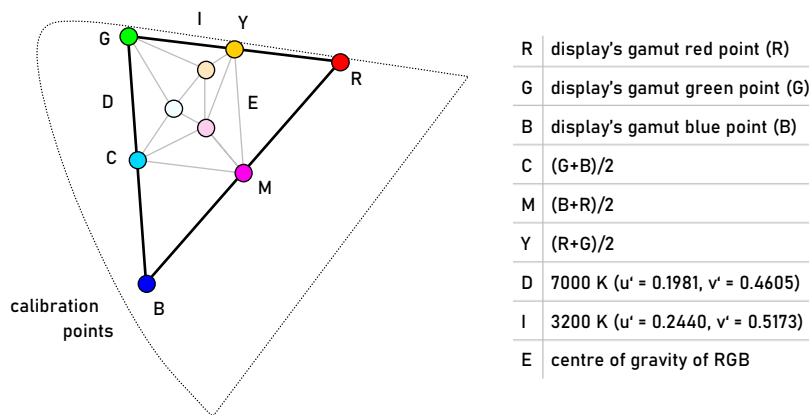

Figure 5.5. Chromaticity calibration data. Coordinates of the points represent the sensor readings transformed into the $\hat{u}'\hat{v}'$ space, colours of the points show the desired display output (RGB triplets), and the point list describes the points in terms of $u'v'$ coordinates that the lighting is set to.

The calibration data can be acquired using configurable lighting. For each calibration point, set the illumination to have the specified colour, sense this electronically, and manually adjust the display settings so that when it displays a white screen, the output matches the colour of a white paper reference. For more detailed steps on how to perform this calibration, see Appendix G. For the setup in this thesis, Philips Hue lights as introduced in 3.5.2 were used to control the ambient lighting conditions, together with Xerox Digital Paper (PW) (wrapping reference 003R94779, 75 g/m²) as a reflective paper reference. The lights were on a desk 55cm away from the sensor, paper and display.

5.4 Colour Matching

For both quantization and sampling filtering, please refer to the section 5.5.2.2 below.

5.4.1 Chromaticity Matching

The chromaticity calibration points in the $\hat{u}'\hat{v}'$ space are turned into triangles using Delaunay triangulation [171] as shown in Figure 5.5. The sensor's RGB values are transformed into the $\hat{u}'\hat{v}'$ space using the primaries mentioned above (code listing line 17). The algorithm then finds the triangle that contains the sensed point (line 25)⁶⁸. If no such triangle exists, it means the display is not capable of matching the chromaticity and the algorithm uses the closest point on any of the triangles as a best effort solution.

Once we have a point on a triangle, we determine its barycentric coordinates, i.e. its relative position in the triangle [172] (line 26). Each of the three $\hat{u}'\hat{v}'$ calibration points of the triangle has a desired display output assigned (in $u'v'$ coordinates). These desired colors form another triangle in the $u'v'$ space. The algorithm's result is the $u'v'$ point that is at the same relative position to the triangle in $u'v'$ as is the sensed point in the $\hat{u}'\hat{v}'$ triangle (i.e. has the same barycentric coordinates), effectively linearly interpolating the desired colours (lines 28-29). Finally, the $u'v'$ result is transformed using display primaries back to RGB for the display driver (line 31). The returned RGB values are normalized to the maximum of 1.0 since the intensity is dealt with separately.

5.4.2 Brightness Matching

Under the assumption that the display's linear brightness characteristics starts at $[0, 0]$, we compute the desired brightness as lying on the line from origin to the high brightness calibration point:

$$brightness_+ = reading \cdot \frac{high\ point\ brightness}{high\ point\ reading}. \quad (5.1)$$

If, however, the resulting brightness is below the cut-off point brightness, i.e. in the $[0, cut-off\ brightness)$ range, we remap it to the $[-1, 0]$ range as negative brightness:

$$brightness = \frac{brightness_+}{cut-off\ brightness} - 1 \quad (5.2)$$

⁶⁸ Finding an enclosing triangle in a triangulation is generally an $O(\log n)$ problem where n is the total number of points. Algorithms achieving the optimal complexity exist but are complicated; an interested reader can find references and examples of simpler methods e.g. in [177]. Since in our configuration we have only 10 triangles, a simple linear search was utilized. Remembering the last enclosing triangle significantly drops the average complexity when light changes continuously.

(line 34). An additional additive correction is applied in case the display was set to different brightness at chromaticity calibration points to account for perceived differences in luminance based on colour. Since barycentric coordinates represent the distance of a point to the enclosing triangle's vertices as values in the range of $[0, 1]$, they can be used directly as weighing the brightness corrections recorded at individual vertices (i.e. chromatic calibration points; lines 35-38).

5.4.3 Desaturation in the Dark

To mitigate undesirable visual artefacts of quantization limits, a final desaturation of the algorithm result is employed. When the light level is so low that it is reaching sensitivity limits of the sensor, the output of the sensor is catastrophically misleading. For example, looking at the sensor spectral sensitivity (cf. Figure 3.6), we can see that the red channel is the most sensitive. It is then certainly possible that a low intensity white light can be below the thresholds for green and blue channels yet cross the threshold for the red channel. In such case, the report from the sensor and consequently result of the algorithm would be “fully red”, which is not in agreement with the environmental conditions.

To avoid possible unnatural and therefore attention-grabbing display output in these cases, the chromaticity matching is inhibited as the light levels approach zero. For the lowest 255 values the sensor can report (which is about 0.4 % of its range), the maximum of the desired R, G and B values is retained, but the remaining channels are linearly scaled so that at zero light level, all three channels are equal, resulting in no chromaticity corrections by the algorithm (lines 43-45).

Note that desaturation is a mitigation of a technical limitation. If the system's light sensitivity was higher and the display could match such low levels (or the system was analogue), desaturation wouldn't be necessary.

5.4.4 Negative Brightness

Realizing the negative brightness is the last step of the algorithm (lines 49-51). It is achieved by uniformly decreasing the RGB result of the chromaticity matching (after desaturation). The desired brightness is looked up in the negative brightness profile obtained during calibration, and the corresponding sensor reading, scaled to $[0, 1]$ where 1 corresponds to the cut-off sensor reading, is used as a scaling factor for the RGB result.

The final RGB values are used as linear coefficients in the graphic adapter's gamma lookup tables. LUTs are used by the graphics hardware as the last step of screen content composition, originally intended to compensate for non-linearities in CRT monitors. On Microsoft Windows operating systems, the *SetDeviceGammaRamp* function⁶⁹ can be used to load an arbitrary LUT in the hardware. Our algorithm modifies this to be a linear function of the result, e.g.

$$output_R = display_R \cdot input_R \quad (5.3)$$

This way, the chromaticity matching is applied globally to all content displayed on the screen without extra computational overhead, it can retain the existing screen calibration stored in LUTs and, as the ambient lighting decreases, the screen content eventually turns completely black.

5.5 Light Sensor

Neither of the tablets used in the forthcoming studies had a built-in RGB sensor accessible to the user, so an external one was supplied. A built-in camera might seem like a tempting alternative for sensing lighting the conditions; however, it is not suitable for several reasons:

- a) In order to mimic a reflective surface, we are interested in the light incident on the surface of the device, whereas the camera senses the light levels of remote surfaces and light sources. This could be practically resolved by putting a diffuser (such as sheet of paper) right in front of the camera, however, it renders the camera useless for its normal purpose.
- b) Cameras employ, either in hardware or in drivers, various automatic compensations of the image that cannot be switched off, effectively destroying the very signal we are trying to sense.
- c) Compared to even the most basic RGB sensors, common cameras suffer from poor dynamic range, high noise levels and processing complexity, as well as high power consumption.
- d) Last but not least, it violates the principle of least privilege [173], and having a camera on all the time, including and especially when the device is not being actively used might raise some privacy concerns among users.

⁶⁹ <http://msdn.com/library/dd372194.aspx>

Therefore, an RGB sensor is a better choice, and many inexpensive, off-the-shelf RGB sensors can be used for the paper-like displays algorithm. This section summarizes the design of an external sensor used later with the tablets and solutions to some of the practical challenges.

5.5.1 RGB Sensor Requirements

During prototyping the system, Intersil's ISL29125 RGB sensor has been used, available on MikroElektronika's COLOR 2 click board⁷⁰ and interfaced through an mbed LPC11U24 development board⁷¹ (see Figure 5.6).

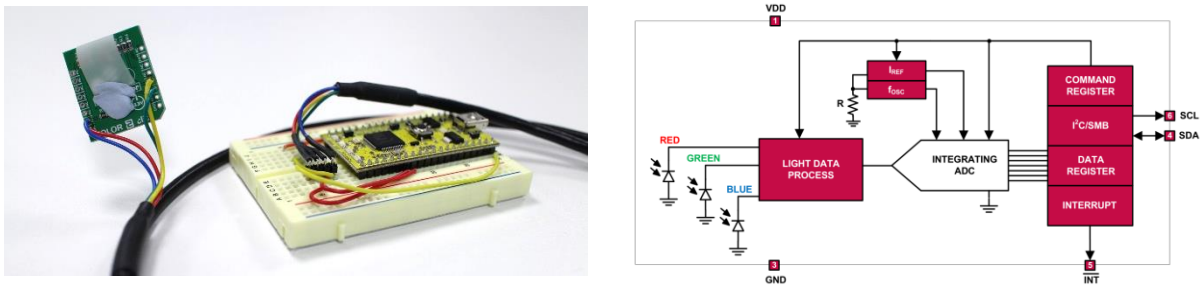

Figure 5.6. Prototype sensing using ISL29125 with an improvised diffuser.

That sensor has a single ADC that can read only one of the red, green and blue channels at a time, but all three channels are required to sample the environment condition. Now consider two conditions, a room with lights off, e.g. $R=G=B=0$ and the room with lights on, e.g. $R=G=B=1$. If the lights are switched on in the middle of reading an RGB triplet, the sensor can read e.g. $R=G=0$ and $B=1$, claiming the light in room is bright blue which was never the case. As a result, the algorithm would produce a visible flash of a bright blue tint on the screen. Specially, if the room has lighting that keeps constantly changing (for example, slowly fading LED strips), such sensor *never* reports a real colour from the environment.

Hence a critical requirement of the paper-like algorithm (and any other algorithm expecting to sense colour that changes over time) is that the RGB sensor has a separate ADC for each colour channel sensed, allowing to read them synchronously.

5.5.2 Final Hardware Design

In the remaining work presented in this thesis, a custom-made hardware solution based on the TCS34725 by sensor introduced in chapter 3.2.2 was used. I am grateful to Philip Wright, Tobias Grosse-Puppenthal, Nick Trim and John Helmes from Microsoft Research for designing and

⁷⁰ <http://www.mikroe.com/color-2-click>

⁷¹ <http://os.mbed.com/platforms/mbed-LPC11U24>

producing the PCB combining the RGB sensor and a MSP430 processor a small, plug and play USB sensor. This RGB sensor has 4 channels, red, green, blue and clear for overall luminance, each with their own ADC (see Figure 5.7).

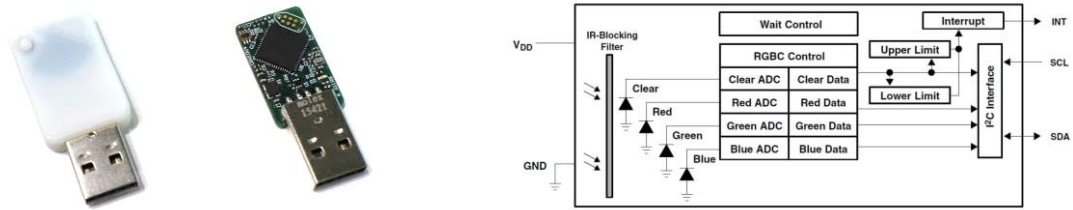

Figure 5.7. Custom-built USB dongle with 4-channel (RGB+clear) TCS34725 light sensor.

I authored the firmware running in the sensor, fixing the integration time to 24 ms (i.e. theoretical limit of about 40 readings per second), and performing automatic gain switching.

5.5.2.1 Angular response

Typically, the sensitivity of an RGB sensor varies significantly with the incident angle of the light (Figure 5.8). That means that the system is very sensitive to the relative position of the light source with respect to the sensor, and a system calibrated with straight-on light ends up too dim when the light is coming at an angle. Diffusive reflective surfaces such as paper have much more uniform angular responses, due to scattering incoming light in all directions.

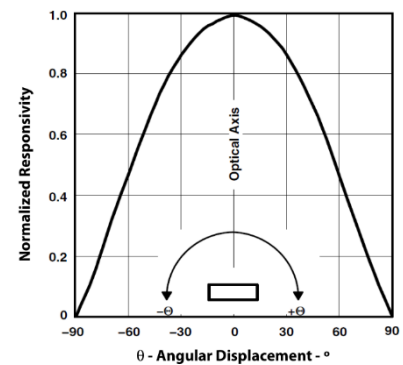

Figure 5.8. Angular response of TCS3472 (from its datasheet).

In order to equalize the response across all angles, we can try to diffuse the incoming light so that the light reaching the sensor is the same regardless of the angle it comes from. Using a stepper motor from LEGO® MINDSTORMS® EV3⁷², I built an angular response measuring device for evaluating various means of achieving the desired sensor response (see Figure 5.9). Controlled by computer, it rotates the sensor against a fixed light source in steps of 5 degrees. Since we are interested in general shape of the response, colorimetric accuracy isn't necessary for these experiments.

⁷² <http://education.lego.com/product/mindstorms-ev3>

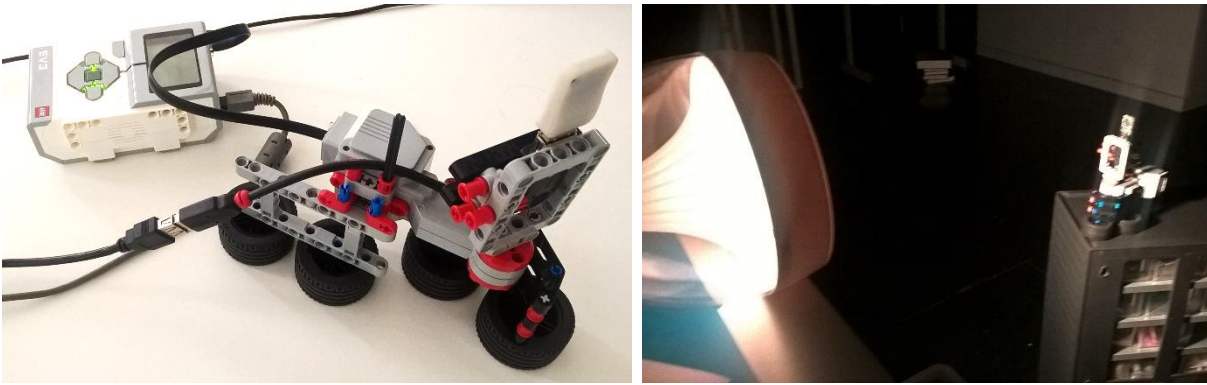

Figure 5.9. Angular response automated measurement.

Many materials have been tested, including cotton, paper tissue, paper and plastic sheets and various transparencies, an optical diffuser, both from inside and outside of the sensor case (selected measurements plotted in Figure 5.10). A simple paper provided the flattest response, yet the attenuation at $\pm 60^\circ$ was still around 50%. Another option for response equalization is to inhibit the sensor's response to direct light while keeping its lower sensitivity at steep angles unaffected and therefore flattening the response curve. Since the sensor case is 3D printed, an attractive option is to model a 3D printed structure above the sensor surface to control the angular responsivity. With the help of John Helmes, who was modelling and 3D printing various shapes, materials and surface finishes, we eventually succeeded in achieving an acceptably flat response with less attenuation than a simple paper diffuser, see Figure 5.10.

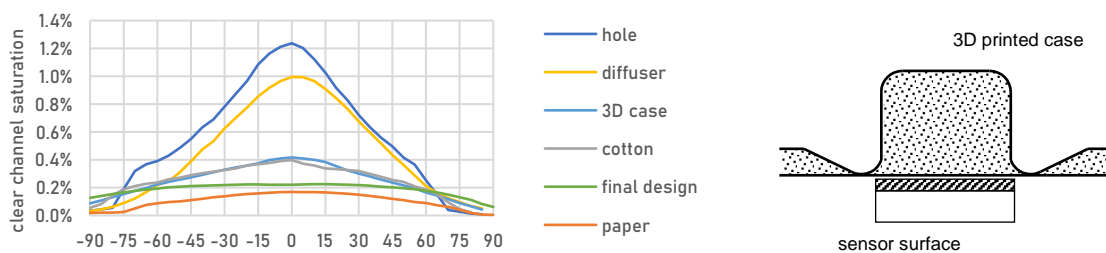

Figure 5.10. Light sensor design. Left: angular response (measured) for various materials on top of the sensor surface. Right: cross-section of the final 3D printed enclosure

5.5.2.2 Flicker filtering

Display flickering is very distracting and obviously counterproductive phenomena when trying to design a display that seamlessly blends into the environment. In initial pilot trials of the system, two sources of flicker were identified: quantization flicker and sampling flicker.

Quantization flicker is an artefact of discrete value resolution during the analogue to digital signal conversion. It occurs when the light level is exactly at the boundary of two digital values reported by the sensor, resulting in a stream of consecutively alternating values. The value changes by ± 1 on

every read and is generally of transitional nature, since any change in the lighting level will swing the values one way or another. The darker the environment, the more serious and visible the flicker is as it can result in dramatic differences in the algorithm results.

Sampling flicker is an artefact of discrete time resolution during the analogue to digital signal conversion. The reported values are representation of an actual light source flicker that is invisible to human eye (many light sources flicker, including fluorescent tubes and LEDs), however, the ADC is not fast enough to capture the true frequency of the flicker and, following Nyquist-Shannon sampling theorem, produces lower, false frequencies that become visible. Sampling flicker does not depend on the intensity of the light and therefore is permanently present for any flickering light source.

Illustration of causes of flicker is depicted in Figure 5.11.

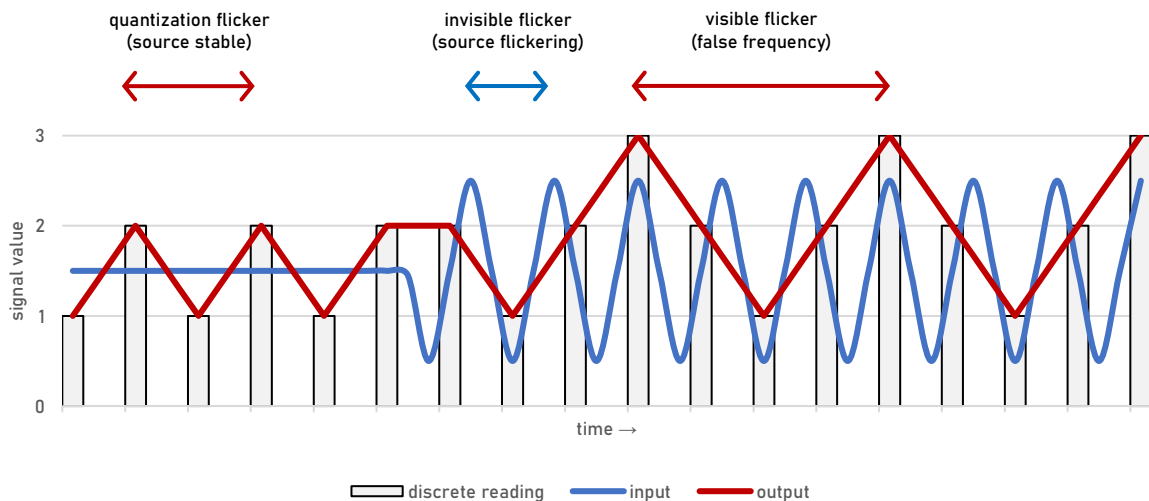

Figure 5.11. Causes of flicker

Common way to alleviate flickering artefacts is filtering the signal, for example using a moving average, where number of last values is averaged. The more values are averaged, the more stable the filtered output is. While averaging last 2 values can mitigate the quantization flicker, averaging larger number of samples is unsuitable for paper-like displays, since it delays and smoothens sudden changes in lighting. To mimic the paper in reflecting light, we need to react as fast as possible when lights are switched off or on.

As a compromise between responsivity and sampling flickering, the system prototype utilized a *timed error* filter. The new result would be let through only if the change from the current output is big enough, or if given time has passed since the last result was applied. The error threshold was

set to 0.02 of distance between current and previous results, which was defined as the maximum of changes in red, green, blue and double of brightness:

$$err = \max \left(\begin{array}{l} |display_R - lastDisplay_R|, \\ |display_G - lastDisplay_G|, \\ |display_B - lastDisplay_B|, \\ 2 \cdot |brightness - lastBrightness| \end{array} \right). \quad (5.4)$$

In trials experiments, a timeout of 250 ms was used, which yielded satisfactory flicker mitigation. On reflection, more elaborate methods might be desirable. As long as the sampling is at regular intervals, there is always a risk of false frequencies. One possible solution would be to combine randomized sampling with moving average that would reset immediately any time the change crosses a threshold.

5.6 Lab Evaluation

In order to quantitatively assess the performance of the above discussed algorithm, an in-lab experiment has been conducted using the Philips Hue lights and XYZ sensor.

5.6.1 Measurement Set-up

The objective of the experiment was to measure the colour differences between a blank sheet of paper and an emissive display running the paper-like algorithm and showing white colour, across varying lighting conditions. The tablet introduced in 3.4.1 was used as a display, the Xerox paper used for calibration (5.3.2) as a reference, and the XYZ sensor integrating directly into the human perception based CIE XYZ space introduced in 3.2.3 was used for the colorimetry measurements.

The setup is depicted in Figure 5.12. A display with the RGB sensor was attached to a white wall made of foam core, lights were placed facing the display, and the XYZ sensor was placed on the axis perpendicular to the centre of the display so that the screen height constitutes 10° of the sensor's view. Since we are measuring differences only, the exact positions of the lights and distances are not important as long as they stay the same throughout the measurements.

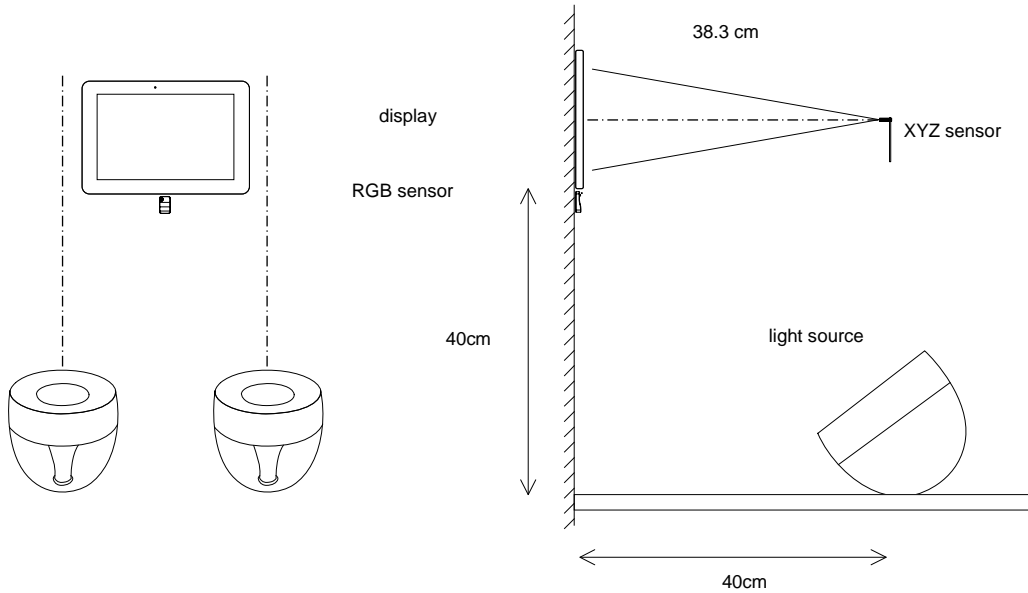

Figure 5.12. Quantitative evaluation setup

Emissive sources are usually measured in the CIE LUV space [174], while reflective sources in the CIE LAB space [24], so there is no clear common space for comparison. However, since our aim is to make the display look like a reflective medium, we will evaluate it in the LAB space. It bears noting though, that the conditions under which these spaces and metrics were designed differ considerably from the evaluated application, which includes varying lighting conditions from total darkness to very saturated colours, so the values are not directly comparable to other colorimetry measurements in the literature. Nevertheless, we should get at least some sense on the algorithm's performance.

The experiment was conducted as follows: The display and lights were turned on and to white for several minutes, so that they warmed up and the measurements were stable. A piece of paper was placed over the (inactive) display. The light was then set to produce several colours (described below) for 5 different brightness levels, and the colour reflected from the paper was measured and recorded. Each measurement consisted of averaging 3 sensor readings each integrated over 400 ms. Then, the paper was removed from the display, the display was turned on (operating as described in 5.1), and the measurements were repeated for the same colours/brightnesses. Finally, the Euclidean distance error in the CIE LAB space ΔE_{abL}^* was calculated for the display for each color/brightness combination, using the paper data as ground truth:

$$\Delta E_{abL}^* = \sqrt{(L_1^* - L_2^*)^2 + (a_1^* - a_2^*)^2 + (b_1^* - b_2^*)^2} \quad (2.34)$$

As a white point reference, the display's white screen on full brightness was used. The Philips Hue lights are not able to match the full brightness range of the display in this setup (L^* ranged roughly from 20 to 63), and the colour gamuts are also different as can be seen from the triangles in Figure 5.13.

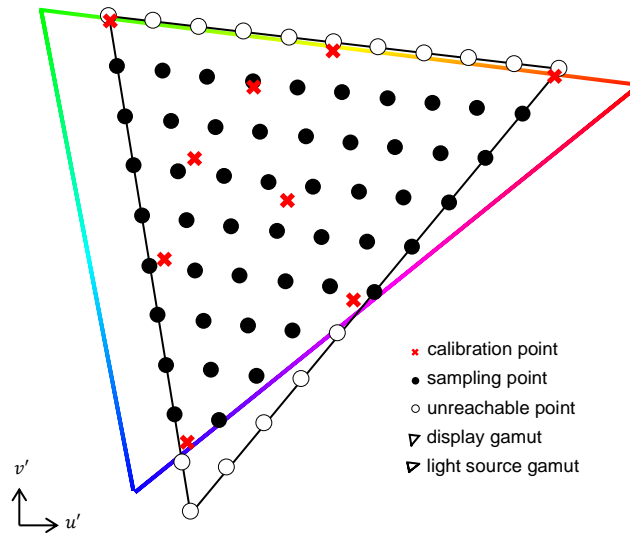

Figure 5.13. Gamut sampling

The display's gamut in $u'v'$ was sampled uniformly using 66 points by dividing each side of the gamut triangle into 10 equally sized parts - see the points in Figure 5.13 - and only those that could be matched with this setup were measured (50 in total). That way, the measurements could be directly compared to results achieved by other systems running on the same display. The above was repeated for five brightness level settings on the light source (2, 65, 128, 191, 254), corresponding to the L^* values of 20, 26, 38, 51 and 63 respectively, giving us a total of 250 measurement points.

5.6.2 Results

The average error across all 250 measured points was $\overline{\Delta E_{abL}^*} = 6.16$, $\sigma^2 = 12.38$, median 5.35.

The distribution of the error can be seen on Figure 5.14, including contribution from individual brightness levels.

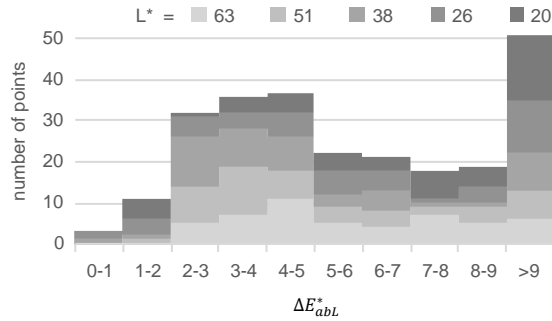

Figure 5.14. Overall distribution of the measured colour distances, shades correspond to the brightness level.

Figure 5.15 further shows the individual colour differences for three selected brightness levels ($L^* = 20, 38, 63$). The colour points represent the paper measurements and each of the point features a line to the corresponding display measurement.

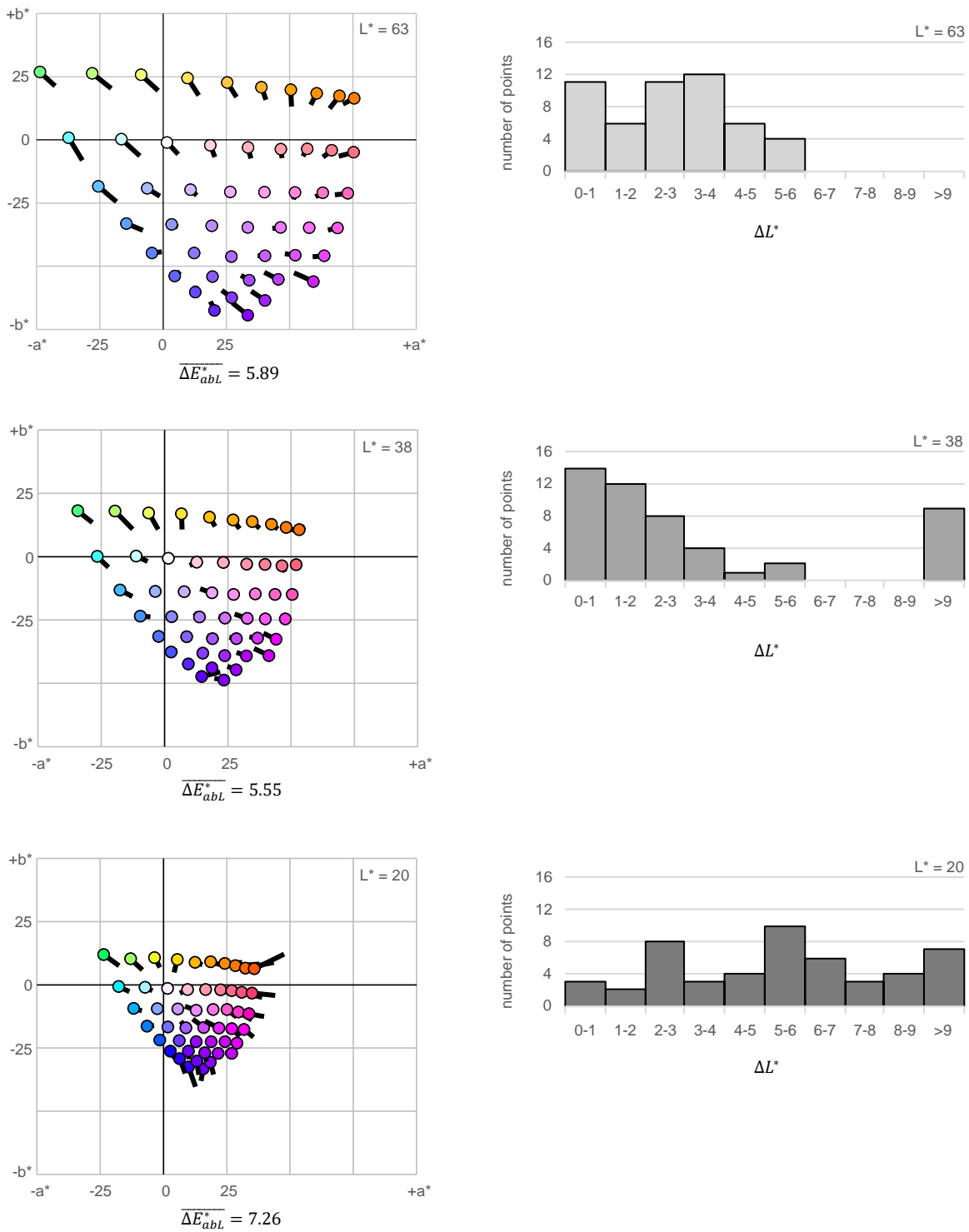

Figure 5.15. Distribution of differences between the display and paper for selected brightness levels. Left: individual chromaticity differences. Right: brightness differences.

To put the numbers into some perspective, under the metric's defined conditions, a ΔE_{abl}^* value of 2.3 is usually considered as indistinguishable for two adjacent colours, although the threshold varies significantly across the space [175]. For example, one of the early but still often referenced works in this area uses the length of axes of the MacAdam ellipses [176] for the threshold, and this ranges from 0.9 to 9.9 with an average of 3.6 [177] in this colour space. Colour perception also

considerably differs between individuals [178] and the threshold increases with complex content compared to a single patch of colour [179].

To get a better idea of a threshold in comparable conditions to those in which our system is intended to be deployed (e.g. as in the bedroom scenario presented in the next section), a small trial was held, in which 6 participants adjusted the display's colours and brightness using sliders, aiming to match the paper next to the display the best they could. This suggested an average threshold of $\overline{\Delta E_{abL}^*} = 8.63$. The colorimetry study conducted in Chapter 4 resulted in average threshold ellipses of about 16.0×6.0 size.

In summary, the quantitative evaluation shows that the system achieves an average error of $\overline{\Delta E_{abL}^*} = 6.16$ compared to paper as ground truth. Majority of the measured points in all brightness levels except the darkest one had error of $\overline{\Delta E_{abL}^*} < 5$ across the whole gamut. Based on existing metrics and previous analysis, a user of the system would likely be able to see a difference if given a reference image next to the display for comparison, however without such a reference image, the user is unlikely to notice the display behaving differently to paper. This provides confidence that the system's performance in real-world deployments is more than acceptable, which is in agreement with the results of the field study described below.

5.7 Field Evaluation

The paper-like display prototype running the algorithm was deployed in a two-week field study in 12 participants' bedrooms, with three overall aims:

1. To validate that a paper-like display mode simulating a reflective display would be preferred over normal display behaviour in the bedroom;
2. to verify that the implementation of the calibrated reflective-matching display algorithm and associated hardware had the “calm” qualities desired;
3. to gather feedback from users on their thoughts around calm displays having lived with one, in order to inform future work.

There are two main reasons to use the bedroom environment for evaluating our algorithm. First, it is a particularly challenging environment for situated displays [7]. The hypothesis is that that is because existing displays are obtrusive, and paper-like display mode will make them less obtrusive. Second, it would elicit clear responses during the study. In another location of the house, participants might tolerate an obtrusive device as a research artefact they were being asked to live

with. In the bedroom beside their bed on the other hand, participants would give a strong signal if they felt the device was obtrusive or not, since they could not easily walk away from it.

The display deliberately showed only generic content, i.e. a slideshow of stock photos, with no other “useful” information, in order to avoid bias in the study due to the utility and/or readability of the information itself, which may vary from participant to participant and day to day. Rather we want participants to focus on the comparison between the paper-like display mode and a normal mode.

5.7.1 Study Design

The overall study design is a within-subjects comparison of the paper-like display running the matching algorithm described at the beginning of this chapter and a “normal” display. The normal display implements adaptive brightness as many tablet PCs do, but this is relatively unresponsive to the ambient light, as the introductory Figure 5.1 shows.

Participants received a 10.1” display tablet PC with attached RGB sensor described in 5.5 and an AC adaptor, and placed it in their bedroom in plain sight from their bed as shown in Figure 5.16.

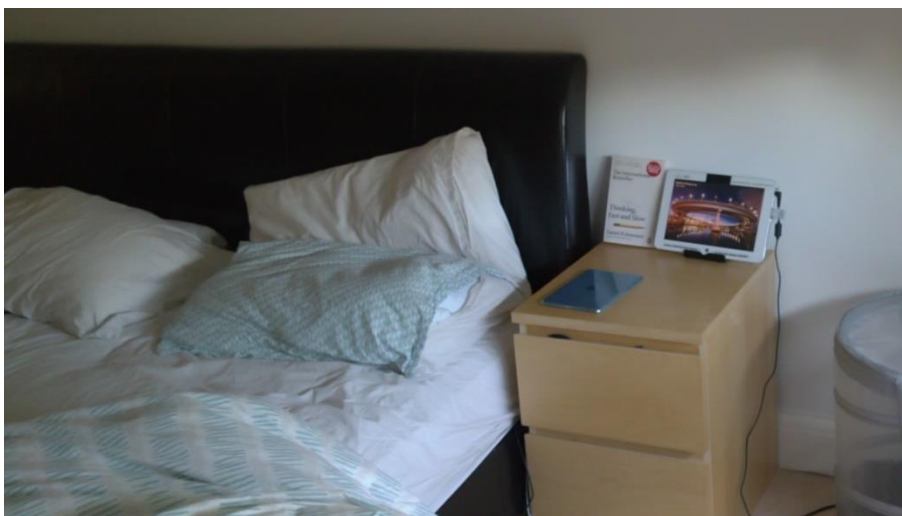

Figure 5.16. An example of the deployed device in-situ.

The tablet showed a random slideshow of photos, advancing to the next image every 5 minutes with a 10-second cross-fading transition. The only interaction possible with the tablet was to toggle the display off or back on again using a hardware button. A label on the device highlighted the function of the button. If the participants turned the display off, it turned itself on again the following day at noon.

The study was split into two weeks, with half seeing the normal condition in the first week followed by the calm condition in the second week, and the reverse for the remaining participants. Participants were not informed of the differences between calm and normal conditions, nor that there would be two different weeks of conditions (until the second week).

The normal condition mimicked the measured behaviour of an existing off-the-shelf device – switching between 24% brightness and 40% brightness level based on static ambient light intensity thresholds.

For privacy, the display was not connected to any network, all cameras and LED lights on the hardware were covered with opaque tape and disabled in the software. By replacing the Windows shell on the device with the study software, and by showing messages on the device if the mains power was ever unplugged or the sensor was unplugged, it was ensured that the participants were unable to use the device for any other purpose, and that the device was operating properly.

Two different types of tablet PC hardware were used, the high-end Fujitsu one as introduced in 3.4.1 and a low-end Linx 1010 tablet with 10.1" IPS display and resolution of 1280 × 800 pixels. The types of tablets were balanced amongst the conditions. Participants were assigned their device randomly.

Twelve paid participants (aged 21-40 with median 32.5, 5 female) were recruited from a multi-disciplinary research lab in the UK, with the prerequisite of having only one bed in their bedroom. None of them were HCI researchers. 4 (2 female) had used electronic photo displays in the past.

The study design was approved using the ethics committee procedures for Newcastle University.

5.7.2 Data Gathered

During the study, various data was recorded: objective and subjective, qualitative and quantitative. Objectively, the device recorded the ambient lighting conditions and logged when the display was manually turned on or off, so that any difference in peoples' behaviour between the paper-like mode or normal mode could be assessed.

Subjective data were gathered through a mid-study interview before the second condition was experienced and a final interview. In both interviews, the participants were asked to describe the operation of the device that week, allowing us to validate that the study procedure was followed. Questions concerning that week's condition were presented at both the mid-interview and final

interview, while other questions concerning the value of the light-matching display mode and comparing the two conditions were only asked at final interview. The interviews were semi-structured, including both 1-5 Likert scale questions and freeform questions. The specific interview questions asked will be presented in-line with the results in the next section.

I am thankful to James Scott for his help by conducting the mid-interviews.

5.7.3 Results

For two of the participants, the mode of their device was not set correctly for both weeks: one (#11) was meant to have calm mode in the initial week but had calm mode both weeks, while another (#12) was meant to have normal mode in the initial week but had calm mode both weeks. Since #11 and #12 saw the calm mode, their freeform responses concerning the value of this mode were retained, but all their responses and data for analyses comparing the paper-like and normal mode were excluded.

Participants #01-10 all responded to the mid- and final-week interview question about describing the behaviour of the system during each week, reporting no significant issues with the operation of the device (e.g. no device was powered down at any point). The software log files also confirm the device was operating correctly, which gives confidence to the resulting data.

Participants were also asked which nights the bedroom was unoccupied and six nights from the results were excluded as a result. One participant started the study one day late. The overall participation schedule can be reviewed in Figure 5.17.

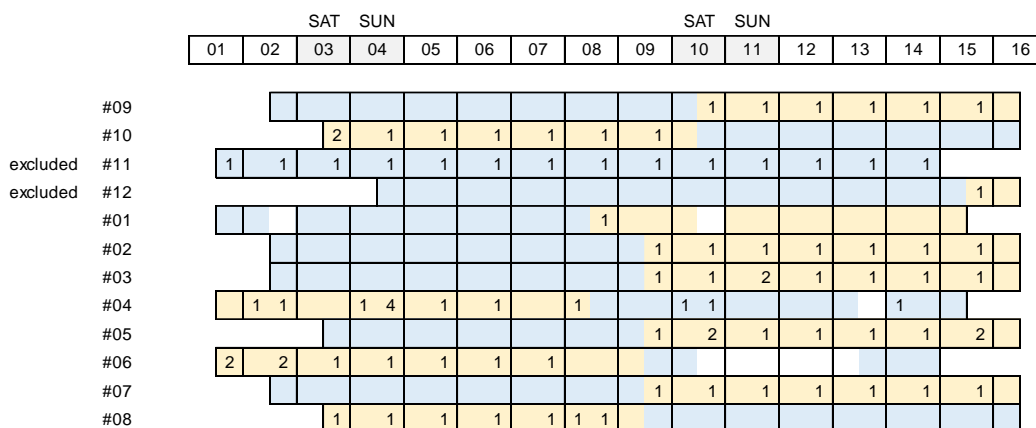

Figure 5.17. Paper-like field study overview. Dark = paper-like mode, light = normal mode, white = excluded as per participant reports. Numbers indicate the number of times participants turned the display manually off in the morning and at night (left and right of a day slot, respectively).

5.7.3.1 Observed behaviour

Logs from the devices confirmed that on 59 nights out of 68 (87%), participants turned the normal display off overnight. In contrast, there was only single night out of 63 (2%) on which the calm display was manually turned off (see Figure 5.18 for per-participant data). This observed behaviour in a real-world deployment is very encouraging for the potential for calm displays in ubiquitous computing scenarios.

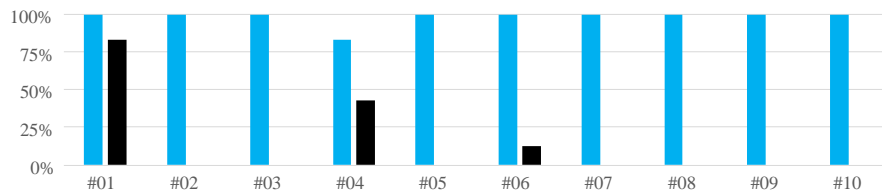

Figure 5.18. Percent of the nights on which individual participants kept the display on (blue = paper-like mode, black = normal mode).

It is hard to overlook participant #11, who was seemingly conveniently excluded on the grounds of not having experienced both conditions, and who turned off the display every night despite it being in paper-like mode. The reason for this behaviour transpired during the final interview, in which they described their routine as turning the display off first and then the lights in the room. Since participants were not briefed on purpose of the study or the new display behaviour, they just expected the display to be distracting based on their previous experience with emissive displays and turned it off as preventative measure before going to sleep.

5.7.3.2 Distraction

We asked participants how distracting they found the display on a scale from 1 (not distracting) to 5 (very distracting). 6 out of 10 participants marked the normal display as distracting (i.e. scoring it 4 or 5), while none marked the calm display as distracting, see Figure 5.19. Fisher's 2x3 exact test [180] shows a statistically significant difference in the perceived distraction ($p = 0.005$).

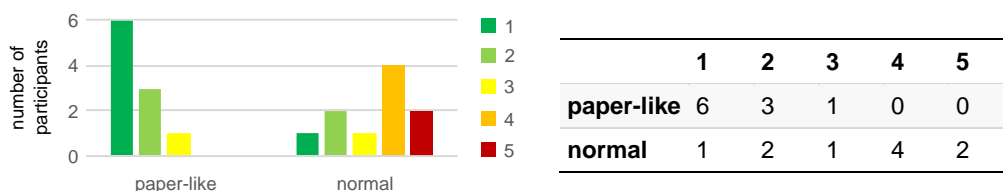

Figure 5.19. Was the display distracting? (1 = not distracting, 5 = very distracting)

During the interviews, six participants described the normal display as “too bright”, in spite of the fact that it was never above 40% of its maximum brightness. Five participants explicitly

commented on the non-distracting nature of the calm setting. Participants noted that the display was “unobtrusive” (#07) and “blends in with the rest of the room” (#01).

5.7.3.3 Visibility of content

Since the paper-like display aggressively controls the brightness and chromaticity through gamma settings, one of the questions is whether that has any significant effect on the ability for participants to see the content on the display. Participants were asked whether they were able to see the content when they glanced at the display, ranking from 1 (very difficult to see the content) to 5 (very easy to see the content). The results are shown in Figure 5.20.

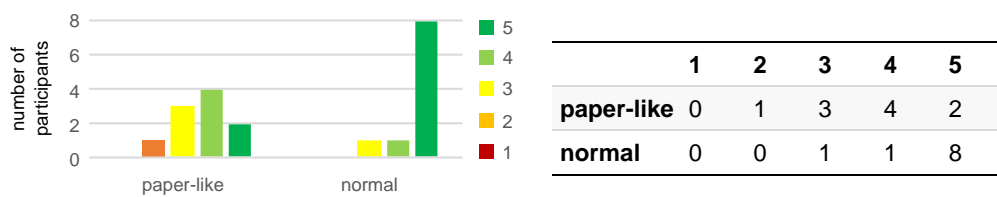

Figure 5.20. Were you able to see the content when you glanced at it? (1 = very difficult to see, 5 = very easy to see)

Fisher’s exact test doesn’t show a statistically significant difference in content visibility ($p = 0.303$). It is expected that the content on a normal display would be perceived as easier to see and indeed, within-subject comparison confirmed this expectation, as shown in Fig. 16.

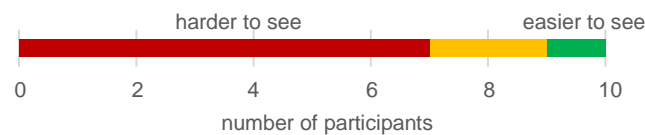

Figure 5.21. Within-subjects content visibility scoring of paper-like display compared to normal display.

Half of the participants stated to various degrees that the image on the calm display was perhaps too dim, but all of these participants had the lower-end tablet, which has a worse viewing angle.

“Content during the day is quite easy to see, but during the evening it was a bit more difficult.”
#04

In addition to the subjective reports, a more objective way of assessing whether participants could see the content – a recollection test – was used. The photos shown on the display were 10 pictures of flowers and fruits for the first week and 10 pictures of landscapes and trees for the second week, downloaded from public collection of wallpapers⁷³ (see Figure 5.22 for examples).

⁷³ <http://support.microsoft.com/help/13768>

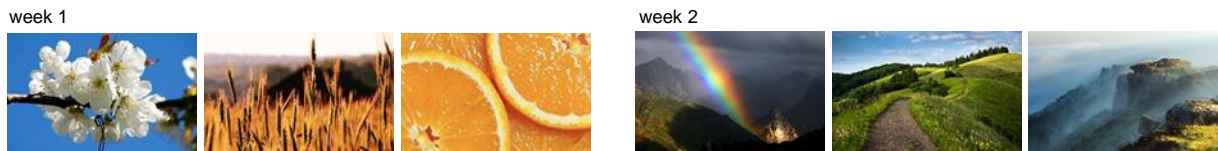

Figure 5.22. Examples of images used during the study

During the interview after first week, participants were presented a sheet containing 30 photos of fruits and flowers (10 of which were shown on their display during that week) and asked them to mark the ones they remember seeing. Similar test was performed after the second week, presenting a set of 30 pictures of landscapes and trees, of which the display had been showing 10.

Results from the recollection test are summarized in Table 5.2. No significant difference in the recollection performance between the normal display and calm display conditions has been found.

| | correctly | incorrectly |
|---------------------------|-----------|-------------|
| paper-like display | 3.4 | 1.0 |
| normal display | 3.2 | 1.2 |

Table 5.2. Average number of pictures remembered.

5.8 Bedroom Environment

Deploying to bedrooms also gives us an interesting opportunity to explore typical lighting conditions in this environment.

5.8.1 Lighting Data

The light levels of a typical day in a bedroom are shown in Figure 5.23.

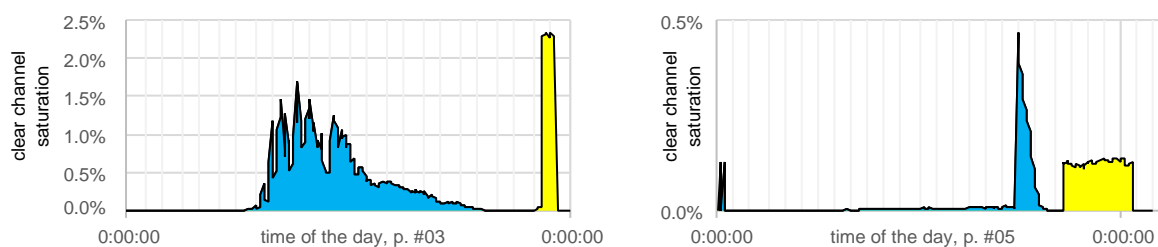

Figure 5.23. The light level during a typical 24-hour period in two different participants' bedrooms; blue shows daylight and yellow indoor lighting. The vertical axis is absolute sensor saturation, note that the left scale is 5× the right scale.

Note that on the left part of the figure, the amount of light coming from the indoor lighting is larger than the amount of light coming from outside, but it is vice versa for the participant on the right. The sudden appearance of daylight is most likely caused by opening curtains in the evening. During the initial interview, all but one participant reported that they sleep with curtains closed.

The overall distribution of illuminance values measured during the study is shown in Figure 5.24. The data were values in lux were computed based on a formula in the sensor’s application note [111].

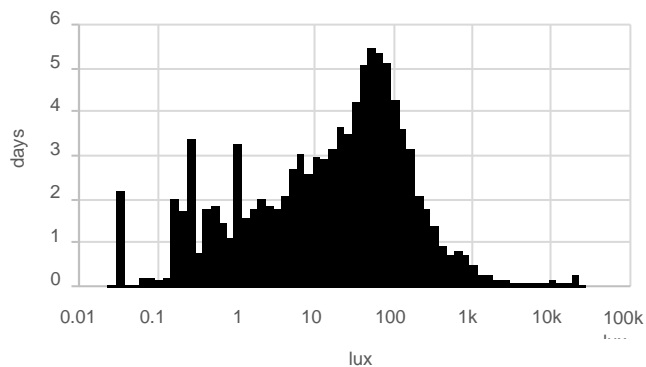

Figure 5.24. Distribution of illuminance values measured.

The sensor read zero illuminance for 86% of the time (not shown in the figure). These values indicate that the environment is often very dark. During the paper-like condition, the high-end tablet used negative brightness for 65% of the time, the low-end tablet for 50% of the time, which indicates it is an important feature of the system.

“[The light level] is the key thing if you want to put [a display] in your bedroom.” #05

As for the chromaticity, none of the participants had any coloured lighting in their bedrooms. All the algorithm results applied during the study are plotted in Figure 5.25 (each participant shown in different colour). The black line is the Planckian locus, denoting the chromaticity of a black body as its temperature changes from 1000K to 40,000K (see 2.1.1 for background).

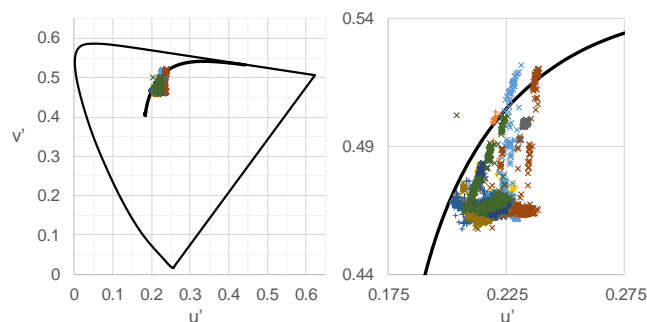

Figure 5.25. Applied chromaticity results.

Even though in this study participants’ conditions did not entail any extremities in terms of chromaticity, one participant noticed and highlighted the importance of chromaticity adjustments.

"It's very good at adjusting between the white light that comes out of the ceiling light and the creamy orangey light from the bedside light." #12

5.8.2 Appropriateness of Displays

The participants were asked whether they thought that the light-matching display mode was more appropriate for use in bedrooms, from 1 (much less appropriate) to 5 (much more appropriate). 8 out of 10 participants said it is more or much more appropriate, see Figure 5.26. Note that the word "calm" was not mentioned to the participants.

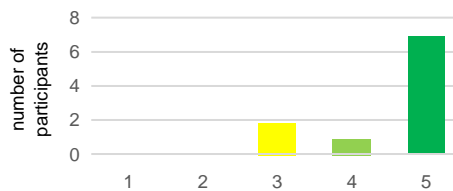

Figure 5.26. Are calm displays more appropriate for bedroom use? (1 = much less appropriate, 5 = much more appropriate)

Participants were also asked whether they would like to have a display like the one used during the study in their bedroom long-term, from 1 (definitely not) to 5 (definitely yes), provided they could customize its appearance to their liking and that the display was affordable. The distribution of answers can be seen in Figure 5.27, and the within-subject comparison in Figure 5.28. Fisher's exact test doesn't show a statistically significant difference in the preference of having such display in a bedroom ($p = 0.523$).

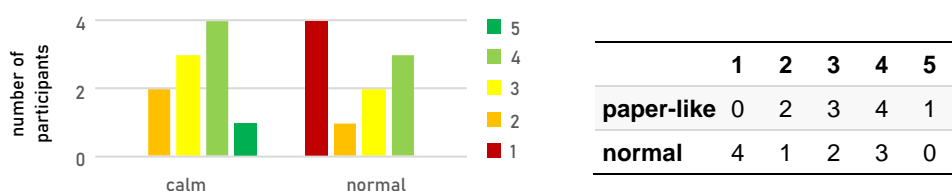

Figure 5.27. Would you want a display like this in your bedroom long-term? (1 = definitely not, 5 = definitely yes)

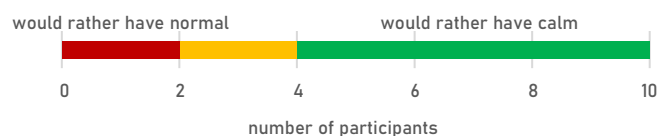

Figure 5.28. Within-subjects' scoring on the desirability of having paper-like vs normal display in their bedroom.

5.8.3 Types of Content

All but one participant said that personal photos would definitely be their choice of content, and 9 participants ranked photos as the most important of the content they were considering. This is perhaps not surprising given the resemblance of the prototype to a digital picture frame, yet there is a special value seeing them during bedtime, which the paper-like display enables.

“When I was younger I never really saw the value in photographs. Now with the family and with more to look back on, it’s nice to see something that triggers a positive memory, even if just fleeting. Nice to wake up to, or to see just before you go to sleep. To start the day in a positive way or to finish on a high note at the end of the day.” #02

We will focus on the value of bedtime in Chapter 6, where waking up to a content of personal significance resonates with other participants.

Two participants preferred different content over photos – a to-do list, a calendar (#03), appointments and weather (#01). The complete list of content suggestions is summarized in Table 5.3.

| participants | content |
|--------------|--|
| 11 | photos |
| 4 | weather |
| 3 | calendar/appointments/schedule |
| 2 | social (FB, Twitter, Instagram) |
| each once | to-do list, time, BBC news, audio control, quotes & tips |

Table 5.3. Display content suggested by 12 participants.

This table reflects uses that participants came up with themselves. Additionally, the participants who only specified photos were asked whether weather and time would be useful. Only one participant acknowledged time as useful; another dismissed it as something that they are using their phone for; four participants acknowledged that weather would be useful.

5.8.4 Other Environments

When asked if they can think of any other environment where our system would make displays more appropriate, 7 participants said that the algorithm can and should be used on displays anywhere in the home, whereas 4 participants suggested just the living room.

I’d probably use it anywhere. I think it is nice to just have something that adjusts to [the light] – I’d have something like that in my lounge, because I have different types of lighting within my lounge, I don’t think it’s just bedroom only. Personally I think it could work anywhere. #12

The television use case was a popular example among living room suggestions.

If you were watching TV at light night, if you were watching film, you wouldn’t necessarily want really brightly lit photo display on at the same time. #01

If I was in the living room, watching something on the television and I dimmed the lights, it would be useful if it dimmed as well. #03

5.9 Discussion

Although the participants were not told that our algorithm was designed to mimic a reflective surface, two participants in the field study compared it to a printed picture and one to the walls.

"The screen was the same brightness as the walls, which was pretty impressive, I didn't know you can make the screen that dim." #10

"It's a nice ambient thing, like a regular picture in a way – you don't notice that it's there unless you are looking for it." #02

5.9.1 Building Calm Devices

The results of the evaluation suggest that displays that are responsive to ambient lighting are less distracting and more environmentally appropriate. These results are encouraging for researchers and designers of ambient information systems since it implies that devices with high-resolution emissive LCD displays, which are in widespread use, can be used in "calm" applications. This is an interesting development since designers have previously argued against the use of these displays due to their attention-grabbing nature [181].

However, our findings also suggest that matching ambient illumination alone may not be enough for creating a calm device. Ambient illumination matching only provides a way for information to fade into the periphery. Calm technologies also need to provide a way for information to easily return to the centre of attention. An example of this problem manifesting itself was when one of the participants commented that the "calm" display condition had decreased visibility, which they found distracting. Consequently, future work in calm devices will need to investigate lightweight mechanisms to bring information back into focus.

5.9.2 Limitations

There are two aspects to successful ambient displays. One is the willingness of users to have them on and active, and the other one is the ability of this display to provide useful information. This study has addressed the willingness part by showing that displays can effectively blend into the background. A prospective feedback has been also gathered from participants through their actions and opinions that they would find it compelling to use calm displays to show information. However, the large space of the various types of information to display is yet to be explored and the various scenarios that displays can be — within the bedroom, the home, and other environments as well, and there is rich future work to do in this space, drawing on the existing literature in the area of ambient displays [7, 150, 154, 182, 183, 184].

Nonetheless, this work provides an important foundational step for calm displays and enables future work towards that goal.

5.9.3 Recommendations to Device Manufacturers

Current manufacturers' decisions and practices impede the aims of the paper-like display algorithm. In order to take full advantage of the technology, a few changes are suggested to their approach:

1. Displays should be able to gradually reach zero backlight levels or equivalent brightness for display technologies without backlight, so that the display can match very dark environments.
(Section 5.8.1 shows that light levels in the bedroom environment are close to zero, and section 5.7.3.1 shows that displays can be present in such environments if and only if they are able to match these levels.)
2. Changing brightness/backlight levels should be instantaneous, without any slow, fading transitions. The algorithm needs to be able to change levels in real time in order to mimic reflective surface responses.
(Further work needs to be done to show what is the maximum acceptable delay for the display to react for human observers not to notice it.)
3. Published display specification should include colorimetry data, most importantly primary colour coordinates including luminance and absolute brightness levels. Ideally, these should be readable electronically from the hardware.
(The primary coordinates are required in section 5.4.1 and need to be estimated using a calibration procedure described in 5.3.2 section 5.3.2 if not provided).
4. Backlight/brightness should be settable in absolute units, such as cd/m^2 . Displays especially designed to work in the paper-like mode might choose to allow setting the white point anywhere within the colour gamut using absolute coordinates.
(The brightness characteristics is required in section 5.4.2 and need to be estimated using a calibration procedure described in section 5.3.1 if not provided).

Points 1-2 are critical for paper-like displays, while points 3-4 would allow hardware agnostic operation of the algorithm without any end-user calibration required.

5.10 Summary

In this chapter we have introduced and evaluated an algorithm for paper-like displays, which, using commodity RGB sensors, can make both existing and new display panels mimic reflective surfaces in the way they react to the lighting in the environment by aggressively controlling the display's backlight and gamma tables, effectively moving displays into the background and periphery of attention. Colorimetry evaluation in the lab environment showed that the algorithm is capable of reaching thresholds of human ability to discriminate colours in non-standard lighting conditions as determined in the previous chapter. Moreover, both quantitative and qualitative results from a field study were presented, both indicating that paper-like displays are less obtrusive than regular displays while providing nearly as much utility.

Eight out of ten participants said that paper-like displays are more appropriate for use in bedrooms compared to existing displays (the other two were neutral), and this work provides direct evidence about the distracting and inappropriate nature of current display technology for ubiquitous deployments. Yet, the research community has chosen not to look for means of improving the way we co-exist with displays in our environment; rather, displays are being excluded from designs where unobtrusiveness is critical. I am convinced that paper-like displays can bring us closer to the vision of calm technology without sacrificing the rich interaction and visualization possibilities of emissive displays.

Chapter 6. Bedtime Window: Connecting Bedrooms of Long-Distance Couples⁷⁴

In the previous chapters we have designed and evaluated a paper-like display algorithm that is capable of keeping common emissive displays unobtrusively in the background. To demonstrate that such display technology has real-world practical applications and opens new areas of research in HCI, let us leverage the bedroom environment we have tested the technology in, and build an application that brings value to people in such an intimate space. Furthermore, we expect calm technology to move, by definition, seamlessly between foreground and background, but we haven't yet explored when should such transition happen.

Since I have been in a long-distance relationship (LDR) for several years, I have used the paper-like display to design a system for remote couples to share bedtime, a time and space collocated couples normally share together. While the background mode is not a main subject of this study, it is a critical aspect of the system without which deployment to peoples' bedrooms wouldn't be possible in the first place.

The system, called Bedtime Window (BW), is a complex system featuring various means of communication and interaction. It features slow photo stream, real-time, disappearing inking on a shared surface, paper-like adaptation to either local or remote location and light timeline (see Figure 6.1 for illustration).

⁷⁴ The field study in this chapter has been published in [289]. A demo of the system including a video of the features was published in [289].

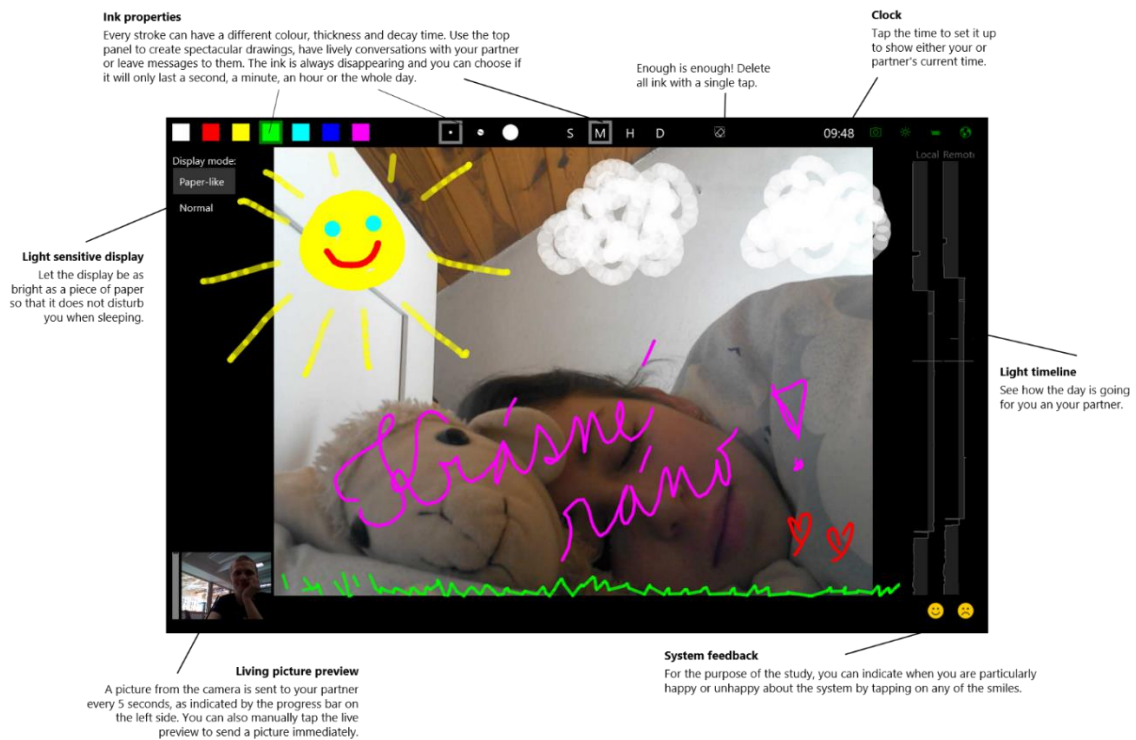

Figure 6.1. Overview of Bedtime Window as presented during recruiting participants.

In this chapter, the most relevant existing work related to the individual aspects of the system is presented (6.1), followed by a description of an autobiographical design of the system, summarizing the iterative co-design process and its long-term evaluation (6.2) and finally, learnings from a field study when the BW was deployed into bedrooms of geographically separated couples for a period of 4 weeks (6.3).

6.1 Related Work

6.1.1 Long-Distance Relationships

LDR is a fairly common form of a relationship – many individuals have been in a LDR at least once (75% in USA in 2017 [185], 54% in Germany in 2014 [186]) and the number is still increasing [187], which is attributable to the continual advancement of travel and communication technologies [188], as well as job market and globalization forces [187]. Despite popular beliefs, partners in LDR can be as satisfied as partners in normal relationships, if properly maintained [189]. Canary & Stafford define relational maintenance behaviour as actions and activities used to sustain desired relational definitions and suggest that sharing activities play important role in maintaining relationships [190].

Many prototypes and designs for relationship maintenance were published in the past, from remote hugging [191, 192], touch [193, 194] or kisses [195, 196], to sharing heart rate [197] or glasses [198, 199], from abstract, multimodal interaction [200] to single bit of communication [201, 202], so

in this section we will focus only on the work sharing similar features or purposes to BW. A lesser known system that shares some aspects with our work is Pictures' Call by Pujol & Umemuro [203]. When movement is detected, the system takes up to 7 pictures at different times of the day at random intervals, and sends them to the remote system, which is continuously showing a slideshow of up to last 20 pictures received. Users cannot see when or what pictures they are sending, but they can delete any in the past 2 hours for which the transfer is delayed, and they can also ink on received pictures and send them back. The system is supporting all 8 principles of productive love the authors propose – giving, care, responsibility, respect, realistic knowledge, enjoyment, freedom and self-growth. Participants from 6 families found the device enjoyable, but with no effect on their productive love qualities, attributed to the short duration of the deployment (2 weeks). BW is a different system supporting the same principles in the same way.

6.1.1.1 Video chat

Neustaedter et al. have done extensive work with LDR. In [204, 205], Neustaedter & Greenberg interviewed 14 participants in LDR to understand how they make use of video chat systems to maintain their relationships. Participants most often used Skype or Google Chat to video chat. They wanted to see each other, engaged in both parallel and shared activities while being connected, as well as shared more intimate acts. Authors argue for designs that support shared sense of presence between partners as means of supporting and maintaining LDRs, and suggest that researchers consider other mediums in addition to video to provide a rich experience that allows partners to feel like they are part of each other's life. [205] BW is an example of such design, with not only inking providing the rich experience but also offering an alternative to the video channel connection.

Baishya explored a video and audio streaming system for couples that allowed them to call each other anywhere anytime [206]. Partners were asked to place a smartphone into their shirt pocket, camera facing outwards, so rather than the traditional set-up where users can see each other, they would see what their partner see. The phone was running Skype in auto-answer mode. Her participants found value in seeing everyday mundane activities of the other partner, but it also reduced the number of topics for them to talk about in their nightly calls, which neither of them liked. The study raised questions around how one might think to design video communication systems that still place value in the creation of special moments.

Video chat was seen as more challenging to initiate a connection with than other technologies [205], and video communication systems have long been described as difficult to use where it is challenging to maintain a connection long term [206]. I've tried to address these challenges by sharing slow photo stream rather than a real-time video connection, automatic connection recovery and buffering important undelivered data.

6.1.1.2 Always-On channels

Always on or at least always available media spaces have been studied for decades in the context of work environment and sharing workspaces [207], summarized by Harrison et al. [208]. Pang et al. looked into creating an always-on channel between workspace and personal space [209]. They conducted an online survey of hypothetical usage scenarios, asking how many people would use an always-on channel that way, and created an iOS app – Perch – that shared video with other locations, including audio whenever a face was detected on the camera. Of particular interest to our work is the Scenario 6 of long-distance couples, describing a person connecting to his partner in their bedroom before bed while he was away traveling and at hotel. 51% of participants said they would or maybe would use the system in such scenario, while the rest would not. Authors noted that those who would had been in such life situation themselves before and privacy concern is usually not such a worry, as the involved parties are in a close relationship. From the field study of the app with five participants, one participant was in LDR and under what-if unlimited resources scenario she indicated she would put a dedicated device in her bedroom, although authors don't delve into the bedroom environment. One of the main results and reasons for lack of adoption of the technology was the lack of dedicated devices. In the BW field study, dedicated devices are deployed to couples' bedroom to overcome this limitation and pursue this usage scenario to learn more about how technology could be used to share this time and space between partners in LDR.

Moving away from other work involving work-place, substantial research went into connecting homes and families, across generations [210, 211, 212], living apart [213, 214], summarized in the book *Connecting Families* [215]. Kirk et al. interviewed participants about their video communication practices at home [216]. Some of them talked about 'open connections' where they would leave a video call for an extended period of time. One such participant was a partner in LDR who indicated turning the audio off, spending the evening together without the pressure to chat. The lack of sound removes the requirement to make a conversation while still allowing to share gestures of presence like waving at each other. Authors also enquired about what 'feeling closer'

means to participants when they claimed that video calls made them feel closer compared to phone calls. Explanations relevant to the couple scenario were to know that somebody is there, to partake of routine, allowing oneself to be seen, and to show dedication. Notably, authors note that bedtime is somewhat ritualized activity in most homes, and the technology enabled a dislocated couple to continue these routines together. Our work follows up on these learnings: The BW, also without audio, specifically targets these bedtime rituals, learning about the values in sharing them, and to what extent can adding an inking channel disrupt the freedom from conversation obligations.

Family Window

Judge et al. designed, also through autobiographical design, the Family Window (FW) to connect parts of families living separately [217]. This work was later extended to more than two connected homes through Family Portals [218], and to multiple cameras and/or displays [219]. All these systems, including Perch, are summarized in [220]. The FW, offering video and ink messages is the closest system to ours, albeit targeting a slightly different environment and users.

The FW was designed to connect separate parts of families, such as grandparents with their children and grandchildren using always-on video. In both cases, the first iteration focused on exchanging visual image of the two connected places, including small preview of local video in the bottom left corner. FW was aiming for highest framerate technically achievable, which ended up being around ~2-3 frames per second [220] with an option to blur the video for privacy reasons. Users could also turn off or on their cameras separately. In BW, the framerate was deliberately set to 0.2 fps to address privacy concerns, but there wasn't any need for turning the cameras off, perhaps due to connecting one separated home rather than bridging two independent households. Both systems ruled out audio link for privacy reasons at early stage of the design.

Interestingly, both systems realized that there needs to be a mechanism to draw attention of the other side. FW went with an ephemeral knocking sound, while BW was looking for vibrating the remote device since both users were familiar with that concept from previous communication practice. For an always-on device located in bedroom, audio was not even considered as an option. The role of attention grabbing for BW was eventually fulfilled through inking.

FW implemented handwritten messages as a last resort for sharing short bits of communication when other methods turned out to be not technically possible, and a notification appears on the remote device when new writing is received. Users could pick any ink colour, write or erase mode,

and a preview of the ink on the remote display is shown in the local video preview. On the other hand, the inking in BW has become the central communication feature of the system and one of the distance bridging stones in a relationship. The ink is always disappearing to support active exchange of messages and natural communication flow. Users have predefined set of colours, thicknesses and ink durations, but cannot erase except for clearing the whole canvas (to keep the implementation and user interface simple). There is no ink on the local video preview (otherwise remote users would be able to cover the whole preview).

Although not the same, both systems have implemented a form of timeline. For FW, it was an activity timeline visualizing the difference between video frames in order to let users know about each other's activities. It covered current and previous day and also worked as a user interface to cue video replay. For BW, it was a light timeline, intended for visualizing each other's day and night, especially for partners in different time zones. Cyclically covering last 24 hours, it was the only element of BW that displayed non-real-time data.

The functionality where these two systems differ is related to their intended usage. FW has time shift recording, allowing users to record and later replay events they have missed. BW is focusing on the paper-like background mode required in bedrooms and exploring the light as a communication channel.

It is remarkable that two independent systems for connecting different aspects of home, going through long-term autobiographical design in different countries arrive to a set of common concepts: sharing visual images of the place, ink drawing, timeline, and means to grab attention. It appears that this set of features constitutes a core functionality for always-on displays connecting homes.

6.1.1.3 Bedrooms & night

HCI research in the bedroom environment is still very sparse, although it seems to be getting some traction. Wan prototyped a situated shopping experience from bedroom [221], which, however, is only connected to bedroom by the presence of a wardrobe in the room. Odom looked at virtual possessions in the context of teen bedrooms [222], creating an illusion of several independent screens by using a digital projector. While they expected the teens to find the display invasive and overwhelming, they had nearly positive reactions only, and they identify an opportunity to rethink the bedroom in terms of digital displays and new interaction methods, as well as creating more integrated and artful display systems.

In the context of relationships, Dodge presents the bed as a medium for intimate communications in as early as 1997 [223], communicating body warmth, heartbeat, breath and audio levels through pillows and colour shadows projected on curtains. A different approach was taken by Goodman & Misilim [224], turning the bed itself into an ambient display read through the skin, transferring remote pressure into heat, concluding the bed can only be comforting when supported by more active communication methods. Scherini et al. used remotely warmed pillows (Somnia) and a necklace to indicate to the other partner that one has gone to sleep [225]. Authors found that feeling connected to loved ones just before going to sleep is important in determining sleep behaviour. Participants however indicated that more elaborated interaction including exchanging drawings might increase connection and experience of co-presence. Couples felt encouraged to go to sleep at the same time but were unable to adapt to each other due to external circumstances. Gooch & Watts designed sleepyWhispers where partners could record and play audio messages using pillows. The partners using this system found themselves sending mostly “silly messages” that were not worth keeping. They also indicated that live communication was preferred over recording and listening to messages. Kim et al. designed BuddyClock for sharing sleep status (awake, snoozing, asleep) as a form of general wellness awareness and encourage healthier sleep behaviors [226]. All participants felt that knowledge of other’s sleeping patterns made them feel more intimate and think about others. To some it felt like they were sleeping in the same room, with one participant suggesting a simply note function to leave a message to other while they were asleep.

Recently, Salmela et al. investigated how co-located couples use mobile technology in bed using interviews and online survey [227]. It is clear that the same technology that allows remote couples to stay connected, feel close and mediate intimacy during bedtime is treated very differently, often negatively, when the couple shares one bed. Some of the findings, however, are applicable to both scenarios. Authors identified three stages of proliferation of technology in bedrooms: sanctuary, where technology is often, but not always, not allowed; site for entertainment, providing prolonged shared bedtime for watching things together; and site for excessive phone use, bordering with addiction and source of tensions in the relationship. In the context of the BW study, it is also interesting to note the strategies the partners took to avoid disturbing each other. Around 39% of respondents indicated avoiding noise and 25% dimming the screens, of which 16% specifically mentioned night mode or avoiding blue light (based on the data authors supplied).

The BW is building upon findings and suggestions from these works, from adding rich ephemeral interaction to sharing bedtime and sleep awareness to paper-like display with no audio, providing some insights on the usage of technology in bedrooms of separated couples.

6.1.1.4 Privacy

According to survey of private moments in the home by Choe et al., bedroom is the most frequently mentioned place where people do activities they don't want to be recorded [228].

Hindus et al. found even a simple presence light based on remote activity to be perceived as a surveillance device that threatened home privacy whilst conveying minimal level of information.

However, as Neustaedter et al. stated [229], video use in homes cannot be stopped, we can only identify and try to resolve the related problems. Boyle and Greenberg presented some privacy learnings from video media space analysis and defined the corresponding vocabulary [230].

Previous research into always-on video media spaces in homes has also found the transmission of audio to be more privacy-invasive than video [231].

For video streams, various approaches have been put in place to provide some level of privacy to users. This includes image processing filters such as pixelization or blur [230] and mechanical metaphors such as blinds or curtains overlays [217]. In the case of FW, Judge et al. reports that these filters were only used in the first week of the study, none of the families used them afterwards. Moreover, running FW on a laptop or desktop computer rather than a dedicated display proved another source of privacy concern, since normal computer use was misinterpreted as staring in the remote location.

In BW, a slow photo stream has been employed instead of a live video in an attempt to balance the privacy and sense of remote presence. Users can also see when photo is about to be taken and plan accordingly.

6.1.2 Inking

Vast amount of research has been devoted to ink input in the work environment, especially for document annotation and review, much of which has been summarized in a survey paper by Sutherland et al. [232]. Motivation for inking and comparing analog and digital pen affordances can be found in [233], with 41% of people reporting three or more analog pen activities daily.

Inking with appearing strokes has also been utilized in digital chalkboards (e.g. [234]) and educational YouTube videos, as well as several commercial messaging applications (e.g. MSN Messenger, Apple's Digital Touch).

6.1.2.1 Homes

In the context of homes, one of the early ink designs was explored within the Casablanca project by Hindus et al. [235]. Authors presented learnings from CommuteBoard, their most successful system, used for ride sharing arrangements. Users wrote into a shared window that was automatically cleared every morning, using a separate Wacom tablet for pen input. The ephemerality combined with colored ink supported playfulness and informality enjoyed by users and simple expressive interactions such as handwriting proved to be surprisingly effective in homes, while the issues of legibility and limited writing space were identified to be resolved. Consumers were, among others, interested in social communication devices that kept users in touch with loved ones, were fun to use and simple to operate.

Sellen et al. presented a field study with HomeNote, a situated device that displays either received text messages or locally drawn scribbles (using a stylus input) [236]. All households ended up using it for handwritten messages more than text messages, and the resulting playfulness, as well as increased diversity in type of messages, was attributed to the ability to scribble. The most popular type of message were expressions of affection, which in case of one of the households included regular “good morning” and “welcome home” messages. As with relationships, the dynamics of households proved to vary significantly, and the system was useful only for some of them.

Similarly, Lindley et al. designed Wayve, a situated messaging device for families and friends that allowed exchanging mixed content including photos and ink messages between devices, through SMS/MMS and e-mail channels [237]. Received messages could be inked upon and sent back or forwarded to someone else – an interaction, that would often span several days. Like in previous case, inking engendered playfulness (39% of total messages were categorized as playful), either in messages, drawings, photo annotations or in the form of games, such as ‘noughts and crosses’ or ‘hangman’. Play was found to be a fundamental feature of social relationships.

Finally, the learnings from handwritten messaging in FW and Family Portals are discussed by Judge et al. in [238]. Despite not targeting bedtime, the most common messages were greetings between families such as ‘good morning’ or ‘good night’. Participants highlighted coming home or waking up to a message from their relatives, and the option to see the other person while communicating with them was highly valued – to the extent that family members were reluctant to ink on video stream since that would prevent them from seeing each other. The sample data

also hint abbreviating commonly used phrases (eg. *Ckn nug* [*chicken nuggets*], *M&D* [*Mum and Dad*]) in ink messages.

The BW picks up on these hints of values in handwriting for close relationships, recurring reports of bedtime context usage and desire for conversations through ink and focuses the inking experience to partners in LDR and bedroom environment.

6.1.2.2 Collaborative drawing

The first collaborative drawing interface involving visual stream was VideoDraw developed by Tang et Minneman in 1990 [239, 240], and soon after ClearBoard iterations by Ishii et al. [241, 242, 243], in the very nature of FW and BW. In VideoDraw, a pair of interconnected CRT displays captured by video cameras, users drew using whiteboard markers directly on the screen surface. The screens and cameras used polarizing filters to avoid the received video to be captured and transmitted back. Consequently, each conversation participant has its own ink layer that cannot be affected by their partner, and their faces are not part of the projected video stream (face-to-face channel was available on a separate screen). ClearBoard vocalizes this as ‘talking through and drawing on a transparent glass window’ metaphor, adding a video stream behind the ink layer for eye contact. ClearBoard-2 switched from drawing on the screen surface to the input from digitizer rendered using TeamPaint, however, the separated ink layers have been preserved. Both systems have been developed to support collaboration in a work environment.

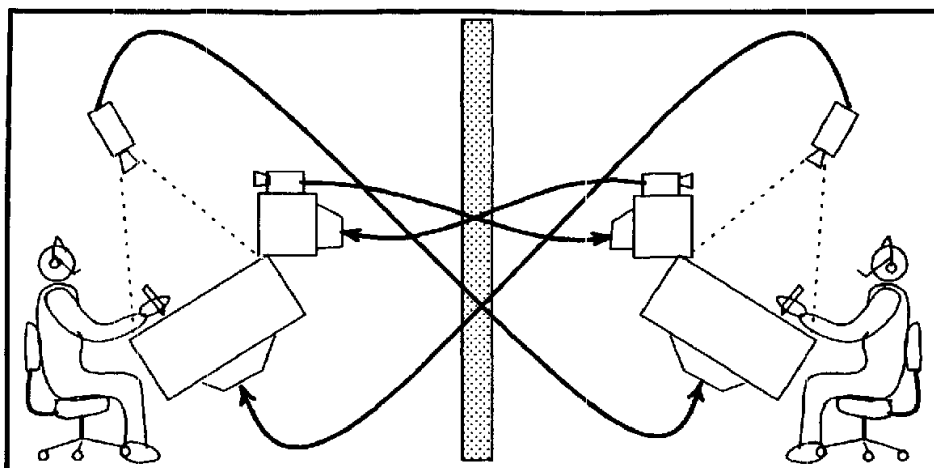

Figure 6.2. First collaborative drawing interfaces overlaying a video.
 Top: VideoDraw schematic diagram (Reprinted from CHI' 90 Proceedings [239]).
 Bottom: Ishii's ClearBoard-2 in use (Reprinted from Communications of the ACM, 1994 [244]).

The use of projectors and camera have continued, both DigitalDesk [245] and PlayTogether [246] explored collaborative drawing when one each participant was drawing on a paper having the remote drawing superimposed, again keeping the inking layers separate. Miwa experimented with shadow communication that also enabled collaborative drawing (through hot pen tip and thermal cameras) [247], which was a shared ink space, however, the achieved precision was not conducive of fine text writing. Both FW and Family Portals offered shared ink space(s), but inking was not the main purpose or originally planned feature of the system [217]. The systems assumed messaging-like ink interaction, for example, a notification is shown when new ink message is received, and user has to indicate their desire to ink. In BW, I have put inking in the centre of the user experience, with one shared ink layer and various brush features. Realtime ink delivery is prioritized and guaranteed.

6.1.2.3 Disappearing

Snapchat, a mobile phone application that lets users send photos (including ink annotated) that will be automatically deleted in 1-10 seconds after opening has become the third most popular social network in 2015 [248]. Followed by Snapchat Stories, Instagram Stories, WhatsApp Stories and YouTube Stories that allow users to consume content for one or more days before it disappears, ephemerality has become intrinsic part of the popular culture. Users reported ease of sharing mundane events valuable for relationship maintenance but not worth keeping and increased creativity in messages [248].

To my knowledge, there is no prior academic work involving digital disappearing ink. OneNote software has a pen as pointer functionality, which allows collaborating users to draw attention to something in the notebook using ink which suddenly disappears after couple of seconds. The closest to my implementation is the Waterlight Graffiti artwork by Antonin Fourneau [249], where users can paint with water on a display composed of thousands of LEDs. The more water the brighter light the LEDs produce; consequently, as the water evaporates, the light strokes slowly disappear.

Ephemerality is usually highlighted as a fundamental feature of being human [250], allowing users to use technologies without fear of later consequences. However, it can also have practical function as is the case of BW, where continuously disappearing ink is used to support seamless communication flow within limited space.

6.1.3 ABD as a Research Method

Neustadter & Sengers defined autobiographical design (ABD) as design research drawing on extensive, genuine usage (i.e. based on true needs) by those creating or building system [251]. Arguing that self-usage happens and provides valuable learnings regardless whether documented or not, authors interviewed senior HCI researchers who employed self-use to design systems about the process – rarely mentioned in the final papers – trying to establish ABD as a valid method in the field of HCI. They found that ABD supports fast tinkering, iterative process, produces real systems that work and leads to their long-term evaluation. However, while ABD allows early innovation and reveals big effects, it doesn't automatically provide generalizability and data collection is unusual. Researchers were worried about bias and selfishness. Yet with the current proliferation of technology in society, it is increasingly difficult to learn within a few weeks of field studies, how delicate prototypes are being used, and ABD can help combat this problem [251].

Desjardins & Ball again in 2018 report that researchers rarely share details, challenges and adjustments during ABD of their systems, resulting in the complexities of ABD being still widely unexplored and the method novel [252]. ABD is connected with new questions in HCI, as a method to study intimate, long-term and personal relations between technology and humans. Authors describe tensions in ABD, including questioning the genuine needs, probing design participation, tension between design and research and weighing intimacy, privacy and relationships. Recalling honesty and transparency to be one of the criteria for evaluating autoethnographic research that is difficult to attain in HCI research, they call for more clarity in the ‘origin stories’ of ABD projects in order to establish credibility in the findings, and to report on the design process including decision making, tools and materials to strengthen the contributions for designers and researchers who are interested in building similar systems. While ABD does not have to be a co-design process, acknowledging other actors in the design and describing the feedback helps understanding the decisions made and can help readers to assess the quality and validity of the work [68].

Some of the notable ABD projects relevant to BW and that will be referred to in the text are Gaver’s Video Window, an ambient display situated in his bedroom showing a panoramic view from camera on top of the house [170], Heshmat’s Moments, an always-on recording system for home [231], the already mentioned Family Window [217, 253] and series of designs of Chie [186] for his girlfriend with whom he has been in a LDR. Gaver’s window discusses aesthetics of the content but hasn’t touched upon any aspects of having an emissive display in a bedroom. Heshmat’s idea of glanceable displays in the home is based on previous learnings that families find value in being able to walk by and glance at the content on a display with ease [231]; a quality my participants have also highlighted.

6.2 Autobiographical Design

6.2.1 Origin and Consent

As suggested in the introductory paragraphs, the system has been designed as a part of exploration of new opportunities enabled by background display mode making emissive screens acceptable in spaces such as bedrooms.

For myself being in a LDR and my advisor about to enter one, the advisor suggested trying a situated display device in a bedroom together with the remote partner. In autobiographical design, authors often do not expect the design to become research and lack formalized records of the

process [251]. Fortunately, due to the nature of communication between myself and my partner being predominantly in the form of chat messages, most of the design process has been – although informally – recorded in logs nevertheless. Here is the first time my partner learned about the idea on 6th of December 2016 (chats are translated):

Me: so I met my supervisor today
and he suggested we put the displays besides our beds
Her: who?
Me: me and you
Her: 😊 okay...so you will bring it over here?
Me: 😊 well we must discuss it a bit, don't we? 😊
Her: Why? What? Etc.?
Me: well how is it gonna work, what do we want from it, expect etc.? 😊
Her: Me likely nothing, right? 😊 It's your research 😊

The conversation then carries on trying to explain that this is not another photo frame but something that should help bridge the gap in the LDR and inviting the other partner to participate on the design. The short excerpt above already touches on several important aspects of the autobiographical methodology of couples in home where the partners have different backgrounds and training.

First, the genuine need in the sense Neustaedter and Sengers envisioned is clearly lacking on my partner's side, and while I might have been looking for more calls in the relationship, there is no doubt that the primary motivation of the design here was an exploration of whether there is something that this work could do to support LDRs in general. Nevertheless, we consider the design to be successful, engaging and becoming integral part of who we as partners are. Desjardins and Ball already described how project motivations in ABD are not always based on genuine design needs [252]. Neustaedter and Sengers, however, considered genuine need as a prerequisite to the genuine usage of the system [251]. Genuine need is not a necessary condition of a genuine usage, as others have shown too [252]. Our own experience suggests that it is the genuine usage rather than need that is key to a successful autobiographical design.

Second, the partner did not expect to be in any other role than just helping with research that she did not feel entitled to question or influence. Such imbalance is supported by the fact that the researcher is the one who has the technical knowledge to implement the system. Even though I tried to involve my partner as a co-designer, trying to think out "loud" about the system, she never took on an equal role in the design, possibly due to the combination of insecurity and lack of need.

Instead, the discussion was seen as a lack of trust in the willingness to help, ending with the partner saying “just bring it!”.

An innocent design decision that later turned out to be one of the core features of the system (slow photo stream) has been made together at the very beginning:

Me: the idea is, that we would try it as something to bridge the distance [between us] 😊
Her: But how?
Me: well that’s what we should find out 😊
it can either show something about the other one
or it can be an always-on video
or some fancy decoration
whatever we want it to do we have the opportunity to make it to do 😊
Her: always-on video would likely make me nervous...
Me: exactly
it can be just a picture every now and then
or only when we both agree

Similar to the process of Chien [186], it turned out to be more productive (and less conflicting) to incorporate her feedback on features in more mature stages. Co-designing is a form of incorporating each other’s feedback at a stage where there is nothing to begin with. Interestingly, hint of another forming aspect of the system has been mentioned at this early stage:

Me: how to make a morning greeting when we won’t get up at the same time

Last, but not least, the partner expressed her consent to participate immediately, only on the basis of the trust coming from the relationship, possibly without considering other members of the family, potential effects on the relationship or even knowing what the technology actually does.

I felt the responsibility to make the consent at least somewhat informed, and turned to the existing LDR research in HCI, reporting to my partner some findings from Neustaedter and Greenberg’s INTIMACY IN LDR OVER VIDEO CHAT paper [205]. I enquired about conflicting topics, noting that the partners open up, discuss conflicting topics, and a third of LDRs end within three months of reunion, but it was concluded that we are already over those issues, as well as happy seeing each other right after waking up. Reflecting on this discussion, many of the forming features came up as well, such as no need to talk – just seeing smiles, partners trying to watch videos together or seeing each other falling asleep, including all the problems they experienced with laptops during that activity. Intimacy has been also mentioned. While she didn’t feel like “being in porn movie” the way P4 did in [205] when seen naked during a Skype call, she did reflect on being less comfortable with that than in person.

6.2.2 Autobiographical Set-up

We were both located in Europe, with one hour of time zone difference. I was located in the United Kingdom, alone in a single room with a bed, she was staying in a house with her family. She had her own room mostly used exclusively as a bedroom, although other members of the family would occasionally enter it (e.g. to pass through to another bedroom).

At the time of the design process we have been in a relationship for 13 years, of which the last two have been the longest separation to date. When collocated, we would share the bedroom together. As for communication patterns, we almost exclusively relied on Skype messaging to keep in touch with each other. The conditions were not very conducive of calls, resulting in about 52.9 minutes of calls on average per month in the 6 months prior to the ABD, however, an average of 121 messages daily were exchanged for the same period.

6.2.3 Rapid Prototyping

The system is a software solution running on Microsoft Windows tablet, which has been delivered to my partner before the development has been finished, so the remote partner was in charge of deploying the software and reporting any errors. The first iteration of the system has been ready to try out on 12th of December: based on the initial idea of sharing pictures, the *bed window* would

1. take a picture and upload it to a web server every 5 seconds;
2. download a new picture of the partner from the web server every 5 seconds and show it on the screen;
3. run the background mode algorithm adapting to the light conditions;
4. check for a new version and configuration of the software every hour and self-update if available. It was deemed critical for the software to be remotely updatable to enable quick design iterations without burdening the remote partner.

The first few builds were not successful. My partner had to be trained on how to retrieve error descriptions from the system, finding the most useful information in the callstack and redeploying the software manually. It also proved helpful to agree on the nomenclature of individual system components (such as the external light sensor).

After the first set of photos has been finally exchanged the next day, accompanied with mutual "hellooooo!" chat messages, we quickly realized that the bedroom usage might not be the most effective use of the new exciting system.

Me: let's see in the evening if it's not too dark
Her: I'm in the living room, am I supposed to move it back and forth all the time? 😊😊😊
it's a bit of vehicle 😊
Me: 😊 no, we will keep it in the bedroom
but I might have to start coming home earlier
Her: 😊 why? 😊
I don't spend that much time in my bedroom 😊
Me: well me neither 😊
Her: 😊 then I can keep it in the living room and you in the office

The photos were great fun from the beginning, but because of the implementation details of camera capture, the latency ended up being much higher than the intended 5 seconds and turned out to be unbearable.

Me: I wonder what the delay is
Her: a lot
Me: because I reckon it takes forever before it takes the picture I want
Her: you bet 😊
like it takes it, but before it sends it
Me: well... that's what we cannot see, can we
Her: well, see, I got bored making faces, so I gave up and the picture appeared in about quarter to half a minute

Eventually we established the delay is almost a whole minute. This experience showed four new learnings about the system: First, unlike always-on videos, photos can be playfully staged. Second, there is an upper limit of the interval between photos when the photo stream ceases to be engaging. Third, for this usage the user would benefit from seeing when the picture is actually taken. And fourth, it wasn't clear whether any connectivity issues are responsible for the delays, in other words, the photo stream masks temporary connectivity loss, which is otherwise a very frustrating experience during a video connection.

As a direct result of this feedback, a progress bar has been added to the user interface, periodically going up and once it reaches 100 %, a picture from the camera is taken, so the user knows when the moment of interaction occurs. This is an example of a design change initiated by the remote partner coming from their use of the system. Three days later, an explicit trigger to take and send a picture straight away has been added.

First consequences of connecting two separate spaces also appeared. Accounting for presence in the device vicinity – *“And you are gone again. Are you gone? Where have you gone?”*, finding the right spot for the device and getting distracted:

Me: It's stupid this way that my laptop is on the other side of the desk
Her: Doesn't matter, does it? :) I am not looking into the display all the time either...
Me: sure 😊
Her: should I be doing that? 😊
Me: though I look at myself a lot
Her: me too, cause I want to see what you see 😊
Me: exactly, I think we will leave it next to beds 😊
Her: if you say so 😊

Ways to grab other partner's attention has been discussed, such as vibrating the remote device, akin to the nudge function of Messenger Plus! the partners had previous experience with.

Unfortunately, the hardware manufacturer confirmed there is no way for software to control the device vibrations. As an alternative, the inking has been introduced on 18th of December, about two weeks into the usage, as a way to leave a message. This functionality, requiring complete redesign of how the system operates (moving from HTTP requests to socket level packets), was a surprise for my partner ("*what are these gizmos?*") and it came feature complete, with colours, thicknesses and disappearing ink with pre-set times.

The very next day I woke up to a good morning message scribbled on the display after my partner had left the home.

Her: Good morning! ❤️ that hasn't stayed there, has it? 😊
Me: it has love!
it's so swell love you 😊
Her: Ohhhh 😊

It was clear the device has provided something intimate that messaging could not. Seeing a partner sleeping is an implicit invitation to leave a message for when they wake up, and glancing over a handcrafted drawing from your loved one, first thing in the morning feels much closer than having to explicitly interact with physical device such as mobile phone.

It bears noting that the system at this stage still had serious usability issues. The light sensor and hence background mode had not been working and required a firmware update, the camera stopped working anytime the display turned off for the night, requiring restart, and the software kept randomly crashing due to various bugs. Status icons have been added to quickly recognize which components are or are not working. After the first few system crashes, most of the issues could have been resolved with the help of log files the software produced. The user had to find the file and either interpret it themselves or send it over, for which at one point my partner used a public, 3rd party file sharing, unaware of the fact that the log contains potentially sensitive data

such as the URL address of the latest photo from her bedroom. This prompted an idea to be able to request logs remotely on demand.

Similarly, even though automatic process, checking for software update every hour was hampering rapid design iterations, as was the need to wait for the partner to restart the device to recover it from component failures. Commands to restart the device remotely as well as trigger check for updates remotely have been added.

When device crashes or disconnects, data gets lost, which happened on the first day possible.

Her: By the way, do you still have my drawings on the display?
Me: no love I am very sorry
but since I didn't have internet, I didn't get them 😞
Her: I seeeee, I thought they will appear once you get back online... Sorry 😊
Me: it doesn't
it's not being saved anywhere
I am so sorry

This has been a notable loss. Unlike in messaging where the sender has a copy that they can resend, all the effort of drawing for beloved one is gone without the partner even knowing it existed in the first place, and it's immediately apparent that there isn't any way to recreate it. I have never learned what she made for me. Should this technology be trusted by partners to maintain relationships, it is important that the inking delivery is guaranteed.

6.2.4 Long-term Usage

At this point the system was usable enough to live with it, which we did for about 8 months.

6.2.4.1 Late features

On 13th May, half year after the first run of the system, the ability to exit the background mode of the display has been implemented. Users could now choose whether the display should be a) always bright, b) always dark, c) paper-like according to the local sensor, or d) paper-like according to the remote sensor. Moreover, users could set this behaviour on both their own and partner's displays. A day later, the screens started showing a 24-hour of history of the light at both locations.

Again, this feature came out of curiosity and exploratory reasons. The idea to use light in the remote environment to affect local display seemed confusing:

Her: rrrright 😊 why would I want your sensor?
Me: I will leave that to you 😊

There were few occasions on which that provided an unexpected connection. On one occasion, I was staying late in the office with lights off, having BW set to the remote sensor which was also in the dark. Suddenly, my partner turned on the lamp in her room and my display lit up with warm light as if it was a lamp in my office.

The timeline is the only part of the system that shows historical data. It was introduced as a visualization of differences between time zones but also provided awareness of partner getting safely home at night without the need of stressing them.

6.2.4.2 Changes and routines

For the first six months of usage the display was permanently in background mode, adapting to the light like a paper. Most notably, nothing could be seen on the display if there wasn't any light in the room, so the interaction with it was severely limited. On a similar note, the camera couldn't see anything in the dark room. When home in bed, I would normally use a laptop in the dark before going to sleep, but with the BW, I started sleeping with the lights on.

Waking up together was one of the most valued experience the design has enabled, and we tried to synchronize our schedules to wake up at the same time when possible. Unannounced changes to that routine were subject of guilt and disappointment:

Her: Good morning love! 😊 I am at work, so don't be disappointed 😊
Me: 😊 I am 😊
Her: 😊 whyyyy?
Me: I didn't know [ahead of time]
would have gotten up with you
Her: no way, getting up at 6am because of me, especially when the display was off anyway as it was too dark

The discussions about getting up more than doubled in the 6 months of using the system compared to the 6 months before, and the context moved from informative notices, e.g. *"have to go, waking up early"* to enquiries in order to synchronize or about the events observed, such as *"you seem to have shifted your waking-up time"*.

On 13th of June, after seven months (and what will become 6 weeks before the end), there is a first discussion between the partners that the work might become research and my partner was

encouraged to share her thoughts on the system. On the question whether she or anyone else had to change their customs due to the system, she writes:

"I didn't change anything other than in the morning, I don't wake up just like that, but I check the tablet to see whether you are there or whether there is a message for me 😊 Because handwritten message or drawing is better than [message] on Skype"

In the early stages, the device required daily restarts to recover from errors, which has become a normal part of the experience, without even checking whether it is actually working or not.

Her: I will be on the tablet...have you restarted it or should I do it? 😊

Me: Well once you switch on the lights we will find out whether the video is working 😊

6.2.4.3 Remote presence

The system provided a convincing sense of remote presence that reflected in the way we talked about the system, e.g. questions like *"Are you taking me with you?"* when I was leaving for a weekend or *"Where are you taking me?"* when she saw on the device that it is being moved. Because of different work/sleep routines, I would typically have the system in the office to catch the moment when she was going to sleep, and carry it with me home later, so that she can see me when she wakes up. At one point when I didn't take it back to the office, my partner felt abandoned: *"You left me at home!"*

It is worth noting that this set-up created an extra routine for the local partner of packing the tablet and carrying it with him back and forth almost every day. Since any drawn ink and light timeline are only stored in volatile memory (RAM) and the timeline ought to represent accurate history, the device was usually fully running while being carried. Despite the lack of connectivity outdoors, it provided a sense of continuity and togetherness.

Another aspect of remote presence is experiencing the remote environment locally. On one day, it was particularly dark and cloudy, while the window provided a view of blue sky and sunny room from the other end and lifting up the mood. Having the display reflect the remote light colour and intensity provided an extra connection compared to having just a sunny background wallpaper and brought shades that no local light source would provide.

6.2.4.4 Interaction with other technology

The BW had to integrate into our existing communication practices. Typically, we would be messaging using Skype on laptops, and when time comes to go to sleep, we would wish each other goodnight and my partner would move to her bedroom, either going to sleep or read. With the BW,

this time before going to sleep has become shared, and partners would interact on the device when in bed, continuing the communication through means acceptable in the bedroom environment. The window completely replaced morning greetings that would otherwise been exchanged from mobile phones.

I noted down my impression of decreased use of Skype as a result of using the BW, however, the chat logs do not indicate significant change in the number of messages exchanged. While part of the casual conversation indeed moved to the new device, it has been replaced by designing and troubleshooting the system when that did not work, including an increase in voice calls since some of the problems could not have been resolved through messaging.

We often referred to or expressed the intent to move the communication to the BW, such as “*see you on tablet!*”, “*I’m here! well not on the tablet*”, “*I waited for you on the tablet and you are not there*”, etc. but there was rarely need to coordinate the move the other way, since the traditional means of communication had means of taking over of the attention, such as audio-visual notifications.

My partner sometimes came to her bedroom to make a phone call in private. Noticing her partner being present on the Bedtime Window in bedroom, she waved for a greeting while being on the call. In one particular instance, the system has triggered interaction between the partners over different media: I have caught her sitting on her bed interacting with her phone, not having noticed me on the tablet. I grabbed my phone and sent her a SMS text message rather than Skype one to ensure she receives it on the device I saw her using, just a small hello. She got the message and smiled, then lifted her head and greeted me on the tablet. That was a warming novel experience, I have never seen her reaction to my message before.

6.2.4.5 New language

The most engaging and novel aspect of the design was most definitely the disappearing inking experience. Not limited by keyboard and the sequential messaging paradigm, we would draw and/or write freely in any style or script we liked, slowly developing new patterns of communication. The observed behaviour includes:

1. Creating abbreviations for commonly used words or phrases. Inking takes longer time than typing, and given the situated use in bedrooms, even whole sentences (such as have you slept well?) will quickly turn into few letters or new, invented symbols.

2. Adapting emoticons. At the beginning, we kept drawing emoticons as we would have typed them in Skype, such as :D or (hug). Those would slowly transform into more drawn forms in natural orientation, although some complex animated concepts, such as (facepalm) remained in their original form.
3. Annotations, corrections and explanations. Often someone would write a word that could not be read or used a symbol that the other one wasn't familiar with. A syntax needs to be established on how to ask for explanation and how to refer to things written previously. We eventually settled on underlining an unknown word, often with a question mark.
4. Reuse. When we were both actively using the device, words or drawings were reused in new sentences, simply by underlining them or drawing arrows at the time they should have been written. Another way is to graphically construct the new sentence so that the old word or letters would fit into it in different directions, similar to a Scrabble game.
5. Finishing sentences. Predicting what a partner is trying to write and either completing their sentences or subverting them into different sentences has been a great source of amusement and novelty.

Most of the time during active drawing sessions, the ink has been set to disappear within one minute. When communication evolves rapidly, this would often result in several layers of ink being written over each other using different colours to distinguish them, practically providing an infinite drawing surface. Longer durations of ink were used to leave messages when the writer did not expect to be around. On several occasions, previously written message had to be retraced when it has disappeared too soon, and the partner still hasn't seen it.

The only option to erase inking was to clear all ink on both tablets at the same time. Users would typically strike over or simply redraw things for corrections, however, the erase all command was sometimes used as an escalation tool during an "argument" filling the display with ink. There were no changes on the design of the inking since its introduction, other than adding a black colour, motivated by the need to write over photos with white surfaces. As could be seen on Figure 6.1, it is not apparent from the user interface at this stage that black colour is available (next to magenta), equipping me as a developer with a playful yet unfair advantage over my partner (that did not last long).

The way the communication using disappearing inking develops is inherently personalized to the couples using it, effectively creating a new, private language between them. Note that this is

possible only due to a single shared layer of ink where the last stroke comes on top of the previous ones, as opposed to each user having their own separate inking layer which has been the case in some of the previous work in office environment (e.g. [244]).

6.2.4.6 Privacy

We had no children and even when in the same country, we would spend Christmas separated, each with our own family. The system offered the possibility, for the first time in our relationship, to experience gifts unpacking together through the window. However, the only place my partner could place her tablet was next to a TV, effectively making it look like her whole extended family was watching me through the window, all gathered around a table, having an afternoon tea. Feeling watched by other people, this set up was unacceptable for me and lacking alternatives, the Christmas experience has been cancelled. This was the closest to a conflict between us during the use of the system.

Me: I dunno, this way everyone is looking at it 😊
Her: So what?
Me: well that's not great 😊 [...]
Her: Moreover, everyone at your side could watch us too
Me: Yes, that's not the point 😊
Her: What's the point then?
Me: that when it's next to the TV then the whole time everyone sits there it's like they are watching us on a TV 😊
Her: They are watching THE TV
Me: I know that 😊

Other than that, we experienced minimal privacy implications. The system allowed us to see when someone is at home or what activities they do, but it didn't limit anything. Other people were very rarely featured on the screen and when my partner started sharing bed with her sister (see below), the sister enquired about the angle the window covers and made sure she changes outside of the view. On reflection about privacy implications, my partner reported trying to position the device in such way that the capture of "innocent strangers" by camera was minimized.

Like most of the participants interviewed by Neustaedter and Greenberg, we have not tried using the system for cybersex and any occasional frame of nudity arising from changing in the bedrooms has not been sexual in nature. In that sense, the slow photo stream helped to maintain a level of privacy as envisioned. Being situated and peripheral in nature, it almost felt like desexualizing nudity compared to other means of communication (videos or staged photos).

6.2.4.7 Relationship

Both my partner and I view the BW as having a positive effect on our relationship. It created both a sense of remote presence and an awareness of each other activities, connecting us in the background as part of the everyday environment, during time that existing technology fails to mediate the connection between partners.

Seeing each other wake up and going to sleep was a special moment of the day, “[*Shame you couldn’t wake me up personally ...*] *At least I have you on the tablet, that makes my day better.*”, “*I like my tablet, I see you every day*”, and so was waking up to a handwritten message. Inking not only increased personal bonds through the development of a private language, but also expressed personal involvement through one’s handwriting and increased care. When asked why handwritten messages or drawings are better than Skype ones, my partner responded, “*it’s more personal, you have to invest more time and effort into it*”. After over two years since last using the BW, she “*felt that we were more together than if we just messaged each other*” to be the biggest contribution of the system.

6.2.4.8 Decline of usage

On 8th of May, the conditions in my partner’s house changed considerably due to family reasons. As a result, the remote partner started sharing a double bed with her sister, two floors away from where she would spend most of the day, including morning and evening routines. Moreover, the limited options of tablet placement in the new bedroom made it hard to reach for interaction, see Figure 6.3.



Figure 6.3. Two deployment configurations at remote partner during ABD. Left: Original set-up, easily accessible from the bed. Right: the only available place for the BW was hard to reach, leading to decline of usage.

Me: [the placement] is not great for writing

Her: yeah, it isn't... that annoys me, but there is nothing we can do 😊

While the system still provided limited value of knowing the other partner is present, it was no longer very fun, and the time window the partners could use it to communicate with each other become very limited.

Despite new, light-related features implemented in May, the usage has never been as active as before. On 25th July, the power supply has failed, and the hardware has been returned for repair and use in subsequent field study, totalling just over 8 months of autobiographical use.

6.2.5 Limitations of the ABD

We tried to peek into how similar system could benefit partners in LDR through the design and usage formed within the habits and conditions of me and my partner, some of which do not generalize to everyone. We were always in close time zones of one-hour difference, which even allowed us to synchronize waking up. We have known each other for many years, and we come from a culture where make-up is not very prominent, making it easier to be seen as we wake up. There were no children in the relationship nor in the houses where the devices have been located. It is also easy to put trust into a system that one is developing themselves and owning locations where data might be stored on the way.

As for technical limitations of the system, the most affecting issues were unrecovered connectivity drops and inking latency and/or loss. We tried to address these shortcomings for the field study.

6.3 Final System Design for Field Study

A preinstalled, point-of-service like devices were provided to participants, working out of the box. A quick user manual and an external USB-pluggable RGB sensor was included for the paper-like display experience. Devices were shipped to remote participants via courier service.

6.3.1 System Architecture⁷⁵

The BW system runs on standard Windows PC tablets, developed in C# using Windows Presentation Foundation. Based on learnings from the autobiography design above, it was critical to ensure that inking delivery is reliably guaranteed, and therefore devices connected with each other through a server software orchestrating the packets queueing, guaranteeing delivery when requested. The server part has been also written in C#, running on a Windows Server machine, and provides a primitive webserver to check on status of all the deployed devices.

⁷⁵ The architecture design has been published as a part of demo at Ubicomp 2019 [289].

The communication takes place over TCP/IP. Each device opens two bidirectional connections to the server, one for inking and one for everything else (see Figure 6.4), which allows low latency inking delivery uninterrupted by large photo packets.

Each pair of devices had its own symmetric AES⁷⁶ encryption key pre-deployed, so that photos from bedrooms couldn't be eavesdropped on the network or recovered from the server, should it be compromised during the course of the study.

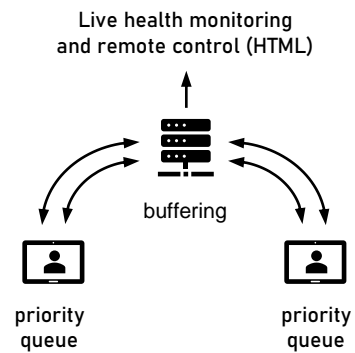

Figure 6.4. Overall Bedtime Window schema. Devices communicate on two channels through a server that distributes messages.

Packets have 16 bytes of header containing length, checksum, stream ID and flags. The purpose of the checksum is to quickly ensure parsing aligns with the packet beginning rather than to detect transfer errors, and is equal to the negative length of the packet.

The flags enable packet prioritization:

1. CanBeDropped: The packet contains non-critical data and if there is no connection available when it should be dispatched it will be dropped.
2. IsReplaceable: Only the latest packet with the same stream ID will be dispatched. Replaceable packet in a queue works like a placeholder for the latest packet of the same ID available.
3. Encrypted: The packet's data is encrypted using AES to prevent the server compromising sensitive data such as user photos.

For example, inking packets (Figure 6.5) cannot be dropped neither replaced, but photo stream will only send the last photo captured.

⁷⁶ Advanced Encryption Standard [180].

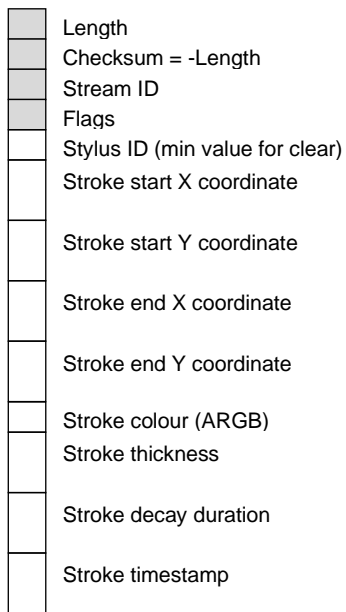

Figure 6.5. Inking packet (80 bytes)

At the end user devices, packets are enqueued with assigned priorities, and the queue is keeping a dictionary with the latest enqueued replaceable packets by their stream ID. Whenever connection is available, packets are being sent to the server ordered by their priority. The server parses the packet header and starts forwarding the data as soon as available to the remote party. It also keeps undelivered packets that cannot be dropped (including the replaceable lookup) and ensures the remote party receives them when reconnected.

Upon receiving an inking packet, the stroke is added to the inking layer and the ink disappearing process begins. The stroke opacity is decreased by 1% in regular intervals determined by the duration

they need to disappear over. Both local and remote stroke share a single layer, so the latest strokes are on top of the previous strokes, regardless of where they originated from.

6.3.2 Slow Photo Stream

The device captures a picture using the front camera every 5 seconds and sends it to the remote device. The user interface shows a live camera preview in the bottom-left corner with a progress bar so that the user knows at what moment the photo is taken. If the user does not wish to wait 5 seconds, they can tap the live camera preview to send a picture straight away. Received photos are shown full screen in the background. In case of connection loss, only the latest photo is kept in memory for delivery.

6.3.3 Inking





Users can draw on the screen with their finger (or a stylus if available). As they draw, the inking data is transferred and shown in real-time on the remote device, creating a shared inking space. All inking is in single layer, later strokes being drawn over earlier strokes regardless of who drew them. Users can select one of 8 predefined, basic colours, 3 predefined ink thicknesses and 4 predefined ink durations (one second, one minute, one hour or one day). All strokes start linearly disappearing (i.e. becoming transparent) as soon as they are drawn, so that full transparency is reached when the selected duration passes. Users also have the ability to instantly erase all ink on both devices at once.



6.3.4 Light

Users can switch between 'Normal' and 'Paper-like' display mode by tapping on these labels in top-left corner of the display. In normal mode, the display backlight brightness was either 25% or 75% depending on data from the light sensor, similar to standard automatic-brightness behaviour. In paper-like mode, the display was running background mode algorithm described in Chapter 5, trying to imitate light and colour that would be reflected from a sheet of paper in real time. Users could use volume down and volume up hardware buttons to manually offset the brightness from -200% to 200% in both modes in 10% steps⁷⁷. The offset percentage appears on the display and can be reset to zero by tapping on it.

On the right side of the display, two light timelines are displayed, one for readings from the local sensor and one for readings from the remote sensor. The timeline shows 24-hour history of ambient light level readings⁷⁸ from the sensor, the maximum value read per calendar minute. The timeline is absolutely aligned, i.e. local midnight is always at the top for both timelines, allowing to see any time-zone differences. The timelines also had a horizontal line indicating the current time of the day.⁷⁹

6.3.5 Status and Feedback

In the top right corner, four indicators were shown to reflect the status of critical components:  for the camera,  for light sensor,  for power status and battery level, and  for connectivity. Red colour indicated a problem, green colour indicated working status, grey colour indicated light sensor not present or partial connectivity⁸⁰. These indicators were present to aid any remote troubleshooting with participants.

Two smiley icons   – one smiling and one frowning – are shown at the bottom right corner of the display. When user taps on them, an optional screenshot is taken, and users can provide a free-text response to *What happened?* prompt using Windows software keyboard. Participants were suggested to provide feedback anytime they found something exciting or frustrating.

⁷⁷ The algorithm uses negative brightness, so 200% offset is needed to get from -1.0 to 1.0.

⁷⁸ Technically the level shown is a brightness setting that the background mode would set the display to, but all device pairs consisted of the same hardware, so they were directly comparable.

⁷⁹ Some participants took advantage of an implementation detail that the horizontal line is only updated when the timeline data is updated.

⁸⁰ The device maintains a separate connection for inking, see 6.3.1 for technical details. Partial connectivity is a state where one of the connections is up but the other one is down.

To further encourage feedback sharing, the icons playfully jump on the following occasions:

1. Passive viewing is detected: a face is detected in the camera stream for at least 5 consecutive seconds but no inking on either side within last minute.⁸¹
2. Busy session detected: For at least 3 consecutive minutes, there were over 500 ink strokes⁸² each minute.⁸¹
3. Idle usage: Every 5 hours of no encouragement⁸³

6.3.6 Other Controls

The system shows time next to the status indicators. Users can tap it to set the time zone.

Participants were free to choose whether they want to see the local or remote time.

There is also a context menu accessible by tap and hold anywhere on the display, which allows restarting the device, explicitly checking for updates and enabling first run experience. The ability to restart device using this menu was mentioned as a part of first aid troubleshooting instructions in the information sheet.

Tapping on the network status switches to the Windows OOBE Wi-Fi connection dialog allowing users to connect to their wireless network. The first run experience lies in starting the device directly into this dialog.

6.3.7 Differences from ABD

A few modifications have been made from the ABD for the purposes of the study. The light channel feature that allowed the display to “reflect” the light from remote location and control remote display was deemed confusing and somewhat difficult to grasp, hence the BW offered only ‘Normal’ and ‘Paper-like’ options and only for the local display.

There was no research value in having the black ink brush being hidden, so the user interface was updated so that all available controls are clearly visible to the user.

For extra protection of participants’ data, packet encryption has been added and all photos have been exchanged using AES encryption (and limited to the maximum width of 1280 px). All telemetry, set-up experience and the feedback mechanism were only introduced for the field study.

⁸¹ Unless there already has been an encouragement in the last 5 minutes.

⁸² Arbitrary chosen value based on pilot experiments.

⁸³ As an implementation detail, this condition is triggered every time the device restarts.

6.4 Field Study

The BW was deployed to 5 couples in LDR for the duration of 4 weeks.

6.4.1 Study Design

Each participant has been remunerated £150 in recognition for their contribution to the study and reimbursed travel costs to the interviews if they chose to attend them in person. The study design has been approved through full ethics review using the ethics committee procedures for Newcastle University.

Interested participants answered an online pre-screening questionnaire, enquiring about their arrangements and environment (e.g. how long have they been in a relationship, how often they visit each other, whether they have an internet connection etc.). Couples meeting the prerequisites criteria were selected on first-come-first-served basis and invited for 30 minutes of an initial interview and online survey regarding their current communication practices and use of technology in the relationship.

Initial interviews were conducted with both partners together, either in person or over Skype video-call, depending on participants choice. All but one couple chose a Skype call; for the remaining couple, the local partner came in person, but the remote partner had to be called separately due to scheduling reasons. The BW hardware was shipped by post to the participants who could not pick it up personally.

The participants then used the BW for the period of 4 weeks. The summary of instructions in the information sheet was as follows:

*leave the device on 24/7 in your bedroom as an ambient display
(feel free to cover it or turn away whenever you don't feel comfortable)
have fun with the device or just try to live with it for a bit
provide feedback if you find something exciting or annoying*

Participants were allowed to move the device around if they felt their daily schedules do not leave them any interesting common time to take advantage of the system.

After first week of the system running, I sent an e-mail around to check with participants whether everything is working and give them an opportunity to ask questions and voice their concerns and/or impressions. After the full 4 weeks, devices were collected and exit surveys and interviews were conducted, this time with each participant separately. Inspired by one of the couples sharing

photos they took of the device during the study, I sent another e-mail around to check if any other couple had taken any photos (they were not instructed to do so).

6.4.2 Participants

Ten participants (aged 23-46 with median of 27) have been recruited from a university in the UK, with the prerequisites of being in a relationship but currently living separately; not sharing their bedrooms with other people; and having previously lived together. Two of the couples were separated by countries, see Table 6.1 for details. Despite the pre-requirements, it transpired that the eldest couple had not lived together before. I kept them in the study, but their views on privacy might be skewed by this difference.

| Participants | UK and ... | Age | Occupation |
|--------------|------------|-------|----------------------|
| #13F #14M | France | 27-27 | working |
| #15M #16F | Germany | 38-32 | working + student |
| #21F #22M | UK | 23-23 | unemployed + working |
| #23F #24M | UK | 26-25 | students |
| #25M #26F | UK | 46-45 | working |

Table 6.1. Bedtime Window field study participants overview

6.4.3 Data Gathered

The results in the following section come from the initial and exit surveys data and interviews, the feedback participants entered through the system and some of the photos the couples were willing to share. Telemetry was also recorded on all devices, consisting of:

1. Tapping on any of the buttons on the screen (which most importantly includes changing between the 'Normal' and 'Paper-Like' modes of the display).
2. Drawing telemetry – colour, width, duration and length of the strokes during drawing. However, we deliberately excluded the absolute coordinates so that the actual content could not be reconstructed. in order to avoid biasing the communication between partners.
3. The ambient light sensor readings to assess lighting conditions in the bedroom environment.
4. The highest accelerometer reading per minute to detect active device use.
5. The highest number of faces detected in the camera stream per minute to detect passive device use.

6.4.4 Results

6.4.4.1 Engagement

Overall, participants have used and enjoyed the system, providing us with insights into communication of partners in LDR and learnings about how individual features of the system can or cannot address gaps they perceive.

Usage

All participants kept using the system actively for the whole duration of the study, except for some periods where the participants were not at home (for an overview, see Figure 6.6). As the data shows, everyone used the device for at least 4 weeks, with the exception of #14M, who was travelling for the last week of the study.

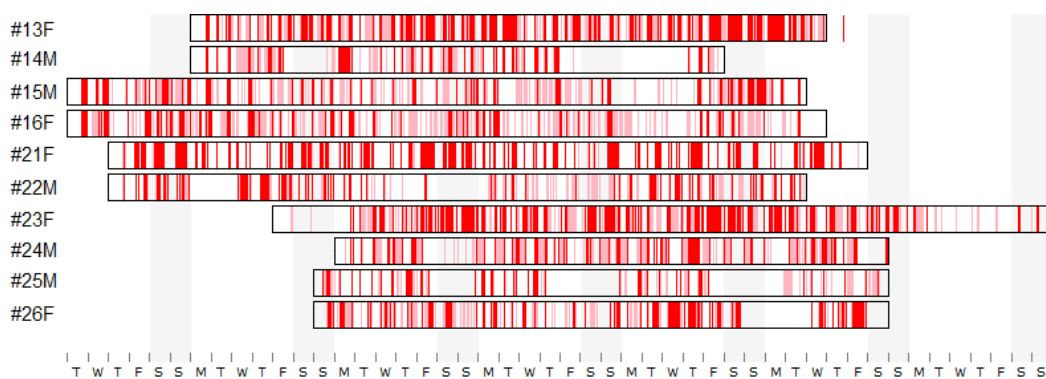

Figure 6.6. System usage during the study. Red: hours when display was touched or face has been detected on the camera, pink: accelerometer activity only.

During recruitment, participant #13F expressed a concern that she would use the system for a bit as it was a novelty and then stop. That did not turn out to be the case during the final interview.

“Yeah I liked it more than I thought actually. I liked the fact that it’s taking pictures every 5 seconds and the drawing was fun, so I think I liked it more than I thought I would, and we used it mostly in the evening, like coming home from work to say ‘hi’ and have some interaction and then the same in the morning before work, that’s the time, yeah.” #13F

Similarly to #13F, all couples reported using the device mostly in the morning and evenings as envisioned, which is a convincing evidence that the device is successfully targeted at remote bedtime sharing scenario.

Reception

70% of the participants viewed the system positively and would recommend it to other people in LDR (see Figure 6.7).

“I am really enjoying it - it is a much nicer way to say goodnight and good morning to [my partner], as opposed to using Facebook messenger.” #24M

"I think it was mostly nice device, I enjoyed having it, now that we don't have it anymore, I was telling [my partner] it would have been nice if it was still here" #14M

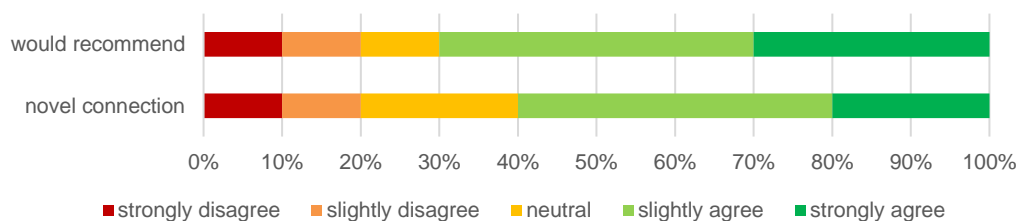

Figure 6.7. System reception questions. How much do you agree with the following:
 "I would recommend the system to other partners in a long-distance relationship" (top)
 "The system has connected me with my partner in a way that other technology have not." (bottom)

One couple, however, as already suggested by the responses in Figure 6.7, disagreed. They felt that the way their relationship works did not really benefit from the device.

"I don't like being in a long-distance relationship, I'd rather be close to [my partner] but I am not, I don't feel like I need more ways to be close to [her]. I think being in a long-distance relationship will always be difficult and with phones and the internet and messaging and ringing and video chat, there are enough tools out there to make the distance bearable and I don't, didn't need another device." #22M

He strongly disagreed with recommending the device to other couples in the exit questionnaire. However, at the end of his interview, when asked whether there is anything he would like to add, he said he would like to revise that answer:

"[...] maybe I was thinking too much about myself rather than other relationships when I answered the question [...] one of my friends who was in a LDR I did know that they would like fall asleep on Skype with each other, that was few years gone, so I guess if I had known about this at the time, I would mentioned it to him." #22M

The oldest couple (#25 #26) reported some mixed feelings. While they really enjoyed the inking aspect of the system, they felt negative towards the pictures sharing (they both explained it probably as a generational thing). Indeed, none of the younger participants had any problems with picture sharing. Despite this unease, the oldest couple also missed the system:

"both [my partner] and I have remarked that in the weeks after the study, we both missed having the device, in spite of the reservations that each of us had held during the study period." #25M

The feedback from participants suggests that the system, as autobiographically co-designed by partners in LDR, was enjoyable for other couples in LDR as well.

Features

In the exit questionnaire, participants were asked how important the individual features of the system were to them, 9 out of 10 marking both the inking and paper-like behaviour as important, and 7 out of 10 marking the picture sharing as important (see Figure 6.8 for details).

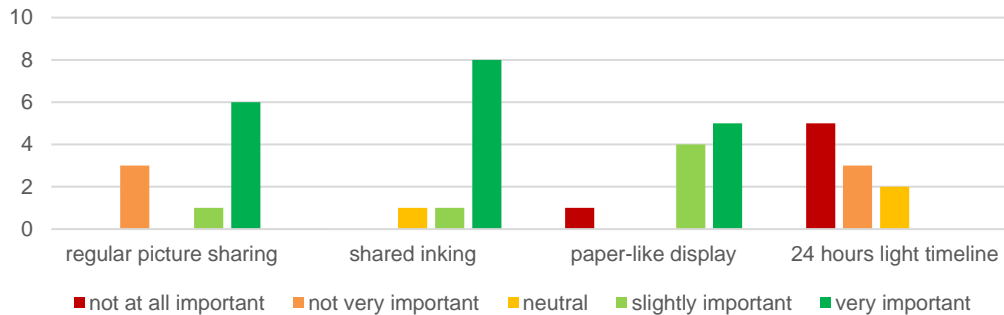

Figure 6.8. Feature importance question. How important were the individual features of the system to you?

When asked to rank the features in order of importance, everyone indicated that either picture sharing (6 participants) or inking (4 participants) were the most important to them with the other one being the second, except #25M who ranked inking first and paper-like display second. Timeline was clearly not popular or useful for the couples in this study. Two participants (#23F, #25M) realized they can use it to see the connection status of their partners, and #24M said it was kind of interesting from “*nerdy point of view*” to see which of their rooms went dark first, but that it looked kind of similar whenever he looked at it (we did not have any large time zone differences among participants where the timelines would differ considerably). Some participants did not notice the timeline at all, despite its description in the information sheet.

6.4.4.2 Slow Photo Stream

The slow photo stream was a novel experience for all participants, but its reception was divisive. One couple didn’t like it, feeling “*we could just be on the phone instead*” (#21F) and comparing it to online videos experience. #26F was frustrated “*that it wasn’t smooth, that it was a still, and then another still, and then another*”. On the other hand, others saw an opportunity for play:

“it adds an element of fun, because if you are having a very interactive session, you have a chance to think what you are doing and you can have fun with it, like making some funny faces, or you can kind of put your head really close and then move away, just really silly, silly games.”
#13F

“[at the initial interview] I was like ‘maybe a video would be nicer’ but actually I think there are nice things about the pictures” #14M

The Figure 6.9 shows results from the exit questionnaire asking whether participants would prefer the two familiar alternatives (i.e. video and photos).

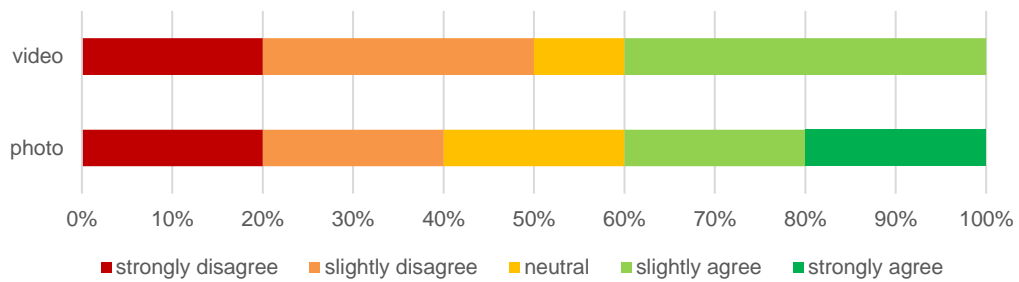

Figure 6.9. Slow photo stream questions. How much do you agree with the following: “I would prefer if the camera was sending video all the time rather than occasional pictures only.” (top) “I would prefer if the pictures were shared only when I say, not automatically.” (bottom)

Half of the participants suggested they would either like to be able to adjust the interval between the photos, possibly the same way they could for the ink duration, or to make a photo last until the other person sees it as a part of a message they left.

Only two participants mentioned direct effect of the photo stream on privacy the way the feature was envisioned in comparison to always-on video. When discussing the negative privacy implications, #26F suggested video would be even worse. #23F felt the photo stream provides a balance between privacy and sharing:

“I liked it actually, because video feels quite awkward, because you can see everything they do all the time, where as 5 seconds is like a moment where you know they can’t see you, it doesn’t matter if you wanna like go and get something or I don’t know, it feel[s] a bit more private but also sharing, which is nice.” #23F

Another two participants also expressed the lessened tensions the photo stream provides compared to traditional video connection, suggesting it might be more appropriate for always-on peripheral systems:

“I think with the normal video maybe you feel you have to pay attention all the time” #24M

“you don’t feel maybe the pressure like the video” #14M

Nevertheless, the system managed to preserve the sense of remote presence. For 3 couples, the feeling of remote presence is an important part of a LDR, and those couples reported that the system made them feel present at partner’s place as well as the other way around. The remaining two couples who did not find the feeling very important also reported experiencing it to lesser amount, see Figure 6.10 for details.

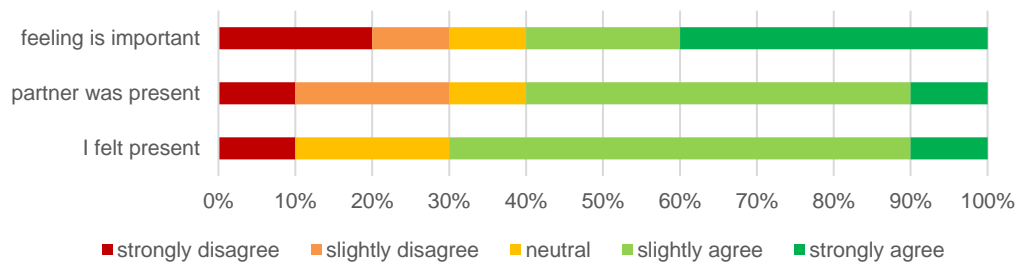

Figure 6.10. Remote presence questions. How much do you agree with the following (top to bottom):
 “The feeling of being remotely present is an important part of a relationship to me.”
 “The system made me feel my partner is present at my place.”
 “The system made me feel present at my partner’s place.”

We saw that participants did not agree on whether they prefer photos, photo stream or always-on video (they only experienced the photo stream condition in this study). Advantages included additional playfulness, less attention demands supporting peripheral use and increased sense of privacy compared to video, while still allowing sharing and remote presence. Negative feedback suggested the photo stream to be either too slow or too fast. One possible way to mitigate the negative aspects of the experience and address many participants’ desire to make the photos last varied length of time would be an experience where users can adjust the frame rate anywhere from still photos to full video.

6.4.4.3 Inking

Real-time, shared inking was a central experience of the system and proved to be a simple, versatile and novel way of personal communication, which everyone enjoyed. As Figure 6.8 showed, inking was the most important feature of the system to the couples.

Simplicity

The system did not require any extra interaction in order to send ink strokes to the remote device, as soon as the screen was touched, ink was transferred in real-time to the partner. This always-readiness was valued in comparison to the work required to initiate communication through traditional means.

“I think the right word would be ‘effortless’, because when you use WhatsApp or something, you have to do more of an effort, you have to think about to do it, whilst here you do it, it’s more natural.” #14M

The inking was easy enough to be performed side by side with other activities —

“We were drawing at the same time as on the phone” #21F

“We also used it whenever we called each other on the phone, so it’s like Skype, almost, and then we could talk and draw at the same time” #23F

— or just when passing by the device:

“[...] even writing, we always leave each other message even if we’re passing by [...]” #14M

The feasibility of long text is a matter of personal preference (as #15M noted, *“writing everything yourself is a bit harder but also quite rewarding if you like it”*), but in general inking was easy to understand, simple enough to multitask with other activities and straightforwardly complemented with other technologies when needed.

Versatility

Another benefit of inking as a medium of communication is that it is inherently versatile, supporting both text in any language and freeform use [254]. Ink was used in a variety of modalities, from asynchronous, where one person was drawing to leave a message (85% of sessions), to turn taking, where both partners were present and drawing to each other but never at the same time (10%, *“we just like.. take turns to see what each of [us] was drawing”* #22M), to fully synchronous where both partners were drawing at the same time (5%).⁸⁴

In addition to those varying modalities of use, people also used ink for many different purposes. Examples of how participants used inking for purposes such as conversation, organization, relationship maintenance, play and art now follow. Note that these examples are just based on ones reported to us by participants; there may be other categories, but because of privacy concerns the full inking history for participants was not recorded.

Organizational: Couple #25M-#26F described how they communicated about events in the future.

“We might have left messages like phone call tonight, question mark, 8pm, question mark” #25M

⁸⁴ For statistical purposes, any session containing at least two consecutive seconds in which both partners draw was counted as synchronous, sessions meaning occurrences of inking with less than 2 minutes break.

Relationship maintenance: All couples reported using inking for relationship maintenance, i.e. wishing a nice day or a good night, welcoming each other, expressing affection.

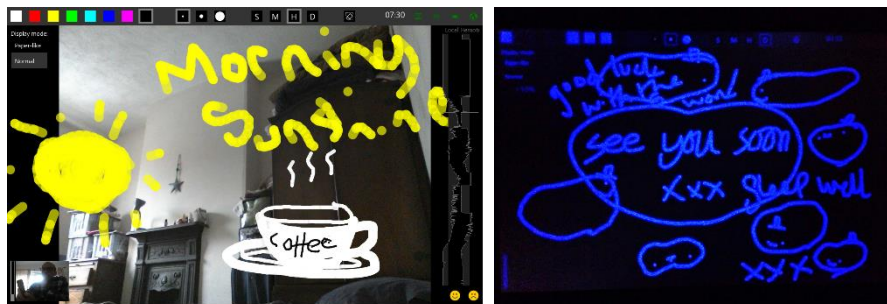

Figure 6.11. Examples of relationship maintenance: wishes of good morning (left, #25-26) and good night (right, #23-24) by different couples, both partners sharing the inking space.

“small love words or like hearts, [...] usually not very long messages, but like just to say ‘hello’ or ‘miss you’ or something like that” #14M

Partners mentioned both synchronous use, when both of them were interacting at the same time (see e.g. two handwritings in Figure 6.11 right), as well asynchronous, when they left messages for each other to see later.

“[She] wakes up earlier than me, so before she goes to work she’d normally leave a message, like ‘have a nice day’ or if she was coming down to visit me like ‘see you tomorrow’, something like that, that was kind of mainly how it was used.” #22M

Drawing hearts was a big part of the relationship maintenance. All couple but one discussed drawing hearts.

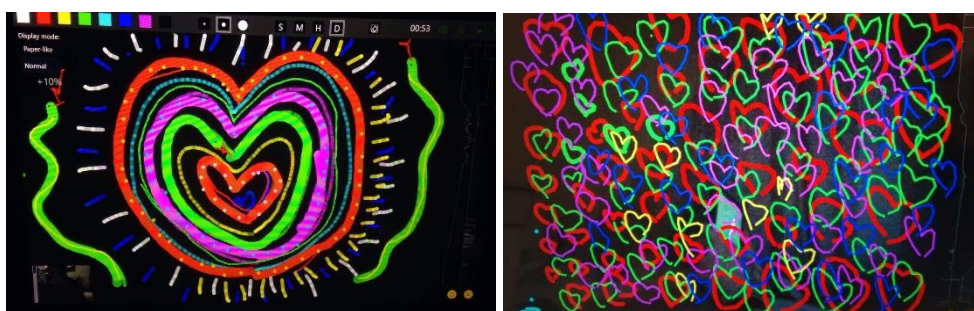

Figure 6.12. Examples of relationship maintenance: drawing hearts (#23-24 left, #15-16 right).

Even when a partner is not very good at drawing, the inking aspect of bedtime window helped to create something the couple would carry on between them.

“[the heart symbol] is not something that I have really had a lot of practice drawing in the past, and kind of through the window I learned - or we learned - that I am really bad at drawing a heart, and it kind of became a joke that it was basically just a circle which I was drawing, so

instead of trying to draw heart we both draw like this really crude child attempt to drawing a heart” #24M

Conversation: One of the couples reported having long handwritten conversations (“*sometimes we talked actually by writing*” #23F), the same me and my partner experienced during ABD (see Figure 6.13). Others, however, preferred to move to other communication media in those cases, see limitations below.



Figure 6.13. Examples of crowded communication, 4 layers of writing on 1-min ink duration (ABD).

Play: Inking offered unique experiences of fun and supported playfulness. Three couples discussed playing various sort of games involving various communication strategies. #15-16 played a guess a word, where participant take turns. #23-24 on the other hand, appropriated the game of rock paper and scissors into a very synchronous inking interaction:

“it was essentially like rock paper scissors [...] so like counting down, from 3 to 1 before you choose your move, you do 3 lines on the screen, and when it comes to the third line you have to quickly draw your choice, which is quite fun” #24M

Finally, #25-26 described using different technologies used in a game of guessing a type of a flower that one of the partners has drawn.

“she’s has drawn [the flower] and then written, handwriting to say ‘guess the flower’ [...] I would text my answers [...] so it was in conjunction, it was both the window and that” #25M

Art: All couples discussed creating various art drawings, some of which were very heavy on ink (see Figure 6.14 for examples), effectively attenuating other features of the system, and the artistic abilities of partners were compared.

“I drew random stuff – a pineapple, a ghost, a dinosaur... [no connection...] it was just a nice picture, just a dinosaur with the speech bubble saying ‘hello’ – it sounds really silly, but... that’s kind of joy, apparently.” #25M

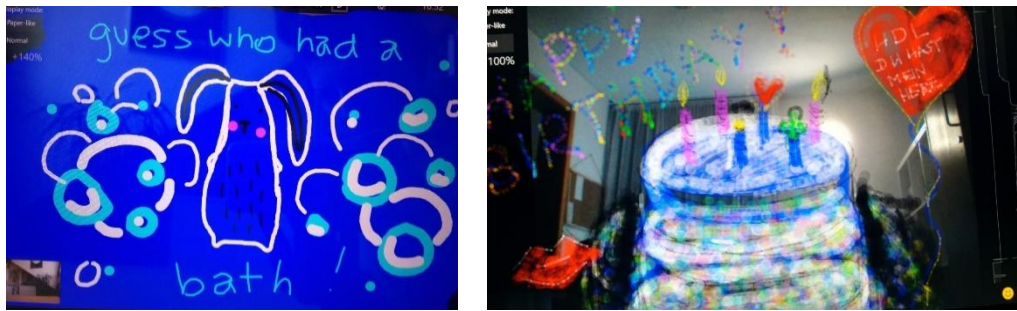

Figure 6.14. Examples of heavy inking. “I’d just paint the whole screen once and drew on it, both of us did that couple of times which was nice” #23F (left), impressionist style of #13F (right).

A notable example of interactive session took advantage of the shortest ink duration available, effectively creating a live animation:

“I drew a little person with an umbrella, and he put it on second and put little blue lines and it looked like it rains, that was quite fun” #23F

Situated: Some participants used ink to leverage the situated nature of the system. Two couples reported tracing and/or annotating the scene they saw on the photo stream, despite the fact that the remote partner could not see it that way. This includes drawing picture frames through which parts of the photo stream could be seen, see Figure 6.15 for examples.

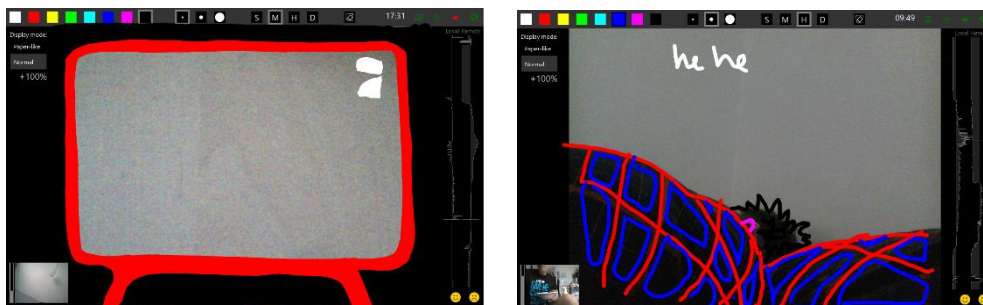

Figure 6.15. Situated inking: framing the scene (left, #15M), tracing a scene (right, #23F).

Novelty

To my knowledge, BW is the first system whose main method of personal communication was inking on a shared, non-layered surface. Moreover, the real-time and disappearing nature of the ink opened new ways of interaction between people.

“it’s kind of instant, you can see the drawing happening, and [...] there is an engagement there, it’s not just a transmission, it’s what’s happening live” #25M

The communication flow builds on what is already on the screen, sometimes even before that. Participants were overwriting, overdrawing or otherwise intervening with what their partner was inking in a way that exchanging messages does not allow.

“sometimes we’d adopt things to each other’s drawing, or wrote over each other” #14M

“sometimes if you paint and I think this colour does not fit here I just draw over the other colour” #15M

“I’d cross out things that she wrote or sometimes trying guess what she is going to write, so she is writing a word, trying to finish it or deliberately change it so that its’ wrong.” #24M

When explicitly asked, participants would admit using arrows (#24M) and/or question marks (#14M, #24M) to mark something that could not be read or understood during conversation in situ, but in general self-reflecting on the discourse aspects of inking was unsatisfactory. No one reported abbreviating written text within the 4 weeks of the study, with one participant feeling that would make it “less exciting”.

Finally, the real-time shared space allowed participants to create something together in a way that other means communication usually do not. People call each other or text each other, and while it is certainly possible to draw to each other, as many participants did, it’s also possible to draw together.

“It’s a beautiful thing, you can create something – that’s quite nice – together” #15M

“we have drawn something together” #16F on many occasions

“I just find it quite funny trying to guess what it was that we were drawing” #24M

In other words, common ways of communication rely on turn-taking, while the BW allowed simultaneous collaboration in which both partners participate.

Personal

Participants also highlighted some of the qualities of inking that other means of communication do not provide, the most prominent was the fact that the messages and/or drawings were handwritten and therefore more personal, as seeing each other’s handwriting is becoming less common.

“It was nice to be able to see each other’s handwriting and drawing style, that was a surprise, I know you mentioned it [during the initial interview] and I was like ‘oh okay’ but that was actually really valuable.” #25M

“it was nice to have a picture or a little handwritten, you know that’s the nice thing, handwritten, and it’s not typed, so we both really liked that [...] because it’s more personal, it’s part of somebody that used his hands to do it” #26F

Committing to handcraft a message or draw a painting is perceived as caring about the partner. Sometimes, inking and messaging behaviour differ in unexpected ways.

“You have to write it yourself, everything, which is a bit harder but also quite rewarding if you like it.” #15M

“[he] put more kisses that he would do normally on messenger, which was interesting, I don’t know why, but he just did” #23F

Limitations

It is clear that one technology does not fit all and since participants were not restricted in the usage of other means of communication, they naturally switched to other technologies when appropriate.

“we needed to organize something, and we couldn’t, you know, that’s not what the device is meant for, so then we would [use WhatsApp]” #26F

While #23-24 enjoyed long textual exchanges as discussed above, most couples deemed the system unfit for exchanging long text (“you can’t fit many words on it” #25M, “it gets messy quite quickly” #15M), especially when the ink is set to last for a long time. Participants would simply switch to another system if they felt they had enough:

“If the threshold of annoyance was reached, then we swapped to Skype or WhatsApp. [...] I wouldn’t write I have enough, I just like send a WhatsApp or call” #15M

Another source of inconvenience has occasionally arisen from the ephemeral nature of the ink. Three participants reported they occasionally forgot that the ink is set to last shorter than they wanted, which was easily fixed by changing the setting and redoing their creation. #25M redid a drawing even on the longest duration when he noticed it’s “starting to fade”, and on one occasion, it was easier to take a picture of the drawing.

“once I spent a long time doing a drawing, so I had it on hour setting and then she wouldn’t be home for another hour, so I ended up taking a photo to prove it” #24M

One possible way to address these shortcomings, apart from letting the ink stay indefinitely, is to offer a way to ‘bump’ the ink duration, so that it can stay longer than originally intended without the need to redo the content.

6.4.4.4 Appropriateness in bedrooms

The study showed that technology situated in bedrooms can provide value to people without being too intrusive. 7 out of 10 participants agreed that falling asleep and waking up together are important moments of a relationship. Six people found it valuable seeing their partner during that time and the same six people felt comfortable sharing this time with their partners, see Figure 6.16.

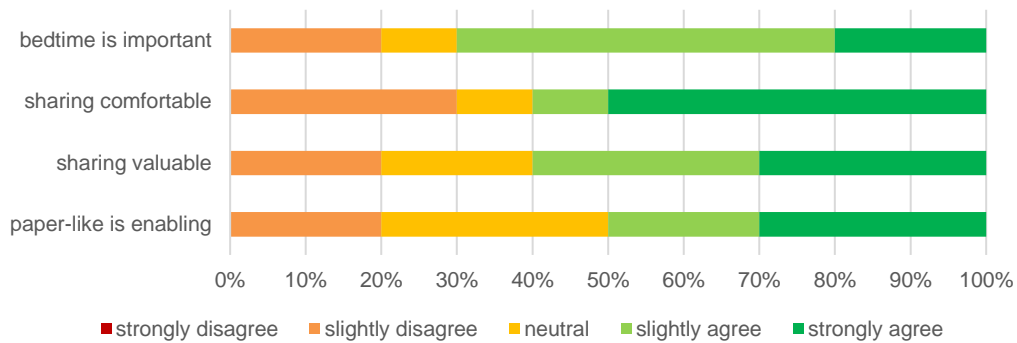

Figure 6.16. Bedtime questions. How much do you agree with the following (top to bottom):
 “Being together when falling asleep and waking up are important moments of a relationship to me.”
 “I felt comfortable sharing the time when I fall asleep and/or wake up with my partner.”
 “Seeing my partner fall asleep and/or wake up was valuable to me.”
 “Paper-like display allowed us to stay connected around bedtime.”

“I like the part that you can see when your partner, you can go to sleep with him and wake up, and you can see when he is home or not and what he is doing” #16F

“That time when you are in bed before you sleep, like I wouldn’t really watch him after he’d fallen asleep, but it was more nice when we were both getting ready for bed, maybe sitting in bed for a bit and then sleeping, this period was nice.” #13F

One couple even tried to synchronize the time they wake up. On the other hand, the couple who liked BW the least didn’t think it was important to share bedtime and their schedules did not let them to try the experience either.

“I think I started waking up a bit later than I’d try to, because he wakes up later, so if I wake up and he is asleep, I’d be more inclined to just stay in bed rather than normally I get up straight away” #23F

“We didn’t really used it very much for that, I think he probably goes to bed later and gets up later than me as well, and I get up really early, so I think we weren’t really on the right schedules to try that very much, but I feel like that, when he is not in the room, I am not that bothered about, trying to recreate it.” #21F

An important aspect of technology with emissive display becoming appropriate in bedrooms is the ability to blend into the environment, not affecting people’s sleep. Unlike in [255], participants

could switch the BW between normal display mode and paper-like mode, which would adapt to the lighting in real-time, effectively turning the display off if the room was dark.

“I really liked [the paper-like mode] because when it’s dark it adapts to the lights, so it doesn’t distract you at all, so you can sleep quite well, because with the Skype, sometimes it’s really distracting if you leave it overnight or try to be with so you are asleep then sometimes the light is distracting.” #16F

7 out of 10 participants said they usually or always kept the display in paper-mode. Sometimes they switched to normal mode when the clarity of display under dim environment lighting wasn’t satisfactory for interaction, in which case, they would turn it back to paper-like when they went to sleep. #26F compared switching to paper-like mode to a goodnight routine (*“I might do that at bedtime, as it seemed sort of good night type of thing” #26F*).

6.4.4.5 Relationship

In overall, the BW had a positive impact on relationships, providing connections that are not easily achievable using other technology, as confirmed by the exit survey questions described in Figure 6.17.

We have already discussed the notion of drawing and creating something together as a couple rather than sending messages to each other and hinted the notion of feeling of increased care from partner’s side.

“He came across as more caring and affectionate in the drawings” #23F

“It definitely has [the showing care] effect, the intimacy effective, that was a surprise, it was a pleasant surprise, to see that, it did add a dimension to a relationship.” #25M

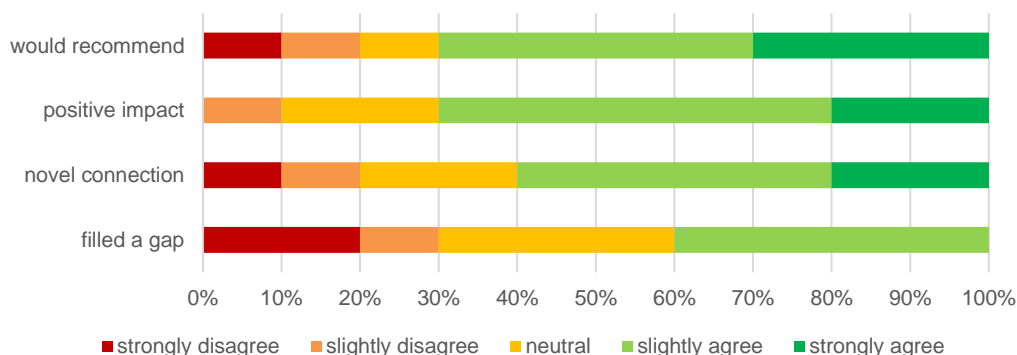

Figure 6.17. Relationship questions. How much do you agree with the following (top to bottom):
 “I would recommend the system to other partners in a long-distance relationship”
 “The system had a positive impact on my relationship”
 “The system has connected me with my partner in a way that other technology have not.”
 “The system had filled a gap in my relationship.”

Ordinary daily activities that are not worth having explicit conversations about become part of long-distance relationship again and participants found value in seeing them, in agreement with the results of Baishya [206].

“The whole morning routine and evening routine of getting ready for work or getting changed and stuff is something that’s not important enough to talk about, but then when you see it, it’s kind of, I don’t know, it definitely increases the connection, like, I don’t know it’s just knowing what each other is doing is just nice I guess, it’s more like being in the same place, kind of.” #24M

“I guess the surprising thing is that it’s nice to see her like eating breakfast... which on itself is not exciting at all, but it’s interesting that seeing that is nice. [...] really mundane stuff becomes like quite nice thing” #24M

The situated nature of the window leverages one of the key aspects of a collocated relationship – only short sparse interaction or no interaction at all, just being together (*“because if you are together, you wouldn’t constantly be having a conversation 100% of the time” #24M*).

“Sometimes we would see each other and that was nice, briefly, and we knew that we were both sort of on our way to work, so we did give a wave and smile and a picture” #26F

“I think it made [the relationship] better [...] because when we were really busy, it is hard to make time to talk properly, but even if your exchange is shorter when you can see each other through the window it’s a bit more meaningful, so I didn’t really miss that we weren’t talking that much if we weren’t talking that much.” #23F

Participants felt the BW made them feel closer compared to other existing technologies they were using.

“It helps you also feel sometimes that you’re near to the other person, more than social media” #14M

“I feel more connected to my partner, I feel more like he would be close to me rather than text him and then [it’s] over” #16F

“we were just thinking about each other slightly more, wondered what they were doing” #21F

While one couple did not feel they need yet another way to be in touch in their relationship as we discussed in 06.4.4.1, all the other couples felt that the BW did help them to be closer, learn about each other and create shared memories.

“I think we are always in touch, you know, like nowadays would have all the technologies and WhatsApp and everything, we’re always in touch, but it’s a different way to be in touch.” #14M

6.5 Discussion

Hassenzahl et al. described six strategies for mediating intimate relationships through technology: awareness, expressivity, physicalness, gift giving, joint action and memories [187]. The BW allows partners to employ most of these strategies: awareness with passive photo stream, expressivity with inking, physicalness by sharing bedtime and light of the environment, gift giving by leaving messages for partner when they come home or wake up, joint action by drawing together. The last one, memories, could be easily achieved by giving users the ability to save their creations (*“if you said to me now that we could see all of the drawings, that would be amazing”, #24M*).

All but one couple consider being together when falling asleep and waking up to be important moments of a relationship, yet very few technologies are exploring this space. The same couples indicated that the system has connected them in a way that other technologies have not, that it had a positive effect on their relationship and that they would recommend BW to other couples in LDR. The remaining couple did not feel they need to be connected during bedtime, or that they need any more ways to connect in general, suggesting that this is specific to how their relationship works.

Every couple I got to know during the study, the dynamics of their relationship as well as communication habits were unique, and it is expected that any technology, especially designed around needs of one particular couple, will not fit to everyone. However, the way one of the couples used the system (#23-24) was especially similar to how my partner and I were using it during the ABD, and while ABD does not lead to generalizability, long-term design process around genuine usage of particular users will often match group of other users with the same needs and patterns.

6.5.1 Further Recommendations for ABD

I have presented an autobiographical design of an always-on interactive system allowing partners to share bedtime and communicate through new ways of inking. The co-designing process is rarely documented in the literature as authors often do not expect their work to become research and do not think of or find it worth collecting formal notes from the process [251], but in this case, conversations were coincidentally logged.

There is little that can be done for researchers undergoing their first autobiographical design not knowing their work will become research other than including the methodology in research training. Besides the methodology discussed by Neustaedter & Sengers [251] and Desjardins & Ball

[252], the learnings from the process of designing BW for future autobiographical research are as follows:

1. Genuine, long-term usage is more important than genuine need. Many successful designs arise as a result of exploration, curiosity and imagination.
2. Ensure usage is recorded in the system logs. Often logs are already produced for debugging purposes and logging telemetry is little extra work that allows to back up potentially biased personal experiences. I believed the usage of Skype with my partner has decreased during the ABD, but logs confirmed barely any change. BW itself did not have most telemetry until later field study deployment.
3. Keep individual iterations. Source control is an ideal choice, but if not employed, set aside binaries if applicable. For long-term usage, it becomes difficult to remember how features were added and it was only possible to reconstruct the design process thanks to the auto-updating feature of BW preserving previous versions of the software.
4. Try to collect communication with other users and stakeholders of the system, in addition to personal observations and feelings, as a documentation of the co-design process and its decisions. Coincidentally and uniquely in the literature, most of the conversations from the design process have been recorded for BW, however, daily personal experiences are not available, apart from a few notes by the researcher, which can at best help to recollect only a one-sided view of the system.
5. Try deliberately changing the conditions where, when or how the technology is used. For BW, the partners were “lucky” to experience two completely different set-ups, one of which worked great and one that eventually failed. While ABD does not guarantee generalizability, becoming aware of why a design might or might not work in a different situation is a valuable insight that can make learnings from further studies more effective.
6. Report on what happened with the autobiographical design at the end, and what led to its decline, had the usage stopped. Gaver wrote his design became part of his home [170], and Chien noted they are still using 2 of his 4 designs [186], but most of the autobiographical research does not mention the fate of the technology designed [217, 256, 257, 231, 258].

6.5.2 Implications for System Design

I found that bedtime is important part of relationships, yet mostly unexplored in HCI for both co-located and separated couples (with notable exception of [227]), and that technology can play a

supporting role during this time. Using paper-like display mode allowed us to deploy fast emissive displays into the space of bedroom environment for the first time, without the need to worry about affecting participants ability to sleep.

The situated and dedicated nature of the system, like in previous works, was critical in not only mediating remote presence and awareness and lowering barriers to communication, but also enabling 'gift giving' in the form of drawings – something to look for when one returns home.

6.5.2.1 Photo stream

I was able to reproduce several findings from previous work on always-on video channels, such as increased awareness of and connection to the remote partner, and increased thinking of and interacting with each other without the feeling of obligation to call [217]. Notably though, I was able to do so without having an always-on video channel, suggesting that always-on video is not critical to achieve these design goals, saving consumption of both bandwidth and power as well as privacy concerns of being constantly monitored.

Moreover, the photo stream allowed extending the freedom from obligations into the communication itself, as participants didn't feel pressured to pay full attention to each other and to give up their time to focus solely on the interaction with their partner compared to regular calls. Many mundane and daily activities are not worth talking about but are still nice to perceive and share, and sharing these seemingly unimportant moments is a fundamental part of living together with someone. As one of our participants pointed out, people don't constantly talk to each other when cohabiting either.

While the slow photo stream proved to be a promising compromise between users' privacy and feeling of remote presence, participants also expressed the desire to sometimes retain photos they have staged for their partners until they see them, as well as for more video-like sessions. Some of them suggested to associate the disappearing property of ink with the photos too. This suggests that users would benefit from being able to adjust the lifetime or interval between photos in a photo stream on the go, anywhere from 'stopped' to the 'video' state.

What, however, turned out to be an important element when employing a photo stream rather than video is an indication about when a photo is going to be taken. Not only it enables additional playful usage (i.e. staging photos, animation) and facilitates effective communication (i.e. users do

not need to wait unknown amount of time to send a message), but also clearly marks when users can expect a window of complete privacy.

6.5.2.2 Inking

The core communication channel, real-time disappearing inking on a shared surface (i.e. where last stroke wins), proved to be an enjoyable and versatile experience, allowing participants to communicate, play and create together, letting them to leave messages and drawings for later as well as synchronously draw at the same time, in any language and writing script, expressing personal involvement and care.

We have all experienced the ability to send handwritten messages come and go in commercial software, but that covers only fraction of the affordances of inking. Sharing one inking space in real-time opens space for conversation, creativity and play. Ishii presented the metaphor of drawing from two sides of a glass, resulting in separated ink layers [244]. In BW, the strokes are overlaid on a single layer, providing new, unique experience without corresponding physical equivalent, leading to inking meta-interactions where users alter, overwrite, annotate or decorate ink as it is appearing. This is comparable to typed-chat in which participants see messages as they are being typed (e.g. [259]), except that in this case users can actually interfere with each other's writing.

In addition to traditional inking properties such as stroke width and colour, a 'decay time' property has been introduced, defining individual stroke's behaviour over time, effectively making all the ink continuously disappearing as soon as it is written. Similarly to the photo stream, while disappearing ink supported conversation flow and extra playfulness, users suggested it would have been desirable to have an option to keep the inking visible until the other partner sees it.

Some participants spent a lot of time drawing unexpectedly complex and ink-heavy content and employed their own measures to ensure their creation is preserved, such as taking picture of the device with their camera. Despite valuing ephemerality of the system for sharing mundane tasks, everyday drawings and just being together, inking is inherently time consuming and cannot be as easily reproduced as usual text messages or photos, suggesting that a way to save drawings would have been welcome by users.

6.5.3 Limitations and Future Work

The BW has introduced new experience paradigms and many questions remain yet to be answered. I showed that always-on video is unnecessary to achieve many of the common goals of connecting partners in LDR. The system used an arbitrarily chosen interval of 5 seconds between photos, but how much of the continuity can be removed without affecting the design goals is not known. In a similar way, the set of ink disappearing intervals were chosen arbitrarily, and the optimal duration for maximizing communication flow needs to be determined.

Cautious about affecting the content of inking exchange between partners in an intimate space, the inking content has not been recorded in this study, only the amount and properties of the ink used. However, we learned that real-time shared inking brings meta-interactions and new elements driving communication dynamics, topics that have not yet been systematized or described in the field and that I hope will be explored in future works.

Undoubtedly the learnings from BW are limited by the circumstances of our participants, who were at most 1 hour of time zone difference apart, and who have experienced the system for 4 weeks only. The ABD taking place for about 8 months has already indicated some of the developments with long-term usage, such as abbreviating common phrases and inventing new symbols and language elements between the partners.

6.6 Summary

In this chapter the Bedtime Window, a system for connecting remote couples during bedtime, has been described and evaluated. The system was designed through autobiographical process of long-term, everyday usage of myself and my partner for 8 months, and subsequently deployed to 5 other couples in LDR for a field study of 4 weeks.

Our participants found a slow-photo stream to have a higher degree of privacy than video, while it still provided a sense of remote presence.

We have also shown that real-time shared inking offers a rich communication channel supporting novel ways of communication that are not easily achieved with existing mechanisms that rely on turn taking, such as mobile phones. This includes live annotation and intervention, as well as simultaneous co-creation.

Most significantly, participants indicated that bedtime is an important time for partners to share and that situated image sharing is acceptable in the bedroom, as long as the display stays unobtrusive. None of the participants using the novel paper-like mode raised any concerns about the system being distracting or preventing them from sleep. The Bedtime Window wouldn't be able to achieve its goals of interactively connecting people around bedtime without the paper-like display.

Chapter 7. Conclusion

In this thesis, I proposed a way to make widely used emissive displays physically blend into the background, namely making it react to light in the environment the same way an ordinary piece of paper does, and showed that emissive displays can be successfully used as a component in calm technologies.

First, I have designed and run a visual psychophysical experiment that provided us with learnings about human vision under extreme chromatic lighting, conditions that are becoming more and more common in home environments due to ‘smart’ lighting, but also whenever normal emissive displays are the sole source of light in the room. We estimated the human performance of colour matching an emissive surface (standard TFT display) to a reflective surface (colorimetrically controlled sheet of paper), providing the basis of how good an algorithm needs to be doing the same task to exhibit perceptually acceptable results. Current literature is lacking both cross-media matching and matching under chromatic lights. We have also contributed to the discussion of varying results of hue versus chroma discrimination thresholds, suggesting that it can be explained by variance in luminance. Interestingly in the context of this thesis, some observers couldn’t tell which surface is the display and which is the paper during the experiment.

Second, I have designed an algorithm that senses light in the surrounding environment and tries to behave as a reflective medium in the way it reacts to the lighting changes, by adjusting both backlight (if available) and global gamma lookup tables in real-time. Since colorimetric data about the display and sensor are currently not available to the software, nor to the user, a single calibration step is required to “show” the display how it should look like under few different conditions, which can be easily performed by the user and common commercial lights.

I have then deployed a display running this algorithm into peoples’ bedrooms in a two-week fieldwork study, resulting in 13 % of nights when users kept the ‘normal’ display on, and 99 % of nights when users kept the ‘paper-like’ display on. Overall, I have demonstrated that paper-like displays successfully blend into the background, are less distracting than normal displays and that they are acceptable even in such environments as bedrooms.

Finally, I provided an example of a practical application of the paper-like display in the Bedtime Window, a system for connecting partners in long-distance relationship during bedtime. In a four-week deployment to remote partners, we have explored several features of always-on connection

and interactivity. Most importantly it was a slow photo-stream that provided a balance between privacy and remote presence, and real-time shared inking with disappearing ink that provided novel and engaging means of communication compared to traditional, turn-taking technology. Participants indicated that Bedtime Window had mostly a positive effect on their relationship and suggested that bedtime is an important time to share among partners; yet little current HCI work is addressing this demand, or bedroom as a space in general. Hopefully, paper-like displays — without which a system like Bedtime Window would not be possible — will open new spaces and endeavours for systems and application to connect and entertain people.

7.1 Future work

7.1.1 Bedtime Window

The Bedtime Window is a complex system with several features, and some of the outstanding questions were already hinted in the study limitations in 6.5.3. We have seen that many qualities of an always-on video system can be retained using slow photo stream, with an additional benefit of increased sense of privacy. On the other hand, Pujol & Umemuro whose system sent just a few photos per day have not mentioned any feeling of remote presence [203], which suggests there is a point where the presence feeling ceases and which is currently unknown.

Personally, I am very encouraged to further research the real-time shared inking as a means of communication, not only in private spaces, but also in the working environment or in public spaces, and with multiple users involved simultaneously. The handwriting interactions and annotations could potentially be subjected to discourse analysis and compared to the elements and dynamics of spoken conversation. From linguistics and psychology point of view, it offers a unique probe into language development between individuals.

An intriguing experience from the autobiographic design that was eventually cut from the final field deployment was making the display adapt to the light in remote location and controlling the remote display behaviour. The affordances of light as a communication channel in this sense would also be interesting to explore in future work.

Finally, I have identified and tried to address a gap in the supporting technologies for partners in long-distance relationship by sharing bedtime and falling asleep and waking up together or to each other. How the Bedtime Window addresses this need in relationships with large time differences remains yet to be evaluated.

7.1.2 Paper-like Algorithm

Moving a level up, there are many ways to extend the presented work on displays mimicking reflective surfaces.

7.1.2.1 Future display technologies

The paper-like algorithm is easily applicable to emerging and upcoming display technologies, which can further extend the range and speed of the display adaptation as well as power savings.

For example, data from the study in Chapter 5 show that at least 86 % of the time the device could be turned off completely and save power without any impact on user's experience, because it is dark, while automatically coming back on when it is light again, enabling the users to glance at the display at will. OLED displays would result in further power savings compared to when the display is in the 'normal' mode, as OLEDs consume power in proportion to the brightness they emit.

Furthermore, they have no minimum backlight limitations. Since the performance of the algorithm depends only on the capabilities of the display such as its dynamic range and colour gamut, it should perform even better with OLED displays, without any further modifications.

One of the limitations of the algorithm as presented is its dependence on 3 display primaries (typically red, green and blue). The colour gamut of displays can be extended with additional primaries, such as yellow and cyan. Cheng et al. [260] have prototyped such LCD, and Sharp's Quattron technology with extra yellow primary is currently available in commercial TVs⁸⁵.

Quantum dot technology can offer arbitrary primaries, and one can envision a display that has a different, adjustable primary for each pixel. For such technologies, the algorithm would have to be redesigned to fully take advantage of the display's capabilities.

It is also worth mentioning that some backlight mechanisms are not global, for example a display can be split into four quadrants with individually controllable backlight, or when the backlight is realized using full array of white LEDs that can be controlled individually (a feature known as *local dimming*, see e.g. [261] for an overview in the context of commercial TVs). The paper-like algorithm currently cannot take advantage of such configurations; however, I would suggest that rather than trying to achieve the qualities of a reflective medium, these features are trying to boost the contrast of the displays in the very opposite direction, in a way that reflective medium cannot easily achieve.

⁸⁵ <http://www.aquos-world.com/>

Last, notice that the discussed paper-like algorithm relies on one light sensor, sensing the conditions at one particular point on the device surface and assuming that the same light falls on the whole surface of the display. To fully mimic a reflective surface, especially on large displays, it would be desirable to have light sensing in each pixel, so that cast shadows can be reacted to appropriately. In fact, large public displays use matrices of large LEDs that could easily accommodate light sensor in or next to each LED.

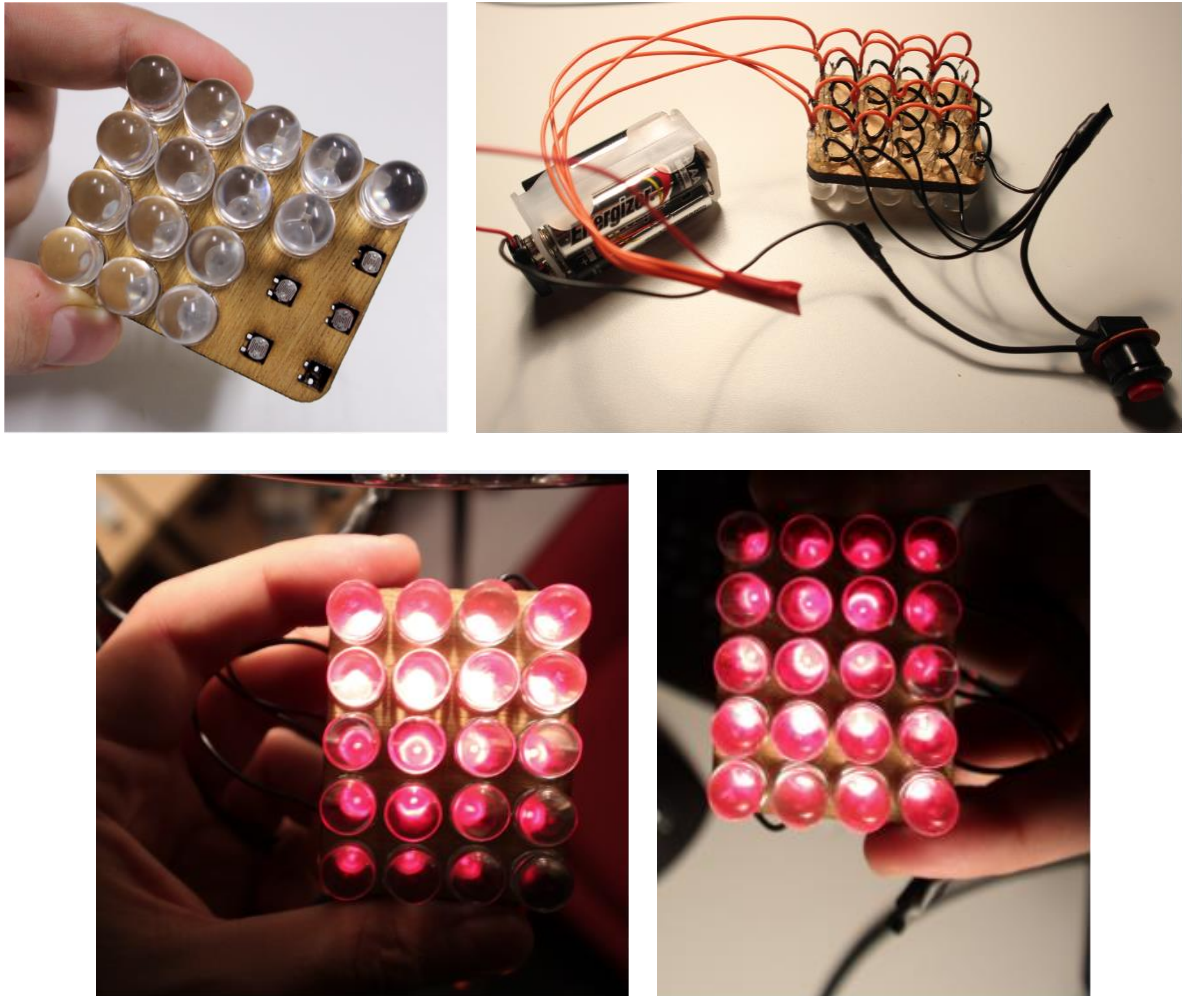

Figure 7.1. Analogue prototype of the paper-like response with separate light sensor per each pixel.

I tried to build a proof-of-concept of such arrangement using 20 LEDs. It takes advantage of crystal clear, big LEDs that emit red light to the front while they still allow incident light to come through to the back where simple photo-resistor is regulating the power input to the LEDs. It does not match chromaticity, but the brightness matching does a surprisingly effective job even without trying to match the resistor value to a hypothetical reflective surface. In Figure 7.1 bottom, all LEDs are fully powered, but half of the “display” is under lamp shade. It is challenging to capture the

effect as it behaves just as one would expect – it shows shadows⁸⁶. Since chromatic matching is practically a series of matrix multiplications, it should be possible to implement the whole algorithm using analogue hardware components directly, with nanoseconds latency and minimal power requirements.

7.1.2.2 Partial calmness

One of the future aspects of calm technology and especially its interpretation in displays as proposed in this thesis that I am particularly intrigued about is the idea of partial calmness. In HCI, calm technology is perceived as a binary quality – either something is calm, or it is not, regardless of what ‘calm’ may mean to particular people. We can discuss about when and how to transition between the background and foreground, but is there a state in-between, a *partially calm* technology, and what can it bring us?

The way how we introduced calmness into displays in this work offers two concrete interpretations of partial calmness. First, we have two display possible display settings – ‘normal’ display and ‘paper-like’ display. The nature of these settings allows us to have values in between, e.g. half-way what the normal settings would be and half-way what the algorithm suggests a reflective medium should look like. We are, however, already familiar with surfaces that are reflective but also partially emissive in the real world: we call that *fluorescence*. The paper-like displays give us a unique tool to study human perception of fluorescence, and explore what qualities and properties does surface have to have in order to be perceived as fluorescent. And we can potentially make displays look fluorescent.

The other interpretation is to look at individual pixels, something that could be called *per-pixel calmness*. In other words, some pixels of the display would behave like normal emissive display, while other pixels would have the paper-like settings applied. Note that this technique requires not having a global backlight control, i.e. it can only work with OLED displays and alike. It is easy to see that if one has a display surface that looks like a paper, leaving some area of it at the ‘normal’ display mode effectively gives us the ability to have a non-rectangular display. However, using the paper-like algorithm to achieve this effect gives us an opportunity to change the shape of the display dynamically at runtime, rather than at manufacture time.

⁸⁶ Note that light sensing per pixel technique could be also used the other way to compensate for shadows.

Finally, combining these two interpretations of partial calmness, one can envision another channel for display pixels: the same way Alvy Ray Smith invented the alpha channel for transparency [262], we can add another channel for calmness. And by associating different pixels with different calibration settings, we make a step towards mimicking different physical materials on the screen. Pieces of sticky notes on fluorescent paper is just the beginning.

7.1.2.3 Working environment⁸⁷

In this thesis, we mostly focused on applications in the home environment, especially bedrooms. However, nothing stops us from deploying calm displays into the working environment, and I adapted the algorithm to work with desktop monitors to run a simple preliminary probe into such experience [263].

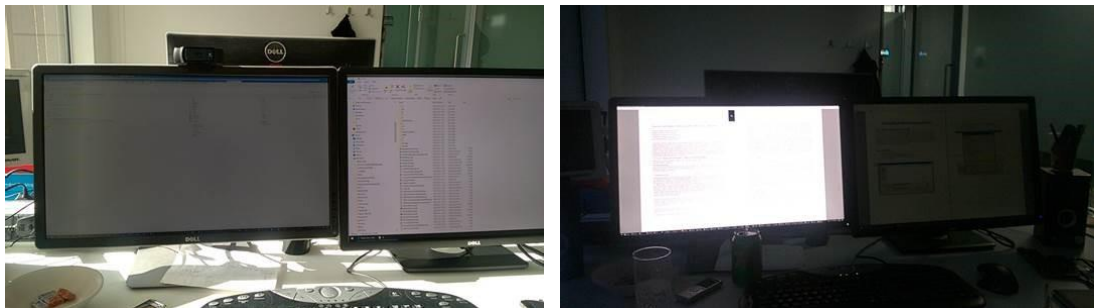

Figure 7.2. Paper-like display algorithm running on a secondary desktop screen (right monitor in both photos). Left displays are the same brightness in both photos, direct sunlight on the left, working at night on the right.

The calm display would naturally become brighter than the normal monitor under direct sun and darker at night (see Figure 7.2). The fact that the screen was a second monitor made it incredibly easy to move windows from the main, active screen into the periphery of the paper-like screen, very much to the seamless requirement of Weiser's calm technology. Perhaps if ambient displays around us would all be natural extensions of the devices with interact with every day like computers, it would increase their usually limited utility.

While the calm display had the ambient display qualities, it made clear that then normal displays could do better in terms of adapting – there is no reason why adaptive brightness (or partial calmness) should be limited to mobile phones only. It also turned out that various colour schemes aiming at reducing the tiring nature of displays (such as white text on black background, which is not a common practise on paper media), can interfere with the readability when shown on paper-

⁸⁷ Some of these proposals and discussions have been presented at UbiTtention workshop [199].

like screen. Calm applications therefore need to take into account not only the environmental conditions but also how the system is responding to them and adapt.

This brings us to the idea of calm applications. The same way we have a power-saving mode on the devices, a similar attention-saving mode could be introduced that applications could detect and adjust their behaviour in order to meet the user's explicit request for staying in the background.

Some examples on how various applications could take an advantage of such mode include:

1. Message rate, verbosity & filtering: Some applications (such as code compilers or slack) are source of continuous messages that could be adjusted or filtered based on importance or condition on keywords to break through the calm mode.
2. Colour schemes, animations & transitions: Applications could be more considerate with colour choices and animation parameters. Sometimes sudden transition is better than a slow one, or the application could update the user interface only when user is not present.
3. Audio, transcriptions & spatial: Video applications with audio output could lower the volume or switch to automatic transcription. The audio output should be adjusted to come from the place where the video window is located.

Many of these adaptations are non-binary and could take an advantage of a continuous calmness scale.

7.1.3 Future Work in Vision Science

Finally, moving to the level of human vision and perception, the colour matching study in this thesis, being the first work into both cross-media matching and matching under extreme chromatic conditions, opens many follow up questions. Due to the time demanding nature of the task, compromise had to be found between the number of conditions and numbers of observers and their engagement. More conditions would be needed to infer a usable model of colour differences perception. For example, all conditions in this work were of more or less the same luminance level.

It would also be interesting to compare the results to a forced binary choice design (i.e. match vs. not a match). Unlike in traditional colour-matching experiments, having a display and spectrally tunable lights would allow us to realize such study, however, a staircase method equivalent in three-dimensional space would need to be developed.

Learning about human vision for scenarios like paper-like displays required an extreme violation of one of the core principles of colour science – standardised, strict lighting conditions. In the matching experiment in this thesis, the lighting was chromatic, but still fixed and well-defined per condition. Imagine, however, if observers adjusted the light, not the display, to match the reflected light from paper to a fixed colour on the display. In both cases, the effect of observer's adaptation on the matching results, as well as the chromatic limits of adaptation remain unclear.

Of course, there are higher level questions too. Some observers in this work's set-up were already confused about which surface is the display and which one is the paper. While that is an encouraging observation for paper-like display applications, it poses further questions about what makes a surface perceived as reflective or emissive. The new opportunity to research human perception of fluorescence has been already mentioned above.

Last, but not least, as an HCI researcher I cannot overlook the mechanisms of colour space navigation by observers, which seem to be based on best guesses rather than any usability study. During the course of my PhD, I had various users navigate RGB, Yu'v', and CIE LAB spaces. My experience suggests that beyond RGB being clearly the worst to navigate for untrained observers (note that RGB was used in the early matching experiments), the differences between the others and/or the effect they might have on results is debatable. The same goes for the user interaction with the game controller, which could be buttons or joystick, both with linear or accelerated behaviour, and might differ for people with and without gaming experience. An HCI study to inform the navigational tasks in colour science is long overdue.

7.2 Responding to Research Questions

A few research questions were stated in the introduction to this thesis (1.2), and we should now be able to address them.

- *How can we make current displays calm, blend naturally into the environment, but stay useful and valuable when not used?*

We can make displays sense the environment and let them blend in physically, just like a piece of paper does. They can remain fully responsive, interactive and present information without being distracting.

- *Can we make displays just as unobtrusive as paper or other physical materials, yet retain their information flow qualities and interactivity?*

We indeed can; in this thesis it was achieved by a paper-like algorithm that uses off-the-shelf RGB sensor to sense the environment in real-time, and with one-time calibration step. Common limitations that impede such efforts were identified and they are often arbitrarily imposed by manufacturers of software and hardware (minimum brightness levels, slow response times, no absolute units).

- *How do humans perceive colour differences between emissive and reflective surfaces, and under non-standard lighting conditions?*

The experiments presented in this thesis suggest that emissive and reflective surfaces can be confusable. The cross-media colour discrimination thresholds between reflective and emissive surfaces are higher than for the same surfaces under strict standardized conditions. The discrimination threshold is lower for hue than for chroma, but the chroma differences may be masked by luminance differences.

- *What new applications and experiences can such displays bring to us?*

The studies in this thesis showed that displays running a paper-like algorithm are acceptable in bedrooms, and a novel application connecting remote partners during bedtime was presented, addressing the needs of couples in long-distance relationships.

7.3 Applications in Other Domains

Bedroom is not the only space that could benefit from the technologies presented in this thesis. We have already touched upon other spaces that have challenging light requirements in the introduction, including cinemas, theatres, or even places of worship. We have also seen attempts at using displays for art installations in both homes and public spaces, and the negative perception of public when such displays are turned off. All of these challenges could benefit from paper-like display technology. Paper-like displays could match the surrounding patterns of wallpapers and textiles to make the display visually disappear fully or partially, finding their potential use in wearables and fashion.

Another aspect driving the application of paper-like displays is decreasing the attention demand and cognitive load of the users. In very information-busy environments such as control centres, newsrooms or monitoring stations, paper-like displays can keep information at hand in the

periphery, while allowing operators to focus on what is important by transitioning into normal, transmissive displays as needed. The reduced intrusiveness can also be used in healthcare and social care, where constant monitoring is required by professionals without compromising the comfort of users.

Finally, the paradigms introduced by the Bedtime Window can also find use cases in remote healthcare, education, social services, or elder care – wherever the need to balance privacy with interactivity and feeling of connectedness exists.

7.4 Summary

Coming back to Weiser's vision of calm technology, this thesis demonstrated that even existing emissive display technologies are capable of mimicking calm piece of paper, and that this approach makes them less distracting and blend easily into the periphery, to the extent that they become acceptable in peoples' bedrooms. This makes displays eligible to be part of calm technology systems and designs, providing rich output and fast interactivity, as well as unobtrusive when not used in the periphery of our environments.

References

- [1] J. N. Brown, *Anthropology-Based Computing: Putting Human in Human-Computer Interaction*, Cham: Springer, 2016.
- [2] P. D. Adamczyk and B. P. Bailey, "If Not Now, When? The Effects of Interruption at Different Moments within Task Execution," in *Proceedings of the SIGCHI Conference on Human Factors in Computing Systems*, Vienna, 2004.
- [3] A. Case, *Calm Technology - Principles and patterns for non-intrusive design*, Sebastopol: O'Reilly Media, 2016.
- [4] N. Davies, S. Clinch, M. Mikusz, O. Bates, H. Turner and A. Friday, "Better Off: When Should Pervasive Displays be Powered Down?," in *PerDis '17: Proceedings of the 6th ACM International Symposium on Pervasive Displays*, Lugano, 2017.
- [5] M. Weiser, "The Computer for the 21st Century," *Scientific American*, vol. 3, no. 265, pp. 94-104, 1991.
- [6] M. Weiser and J. S. Brown, "Designing Calm Technology," *PowerGrid Journal*, vol. 1.01, 1996.
- [7] S. Consolvo and J. Towle, "Evaluating an ambient display for the home," in *CHI EA '05 CHI '05 Extended Abstracts on Human Factors in Computing Systems*, New York, 2005.
- [8] Y. Rogers, "Moving on from Weiser's Vision of Calm Computing: Engaging UbiComp Experiences," in *Proceedings of the 8th international conference on Ubiquitous Computing*, Berlin, 2006.
- [9] G. Bell and P. Dourish, "Yesterday's tomorrows: notes on ubiquitous computing's dominant vision," *Personal and Ubiquitous Computing*, vol. 11, no. 2, pp. 133-143, 2007.
- [10] G. D. Abowd, "What next, UbiComp? Celebrating an intellectual disappearing act," in *Proceedings of the 2012 ACM Conference on Ubiquitous Computing*, Pittsburgh, 2012.

- [11] S. Bakker, D. Hausen and T. Selker, *Peripheral Interaction: Challenges and Opportunities for HCI in the Periphery of Action*, Cham: Springer, 2016.
- [12] J. Riecki, P. Isomursu and M. Isomursu, "Evaluating the Calmness of Ubiquitous Applications," in *Proc. of 5th International Conference on Product Focused Software Process Improvement*, Kansai Science City, 2004.
- [13] J. N. Brown, P. S. Bayerl, A. Fercher, G. Leitner, A. C. Mallofré and M. Hitz, "A Measure of Calm," in *Peripheral Interaction: Shaping the Research and Design Space. Workshop at CHI'14*, Toronto, 2014.
- [14] R. M. Carvalho, R. M. Andrade and K. M. Oliveira, "Using the GQM Method to Evaluate Calmness in Ubiquitous Applications," in *Distributed, Ambient, and Pervasive Interactions*, Cham, Springer, 2015, pp. 13-24.
- [15] R. Mantiuk, A. G. Rempel and W. Heidrich, "Display Considerations for Night and Low-Illumination Viewing," in *Proceedings of the 6th Symposium on Applied Perception in Graphics and Visualization*, New York, 2009.
- [16] A. Durrant, D. Frohlich, A. Sellen and E. Lyons, "Home curation versus teenage photography: Photo displays in the family home," *International Journal of Human-Computer Studies*, vol. 67, no. 12, pp. 1005-1023, 2009.
- [17] J. Häkkinä, Y. Dubovskaya, J. Gabauer, N. Hailuoto, L. Stolz, M. Posti and A. Colley, "Developing an Interactive Social Cinema Concept with a Tangible UI," in *Proceedings of the 13th International Conference on Mobile and Ubiquitous Multimedia*, Melbourne, 2014.
- [18] B. Viola, Artist, *Martyrs (Earth, Air, Fire, Water)*. [Art]. St Paul's Cathedral, 2014.
- [19] C. Bavor, "A Canvas Made of Pixels," 27 December 2017. [Online]. Available: <https://www.claybavor.com/blog/a-canvas-made-of-pixels>. [Accessed 3 March 2020].
- [20] MarketsandMarkets, "Smart Lighting Market by Offering (Hardware: Lights & Luminaires, Lighting Controls; Software, and Services), Communication Technology (Wired and Wireless), Installation Type, End-use Application, and Geography - Global Forecast to 2025," MarketsandMarkets™ INC., Northbrook, 2020.

- [21] I. S. Newton, *Opticks: or, A treatise of the reflexions, refractions, inflexions and colours of light.*, London: Royal Society, 1704.
- [22] A. I. Sabra, *Theories of Light: From Descartes to Newton*, 2nd ed., Cambridge: Cambridge University Press, 1981.
- [23] J. C. Maxwell, "VIII. A dynamical theory of the electromagnetic field," *Philosophical Transactions*, vol. 155, pp. 459-512, 1865.
- [24] CIE, "CIE 15:2004 Colorimetry," Vienna, 2004.
- [25] T.-P. Cheng, *Einstein's Physics: Atoms, Quanta, and Relativity Derived, Explained, and Appraised*, Oxford: Oxford University Press, 2013.
- [26] T. L. Dimitrova and A. Weis, "The wave-particle duality of light: A demonstration experiment," *American Journal of Physics*, vol. 76, no. 2, pp. 137-142, 2008.
- [27] J. Kremers, R. C. Baraas and N. J. Marshall, Eds., *Human Color Vision*, Cham: Springer International Publishing, 2016.
- [28] A. B. Kerlin, L. A. DeSilva, S. Rose and J. E. Hasbun, "Calculating the Sun's Photospheric Temperature, an Undergraduate Physics Laboratory," *Georgia Journal of Science*, vol. 74, no. 2, 2016.
- [29] J. Schanda, Ed., *Colorimetry: Understanding the CIE System*, New Jersey: John Wiley & Sons, Inc., 2007.
- [30] R. Hunt and M. Pointer, *Measuring Colour*, 4th ed., Chichester: John Wiley & Sons, Ltd, 2011.
- [31] K. Nassau, *The Physics and Chemistry of Color: The Fifteen Causes of Color*, 2nd ed., New York: John Wiley & Sons Inc, 2001.
- [32] P. Jaiswal, S. N. Jha and R. Bharadwaj, "Non-destructive prediction of quality of intact banana using spectroscopy," *Scientia Horticulturae*, vol. 135, pp. 14-22, 2012.
- [33] P. Yuan, R. Chen, Y. Su, B. Fan and X. Wang, "Characteristic parameters of positive cloud-to-ground lightning channel," *Journal of Earth System Science*, vol. 128, no. 6, 2019.

- [34] CIE Standard, *Colorimetry -- Part 2: CIE standard illuminants*, CIE International Commission on Illumination, 2006.
- [35] N. T. Ingram, A. P. Sampath and G. L. Fain, "Why are rods more sensitive than cones?," *The Journal of Physiology*, vol. 594, no. 19, pp. 5415-5426, 2016.
- [36] D.-G. Luo, V. Kefalov and K.-W. Yaou, "Phototransduction in Rods and Cones," in *The Senses: A Comprehensive Reference*, vol. 1, Academic Press, 2008, pp. 269-301.
- [37] C. A. Curcio, K. R. Sloan, R. E. Kalina and A. E. Hendrickson, "Human Photoreceptor Topography," *The Journal of Comparative Neurology*, vol. 292, pp. 497-523, 1990.
- [38] G. Osterberg, "Topography of the layer of rods and cones in the human retina," *Acta Ophthalmologica*, vol. 13, no. S6, pp. 1-103, 1935.
- [39] J. Chen, W. Cranton and M. Fihn, Eds., *Handbook of Visual Display Technology*, Cham: Springer International Publishing, 2016.
- [40] A. P. Schachar, Ed., "Color Vision and Night Vision," in *Ryan's Retina*, 6th ed., vol. 1, Elsevier, 2018, pp. 325-339.
- [41] J. L. Nerger and C. M. Cicerone, "The Ratio of L Cones to M Cones in the Human Parafoveal Retina," *Vision Research*, vol. 32, no. 5, pp. 879-888, 1992.
- [42] C. A. Curcio, K. A. Allen, K. R. Sloan, C. L. Lerea, J. B. Hurley, I. B. Klock and A. H. Milam, "Distribution and Morphology of Human Cone Photoreceptors Stained With Anti-Blue Opsin," *The Journal of Comparative Neurology*, vol. 132, pp. 610-624, 1991.
- [43] D. K. Lynch and W. Livingston, *Color and Light in Nature*, 2nd ed., Cambridge: Cambridge University Press, 2001, p. 292.
- [44] D. H. Sliney, R. T. Wangemann, J. K. Franks and M. L. Wolbarsht, "Visual sensitivity of the eye to infrared laser radiation," *Journal of the Optical Society of America*, vol. 1976, no. 4, pp. 339-341, 1976.
- [45] A. B. Watson, "A formula for human retinal ganglion cell receptive field density as a function of visual field location," *Journal of Vision*, vol. 14, no. 7, pp. 1-17, 2014.

- [46] E. Yamada, "Some Structural Features of the Fovea Centralis in the Human Retina," *Arch Ophthalmol.*, vol. 82, no. 2, pp. 151-159, 1969.
- [47] A. Stockman and D. H. Brainard, "Fundamentals of color vision I: color processing in the eye," in *Handbook of Color Psychology*, Cambridge, Cambridge University Press, 2015, pp. 27-69.
- [48] H. Strasburger, I. Rentschler and M. Jüttner, "Peripheral vision and pattern recognition: A review," *Journal of Vision*, vol. 11, no. 5, pp. 1-82, 2011.
- [49] S. Beatty, M. Boulton, D. Henson, H.-H. Koh and I. J. Murray, "Macular pigment and age related macular degeneration," *British Journal of Ophthalmology*, vol. 83, no. 7, pp. 867-877, 1999.
- [50] A. Stockman, L. T. Sharpe and C. C. Fach, "The spectral sensitivity of the human short-wavelength cones.," *Vision Research*, vol. 39, pp. 2901-2927, 1999.
- [51] A. Stockman and L. T. Sharpe, "Spectral sensitivities of the middle- and long-wavelength sensitive cones derived from measurements in observers of known genotype," *Vision Research*, vol. 40, pp. 1711-1737, 2000.
- [52] T. Young, "II. The Bakerian Lecture. On the Theory of Lights and Colours," *Philosophical Transactions*, vol. 92, pp. 12-48, 1802.
- [53] H. v. Helmholtz, *Handbuch der physiologischen Optik*, Leipzig: Leopold Voss, 1867.
- [54] J. C. Maxwell, "On the Theory of Compound Colours, and the Relations of the Colours of the Spectrum," *Philosophical Transactions of the Royal Society of London*, vol. 150, pp. 57-84, 1860.
- [55] F. C. Donders, "Ueber Farbensysteme," *Albrecht von Graefes Archiv für Ophthalmologie*, vol. 27, no. 1, pp. 155-223, 1881.
- [56] A. König and C. Dieterici, "Die Grundempfindungen in normalen und anomalen Farbensystemen und ihre Intensitätsverteilung im Spektrum," *Zeitschrift für Psychologie und Physiologie der Sinnesorgane*, vol. 4, pp. 241-347, 1893.

- [57] W. d. W. Abney, "X. Modified Apparatus for the Measurement of Colour and its Application to the Determination of the Colour Sensations," *Philosophical Transactions of the Royal Society*, vol. 205, pp. 333-355, 1905.
- [58] L. T. Troland, "The Present Status of Visual Science," *Bulletin of the National Research Council*, vol. 5, no. 27, pp. 1-120, 1922.
- [59] L. T. Troland, "Report of Committee on Colorimetry for 1920-1921," *Journal of the Optical Society of America and Review of Scientific Instruments*, vol. VI, no. 6, pp. 527-596, 1922.
- [60] H. E. Ives, "The transformation of color-mixture equations from one system to another," *Journal of the Franklin Institute*, vol. 180, no. 6, pp. 673-701, 1915.
- [61] J. Guild, "V. The Colorimetric Properties of the Spectrum," *Philosophical Transactions of the Royal Society of London*, vol. 230, pp. 149-187, 1932.
- [62] J. Guild, "A trichromatic colorimeter suitable for standardisation work," *Transactions of the Optical Society*, vol. 27, no. 106, pp. 106-129, 1925.
- [63] W. D. Wright, "A Trichromatic Colorimeter with Spectral Primaries," *Transactions of the Optical Society*, vol. 29, pp. 225-242, 1928.
- [64] W. D. Wright, "A Re-Determination of the Mixture Curves of the Spectrum," *Transactions of the Optical Society*, vol. 31, pp. 201-218, 1930.
- [65] W. D. Wright, "A re-determination of the trichromatic coefficients of the spectral colours," *Transactions of the Optical Society*, vol. XXX, no. 4, pp. 141-159, 1928-29.
- [66] H. S. Fairman, M. H. Brill and H. Hemmendinger, "How the CIE 1931 Color-Matching Functions Were Derived from Wright-Guild Data," *COLOR research and application*, vol. 22, no. 1, pp. 11-23, 1997.
- [67] J. J. Vos, "Colorimetric and Photometric Properties of a 2° Fundamental Observer," *COLOR research and application*, vol. 3, no. 3, pp. 125-128, 1978.

- [68] W. Stiles and J. M. Burch, "Interim Report to the Commission Internationale de l'Eclairage, Zurich, 1955, on the National Physics Laboratory's Investigation of Colour-matching (1955)," *Optica Acta: International Journal of Optics*, vol. 2, no. 4, pp. 168-181, 1955.
- [69] P. Trezona, "Individual observer data for the 1955 Stiles–Burch 2° pilot investigation," *Journal of the Optical Society of America A*, vol. 4, no. 4, pp. 769-782, 1987.
- [70] W. S. Stiles and J. M. Burch, "NPL colour-matching investigation: Final Report," *Optica Acta*, vol. 6, pp. 1-26, 1959.
- [71] N. I. Speranskaya, "Determination of spectrum color coordinates for twenty-seven normal observers," *Optics and Spectroscopy*, vol. 7, pp. 424-428, 1959.
- [72] A. Stockman, L. T. Sharpe and C. Fach, "The spectral sensitivity of the human short-wavelength sensitive cones derived from thresholds and color matches," *Vision Research*, vol. 39, no. 17, pp. 2901-2927, 1999.
- [73] A. Stockman and L. T. Sharpe, "The spectral sensitivities of the middle- and long-wavelength-sensitive cones derived from measurements in observers of known genotype," *Vision Research*, vol. 40, no. 13, pp. 1711-1737, 2000.
- [74] International Committee for Display Metrology, *Information Display Measurements Standard*, Campbell: Society for Information Display, 2012.
- [75] J. Barsotti, D. Smith and L. Heberlein, "SMPTE Conference - Issues in Color Matching," in *The 2012 Annual Technical Conference & Exhibition*, Hollywood, 2012.
- [76] G. Dalvi, "Digital Typography - 2," IDC, IIT Bombay, 5 August 2015. [Online]. Available: <http://www.dsource.in/course/digital-typography-2/screen-types>. [Accessed 24 March 2020].
- [77] F. Nielsen, *Visual Computing: Geometry, Graphics, and Vision*, Charles River Media / Thomson Delmar Learning, 2005.

- [78] S. Bianco and R. Schettini, "Two new von Kries based chromatic adaptation transforms found by numerical optimization," *Color Research & Application*, vol. 35, no. 3, pp. 184-192, 2010.
- [79] G. T. Fechner, *Elemente der psychophysik*, Leipzig: Breitkopf und Härtel, 1860.
- [80] K. Deshpande, "N-colour separation methods for accurate reproduction of spot colours," University of the Arts London, PhD thesis, 2015.
- [81] P. Cruse, "Printing Specifications: Part 2 - ISO, FOGRA, etc.," Graphic Quality Consultancy, 31 January 2019. [Online]. Available: https://www.colourphil.co.uk/iso_swop_gracol.shtml. [Accessed 13 August 2019].
- [82] R. G. Kuehni, "Historical Development of Color Space and Color Difference Formulas," in *Color Space and Its Divisions: Color Order from Antiquity to the Present*, John Wiley & Sons, Inc., 2003, pp. 204-270.
- [83] D. B. Judd, "Chromaticity Sensibility to Stimulus Differences," *Journal of the Optical Society of America*, vol. 22, no. 2, pp. 72-108, 1932.
- [84] D. L. MacAdam, "Projective Transformations of I. C. I. Color Specifications," *Journal of the Optical Society of America*, vol. 27, no. 8, pp. 294-299, 1937.
- [85] D. L. MacAdam, *Color Measurement: Theme and Variations*, Second Revised ed., New York: Springer-Verlag, 1985.
- [86] E. F. Schubert, *Light-Emitting Diodes*, New York: E. Fred Schubert, 2018.
- [87] R. G. Kuehni, *Color Space and Its Divisions: Color Order from Antiquity to the Present*, John Wiley & Sons, Inc., 2003.
- [88] S. Eddins, "Displaying a color gamut surface," The MathWorks, Inc., 03 04 2015. [Online]. Available: <https://blogs.mathworks.com/steve/2015/04/03/displaying-a-color-gamut-surface/>. [Accessed 19 03 2020].
- [89] M. R. Luo and B. Rigg, "Chromaticity-Discrimination Ellipses for Surface Colours," *COLOR research and application*, vol. 11, no. 1, pp. 25-42, 1986.

- [90] P.-C. Hung and R. S. Berns, "Determination of constant Hue Loci for a CRT gamut and their predictions using color appearance spaces," vol. 20, no. 5, pp. 285-295, 1995.
- [91] M. D. Fairchild, *Color appearance models*, Chichester: Wiley-IS&T, 2013.
- [92] A. R. Robertson, "Historical development of CIE recommended color difference equations," vol. 15, no. 3, pp. 167-170, 1990.
- [93] J. D. Mollon, "The Origins of Modern Color Science," in *The Science of Colour*, 2nd ed., S. K. Shevell, Ed., Oxford, Elsevier, 2003, pp. 1-39.
- [94] R. G. Kuehni, "The Early Development of the Munsell System," *COLOR research and application*, vol. 27, no. 1, pp. 20-27, 2002.
- [95] *International Directory of Company Histories*, vol. 53, St. James Press, 2003.
- [96] RAL Deutsches Institut für Gütesicherung und Kennzeichnung e. V., "RAL Colours history," 15 May 2013. [Online]. Available: http://toxid.ral-farben.de/fileadmin/pdf/RAL_History.pdf. [Accessed 8 July 2019].
- [97] M. Bass, C. DeCusatis, J. M. Enoch, V. Lakshminarayanan, G. Li, C. MacDonald, V. N. Mahajan and E. V. Stryland, Eds., *Handbook of Optics*, 3 ed., vol. III, McGraw-Hill Education, 2010.
- [98] E. Hering, "Hauptsätze einer neuen Theorie des Farbensinnes," in *Zur Lehre vom Lichtsinne*, Wien, Gerold, 1878, pp. 118-121.
- [99] L. M. Hurvich and D. Jameson, "An Opponent-Process Theory of Color Vision," *Psychological Review*, vol. 64, no. 6, pp. 384-404, 1957.
- [100] B. B. Lee, "Color coding in the primate visual pathway: a historical view," vol. 31, no. 4, p. A103—A112, Apr 2014.
- [101] P. K. Kaier, "The Joy of Visual Perception," York University, 7 February 2017. [Online]. Available: <http://www.yorku.ca/eye/opponent.htm>. [Accessed 21 March 2020].

- [102] A. M. Derrington, J. Krauskopf and P. Lennie, "Chromatic mechanisms in lateral geniculate nucleus of macaque.," vol. 357, no. 1, pp. 241-265, 1984.
- [103] D. H. Brainard, "Cone Contrast And Opponent Modulation Color Spaces," in *Human Color Vision*, Washington, DC, Optical Society of America, 1996, pp. 563-579.
- [104] P. DeMarco, J. Pokorny and V. C. Smith, "Full-spectrum cone sensitivity functions for X-chromosome-linked anomalous trichromats," vol. 9, no. 9, p. 1465—1476, Sep 1992.
- [105] P. K. Kaiser and R. M. Boynton, *Human Color Vision*, Washington, DC: Optical Society of America, 1996.
- [106] S. M. Sze and M. K. Lee, *Semiconductor Devices: Physics and Technology*, New York: John Wiley & Sons, Inc., 2012.
- [107] H. S. {Malvar}, {-w. He} and R. {Cutler}, "High-quality linear interpolation for demosaicing of Bayer-patterned color images," in *2004 IEEE International Conference on Acoustics, Speech, and Signal Processing*, 2004.
- [108] M. Born and E. Wolf, *Principles of optics*, Pergamon Press, 1980.
- [109] H. A. Macleod, *Thin-Film Optical Filters*, 3 ed., Bristol: Institute of Physics Publishing, 2001.
- [110] I. H. Blifford Jr., "Factors affecting the performance of commercial interference filters," *Appl Opt.*, vol. 1, no. 5, pp. 105-111, 1966.
- [111] ams AG, "Application Note: DN40-Rev 1.0 – Lux and CCT Calculations using ams Color Sensors," 26 Aug 2018. [Online]. Available: http://ams.com/documents/20143/80162/ColorSensors_AN000166_1-00.pdf. [Accessed 22 Jan 2020].
- [112] H. Widdel and D. L. Post, Eds., *Color in Electronic Displays*, New York: Springer Science+Business Media, 1992.
- [113] S. W. Depp and W. E. Howard, "Flat-Panel Displays," *Scientific American*, no. March, pp. 90-97, 1993.

- [114] H. G. Walton and D. Dunmur, "Liquid crystal display," Encyclopædia Briyannica, Inc., 03 August 2015. [Online]. Available: <http://www.britannica.com/technology/liquid-crystal-display>. [Accessed 10 March 2020].
- [115] D.-K. Yang and S.-T. Wu, *Fundamentals of Liquid Crystal Devices*, John Wiley & Sons, Ltd, 2015.
- [116] J.-H. Lee, D. N. Liu and S.-T. Wu, *Introduction to Flat Panel Displays*, John Wiley & Sons Ltd., 2008.
- [117] S. Nakamura, S. Pearton and G. Fasol, *The Blue Laser Diode: The Complete Story*, Springer-Verlag Berlin Heidelberg, 2000.
- [118] A. Shaik, "Light Emitting Diode (LED) - Working, Construction and Symbol - Diode," *Physics and Radio-Electronics*, 2017. [Online]. Available: <https://www.physics-and-radio-electronics.com/electronic-devices-and-circuits/semiconductor-diodes/lightemittingdiodeledconstructionworking.html>. [Accessed 11 March 2020].
- [119] V. K. Khanna, *Fundamentals of solid-state lightning: LEDs, OLEDs, and their applications in illumination and displays*, CRC Press, 2014.
- [120] X. Hou, Ed., *Design, Fabrication, Properties and Applications of Smart and Advanced Materials*, CRC Press, 2016.
- [121] Y. Wen, Z. Liu, W. Shi, Y. Jiang, A. M. Cheng, K. Le and Y. Wen, "Energy Efficient Hybrid Display and Predictive Models for Embedded and Mobile Systems," in *Proceedings of the 2012 International Conference on Compilers, Architectures and Synthesis for Embedded Systems*, Tampere, 2012.
- [122] M. Ford, "Differences Between 1st, 2nd, 3rd & 4th Gen Philips Hue Bulbs," *Hue Home Lighting*, 9 December 2019. [Online]. Available: <https://huehomelighting.com/key-differences-1st-2nd-3rd-gen-philips-hue-bulbs/>. [Accessed 28 January 2020].
- [123] M. Pratt, "Smart light bulbs: Philips Hue vs other smart lighting systems," *Which?*, 2018. [Online]. Available: <https://www.which.co.uk/reviews/light-bulbs/article/smart-light-bulbs/philips-hue-vs-other-smart-lighting-systems>. [Accessed 28 January 2020].

- [124] I. Chew, D. Karunatilaka, C. P. Tan and V. Kalavally, "Smart lighting: The way forward? Reviewing the past to shape the future," vol. 149, pp. 180 - 191, 2017.
- [125] T. v. Rooij and S. Bakker, "Plux: Exploring Light Settings through Hybrid Control," in *Proceedings of the Twelfth International Conference on Tangible, Embedded, and Embodied Interaction*, Stockholm, 2018.
- [126] B. Yu, J. Hu, M. Funk and L. Feijs, "DeLight: Biofeedback through Ambient Light for Stress Intervention and Relaxation Assistance," vol. 22, no. 4, 787–805 2018.
- [127] A.-M. Ortloff, L. Güntner, M. Windl, T. Schmidt, M. Kocur and C. Wolff, "SentiBooks: Enhancing Audiobooks via Affective Computing and Smart Light Bulbs," in *Proceedings of Mensch Und Computer 2019*, Hamburg, 2019.
- [128] J.-b. Woo and Y.-k. Lim, "User Experience in Do-It-Yourself-Style Smart Homes," in *Proceedings of the 2015 ACM International Joint Conference on Pervasive and Ubiquitous Computing*, Osaka, 2015.
- [129] M. Pavlovic, S. Colombo, Y. Lim and F. Casalegno, "Designing for Ambient UX: Case Study of a Dynamic Lighting System for a Work Space," in *Proceedings of the 2018 ACM International Conference on Interactive Surfaces and Spaces*, Tokyo, 2018.
- [130] A. Maiti and M. Jadliwala, "Light Ears: Information Leakage via Smart Lights," vol. 3, no. 3, Article 98 2019.
- [131] N. T. Ly, R. Tscharn, J. Preundefinedler, S. Huber, S. Aknine, A. Serna and J. Hurtienne, "Smart Lighting in Dementia Care Facility," in *Proceedings of the 2016 ACM International Joint Conference on Pervasive and Ubiquitous Computing: Adjunct*, Heidelberg, 2016.
- [132] C. Downey and S. W. Kamel, "Storytime with Hue: An Innovative Approach to Storytelling Where Storytellers Control a Dynamic Lighting Environment," in *Proceedings of the TEI '16: Tenth International Conference on Tangible, Embedded, and Embodied Interaction*, Eindhoven, 2016.

- [133] G. Finlayson, M. Mackiewicz, A. Hurlbert, B. Pearce and S. Crichton, "On calculating metamer sets for spectrally tunable LED illuminators," *Journal of the Optical Society of America A*, vol. 31, no. 7, p. 1583, 2014.
- [134] C. v. Trigt, "Smoothest reflectance functions. I. Definition and main results," *Journal of the Optical Society of America A*, vol. 7, no. 10, p. 1892, 1990.
- [135] B. Pearce, S. Crichton, M. Mackiewicz, G. D. Finlayson and A. Hurlbert, "Chromatic Illumination Discrimination Ability Reveals that Human Colour Constancy is Optimised for Blue Daylight Illumination," *PLOS ONE*, vol. 9, no. 2, p. 8, 2014.
- [136] S. Aston, "Spectral Fitting Procedures," in *Using an Illumination Discrimination Paradigm to Investigate the Role of Illumination Priors in Colour Perception*, Newcastle upon Tyne, Newcastle University, 2017, pp. 40-43.
- [137] C. Li and M. R. Luo, "The Estimation of Spectral Reflectances Using the Smoothness Constraint Condition," in *9th Color and Imaging Conference Final Program and Proceedings*, Scottsdale, 2001.
- [138] S. Ishihara, *The Series of Plates Designed as a Test for Colour-Blindness*, Tokyo: Kanehara Shuppan Co., Ltd., 1972.
- [139] A. C. Hurlbert, G. Gupta, N. Gross and R. Pastilha, "Colour constancy measured by achromatic adjustment in immersive illumination," *Journal of Vision*, vol. 19, no. 10, 2019.
- [140] K. Rolf G., "Variability in Unique Hue Selection: A Surprising Phenomenon," vol. 29, no. 2, pp. 158-162, 2004.
- [141] Y. Asano, M. D. Fairchild and L. Blondé, "Individual Colorimetric Observer Model," *PLOS ONE*, vol. 11, no. 2, pp. 1-19, 2016.
- [142] R. M. Boynton and C. X. Olson, "Salience of Chromatic Basic Color Terms Confirmed by Three Measures," *Vision Research*, vol. 30, no. 9, pp. 1311-1317, 1990.
- [143] L. T. Sharpe, A. Stockman, H. Jägle, H. Knau, G. Klausen, A. Reitner and J. Nathans, "Red, Green, and Red-Green Hybrid Pigments in the Human Retina: Correlations between

Deduced Protein Sequences and Psychophysically Measured Spectral Sensitivities," *Journal of Neuroscience*, vol. 18, no. 23, pp. 10053-10069, 1998.

- [144] A. Stockman and L. Sharpe, "Physiologically-based Colour Matching Functions," in *ISS/CIE Expert Symposium '06 "75 Years of the CIE Standard Colorimetric Observer"*, Vienna, 2006.
- [145] M. R. Luo, G. Cui and B. Rigg, "The Development of the CIE 2000 Colour-Difference Formula: CIEDE2000," *COLOR research and application*, vol. 26, no. 5, pp. 340-350, 2000.
- [146] D. B. Judd, "Ideal Color Space: II. The Super-Importance of Hue Differences and Its Bearing on the Geometry of Color Space," *Palette*, vol. 29, pp. 21-28, 1968.
- [147] M. V. Danilova and J. D. Mollon, "Superior discrimination for hue than for saturation and an explanation in terms of correlated neural noise," *Proceedings of the Royal Society B*, vol. 283, no. 20160146, pp. 1-9, 2016.
- [148] M. V. Danilova and J. D. Mollon, "Discrimination of hue angle and discrimination of colorimetric purity assessed with a common metric," vol. 37, no. 4, p. A226—A236, Apr 2020.
- [149] G. Gupta, N. Gross, R. Pastilha and A. Hurlbert, "The time course of color constancy by achromatic adjustment in immersive illumination: What looks white under coloured lights?," 2020.
- [150] Z. Pousman and J. Stasko, "A taxonomy of ambient information systems: four patterns of design," in *AVI '06 Proceedings of the working conference on Advanced visual interfaces*, New York, 2006.
- [151] J. Mankoff, A. K. Dey, G. Hsieh, J. Kientz, S. Lederer and M. Ames, "Heuristic evaluation of ambient displays," in *CHI '03 Proceedings of the SIGCHI Conference on Human Factors in Computing Systems*, New York, 2003.
- [152] A. K. Dey and E. d. Guzman, "From awareness to connectedness: the design and deployment of presence displays," in *CHI '06 Proceedings of the SIGCHI Conference on Human Factors in Computing Systems*, New York, 2006.

- [153] C. Plaue and J. Stasko, "Animation in a peripheral display: distraction, appeal, and information conveyance in varying display configurations," in *GI '07 Proceedings of Graphics Interface*, New York, 2007.
- [154] S. Zargham, J. Čalić and D. M. Frohlich, "4streams: an ambient photo sharing application for extended families," in *British HCI '15 Proceedings of the 2015 British HCI Conference*, New York, 2015.
- [155] E. J. J. Kirchner and J. Ravi, "Setting Tolerances on Color and Texture for Automotive Coatings," *Color Research & Applications*, vol. 39, no. 1, pp. 88-98, 2012.
- [156] H. Mangine, K. Jakes and C. Noel, "A Preliminary Comparison of CIE Color Differences to Textile Color Acceptability Using Average Observers," *COLOR research and application*, vol. 30, no. 4, pp. 288-294, 2005.
- [157] J. Park, "Engineered textile colour standards," *Coloration Technology*, vol. 123, no. 1, pp. 1-7, 2007.
- [158] S. J. Chu, R. D. Trushkowsky and R. D. Paravina, "Dental color matching instruments and systems. Review of clinical and research aspects," *Journal of Dentistry*, vol. 38, no. 2, pp. e2-e16, 2010.
- [159] T. Oskam, A. Hornung, R. W. Sumner and M. Gross, "Fast and Stable Color Balancing for Images and Augmented Reality," in *Proceedings of the 2012 Second International Conference on 3D Imaging, Modeling, Processing, Visualization & Transmission*, Washington, 2012.
- [160] A. Setkov, M. Gouiffès and C. Jacquemin, "Evaluation of color descriptors for projector-camera systems," *Journal of Visual Communication and Image Representation*, vol. 36, no. C, pp. 11-27, 2016.
- [161] M.-H. Lee, H. Park and J.-I. Park, "Fast radiometric compensation accomplished by eliminating color mixing between projector and camera," *IEEE Transactions on Consumer Electronics*, vol. 54, no. 3, pp. 987-991, 2008.

- [162] A. G. Rempel, W. Heidrich, H. Li and R. Mantiuk, "Video viewing preferences for HDR displays under varying ambient illumination," in *APGV '09 Proceedings of the 6th Symposium on Applied Perception in Graphics and Visualization*, New York, 2009.
- [163] R. Mantiuk, A. G. Rempel and W. Heidrich, "Display considerations for night and low-illumination viewing," in *APGV '09 Proceedings of the 6th Symposium on Applied Perception in Graphics and Visualization*, New York, 2009.
- [164] K. Devlin, A. Chalmers and E. Reinhard, "Visual calibration and correction for ambient illumination," *ACM Transactions on Applied Perception (TAP)*, vol. 3, no. 4, pp. 429-452, 2006.
- [165] K. Choi and H.-J. Suk, "User-preferred color temperature adjustment for smartphone display under varying illuminants," *Optical Engineering*, vol. 53, no. 6, p. 061708, 2014.
- [166] N. Na and H.-J. Suk, "Optimal Display Color for Nighttime Smartphone Users," *Color Research & Application*, vol. 42, no. 1, pp. 60-67, 2017.
- [167] J. Yu, Y. Chen and J. Li, "Color Scheme Adaptation to Enhance User Experience on Smartphone Displays Leveraging Ambient Light," *IEEE Transactions on Mobile Computing*, vol. 16, no. 3, pp. 688-701, 2017.
- [168] S. Lee, T. Park, J. Jang, W. Seo, T. Kim, J. Park, M. Lim and J. S. Baek, "Luminance and Gamma Optimization for Mobile display in Low ambient conditions," in *Image Quality and System Performance XII*, 2015.
- [169] H. Su, C. Jung, S. Wang and Y. Du, "Readability Enhancement of Displayed Images Under Ambient Light," *IEEE Transactions on Circuits and Systems for Video Technology*, vol. PP, no. 99, 2017.
- [170] W. Gaver, "The video window: my life with a ludic system," *Personal and Ubiquitous Computing*, vol. 10, no. 2-3, pp. 60-65, 2006.
- [171] P. Bourke, "Efficient Triangulation Algorithm Suitable for Terrain Modelling," in *Pan Pacific Computer Conference*, Beijing, 1989.

- [172] C. Ericson, *Real-Time Collision Detection*, CRC Press, 2004.
- [173] J. Shaltzer and M. Schröder, "The protection of information in computer systems," *Proceedings of the IEEE*, vol. 63, no. 9, pp. 1278-1308, 1975.
- [174] G. Kramer and C. Schierz, "Color Discrimination Subject to Illuminant and Color Transition," *Color Research and Application*, vol. 41, no. 5, pp. 457-467, 2016.
- [175] G. Sharma, Ed., *Digital Color Imaging Handbook*, New York: CRC Press, 2003.
- [176] D. L. MacAdam, "Visual Sensitivity to Color Differences in Daylight," *Journal of the Optical Society of America*, vol. 32, no. 5, pp. 247-274, 1942.
- [177] S. K. Shevell, Ed., *The Science of Color*, Oxford: Elsevier, 2003.
- [178] Y. Asano, *Individual Colorimetric Observers for Personalized Color Imaging*, Rochester: Rochester Institute of Technology, 2015.
- [179] M. Melgosa, A. Trémeau and G. Cui, "Colour Difference Evaluation," in *Advanced Color Image Processing and Analysis*, New York, Springer, 2013, pp. 59-79.
- [180] G. H. Freeman and J. H. Halton, "Note on an exact treatment of contingency, goodness of fit and other problems of significance," *Biometrika*, vol. 38, no. 1-2, pp. 141-149, 1951.
- [181] A. Case, *Calm Technology: Principles and Patterns for Non-Intrusive Design*, Sebastopol: O'Reilly Media, 2015.
- [182] K. Davis, E. Owusu, J. Hu, L. Marcenaro, C. Regazzoni and L. Feijs, "Promoting Social Connectedness through Human Activity-Based Ambient Displays," in *Proceedings of the International Symposium on Interactive Technology and Ageing Populations*, Kochi, 2016.
- [183] J. Schwarzer, S. Draheim, K. v. Luck, Q. Wang, P. Casaseca and C. Grecos, "Ambient Surfaces: Interactive Displays in the Informative Workspace of Co-located Scrum Teams," in *Proceedings of the 9th Nordic Conference on Human-Computer Interaction*, Gothenburg, 2016.
- [184] B. Shelton and K. Nesbitt, "Evaluating WaveWatch: an ambient display of web traffic," in *Proceedings of the Australasian Computer Science Week Multiconference*, Geelong, 2017.

- [185] Statistic Brain, "Long Distance Relationship Statistics – Statistic Brain," Statistic Brain Research Institute, 14 September 2017. [Online]. Available: <https://www.statisticbrain.com/long-distance-relationship-statistics/>. [Accessed 19 August 2018].
- [186] W.-C. Chien and M. Hassenzahl, "Technology-Mediated Relationship Maintenance in Romantic Long-Distance Relationships: An Autoethnographical Research through Design," *Humann-Computer Interaction*, vol. 00, pp. 1-48, 2017.
- [187] M. Hassenzahl, S. Heidecker, K. Eckoldt, S. Diefenbach and U. Hillmann, "All You Need is Love: Current Strategies of Mediating Intimate Relationships through Technology," *ACM Transactions on Computer-Human Interaction*, vol. 19, no. 4, pp. 30:1-19, 2012.
- [188] A. J. Merolla, "Relational Maintenance and Noncopresence Reconsidered: Conceptualizing Geopgraphic Separation in Close Relationships," *Communication Theory*, vol. 20, no. 2, pp. 169-193, 2010.
- [189] M. C. Pistole and A. Roberts, "Measuring Long-Distance Romantic Relationships: A Validity Study," *Measurement and Evaluation in Counselling and Development*, vol. 44, no. 2, pp. 63-76, 2011.
- [190] D. J. Canary and L. Stafford, "Maintaining Relationships through Strategic and Routine Interaction," in *Communication and Relational Maintenance*, San Diego, Academic Press, Inc, 1994, pp. 3-22.
- [191] F. ' . Mueller, F. Vetere, M. R. Gibbs, J. Kjeldskov, S. Pedell and S. Howard, "Hug Over a Distance," in *Extended abstracts of CHI 05*, Portland, 2005.
- [192] F. Gemperle, C. DiSalvo, J. Forlizzi and W. Yonkers, "The Hug: a New Form for Communication," in *Proceedings of the 2003 conference on Designing for user experiences*, San Francisco, 2003.
- [193] D. Kontaris, D. Harrison, E. -. E. Patsoule, S. Zhuang and A. Slade, "Feelybean: Communication Touch Over Distance," in *CHI '12 Extended Abstracts on Human Factors in Computing Systems*, Austin, 2012.

- [194] S. Singhal, C. Neustaedter, A. N. Antle and B. Matkin, "Flex-N-Feel: Emotive Gloves for Physical Touch Over Distance," in *Companion of the 2017 ACM Conference on Computer Supported Cooperative Work and Social Computing*, Portland, 2017.
- [195] H. A. Samani, R. Parsani, L. T. Rodriguez, E. Saadatian, K. H. Dissanayake and A. D. Cheok, "Kissenger: Design of a Kiss Transmission Device," in *Proceedings of the Designing Interactive Systems Conference*, Newcastle, 2012.
- [196] E. Saadatian, H. Samani, R. Parsani, A. V. Pandey, J. Li, L. Tejada, A. D. Cheok and R. Nakatsu, "Mediating intimacy in long-distance relationships using kiss messaging," *Int. J. Human-Computer Studies*, vol. 72, no. 10-11, pp. 736-746, 2014.
- [197] J. Werner, R. Wettach and E. Hornecker, "United-Pulse: Feeling Your Partner's Pulse," in *Proceedings of the 10th international conference on Human computer interaction with mobile devices and services*, Amsterdam, 2008.
- [198] C.-H. J. Lee and H. Chung, "Lover's cups: connecting you and your love one," in *ACM SIGGRAPH 2006 Research posters*, Boston, 2006.
- [199] R. Pan, S. Singhal, B. E. Riecke, E. Cramer and C. Neustaedter, "'MyEyes': The Design and Evaluation of First Person View Video Streaming for Long-Distance Couples," in *Proceedings of the 2017 Conference on Designing Interactive Systems*, Edinburgh, 2017.
- [200] R. Kowalski, S. Loehmann and D. Hausen, "cubble: A Multi-Device Hybrid Approach Supporting Communication in Long-Distance Relationships," in *Proceedings of the 7th International Conference on Tangible, Embedded and Embodied Interaction*, Barcelona, 2013.
- [201] Y. R. Joi, T. B. Jeong, J. H. Kim, K. H. Park, T. Lee and J. D. Cho, "WearLove: Affective Communication via Wearable Device with Gamification," in *Proceedings of the 2015 Annual Symposium on Computer-Human Interaction in Play*, London, 2015.
- [202] J. ' . Kaye, "I Just Clicked To Say I Love You: Rich Evaluations of Minimal Communication," in *CHI '06 Extended Abstracts on Human Factors in Computing Systems*, Montreal, 2006.

- [203] R. S. Pujol and H. Umemuro, "Productive Love Promotion via Affective Technology: An Approach Based on Social Psychology and Philosophy," *Human Technology: An Interdisciplinary Journal on Humans in ICT Environments*, vol. 6, no. 2, pp. 191-211, 2010.
- [204] S. Greenberg and C. Neustaedter, "Shared Living, Experiences, and Intimacy over Video Chat in Long Distance Relationships," in *Connecting Families: The Impact of New Communication Technologies on Domestic Life*, London, Springer-Verlag, 2013, pp. 37-53.
- [205] C. Neustaedter and S. Greenberg, "Intimacy in Long-Distance Relationships over Video Chat," in *CHI'12*, Austin, 2012.
- [206] U. Baishya, "In Your Eyes: Anytime, Anywhere Video and Audio Streaming for Couples," in *CSCW*, Portland, 2017.
- [207] E. Myodo, J. Xu, K. Tasaka, H. Yanagishara and S. Sakazawa, "Issues and Solutions to Informal Communication in Working from Home Using a Telepresence Robot," *ITE Transactions on MEdia Technology and Applications*, vol. 6, no. 1, pp. 30-45, 2018.
- [208] S. Harrison, Ed., *Media Space 20+ Years of Mediated Life*, London: Springer-Verlag, 2009.
- [209] C. Pang, A. Foghrani, E. Oduor, C. Neustaedter, I. Walker and D. Robinson, "Reactions to Mixed-Context Always-On Video for Connecting Close Personal and Work Contacts," Simon Fraser University, 2014.
- [210] J. S. Lee, S. Liang, S. Park and C. Yan, "Hi Grandpa!: A communication Tool Connecting Grandparents and Grandchildren Living Apart," in *Proceedings of the 17th International Conference on Human-Computer Interaction with Mobile Devices and Services Adjunct*, Copenhagen, 2015.
- [211] J. Lundell, M. Morris and S. Intille, "Home technologies to keep elders connected," in *CHI '04 Extended Abstracts on Human Factors in Computing Systems*, Vienna, 2004.
- [212] I. Keller, W. v. d. Hoog and P. J. Stappers, "Gust of me: reconnecting mother and son," *IEEE Pervasive Computing*, vol. 3, no. 1, pp. 22-27, 2004.

- [213] J. Farny, M. Jennex, R. Olsen and M. Rodriguez, "Anchor: connecting sailors to home," in *CHI '12 Extended Abstracts on Human Factors in Computing Systems*, Austin, 2012.
- [214] S. P. Wyche and M. Chetty, "'I want to imagine how that place looks': designing technologies to support connectivity between africans living abroad and home," in *Proceedings of the SIGCHI Conference on Human Factors in Computing Systems*, Paris, 2013.
- [215] C. Neustaedter, S. Harrison and S. Abigail, Eds., *Connecting Families*, London: Springer-Verlag, 2013.
- [216] D. Kirk, A. Sellen and X. Cao, "Home Video Communication: Mediating 'Closeness'," in *Proceedings of the 2010 ACM conference on Computer supported cooperative work*, Savannah, 2010.
- [217] T. K. Judge, C. Neustaedter and A. F. Kurtz, "The Family Window: The Design and Evaluation of a Domestic Media Space," in *CHI 2010*, Atlanta, 2010.
- [218] T. K. Judge, C. Neustaedter, S. Harrison and A. Blose, "Family portals: connecting families through a multifamily media space," in *Proceedings of the SIGCHI Conference on Human Factors in Computing Systems*, Vancouver, 2011.
- [219] E. Oduor and C. Neustaedter, "The family room: a multi-camera, multi-display family media space," in *Proceedings of the companion publication of the 17th ACM conference on Computer supported cooperative*, Baltimore, 2014.
- [220] C. Neustaedter, C. Pang, A. Forghani, E. Oduor, S. Hillman, T. K. Judge, M. Massimi and S. Greenberg, "Sharing Domestic Life through Long-Term Video Connections," *ACM Transactions on Computer-Human Interaction*, vol. 22, no. 1, pp. 3:1-3:29, 2015.
- [221] D. Wan, "Magic Wardrobe: Situated Shopping from your own Bedroom," *Personal Technologies*, no. 4, pp. 234-237, 2000.
- [222] W. Odom, J. Zimmerman, J. forlizzi, H. Choi and S. Meier, "Investigating the prsence, form and behavior of virtual poseessions in the context of a teen bedroom," in *Proceedings of the SIGCHI Conferece on Human Factors in Computing Systems*, Austin, 2012.

- [223] C. Dodge, "The Bed: A Medium for Intimate Communication," in *CHI '97 Extended Abstracts on Human Factors in Computer Systems*, Atlanta, 1997.
- [224] E. Goodman and M. Misilim, "The Sensing Beds," in *Proceedings of UbiComp 2003 Workshop*, Seattle, 2003.
- [225] T. Scherini, P. Melo, T. v. Craenendonck, W. Zou and M. Kaptein, "Enhancing the Sleeping Quality of Partners Living Apart," in *Proceedings of the 8th ACM Conference on Designing Interactive Systems*, Aarhus, 2010.
- [226] S. Kim, J. A. Kientz, S. N. Patel and G. D. Abowd, "Are You Sleeping? Sharing Portrayed Sleeping Status withing a Social Network," in *Proceedings of the 2008 ACM Conference on Computer supported cooperative work*, San Diego, 2008.
- [227] T. Salmela, A. Colley and J. Häkkinä, "Together in Bed? Couples' Mobile Technology Use in Bed," in *Proceedings of the 2019 CHI Conference on Human Factors in Computing Systems*, Glasgow, 2019.
- [228] E. K. Choe, S. Consolvo, J. Jung, B. Harrison and J. A. Kientz, "Living in a glass house: a survey of private moments in the home," in *Proceedings of the 13th international conference on Ubiquitous computing*, Beijing, 2011.
- [229] C. Neustaedter, S. Greenberg and M. Boyle, "Blur Filtration Fails to Preserve Privacy for Home-Based Video Conferencing," *ACM Transactions on Computer-Human Interaction*, vol. 13, no. 1, pp. 1-36, 2006.
- [230] M. Boyle and S. Greenberg, "The Language of Privacy: Learning from Video Media Space Analysis and Design," *ACM Transactions on Computer-Human Intearction*, vol. 12, no. 2, pp. 328-370, 2005.
- [231] Y. Heshmat, C. Neustaedter and B. DeBrincat, "The Autobiographical Design and Long Term Usage of an Always-On Video Recording System for the Home," in *Proceedings of the 2017 Conference on Designing Interactive Systems*, Edinburgh, 2017.

- [232] C. J. Sutherland, A. Luxton-Reilly and B. Plimmer, "Freeform digital ink annotations in electronic documents: A systematic mapping study," *Computers & Graphics*, vol. 55, pp. 1-20, 2015.
- [233] Y. Riche, H. N. Riche, K. Hinckley, S. Panabaker, S. Fuelling and S. Williams, "As We May Ink? Learning from Everyday Analog Pen Use to Improve Digital Ink Experiences," in *Proceedings of the 2017 CHI Conference on Human Factors in Computing Systems*, Denver, 2017.
- [234] G. Friedland, L. Knipping, R. Rojas and E. Tapia, "Teaching with an intelligent electronic chalkboard," in *Proceedings of the 2004 ACM SIGMM workshop on Effective telepresence*, New York, 2004.
- [235] D. Hindus, S. D. Mainwaring, N. Leduc, A. E. Hagström and O. Bayley, "Casablanca: Designing Social Communication Devices for the Home," in *Proceedings of the SIGCHI Conference on Human Factors in Computing Systems*, Seattle, 2001.
- [236] A. Sellen, R. Harper, R. Eardley, S. Izadi, T. Regan, A. S. Taylor and K. R. Wood, "HomeNote: Supporting Situated Messaging in the Home," in *Proceedings of the 2006 20th anniversary conference on Computer supported cooperative work*, Banff, 2006.
- [237] S. E. Lindley, R. Harper and A. Sellen, "Designing a Technological Playground: A Field Study of the Emergence of Play in Household Messaging," in *Proceedings of the SIGCHI Conference on Human Factors in Computing Systems*, Atlanta, 2010.
- [238] T. K. Judge, C. Neustaedter and S. Harrison, "Inter-Family Messaging with Domestic Media Spaces," in *Connecting Families*, London, Springer-Verlag, 2013, pp. 141-157.
- [239] J. C. Tang and S. L. Minneman, "VideoDraw: A Video Interface for Collaborative Drawing," *ACM Transactions on Information Systems*, vol. 9, no. 2, pp. 170-184, 1991.
- [240] J. C. Tang and S. L. Minneman, "VideoDraw: A Video Interface for Collaborative Drawing," in *Proceedings of the SIGCHI Conference on Human Factors in Computing Systems*, Seattle, 1990.

- [241] H. Ishii and M. Kobayashi, "ClearBoard: A Seamless Medium for Shared Drawing and Conversation with Eye Contact," in *Proceedings of the SIGCHI Conference on Human Factors in Computing Systems*, Monterey, 1992.
- [242] H. Ishii, M. Kobayashi and J. Grudin, "Integration of inter-personal space and shared workspace: ClearBoard design and experiments," in *Proceedings of the 1992 ACM conference on Computer-supported cooperative work*, Toronto, 1992.
- [243] H. Ishii, M. Kobayashi and J. Grudin, "Integration of interpersonal space and shared workspace: ClearBoard design and experiments," *ACM Transactions on Information Systems*, vol. 11, no. 4, pp. 349-375, 1993.
- [244] H. Ishii, M. Kobayashi and K. Arita, "Iterative design of seamless collaboration media," *Communications of the ACM*, vol. 37, no. 8, 1994.
- [245] P. Wellner, "Interacting with Paper on the DigitalDesk," *Communications of the ACM*, vol. 36, no. 7, pp. 87-96, 1993.
- [246] A. D. Wilson and D. C. Robbins, "PlayTogether: Playing Games across Multiple Interactive Tabletops," in *IUI Workshop on Tangible Play: Research and Design for Tangible and Tabletop Games*, Honolulu, 2007.
- [247] Y. Miwa and C. Ishibiki, "Shadow communication: system for embodied interaction with remote partners," in *Proceedings of the 2004 ACM conference on Computer supported cooperative work*, Chicago, 2004.
- [248] B. Xu, P. Chang, C. L. Welker, N. N. Bazarova and D. Cosley, "Automatic Archiving versus Default Deletion: What Snapchat Tells Us About Ephemerality in Design," in *Proceedings of the 19th ACM Conference on Computer-Supported Cooperative Work & Social Computing*, San Francisco, 2016.
- [249] A. Fourneau, Artist, *Waterlight Graffiti*. [Art]. DigitalArti Artlab, 2012.
- [250] L. J. Bannon, "Forgetting as a feature, not a bug: the duality of memory and implications for ubiquitous computing," *CoDesign*, vol. 2, no. 01, pp. 3-15, 2006.

- [251] C. Neustaedter and P. Sengers, "Autobiographical Design in HCI Research: Designing and Learning through Use-It-Yourself," in *DIS*, Newcastle, 2012.
- [252] A. Desjardins and A. Ball, "Revealing Tensions in Autobiographical Design in HCI," in *DIS*, Hong Kong, 2018.
- [253] C. Neustaedter, "My Life with Always-On Video," *The Electronic Journal of Communication*, vol. 23, no. 1 & 2, 2013.
- [254] M. Prasad A, M. Selvaraj and S. Madhvanath, "Peer-to-peer ink messaging across heterogeneous devices and platforms," in *COMPUTE '08 Proceedings of the 1st Bangalore Annual Compute Conference*, Bangalore, 2008.
- [255] J. Kučera, J. Scott, N. Chen, P. Olivier and S. Hodges, "Towards Calm Displays: Matching Ambient Illumination in Bedrooms," *Proceedings of the ACM on Interactive, Mobile, Wearable and Ubiquitous Technologies*, vol. 1, no. 2, June 2017.
- [256] W.-C. Chie, M. Hassenzahl and J. Welge, "Sharing a Robotic Pet as a Maintenance Strategy for Romantic Couples in Long-Distance Relationships. An Autobiographical Design Exploration," in *CHI'16 Extended Abstracts*, San Jose, 2016.
- [257] A. Desjardins and R. Wakkary, "Living In A Prototype: A Reconfigured Space," in *Proceedings of the 2016 CHI Conference on Human Factors in Computing Systems*, San Jose, 2016.
- [258] K. Helms, "Leaky Objects: Implicit Information, Unintentional Communication," in *Proceedings of the 2017 ACM Conference Companion Publication on Designing Interactive Systems*, Edinburgh, 2017.
- [259] M. Glass, K. Bryant, J. H. Kim and M. Desjarlais, "Come let us chat together: simultaneous typed-chat in computer-supported collaborative dialogue," *Journal of Computing Sciences in Colleges*, vol. 31, no. 2, pp. 96-105, 2015.
- [260] C. Hui-Chuan, B.-D. Illan and W. Shin-Tson, "Five-Primary-Color LCDs," *Journal of Display Technology*, vol. 6, no. 1, pp. 3-7, 2010.

- [261] C. Demers, "Local dimming on TVs: Direct-lit, edge-lit, full-array," RTINGS.com, 01 Jun 2016. [Online]. Available: <https://www.rtings.com/tv/tests/picture-quality/local-dimming>. [Accessed 3 March 2020].
- [262] A. R. Smith, "Alpha and the History of Digital Composing," Microsoft Tech Memo 7, 1995.
- [263] J. Kučera, J. Scott and N. Chen, "Probing calmness in applications using a calm display prototype," in *Proceedings of the 2017 ACM International Joint Conference on Pervasive and Ubiquitous Computing and Proceedings of the 2017 ACM International Symposium on Wearable Computers*, Maui, 2017.
- [264] A. Stockman, D. I. A. MacLeod and N. E. Johnson, "Spectral sensitivities of the human cones," *Journal of the Optical Society of America A*, vol. 10, no. 12, pp. 2491-2521, 1993.
- [265] A. Stockman, L. T. Sharpe, S. Merbs and J. Nathans, "Spectral Sensitivities of Human Cone Visual Pigments Determined in Vivo and in Vitro," *Methods in Enzymology*, vol. 316, pp. 626-650, 2000.
- [266] A. R. Smith, "Gamma Correction," Microsoft, 1995.
- [267] L. T. Sharpe, A. Stockman, H. Knau and H. Jägle, "Macular pigment densities derived from central and peripheral spectral sensitivities," *Vision Research*, vol. 38, pp. 3233-3239, 1998.
- [268] T. Scherini, P. Melo, T. v. Craenendonck, W. Zou and M. Kaptein, "Enhancing the Sleeping Quality of Partners Living Apart," in *DIS '10: Proceedings of the 8th ACM Conference on Designing Interactive Systems*, Aarhus, 2010.
- [269] A. Oulasvirta, A. Pihlajamaa, J. Perkiö, D. Ray, T. Vähäkangas, T. Hasu, N. Vainio and P. Myllymäki, "Long-term Effects on Ubiquitous Surveillance in the Home," in *Proceedings of the 2012 ACM Conference on Ubiquitous Computing*, Pittsburgh, 2012.
- [270] M. Millodot, *Dictionary of Optometry and Visual Science*, 7 ed., Elsevier, 2009.
- [271] S. E. Lindley, "Designing Interfaces to Afford Enjoyable Social Interactions by Collocated Groups," in *CHI '05 Extended Abstracts on Human Factors in Computing Systems*, Portland, 2005.

- [272] C. Heil, *Introduction to Real Analysis*, Springer International Publishing, 2019.
- [273] A. Beiser, *Concepts of modern physics*, 6th ed., New York: McGraw-Hill Companies, 2003.
- [274] International Telecommunication Union, *Parameter values for the HDTV standards for production and international programme exchange*, 2015.
- [275] J. Daemen and V. Rijmen, *The Design of Rijndael*, Springer-Verlag Berlin Heidelberg, 2020.
- [276] J. Kučera, “Calm displays,” in *Proceedings of the 2017 ACM International Joint Conference on Pervasive and Ubiquitous Computing and Proceedings of the 2017 ACM International Symposium on Wearable Computers*, Maui, 2017.
- [277] O. Devillers, S. Pion and M. Teillaud, “Walking in a Triangulation,” in *Proceedings of the Seventeenth Annual Symposium on Computational Geometry*, Medford, 2001.
- [278] J. Kučera, G. Gupta, J. Scott and A. Hurlbert, “Cross-Media Colour Matching under Chromatic Lights,” *Journal of Vision*, vol. 19, no. 10, p. 296c, 2019.
- [279] A. Case, “Keynote: Designing Calm Technology,” UX Week, San Francisco, 2016.
- [280] R. N. Bashir, S. Qadri, R. M. Saleem, M. Naeem and Y. Ghafoor, “Human Computer Interaction (HCI) in Ubiquitous Computing,” *International Journal of Innovation and Applied Studies*, vol. 9, no. 2, pp. 534-540, 2014.
- [281] F. Rahman, “The Shrinking Green Gap: Trends in Solid-State Green Emitters,” *Photonics Media*, 08 January 2019. [Online]. Available: https://www.photonics.com/Articles/The_Shrinking_Green_Gap_Trends_in_Solid-State/a64221. [Accessed 11 March 2020].
- [282] Market Reports World, “Global Display Market Report 2019,” Pune, 2019.
- [283] Mordor Intelligence, “Electronic Paper Display Market-Growth, Trends, and Forecast (2020-2025),” Hyderabad, 2020.
- [284] K. McLaren, “Publications Sponsored by the Colour Measurement Committee—V The Adams—Nickerson Colour-difference Formula*,” vol. 86, no. 8, pp. 354-356, 1970.

- [285] G. J. Braun, M. D. Fairchild and F. Ebner, "Color Gamut Mapping in a Hue-Linearized CIELAB Color Space," in *Color Imaging Conference*, Scottsdale, 1998.
- [286] W.-C. Wang, "Optical Detectors," 14 February 2016. [Online]. Available: <http://courses.washington.edu/me557/optics/detector.pdf>. [Accessed 25 March 2020].
- [287] ISO, "ISO 15008:2003 Road vehicles — Ergonomic aspects of transport information and control systems — Specifications and compliance procedures for in-vehicle visual presentation," ISO, 2003.
- [288] J. Kučera, J. Scott, S. Lindley and P. Olivier, "Bedtime Window: A Field Study Connecting Bedrooms of Long-Distance Couples Using a Slow Photo-Stream and Shared Real-Time Inking," in *CHI '21: CHI Conference on Human Factors in Computing Systems*, Yokohama, 2021.
- [289] J. Kučera, J. Scott, S. Lindley and P. Olivier, "Bedtime Window: a system enabling sharing of bedtime for long-distance couples," in *Adjunct Proceedings of the 2019 ACM International Joint Conference on Pervasive and Ubiquitous Computing and Proceedings of the 2019 ACM International Symposium on Wearable Computers*, London, 2019.
- [290] J. Kučera, K. Ibekwe, S.-M. Papadopoulou, G. Gupta and A. Hurlbert, "Making a Display look like Paper: the Effects of Adaptation Duration and Luminance," *Journal of Vision*, vol. 21, 2021 (V-VSS abstract accepted).

Appendix A. Philips Hue Analysis

A.1 Point Accuracy

In order to verify and establish the full gamut of the lights, several thousands of colour points have been tested on the lights, taking advantage of the firmware clipping the colours into gamut. Three types of points were tested, all on full brightness (= 254):

1. 800 xy points on bounding unit square, i.e. $x=0..1$ for $y=0$ and $y=1$ and vice versa, using steps of 0.05.
2. 3419 xy points on a uniform grid ranging from $y=0.07$ to 0.71 and $x=0.13$ to 0.71 with steps of 0.01.
3. 8192 hue points with maximum saturation (= 254), hue value ranging from 0 to 65536 in steps of 8.

The resulting points are plotted in Figure 0.1. The maximum Euclidean distance between requested and final point for the in-gamut grid points was $\Delta_{xy} = 0.0107$, with the error distribution shown in Figure 0.2.

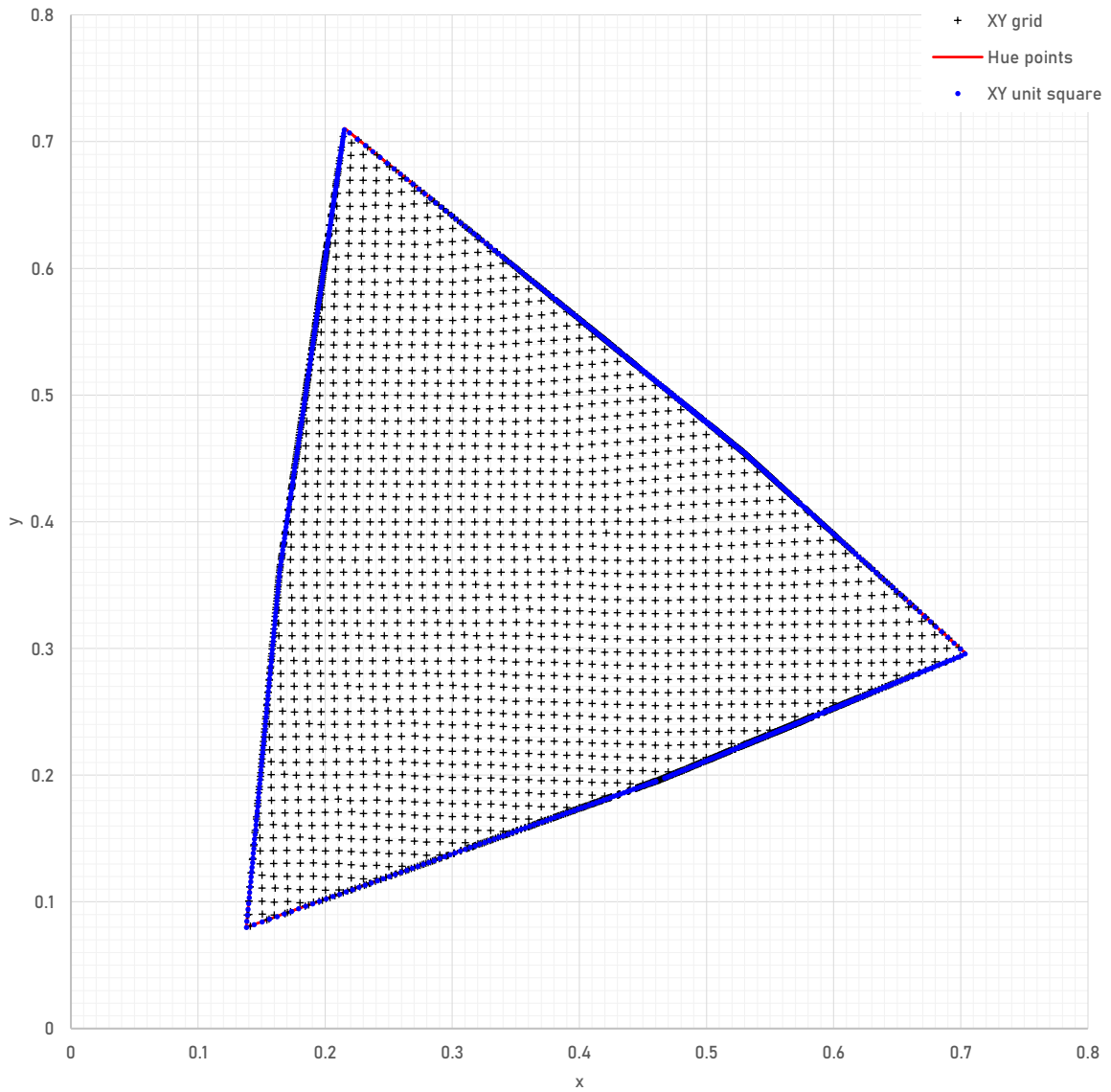

Figure 0.1. Philips Hue LLC010 gamut points

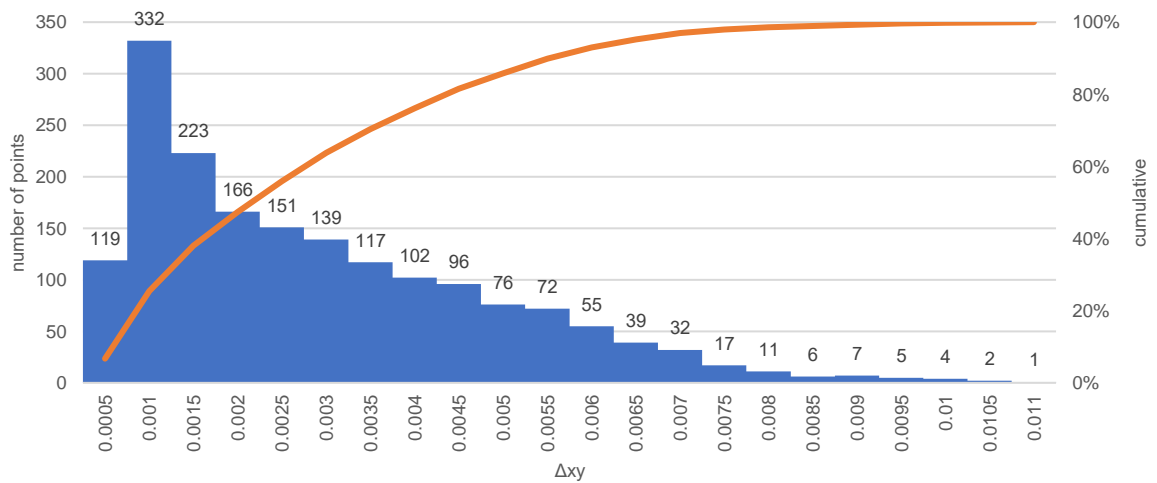

Figure 0.2. Requested vs final point distance distribution

White area as well as red, green and blue corners have the least error. The gamut midpoints, i.e. cyan, magenta and yellow are the areas with the highest error, as can be seen in Figure 0.3.

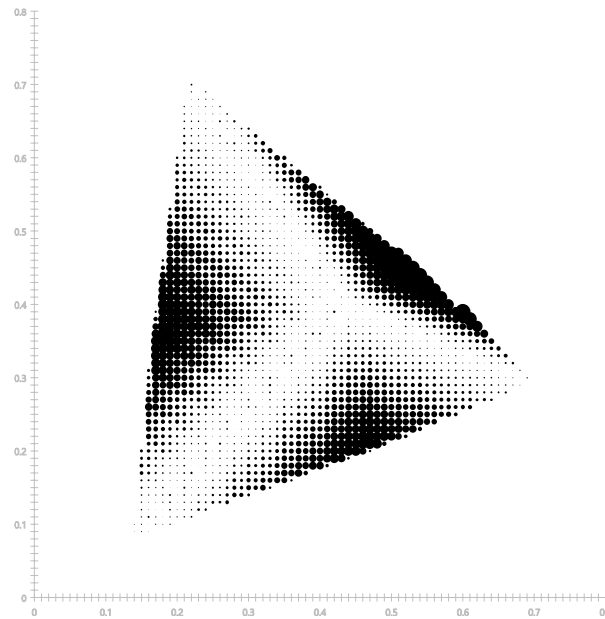

Figure 0.3. Requested vs final point distance by colour requested. Points represent requested colours, the circle radius is the Euclidean distance to the final colour points.

A.2 Stabilization Time

Knowing the stabilization time is important to avoid measuring the light during calibration process (see 5.3.1) while it is still changing or to be changed. All of the 12,411 test points discussed above were timed using the procedure as follows:

1. Set lights to the desired colour.

```
PUT /api/key/groups/0/action {"xy":[x,y],"bri":brightness,"transitiontime":0} or
```

```
PUT /api/key/groups/0/action {"hue":hue,"sat":saturation,"bri":brightness,"transitiontime":0}
```
2. Every 200 ms, get the current colour in xy.

```
GET /api/key/lights/1
```
3. Repeat until the read colour is different from the desired (i.e. we assume the algorithm will almost never produce the exact colour requested), or until 50 attempts (10 seconds) have passed, in which case we assume we got exact colour since the beginning and stabilization time is zero.
4. Wait another 250 ms and ensure the value has not changed any further.

In case any of the request failed, the whole point was repeated. The histogram of all times it took for the light to stabilize is in Figure 0.4.

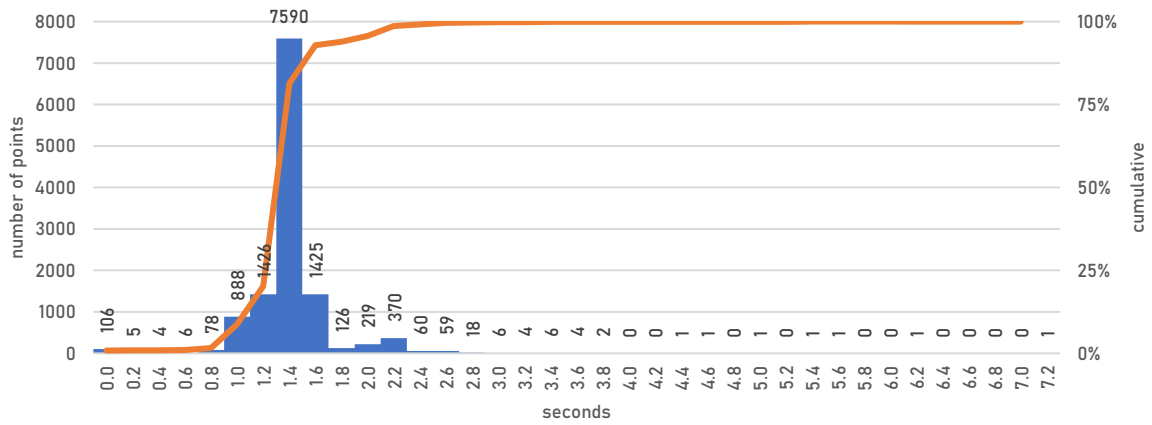

Figure 0.4. Philips Hue stabilization time.

The results indicate that waiting at least 3 seconds after setting the desired colour will result in the final colour applied in 99.8% of the cases (as reported by the lights).

A.3 Gamut Estimation

It is apparent from the Figure 0.1 that the gamut is not exactly triangular, since the midpoints are outside of the triangle. In order to find out all the gamut corners, the points from unit square were manually categorized into 6 groups, depending to which side of the gamut ‘triangle’ they belong: blue-magenta, magenta-red, red-yellow, yellow-green, green-cyan, and cyan-blue. Unclear points around the corners were ignored. Then, the least square regression analysis was performed to estimate the gamut lines, yielding the gamut corners as intersection of these lines. Finally, the lights were set to the corner points in order to retrieve the closest points achievable. Summary of the analysis can be found in Table 0.1.

| gamut | linear regression | | | corner | documented | | solved | | final | | | |
|----------------|-------------------|----------|---------------------|---------|------------|--------|--------|--------|---------------|---------------|---|---|
| | line | slope | intercept | | RSS | point | x | y | x | y | x | y |
| blue – magenta | 0.35808 | 0.03058 | $1.1 \cdot 10^{-7}$ | blue | 0.138 | 0.08 | 0.1380 | 0.0800 | 0.1380 | 0.0800 | | |
| magenta – red | 0.41360 | 0.00483 | $2.3 \cdot 10^{-7}$ | magenta | | | 0.4637 | 0.1966 | 0.4627 | 0.1963 | | |
| red – yellow | -0.90892 | 0.93589 | $2.0 \cdot 10^{-7}$ | red | 0.704 | 0.296 | 0.7040 | 0.2960 | 0.7040 | 0.2960 | | |
| yellow – green | -0.81400 | 0.88566 | $5.8 \cdot 10^{-7}$ | yellow | | | 0.5215 | 0.4549 | 0.5215 | 0.4611 | | |
| green – cyan | 6.85594 | -0.76430 | $9.6 \cdot 10^{-6}$ | green | 0.2151 | 0.7106 | 0.2151 | 0.7106 | 0.2160 | 0.7094 | | |
| cyan – blue | 10.75463 | -1.40414 | $1.2 \cdot 10^{-5}$ | cyan | | | 0.1641 | 0.3609 | 0.1643 | 0.3622 | | |

Table 0.1. Philips Hue gamut lines and points analysis

To evaluate the quantization limits of the Philips Hue lights, extra test points with high resolution were taken around the final gamut points. See Figure 0.5 for the results.

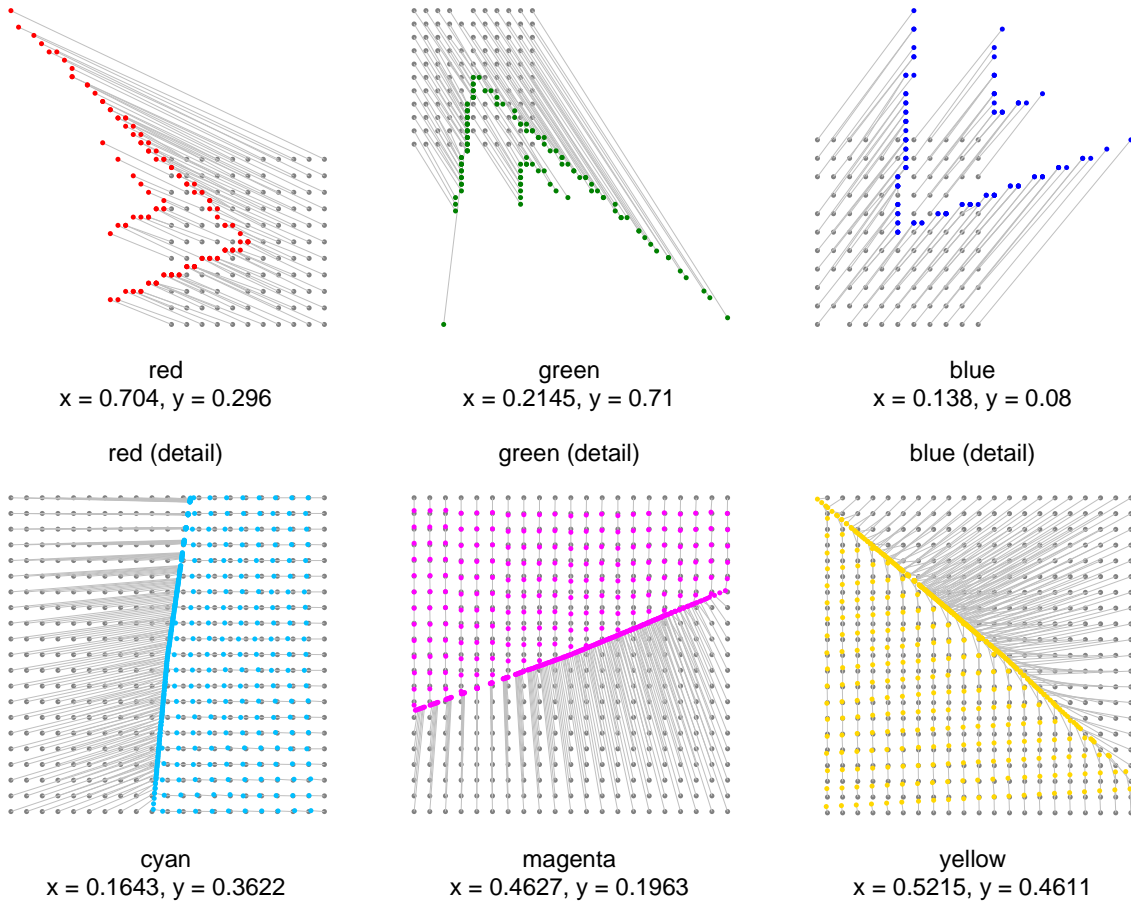























Figure 0.5. Details of gamut corners requested-final point mappings. RGB with resolution of 0.0002, CMY with resolution of 0.005. Coordinates refer to the center of the test grid.

The patterns suggest that rather than finding the closest xy point to the requested colour, the firmware computes the required red, green, resp. blue LED power levels and then trims the values to the available resolution step. The inner and outer triangles in Figure 0.5 are the smallest changes in the LED power output the Hue lights are capable of.

Appendix B. LED Channel Values

The table below lists the 12-bit values (i.e. maximum is 4095) used for the LT-01 illuminant's LED channels to generate target lighting conditions for the colorimetry study in Chapter 3.

| Condition name |  |  |  |  |  |  |  |  |  |  |  |  |  |
|---|---|---|---|---|---|---|---|---|---|---|---|---|---|
|  red | 100 | 105 | 249 | 228 | 46 | 106 | 25 | 4 | 1732 | 189 | 2133 | 1314 | 793 |
|  green | 22 | 25 | 55 | 86 | 423 | 1569 | 1313 | 7 | 515 | 156 | 211 | 306 | 350 |
|  blue | 822 | 1170 | 1731 | 793 | 951 | 924 | 470 | 4 | 214 | 214 | 441 | 735 | 791 |
|  cyan | 146 | 164 | 446 | 545 | 845 | 1157 | 1051 | 3 | 228 | 220 | 400 | 653 | 707 |
|  magenta | 559 | 549 | 448 | 302 | 81 | 158 | 57 | 8 | 1980 | 151 | 1009 | 637 | 462 |
|  yellow | 28 | 31 | 101 | 148 | 396 | 1138 | 466 | 10 | 1203 | 286 | 467 | 572 | 601 |
|  white | 262 | 312 | 555 | 569 | 657 | 836 | 479 | 51 | 906 | 282 | 241 | 439 | 488 |
|  daylight yellow | 33 | 37 | 131 | 181 | 363 | 1008 | 217 | 9 | 1387 | 323 | 630 | 684 | 693 |
|  daylight blue | 364 | 496 | 722 | 663 | 727 | 865 | 511 | 10 | 572 | 417 | 454 | 540 | 576 |

Appendix C. Display's Chromatic Uniformity

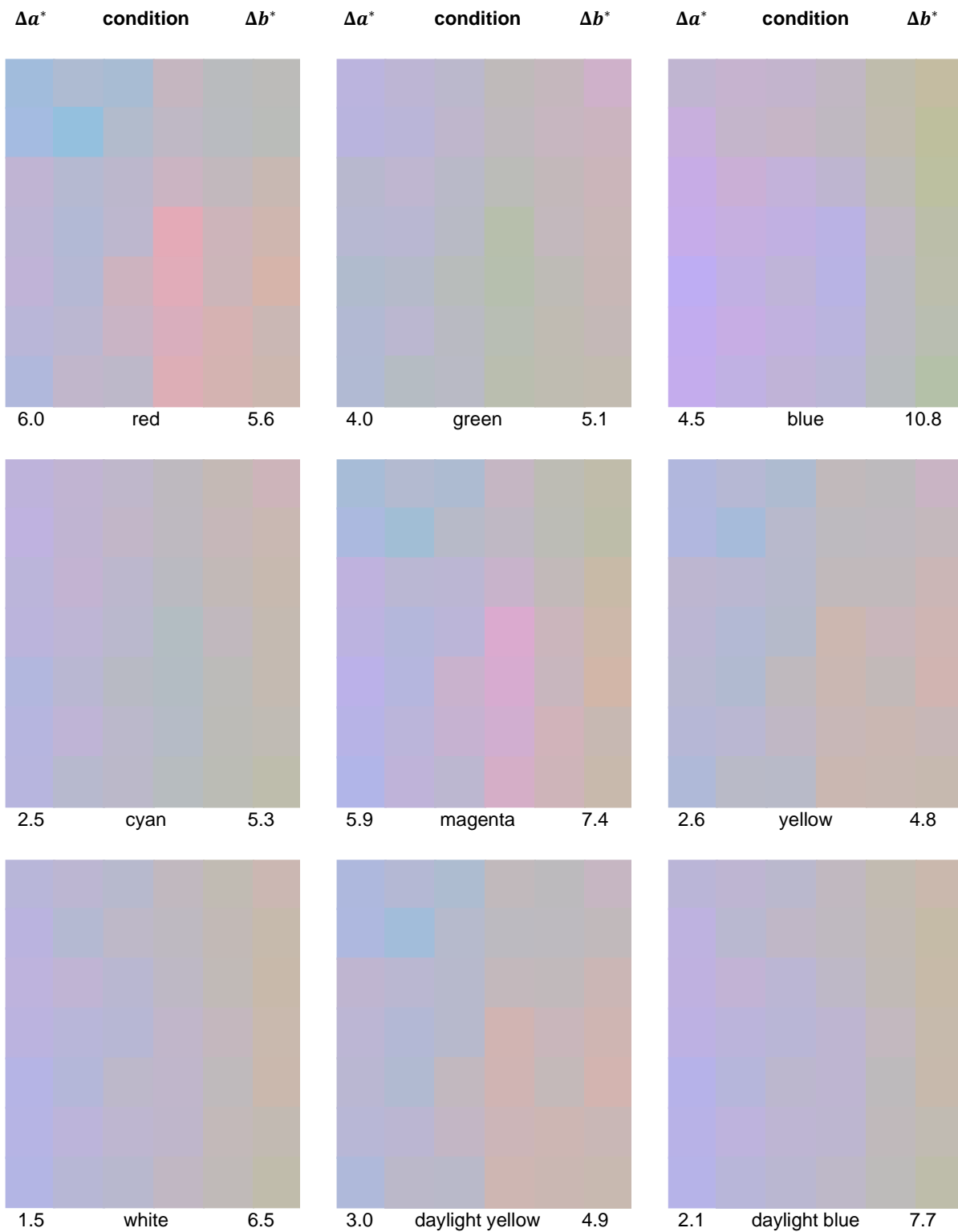

Shading represents LAB values converted to RGB, with $L^* = 150$ and a^* and b^* values multiplied by 10. Neutral i.e. grey colour falls on the mean value of a^* resp. b^* , hence the colouring visualises the differences rather than absolute colours (for example, red condition didn't have any green, just more and less saturated red).

Appendix D. Colour Matching Experiment Documents

D.1 Information Sheet



Ambient Adaptive Colour Constancy Model

Experiment Title: **Cross-Media Colour Matching II**

Name of Researcher: Jan Kučera

Principal Investigator: Prof Anya Hurlbert

Information Sheet

Thank you for expressing an interest in this research. This sheet will give you an overview of the research project and the experiment that you might be taking part in. Please take the time to read it in full and make a note of any questions you may have. You can contact the researcher at any time using the contact details at the end of this sheet.

Project Summary

As we are having more and more displays in our environment, it may be desirable to let them blend into their surroundings as many other everyday objects do, so that we don't become easily overwhelmed or overly distracted. It is therefore important for the displays to be able to match the colour of other objects in the surrounding environment. In this study, we are interested in how sensitive people are to colour differences under various lighting conditions, in order to determine how close such matches need to be.

What is involved in the study?

During the study, you will visit the Institute of Neuroscience on up to four occasions at your convenience to complete a colour matching task. In this task, you will be presented with an LCD screen next to a paper cardboard. You will be asked to adjust the colour on a display using a game controller, so that it matches the colour on the paper card as much as possible. You will be repeating this task under different lighting colours.

Each session should take approximately 60-90 minutes to complete. You will also need to complete some basic colour vision tests and sign the consent form before taking part in the study. For every completed 60 minutes of the matching task, you will be compensated with a £10 voucher as a recognition of your time and contribution. Should you attend only one session that lasts less than 60 minutes, you will be eligible for one £5 voucher instead.

Are you eligible to take part?

If you are a generally healthy individual, between the ages of 16 and 45, with normal or corrected to normal visual acuity and no colour vision deficiencies, then we would like to hear from you.

Withdrawal and data protection

Participation is voluntary and you may withdraw from the study at any time without reason or penalty. If you decide to take part in the study, you will be given a copy of this information sheet to keep and will be asked to sign a consent form. All participants are issued with a participant number when they sign the consent form. After this, all data will be kept anonymised and only referred to by the participant number. If you choose to withdraw from the study, all data will be destroyed immediately.

Would you like to be involved?

To participate in the study, please contact us at j.kucera1@ncl.ac.uk.

D.2 Consent Form



Ambient Adaptive Colour Constancy Model

Experiment Title: **Cross-Media Colour Matching II**

Name of Researcher: Jan Kučera

Principal Investigator: Prof Anya Hurlbert

Consent Form

I, (name),
consent to taking part in the above-named study.

- I have read the information sheet giving details of this study and have had the opportunity to ask questions.
- I understand that my participation is voluntary and that I may withdraw consent at any time without giving any reason and without penalty.
- I consent to being contacted on the e-mail address I provide with regards to this study.
- I consent to being contacted on the e-mail address I provide with regards to future studies.
- I give consent for my anonymized data to be used for research purposes for the next 10 years. I consent for data I contribute, including my age and gender, to be published in scientific journals, on the internet and at scientific conferences. I acknowledge that I will not be identified by name. I consent to be identified by a code.

Contact e-mail address:

Signed:.....(participant)

Witness name:(experimenter)

Witness signature:(experimenter)

D.3 Instructions to Participants



Ambient Adaptive Colour Constancy Model

Experiment Title: **Cross-Media Colour Matching II**

Name of Researcher: Jan Kučera

Principal Investigator: Prof Anya Hurlbert

Instructions to participants

1. Researcher: check plane tilt.
2. Thank you for taking part in the study!
3. Today's task is a colour matching task.
4. When you look through the window, you can see a display on the left side and a paper card on the right side.
5. You will use the game controller to adjust the display so that it looks as similar as possible to the card on the right side.
 - a. YBAX buttons on the right to make the display more yellow, red, blue, green;
 - b. directional pad up/down on the left to make the display lighter or darker;
 - c. right back button to switch to fine steps for adjusting the display;
 - d. holding left back button to confirm your choices.
6. When you reach limits of the display, for example when it cannot go any more red, the controller will vibrate. If you get stuck at any point, simply tell me and we will find a solution.
7. Adjust your chair if needed so that you can rest your chin on the stand.
8. When doing the matches, try to look at either the display or the paper – don't look in the middle and don't cross your eyes.
9. If you have any questions or problems during the course of the study, feel free to let me know; you are allowed to speak.

D.4 Demographic Questionnaire



Ambient Adaptive Colour Constancy Model

Experiment Title: **Cross-Media Colour Matching II**

Name of Researcher: Jan Kučera

Principal Investigator: Prof Anya Hurlbert

Demographic Questionnaire

Session number:

What is your age?

What is your gender?

What is your ethnicity?

What is your date of birth?

What is your first language?

What is the colour of your eyes?

You are: Left-handed Right-handed

Appendix E. Paper-like Displays Study Documents

E.1 Call for Participants



Bedroom Displays Study — Invitation E-mail

Subject: Bedroom displays study — participants needed

Hello everyone!

We are looking for participants for our study around displays in bedrooms.

What?

Participants will be given a tablet PC showing a slideshow of pictures of nature to place into their bedroom. The display can be turned off and on if needed, but no interaction is required.

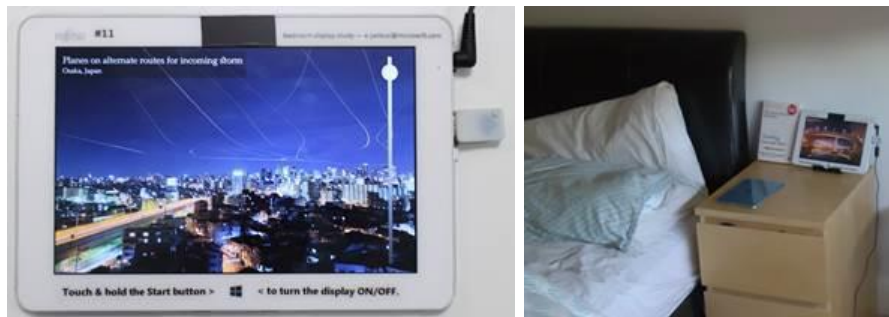

How long?

We are doing a 2-week deployment starting sometime next week (30/8-2/9). Halfway through the deployment and again at the end, there will be a 10-minute interview about your experiences with the device.

What data is collected?

The device has an ambient light sensor to detect the light level in the room. Readings from that sensor will be recorded as well as when the display is turned off or on. No video or audio is being recorded or processed and all data will be anonymous.

Why participate?

Because research is important. On top of that, as a thank-you we would like to offer a £20 Amazon voucher and some chocolates.

If that made you interested and

- you have only one bed in the bedroom,
 - you will be mostly sleeping in your bedroom for the next 2 weeks,
 - you are not from the Sensors and Devices group,
- please let us know!

Thank you,
Jan Kučera & James Scott

E.2 Consent Form



Bedroom Displays Study — Consent Form

I agree to participate in the study *Bedroom Displays Study* being carried out by Newcastle University and Microsoft Research.

- I have read and understood the information sheet about taking part.
- A researcher has answered any questions that I had.
- I understand that any collected data will be used for research purposes only.
- I understand that I will not be mentioned by name on any documents or in any presentations about the research.
- I understand that I can withdraw from the study at any time without needing to give a reason.

Signature of participant:

Name in capitals: Date:

Date of birth: Gender:

Signature of the researcher:

Name in capitals:

Device number:

E.3 Information Sheet



Bedroom Displays Study — Information Sheet (white tablet)

Thank you for taking part in the bedroom displays study! This sheet should guide you through the study and answer some of the questions you might have. Should you have any other requests or if you encounter any problem during the course of the study, please contact me at a-jankuc@microsoft.com.

Who are the researchers and what is the research about?

My name is Jan Kučera and I am conducting this study as a PhD student at Newcastle University in collaboration with Microsoft Research.

My research is about display technologies in challenging settings such as theatres or bedrooms, and this particular study looks into suitability of existing displays for bedrooms.

What do I get?

You should have received a package that contains:

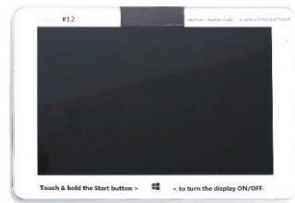

a tablet device



power adapter for the tablet



USB ambient light sensor



stand for the tablet

How do I set it up?

Please proceed as follows:

1. Place the device anywhere in your bedroom so that you can directly see the display from your bed. Feel free to use the supplied stand if helpful. In order to adjust the stand angle, you need to push the round button on the side:



2. Open the **USB socket** on right side of the device and plug the sensor in.
3. Open the **power socket** and plug the power adapter in. It should look like this:

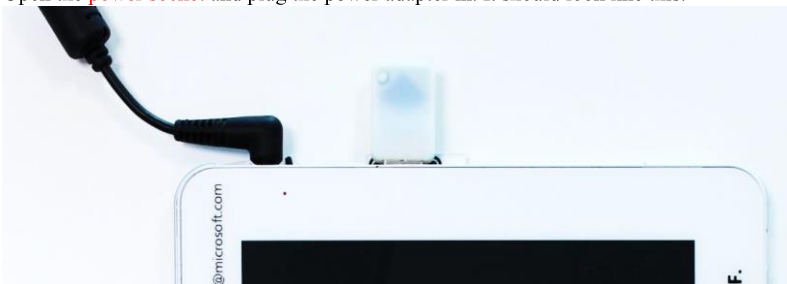

4. Press the **power button** on the side of the device. The device will vibrate, a purple light on the sensor should blink once and the device will start up.
5. Take a picture of how you set up the device in the room and e-mail it to me at a-jankuc@microsoft.com. This will only be used for verifying the setup is OK.

What do I need to do?

Short version: leave the display in your bedroom as an ambient display,
turn the display off if you find it distracting.

The display will cycle through a set of photos, changing every 5 minutes. We hope you will simply enjoy having the device, like a dynamic picture frame.

The only interaction supported by the display is turning the screen off or back on. This is by touching the Start button  for a moment (note that the device will vibrate and once you release it, the display will react). If you find the display distracting, feel free to turn it off. You can turn it on the same way. Even if you don't, it will turn itself back on the next day.

Halfway through the 2-week study, and again at the end, we will conduct a 10-minute interview with you, asking questions about how you felt about having the display in the bedroom. Please note down the days when you are not sleeping in the room, if any.

Can I change the device location once set up?

Yes, as long as you keep the display in plain sight from your bed.

You might need to locate several things on the tablet:

left side view

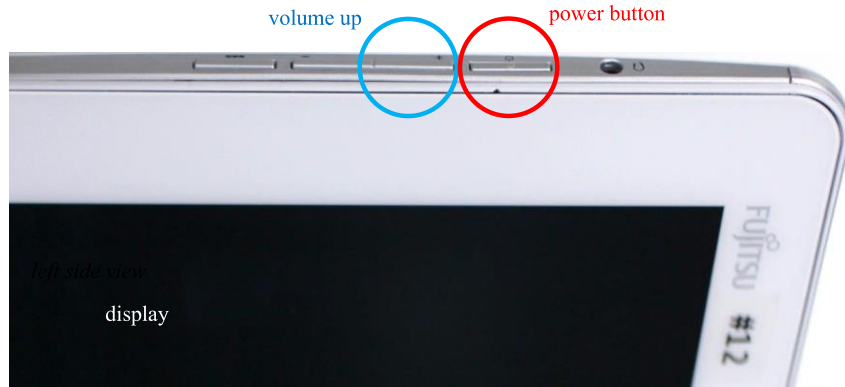

right side view

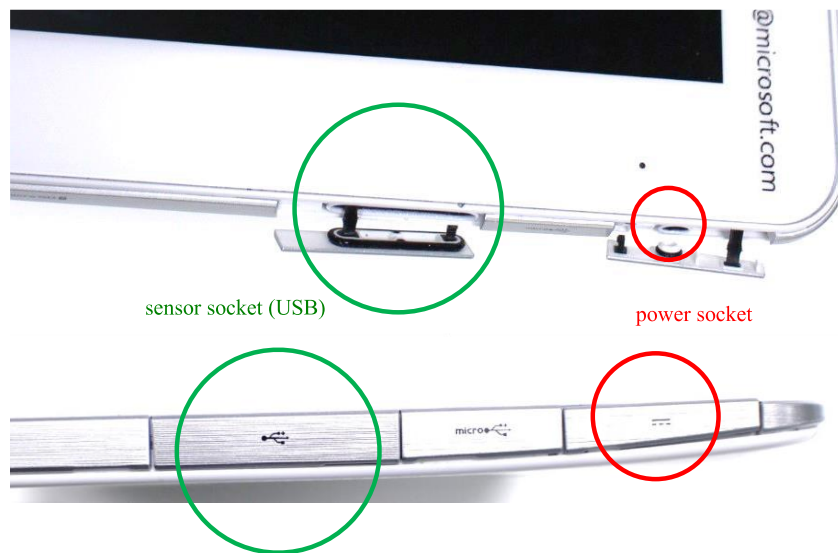

What data does the device record?

The device records the time whenever you turn the display on or off, as well as the ambient lighting conditions (i.e. whether it's dark or light in the room).

Is audio or video being recorded or processed at any time?

No.

Does it need internet connection?

No. The device is in flight mode and does not attempt to connect to any network.

How do I withdraw from the study?

Participation is completely voluntary and you can withdraw from the study at any time with no explanation. Just drop me an e-mail to a-jankuc@microsoft.com and bring back the hardware.

It does not work!



The sensor is not detected. Make sure it is properly plugged in – try re-plugging it if necessary. If that does not help, please contact me.



The device is running on battery. Make sure the power adapter is properly plugged in and the socket is switched on. Try re-plugging the power adapter if necessary. If that does not help, please contact me.



If you happen to encounter this screen (lock screen), please contact me. While you might be able to dismiss it by tapping on the screen, an important aspect of the software needs to be fixed.





If you happen to encounter this screen (logon screen) on first power up, use the password *study*. If you see it at any other time during the study, please contact me, as an important aspect of the software needs to be fixed.

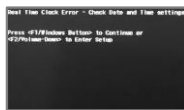

If the display appears off or black, try the following in order:

1. try touching the Start button  to turn it on;
2. unplug the USB sensor – if the screen shows the error message above, it's working as it should (no fix is required);
3. otherwise please email me at a-jankuc@microsoft.com.



If you see **Real Time Clock Error** on power up, you can continue by touching the Start button , but please e-mail me the date and time when it happened.

Thank you again for your participation!

Jan Kučera

E.4 Progression Instructions



Bedroom Displays Study — Progressing to 2nd week (white tablets)

Thanks for your participation so far, you have been doing great!

Now it's time to progress to the next phase. Please locate the **volume up** button:

left side view

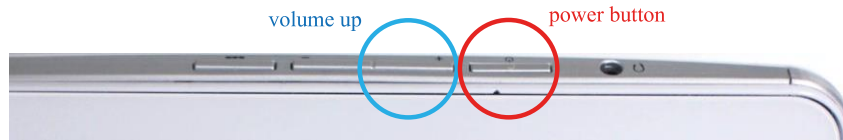

display

Press it and keep holding it for several seconds. After first couple of seconds, a confirmation will appear, but keep holding:



And after a couple of more seconds, you will get a confirmation:



You can release the button at this point. You can recognize you have succeeded for example by the fact that you will be presented a new set of pictures. In case of troubles, please e-mail me at a-jankuc@microsoft.com.

Thank you!

E.5 Study Plan



Bedroom Displays Study — Study Plan

Aim of the study: We have got the technology to make displays blend into the environment, and the study is a way to get people think about how they would use such displays in their personal spaces that are sensitive to light, and whether it makes them consider deploying displays into spaces they wouldn't have had considered before.

Schedule

| | Group A 3 black tablets 3 white tablets | Group B 3 black tablets 3 white tablets |
|-------------------------|--|--|
| | initial interview | |
| Week 1: Corpus A | calm | normal |
| | midway interview + recollection | |
| Week 2: Corpus B | normal | calm |
| | final interview + recollection | |

Operation modes

Calm: Display tries to emit as much light and colour as a paper would reflect given ambient lighting any moment.

Normal: Display does no colour adjustments and changes brightness between “bright” level and “dimmed” level based on ambient lighting (i.e. what normal display with automatic brightness does).

In both modes:

- users can turn the display off and on using a button;
- the display will turn itself on at noon every day;
- one of the 10 preselected pictures of given corpus is shown on the screen for 5 minutes.

The participants will be instructed to progress into second week by holding a button on the device once interviewed.

E.6 Interview Questions Plan



Bedroom Displays Study — Interview questions

Initial:

1. How many beds are there in your bedroom? Who normally sleeps there?
2. Have you used an electronic picture frame before? What content did you show, what room was it in, and how long is/was it placed there?
3. What displays do you currently have in your bedroom? Alarm clock?
4. How dark is your bedroom normally at night? Are your curtains “blackout”/ do you sleep with curtains closed or open? Do you have a night light that stays on all night?
5. Do you keep your phone with you over night? Where?

Do not talk with others (?)

Midway + Final:

1. Did you notice the tablet changing brightness automatically? Please describe what it did.
2. Did you find it distracting when trying to get to sleep in the last week?
3. Did you turn the tablet off in the last week? How often, and why?
4. In the last week, when the tablet was on, were you able to see the content when you glanced at it?

1 (very difficult to see the content) .. 3 (neutral) .. 5 (very easy to see the content)

5. Based on your experience in the last week, how interested are you in having this type of display in your bedroom? Assume the hardware is affordable.

1 (not interested at all) .. 3 (neutral) .. 5 (highly interested)

6. Imagine you can customize the appearance of the tablet itself (e.g. a wooden frame), and the content of the images shown (e.g. to be your own pictures), what is your opinion to the question above in that case?

Same scale as above

7. Did you have any other issues with the display?

<now explain how to move it into week 2 mode>

Final only:

1. Have you noticed any difference between the two weeks? Please describe briefly.
2. Did you feel the [calm mode] made the display more appropriate for use in bedrooms?
1 (calm is much less appropriate) .. 3 (same) .. 5 (calm is much more appropriate)
3. Can you think of other environments where the “calm” mode would be appropriate/useful?
4. What types of content would you find useful on a bedroom display?
5. Please rank the importance of the types of content above?

E.7 Recollection Sheet Week 1



Bedroom Displays Study — Corpus A

Please mark the photos you remember seeing on the display during the last week:

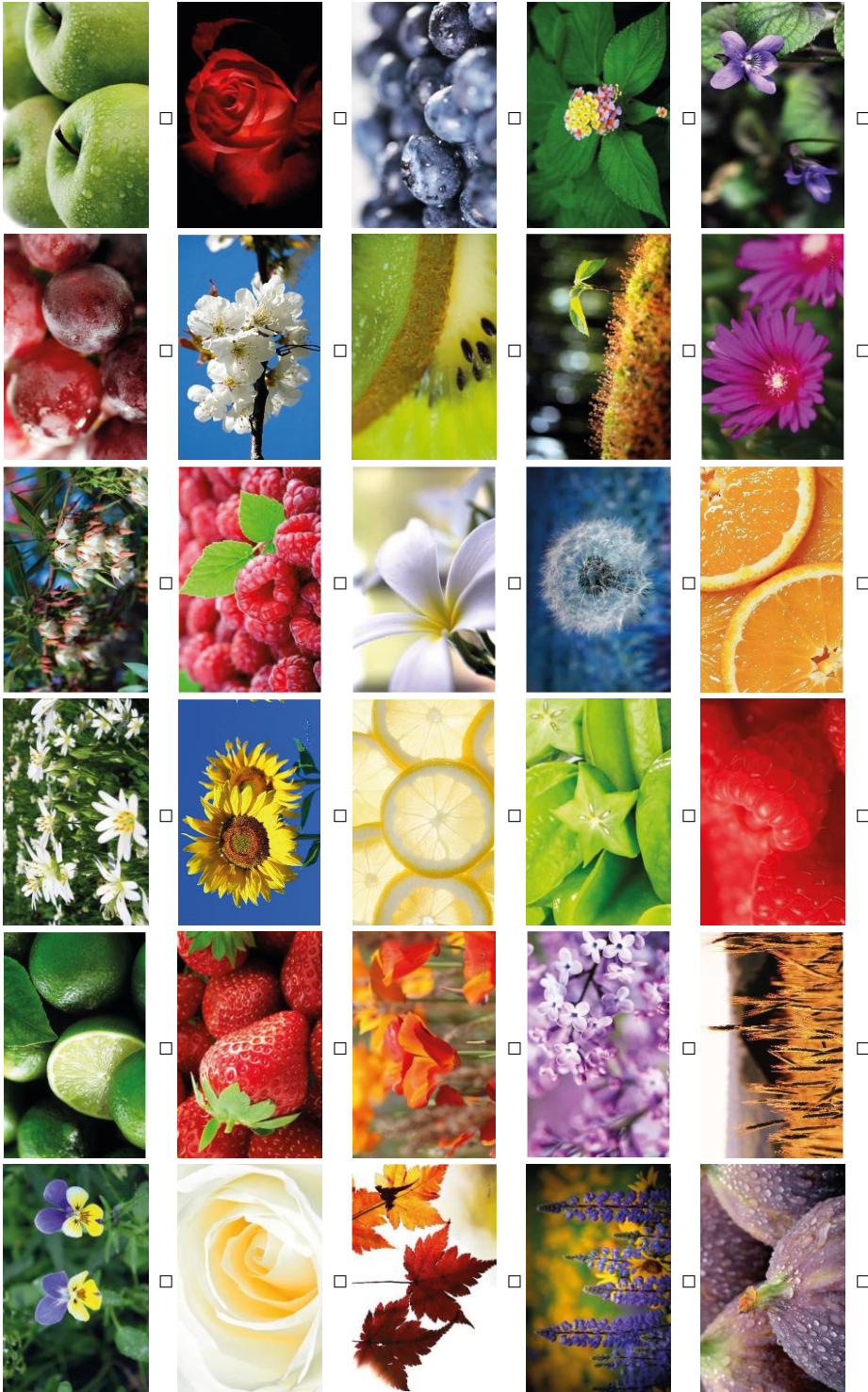















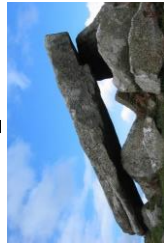
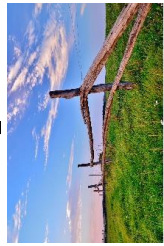

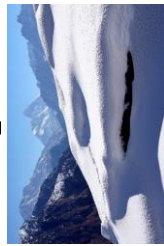

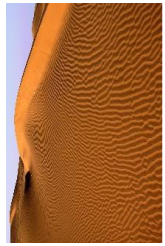

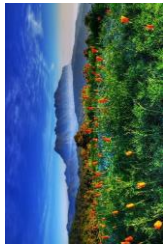



E.8 Recollection Sheet Week 2

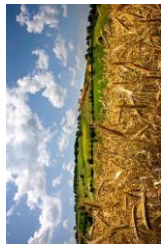

Bedroom Displays Study — Corpus B

Please mark the photos you remember seeing on the display during the last week:

| | | | | | |
|---|---|---|--|---|---|
|  |  |  |  |  |  |
|  |  |  |  |  |  |
|  |  |  |  |  |  |
|  |  |  |  |  |  |
|  |  |  |  |  |  |

Appendix F. Bedtime Window Study Documents

F.1 Recruitment Page



Newcastle University

Bedtime Window

Living in a long distance relationship?

Feeling disconnected from your partner, especially at night?

Interested in how technology can support your relationship?

We are looking for participants for our study of long distance relationships around bedtime and the role technology can play in supporting these relationships.

We require partners that:

- are in a relationship but currently living separately;
- do not currently share bedroom with other people;
- have previously lived together;
- are both willing to participate in the study;
- are both aged over 18 years-old;
- are able to interact with touch screens (including fine control).

You would be asked to:

- try a new system prototype in your bedroom for 4 weeks;
- attend in person or remotely 2 interviews;

Each participant will be remunerated with a **£120** gift voucher in recognition for their contribution to the study and reimbursed travel costs to the Newcastle University, should they chose to attend interviews in person.

What does it do?

The system is running 24/7 on a tablet-like device and provides two core experiences:

- real-time, shared inking space for drawing together
- a picture from the camera is exchanged every 5 seconds

The device does not record or transmit any audio or video.



Ink properties
Every stroke can have a different colour, thickness and decay time. Use the top panel to create spectacular drawings, have lively conversations with your partner or leave messages to them. The ink is always disappearing and you can choose if it will only last a second, a minute, an hour or the whole day.

Clock
Tap the time to set it up to show either your or partner's current time

Enough is enough! Delete all ink with a single tap.

Light sensitive display
Let the display be as bright as a piece of paper so that it does not disturb you when sleeping.

Living picture preview
seconds, as indicated by the progress bar on the left side. You can also manually tap the live preview to send a picture immediately.

System feedback
After trying our demo, you can indicate what made you particularly happy or unhappy about the system by tapping on any of the smiles.

Light timeline
See how the day is going for you and your partner.

What data is recorded and what happens to it?

Data that are never recorded or transmitted:

- audio from microphone(s)
- video streams from camera(s)

Data that are transferred over network but not accessible to the research team:

- still images from camera (encrypted)
- inking data

Data that are recorded on the device for research analysis:

- inking telemetry (type and amount of ink used)
- highest measured light intensity per minute
(for assessing lighting conditions in bedroom environments)
- highest accelerometer reading per minute
(for detecting active system use)
- number of faces detected in the camera image per minute
(for detecting passive system use)
- screenshots only if explicitly taken and saved by participant

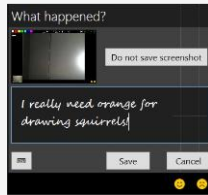

System feedback, screenshots & interviews

We are interested in potential effects of the technology on your relationship, inking communication patterns, and the perception of presence. We hope to learn about that through interviews with you. You will also be encouraged to record optional screenshots and/or written notes during the system use that you want to discuss with us during the final interview — entirely at your control and you will be given an opportunity to review and remove the screenshots before showing it to the researchers. This data stays on the device and isn't transmitted anywhere.

The interviews will be audio-recorded and you will be asked to take a picture of how you placed the device in the bedroom. Anonymized quotes from the interview and charts of the collected telemetry might be published in an academic publication. Screenshots and the picture of the device will not be published unless we explicitly ask for a separate permission on case by case basis.

Frequently asked questions

Organizational

When will the study take place?

The study needs to run for 4 consecutive weeks during which you would be expected to spend most of the time separated from your partner, plus distributing and collecting the devices. We will do our best to accommodate your preferred dates but we would like to run the first studies April—May 2018.

Will I or my partner have to travel anywhere?

No. You are welcome and encouraged to do the interviews in person at the Newcastle University and we will reimburse you travel costs within the United Kingdom, but you are fine doing the interviews over video chat and we are happy to ship the devices to both of you.

Any restrictions on where we are based?

If you are interested in the study, feel free to apply regardless of where you or your partner is based. In the first round, however, we might prefer to choose participants based in the UK or Europe.

Can I withdraw from the study once it is running?

Yes. Any of you can withdraw at any time and the study will end for both of you. You will be remunerated partially according to the duration of your participation.

System features

Can I call my partner?

The system does not capture audio and cannot make video calls either. However, feel free to use your phone or other technologies you are otherwise used to use with your partner to communicate with each other.

What are the connectivity requirements?

We strongly recommend at least broadband internet connection. The system typically exchanges up to 1 GB of data per day, and takes on average 128 kbps of both download and upload bandwidth. In case of connectivity issues or insufficient connection speed, the system will exchange pictures less often.

Can my partner store my data without me knowing?

The system does not allow you to save anything other than taking screenshots for the purpose of discussion during the final interview. That said, like with any other technology, we cannot prevent anyone for example taking a photo of the system running. If you are worried about your partner obtaining your data, you might want to reconsider your participation.

Privacy

Can the researchers see what I draw?

No. The device only collects usage telemetry, i.e. how much you ink, what color you use etc. but the drawings themselves cannot be reconstructed from the data. Only you and your partner can see the drawings. If you feel particularly excited about your drawing or how you used it with your partner, you can use the feedback buttons to take a screenshot, and then show it to the researchers during the final interview.

Will my partner see me naked?

That is entirely up to you. We ask you to keep the device always on, but feel free to set it up or move or cover at any time so that you are both comfortable using it.

Will the researchers see me naked?

No. No one else can see the pictures transferred between you and your partner. They are not stored anywhere and they are transferred encrypted so that no one can view them on the way to your partner, using widely used [Advanced Encryption Standard](#), similar to how other applications encrypt communication. If you by accident happen to take a screenshot that you are not comfortable sharing with the researchers, you will be given an opportunity to remove it.

Any other questions? Feel free to ask at j.kucera1@newcastle.ac.uk.

This study is conducted by [Open Lab](#) at Newcastle University, 1 Science Square, Newcastle upon Tyne, NE4 5TG, United Kingdom.

Still interested?



Apply to participate

F.2 Pre-screening Questionnaire

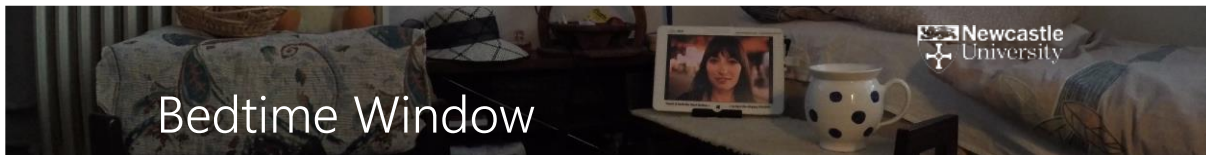

Thank you for your interest in our study! In order to apply, please fill in the following questionnaire with your partner.

A bit about you

| | you | your partner |
|---|----------------------|----------------------|
| Where do you live? | <input type="text"/> | <input type="text"/> |
| How old are you? | <input type="text"/> | <input type="text"/> |
| Your occupation? | <input type="text"/> | <input type="text"/> |
| E-mail address you want to be contacted at regarding participation: | <input type="text"/> | <input type="text"/> |

Your relationship

| | |
|---|----------------------|
| How long have you been in a relationship? | <input type="text"/> |
| How long have you lived together? | <input type="text"/> |

Living apart

| | |
|--|----------------------|
| How long have you lived apart from each other? | <input type="text"/> |
| How often do you visit each other? | <input type="text"/> |
| What is the time zone difference between you? | <input type="text"/> |

Your place when living apart

| | you | your partner |
|---|--|--|
| Do you share your home with someone else other than your partner? | <input type="radio"/> Yes <input type="radio"/> No | <input type="radio"/> Yes <input type="radio"/> No |
| Do you share your bedroom with someone else other than your partner?? | <input type="radio"/> Yes <input type="radio"/> No | <input type="radio"/> Yes <input type="radio"/> No |
| Do you sleep in a separate room for sleeping only, i.e. bedroom? | <input type="radio"/> Yes <input type="radio"/> No | <input type="radio"/> Yes <input type="radio"/> No |
| Do you have a broadband internet connection or better? | <input type="radio"/> Yes <input type="radio"/> No | <input type="radio"/> Yes <input type="radio"/> No |

Almost done!

| | |
|--|----------------------|
| When would you be able to start the study? | <input type="text"/> |
| Is there anything else you think we should know about? | <input type="text"/> |

I confirm both I and my partner are over 18 years of age and interested in participating in the study.

Apply

Any questions? Feel free to ask at j.kucera1@newcastle.ac.uk.

This study is conducted by [Open Lab](#) at Newcastle University, 1 Science Square, Newcastle upon Tyne, NE4 5TG, United Kingdom.

F.3 Consent Form



Bedtime Window Study — Consent Form

I agree to participate in the study *Bedtime Window Study* being carried out by Newcastle University.

- I have read and understood the information sheet about taking part.
- A researcher has answered any questions that I had.
- I understand that any collected data will be used for research purposes only.
- I understand that I will not be mentioned by name on any documents or in any presentations about the research.
- I understand that I can withdraw from the study at any time without needing to give a reason.

Signature of participant:

Name in capitals: Date:

Date of birth: Gender:

Signature of the researcher:

Name in capitals:

Device number:

F.4 Information Sheet



Bedtime Window Displays Study — Information Sheet (white tablet)

Thank you for taking part in the bedroom displays study! This sheet should guide you through the study and answer some of the questions you might have. Should you have any other requests or if you encounter any problem during the course of the study, please contact me at j.kucera1@ncl.ac.uk.

Who are the researchers and what is the research about?

My name is Jan Kučera and I am conducting this study as a PhD student at Open Lab, Newcastle University, supervised by Patrick Olivier.

My research is about display technologies in challenging settings such as theatres or bedrooms. My previous study explored the suitability of existing displays for bedrooms and I am now looking into how such technology can support partners in long distance relationships. I am in such a relationship myself and I have been developing and piloting this experience with my partner for couple of months, so I hope you will enjoy it as much as we did!

What do I get?

You should have received a package that contains:



a tablet device



power adapter for the tablet



USB ambient light sensor



2 stands for the tablet

You might need to locate several things on the tablet:

left side view



right side view



How do I set it up?

Please proceed as follows:

1. Place the device in your bedroom, preferably so that you can see the display and reach it from the bed when you want to interact with the device. Feel free to use the supplied stands if helpful. In order to adjust the stand angle, you need to push the round button on the side:



The reason you have two is for the case you wanted to tilt the tablet downwards:



2. Open the **USB socket** on right side of the device and plug the sensor in.
3. Open the **power socket** and plug the power adapter in. It should look like this:



4. Press the **power button** on the side of the device. The device will vibrate, a purple light on the sensor should blink once and the device will start up.

5. The device should boot into a window with a list of available wireless networks:

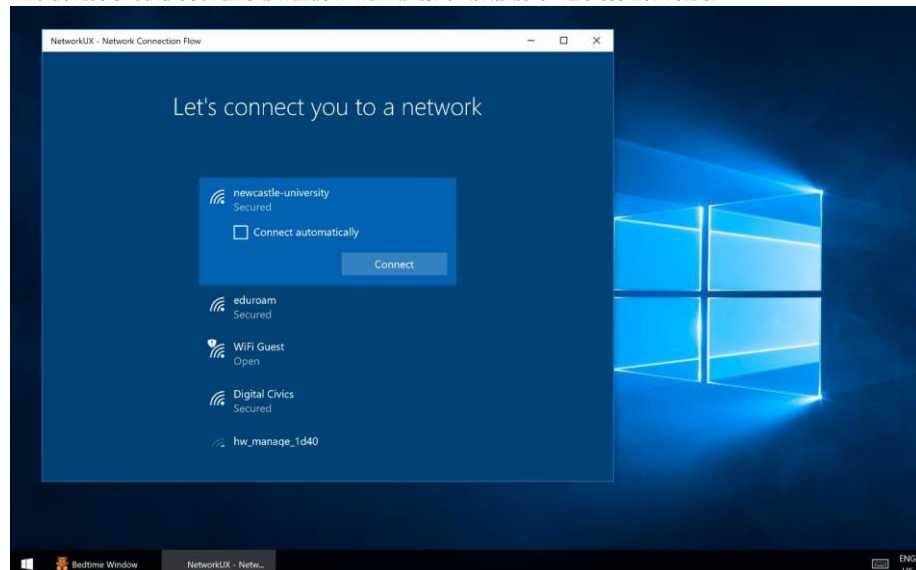

- Tap the network you want to connect the device to.
- Ensure **Connect automatically** is checked.
- Tap Connect.
- If applicable, tap the username/password boxes, fill in your wireless network credentials and tap OK to connect, or finish connecting in the browser.

Once connected, the Bedtime Window should automatically appear. You can also tap 'Bedtime Window' at the bottom of the screen to switch to it manually.

Should you need to get to the network list window later, for example to troubleshoot the network connectivity or if you need to connect to a different network, just tap the globe icon in the top right corner of the Bedtime Window: 🌐

6. Take a picture of how you set up the device in the room and e-mail it to me at j.kucera1@ncl.ac.uk. This is only for verification purposes and will not be shared with anyone unless I reach out to you asking for an extra permission.

If you received the device in mail, please keep the box and the package filling so that we can arrange collection after the study is over.

What do I need to do?

Short version: leave the device on 24/7 in your bedroom as an ambient display (feel free to cover it or turn away whenever you don't feel comfortable), have fun with the device or just try to live with it for a bit provide feedback if you find something exciting or annoying

The system sends a picture every 5 seconds to your partner and allows you to draw with your finger on a shared, real-time inking space. Anything you draw automatically appears on partner's display and starts slowly fading away.

There are no given tasks you need to complete. Use the device as much as you want in any way you want – or just leave it around untouched, but we ask you to keep it running all the time, even when you are not in the room or when you leave for a weekend.

I understand that for some of you it may be sometimes uncomfortable to share pictures from such a private space even with your partner. In such cases, feel free to cover the camera or turn the device away. Try to avoid covering the ambient light sensor (the white USB thing plugged in from the side).

Can I change the device location once set up?

Yes. Feel free to try various places to find out what suits you the most.

Can I take the device with me to another room or out of the house?

Yes. It is your device and your experience. If you feel that your daily schedules do not really leave you any interesting common time to take advantage of the system, you can try to take it with you. Please respect the privacy of your partner and others that might inadvertently end up being visible on the device.

Can I turn off, flip or cover the device for night?

I cannot prevent you from covering or flipping the device for night, however note that this study is especially about sharing the bedtime with your partner – before you fall asleep and when you wake up. If you leave or put the device in 'Paper-like' mode, it will turn off the display and camera whenever the light sensor detects darkness.

What data does the device record?

The device records the following:

1. Tapping on any of the buttons on the screen.
2. Drawing telemetry – colour, width, duration and length of strokes during drawing. (what you draw or write cannot be reconstructed from the recorded data)
3. Highest measured light intensity per minute. (for assessing lighting conditions in bedroom environments)
4. Highest accelerometer reading per minute. (for detecting active device use)
5. Highest number of faces detected in the camera image per minute. (for detecting passive device use)
6. Textual feedback and/or screenshot, if and only if you explicitly take and save it using the smiley faces.

What data does the device transfer over network?

The device transfers the following to your partner:

1. Inking data.
2. Encrypted still images from the camera. Only your partner's device is able to decrypt them.
3. Timeline history (highest ambient light reading per minute for the past 24 hours).
4. Diagnostics information: software version, status and any errors encountered.

Is audio or video being recorded at any time?

No. Audio hardware is disabled on the device and the video camera is only shown to you in the live preview window and it is not recorded.

How do I withdraw from the study?

Participation is completely voluntary and you can withdraw from the study at any time with no explanation. Just drop me an e-mail to j.kucera1@ncl.ac.uk and we will figure out collecting the system back.

It does not work!



If you happen to encounter this screen (lock screen), please contact me. While you might be able to dismiss it by tapping on the screen, an important aspect of the software needs to be fixed.



If you happen to encounter this screen (logon screen) on first power up, use the password *study*. If you see it at any other time during the study, please contact me, as an important aspect of the software needs to be fixed.



If the display appears off or black when you don't expect it (i.e. during the day), try to press and hold the **increase brightness** button on the side of the tablet. If it doesn't help, please email me at j.kucera1@ncl.ac.uk.

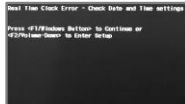

If you see **Real Time Clock Error** on power up, you can continue by touching the Start button . The clock should synchronise as soon as the device connects to the network.

What does it do?

The user experience looks like below:



Camera preview

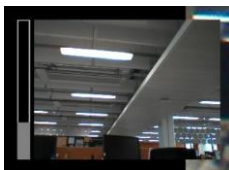

In the bottom left corner, you see a live preview from the camera on your device with a progress bar that is constantly going up. Once the progress bar reaches the top (every 5 seconds), the picture from camera is taken and sent to your partner.

Tip: You can tap the live preview image to send the current image immediately.

Display mode

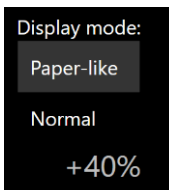

In the top left corner, you can switch the display between paper-like mode and normal mode. In normal mode, the display stays bright like any other display. In paper-like mode, the display tries to be as bright as a piece of paper, which means that when it's dark, you won't be able to see anything on the display and it will not distract you during sleep.

You can use the hardware [increase brightness](#) and [decrease brightness](#) buttons on the side of the tablet (marked with the ○● label) to make the display brighter or darker, for example if you wanted to interact with the device at night in the dark. A percentage will appear on the display to let you know you are overriding the default brightness settings.

Tip: You can tap the percentage to reset the display into its default brightness.

Inking controls



The top panel allows you to control various properties of the ink you can draw with: colour, width and duration. Any ink on the screen is always disappearing. The **S M H D** buttons affect the speed of the disappearing as follows: **S** makes it last one second, **M** one minute, **H** one hour, and **D** one day.



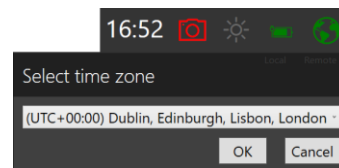

You cannot erase individual strokes, but you can use the clear all button  to clear both yours and your partner's screen immediately.

Status icons

In the top right corner, there is a clock and few status indicators. You can tap the clock to change the device time zone, so you can set it to show either yours or your partner's time.



If everything is working OK, all indicators will be green. Here is some troubleshooting information:

-  If the camera indicator is red, the system is not receiving any images from the device camera. Tap and hold your finger on the display for a few seconds to open a menu and restart the device. If that does not help, please contact me at j.kucera1@ncl.ac.uk.
-  If the sensor indicator is grey, the system does not see the ambient light sensor, and the paper-like mode will not work. Make sure the sensor (the white USB thing) is plugged in. Try to unplug it and plug it back again.
-  If the battery indicator is red or grey, the system is running from battery rather than from external power source. The indicator will reflect remaining battery capacity. Feel free to unplug the device if you want to move or play with it for a bit, but don't forget to plug it back.
-  If the network connectivity indicator is red or grey, the system is not connected. The system is resilient to network dropouts and should reconnect again as soon as possible. If that is not happening or if you changed your wireless network settings, you can tap the icon to go to the wireless networks window and resolve the issue there.

Timeline



The timeline on the right side displays readings from both yours and your partner's ambient light sensor past 24 hours, with midnights at the top and the bottom. There is a horizontal line indicating the current time of the day.

System feedback

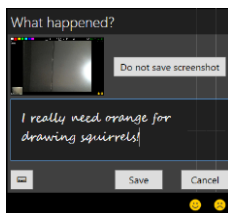

In the bottom right corner there is a happy smile 😊 and a sad smile 😞 icon. You can tap these to provide any feedback or thoughts you have about the system. Any time you feel something is exciting or frustrating, it would be great if you could note down your experience. During the final interview, we will review together the feedback you have submitted.

The system takes a screenshot whenever you tap any of the smileys and when you tap Save, it saves it together with your note to the device. If you do not want to show me the screenshot during interview, you can remove the screenshot by tapping Do



not save screenshot button before saving the feedback. Screenshots will not be published unless I reach out to you asking for an extra permission. The feedback data stays on the device and is never transferred over network.

Thank you again for your participation and have fun!

Jan Kučera

F.5 Initial Interview Supplemental Questionnaire

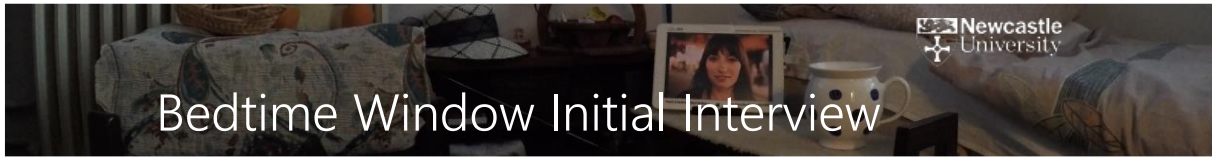

Your device number:

1. In the last working week, please indicate how often were you in touch with your partner using the following technologies:

| | every day | few times a week | once a week | once a month | less | never |
|------------------------------|-----------------------|-----------------------|-----------------------|-----------------------|-----------------------|-----------------------|
| text (messaging, chat) | <input type="radio"/> | <input type="radio"/> | <input type="radio"/> | <input type="radio"/> | <input type="radio"/> | <input type="radio"/> |
| inking or handwritten | <input type="radio"/> | <input type="radio"/> | <input type="radio"/> | <input type="radio"/> | <input type="radio"/> | <input type="radio"/> |
| photos (mms, snapchat, etc.) | <input type="radio"/> | <input type="radio"/> | <input type="radio"/> | <input type="radio"/> | <input type="radio"/> | <input type="radio"/> |
| voice or phone calls | <input type="radio"/> | <input type="radio"/> | <input type="radio"/> | <input type="radio"/> | <input type="radio"/> | <input type="radio"/> |
| video calls | <input type="radio"/> | <input type="radio"/> | <input type="radio"/> | <input type="radio"/> | <input type="radio"/> | <input type="radio"/> |

2. How satisfied are you with the amount of communication you have with your partner through these technologies?

| | I would prefer much less | I wouldn't mind less | I am happy | I wouldn't mind more | I would prefer much more |
|------------------------------|--------------------------|-----------------------|-----------------------|-----------------------|--------------------------|
| text (messaging, chat) | <input type="radio"/> | <input type="radio"/> | <input type="radio"/> | <input type="radio"/> | <input type="radio"/> |
| inking or handwritten | <input type="radio"/> | <input type="radio"/> | <input type="radio"/> | <input type="radio"/> | <input type="radio"/> |
| photos (mms, snapchat, etc.) | <input type="radio"/> | <input type="radio"/> | <input type="radio"/> | <input type="radio"/> | <input type="radio"/> |
| voice or phone calls | <input type="radio"/> | <input type="radio"/> | <input type="radio"/> | <input type="radio"/> | <input type="radio"/> |
| video calls | <input type="radio"/> | <input type="radio"/> | <input type="radio"/> | <input type="radio"/> | <input type="radio"/> |

3. What influence does the technology have on your relationship?

| | very negative | slightly negative | neutral | slightly positive | very positive | N/A not using |
|------------------------------|-----------------------|-----------------------|-----------------------|-----------------------|-----------------------|-----------------------|
| text (messaging, chat) | <input type="radio"/> | <input type="radio"/> | <input type="radio"/> | <input type="radio"/> | <input type="radio"/> | <input type="radio"/> |
| inking or handwritten | <input type="radio"/> | <input type="radio"/> | <input type="radio"/> | <input type="radio"/> | <input type="radio"/> | <input type="radio"/> |
| photos (mms, snapchat, etc.) | <input type="radio"/> | <input type="radio"/> | <input type="radio"/> | <input type="radio"/> | <input type="radio"/> | <input type="radio"/> |
| voice or phone calls | <input type="radio"/> | <input type="radio"/> | <input type="radio"/> | <input type="radio"/> | <input type="radio"/> | <input type="radio"/> |
| video calls | <input type="radio"/> | <input type="radio"/> | <input type="radio"/> | <input type="radio"/> | <input type="radio"/> | <input type="radio"/> |

4. What do you usually use the technology for?

| | text (messaging, chat) | inking or handwritten | photos (mms, snapchat) | voice or phone calls | video calls |
|--|--------------------------|--------------------------|--------------------------|--------------------------|--------------------------|
| sharing what you have been up to during the day or in the past | <input type="checkbox"/> | <input type="checkbox"/> | <input type="checkbox"/> | <input type="checkbox"/> | <input type="checkbox"/> |
| sharing what is happening right now, what you are doing, what you are wearing etc. | <input type="checkbox"/> | <input type="checkbox"/> | <input type="checkbox"/> | <input type="checkbox"/> | <input type="checkbox"/> |
| comparing your and partner's location - current weather, temperature, etc. | <input type="checkbox"/> | <input type="checkbox"/> | <input type="checkbox"/> | <input type="checkbox"/> | <input type="checkbox"/> |
| planning or talking about the following day/the future | <input type="checkbox"/> | <input type="checkbox"/> | <input type="checkbox"/> | <input type="checkbox"/> | <input type="checkbox"/> |
| intimacy | <input type="checkbox"/> | <input type="checkbox"/> | <input type="checkbox"/> | <input type="checkbox"/> | <input type="checkbox"/> |
| random communication about anything | <input type="checkbox"/> | <input type="checkbox"/> | <input type="checkbox"/> | <input type="checkbox"/> | <input type="checkbox"/> |

5. Please rank the technologies in order of importance to your relationship:

- text (messaging, chat)
- inking or handwritten
- photos (mms, snapchat, etc.)
- voice or phone calls
- video calls

6. How much do you agree with the following:

| | strongly disagree | slightly disagree | neutral | slightly agree | strongly agree |
|---|-----------------------|-----------------------|-----------------------|-----------------------|-----------------------|
| In general, technology has positively supported my long-distance relationship(s) so far. | <input type="radio"/> | <input type="radio"/> | <input type="radio"/> | <input type="radio"/> | <input type="radio"/> |
| In general, current technology is providing me all I need in a long-distance relationship. | <input type="radio"/> | <input type="radio"/> | <input type="radio"/> | <input type="radio"/> | <input type="radio"/> |
| I would find it challenging to stay in a long-distance relationship without digital technology. | <input type="radio"/> | <input type="radio"/> | <input type="radio"/> | <input type="radio"/> | <input type="radio"/> |
| The feeling of being remotely present is an important part of a relationship to me. | <input type="radio"/> | <input type="radio"/> | <input type="radio"/> | <input type="radio"/> | <input type="radio"/> |
| Being together when falling asleep and waking up are important moments of a relationship to me. | <input type="radio"/> | <input type="radio"/> | <input type="radio"/> | <input type="radio"/> | <input type="radio"/> |

7. You are going to try a new way to connect with your partner. Based on the introduction of the system before the interview, how important do you think the individual features of the system will be to you?

| | not at all important | not very important | neutral | slightly important | very important |
|-------------------------|-----------------------|-----------------------|-----------------------|-----------------------|-----------------------|
| regular picture sharing | <input type="radio"/> | <input type="radio"/> | <input type="radio"/> | <input type="radio"/> | <input type="radio"/> |
| shared inking | <input type="radio"/> | <input type="radio"/> | <input type="radio"/> | <input type="radio"/> | <input type="radio"/> |
| paper-like display | <input type="radio"/> | <input type="radio"/> | <input type="radio"/> | <input type="radio"/> | <input type="radio"/> |
| 24 hours light timeline | <input type="radio"/> | <input type="radio"/> | <input type="radio"/> | <input type="radio"/> | <input type="radio"/> |

Submit

F.6 Final Interview Supplemental Questionnaire

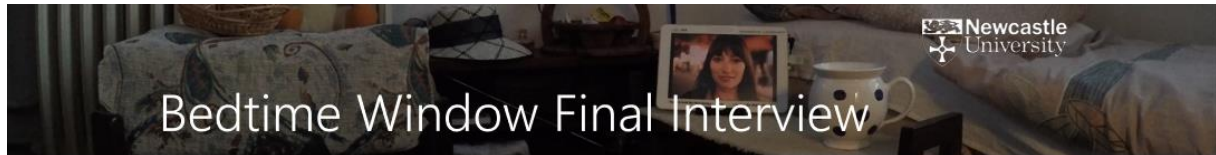

Your device number:

1. Did the system affect how often you used other technologies (other than the Bedtime Window):

| | we used it much less | we used it slightly less | no change | we used it slightly more | we used it much more |
|------------------------------|-----------------------|--------------------------|-----------------------|--------------------------|-----------------------|
| text (messaging, chat) | <input type="radio"/> | <input type="radio"/> | <input type="radio"/> | <input type="radio"/> | <input type="radio"/> |
| inking or handwritten | <input type="radio"/> | <input type="radio"/> | <input type="radio"/> | <input type="radio"/> | <input type="radio"/> |
| photos (mms, snapchat, etc.) | <input type="radio"/> | <input type="radio"/> | <input type="radio"/> | <input type="radio"/> | <input type="radio"/> |
| voice or phone calls | <input type="radio"/> | <input type="radio"/> | <input type="radio"/> | <input type="radio"/> | <input type="radio"/> |
| video calls | <input type="radio"/> | <input type="radio"/> | <input type="radio"/> | <input type="radio"/> | <input type="radio"/> |

2. What did you use the individual features of the Bedtime Window for?

| | regular picture sharing | shared inking | 24 hours light timeline |
|--|--------------------------|--------------------------|--------------------------|
| sharing what you have been up to during the day or in the past | <input type="checkbox"/> | <input type="checkbox"/> | <input type="checkbox"/> |
| sharing what is happening right now, what you are doing, what you are wearing etc. | <input type="checkbox"/> | <input type="checkbox"/> | <input type="checkbox"/> |
| comparing your and partner's location - current weather, temperature, etc. | <input type="checkbox"/> | <input type="checkbox"/> | <input type="checkbox"/> |
| planning or talking about the following day/the future | <input type="checkbox"/> | <input type="checkbox"/> | <input type="checkbox"/> |
| intimacy | <input type="checkbox"/> | <input type="checkbox"/> | <input type="checkbox"/> |
| random communication about anything | <input type="checkbox"/> | <input type="checkbox"/> | <input type="checkbox"/> |

3. How important were the individual features of the system to you?

| | not at all important | not very important | neutral | slightly important | very important |
|-------------------------|-----------------------|-----------------------|-----------------------|-----------------------|-----------------------|
| regular picture sharing | <input type="radio"/> | <input type="radio"/> | <input type="radio"/> | <input type="radio"/> | <input type="radio"/> |
| shared inking | <input type="radio"/> | <input type="radio"/> | <input type="radio"/> | <input type="radio"/> | <input type="radio"/> |
| paper-like display | <input type="radio"/> | <input type="radio"/> | <input type="radio"/> | <input type="radio"/> | <input type="radio"/> |
| 24 hours light timeline | <input type="radio"/> | <input type="radio"/> | <input type="radio"/> | <input type="radio"/> | <input type="radio"/> |

4. Please rank the system features in the order of importance to you:

| | | |
|----------------------------------|----------------------------------|-------------------------|
| <input type="button" value="▲"/> | <input type="button" value="▼"/> | regular picture sharing |
| <input type="button" value="▲"/> | <input type="button" value="▼"/> | shared inking |
| <input type="button" value="▲"/> | <input type="button" value="▼"/> | paper-like display |
| <input type="button" value="▲"/> | <input type="button" value="▼"/> | 24 hours light timeline |

5. How much do you agree with the following:

| | strongly disagree | slightly disagree | neutral | slightly agree | strongly agree |
|---|-----------------------|-----------------------|-----------------------|-----------------------|-----------------------|
| The feeling of being remotely present is an important part of a relationship to me. | <input type="radio"/> | <input type="radio"/> | <input type="radio"/> | <input type="radio"/> | <input type="radio"/> |
| The system made me feel present at my partner's place. | <input type="radio"/> | <input type="radio"/> | <input type="radio"/> | <input type="radio"/> | <input type="radio"/> |
| The system made me feel my partner is present at my place. | <input type="radio"/> | <input type="radio"/> | <input type="radio"/> | <input type="radio"/> | <input type="radio"/> |

| | strongly disagree | slightly disagree | neutral | slightly agree | strongly agree |
|---|-----------------------|-----------------------|-----------------------|-----------------------|-----------------------|
| Being together when falling asleep and waking up are important moments of a relationship to me. | <input type="radio"/> | <input type="radio"/> | <input type="radio"/> | <input type="radio"/> | <input type="radio"/> |
| I felt comfortable sharing the time when I fall asleep and/or wake up with my partner. | <input type="radio"/> | <input type="radio"/> | <input type="radio"/> | <input type="radio"/> | <input type="radio"/> |
| Seeing my partner fall asleep and/or wake up was valuable to me. | <input type="radio"/> | <input type="radio"/> | <input type="radio"/> | <input type="radio"/> | <input type="radio"/> |
| Paper-like display allowed us to stay connected around bedtime. | <input type="radio"/> | <input type="radio"/> | <input type="radio"/> | <input type="radio"/> | <input type="radio"/> |
| | strongly disagree | slightly disagree | neutral | slightly agree | strongly agree |
| I would prefer if the camera was sending video all the time rather than occasional pictures only. | <input type="radio"/> | <input type="radio"/> | <input type="radio"/> | <input type="radio"/> | <input type="radio"/> |
| I would prefer if the pictures were shared only when I say, not automatically. | <input type="radio"/> | <input type="radio"/> | <input type="radio"/> | <input type="radio"/> | <input type="radio"/> |
| Seeing my partner's place empty was valuable to me. | <input type="radio"/> | <input type="radio"/> | <input type="radio"/> | <input type="radio"/> | <input type="radio"/> |
| | strongly disagree | slightly disagree | neutral | slightly agree | strongly agree |
| The system has connected me with my partner in a way that other technology have not. | <input type="radio"/> | <input type="radio"/> | <input type="radio"/> | <input type="radio"/> | <input type="radio"/> |
| The system had a positive impact on my relationship. | <input type="radio"/> | <input type="radio"/> | <input type="radio"/> | <input type="radio"/> | <input type="radio"/> |
| The system has filled a gap in my relationship. | <input type="radio"/> | <input type="radio"/> | <input type="radio"/> | <input type="radio"/> | <input type="radio"/> |
| I would recommend the system to other partners in a long-distance relationship. | <input type="radio"/> | <input type="radio"/> | <input type="radio"/> | <input type="radio"/> | <input type="radio"/> |

Submit

Appendix G. Paper-like Display Manual Calibration

This appendix describes the steps an end-user can perform with their existing display, a sensor and Philips Hue lights to obtain the calibration data described in chapter 5.3. As has been noted previously, the point of the calibration process is to establish a relationship between a particular sensor, a particular display panel and the human vision characteristics. If the display is calibrated and the sensor outputs values in XYZ or an equivalent colour space, none of these steps are needed.

G.1 Display Primaries

Display primaries can typically be found in the display panel datasheet, and the device manufacturer might be able to share the display panel model with you. If you are unable to find the gamut values, you can use Philips Hue lights to estimate them, assuming that the lights' gamut covers the display gamut.

Set-up:

1. Carry this procedure in total darkness.
2. Place the display next to a white wall or a sheet of white paper.
3. Turn the Philips Hue lights towards the white surface.

Steps:

1. Set the display to show red colour, i.e. RGB values of 255,0,0.
2. Adjust the Philips Hue lights so that it visually matches the colour on the screen.
3. Note down the current xy values from Philips Hue lights, and convert them to $u'v'$ using (2.25). This is the red primary gamut point.
4. Repeat steps 3-5 for
 - a. Green (RGB 0,255,0)
 - b. Blue (RGB 0,0,255)
 - c. White (RGB 255,255,255)

There is no sensor involved in this process. The outcome is 4 pairs of RGB to $u'v'$ mappings.

G.2 Linear Brightness Calibration

A high-level overview of the brightness calibration procedure and visualization of the calibration data is given in chapter 5.3.1. In this part, we establish perceived display brightness relative to the sensor reading under the assumption that the relationship is linear (this can be verified by measuring various brightness levels with the sensor). If the display does not allow for brightness control, skip this part.

Set-up:

1. Place the display next to a white wall or a sheet of white paper. Alternatively, if you have a reference image to calibrate with, place the display next to the image.
2. If you have an external sensor, plug it into the device.
3. Turn the Philips Hue lights towards the white surface (or the reference image) and change its colour to the displays' white gamut point.

Steps:

1. Set display to show white colour, i.e. RGB values of 255,255,255 (or the reference image).
2. Set the display to the minimum brightness value.
3. Adjust the Philips Hue lights brightness so that the intensity of the light reflected from the reference wall/paper/image matches the brightness of the display.
4. Measure the incident light with the sensor (using the clear channel).
5. Obtain the second point:
 - a. If the display can produce brighter image than the Philips Hue lights (common scenario), set the Philips Hue lights brightness to its maximum (i.e. 254) and adjust the display brightness setting so that the intensity of the light reflected from the reference wall/paper/image matches the brightness of the display.
 - b. Otherwise, set the display to the maximum brightness value and adjust the Philips Hue lights brightness so that the intensity of the light reflected from the reference wall/paper/image matches the brightness of the display.
6. Measure the incident light with the sensor (using the clear channel).

The outcome is 2 pairs of display sensor reading to brightness value mapping. The algorithm linearly interpolates between the given points. If the display does not have a linear response to the brightness values, simply record sensor readings for several brightness levels.

G.3 Chromaticity Calibration

A high-level overview of the chromaticity calibration procedure and visualization of the calibration data is given in chapter 5.3.2. In this part, we map the perceived chromaticity shown on the display to the sensor readings. Optionally, we also collect any brightness adjustments dependant on the displayed chromaticity.

Set-up:

1. Place the display next to a white wall or a sheet of white paper. Alternatively, if you have a reference image to calibrate with, place the display next to the image.
2. If you have an external sensor, plug it into the device.
3. Turn the Philips Hue lights towards the white surface (or the reference image) and change its colour to the displays' white gamut point.

Steps:

1. Set the display to show white colour or the reference image.
2. Set the display to full brightness.
3. Set the Philips Hue lights to the xy values of the display's red gamut point.
4. For easier user experience, you can also convert the xy values to RGB and apply them to the display as the algorithm output. Alternatively, if previous calibration data already exists, you can set the display to the algorithm output using the existing data.
5. Adjust the display so that it looks as close as possible to the reference wall/paper/image.
6. If needed, adjust the display brightness to better match the reference wall/paper/image.
7. Measure the incident light with the sensor, both using the colour channels and the clear channel. Convert the colour reading into $\hat{u}'\hat{v}'$ and store.
8. Use the clear channel reading to predict the display brightness using the algorithm. Store the difference between the prediction and current setting as the brightness correction.
9. Convert the display setting into $u'v'$ and store.
10. Repeat steps 3-9 for all calibration points. The remaining points used in this thesis are:
 - a. display's green and blue gamut points
 - b. display's red-green, red-blue and green-blue gamut midpoints
 - c. centre of gravity of the gamut points in the $u'v'$ space
 - d. 7000K daylight ($x = 0.3064, y = 0.3165$)
 - e. 3200K incandescent light ($x = 0.4234, y = 0.3990$)

The outcome is $\hat{u}' \hat{v}'$ sensor reading to $u' v'$ display output + brightness adjustment mapping. The algorithm linearly interpolates the $u' v'$ output from the closest three calibration points.

For an illustrative example, imagine the calibration data to look like this:

| sensor reading display output | | | | | |
|-------------------------------|------------|------------|------|------|-----------------------|
| # | \hat{u}' | \hat{v}' | u' | v' | brightness correction |
| 1 | 0 | 0 | 0.1 | 0.1 | ± 0 |
| 2 | 0 | 2 | 0.2 | 0.1 | ± 0 |
| 3 | 2 | 0 | 0.2 | 0.2 | ± 0 |

Let us see how this is processed when the sensor reads RGB values that transform into $\hat{u}' = 0.666$, $\hat{v}' = 0.666$. We find that this point falls inside the triangle made of $\hat{u}' \hat{v}'$ points #1-#2-#3, so we construct a triangle ABC from these $\hat{u}' \hat{v}'$ sensor readings, i.e. A = [0, 0], B = [0, 2] and C = [2, 0], and a triangle UVW from the corresponding $u' v'$ display output values, i.e. U = [0.1, 0.1], V = [0.2, 0.1], W = [0.2, 0.2].

We express the $\hat{u}' \hat{v}'$ point in the barycentric coordinates of the ABC triangle. Since the measured point happens to be at its centre of gravity, $p_1 = 0.333$, $p_2 = 0.333$.

We calculate a point with the same barycentric coordinates in the UVW triangle. Since it is the centre of gravity, $u' = 0.166$, $v' = 0.133$. This is our desired display settings, convert it to RGB and adjust the display accordingly.

As Cool As Simple