

University of Groningen

The Plasma Membrane of *Saccharomyces cerevisiae*

VANDERREST, ME; KAMMINGA, AH; NAKANO, A; ANRAKU, Y; POOLMAN, B; KONINGS, WN

Published in:
 Microbiological Reviews

IMPORTANT NOTE: You are advised to consult the publisher's version (publisher's PDF) if you wish to cite from it. Please check the document version below.

Document Version
 Publisher's PDF, also known as Version of record

Publication date:
 1995

[Link to publication in University of Groningen/UMCG research database](#)

Citation for published version (APA):

VANDERREST, ME., KAMMINGA, AH., NAKANO, A., ANRAKU, Y., POOLMAN, B., & KONINGS, WN. (1995). The Plasma Membrane of *Saccharomyces cerevisiae*: Structure, Function, and Biogenesis. *Microbiological Reviews*, 59(2), 304-322.

Copyright

Other than for strictly personal use, it is not permitted to download or to forward/distribute the text or part of it without the consent of the author(s) and/or copyright holder(s), unless the work is under an open content license (like Creative Commons).

The publication may also be distributed here under the terms of Article 25fa of the Dutch Copyright Act, indicated by the "Taverne" license. More information can be found on the University of Groningen website: <https://www.rug.nl/library/open-access/self-archiving-pure/taverne-amendment>.

Take-down policy

If you believe that this document breaches copyright please contact us providing details, and we will remove access to the work immediately and investigate your claim.

Downloaded from the University of Groningen/UMCG research database (Pure): <http://www.rug.nl/research/portal>. For technical reasons the number of authors shown on this cover page is limited to 10 maximum.

The Plasma Membrane of *Saccharomyces cerevisiae*: Structure, Function, and Biogenesis

MICHEL E. VAN DER REST,¹ ANNE H. KAMMINGA,¹ AKIHIKO NAKANO,²
YASUHIRO ANRAKU,² BERT POOLMAN,¹ AND WIL N. KONINGS^{1*}

Department of Microbiology, Groningen Biomolecular Sciences and Biotechnology Institute, University of Groningen, 9751 NN Haren, The Netherlands,¹ and Department of Plant Sciences, Graduate School of Science, University of Tokyo, Hongo, Bunkyo, Tokyo 113, Japan²

INTRODUCTION	304
STRUCTURE OF THE PLASMA MEMBRANE	305
LIPID COMPOSITION AND ROLE OF LIPIDS IN THE PLASMA MEMBRANE	305
Phospholipids	305
Fatty Acyl Chains	307
Head Groups	307
Sphingolipids	307
Sterols	307
BIOCHEMICAL PATHWAYS FOR LIPID SYNTHESIS	308
Phospholipid Biosynthesis	308
Sphingolipid Biosynthesis	308
Ergosterol Biosynthesis	309
LIPID SORTING	309
PROTEIN SYNTHESIS AND SORTING TO THE PLASMA MEMBRANE	309
PROTEIN CONTENT OF THE PLASMA MEMBRANE	311
PRIMARY TRANSPORT PROTEINS	311
Plasma Membrane ATPases	311
ABC Transporters	313
PASSIVE AND FACILITATED DIFFUSION ACROSS THE PLASMA MEMBRANE	313
Passive Diffusion	313
Channels	313
Secondary Transport Proteins	313
Uniport	314
Symport	314
Ions	314
Sugars	314
Amino acids	315
Nucleosides	315
Antiport	315
Regulation of Secondary Solute Transport	315
ISOLATION OF FUNCTIONAL PLASMA MEMBRANES	316
FUSION OF PLASMA MEMBRANES WITH LIPOSOMES	316
SECRETORY VESICLES	317
FUNCTIONAL STUDIES IN HYBRID MEMBRANES	317
CONCLUDING REMARKS	317
ACKNOWLEDGMENTS	318
REFERENCES	318

INTRODUCTION

The outermost layer of the yeast cell envelope is the cell wall. The cell wall maintains the structure and the rigidity of the cell but is freely permeable for solutes smaller than 600 Da (174). The plasma membrane forms a relatively impermeable barrier for hydrophilic molecules. Specialized proteins mediate the selective uptake and/or secretion of solutes across this membrane.

Transport of solutes into yeast cells has been studied since 1930 (40), but mechanistic aspects of solute transport received substantial attention only after the proposal of the chemiosmotic theory by Mitchell (120). One of the earlier reviews on the energetics of solute transport in yeast cells came from Eddy (56). More recent reviews focused on amino acid transport (76), sugar transport (17, 107), or ion translocation (178) or tabulated the known transport systems in the yeast plasma membrane (31). Although a considerable amount of data is available on the transport processes in the plasma membrane, the translocation mechanisms and the factors that control the rate of transport are poorly understood. The studies are often hampered by a lack of genetically well-defined mutants and/or the lack of artificial membrane systems to study translocation

* Corresponding author. Mailing address: Department of Microbiology, Groningen Biomolecular Sciences and Biotechnology Institute, University of Groningen, Kerklaan 30, 9751 NN Haren, The Netherlands. Phone: 31 50 632150. Fax: 31 50 632154.

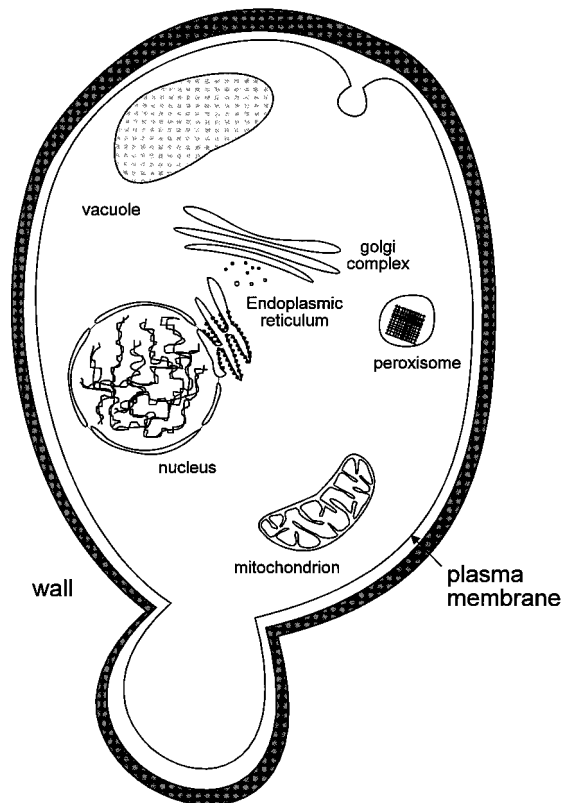

FIG. 1. Schematic representation of the various compartments (organelles) in *S. cerevisiae*.

catalysis *in vitro*. Knowledge about the structure and function of the plasma membrane will be crucial for the manipulation of metabolic processes inside the cell.

In contrast to bacteria, in which the cytoplasmic membrane accommodates all the membrane associated processes, yeasts contain many specialized membranes: (i) the plasma membrane separates the other membranes and cell components from the external medium; (ii) the mitochondrial membrane is involved in metabolic energy generation; (iii) the endoplasmic reticulum (ER) and Golgi apparatus are involved in protein and lipid sorting and synthesis; (iv) the nuclear membrane encases and protects the DNA; and (v) the vacuolar and peroxisomal membranes compartmentalize special metabolic and digestive functions (Fig. 1). This review gives an overview of the different plasma membrane constituents, their origins, and their role in the maintenance and function of the plasma membrane.

STRUCTURE OF THE PLASMA MEMBRANE

The plasma membrane forms a lipid bilayer approximately 7.5 nm wide. It contains a mixture of polar lipids and proteins which, by their interactions, govern the structure of the membrane. The classical Singer and Nicolson model (182) describes the membrane as a continuous sea of lipids dotted with globular proteins which are able to move unrestricted within the plane of the membrane. In this model, the lipids not only diffuse freely within the plane of the membrane but also undergo rotational and transverse motions (flip-flop). The high lateral mobility of lipids in the plasma membrane, however, has recently been questioned, since the mobility of fluorescent lipid probes in the plasma membrane of *Saccharomyces cerevisiae* was found to be anomalously slow (75). Membrane pro-

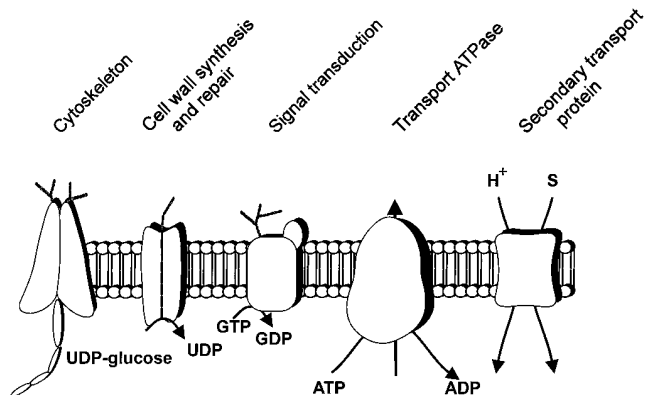

FIG. 2. Classes of membrane proteins found in the *S. cerevisiae* plasma membrane.

teins are often hindered in their lateral motion because of association with other proteins or association with elements of the cytoskeleton or extracellular matrix. Another dominant feature of membrane structure is the asymmetric location of the proteins. Some span the entire length of the membrane (intrinsic), while others are only partially embedded in the membrane and protrude on one side of the membrane (extrinsic). The plasma membrane encompasses proteins involved in transport of solutes, signal transduction, anchoring of the cytoskeleton, and synthesis of outer membrane components (Fig. 2). The lipids of the plasma membrane are asymmetrically disposed across the bilayer. The inner leaflet of the *S. cerevisiae* plasma membrane is enriched in phosphatidylethanolamine (PE), phosphatidylinositol (PI), and phosphatidylserine (PS) (36). In erythrocyte membranes, PE, PI, and PS are also preferentially located in the internal leaflet, while the external leaflet is enriched in phosphatidylcholine (PC) and sphingolipids (138). A striking feature of the plasma membrane lipids is their diversity in size and composition. The major lipid classes are glycerophospholipids, sphingolipids, and sterols (Fig. 3). Glycerophospholipids consist of two fatty acid acyl chains ester-linked to glycerol-3-phosphate; various substituents such as choline (in PC), ethanolamine (in PE), serine (in PS), myo-inositol (in PI), and glycerol (in PG) can be linked to the phosphoryl group. Diphosphatidyl glycerol or cardiolipin, the dimeric form of PG, is also present in yeast cells. Sphingolipids have a ceramide backbone which is composed of a long-chain base phytosphingosine that is N acylated with a hydroxy C_{26} fatty acid. *S. cerevisiae* contains only three major sphingolipids: inositol phosphate ceramide, mannosyl-inositolphosphate-ceramide, and mannosyl-diinositolphosphate-ceramide. Sterols are compact rigid hydrophobic molecules with a polar hydroxyl group. In contrast to higher eukaryotes, in which cholesterol is the most abundant sterol, the yeast plasma membrane contains mainly ergosterol and minor amounts of zymosterol (226).

LIPID COMPOSITION AND ROLE OF LIPIDS IN THE PLASMA MEMBRANE

Phospholipids

Most papers dealing with lipids of *S. cerevisiae* do not consider the composition of the various membrane fractions separately (86, 158). Only a few reports specifically describe the lipid composition of membrane fractions that are $\geq 90\%$ pure (20, 142, 226). A limitation of these studies is the lack of uniformity in experimental conditions (choice of model organ-

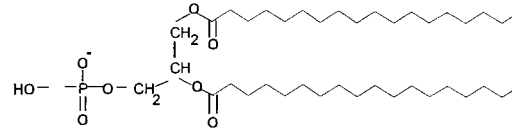
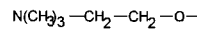
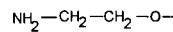
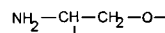
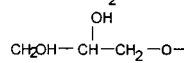
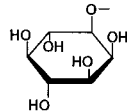
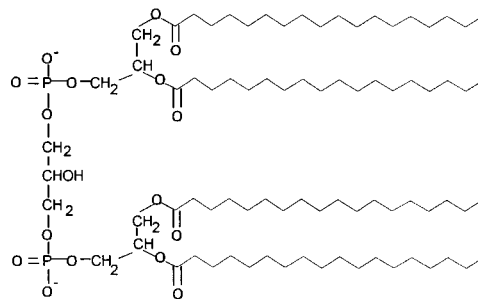
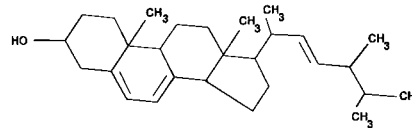
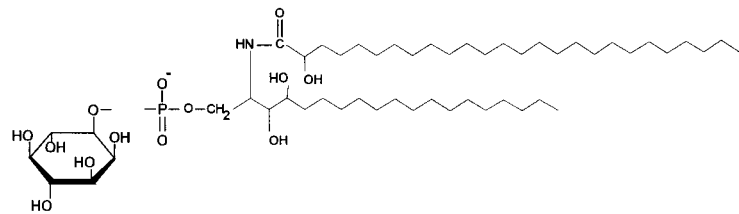
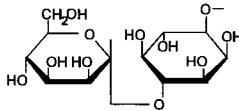
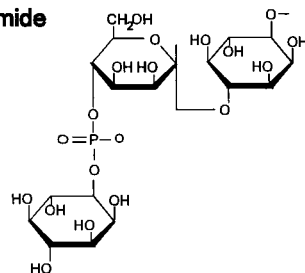
Phosphatidic acid**Phosphatidylcholine****Phosphatidylethanolamine****Phosphatidylserine****Phosphatidylglycerol****Phosphatidylinositol****Cardiolipin****Ergosterol****Inositolphosphate ceramide****Mannosyl inositolphosphate ceramide****Mannosyl diinositolphosphate ceramide**FIG. 3. Lipids found in the *S. cerevisiae* plasma membrane.

ism, growth conditions, lipid extraction procedures, etc.), which makes it difficult to compare the results obtained in different studies. For instance, polar solvents are required to extract the highly polar sphingolipids (98, 143). The differences

in PS and PI content (Table 1) are also quite remarkable and are most probably caused by differences in the strains, culture conditions, and/or extraction procedures used.

The lipid composition of the plasma membrane is complex

TABLE 1. Lipid composition of the plasma membrane of *S. cerevisiae*

Lipid	% Composition according to:	
	Patton and Lester (142)	Zinser et al. (226)
PC	17.0	16.8
PE	14.0	20.3
PI	27.7	17.7
PS	3.8	33.6
CL	4.2	0.2
PA	2.5	3.9
Sphingolipids	30.7	
Others		6.9

and tightly regulated, suggesting that lipids play a role in the activity of the proteins in the plasma membrane. The annular lipids, which are in direct contact with the proteins, are likely to stabilize the proteins in a functional conformation (223). Direct evidence for a role of these annular lipids in *S. cerevisiae* has been presented in studies on two membrane proteins, a chitin synthase and the plasma membrane ATPase (100, 114, 115). It has been shown that delipidation of the ATPase results in inactivation of the enzyme (54). By reconstitution of the purified enzyme, Serrano et al. (180) showed that the ATPase requires lipids with a negatively charged polar head group (with preference for PI and PG) and an unsaturated hydrophobic acyl chain. Purified chitin synthase has a requirement for PS (100).

The influence of the bulk lipids on enzyme activity in yeast mutants with a variety of defects in phospholipid biosynthesis has been investigated. For example, choline or ethanolamine auxotrophs have been used to specifically enrich the plasma membrane for PC or PE, respectively, or to deplete the membrane of PS (4, 5). Several membrane-associated processes are affected by changes in the lipid composition; e.g., the apparent affinity constants for transport of various amino acids are increased in cells enriched with either PC or PE (198, 199). Since these studies were performed with whole cells under conditions that were poorly defined, the data should be interpreted with caution. Trivedi et al. (197) showed that the plasma membrane ATPase activity in PI-enriched cells is enhanced, which could have resulted in a higher proton motive force and, consequently, in a higher driving force for amino acid uptake.

Fatty Acyl Chains

Oleic acid (18:1) and palmitoleic acid (16:1), together with trace amounts of palmitic acid (16:0) and stearic acid (18:0), are the principal fatty acyl chains in *S. cerevisiae* (Table 2) (41, 158). The fatty acyl packing of these chains determines to a large extent the membrane fluidity. The packing increases with increasing length of the acyl chains and decreasing extent of

TABLE 2. Fatty acid composition of *S. cerevisiae*

Chain length and saturation	% of total fatty acids
10:0-14:1	7.0
16:0	12.8
16:1	32.3
18:0	8.0
18:1	28.0
18:3	1.4
20-24	8.0

unsaturation, which leads to a more ordered structure and a decrease in fluidity. Perturbations of the bilayer that decrease the area of a lipid molecule, such as increased hydrostatic pressure, lowering of the temperature, or addition of sterols to phospholipids, also result in a decrease in fluidity (181). The physiological relevance of fluidity is evident from the adaptations of various yeasts to environmental stress. The plasma membrane of the psychrophilic yeast *Leucosporidium frigidum* contains a large amount of unsaturated fatty acyl chains, while the plasma membrane of the thermotolerant yeast *Torulopsis bovina* has a low content of unsaturated fatty acyl chains (216).

Head Groups

The charge of the head groups not only affects the surface potential of the membrane (33) but also can influence the activity of membrane proteins directly (35, 53, 180). The size of the head group determines to a large extent the physical state of the membrane, which is liquid crystalline under most physiologically relevant conditions. Lipids such as PC, PS, PI, and sphingolipids, which have head groups and acyl chains with comparable cross-sectional areas, are cylindrical and organize easily in bilayers. Lipids which have smaller head groups than acyl chains, such as PE, CL, and sterols, are cone shaped and form inverted micelles in solution. High concentrations of such lipids in the membrane may locally induce a high membrane curvature and membrane-packing defect, which can create an environment into which proteins can insert without compromising the barrier function of the membrane (47).

Sphingolipids

Sphingolipids are ubiquitous constituents of eukaryotic plasma membranes. Studies on sphingolipids started with the discovery of these molecules in the human brain in 1884 (196). Current research on sphingolipids is focused primarily on their possible role in signal transduction across the plasma membrane (68, 80, 82, 83). A clear indication for an essential role of sphingolipids in growth and viability came from the isolation of a sphingolipid-defective *S. cerevisiae* mutant. This mutant strain has an obligatory growth requirement for a sphingolipid long-chain base, such as phytosphingosine (217). The mutant lacks serine palmitoyltransferase (147), the first enzyme in sphingolipid long-chain base synthesis.

Patton and Lester (142) have shown that more than 90% of the sphingolipids are located in the plasma membrane and that the sphingolipids constitute about 30% of the total phospholipid content. Sphingolipids have not been detected in isolated mitochondria and nuclear membranes. Since glyco-phospholipids have been found only in wall-bearing eukaryotes, where the molecules are presumably located in the outer leaflet of the plasma membrane (138), it is possible that these lipids have a role in wall synthesis as cell wall anchors (112). Ceramide and other products of sphingolipid turnover have been implicated as second messengers in higher eukaryotic cells (51, 82), but there is no direct evidence for a similar function in *S. cerevisiae* (122). Using suppressor strains lacking sphingolipids, Patton et al. (143) showed that these strains cannot grow at low pH, elevated temperatures, or high salt. Apparently, strains lacking sphingolipids become impaired in proton extrusion by the plasma membrane ATPase and/or the cells become more permeable to protons.

Sterols

The content of sterols in the plasma membranes is a matter for controversy. Bottema et al. (20) reported a molar sterol-

to-phospholipid ratio of 0.365, Zinser et al. (226) gave a ratio of 3.31, while we have calculated from the data of Patton and Lester (142) a ratio of 0.94, which is comparable to the value of 0.81 reported by Rodriguez et al. (163). Since our studies indicate that it is not possible to form well-sealed liposomes with a sterol-to-phospholipid ratio higher than 1 (88a), a membrane in which each phospholipid molecule is surrounded by more than three sterol molecules seems unlikely. The sterols determine to a large extent the rigidity of the plasma membrane, which, in turn may affect the lateral movement and the activity of membrane proteins. Sterols may also create an environment into which polypeptides can insert. For this bulk function, sterol auxotrophs require relatively large amounts of sterols in the medium (15 $\mu\text{g/ml}$) (163). A further role for sterols can be found in cell proliferation, which requires the presence of specific sterols (127). The role of sterols as a trigger for cell proliferation is satisfied at concentrations of 1 to 10 ng/ml . In the region between 0.1 and 15 $\mu\text{g/ml}$, two interesting additional roles for sterols have been defined, i.e., the "critical-domain" and "domain" function. The critical-domain role is observed at 0.1 μg of ergosterol per ml and is essential for growth. Plasma membranes isolated from sterol auxotrophs grown in the presence of 0.1 μg of ergosterol per ml show a thermotropic phase transition of the lipids which is not observed at higher concentrations of ergosterol (163). At the domain concentrations, i.e., between 0.1 and 15 $\mu\text{g/ml}$, the growth yield is increased but the growth rate of a sterol auxotroph is not affected. The existence of sterol-rich and sterol-poor domains in the plasma membranes could be related to these domain functions (20). In model membrane systems, it has been shown that cholesterol has a high affinity for negatively charged phospholipids and for phospholipids which have a low transition temperature. As a result, domains of low and high cholesterol concentration are formed (48, 206). The presence of sterol-rich domains in the plasma membrane is supported by the effects of nystatin on the differences in Arrhenius kinetics of the plasma membrane ATPase and chitin synthase in wild-type and sterol mutants (without ergosterol in the plasma membrane) (20). Nystatin disrupts the bilayer structure of the membranes by complexing with ergosterol. Nystatin has no effect on the ATPase activity, while the chitin synthase activity is greatly reduced (20). It has been postulated that chitin synthase is located in a sterol-rich region and the ATPase is located in a sterol-poor domain, which would be in accordance with the differential effects of nystatin on both enzymes.

BIOCHEMICAL PATHWAYS FOR LIPID SYNTHESIS

The synthesis of lipids has been reviewed in several reports, most recently by Carman and Henry (30) and Paltauf et al. (141). This section focuses on some of the key enzymes of lipid synthesis and the sites of lipid synthesis in yeast cells.

Phospholipid Biosynthesis

The lipid matrix of *S. cerevisiae* membranes is composed of glycerophospholipids similar to those found in the membranes of higher eukaryotic cells. In mammalian cells, the majority of phospholipid biosynthetic enzymes are associated with the ER (49). For instance, PC, PE, PI, and PS are synthesized primarily at the ER. Cardiolipin and its precursor PG, as well as small amounts of PE, are synthesized in the mitochondria (43). The study by Zinser et al. (226) shows that plasma membranes of *S. cerevisiae* are largely devoid of any of the lipid-synthesizing enzymes. However, a more recent study, by Nickels et al. (129),

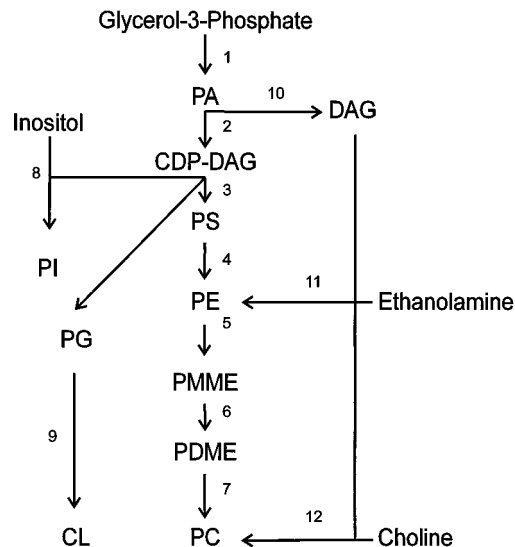

FIG. 4. Phospholipid biosynthetic pathway in *S. cerevisiae*. The indicated reactions are catalyzed by the following enzymes: 1, glycerol-3-phosphate acyltransferase; 2, CDP-DAG synthase; 3, PS synthase; 4, PS decarboxylase; 5, PE *N*-methyltransferase; 6, phospholipid *N*-methyltransferase; 7, PGP phosphatase; 8, cardiolipin synthase; 9, PI synthase; 10, phosphatidic acid (PA) phosphatase; 11, ethanolaminephosphotransferase; 12, cholinephosphotransferase. Abbreviation: CL, cardiolipin.

shows that PG and PI can be synthesized by isolated plasma membranes of inositol auxotroph *S. cerevisiae* strains.

The pathways for the synthesis of phospholipids in *S. cerevisiae* have been elucidated primarily by Lester and coworkers (109, 186, 211). In *S. cerevisiae*, PE and PC are synthesized by two alternative pathways (85). In both cases, glycerol-3-phosphate is the precursor of PE and PC. In the primary pathway of phospholipid synthesis, PE and PC are derived from CDP-diacylglycerol (CDP-DAG) (Fig. 4). The major route for PC biosynthesis in *S. cerevisiae* involves three successive methylations of PE, which sequentially results in phosphatidyl-*N*-monoethylethanolamine (PMME), phosphatidyl-*N,N*-dimethylethanolamine (PDME), and PC. In the alternative pathway, PE and PC are derived from CDP-ethanolamine and CDP-choline, respectively. PI and cardiolipin are also derived from CDP-DAG; these reactions are similar to those in higher eukaryotes. The synthesis of PS in *S. cerevisiae* is similar to that in bacteria and occurs from CDP-DAG plus serine. In higher eukaryotes, PS synthesis involves the exchange of the ethanolamine group of PE or choline group of PC for serine.

Sphingolipid Biosynthesis

In *S. cerevisiae*, three classes of sphingolipids are known: IPC, containing a single inositol phosphate; MIPC, containing a single inositol phosphate to which a mannose unit is attached; and the major sphingolipid, M[IP]₂C, containing two inositol phosphates with a mannose unit attached to one of the inositols. The type of long-chain base, the degree of hydroxylation, and the chain length of the fatty acids give rise to a wide variety of sphingolipids in each of the three classes (184). An outline of the sphingolipid synthesis pathway is given in Fig. 5. The ceramide moiety contains the sphingolipid long-chain base phytosphingosine, linked by an amide bond to a C₂₆ fatty acid (184). Synthesis of phytosphingosine involves the condensation of serine and palmitoyl coenzyme A in the presence of pyridoxal phosphate to yield D-3-ketosphinganine, CO₂, and coen-

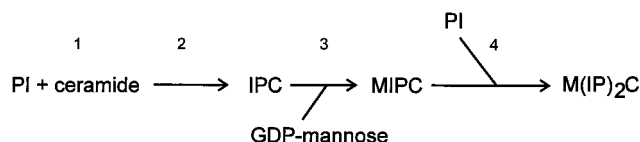

FIG. 5. Pathway for the synthesis of sphingolipids. The indicated reactions are catalyzed by the following enzymes: 1, ceramide synthase; 2 and 4, phosphoinositol transferase; 3, mannosyltransferase.

zyme A, which is catalyzed by serine-palmitoyltransferase. The 3-keto intermediate is converted into D-4-hydroxy-sphinganine by 3-ketosphinganine reductase and phytosphingosine synthase (146). This phytosphingosine is converted to ceramide, which then forms the backbone of the sphingolipid molecule. The ceramide is presumably synthesized in the ER. The subsequent transferase steps are most probably completed in the Golgi apparatus, since the synthesis of sphingolipids requires vesicular transport from the ER to the Golgi (154).

Ergosterol Biosynthesis

The branched-chain isoprenoid pathway (Fig. 6) provides a diverse class of molecules that are required for ergosterol biosynthesis but also serve purposes related to protein synthesis, protein glycosylation, and electron transport (32). In higher eukaryotes, and most probably also in *S. cerevisiae*, the ER is the principal site of sterol synthesis (159). Some evidence is available for the localization of enzymes involved in late steps of the biosynthesis in lipid particles, secretory vesicles, and the plasma membrane (225). Sterol biosynthesis starts from acetate. The principal regulatory step in the synthesis of the isoprenoids is the conversion of 3-hydroxyl-3-methylglutaryl (HMG) coenzyme A into mevalonic acid. The synthesis of ergosterol from mevalonic acid has been reviewed thoroughly elsewhere (39).

LIPID SORTING

Once inserted into a membrane, the lipid molecules show very little tendency to move spontaneously as monomers from one membrane via the aqueous space to another membrane (46). The variation in lipid composition of the organelles there-

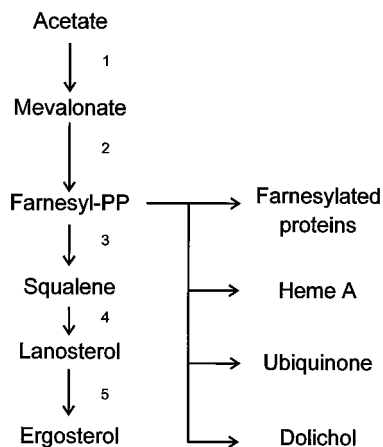

FIG. 6. Sterol biosynthesis via the isoprenoid pathway in *S. cerevisiae*. The indicated reactions are catalyzed by the following enzymes: 1, HMG coenzyme A reductase; 2, farnesyl diphosphate synthetase; 3, squalene synthase; 4, lanosterol cyclase; 5, C-24(28) sterol reductase and steryl ester synthase and reductase.

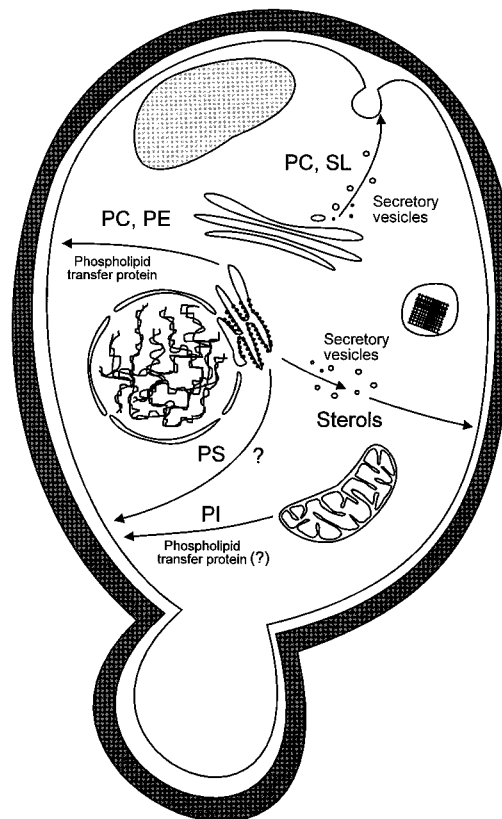

FIG. 7. Schematic representation of lipid transfer in *S. cerevisiae*.

fore requires specific lipid transport mechanisms (Fig. 7) (226). In *S. cerevisiae*, two types of phospholipid transfer proteins have been identified. One of these proteins is highly specific for PI (44), while the other protein is more specific for PC and to a lesser extent for PE, PS, and PI (21). Clear evidence for an essential role of these proteins in intracellular bulk movements of lipids is still lacking. It has also been suggested that these transfer proteins function in exchange rather than in net transport of lipids. The *PIT1/SEC14* gene encodes the PI/PC transfer protein. Temperature-sensitive mutations in *pit1/sec14* abolish phospholipid transfer in cell extracts (9). The *sec14/pit1* defects can be suppressed by mutations in structural genes that participate in the pathway of PC biosynthesis (37). These results and the observation that *PIT1/SEC14* protein copurifies with Golgi membranes suggest that *PIT1/SEC14* functions in maintaining an appropriate phospholipid composition of Golgi membranes which is essential for its secretory function (37).

The intracellular transport of proteins from the site of synthesis to their destination is mediated largely by lipid vesicles (see below). This implies that sorting of lipids can accompany the protein transport process. In most cases, however, the transport of lipids from the site of synthesis to the target organelle is not linked to protein transport (209).

PROTEIN SYNTHESIS AND SORTING TO THE PLASMA MEMBRANE

Plasma membrane proteins are synthesized at membrane-bound ribosomes on the rough ER; the polypeptides transit the ER and the Golgi apparatus and travel to the plasma membrane along the secretory pathway (Fig. 8). The transport from

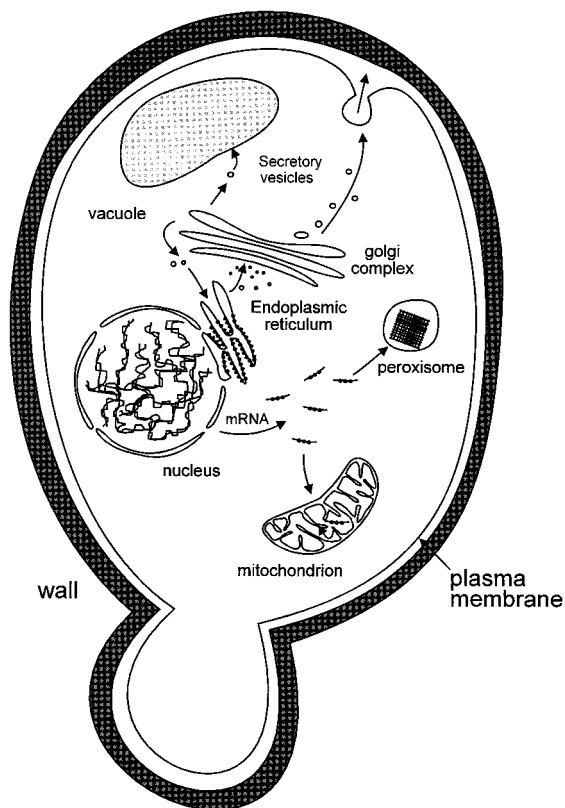

FIG. 8. Schematic representation of protein sorting in *S. cerevisiae*.

one organelle to another is mediated by vesicular transport. A combination of biochemical studies, including reconstitution of vesicular transport in cell-free systems (7, 63), and genetic approaches, including the isolation of *S. cerevisiae* secretory mutants (132, 133, 173), has given insight into the mechanism of protein transport. Plasma membrane proteins are inserted cotranslationally into the rough ER membrane. In the ER, the polypeptides can be proteolytically processed, acquire proper folding, and/or undergo glycosylation or other types of modification. Targeting of ribosomes engaged in the synthesis of plasma membrane proteins to the ER is mediated by the signal recognition particle, which brings the nascent polypeptides to the ER membrane (81, 213). In the process of protein synthesis, the polypeptides are inserted into the rough ER membrane with the aid of an ER membrane-located protein translocation multisubunit complex that is composed of Sec61p, Sec62p, Sec63p, and two other polypeptides (50). Sec61p shows significant sequence similarity to *E. coli* SecY (74), a protein which is involved in the translocation of proteins across the cytoplasmic membrane. Transport of proteins across the ER membrane is probably made irreversible by protein folding and/or posttranslational modification. The oligosaccharyl-transferase complex, encoded by *WBP1* and *SWP1* (190, 191), has also been implicated as a component of the protein translocation pathway. Mutants with conditional mutations of the *WBP1* gene, however, are not defective in protein translocation (190).

Following synthesis and insertion into the ER, transport vesicles bud from the ER and fuse with the Golgi apparatus. Budding of the vesicles is most probably initiated by a Ras-like GTP-binding protein (Sar1p) (124, 135, 136) and a resident ER membrane protein (Sec12p) (Fig. 9). With the help of Sec12p, a GDP-GTP exchange protein (10), the Sar1 protein

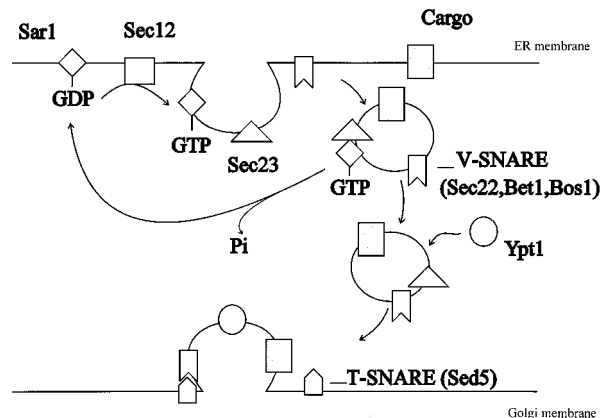

FIG. 9. Schematic representation of secretory vesicle budding from the ER and docking to the Golgi membrane.

on the ER membrane is converted from the GDP-bound resting state to the GTP-bound active state, which promotes budding of transport vesicles from the ER. Upon completion of the vesicle formation, Sar1p hydrolyzes GTP with the help of the GTPase-activating protein Sec23p (224), after which Sar1p cycles back to the ER. These steps have been demonstrated *in vitro* by forming functional vesicle intermediates that are competent in fusing to the Golgi membrane (135, 169). Several proteins that mediate ER-to-Golgi transport are implicated in targeting and fusing vesicles from the ER to the Golgi. Mutations in the GTP-binding protein Ypt1p result in a block of ER-to-Golgi transport and yield accumulation of aberrant membranes and vesicles (12). *In vitro* studies have confirmed that Ypt1p is required for targeting of transport vesicles to the Golgi (160). Proteins encoded by the *BOS1*, *BET1*, and *SEC22* genes represent membrane proteins that are constituents of the ER-derived transport vesicles (128). Antibodies against Bos1p inhibit ER-to-Golgi transport but do not affect budding from the ER membrane (110). Mutations in the Sec22 protein cause a similar phenotype. Although the precise mechanism of the fusion process is not yet known, many details may be learned from studies with mammalian cells (185). In mammalian cells, a protein termed NSF (Sec18p in yeast cells), which is sensitive to *N*-ethylmaleimide and has ATPase activity, associates with soluble NSF attachment proteins (SNAPs; Sec17p in yeast cells). This complex binds to receptors on the vesicle (v-SNARE) and the target membrane (t-SNARE), and this attachment induces membrane fusion provided that some other, as yet uncharacterized, cytoplasmic and target membrane proteins are present. Such a mechanism of membrane fusion is likely to represent a common theme in the secretory pathway (59, 153). Many of the proteins implicated in membrane fusion in mammalian cells share sequence similarity with yeast proteins (59, 153). Sec22p, Bos1p, and Bet1p may have roles as v-SNAREs, and another membrane protein, Sed5p, may be the equivalent of the t-SNARE receptor (84).

Once associated with the Golgi apparatus, the membrane proteins undergo further processing. The Golgi is organized into three functionally distinct regions, the *cis*-Golgi network, the Golgi stack, and the *trans*-Golgi network. The *cis*- and *trans*-Golgi networks are the entry and exit sites, respectively, of the stack and are the places where the sorting takes place.

Transport of proteins between Golgi cisternae is mediated by two distinct forms of transport vesicles as visualized by electron microscopy (166). These forms are called the non-

clathrin-coated vesicles and uncoated vesicles. By using a variety of blocking agents, it has been shown that the coated vesicles precede the noncoated vesicles. The role of the coat in vesicle transport remains elusive, but it is thought that the coat proteins initiate or promote membrane deformation, which is essential for the formation of the vesicle (153).

Post-Golgi secretion vesicles are transported to a specific region of the plasma membrane called the bud; membrane fusion takes place at the bud, and the formation of the daughter cell starts (133). Determination of the budding site is genetically controlled by a set of *BUD* genes (34). Mutations in the Sec4 GTP-binding protein cause the cell to accumulate secretory vesicles (133). The Sec4 protein with bound GTP is proposed to associate with Snc1p/Snc2p on the secretory vesicle membrane (152). The complex formed recognizes an attachment site on the plasma membrane (Sso1p/Sso2p [1]) which then triggers membrane fusion (214). The Sec4 protein is subsequently released, after which it can be used for another round of membrane fusion.

One of the major questions in this process of protein flux is how the cell discriminates between proteins which are resident in an organelle and proteins which have to be exported further to other organelles. Currently, the idea in favor is that transport of proteins to the plasma membrane occurs by default (145, 221). Protein retention in a particular organelle such as the ER requires special mechanisms (130). However, this does not explain why plasma membrane proteins do not stay resident in the ER or Golgi. Bretscher and Munro (23) have proposed that targeting occurs through bilayer-mediated sorting. Hydrophathy analysis of known Golgi membrane proteins predicts that the average length of their membrane-spanning segments is around 17 residues, while transmembrane segments of plasma membrane proteins have on the average 21 residues (23). The high content of ergosterol and sphingolipids in the plasma membrane (142, 226) favors a bilayer that is thicker than that of the Golgi membrane. Consequently, plasma membrane proteins segregate away from the energetically less favorable Golgi membrane. Since mutations in *SHR3* specifically inhibit targeting of amino acid permeases to the plasma membrane but do not affect sorting of other plasma membrane proteins (111), the bilayer-mediated sorting model does not accommodate all observations with regard to transport of membrane proteins to the plasma membrane. Also, it cannot be excluded that the destination of membrane proteins by default may be the vacuole in yeast cells (162).

PROTEIN CONTENT OF THE PLASMA MEMBRANE

Chromosome III, which corresponds to 2.5% of the entire yeast genome, is predicted to encode 33 plasma membrane proteins. From this number, a total of more than 1,000 plasma membrane proteins can roughly be estimated to be present in *S. cerevisiae* (70, 72). It is evident that several membrane protein-encoding genes are present in multiple copies (121), and not all these proteins will be expressed at the same time. The actual number of functional plasma membrane proteins will therefore be much smaller. Indeed, using isolated and purified plasma membrane fractions, Rank and Robertson (157) estimated a total of about 150 unique polypeptides. The transport proteins are most probably the principal constituents of the plasma membrane (see below). For instance, each amino acid is transported by at least one protein (76) and the various sugars are transported by at least 15 different proteins (107). The yeast plasma membrane of a cell can contain up to 10^5 to 10^6 transporter molecules, which is roughly 50% of the plasma membrane proteins (178). The principal plasma membrane

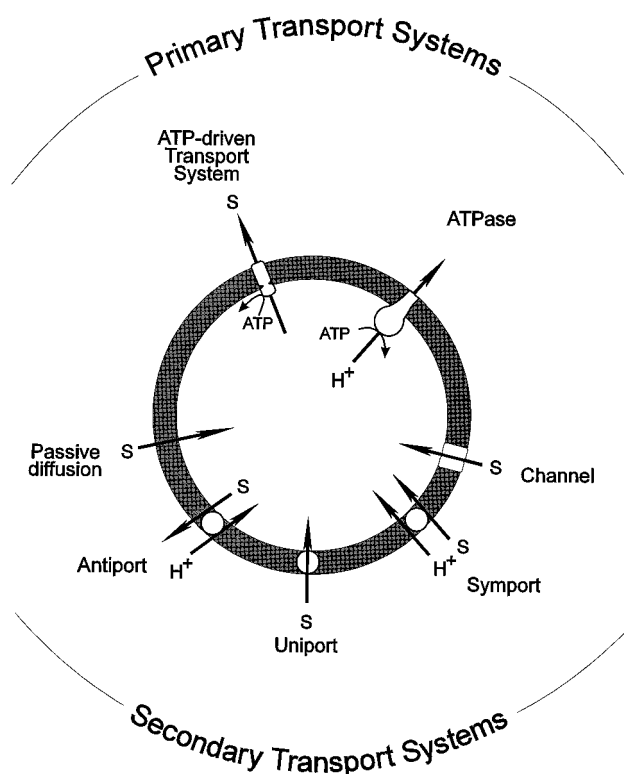

FIG. 10. Primary and secondary transport systems in *S. cerevisiae*.

ATPase, encoded by *PMA1* (179), has not been taken into account in these calculations. By itself, it can account for almost 50% of the plasma membrane protein content of exponentially growing cells (178). Other plasma membrane proteins are involved in cell wall synthesis (61) or signal transduction (134) or form part of the cytoskeleton (11). In the following sections, the various transport proteins in the plasma membrane as well as information on signal-transducing enzymes pertinent to the regulation of solute transport are discussed.

PRIMARY TRANSPORT PROTEINS

Plasma Membrane ATPases

Primary transport is defined as transport in which light or chemical energy is converted into electrochemical energy (i.e., solute or ion concentration gradients). For the plasma membrane of *S. cerevisiae*, only ATP-driven primary transport systems have been described (Fig. 10). The hydrolysis of ATP by the major plasma membrane ATPase (Pma1p) results in the generation of an electrochemical gradient of protons (Δp). The free energy present in the Δp exerts a force on the protons (the proton motive force; $\Delta\bar{\mu}_{\text{H}^+}/F$ or Δp) which is composed of an electrical potential ($\Delta\psi$) and a chemical gradient of protons across the plasma membrane [$-Z\Delta\text{pH} = 2.3(RT/F)(\text{pH}_{\text{in}} - \text{pH}_{\text{out}})$]. This can also be expressed as $\Delta p = \Delta\psi - Z\Delta\text{pH}$ (mV).

The Δp is used to drive membrane-associated processes such as solute transport (see below). The plasma membrane ATPase protein forms a covalent acyl phosphate intermediate as part of the reaction cycle and has two forms of the phosphorylated intermediate (E_1 and E_2) which differ in conformation (71). This type of enzyme is therefore called $E_1E_2^-$ or P-type ATPase. The catalytic mechanism of the P-type ATPase is distinct from that of the F-type ATPase of the mitochondria

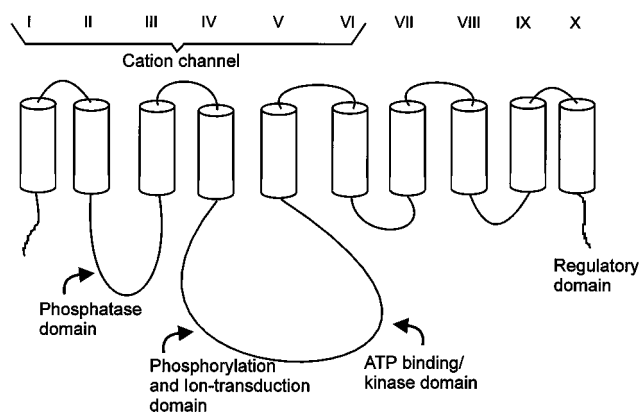

FIG. 11. Model for the secondary structure of Pma1p.

and the V-type ATPase of the vacuolar membrane (3). As noted above, the plasma membrane ATPase protein (Pma1p) is the major protein in the plasma membrane (178). The ATPase is estimated to consume 10 to 15% of the ATP produced during yeast growth (67) and has a reaction stoichiometry of one proton extruded per molecule of ATP hydrolyzed (67). Because of the lack of reliable methods to quantitate the membrane potential in whole cells, it is hard to give an estimate of the Δp formed by Pma1p, but values of -200 mV for the membrane potential have frequently been reported (178, 183). Pma1p is highly specific for Mg^{2+} -ATP, with rates of hydrolysis of CTP, GTP, and ITP which are less than 2% of the activity with ATP (144). The K_m^{app} for ATP is 0.8 to 1.2 mM, and the pH optimum is around pH 6.0 (187). Addition of glucose to yeast cells causes a two- to threefold increase in plasma membrane ATPase activity (187).

The isolation of the *PMA1* gene encoding the plasma membrane ATPase (179) has enabled the molecular analysis of the enzyme. The membrane-embedded part of the protein contains 8 to 12 membrane-spanning segments, with the N and C termini located in the cytoplasm (Fig. 11) (178, 183). Amino acid sequence motifs which are highly conserved among the P-type ATPases have been detected, and mutagenesis of residues in these regions has established their roles in ATPase function (178). The glutamate residue in the TGES motif at amino acid 232 (in the Pma1p amino acid sequence) is required for hydrolysis of the phosphorylated enzyme interme-

TABLE 3. Effects of inhibitors on the vacuolar, plasma membrane, and mitochondrial H^+ -ATPases^a

Inhibitor	Concn (μ M)	Activity (%) of:		
		Vacuolar ATPase	Plasma membrane ATPase	Mitochondrial ATPase
None		100	100	100
DCCD	1	63	86	12
EDAC	100	23	95	100
NBD-Cl	100	27	79	6
Tributyl tin	100	45	33	15
Sodium azide	2,000	110	105	4
Oligomycin	47	74	74	10
DES	100	48	16	95
Quercetin	100	67	30	100
<i>o</i> -Vanadate	100	96	50	100
Miconazole nitrate	300	52	5	86

^a Taken in part from reference 202.

diate; the threonine residue in this motif is involved in the binding of vanadate (151, 178). The aspartate residue in the CSDKTGT motif at position 378 is required for the formation of the acyl-phosphate catalytic intermediate and is essential for ion pumping (151). The lysine residue at position 475 in the motif KGAP and the aspartate residue at position 534 in the motif DPPR are also important for the formation of the phosphorylated intermediate (151). Hydrolysis of the phosphorylated intermediate is facilitated by the first aspartate residue in the TGDGVND motif at position 634, while the second aspartate in this motif is important for the formation of the intermediate (151). The last 11 amino acid residues are involved in the regulation of the enzyme activity. Deletion of this part results in a constitutively activated ATPase (150). In contrast to Pma1p, the mitochondrial F-type and vacuolar V-type ATPases are composed of multiple different subunits (Fig. 12) (3, 126). The H^+ /ATP stoichiometry of Pma1p is 1, which differs distinctly from the 3 to 4 protons pumped per ATP by the F-type ATPase. The differences in pH optima and sensitivity to inhibitors can be used to discriminate between the various ATPase activities (Table 3). In the case of the plasma membrane ATPase, the activity can be used as a marker for the isolation of the plasma membrane. The pH optima for the plasma membrane, vacuolar, and mitochondrial ATPases are pH 6, 7, and 9, respectively. The plasma membrane H^+ -ATPase is relatively sensitive to *ortho*-vanadate and diethylstil-

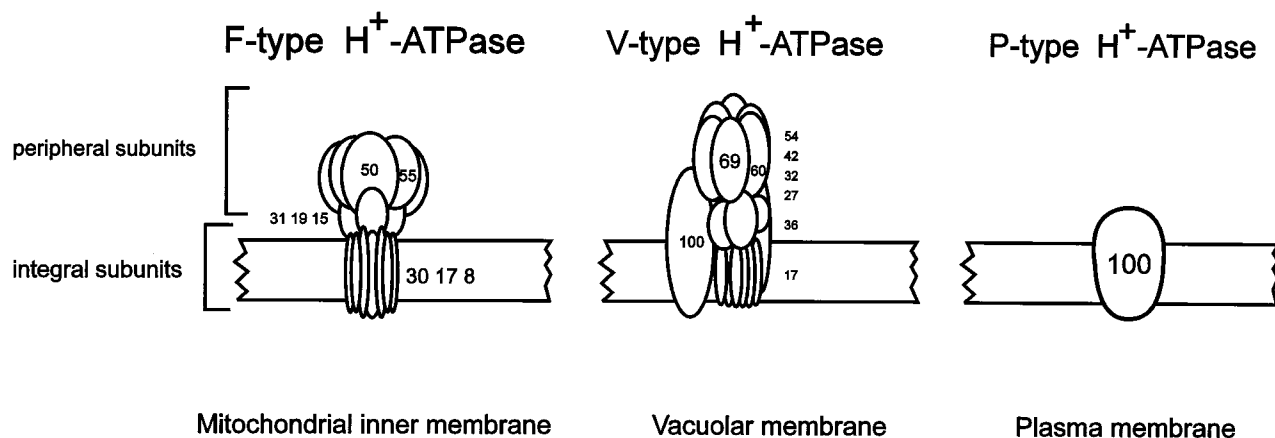
FIG. 12. *S. cerevisiae* H^+ ATPases. The numbers refer to the apparent molecular masses (in kilodaltons) of the various subunits.

bestrol, whereas the vacuolar and mitochondrial ATPases are not affected or only moderately affected by these inhibitors (Table 3) (202).

The genes encoding two other plasma membrane P-type ATPases have been described. The Pma2 ATPase is 90% identical to the Pma1 enzyme (175) but has distinct enzymatic properties. When overexpressed by the *PMA1* promoter, the Pma2 ATPase can functionally complement mutations in the *PMA1* gene. The physiological function and the conditions allowing the expression of *PMA2* are still unknown. The high affinity for MgATP could indicate that Pma2p is a glucose-regulated ATPase that plays a role under starvation conditions, i.e., when the ATP concentration is low (187).

The gene encoding the Pmr2/Ena1 ATPase has recently been isolated by Rudolph et al. (167). The Pmr2/Ena1 protein shows 20% identity with the Pma1 ATPase and apparently transports monovalent cations (Na^+ , Li^+ , and K^+) (164). Deletion of *PMR2* is not deleterious, but the cells become sensitive to high Na^+ concentrations and elevated pH.

ABC Transporters

The Ste6 protein is a representative of the ABC superfamily (88, 105). The distinguishing feature of members of this family is a highly conserved domain of about 200 amino acids making up the ATP-binding cassette (ABC); this domain confers on these transporters the ability to bind and hydrolyze ATP (88). The Ste6 protein is required for the secretion of the a factor (a dodecalipoptide [16]), which is necessary for mating of yeast cells (106). Kuchler et al. (105) have identified by PCR at least two other Ste6-like proteins, but the function of these proteins is unknown. Using endocytosis mutants, Kölling and Hollenberg (104) obtained evidence that the Ste6 protein is present in the plasma membrane in ubiquitinated form. Mutations in several ubiquitin-ligating enzymes decrease the turnover time of the Ste6 protein, indicating that ubiquitination has a role in the degradation of the Ste6 protein (60). The Ste6 protein is also stabilized in vacuolar protease mutants, suggesting that most of the Ste6 protein is degraded in the vacuole (104). This is surprising, since one of the functions of ubiquitin is to mark proteins for degradation by the 26S proteasome, a cytosolic enzyme (60).

Pleiotropic drug resistance proteins in yeast cells are able to transport a variety of unrelated (mostly hydrophobic) compounds upon hydrolysis of ATP (8). These proteins are similar to the multiple drug resistance proteins from higher eukaryotes (88). At least 12 different pleiotropic drug resistance-like loci have been identified in *S. cerevisiae* on the basis of functional studies and/or sequence similarities (8). The function of pleiotropic drug resistance proteins in *S. cerevisiae* has not been established in most cases, although it has been shown that Snq2p (79) and Pdr5p (108) confer various degrees of resistance to different toxic compounds such as 4-nitroquinoline *N*-oxide, triaziquone, sulfomethuron methyl, phenantroline, cycloheximide, chloramphenicol, lincomycin erythromycin, and antimycin (79, 118).

PASSIVE AND FACILITATED DIFFUSION ACROSS THE PLASMA MEMBRANE

Passive Diffusion

The rate of passive diffusion of solutes across the plasma membrane is governed in part by the physical properties of the membrane such as the acyl chain length, degree of saturation of the fatty acids, membrane fluidity, and other factors (see

above). A variety of sugar-alcohols such as arabinitol, erythritol, galactitol, mannitol, ribitol, sorbitol, and xylitol are thought to cross the plasma membrane by passive diffusion only (29). Although specific transport systems have not (yet) been found for these molecules, the relatively hydrophilic nature of the sugar-alcohols makes it unlikely that the rate of diffusion is very high. More-lipophilic compounds such as fatty acids (organic acids), alkanols, and hydrocarbons are more likely to diffuse across the membrane. Various examples of compounds that can dissolve into the plasma membrane and enter the cell by passive diffusion have been discussed by Cartwright et al. (31).

Channels

Channels allow the downhill flux of solutes across the plasma membrane. To date, two distinct types of ion channels have been found in the plasma membrane of *S. cerevisiae*: voltage-dependent K^+ channels (78) and rather unspecific channels that are activated by stretching of the bilayer (78).

The patch clamp technique, used to demonstrate ion channels in the yeast plasma membrane, showed that a K^+ -specific current is induced upon depolarization of the membrane (78). Alkalinization of the medium, as well as a transient increase in cytoplasmic Ca^{2+} levels, which can occur in response to sugar uptake and/or metabolism (15, 57), also elicits a specific K^+ current. The translocation of some sugars induces an equally large flux of protons (assuming a sugar/ H^+ stoichiometry of 1), which could result in depolarization of the membrane potential (176). The efflux of K^+ from the cells alleviates this depolarization. However, K^+ efflux is also observed when glucose is taken up by uniport, i.e. without coupling ion (205). It is therefore more likely that sugar-induced K^+ efflux is linked via a transient increase in cytoplasmic Ca^{2+} (57).

The mechanosensitive channels in the plasma membrane conduct both anions and cations, thereby dissipating the electrochemical ion gradients across the membrane (78). Gustin et al. (78) have suggested that these channels play a role in osmoregulation via ion conductance and signal transduction via Ca^{2+} uptake.

Secondary Transport Proteins

In secondary transport, the energy for translocation of one solute is supplied by (electro-)chemical gradients of other solutes (including ions). The electrochemical ion gradients are often generated by primary transport systems such as the yeast plasma membrane ATPase. Three general categories of secondary transport systems can be distinguished, i.e., uniport, symport, and antiport. Transport of a single solute which is facilitated by a carrier protein without the movement of a coupling solute is termed uniport. When the transport involves the coupled movement of two (or more) solutes in the same direction, the transport process is referred to as symport. Antiport refers to the coupled movement of solutes in opposite directions. Since the solutes transported by secondary transport systems can be neutral, negatively charged, or positively charged and since different numbers of solutes may be co- or countertransported, the driving forces on these processes may vary considerably. For a comprehensive review on secondary transport systems, see Poolman and Konings (149). The types of transport systems detected in the yeast plasma membrane are shown in Fig. 10. The different modes of secondary transport are listed below.

TABLE 4. Sugar transport systems of *S. cerevisiae*^a

Substrate	Gene	K_m^{app} (mM) for:		Mode of transport
		High affinity	Low affinity	
Glucose, fructose, mannose	<i>HXT1-7</i> , (<i>SNF3</i>)	1	20	Facilitated diffusion
Galactose	<i>GAL2</i>	3	300	Facilitated diffusion
Maltose, turanose	<i>MAL(X)1</i>	4	70	Proton symport
Maltotriose, isomaltose (Sucrose)	<i>AGT1</i>	50		(Proton symport) (Proton symport)

^a Parentheses indicate that the mechanism of transport is not well established.

Uniport

The driving force for this process is the electrochemical gradient of the transported solute. The best-known examples of electroneutral uniport in *S. cerevisiae* are the transporters for the monosaccharides glucose and galactose (Table 4). Until recently, glucose uptake was thought to be mediated by two kinetically distinct mechanisms: a constitutive low-affinity transport system with an apparent affinity constant for glucose (K_m^{app}) of approximately 20 mM and a kinase-dependent, glucose-repressible high-affinity transport system with a K_m^{app} of 1 mM (18).

High-affinity glucose transport is genetically very complex, involving at least the gene products *SNF3*, *HXT1*, *HXT2*, *HXT3*, *HXT4*, *HXT5*, *HXT6*, and *HXT7*, while the presence of other genes has not been ruled out (103). High- and low-affinity transport in *S. cerevisiae* has been observed not only for glucose but also for various other sugars. The validity of the determined kinetic parameters of sugar uptake is still a matter of controversy. Fuhrmann and Volker (64) have suggested that the low-affinity component of transport is not carrier mediated but results from passive diffusion of the solute across the plasma membrane at the high concentrations of sugars used. Since internalized sugar is rapidly phosphorylated by a sugar kinase, the phosphorylation activity will influence the transport kinetics. Using quench flow techniques to measure initial sugar uptake rates, i.e., from the increase in radioactivity within 0.2 to 5 s, Van Dam and coworkers (204, 212) showed that the rate of glucose uptake in starved cyanide-treated cells slows after 0.2 s. This suggests that depletion of ATP, caused by the starvation conditions, influences glucose uptake through the activity of hexokinase. The kinetics of glucose uptake in the subsecond time range still displays high- and low-affinity components (212). It has been suggested that regulation of glucose uptake occurs via a factor that modifies the affinity of the transporters. This factor could be the *SNF3* gene product, the general glucose-sensing protein (Ggsp), hexokinase PII (or PI), one of the *HXT* gene products, or any combination of these (212), but it could also be related to modification of the transport protein(s) by, for instance, phosphorylation. The abundance of related glucose transporters suggests that kinetic constants derived from strains that are genetically poorly defined will inevitably be the result of a combination of transport systems. In fact, Wendell and Bisson (218) have shown that the expression of the putative glucose transporter (*HXT2*) is regulated by the growth conditions. Since conditions that result in an increased expression of a particular transport protein may down-regulate the expression of another transporter molecule, different transporters will contribute to the transport kinetics.

Kinetic analysis of galactose transport in *S. cerevisiae* is also characterized by high- and low-affinity transport, but, unlike glucose transport, galactose is mediated by a single gene product (Gal2p) (200) (Table 4). It has been suggested that the different affinities are a result of an interaction of galactokinase

with the transport protein (156). The regulation of expression of *Gal2* involves the Gal3, Gal4, and Gal80 proteins (97).

Symport

Ions. Solute transport in yeast cells occurs most often in symport with protons, which is in contrast to the situation in higher eukaryotes, in which Na^+ is often used as a coupling ion. In experiments to date, only a phosphate transport system has been reported to use Na^+ as a coupling ion (19). This latter observation implies that *S. cerevisiae* is able to generate a sodium motive force in addition to a Δp . Phosphate has also been shown to be transported in symport with either three (38) or two (165) protons. The gene encoding this phosphate transporter (*PHO84*) (see Table 6) has been sequenced and shown to be related to the family of yeast sugar transporters (26). Recently, Pho84p has been purified and functionally reconstituted into liposomes (14). The reconstituted enzyme transports phosphate in response to a $\Delta\psi$, showing that the overall transport is electrogenic, i.e., $\text{HPO}_4^{2-}/n\text{H}^+$ or $\text{H}_2\text{PO}_4^-/m\text{H}^+$, where $n \geq 3$ and $m \geq 2$.

Potassium transport across the plasma membrane is mediated by two kinetically distinct systems. The high-affinity transport system, encoded by *TRK1* (102), is most probably a potassium/proton symporter. The low-affinity potassium transport system encoded by *TRK2* (102) may not be a true secondary transport system, since its activity resembles that of a channel (see above). Deletion of *TRK1* and *TRK2* allowed the isolation of two genes which complement the *trkΔ1 trkΔ2* potassium transport defect (65). Sequence analysis of these genes revealed that they are highly homologous and share high similarity with the galactose and glucose transporters encoded by *GAL2* and *HXT1-2*, respectively. Gaber (65) postulated that these genes are sugar-dependent K^+ transporters involved in K^+ uptake. This would counteract the sugar-induced K^+ efflux via the K^+ channels described above.

Sugars. Transport of disaccharides in *S. cerevisiae* is mediated by proton symport systems (Table 4). Maltose is transported in symport with one proton (176, 208). Maltose transporters are encoded by at least five *MAL* loci (*MAL1* through *MAL4* and *MAL6*). Each *MAL* locus contains a maltose transport gene (*MALX1*, where *X* is the number of the *MAL* locus), a maltase gene (*MALX2*), and at least two genes (*MALX3* and *MALX4*) that encode proteins that regulate the expression of MalX1p and MalX2p (125). Growth of yeast cells on maltose induces synthesis of the maltose permeases by transcriptional activation. A complete description of the regulation of the *MAL* genes has not yet been given, since other gene products interfere with the transcription of the *MAL* genes. For instance, catabolite repression of the *MAL* genes by glucose is observed, but details of the underlying mechanism are largely unknown (125). For maltose transport, two kinetically distinct transport activities have been described (27, 36), a high-affinity

TABLE 5. Amino acid transport systems of *S. cerevisiae*^a

Substrate	Gene	K_m^{app} (μM) for:	
		<i>GAP1</i>	Other
Histidine	<i>GAP1, HIP1</i>	25	20
Proline	<i>GAP1, PUT4</i>	31	
Arginine	<i>GAP1, CAN1</i>	7.6	10
Lysine	<i>GAP1, LYPI</i>	3.1	19
Methionine	<i>GAP1, HTP1</i>	770	12
Glutamine	<i>GAP1, GNP1</i>	400	
Leucine	<i>GAP1, BAP1</i>	84	160
Asparagine	<i>GAP1</i>	350	
Glutamate	<i>GAP1</i>	1,000	112
Serine	<i>GAP1</i>	500	250
Tryptophan	<i>GAP1</i>	9	
Ornithine	<i>GAP1</i>	4	
Valine	<i>GAP1, BAP1</i>		2,000
Cysteine	<i>GAP1</i>	250	
Alanine	<i>GAP1</i>		
Glycine	<i>GAP1</i>		

^a All the amino acid transport systems have been claimed to function by proton symport. For arginine, lysine, threonine, and glutamate, a proton symport mechanism has been shown in in vitro membrane model systems (139, 205a).

component with a K_m^{app} of 4 mM and a low-affinity component with a K_m^{app} of 70 mM. More recently, the activity corresponding to low-affinity transport has been shown to be caused by nonspecific binding of maltose to the cell wall and/or the plasma membrane components (13). Isolated plasma membranes from cells expressing only the maltose transport protein encoded by *MAL61* or *MAL11* show monophasic kinetics with a K_m^{app} of 4 mM, indicating that these proteins are not responsible for the low-affinity component observed in whole-cell studies (205a).

S. cerevisiae transports α -methyl-D-glucoside (24), sucrose (170), trehalose, and maltotriose (42, 119), and in all these cases proton symport is the suggested reaction mechanism. Transport of maltotriose and melezitose occurs via a transport system which is homologous to the maltose transporter (119a).

Amino acids. Amino acids have so far been shown to be transported by proton symport exclusively (Table 5). There are two distinct classes of amino acid transport systems in *S. cerevisiae*, i.e., specific and nonspecific carriers. Most transport systems are specific for one or a few related L-amino acids and exhibit different properties with respect to substrate specificity, capacity, and/or regulation. The general amino acid permease Gap1p (77, 220), however, is able to transport all amino acids, albeit with different apparent affinities and velocities. The synthesis of the specific amino acid carriers is usually constitutive. The synthesis of the Gap1p, Put4p (proline), Dal5p (allantoate), and Uga4p (γ -aminobutyrate) carriers, on the other hand, is highly regulated and dependent on the nitrogen source in the medium. The presence of readily usable nitrogen sources, such as glutamine, asparagine, and ammonia, inhibits synthesis of Gap1p, Put4p, Dal5p, and Uga4p (220). Growth on nitrogen sources such as proline or urea induces synthesis, suggesting that the physiological role of these carriers is to scavenge amino acids for anabolic purposes. To date, only a few amino acid transport genes of *S. cerevisiae* have been identified, i.e., the general amino acid permease (*GAP1*) (95), the histidine permease (*HIP1*) (189), the arginine permease (*CAN1*) (90), the 4-aminobutyric acid permease (*UGA4*) (2), and the lysine specific carrier (*LYPI*) (188). The amino acid sequence similarity between the different carrier proteins is quite high: between 30 and 65% for pairs of proteins (188).

TABLE 6. Various transport systems of *S. cerevisiae*

Substrate	Gene	Mode of transport
a mating factor	<i>STE6</i>	ATP dependent
Choline	<i>CTR</i>	Unknown
P_i	<i>PHO84</i>	Proton symport
GABA ^a	<i>UGA4</i>	Proton symport
NH_4^+	<i>MEP1/MEP2</i>	Uniport
Purine/cytosine	<i>FCY2</i>	Proton symport
Uracil	<i>FUR4</i>	Proton symport
Allantoate	<i>DAL5</i>	Proton symport
K^+	<i>TRK1</i>	Uniport
Ca^{2+}	<i>PMR2</i>	ATP dependent
Copper	<i>CTR1</i>	Unknown
Peptides	<i>PTR2</i>	Proton symport
Urea	<i>DUR3</i>	Proton symport
Divalent cations	<i>COT2</i>	Unknown

^a GABA, γ -aminobutyric acid.

The amino acid carrier proteins are also homologous to various bacterial amino acid transporters (e.g., the *Escherichia coli* LysP, PheP, and AroP proteins) (188).

Nucleosides. Transport of cytosine and uracil is mediated by proton symport (Table 6) (178). Amplification of the genes coding for these transporters (*FCY2* for cytosine and *FUR4* for uracil), using multicopy plasmids, results in at least 6- to 30-fold overexpression of proteins. In these recombinant strains, the basal rate of proton uptake is increased by a factor of at least 3 in the presence of uracil and a factor of 2 with cytosine, which corresponds with the proposed H^+ /symport mechanism for these nucleosides.

Antiport

Antiport systems catalyze the exchange of various mono- and divalent cations for protons in the plasma membrane (56, 178). Detailed biochemical and genetic information on these antiport systems is limited, but these systems are likely to play a major role in cell volume control, regulation of cytoplasmic pH, and ion homeostasis of the cytoplasm. The recent cloning and characterization of *sod2*, a Na^+/H^+ antiporter of *Schizosaccharomyces pombe* (96), offers valuable prospects for further work on this class of transport systems.

The gene *ART1* was found to confer resistance to aminotriazole, an inhibitor of the histidine biosynthetic pathway (99). On the basis of sequence comparisons, the *ART1* gene product, together with five homologs in *S. cerevisiae* (8), belongs to the major facilitator superfamily (116) and functions as an antiporter.

Regulation of Secondary Solute Transport

S. cerevisiae has a number of signal-transducing pathways that enable the cell to respond to external stimuli. The cellular responses caused by these stimuli are thought to be mediated by proteins which reside in the plasma membrane. One of the best-studied examples is the cyclic AMP (cAMP) signalling pathway. If sugar-respiring or derepressed (grown on nonfermentable carbon sources) cells of *S. cerevisiae* are fed with glucose or other fermentable sugars such as fructose or sucrose, a number of metabolic changes occur very rapidly, including inhibition of gluconeogenesis (e.g., inactivation of fructose-1,6-bisphosphatase and other gluconeogenic enzymes), inhibition of various uptake systems (91), stimulation of glycolysis (activation of phosphofructokinase [131]), and mobilization of the storage sugar trehalose (203) (for reviews, see

references 192 and 195). The addition of the fermentable sugar (first messenger) causes a rapid, transient increase in the level of the second-messenger cAMP, which in turn activates (specific) protein kinases (117). Signal transduction from the first to the second messenger is mediated by the yeast RAS proteins and the RAS-activating protein, CDC25; this system is designated the RAS-adenylate cyclase pathway (117). The pathway regulates the activity of the membrane-bound adenylate cyclase, an enzyme that catalyzes the synthesis of cAMP. Knowledge about the upstream part of the pathway is limited, but the sensor of glucose-induced cAMP signalling could be one or more of the low-affinity glucose carriers or a specific glucose receptor (17, 192). The FDP1/GGS1 protein, previously thought to be the glucose sensor (193), is a subunit of the trehalose synthase complex and apparently regulates glucose transport (195).

As far as sugar metabolism is concerned, only sugar kinase activity is required for induction of the cAMP signal by glucose. Not only fermentable sugars but also intracellular acidification and nitrogen starvation can elicit a rapid activation or inactivation of enzymes known to be regulated by cAMP-dependent phosphorylation (194). Intracellular acidification, but not nitrogen limitation, constitutes an alternative means to activate the RAS-adenylate cyclase pathway. For activation of cAMP-dependent protein kinase A by the nitrogen source, a separate signal transduction pathway has been proposed which activates the enzyme at constant cAMP levels (192).

The phosphorylation of transport proteins by protein kinases, which are activated by cAMP, has been proposed to be a trigger for the controlled degradation of the protein. Alternatively, it is possible that conditions effecting cAMP-dependent protein phosphorylation coincide with those that effect transport protein breakdown. A role for cAMP-dependent protein kinase in (catabolite) inactivation of the glucose and galactose transporters is suggested from studies of mutants with different kinase activities (155). However, these results have recently been disputed by studies with similar mutants but different experimental conditions (161). For catabolite inactivation of the maltose transport protein, specific proteolysis of the protein is proposed (113), but the mechanism of this degradation has not been unravelled.

The uracil permease is stable in exponentially growing cells, but the turnover of the permease increases when the yeast cell approaches the stationary phase of growth, i.e. when the cells are starved of a nitrogen, phosphorus, or carbon source and/or when protein synthesis is inhibited (210). Recently, Galan et al. (66) showed that the substitution of an arginine by alanine in a cyclin-like destruction box in the primary amino acid sequence of the uracil permease protects the permease against stress induced degradation. A and B cyclins undergo regulated degradation at specific stages of the cell cycle, and conjugation of these proteins to ubiquitin appears to be essential for the targeting of the proteins for degradation (87). It is likely that the uracil permease is ubiquitinated, analogous to the ubiquitinated Ste6 protein (104), indicating a role of the stress-induced ubiquitin degradation pathway (60). For Ste6p and the uracil permease, the vacuole has been shown to be the site of degradation (45, 210). Both proteins are internalized from the cell surface via endocytosis, yielding endosomal membranes that travel to the vacuole. The hydrolytic enzymes of the vacuole degrade proteins via processes known as micro- and macroautophagy (6, 201). Microautophagy is the sequestration of small portions of the cytoplasm by invagination of the vacuolar membrane or by wrapping of a flaplike protrusion. Macroautophagy refers to the sequestration of organelles and cytosol within vesicles of the vacuolar system. It is very possible that

the endosomal membranes containing the transporter proteins are sequestered into the vacuole by macroautophagy.

ISOLATION OF FUNCTIONAL PLASMA MEMBRANES

Some aspects of solute transport can be examined by using intact cells, but care should be taken of metabolic conversion and/or compartmentalization of the transported molecule. The interference of cytoplasmic processes or components with transport processes can often be restricted by using suitable substrate analogs or, even better, by using appropriate mutants in which the first step of the metabolism of a solute is blocked. However, because of complexity resulting from compartmentalization of solutes and the difficulty in manipulating energetic parameters, etc., it is often difficult to draw unequivocal conclusions regarding mechanisms of energy coupling to transport and the regulation of transport. Isolated plasma membrane vesicles, in which the effects of cellular metabolism are eliminated, have been used to study the facilitated diffusion of sugars and amino acids in yeast cells (62, 137, 139, 140, 156, 208). To isolate the plasma membrane vesicles, the membrane has to be separated from other cellular components. The first step is the removal of the cell wall, for which different strategies can be used. One of the commonly used methods involves the use of lytic enzymes that digest the β -linked glucan molecules of the cell wall. The resulting spheroplasts can be lysed, and plasma membranes are isolated by differential centrifugation and/or density centrifugation. This method has been widely used to study the composition of the plasma membrane (20, 142). Another method involves mechanical disruption of the cell wall with glass beads. This method is relatively harsh and can result in breakage of other cell organelles, which may cross-contaminate the plasma membrane fraction. After breaking of the cells, the membrane fractions are purified by differential centrifugation. In general, the mitochondria can be sedimented specifically by acid precipitation at pH 4.9, followed by centrifugation. The purity of the resulting plasma membranes can be assessed by monitoring the vanadate and azide sensitivity of the ATPase activities (Table 3). The (vanadate-sensitive) Pma1 ATPase is a marker enzyme for the plasma membrane, whereas the (azide-sensitive) F_0F_1 ATPase is a marker enzyme for the mitochondria (69). By using mechanical disruption of the cell wall in combination with differential centrifugation, a plasma membrane purity of 90% can easily be achieved.

FUSION OF PLASMA MEMBRANES WITH LIPOSOMES

Isolated yeast plasma membranes do not constitute well-sealed vesicles but, rather, form membrane sheets, which are leaky to protons and other ions (177). Relatively well-sealed membranes can be obtained by fusing the membrane sheets with preformed liposomes (see below). However, a proton motive force cannot be easily generated in these membrane vesicles, since plasma membranes with a right-side-out configuration have the catalytic domain of the plasma membrane ATPase present at the inner surface of the membrane which is not accessible for ATP. In membranes which are inside out, ATP hydrolysis results in a reversed proton motive force (inside positive and acid), which is often not suitable for the study of membrane transport processes. Procedures have been described to generate artificially a Δp across the membrane which has the appropriate orientation (inside negative and alkaline) (89). However, these potentials are not constant in time, which limits the applicability in the analysis of membrane transport (140). To generate a Δp for longer periods, powerful Δp -gen-

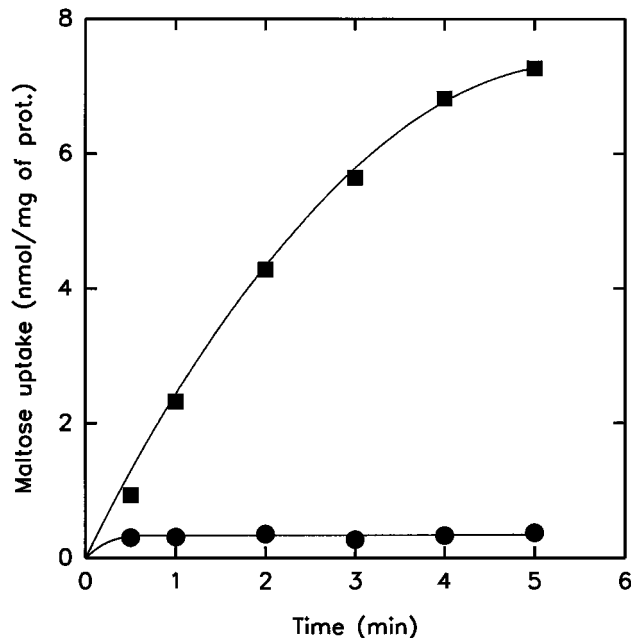

FIG. 13. Comparison of maltose uptake in hybrid membranes formed by sonication (●) and by extrusion (■). Membranes were energized with ascorbate, cytochrome *c*, and *N,N,N',N'*-tetramethyl-*p*-phenylenediamine (TMPD). The uptake experiment was performed in 100 mM potassium phosphate-citrate (pH 5.5) and started with the addition of 40 μ M [14 C]maltose.

erating systems can be functionally incorporated into membrane vesicles of bacteria, fungi, and yeasts. The advantages and disadvantages of different proton pumps and the methods of membrane fusion have recently been reviewed (52). Cytochrome *c* oxidase from bovine heart mitochondria is most frequently used as an H^+ pump to generate a Δp (inside negative and alkaline), since this enzyme is most versatile in its applicability (high activity, functional over a wide pH range). For fusion of plasma membranes with cytochrome *c* oxidase-containing liposomes, the membranes are mixed, frozen in liquid nitrogen, and allowed to thaw undisturbed at room temperature. This results in multilamellar membrane structures that can be converted into unilamellar membranes by sonication or by extrusion of the hybrid membranes through filters of defined pore size (205a). While bacterial membranes are relatively resistant toward sonication, it appears that yeast plasma membranes are not. For yeast membranes, the extrusion method has proven to be superior to sonication. Moreover, the extrusion method has the additional advantage that hybrid membranes with a more uniform size are obtained. Typical results of the uptake of maltose in hybrid membranes prepared by sonication and extrusion are shown in Fig. 13.

SECRETORY VESICLES

A novel yeast protein expression system has been introduced which takes advantage of the temperature-sensitive yeast mutant with the *sec6-4* mutation (215). This mutant is defective in the final step of the vesicular secretory pathway. At the non-permissive temperature, the *sec6-4* mutant accumulates large amounts of secretory vesicles which contain newly synthesized plasma membrane proteins. The secretory vesicles can be isolated with a high purity. The vesicles are well sealed, and the plasma membrane Pma1 ATPase (127) and P glycoprotein from mice (168) have been shown to be functional in these

membranes. Upon addition of ATP, a proton motive force (inside positive and acid) is generated (127), indicating that the orientation of the membranes is predominantly inside out with respect to the plasma membrane. These vesicles are suitable for the study of ATP-dependent transport and proton-linked antiport processes.

FUNCTIONAL STUDIES IN HYBRID MEMBRANES

Studies on glucose and galactose transport in hybrid membranes (62, 137, 156) have substantiated that these solutes are indeed transported by uniport. However, a detailed characterization of these transport systems has not yet been undertaken. In vitro evidence for solute-proton symport was first obtained for the uptake of leucine (140). Transport studies of hybrid membranes of *S. cerevisiae* have also been undertaken in an attempt to estimate the proton/maltose stoichiometry of the transport reaction (208). The *CAN1* gene product, which facilitates arginine transport (90), has been studied in artificial membranes following overexpression of the transport protein. The K_m^{app} values for arginine transport in the hybrid membranes correspond to the values estimated in whole-cell studies (139). By using hybrid membranes, the uptake of glutamate and threonine has also been shown to be driven by the Δp (205a). Furthermore, it has been demonstrated that transport of arginine at very low substrate concentrations is reversible upon dissipation of the Δp and that accumulated arginine can be exchanged with excess of unlabelled arginine on the outside. Similar observations have been made for maltose transport (205a). These results are at variance with previous observations which indicated that transport of arginine and other amino acids is unidirectional in *S. cerevisiae* (56, 139). *trans* inhibition or substrate inhibition (92) following accumulation of the substrate would form the basis for the observed irreversibility of transport (76). Our studies with hybrid membranes indicate that kinetic asymmetry of the carriers may slow the exit transport at high substrate concentrations but that the transport reactions are fully reversible (205a). Finally, the irreversibility of arginine transport in intact yeast cells is most probably the result of the large capacity of the vacuole to sequester basic amino acids by a mechanism of solute/proton antiport (101, 171).

Studies on solute transport in membrane vesicles of bacteria have revealed that the lipid composition of the membranes is an important factor of transport activity (35, 53, 94). A study on the influence of the phospholipid composition on transport in yeasts, using hybrid membrane vesicles of *Kluyveromyces marxianus*, suggested that transport of galactose is stimulated by PE (207).

CONCLUDING REMARKS

The statement, made in the Introduction, that "the plasma membrane separates the other membranes and cell components from the external medium" is clearly an insufficient description of the many functions of the plasma membrane. Many processes that are vital for the organism take place at the plasma membrane. Applications of methods from both membrane biochemistry and molecular genetics have been used to analyze the molecular properties of the plasma membrane and its constituents. The studies of the membrane biology in the lower eukaryotes is most advanced for *S. cerevisiae*, but much remains to be learned in the near future, as discussed below.

(i) The lipid composition of the plasma membrane is liable to undergo changes under different growth conditions. It has been shown that these changes can affect the activity of various

enzymes, including transporters and other plasma membrane associated proteins. For instance, enrichment of the plasma membrane with PI enhances the activity of the plasma membrane ATPase, whereas galactose transport is stimulated by PE. However, for none of these enzymes has a systematic study on lipid requirements been carried out. It is also clear that different strains of *S. cerevisiae* can have major differences in lipid composition, which emphasizes the need for a controllable model system which allows manipulation of the lipid composition.

(ii) The effects of the different components of the proton motive force (Δp) on the transport processes have never been investigated properly. This is a serious lack in our knowledge of the transport processes, since the Δp may not only be a driving force of the transport reaction but may also affect transport processes kinetically (148).

(iii) Unidirectional transport has been observed for almost all secondary transport systems studied to date. A thermodynamic basis for these observations has never been offered. Experiments with hybrid plasma membranes indicate that the transport processes are reversible. Kinetic asymmetry of the transporters may result in exit transport that is slow compared with uptake transport, in particular at high substrate concentrations.

(iv) The regulation of transport activity is poorly understood. The effect of protein phosphorylation on sugar transport is a matter of long-standing debate. Catabolite inactivation of various transporters is observed, but knowledge of the mechanisms of inactivation or targeting of proteins for proteolysis is lacking. The regulation of the uracil transport activity points towards regulation that is mediated by ubiquitination.

(v) The number of genes coding for individual transport proteins and their expression levels have not been fully documented. Manipulation of the transport proteins by genetic means may help to identify domains in the proteins that are targets of posttranslational modification (regulation).

The use of hybrid membranes and secretory vesicles will advance the molecular characterization of transport processes in yeasts. The regulation of transport activity by phosphorylation may be studied in these membranes by inclusion of phosphorylating enzymes (e.g., kinases). Reconstitution of purified transport proteins with various enzymes will allow the identification of factors that control transport activity such as phosphorylation. Detailed genetic analysis and manipulation of the genes encoding transport systems may provide insight into the molecular mechanism of transport but may also help to identify factors that affect the regulation of transport activity.

ACKNOWLEDGMENTS

This work was supported by the Foundation for Technical Sciences (Stichting Technische Wetenschappen) with financial aid from the Netherlands Organization for Scientific Research (Nederlandse Organisatie voor Wetenschappelijk Onderzoek) and by a grant from the Royal Gist-Brocades NV, Delft, The Netherlands.

We thank A. J. M. Driessen for providing some of the drawings.

REFERENCES

- Aalto, M. K., H. Ronne, and S. Keränen. 1993. Yeast syntaxins Sso1p and Sso2p belong to a family of related membrane proteins that function in vesicular transport. *EMBO J.* **12**:4095–4104.
- André, B., C. Hein, M. Grenson, and J. C. Jauniaux. 1993. Cloning and expression of the *UGA4* gene coding for the inducible GABA-specific transport protein of *Saccharomyces cerevisiae*. *Mol. Gen. Genet.* **237**:17–25.
- Anraku, Y., N. Umemoto, R. Hirata, and Y. Wada. 1989. Structure and function of the yeast vacuolar membrane proton ATPase. *J. Bioenerg. Biomembr.* **21**:589–603.
- Atkinson, K., S. Fogel, and S. A. Henry. 1980. Yeast mutant defective in phosphatidylserine synthase. *J. Biol. Chem.* **255**:6653–6661.
- Atkinson, K. D., B. Jensen, A. I. Kolat, E. M. Storm, S. A. Henry, and S. Fogel. 1980. Yeast mutants auxotrophic for choline or ethanolamine. *J. Bacteriol.* **141**:558–564.
- Baba, M., K. Takeshige, N. Baba, and Y. Ohsumi. 1994. Ultrastructural analysis of the autophagic process in yeast: detection of autophagosomes and their characterization. *J. Cell Biol.* **124**:903–913.
- Baker, D., L. Hicke, M. Rexach, M. Schleyer, and R. Schekman. 1988. Reconstitution of *SEC* gene product-dependent intercompartmental protein transport. *Cell* **54**:335–344.
- Balzi, E., and A. Goffeau. 1994. Genetics and biochemistry of yeast multidrug resistance. *Biochim. Biophys. Acta* **1187**:152–162.
- Bankiatis, V. A., J. R. Aitken, A. E. Cleves, and W. Dowhan. 1990. An essential role for a phospholipid transfer protein in yeast golgi function. *Nature (London)* **347**:561–562.
- Barlowe, C., and R. Schekman. 1993. *SEC12* encodes a guanine-nucleotide-exchange factor essential for transport vesicle budding from the endoplasmic reticulum. *Nature (London)* **365**:347–349.
- Barnes, G., D. G. Drubin, and T. Stearns. 1990. The cytoskeleton of *Saccharomyces cerevisiae*. *Curr. Opin. Cell Biol.* **2**:109–115.
- Becker, J., T. J. Tan, H. H. Trepte, and D. Gallwitz. 1991. Mutational analysis of the putative effector domain of the GTP binding Ypt1 protein in yeast suggests specific regulation by a novel Gap activity. *EMBO J.* **10**:785–792.
- Benito, B., and R. Lagunas. 1992. The low-affinity component of *Saccharomyces cerevisiae* maltose transport is an artifact. *J. Bacteriol.* **174**:3065–3069.
- Berhe, A., U. Fristedt, and B. L. Persson. 1995. Expression and purification of the high-affinity phosphate transporter of *Saccharomyces cerevisiae*. *Eur. J. Biochem.* **277**:566–572.
- Bertl, A., D. Gradmann, and C. L. Slayman. 1992. Calcium- and voltage-dependent ion channels in *Saccharomyces cerevisiae*. *Philos. Trans. R. Soc. London Ser. B* **338**:63–72.
- Betz, R., J. W. Crabb, H. E. Meyer, R. Wittig, and W. Dantze. 1987. Amino acid sequences of a-factor mating peptides from *Saccharomyces cerevisiae*. *J. Biol. Chem.* **262**:546–548.
- Bisson, L. F., D. M. Coons, A. L. Kruckeberg, and D. A. Lewis. 1993. Yeast sugar transporters. *Crit. Rev. Biochem. Mol. Biol.* **28**:259–308.
- Bisson, L. F., and D. G. Fraenkel. 1983. Involvement of kinases in glucose and fructose uptake by *Saccharomyces cerevisiae*. *Proc. Natl. Acad. Sci. USA* **80**:1730–1734.
- Borst-Pauwels, G. W. F. H., A. P. R. Theuvenet, and P. H. J. Peters. 1975. Uptake by yeast: interaction of Rb^+ , Na^+ and phosphate. *Physiol. Plant.* **33**:8–12.
- Bottema, C. D. K., C. A. McLean-Bowen, and L. W. Parks. 1983. Role of sterol structure in the thermotropic behaviour of plasma membranes of *Saccharomyces cerevisiae*. *Biochim. Biophys. Acta* **734**:235–248.
- Bozzato, R. P., and D. D. Tinker. 1987. Purification and properties of two phospholipid transfer proteins from yeast. *Biochem. Cell Biol.* **65**:195–202.
- Braun, P. C., and R. A. Calderone. 1978. Chitin synthase in *Candida albicans*: comparison of yeast and hyphal forms. *J. Bacteriol.* **133**:1472–1475.
- Bretscher, M. S., and S. Munro. 1993. Cholesterol and the Golgi apparatus. *Science* **261**:1280–1281.
- Brocklehurst, R., D. Gardner, and A. A. Eddy. 1977. The absorption of protons with α -methylglucoside and α -thioethylglucoside by the yeast *N.C.Y.C. 240*. *Biochem. J.* **162**:591–596.
- Bulawa, C. E., M. Slater, E. Cabib, J. Au-Young, A. Sburlati, W. L. Adair, and P. W. Robbins. 1986. The *Saccharomyces cerevisiae* structural gene for chitin synthase is not required for chitin synthesis in vivo. *Cell* **46**:213–225.
- Bun-ya, M., M. Nishimura, S. Harashima, and Y. Oshima. 1991. The *PHO84* gene of *Saccharomyces cerevisiae* encodes an inorganic phosphate transporter. *Mol. Cell Biol.* **11**:3229–3238.
- Busturia, A., and R. Lagunas. 1985. Identification of two forms of the maltose transport system in *Saccharomyces cerevisiae* and their regulation by catabolite inactivation. *Biochim. Biophys. Acta* **820**:324–326.
- Cabib, E., S. J. Silverman, A. Sburlati, and M. L. Slater. 1989. Chitin synthesis in yeast (*Saccharomyces cerevisiae*), p. 31–41. *In* P. J. Kuhn, A. P. J. Trinci, M. J. Jung, M. W. Goosey, and L. G. Copping (ed.), *Biochemistry of cell walls and membranes in fungi*. Springer-Verlag KG, Berlin.
- Canh, D. S., J. Horák, A. Kotyk, and L. Rihová. 1975. Transport of acyclic polyols in *Saccharomyces cerevisiae*. *Folia Microbiol.* **20**:320–325.
- Carman, G. M., and S. A. Henry. 1989. Phospholipid biosynthesis in yeast. *Annu. Rev. Biochem.* **58**:635–669.
- Cartwright, C. P., A. H. Rose, J. Calderbank, and M. H. J. Keenan. 1989. Solute transport, p. 5–56. *In* A. H. Rose and J. S. Harrison (ed.), *The yeasts*, vol. 3. Metabolism and physiology of yeasts, 2nd ed. Academic Press Ltd., London.
- Casey, W. M., G. A. Kessler, and L. W. Parks. 1992. Regulation of partitioned sterol biosynthesis in *Saccharomyces cerevisiae*. *J. Bacteriol.* **174**:7283–7288.
- Carbon, J., and V. Calderon. 1991. Changes of the compositional asymmetry of phospholipids associated to the increment in the membrane surface potential. *Biochim. Biophys. Acta* **1067**:139–144.

34. **Chant, J., and I. Herskowitz.** 1991. Genetic control of bud site selection in yeast by a set of gene products that constitute a morphogenetic pathway. *Cell* **65**:1203–1212.
35. **Chen, C. C., and T. H. Wilson.** 1984. The phospholipid requirement for activity of the lactose carrier of *Escherichia coli*. *J. Biol. Chem.* **259**:10150–10158.
36. **Cheng, Q., and C. A. Michels.** 1991. *MAL11* and *MAL61* encode the inducible high-affinity maltose transporters of *Saccharomyces cerevisiae*. *J. Bacteriol.* **173**:1817–1820.
37. **Cleves, A. E., T. McGee, E. Whitters, K. Champion, and J. Aitken.** 1991. Mutations in CDP-choline pathway for phospholipid biosynthesis bypass the requirement for an essential phospholipid transfer protein. *Cell* **64**:789–800.
38. **Cockburn, M., P. Earnshaw, and A. A. Eddy.** 1975. The stoichiometry of the absorption of protons with phosphate and L-glutamate by yeast of the genus *Saccharomyces*. *Biochem. J.* **146**:705–712.
39. **Colbeer, T., and D. R. Threfall.** 1989. Biosynthesis of terpenoid lipids, p. 116. In C. Ratledge and S. G. Wilkinson (ed.), *Microbial lipids*. Academic Press, Inc., New York.
40. **Collander, R., O. Turpeinen, and E. Fabritius.** 1931. Die Permeabilität der Rhoec-zellen für Ammoniak und Essigsäure. *Protoplasma* **13**:348–362.
41. **Cottrell, M., B. C. Viljoen, J. F. L. Kock, and P. H. Lategan.** 1986. The long chain fatty acid compositions of species representing the genera *Saccharomyces*, *Schwanniomyces* and *Lipomyces*. *J. Gen. Microbiol.* **132**:2401–2403.
42. **Crowe, J. H., A. D. Panek, L. M. Crowe, A. M. Panek, and P. Soares-de Araujo.** 1991. Trehalose transport in yeast cells. *Biochem. Int.* **24**:721–730.
43. **Daum, G.** 1985. Lipids of mitochondria. *Biochim. Biophys. Acta* **822**:1–42.
44. **Daum, G., and F. Palttauf.** 1984. Phospholipid transfer in yeast: isolation and partial characterization of a phospholipid transfer protein from yeast cytosol. *Biochim. Biophys. Acta* **794**:385–391.
45. **Davis, N. G., J. L. Horecka, and G. F. Sprague.** 1993. *Cis-* and *trans-*acting function required for endocytosis of the yeast pheromone receptor. *J. Cell Biol.* **122**:53–65.
46. **Dawidowicz, E. A.** 1987. Dynamics of membrane lipid metabolism and turnover. *Annu. Rev. Biochem.* **56**:43–61.
47. **De Kruijff, B.** 1987. Polymorphic regulation of membrane lipid composition. *Nature (London)* **329**:587–588.
48. **De Kruijff, B., P. W. M. Van Dijk, R. A. Demel, A. Schuijff, F. Brants, and L. L. M. Van Deenen.** 1974. Non-random distribution of cholesterol in phosphatidylcholine bilayers. *Biochim. Biophys. Acta* **356**:1–7.
49. **Dennis, E. A., and E. P. Kennedy.** 1972. Intracellular sites of lipid synthesis and the biogenesis of mitochondria. *J. Lipid Res.* **13**:263–267.
50. **Deshaies, R. J., S. L. Sanders, D. A. Feldheim, and R. Schekman.** 1991. Assembly of yeast Sec proteins involved in translocation into the endoplasmic reticulum into a membrane bound multisubunit complex. *Nature (London)* **349**:806–808.
51. **Dressler, K. A., S. Mathias, and R. N. Kolesnick.** 1992. Tumor necrosis factor- α activates the sphingomyelin signal transduction pathway in a cell free system. *Science* **255**:1715–1718.
52. **Driessen, A. J. M., and W. N. Konings.** 1993. Insertion of lipids and proteins into bacterial membranes by fusion with liposomes. *Methods Enzymol.* **221**:394–408.
53. **Driessen, A. J. M., T. Zheng, G. In't Veld, J. A. F. Op den Kamp, and W. N. Konings.** 1988. The lipid requirement of the branched chain amino acid transport system of *Streptococcus cremoris*. *Biochemistry* **27**:865–872.
54. **Dufour, J. P., and A. Goffeau.** 1980. Molecular and kinetic properties of the purified plasma membrane ATPase of the yeast *Schizosaccharomyces pombe*. *Eur. J. Biochem.* **105**:145–154.
55. **Durán, A., B. Bowers, and E. Cabib.** 1975. Chitin synthetase zymogen is attached to the yeast plasma membrane. *Proc. Natl. Acad. Sci. USA* **72**:3952–3955.
56. **Eddy, A. A.** 1982. Mechanism of solute transport in selected eukaryotic micro-organisms. *Adv. Microb. Physiol.* **23**:1–78.
57. **Eilam, Y., M. Othman, and D. Halachmi.** 1990. Transient increase in Ca^{2+} influx in *Saccharomyces cerevisiae* in response to glucose: effects of intracellular acidification and cAMP levels. *J. Gen. Microbiol.* **136**:2537–2543.
58. **Farkas, V.** 1989. Polysaccharide metabolism, p. 317–366. In A. H. Rose and J. S. Harrison (ed.), *The yeasts*, 2nd ed. Academic Press Ltd., London.
59. **Ferro-Novick, S., and R. Hahn.** 1994. Vesicle fusion from yeast to man. *Nature (London)* **370**:191–193.
60. **Finley, D.** 1992. The yeast ubiquitin system, p. 539–581. In E. W. Jones, J. R. Pringle, and J. R. Broach (ed.), *The molecular and cellular biology of the yeast Saccharomyces cerevisiae*. Cold Spring Harbor Laboratory Press, Cold Spring Harbor, N.Y.
61. **Fleet, G. H.** 1991. Cell walls, p. 199–277. In A. H. Rose and J. S. Harrison (ed.), *The yeasts*, vol. 3, 2nd ed. Academic Press Ltd., London.
62. **Franzoso, A. J., and V. P. Cirillo.** 1983. Glucose transport activity in isolated plasma membrane vesicles from *Saccharomyces cerevisiae*. *J. Biol. Chem.* **258**:3608–3614.
63. **Fries, E., and J. Rothman.** 1980. Transport of vesicular stomatitis viral glycoprotein in a cell free extract. *Proc. Natl. Acad. Sci. USA* **77**:3870–3874.
64. **Fuhrmann, G. F., and B. Volker.** 1993. Misuse of graphical analysis in nonlinear sugar transport kinetics by Eadie-Hofstee plots. *Biochim. Biophys. Acta* **1145**:180–182.
65. **Gaber, R. F.** 1992. Molecular genetics of yeast ion transport. *Int. Rev. Cytol.* **137**:299–351.
66. **Galan, J. M., C. Volland, D. Urban-Grimal, and R. Haguenaer-Tsapis.** 1994. The yeast plasma membrane uracil permease is stabilized against stress induced degradation by a point mutation in a cyclin-like “destruction box.” *Biochem. Biophys. Res. Commun.* **201**:769–775.
67. **Gancedo, C., and R. Serrano.** 1989. Energy yielding metabolism in yeast, p. 205–259. In J. S. Harrison and A. H. Rose (ed.), *The yeasts*, vol. 3, 2nd ed. Academic Press, Inc., New York.
68. **Ghosh, T. K., J. Bian, and D. L. Gill.** 1990. Intracellular calcium release mediated by sphingosine derivatives generated in cells. *Science* **248**:1653–1656.
69. **Goffeau, A., and J. P. Dufour.** 1988. Plasma membrane ATPase from the yeast *Saccharomyces cerevisiae*. *Methods Enzymol.* **157**:528–533.
70. **Goffeau, A., K. Nakai, P. Slominski, and J. L. Risler.** 1993. The membrane proteins encoded by yeast chromosome 3 genes. *FEBS Lett.* **325**:112–117.
71. **Goffeau, A., and C. W. Slayman.** 1981. The proton translocating ATPase of the fungal plasma membrane. *Biochim. Biophys. Acta* **639**:197–223.
72. **Goffeau, A., P. Slonimski, K. Nakai, and J. L. Risler.** 1993. How many yeast genes code for membrane-spanning proteins. *Yeast* **9**:691–702.
73. **Goncalves, T., and M. C. Loureiro-Dias.** 1994. Aspects of glucose uptake in *Saccharomyces cerevisiae*. *J. Bacteriol.* **176**:1511–1513.
74. **Gorlich, D., S. Prehn, E. Hartman, K. U. Kalies, and T. A. Rapoport.** 1992. A mammalian homolog of Sec61p and SecYp is associated with ribosomes and nascent polypeptides during translocation. *Cell* **71**:489–503.
75. **Greenberg, M. L., and D. Axelrod.** 1993. Anomalous slow mobility of fluorescent lipid probes in the plasma membrane of the yeast *Saccharomyces cerevisiae*. *J. Membr. Biol.* **131**:115–127.
76. **Grenson, M.** 1992. Amino acid transporters in yeast: structure, function and regulation, p. 219–245. In J. J. H. M. De Pont (ed.), *Molecular aspects of transport proteins*. Elsevier Science Publishers BV, Amsterdam.
77. **Grenson, M., C. Hou, and M. Crabeel.** 1970. Multiplicity of the amino acid permeases in *Saccharomyces cerevisiae*. IV. Evidence for a general amino acid permease. *J. Bacteriol.* **103**:770–777.
78. **Gustin, M. C., X. L. Zhou, B. Martinac, and C. Kung.** 1988. A mechanosensitive ion channel in the yeast plasma membrane. *Science* **242**:762–765.
79. **Haese, E., J. Servos, and M. Brendel.** 1992. Isolation and characterization of additional genes influencing resistance to various mutagens in the yeast *Saccharomyces cerevisiae*. *Curr. Genet.* **21**:319–324.
80. **Hakomori, S.** 1990. Bifunctional role of glycosphingolipids. Modulators for transmembrane signaling and mediators for cellular interactions. *J. Biol. Chem.* **265**:18713–18716.
81. **Hann, B. C., and P. Walter.** 1991. The signal recognition particle in *Saccharomyces cerevisiae*. *Cell* **67**:131–144.
82. **Hannun, Y. A., and R. M. Bell.** 1989. Functions of sphingolipids and sphingolipid breakdown products in cellular regulation. *Science* **243**:500–507.
83. **Hannun, Y. A., C. R. Loomis, A. H. Merrill, and R. M. Bell.** 1986. Sphingosine inhibition of protein kinase C activity and of phorbol dibutyrate binding in vitro and in human platelets. *J. Biol. Chem.* **261**:12604–12609.
84. **Hardwick, K. G., and H. R. B. Pelham.** 1992. *SED5* encodes a 39-kD integral membrane protein required for vesicular transport between the ER and the Golgi complex. *J. Cell Biol.* **119**:513–521.
85. **Henry, S. A.** 1982. Membrane lipids of yeast: biochemical and genetic studies, p. 101–158. In J. N. Strathern, E. W. Jones, and J. R. Broach (ed.), *The molecular biology of the yeast Saccharomyces: metabolism and gene expression*. Cold Spring Harbor Laboratory, Cold Spring Harbor, N.Y.
86. **Henschke, P. A., and A. H. Rose.** 1991. Plasma membranes, p. 297–345. In A. H. Rose and J. S. Harrison (ed.), *The yeasts*, vol. 4, 2nd ed. Academic Press Ltd., London.
87. **Hershko, A., D. Ganoth, J. Pehrson, R. E. Palazzo, and L. H. Cohen.** 1991. Methylated ubiquitin inhibits cyclin degradation in clam embryo extracts. *J. Biol. Chem.* **266**:16376–16379.
88. **Higgins, C. F.** 1992. ABC transporters: from microorganism to man. *Annu. Rev. Cell. Biol.* **8**:67–113.
- 88a. **Hillinga, D.** Unpublished results.
89. **Hirata, H., K. Altendorf, and F. M. Harold.** 1973. Role of an electrical potential in the coupling of metabolic energy to active transport by membrane vesicles of *Escherichia coli*. *Proc. Natl. Acad. Sci. USA* **70**:1804–1807.
90. **Hoffman, W.** 1985. Molecular characterization of the *CAN1* locus in *Saccharomyces cerevisiae*. A transmembrane protein without N-terminal hydrophobic signal sequence. *J. Biol. Chem.* **260**:11831–11837.
91. **Holzer, H.** 1976. Catabolite inactivation in yeast. *Trends Biochem. Sci.* **1**:178–181.
92. **Hunter, D. R., and I. H. Segel.** 1973. Control of the general amino acid permease of *Penicillium chrysogenum* by transinhibition and turnover. *Arch. Biochem. Biophys.* **154**:387–399.
93. **Iida, H., S. Sakaguchi, Y. Yagawa, and Y. Anraku.** 1990. Cell cycle control by Ca^{2+} in *Saccharomyces cerevisiae*. *J. Biol. Chem.* **265**:21216–21222.
94. **In't Veld, G., A. J. M. Driessen, and W. N. Konings.** 1993. Bacterial solute transport proteins in their lipid environment. *FEMS Microbiol. Rev.* **12**:293–314.

95. Jauniaux, J. C., and M. Grenson. 1990. GAP1, the general amino acid permease gene of *Saccharomyces cerevisiae*: nucleotide sequence protein similarity with the other bakers yeast amino acid permeases and nitrogen catabolite repression. *Eur. J. Biochem.* **190**:39–44.
96. Jia, Z. P., N. McCullough, R. Martel, S. Hemmingsen, and P. G. Young. 1992. Gene amplification at a locus encoding a putative Na⁺/H⁺ antiporter confers sodium and lithium tolerance in fission yeast. *EMBO J.* **11**:1631–1640.
97. Johnston, M. 1987. A model fungal gene regulatory mechanism: the *GAL* genes of *Saccharomyces cerevisiae*. *Microbiol. Rev.* **51**:458–476.
98. Jungalwala, F. B., J. E. Evans, E. Bremer, and R. H. McCluer. 1983. Analysis of sphingoid bases by reversed-phase high performance liquid chromatography. *J. Lipid Res.* **24**:1380–1388.
99. Kanazawa, S., M. Driscoll, and K. Struhl. 1988. *ATRI*, a *Saccharomyces cerevisiae* gene encoding a transmembrane protein required for aminotriazole resistance. *Mol. Cell. Biochem.* **8**:664–673.
100. Kang, M. S., N. Elango, E. Mattia, J. Au-Young, P. W. Robbins, and E. Cabib. 1984. Isolation of chitin synthase form *Saccharomyces cerevisiae*. Purification of an enzyme by entrapment in the reaction product. *J. Biol. Chem.* **259**:14966–14972.
101. Kitamoto, K., K. Yoshizawa, Y. Ohsumi, and Y. Anraku. 1988. Dynamic aspects of vacuolar and cytosolic amino acid pools of *Saccharomyces cerevisiae*. *J. Bacteriol.* **170**:2683–2686.
102. Ko, C. H., and R. F. Gaber. 1991. *TRK1* and *TRK2* encode structurally related K⁺ transporters in *Saccharomyces cerevisiae*. *Mol. Cell. Biol.* **8**:4266–4273.
103. Ko, C. H., H. Liang, and R. F. Gaber. 1993. Roles of multiple glucose transporters in *Saccharomyces cerevisiae*. *Mol. Cell. Biol.* **13**:638–648.
104. Kölling, R., and C. P. Hollenberg. 1994. The ABC-transporter Ste6 accumulates in the plasma membrane in a ubiquitinated form in endocytosis mutants. *EMBO J.* **13**:3261–3271.
105. Kuchler, K., H. M. Goransson, M. N. Viswanathan, and J. Thorner. 1992. Dedicated transporters for peptide export and intercompartmental traffic in the yeast *Saccharomyces cerevisiae*. *Cold Spring Harbor Symp. Quant. Biol.* **57**:579–592.
106. Kuchler, K., R. E. Sterne, and J. Thorner. 1989. *Saccharomyces cerevisiae STE6* gene product: a novel pathway for protein export in eukaryotic cells. *EMBO J.* **8**:3973–3984.
107. Lagunas, R. 1993. Sugar transport in *Saccharomyces cerevisiae*. *FEMS Microbiol. Rev.* **104**:229–242.
108. Leppert, G., R. McDevitt, S. C. Falco, T. K. Van Dyk, M. B. Ficke, and J. Golin. 1990. Cloning by gene amplification of two loci conferring multiple drug resistance in *Saccharomyces*. *Genetics* **125**:13–20.
109. Lester, R. L., and M. R. Steiner. 1968. The occurrence of diphosphoinositide and triphosphoinositide in *Saccharomyces cerevisiae*. *J. Biol. Chem.* **243**:4889–4893.
110. Lian, J. P., and S. Ferro-Novick. 1993. Bos1p, an integral membrane protein of the endoplasmic reticulum to Golgi transport vesicles, is required for their fusion competence. *Cell* **73**:735–745.
111. Ljungdahl, P. O., C. J. Gimeno, C. A. Styles, and G. R. Fink. 1992. *SHR3*: a novel component of the secretory pathway specifically required for localization of amino acid permeases in yeast. *Cell* **71**:463–478.
112. Lösel, D. M. 1989. Lipids in the structure and function of fungal membranes, p. 119–133. *In* P. J. Kuhn, A. P. J. Trinci, M. J. Jung, M. W. Goosey, and L. G. Copping (ed.), *Biochemistry of cell walls and membranes in fungi*. Springer-Verlag KG, Berlin.
113. Lucero, P., M. Herweijer, and R. Lagunas. 1993. Catabolite inactivation of the yeast maltose transporter is due to proteolysis. *FEBS Lett.* **333**:165–168.
114. Malpartida, F., and R. Serrano. 1980. Purification of the yeast plasma membrane ATPase solubilized with a novel zwitterionic detergent. *FEBS Lett.* **111**:69–72.
115. Malpartida, F., and R. Serrano. 1981. Reconstitution of the proton translocation adenosine triphosphatase of yeast plasma membranes. *J. Biol. Chem.* **256**:4175–4177.
116. Marger, M. D., and M. H. Saier. 1993. A major superfamily of transmembrane facilitators that catalyze uniport, symport and antiport. *Trends Biochem. Sci.* **18**:3–20.
117. Mbonyi, K., M. Beullens, K. Detremerie, L. Geerts, and J. M. Thevelein. 1988. Requirement of one functional *RAS* gene and inability of an oncogenic ras variant to mediate the glucose-induced cyclic AMP signal in the yeast *Saccharomyces cerevisiae*. *Mol. Cell. Biochem.* **8**:3051–3057.
118. Meyers, S., W. Schauer, E. Balzi, M. Wagner, A. Goffeau, and J. Golin. 1992. Interaction of the yeast pleiotropic drug resistance genes *PDR1* and *PDR5*. *Curr. Genet.* **21**:431–436.
119. Michaljanicová, D., J. Hordan, and A. Kotyk. 1982. Maltotriose transport and utilization in baker's and brewer's yeast. *Folia Microbiol.* **27**:217–221.
- 119a. Michels, C. Personal communication.
120. Mitchell, P. 1963. Molecule, group and electron translocation through natural membranes. *Biochem. Soc. Symp.* **22**:142–169.
121. Mosse, M. O., P. Linder, J. Lazowska, and P. Slonimski. 1993. A comprehensive compilation of 1001 nucleotide sequences encoding for proteins from the yeast *Saccharomyces cerevisiae*. *Curr. Genet.* **23**:66–91.
122. Nagiec, M. M., G. B. Wells, R. L. Lester, and R. C. Dickson. 1993. A suppressor gene that enables *Saccharomyces cerevisiae* to grow without making sphingolipids encodes a protein that resembles an *Escherichia coli* fatty acetyltransferase. *J. Biol. Chem.* **268**:22156–22163.
123. Nakamoto, R. K., R. Rao, and C. W. Slayman. 1991. Expression of the yeast plasma membrane [H⁺]ATPase in secretory vesicles. *J. Biol. Chem.* **266**:7940–7949.
124. Nakano, A., and M. Muramatsu. 1989. A novel GTP-binding protein, Sarp, is involved in transport from the endoplasmic reticulum to the Golgi apparatus. *J. Cell Biol.* **9**:2677–2691.
125. Needleman, R. 1991. Control of maltase synthesis in yeast. *Mol. Microbiol.* **5**:2079–2084.
126. Nelson, N., and L. Taiz. 1989. The evolution of H⁺-ATPases. *Trends Biochem. Sci.* **14**:113–116.
127. Nes, W. D., G. G. Janssen, F. G. Crumley, M. Kalinowska, and T. Akihisa. 1993. The structural requirements of sterols for membrane function in *Saccharomyces cerevisiae*. *Arch. Biochem. Biophys.* **300**:724–733.
128. Newman, A. P., J. Shim, and S. Ferro-Novick. 1990. *Bet1*, *Bos1*, and *Sec22* are members of a group of interacting yeast genes required for transport from the endoplasmic reticulum to the Golgi complex. *Mol. Cell. Biol.* **10**:3405–3414.
129. Nickels, J. T., R. J. Buxeda, and G. M. Carman. 1994. Regulation of phosphatidylinositol 4-kinase from the yeast *Saccharomyces cerevisiae* by CDP-diacylglycerol. *J. Biol. Chem.* **269**:11018–11024.
130. Nishikawa, S., and A. Nakano. 1993. Identification of a gene required for membrane protein retention in the early secretory pathway. *Proc. Natl. Acad. Sci. USA* **90**:879–883.
131. Noshiro, A., C. Purwin, M. Laux, K. Nicolay, W. A. Scheffers, and H. Holzer. 1987. Mechanism of stimulation of endogenous fermentation in yeast by carbonyl cyanide *m*-chlorophenylhydrazone. *J. Biol. Chem.* **262**:14154–14157.
132. Novick, P., S. Ferro, and R. Schekman. 1981. Order of events in the yeast secretory pathway. *Cell* **25**:461–469.
133. Novick, P., C. Field, and R. Schekman. 1980. Identification of 23 complementation groups required for post-translational events in the yeast secretory pathway. *Cell* **21**:205–215.
134. Oehlen, B., and F. R. Cross. 1994. Signal transduction in the budding yeast *Saccharomyces cerevisiae*. *Curr. Opin. Cell Biol.* **6**:836–841.
135. Oka, T., and A. Nakano. 1994. Inhibition of GTP hydrolysis by Sar1p causes accumulation of vesicles that are a functional intermediate of the ER-to-Golgi transport in yeast. *J. Cell Biol.* **124**:425–434.
136. Oka, T., S. Nishikawa, and A. Nakano. 1991. Reconstitution of GTP-binding Sar1 protein function in endoplasmic reticulum to Golgi transport. *J. Cell Biol.* **114**:671–679.
137. Ongjoco, R., K. Szkutnicka, and V. P. Cirillo. 1987. Glucose transport in vesicles reconstituted from *Saccharomyces cerevisiae* membranes and liposomes. *J. Bacteriol.* **169**:2926–2931.
138. Op den Kamp, J. A. F. 1979. Lipid asymmetry in membranes. *Annu. Rev. Biochem.* **48**:47–71.
139. Opekarova, M., T. Caspari, and W. Tanner. 1993. Unidirectional arginine transport in reconstituted plasma-membrane vesicles from yeast overexpressing *CAN1*. *Eur. J. Biochem.* **211**:683–688.
140. Opekarova, M., A. J. M. Driessen, and W. N. Konings. 1987. Protonmotive-force-driven leucine uptake in yeast plasma membrane vesicles. *FEBS Lett.* **213**:45–48.
141. Paltauf, F., S. D. Kohlwein, and S. A. Henry. 1992. Regulation and compartmentalization of lipid synthesis in yeast, p. 415–500. *In* E. W. Jones, J. R. Pringle, and J. R. Broach (ed.), *The molecular and cellular biology of the yeast Saccharomyces: gene expression*, vol. 2, Cold Spring Harbor Laboratory Press, Cold Spring Harbor, N.Y.
142. Patton, J. L., and R. L. Lester. 1991. The phosphoinositol sphingolipids of *Saccharomyces cerevisiae* are highly localized in the plasma membrane. *J. Bacteriol.* **173**:3101–3108.
143. Patton, J. L., B. Srinivasan, R. C. Dickson, and R. L. Lester. 1992. Phenotypes of sphingolipid-dependent strains of *Saccharomyces cerevisiae*. *J. Bacteriol.* **174**:7180–7184.
144. Peters, P. H. J., and G. W. F. H. Borst-Pauwels. 1979. Properties of plasma membrane ATPase and mitochondrial ATPase of *Saccharomyces cerevisiae*. *Physiol. Plant.* **46**:330–337.
145. Pfeffer, S. R., and J. E. Rothman. 1987. Biosynthetic protein transport and sorting by the endoplasmic reticulum and Golgi. *Annu. Rev. Biochem.* **56**:829–852.
146. Pinto, W. J., G. B. Wells, and R. L. Lester. 1992. Characterization of enzymatic synthesis of sphingolipid long-chain bases in *Saccharomyces cerevisiae*: mutant strains exhibiting long-chain base auxotrophy are deficient in serine palmitoyltransferase activity. *J. Bacteriol.* **174**:2575–2581.
147. Pinto, W. J., G. B. Wells, A. C. Williams, K. A. Anderson, E. C. Teater, and R. L. Lester. 1986. Characterization of a *Saccharomyces cerevisiae* mutant defective in inositol sphingolipid synthesis. *Fed. Proc.* **45**:1826–1831.
148. Poolman, B., A. J. M. Driessen, and W. N. Konings. 1987. Regulation of solute transport in streptococci by external and internal pH values. *Microbiol. Rev.* **51**:498–508.

149. Poolman, B., and W. N. Konings. 1993. Secondary solute transport in bacteria. *Biochim. Biophys. Acta* **1183**:5–39.
150. Portillo, F., I. F. de Larrinoa, and R. Serrano. 1989. Deletion analysis of yeast plasma membrane H⁺-ATPase and identification of a regulatory domain at the carboxyl-terminus. *FEBS Lett.* **247**:381–385.
151. Portillo, F., and R. Serrano. 1988. Dissection of functional domains of the yeast proton pumping ATPase by directed mutagenesis. *EMBO J.* **7**:1793–1798.
152. Protopopov, V., B. Govindan, P. Novick, and J. E. Gerst. 1993. Homologs of the synaptobrevin/VAMP family of synaptic vesicle proteins function on the late secretory pathway in *Saccharomyces cerevisiae*. *Cell* **74**:855.
153. Pryer, N. K., L. J. Wuestehube, and R. Scheckman. 1992. Vesicle mediated protein sorting. *Annu. Rev. Biochem.* **61**:471–516.
154. Puoti, A., C. Desponds, and A. Conzelmann. 1991. Biosynthesis of mannosylinositolphosphoceramide in *Saccharomyces cerevisiae* is dependent on genes controlling the flow of secretory vesicles from the endoplasmic reticulum to the Golgi. *J. Cell Biol.* **113**:515–521.
155. Ramos, J., and V. P. Cirillo. 1989. Role of cyclic-AMP-dependent protein kinase in catabolite inactivation of the glucose and galactose transporters in *Saccharomyces cerevisiae*. *J. Bacteriol.* **171**:3545–3548.
156. Ramos, J., K. Szkutnicka, and V. P. Cirillo. 1989. Characteristics of galactose transport in *Saccharomyces cerevisiae* cells and reconstituted lipid vesicles. *J. Bacteriol.* **171**:3539–3544.
157. Rank, G. H., and A. J. Robertson. 1983. Protein and lipid composition of the yeast plasma membrane, p. 225–241. *In* J. F. T. Spencer, D. M. Spencer, and A. R. W. Smith (ed.), *Yeast genetics, fundamental and applied aspects*. Springer-Verlag KG, Berlin.
158. Ratray, J. B. M. 1988. Yeast, p. 555–697. *In* C. Ratledge and S. G. Wilkinson (ed.), *Microbial lipids*. Academic Press Ltd., London.
159. Reinhart, M. P. 1990. Intracellular sterol trafficking. *Experientia* **46**:599–611.
160. Rexach, M. F., and R. W. Schekman. 1991. Distinct biochemical requirements for the budding, targeting, and fusion of ER-derived transport vesicles. *J. Cell Biol.* **114**:219–229.
161. Riballo, E., M. J. Mazon, and R. Lagunas. 1994. cAMP-dependent protein kinase is not involved in catabolite inactivation of the transport of sugars in *Saccharomyces cerevisiae*. *Biochim. Biophys. Acta* **1191**:143–146.
162. Roberts, C. J., S. F. Nothwehr, and T. H. Stevens. 1992. Membrane protein sorting in the yeast secretory pathway: evidence that the vacuole may be the default compartment. *J. Cell Biol.* **119**:69–83.
163. Rodriguez, R. J., C. Low, C. D. K. Bottema, and L. W. Parks. 1985. Multiple functions for sterols in *Saccharomyces cerevisiae*. *Biochim. Biophys. Acta* **837**:336–343.
164. Rodriguez-Navarro, A., F. J. Quintero, and B. Garciadeblas. 1994. Na⁺-ATPases and Na⁺/H⁺ antiporters in fungi. *Biochim. Biophys. Acta* **1187**:203–205.
165. Roomans, G. M., and G. W. F. H. Borst-Pauwels. 1979. Interaction of phosphate with monovalent cation uptake in yeast. *Biochim. Biophys. Acta* **470**:84–91.
166. Rothman, J. E., and L. Orci. 1992. Molecular dissection of the secretory pathway. *Nature (London)* **355**:409–415.
167. Rudolph, H. K., A. Antebi, G. R. Fink, C. M. Buckley, T. E. Dorman, J. Vitre, L. S. Davidow, J. I. Mao, and D. T. Moir. 1989. The yeast secretory pathway is perturbed by mutations in *PMR1*, a member of a Ca²⁺ ATPase family. *Cell* **58**:133–145.
168. Ruetz, S., and P. Gros. 1994. Functional expression of P-glycoproteins in secretory vesicles. *J. Biol. Chem.* **269**:12277–12284.
169. Salama, N. R., T. Yeung, and R. W. Schekman. 1993. The Sec13p complex and reconstitution of vesicle budding from the ER with purified cytosolic proteins. *EMBO J.* **12**:4073–4082.
170. Santos, E., L. Rodriguez, M. V. Elorza, and R. Santandreu. 1982. Uptake of sucrose by *Saccharomyces cerevisiae*. *Arch. Biochem. Biophys.* **216**:652–660.
171. Sato, T., Y. Ohsumi, and Y. Anraku. 1984. Substrate specificities of active transport systems for amino-acids in vacuolar-membrane vesicles of *Saccharomyces cerevisiae*: evidence of 7 independent proton-amino-acid antiport systems. *J. Biol. Chem.* **259**:11505–11508.
172. Sbrulati, A., and E. Cabib. 1986. Chitin synthase 2, a presumptive participant in septum formation in *Saccharomyces cerevisiae*. *J. Biol. Chem.* **261**:15147–15152.
173. Schekman, R., and P. Novick. 1982. The secretory process and yeast cell-surface assembly, p. 361–393. *In* J. Strathern, E. W. Jones, and J. R. Broach (ed.), *The molecular biology of the yeast Saccharomyces: metabolism and gene expression*. Cold Spring Harbor Laboratory, Cold Spring Harbor, N.Y.
174. Scherrer, R., R. L. Loudon, and P. Gerhardt. 1974. Proximity of the yeast cell wall and membrane. *J. Bacteriol.* **118**:534–540.
175. Schlessner, A., S. U. Ulaszewski, M. Ghislain, and A. Goffeau. 1988. A second transport ATPase gene in *Saccharomyces cerevisiae*. *J. Biol. Chem.* **263**:19480–19487.
176. Serrano, R. 1977. Energy requirements for maltose transport in yeast. *Eur. J. Biochem.* **80**:97–102.
177. Serrano, R. 1978. Characterization of the plasma membrane ATPase of *Saccharomyces cerevisiae*. *Mol. Cell. Biochem.* **22**:51–62.
178. Serrano, R. 1991. Transport across yeast vacuolar and plasma membrane, p. 523–585. *In* E. W. Jones and J. R. Broach (ed.), *The molecular and cellular biology of the yeast Saccharomyces: genome dynamics, protein synthesis, and energetics*. Cold Spring Harbor Laboratory Press, Cold Spring Harbor, N.Y.
179. Serrano, R., M. C. Kielland-Brandt, and G. R. Fink. 1986. Yeast plasma membrane ATPase is essential for growth and has homology with (Na⁺, K⁺), K⁺ and Ca²⁺-ATPases. *Nature (London)* **319**:689–693.
180. Serrano, R., C. Montesinos, and J. Sanchez. 1988. Lipid requirement of the plasma membrane ATPases from oat roots and yeast. *Plant Sci.* **56**:117–122.
181. Shinitzky, M. 1984. Membrane fluidity and cellular functions, p. 1–51. *In* M. Shinitzky (ed.), *Physiology of membrane fluidity*. CRC Press, Inc., Boca Raton, Fla.
182. Singer, S. J., and G. L. Nicolson. 1972. The fluid mosaic model of the structure of cell membranes. *Science* **175**:720–731.
183. Slayman, C. L., P. Kaminski, and D. Stetson. 1989. Structure and function of fungal plasma membrane ATPases, p. 299–316. *In* P. J. Kuhn, A. P. J. Trinci, M. J. Jung, M. W. Goosey, and L. G. Copping (ed.), *Biochemistry of cell walls and membranes in fungi*. Springer-Verlag KG, Berlin.
184. Smith, S. W., and R. L. Lester. 1974. Inositol phosphorylceramide, a novel substance and the chief member of a group of yeast sphingolipids containing a single inositol phosphate. *J. Biol. Chem.* **249**:3395–3405.
185. Sollner, T., S. W. Whitehart, M. Brummer, H. Erdjument-Bromage, S. Geromanos, P. Tempst, and J. E. Rothman. 1993. SNAP receptors implicated in vesicle targeting and fusion. *Nature (London)* **362**:318–324.
186. Steiner, M. R., and R. L. Lester. 1970. In vitro study of the methylation pathway of phosphatidylcholine synthesis and the regulation of this pathway in *Saccharomyces cerevisiae*. *Biochemistry* **9**:63–69.
187. Supply, P., A. Wach, and A. Goffeau. 1993. Enzymatic properties of the PMA2 plasma membrane-bound H⁺-ATPase of *Saccharomyces cerevisiae*. *J. Biol. Chem.* **268**:19753–19759.
188. Sychrova, H., and M. R. Chevallier. 1993. Cloning and sequencing of the *Saccharomyces cerevisiae* gene *LYP1* coding for a lysine-specific permease. *Yeast* **9**:771–782.
189. Tanaka, J. I., and G. R. Fink. 1985. The histidine permease gene *HIP1* of *Saccharomyces cerevisiae*. *Gene* **38**:205–214.
190. Te Heesen, S., B. Janetzky, L. Lehle, and M. Aebi. 1992. The yeast *WBP1* is essential for oligosaccharyl transferase activity in vivo and in vitro. *EMBO J.* **11**:2071–2075.
191. Te Heesen, S., R. Knauer, L. Lehle, and M. Aebi. 1993. Yeast Wbp1p and Swp1p form a protein complex essential for oligosaccharyl transferase activity. *EMBO J.* **12**:279–284.
192. Thevelein, J. M. 1991. Fermentable sugars and intracellular acidification as specific activators of the RAS-adenylate cyclase signalling pathway in yeast: the relationship to nutrient-induced cell cycle control. *Mol. Microbiol.* **5**:1301–1307.
193. Thevelein, J. M. 1992. The RAS-adenylate cyclase pathway and cell cycle control in *Saccharomyces cerevisiae*. *Antonie Leeuwenhoek* **62**:109–130.
194. Thevelein, J. M., and M. Beullens. 1985. Cyclic AMP and the stimulation of trehalase activity in the yeast *Saccharomyces cerevisiae* by carbon sources, nitrogen sources, and inhibition of protein synthesis. *J. Gen. Microbiol.* **131**:3199–3209.
195. Thevelein, J. M., and S. Hohmann. 1995. Trehalose synthase: guard to the gate of glycolysis in yeast. *Trends Biochem. Sci.* **20**:3–10.
196. Thudichum, J. L. W. 1884. A treatise on the chemical constitution of brain. Bailliere, Tindall, and Cox, London.
197. Trivedi, A., D. J. Fantin, and E. R. Tustanoff. 1987. Role of phosphatidylinositol on the activity of yeast plasma membrane ATPase, p. 207–215. *In* S. C. Goheen (ed.), *Membrane proteins*. Bio-Rad Laboratories, Richmond, Calif.
198. Trivedi, A., S. Khare, G. S. Singhal, and R. Prasad. 1982. Effect of phosphatidylcholine and phosphatidylethanolamine on the structure and function of yeast membrane. *Biochim. Biophys. Acta* **692**:202–209.
199. Trivedi, A., G. S. Singhal, and R. Prasad. 1983. Effect of phosphatidyl serine enrichment on amino-acid transport in yeast. *Biochim. Biophys. Acta* **729**:85–89.
200. Tschoopp, J. F., S. D. Erm, C. Field, and R. Schekman. 1986. *GAL2* codes for a membrane-bound subunit of the galactose permease in *Saccharomyces cerevisiae*. *J. Bacteriol.* **166**:313–318.
201. Tuttle, D. L., A. S. Lwein, and W. A. Dunn. 1993. Selective autophagy of peroxisomes in methylotrophic yeasts. *Eur. J. Cell Biol.* **60**:283–290.
202. Uchida, E., Y. Ohsumi, and Y. Anraku. 1988. Purification of yeast vacuolar membrane H⁺-ATPase and enzymological discrimination of three ATP-driven proton pumps in *Saccharomyces cerevisiae*. *Methods Enzymol.* **157**:544–562.
203. Uno, I., K. Matsumoto, K. Adachi, and T. Isgikawa. 1983. Genetic and biochemical evidence that trehalase is a subunit of cAMP-dependent protein kinase in yeast. *J. Biol. Chem.* **258**:10867–10972.
204. Van Dam, K. 1994. Regulation and control of energy coupling at the cellular level. *Biochim. Biophys. Acta* **1187**:129–131.

205. **Van de Mortel, J. B. J., D. Mulders, H. Korthout, A. P. R. Theuvenet, and G. W. F. H. Borst-Pauwels.** 1988. Transient hyperpolarization of yeast by glucose and ethanol. *Biochim. Biophys. Acta* **936**:421–428.
- 205a. **van der Rest, M. E., Y. de Vries, B. Poolman, and W. N. Konings.** Unpublished data.
206. **Van Dijck, P. W. M.** 1979. Negatively charged phospholipids and their position in the cholesterol affinity sequence. *Biochim. Biophys. Acta* **555**:89–101.
207. **Van Leeuwen, C. C. M., E. Postma, P. J. A. Van den Broek, and J. Van Steveninck.** 1991. Proton-motive force-driven D-galactose transport in plasma membrane vesicles from the yeast *Kluyveromyces marxianus*. *J. Biol. Chem.* **266**:12146–12151.
208. **Van Leeuwen, C. C. M., R. A. Weusthuis, E. Postma, and P. J. A. Van den Broek.** 1992. Maltose/proton co-transport in *Saccharomyces cerevisiae*. *Biochem. J.* **284**:441–445.
209. **Voelker, D. R.** 1991. Organelle biogenesis and intracellular lipid transport in eukaryotes. *Microbiol. Rev.* **55**:543–560.
210. **Volland, C., D. Urban-Grimal, G. Geraud, and R. Haguenauer-Tsapis.** 1994. Endocytosis and degradation of the yeast uracil permease under adverse conditions. *J. Biol. Chem.* **269**:9833–9841.
211. **Waechter, C. J., and R. L. Lester.** 1973. Differential regulation of the N-methyl transferases responsible for phosphatidylcholine synthesis in *Saccharomyces cerevisiae*. *Arch. Biochem. Biophys.* **158**:401–410.
212. **Walsh, M. C., H. P. Smits, M. Scholte, and K. Van Dam.** 1994. Affinity of glucose transport in *Saccharomyces cerevisiae* is modulated during growth on glucose. *J. Bacteriol.* **176**:953–958.
213. **Walter, P., and V. R. Lingappa.** 1986. Mechanism of protein translocation across the endoplasmic reticulum membrane. *Annu. Rev. Cell Biol.* **2**:499–516.
214. **Walworth, N. C., B. Goud, A. K. Kabacell, and P. J. Novick.** 1989. Mutational analysis of *SEC4* suggests a cyclical mechanism for the regulation of vesicular traffic. *EMBO J.* **8**:1685–1693.
215. **Walworth, N. C., and P. J. Novick.** 1987. Purification and characterization of constitutive secretory vesicles from yeast. *J. Cell Biol.* **105**:163–174.
216. **Watson, K.** 1978. Membrane lipid composition: a determinant of anaerobic growth and petite formation in psychrophilic and psychrophobic yeast. *Biochem. Soc. Trans.* **6**:293–302.
217. **Wells, G. B., and R. L. Lester.** 1983. The isolation and characterization of a mutant strain of *Saccharomyces cerevisiae* that requires a long chain base for growth and for synthesis of phosphosphingolipids. *J. Biol. Chem.* **258**:10200–10203.
218. **Wendell, D. L., and L. F. Bisson.** 1993. Physiological characterization of putative high-affinity glucose transport protein Hxt2 of *Saccharomyces cerevisiae* by use of anti-synthetic peptide antibodies. *J. Bacteriol.* **175**:7689–7696.
219. **Wheals, A. E.** 1987. Biology of the cell cycle in yeasts, p. 283–390. *In* A. H. Rose and J. S. Harrison (ed.), *The yeasts*, 2nd ed. Academic Press Ltd., London.
220. **Wiame, J. M., M. Grenson, and H. N. Arst, Jr.** 1985. Nitrogen catabolite repression in yeasts and filamentous fungi. *Adv. Microb. Physiol.* **26**:1–87.
221. **Wieland, F. T., M. L. Gleason, T. A. Serafini, and J. E. Rothman.** 1987. The rate of bulk flow from the endoplasmic reticulum to the cell surface. *Cell* **50**:289–300.
222. **Wirtz, K. W. A., and D. B. Zilversmit.** 1968. Exchange of phospholipids between liver mitochondria and microsomes in vitro. *J. Biol. Chem.* **243**:3596–3602.
223. **Yeagle, P. L.** 1989. Lipid regulation of cell membrane structure and function. *FASEB J.* **3**:1833–1842.
224. **Yoshihisa, T., C. Barlowe, and R. W. Schekman.** 1993. Requirement for a GTPase-activating protein in vesicle budding from the endoplasmic reticulum. *Science* **259**:1466–1468.
225. **Zinser, E., F. Paltauf, and G. Daum.** 1993. Sterol composition of yeast organelle membranes and subcellular distribution of enzymes involved in sterol metabolism. *J. Bacteriol.* **175**:2853–2858.
226. **Zinser, E., C. D. M. Sperka-Gottlieb, E. V. Fasch, S. D. Kohlwein, F. Paltauf, and G. Daum.** 1991. Phospholipid synthesis and lipid composition of subcellular membranes in the unicellular eukaryote *Saccharomyces cerevisiae*. *J. Bacteriol.* **173**:2026–2034.