

University of Groningen

Study of the Calibration Channel Width for a Digital Sideband Separating System for SIS 2SB Receiver

Khudchenko, Andrey; Finger, R.; Baryshev, A.~M.; Mena, F.~P.; Rodriguez, R.; Hesper, R.; Fuentes, R.; Bronfman, L.

Published in:
Atacama Large-Aperture Submm/mm Telescope (AtLAST)

DOI:
[10.5281/zenodo.1159039](https://doi.org/10.5281/zenodo.1159039)

IMPORTANT NOTE: You are advised to consult the publisher's version (publisher's PDF) if you wish to cite from it. Please check the document version below.

Document Version
Publisher's PDF, also known as Version of record

Publication date:
2018

[Link to publication in University of Groningen/UMCG research database](#)

Citation for published version (APA):

Khudchenko, A., Finger, R., Baryshev, A. M., Mena, F. P., Rodriguez, R., Hesper, R., Fuentes, R., & Bronfman, L. (2018). Study of the Calibration Channel Width for a Digital Sideband Separating System for SIS 2SB Receiver. In *Atacama Large-Aperture Submm/mm Telescope (AtLAST)* (pp. 19) <https://doi.org/10.5281/zenodo.1159039>

Copyright

Other than for strictly personal use, it is not permitted to download or to forward/distribute the text or part of it without the consent of the author(s) and/or copyright holder(s), unless the work is under an open content license (like Creative Commons).

The publication may also be distributed here under the terms of Article 25fa of the Dutch Copyright Act, indicated by the "Taverne" license. More information can be found on the University of Groningen website: <https://www.rug.nl/library/open-access/self-archiving-pure/taverne-amendment>.

Take-down policy

If you believe that this document breaches copyright please contact us providing details, and we will remove access to the work immediately and investigate your claim.

Downloaded from the University of Groningen/UMCG research database (Pure): <http://www.rug.nl/research/portal>. For technical reasons the number of authors shown on this cover page is limited to 10 maximum.

Study of the calibration channel width for a Digital Sideband Separating system for SIS 2SB receivers

A. Khudchenko¹, R. Finger², A. M. Baryshev¹, F. P. Mena³, R. Rodriguez², R. Hesper¹, R. Fuentes² and L. Bronfman²

1 - NOVA/Kapteyn Astronomical Institute, University of Groningen, The Netherlands.

2 - Astronomy Department, University of Chile, Santiago, Chile.

3 - Electrical Engineering Department, University of Chile, Santiago, Chile.

Abstract

- Digital Sideband Separating (DSS):
 - Very promising concept for future (multipixel) heterodyne receivers.
 - Relaxes requirements for the Image Rejection Ratio (IRR) of analog receivers.
 - It improves the IRR substantially with simple hardware.
 - Ideal for spectral line surveys (it practically eliminates line confusion and atmospheric noise in the image band).
 - It is a potential option for a future ALMA upgrade.
- Recent work:
 - Applied to a full 2SB receiver (i.e. including the analog IF hybrid).
 - It allows reaching an IRR of 45 dB across the full band.
 - Calibration is more stable respect to the case without IF hybrid.
- Important question:
 - How wide should the calibration-channel width be in order to reach a desired IRR level?
 - It determines, for a large part, the calibration speed of the DSS system and influences the back-end architecture.

Concept of Digital Sideband Separating System

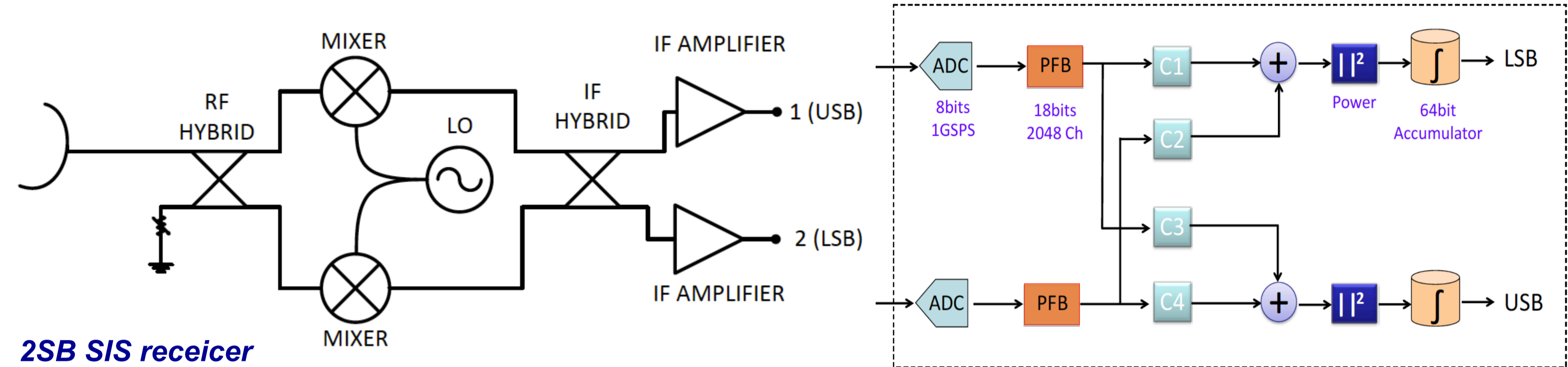

Sideband ratio correction scheme

The DSS system can be used either as:

- An adaptive IF hybrid to reach ultra-pure image rejection [Finger et al. A&A 2015]
- It can be applied to a full 2SB receiver for IRR correction [Rodriguez et al. A&A 2018].
- The latest option has advantages in stability and in possibility to be applied directly to existing instruments.

Implementation for ALMA Band-9 2SB receiver

Scheme of experiment: DSS system + Band 9 2SB receiver

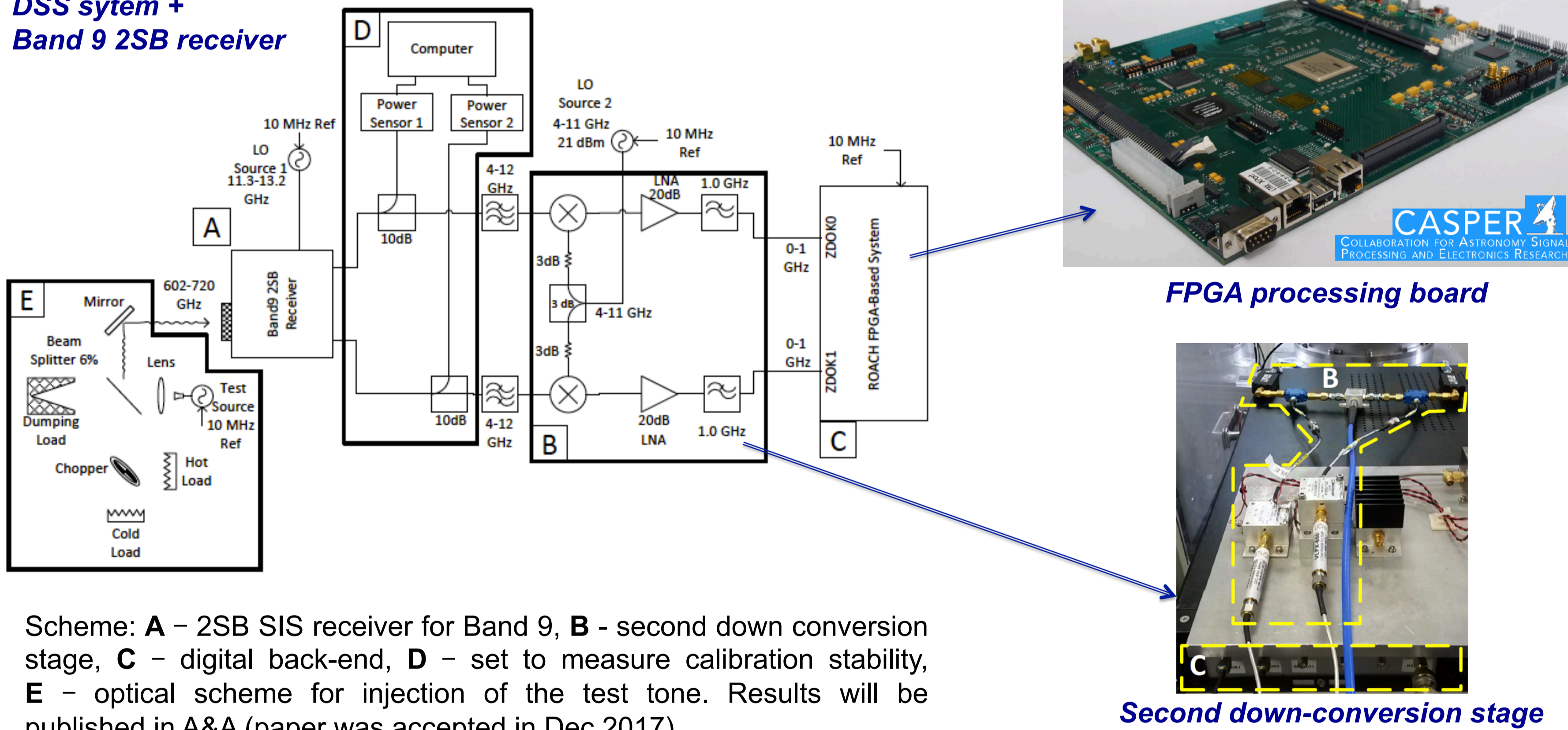

Scheme: **A** – 2SB SIS receiver for Band 9, **B** – second down conversion stage, **C** – digital back-end, **D** – set to measure calibration stability, **E** – optical scheme for injection of the test tone. Results will be published in A&A (paper was accepted in Dec 2017).

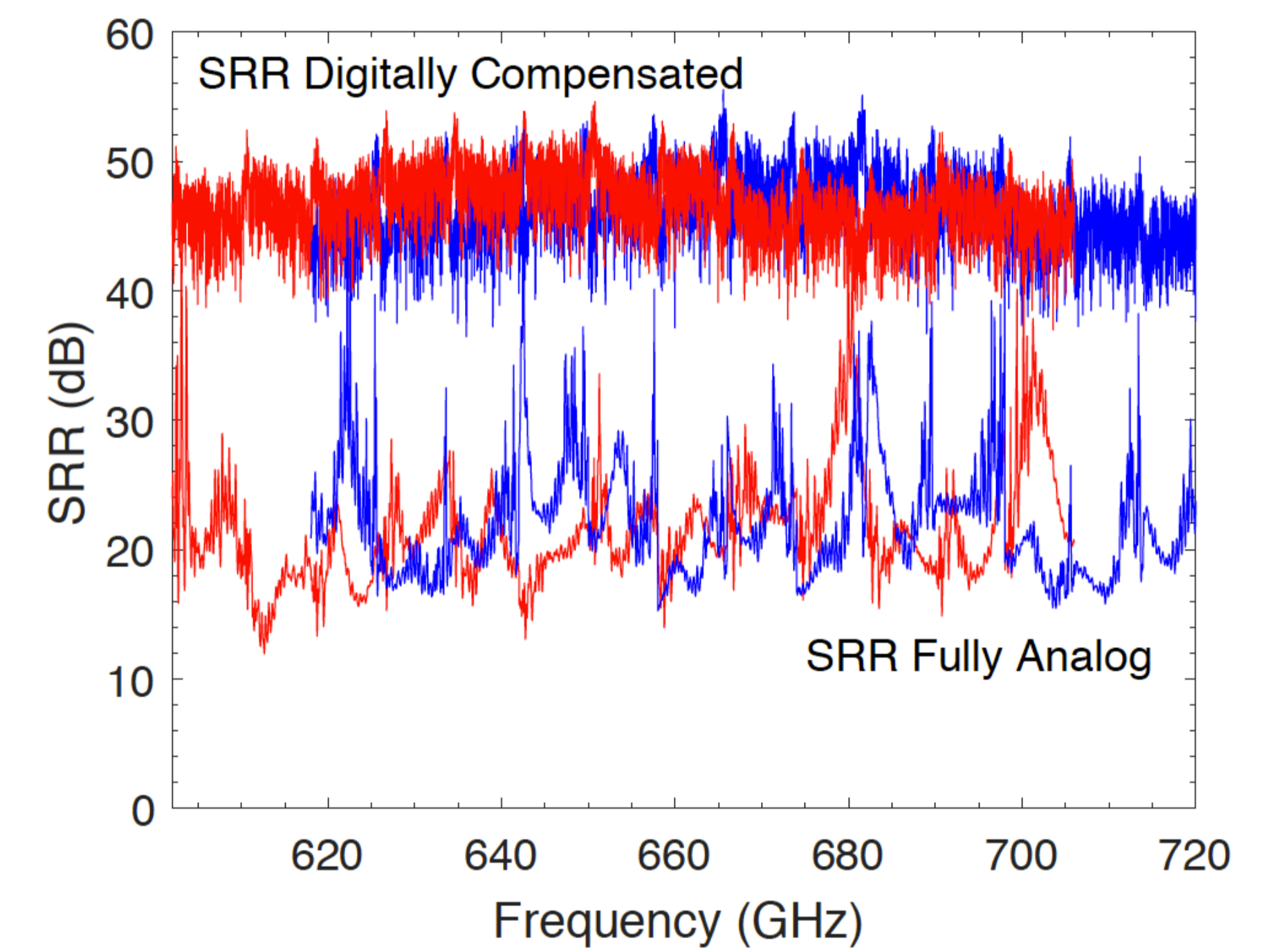

The digitally compensated IRR is above 40 dB. Digital Polarization Synthesis using similar approach has been demonstrated [].

Width of calibration channel to reach certain IRR level

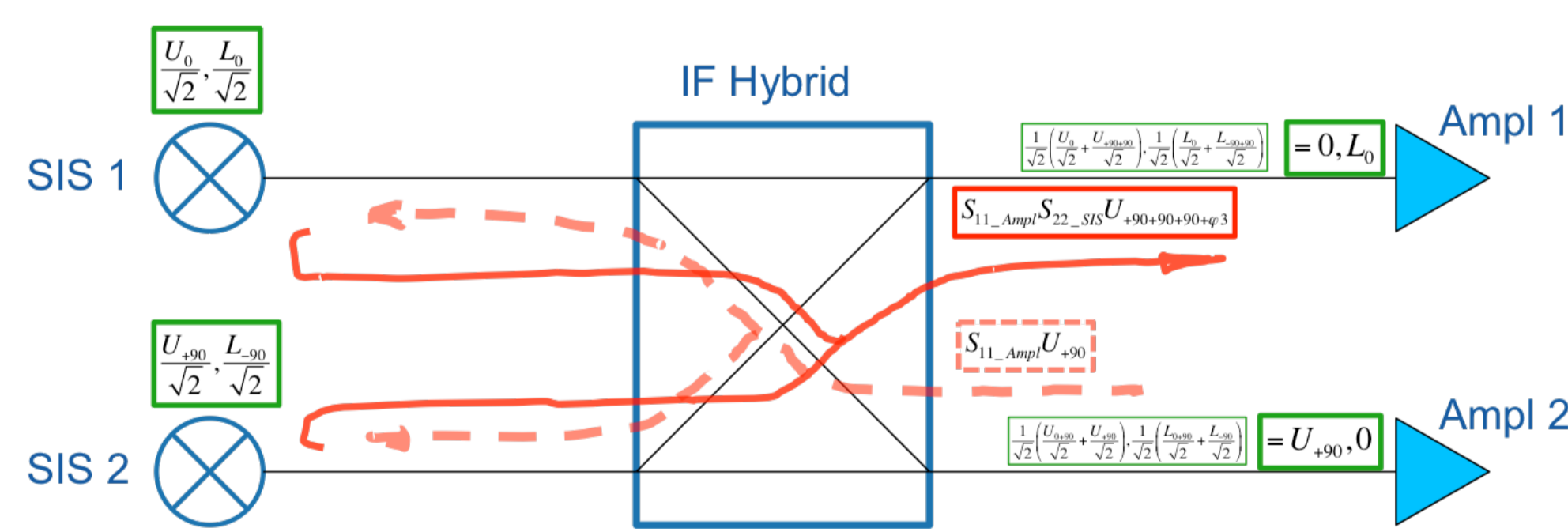

Mechanism of the main contribution to imbalance: Reflection from Amplifiers and SIS mixers through the Hybrid {Amplifier ↔ SIS}: Imbalance amplitude $S_{22,SIS} \cdot S_{H,ISO} = (-5dB) + (-10...-20dB) = -15...-25dB$, periodic – determined by the cable length between SIS and amplifier (isolator).

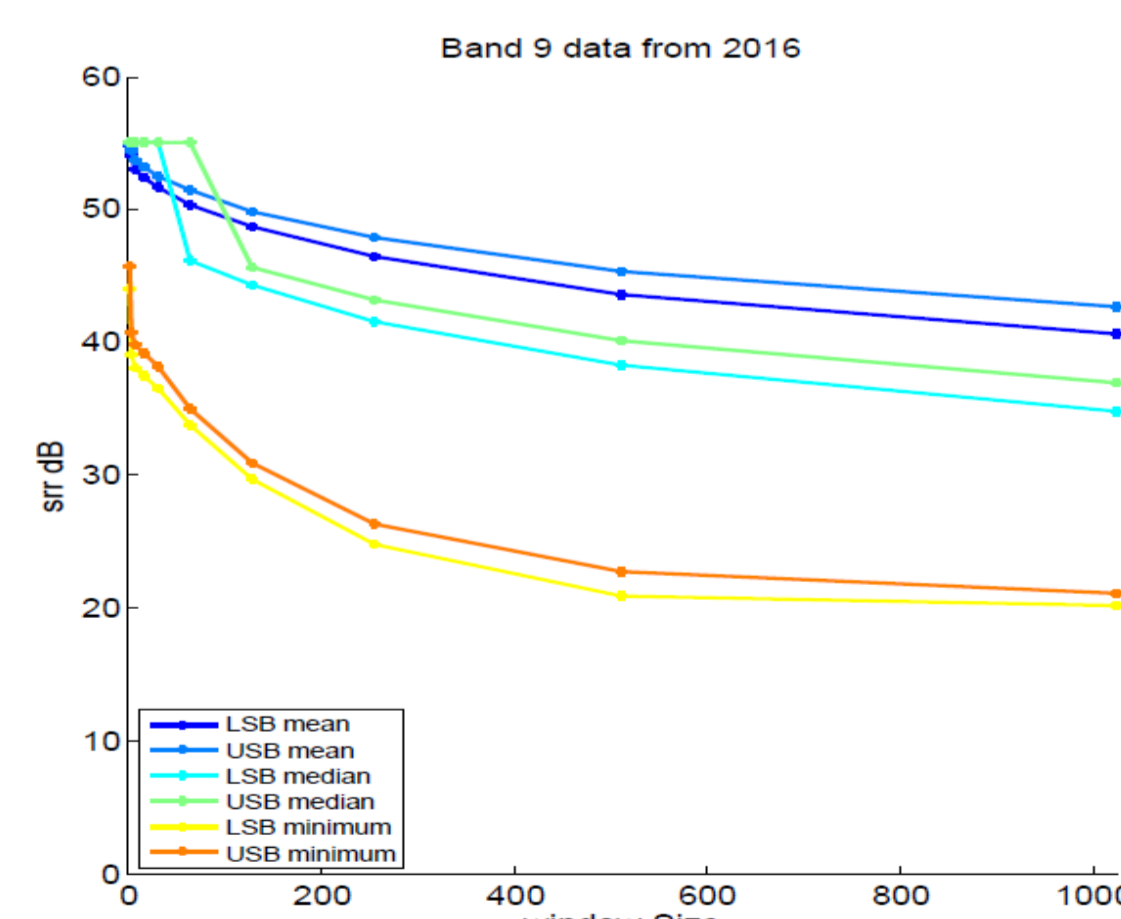

Analysis of measured data: calibration channel can be 244kHz x 64 = 15.6 MHz

Advantage compared to receiver without the IF hybrid

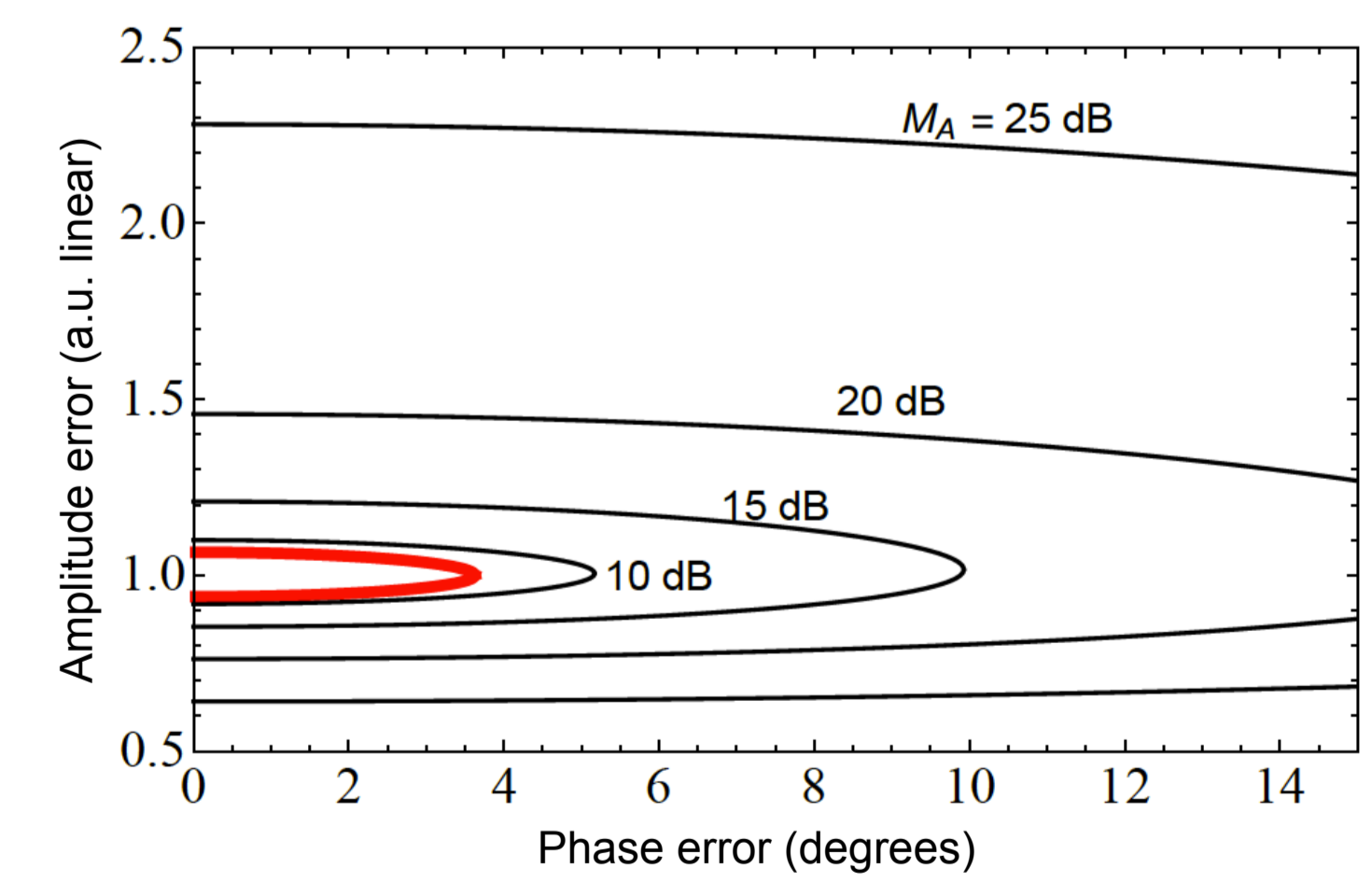

Error zones, providing 30 dB IRR level: red line - system without IF hybrid, black lines - full 2SB receiver with different level of analogue IRR. Error is injected between the receiver and the FPGA board.

IRR level	Band 3	Band 4	Band 5	Band 6 (???)	Band 7	Band 8	Band 9 no Isolators	Band 9 with Isolators
Cable length (mm)	200	350	100	200	200(?)	250	400	300
Reflection period (MHz)	500	285	1000	500	500(?)	400	250	330
SIS mixer S22 (dB)	5(?)	5(?)	5(?)	15(?) - amplifier 1	5(?)	5(?)	5(?)	5(?)
S11 of Isolator (or amplifier) (dB)	18	19	19	18	18	19	10	18
dF for IRR of 30 dB (MHz)	33	23	80	33	33	32	7	22
dF for IRR of 20 dB (MHz)	110	77	270	110	110	108	23	73

Estimation of IF reflections for currently installed ALMA bands (B3-B8) and the corresponding possible calibration channel width. DSS system with 46MHz calibration channel width will guarantee 30dB IRR level for all the bands.

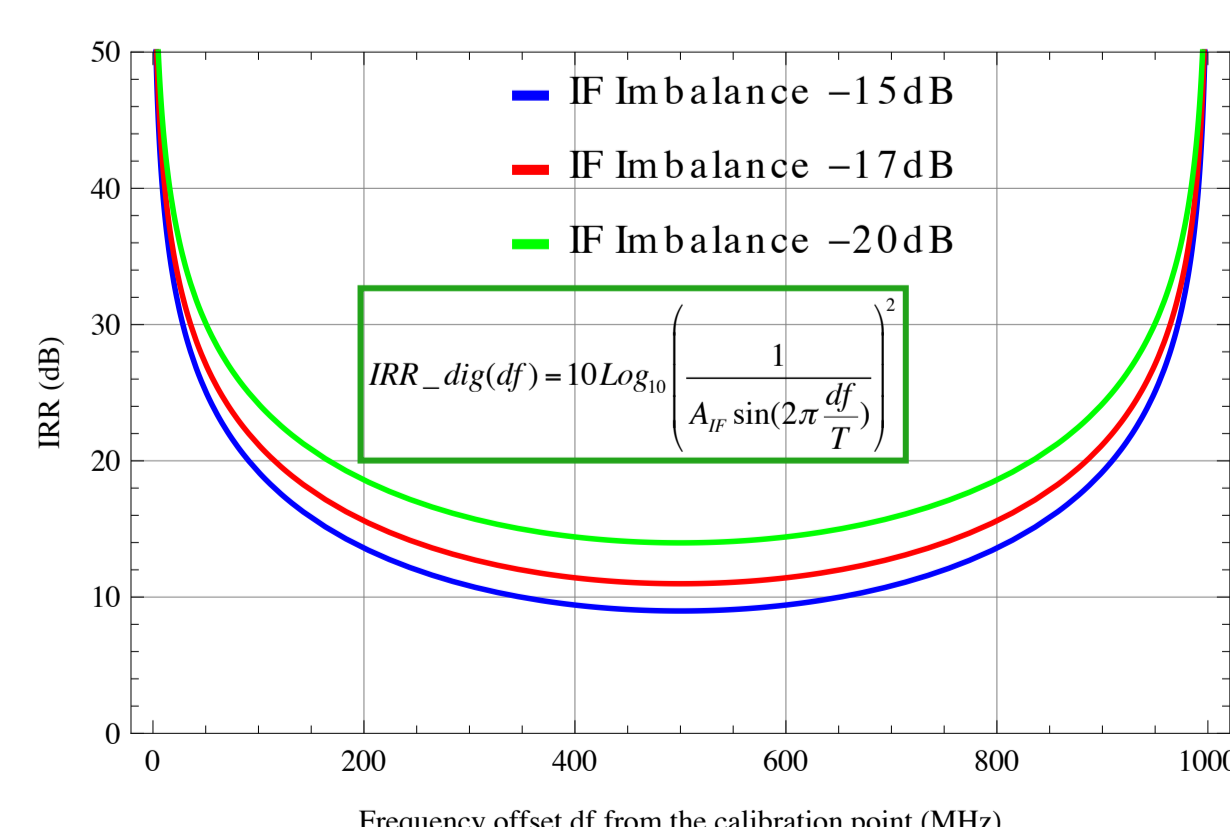

Degradation of the analogue IRR level vs. offset frequency from the calibration point df . Here the period of IF reflections is taken 1000MHz.

SUMMARY

- Digital Sideband Separating can strongly relax requirements for analog components of 2SB SIS receivers, providing at the same time the sideband rejection up to 40dB.
- Calibration stability proved stable on 24 hours and 9 mixer reset cycles (deflux, demagnetisation)
- The channel width of 46 MHz guarantees IRR above 30dB current ALMA receivers.