

University of Groningen

## Google Search and the Law on Dominance in the EU

Herz, Martin

**IMPORTANT NOTE: You are advised to consult the publisher's version (publisher's PDF) if you wish to cite from it. Please check the document version below.**

*Document Version*

Publisher's PDF, also known as Version of record

*Publication date:*

2014

[Link to publication in University of Groningen/UMCG research database](#)

*Citation for published version (APA):*

Herz, M. (2014). *Google Search and the Law on Dominance in the EU: An Assessment of the Compatibility of Current Methodology with Multi-Sided Platforms in Online Search*. SSRN. [http://papers.ssrn.com/sol3/papers.cfm?abstract\\_id=2497932](http://papers.ssrn.com/sol3/papers.cfm?abstract_id=2497932)

### Copyright

Other than for strictly personal use, it is not permitted to download or to forward/distribute the text or part of it without the consent of the author(s) and/or copyright holder(s), unless the work is under an open content license (like Creative Commons).

The publication may also be distributed here under the terms of Article 25fa of the Dutch Copyright Act, indicated by the "Taverne" license. More information can be found on the University of Groningen website: <https://www.rug.nl/library/open-access/self-archiving-pure/taverne-amendment>.

### Take-down policy

If you believe that this document breaches copyright please contact us providing details, and we will remove access to the work immediately and investigate your claim.

*Downloaded from the University of Groningen/UMCG research database (Pure): <http://www.rug.nl/research/portal>. For technical reasons the number of authors shown on this cover page is limited to 10 maximum.*

# GOOGLE SEARCH AND THE LAW ON DOMINANCE IN THE EU.

## AN ASSESSMENT OF THE COMPATIBILITY OF CURRENT METHODOLOGY WITH MULTI-SIDED PLATFORMS IN ONLINE SEARCH

Martin Herz.<sup>1</sup>

### Abstract

Business platforms that utilise, or are based upon, internet technology are omnipresent in consumers daily lives. Since the dawn of the World Wide Web, the amount of web content has increased greatly. Simultaneously, business interests have sparked, meeting the arisen demand for particular online services. As a consequence, economists have defined a novel market in these sectors, namely that of multi-sided platform markets. To an important extent, these markets experience network effects, which can strengthen a platform operator's position in relation to competitors. In turn, competition authorities have witnessed various dominant undertakings emerging. The focus of this article is on one particular internet sector, to wit, that of World Wide Web Search, and on one firm in particular, Google Incorporated. It critically analyses how the Google Search algorithms are shaped from a technological perspective, how these are or can be categorised in accordance with the economic theory of multi-sided platform markets, and how these perform under current dominance law analysis in the European Union, more specifically Art. 102 TFEU. To that end, it will also take into account the recent Google Commitments procedure by the European Commission.

### Keywords

INTERNET SEARCH; DOMINANCE; ARTICLE 102 TFEU; MULTI-SIDED PLATFORM MARKETS; NETWORK EFFECTS; COMMITMENTS.

## I. Introduction

The gap between quickly developing technology, economic theories and the legal frameworks regulating both phenomena seems to be wider than ever. It is an issue that technology nowadays takes such leaps forwards, that competition rules and methodologies appear to be incapable of regulating the business practices surrounding it. Whereas recent economic theories envelop the markets on which these technologies are employed, competition law authorities, however, still seem to struggle with them. A prominent example can be found in the field of search engine technology, and more specifically with the Google Search algorithms. As this article demonstrates, the law on dominance in EU competition law is currently insufficiently equipped for dealing with this fast-paced field of business life.

Google Incorporated has become one of the most popular brands of today over the last 15 years.<sup>2</sup> What is more, its search services are the most well-known as regards online search technology. Nevertheless, by cause of the recent commitments procedure, it appears to have been brought to its knees by various competition law agencies across the world. As such, Google Incorporated and its

---

<sup>1</sup> Lecturer of Economic and European Law at the University of Groningen, Netherlands. This article is an abridged and updated version of the author's homonymic LL.M. Thesis. It forms part of the research programme Protecting European Citizens and Market Participants of the Groningen Centre for Law and Governance. The author owes his deep gratitude to his research and thesis supervisor, prof. dr. Hans Vedder, for his patience in reading, his insightful comments and inspiring discussions.

<sup>2</sup> Hereafter, Google Incorporated will be described either as "Google", as "Google Inc.", as "the company", or as "the firm".

Google Search engine will be scrutinized from a technological, economic and legal perspective, so as to provide for a comprehensive insight in this triad of fields.

In this endeavour, this article explores and utilizes various resources in order to gain a proper understanding of this field of technology. Aside of the literature itself, several graphical representations of the scope of the internet are incorporated, as well as tables and diagrams, exemplifying the explained concepts. The data leading to these figures has been gathered from internet-based sources, economic or competition law related literature, or from the relevant company policy web pages.

## II. Google's Search Technology.

### II.1. A short history of the Internet.

Since the construction of the ARPANET,<sup>3</sup> and since the development of super- as well as personal computers, which has its basis in the 1950s, more and more computers, and people have become mutually connected, enabling intra-continental information sharing.<sup>4</sup> What started as the need for a decentralized network for nuclear weaponry, soon evolved into a demilitarized and fully privatized network of mutually communicating routers, networks and numerous other computing devices, receiving the name the Internet.<sup>5</sup> As the technology and the manner in which it developed showed potential, large investments were made that allowed more devices to connect, more data to be transferred from one place on the grid to the other, and enabled the possibility to privatize the entire grid from government control.

Consequently, in the early 1990s, in Switzerland, information-sharing software was developed, based on a code called HyperText Markup Language (HTML) and the Hyper Text Transfer Protocol (HTTP).<sup>6</sup> Again, even though initially not intended for widespread public use, the applicability of the software became immensely popular, which led to the emergence of the World Wide Web. Both developments resulted in a staggering increase in the number of servers, as well as the amount of web content in the form of web sites and pages. See the graphs in diagrams 1 and 2, in which this increase is displayed.<sup>7</sup>

---

<sup>3</sup> J. Ryan, *A History of the Internet and the Digital Future*, London, Reaktion Books Ltd. 2010, p. 11 ff; W. Stuart, "Internet History - One Page Summary", latest update on 29 April 2009, available online at <livinginternet.com/i/ii\_summary.htm> (accessed 18 September 2014).

<sup>4</sup> Encyclopædia Britannica, entry on "the Internet", last modified on 15 June 2013, p.1, available online at <britannica.com/EBchecked/topic/291494/Internet> (accessed 18 September 2014).

<sup>5</sup> Federal Networking Council, "FNC Resolution: Definition of 'Internet'", *US NITR Development Program website*, 24 October 1995, <nitr.gov/fnc/Internet\_res.aspx> (accessed 18 September 2014)

<sup>6</sup> T. Berners-Lee, *Weaving the Web. The original Design and Ultimate Destiny of the World Wide Web*, New York, Harper Business 2000, p. 59-60.

<sup>7</sup> Data was derived from Netcraft's Web Server Survey, available online at <news.netcraft.com/archives/category/web-server-survey>, The Internet Systems Consortium's Domain Survey Host Count, available online at <isc.org/services/survey>, and R.H. Zakon, "Hobbes Internet timeline", available online at <zakon.org/robert/internet/timeline> (all accessed 18 February 2014).

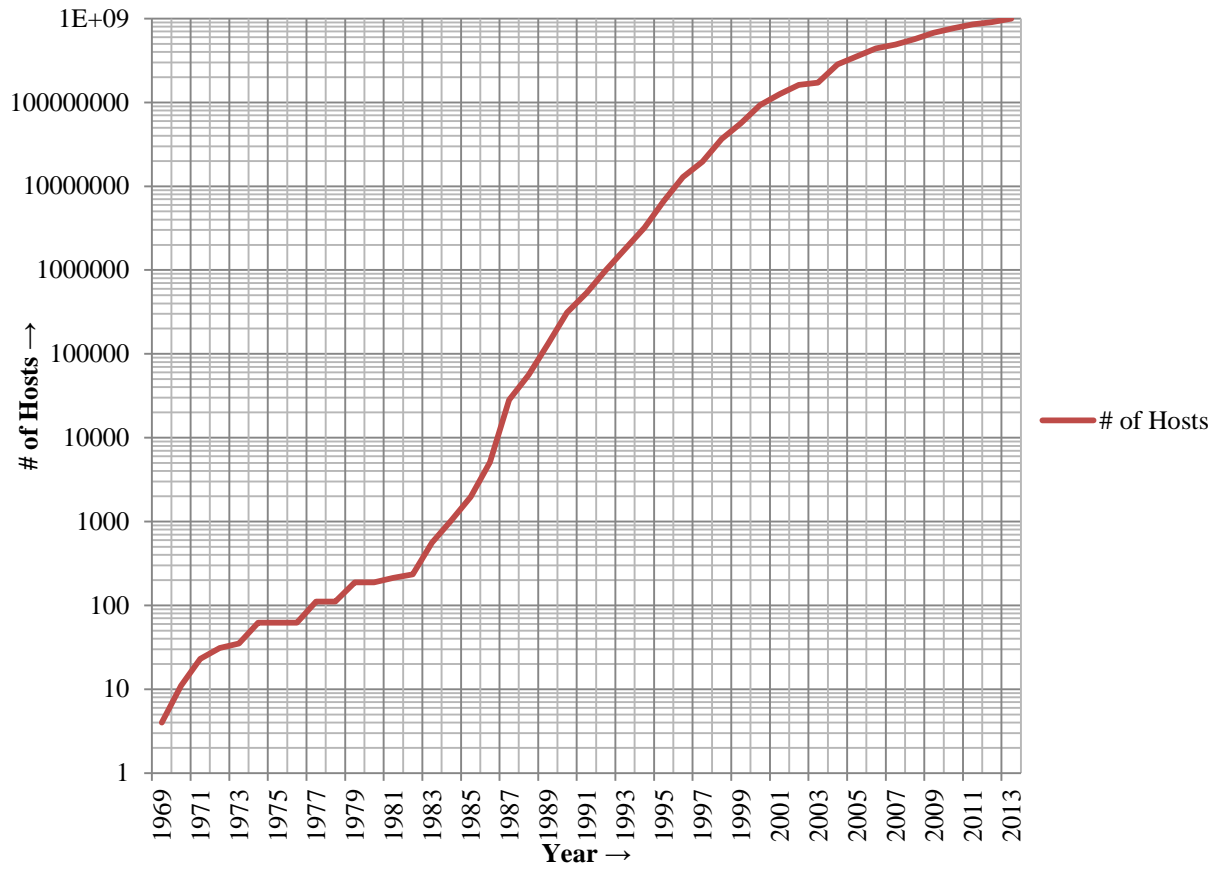

Diagram 1. Number of Hosts since the Dawn of the Internet

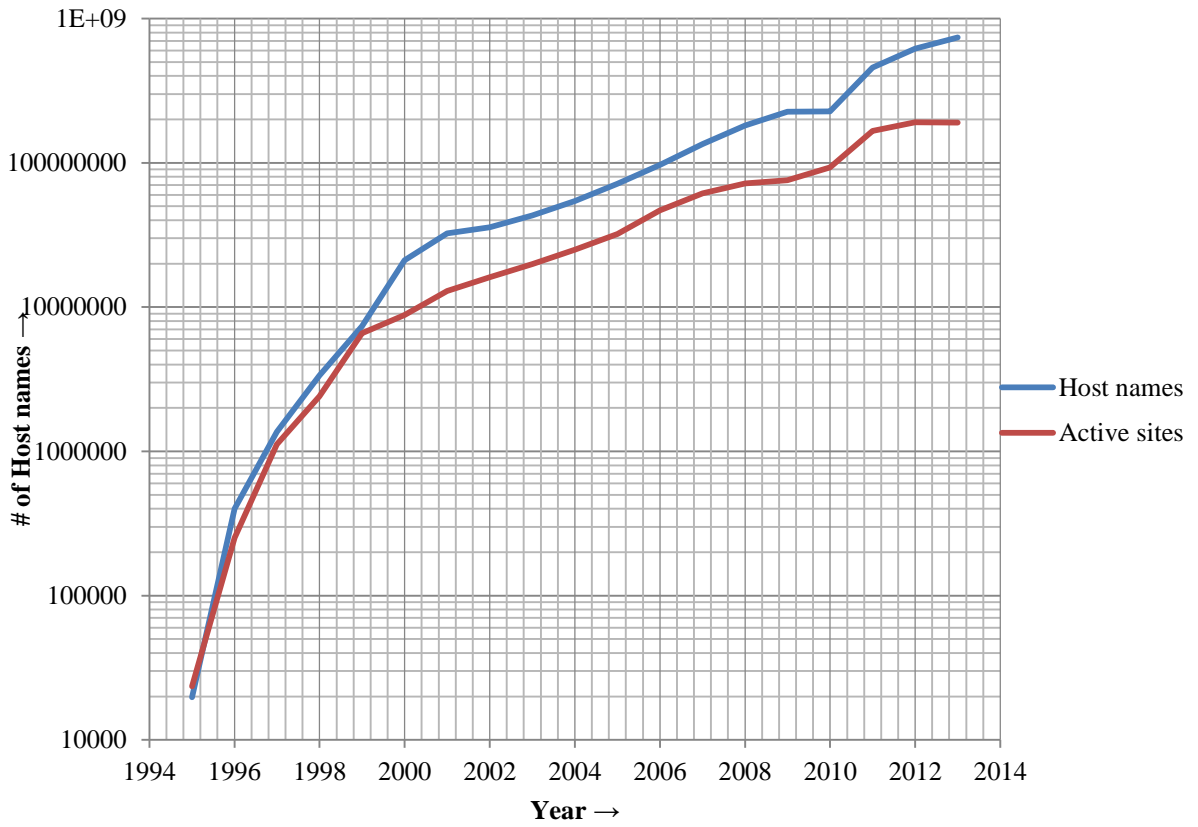

Diagram 2. Number of Host Names and Active Sites

Regarding this immense growth of information on the WWW and of the number of physical internet connections, it is evident that demand also rose for ancillary services such as the indexing and organization of this content. Ergo, shortly after its creation, the World Wide Web became the cradle of indexing and search service providers. Of these, Google Inc. was not the first; various indexing services existed before Google jumped on the bandwagon in 1998-'99.<sup>8</sup>

Original search engines assigned importance to pages on the basis of the entered query. The more often (parts of) a query would coincide with words on a webpage, the more important that page was regarded, and the more likely it would become the first hit. Whereas over the last 15 years, Google's service has evolved, in its prime years it mainly revolved around a search indexing algorithm that substantially different from existing engines.<sup>9</sup> Page & Brin's invention namely employed a different approach to assigning importance.<sup>10</sup> The patent of 2001 stipulates it as follows:

*"A method assigns importance ranks to nodes in a linked database, such as any database of documents containing citations, the World Wide Web or any other hypermedia database. The rank assigned to a document is calculated from the ranks of documents citing it. In addition, the rank of a document is calculated from a constant representing the probability that a browser through the database will randomly jump to the document. The method is particularly useful in enhancing the performance of search engine results for hypermedia databases, such as the World Wide Web, whose documents have a large variation in quality."*<sup>11</sup>

## II.2. Crawling, indexing, categorising and ranking.

The services generally consist of *crawlers* or *spiderbots*, which are pieces of software programmed to scour a predetermined set of webpages for hyperlinks to other webpages, which are scanned for new hyperlinks. Two types exist, *horizontal* or general crawling, and *vertical* or specified crawling, such as only websites relating to sports, to news, or to books. Later in the process, separate search services can be distinguished, therefore defined as horizontal and vertical search services respectively.<sup>12</sup> After having collected the strings of hyperlinks, the crawling software will report back to the main server.

Consecutively, the strings of links are stocked in indexing servers. Also, the crawled info is stored and indexed in a cache server, distributed amongst several categories. Different categories are re-crawled in a different fashion and rate; the prime example for this is an online news service with regular content updates, compared to for instance something more permanent, such as company policy web pages.<sup>13</sup>

---

<sup>8</sup> T. Seymour, D. Frantsvog & S. Kumar, "History Of Search Engines", *International Journal of Management & Information Systems*, vol. 15, ed. 4, 2011.

<sup>9</sup> An algorithm is a concept in computing science that entails a formula or set of rules to mathematically solve equations or other issues. In search, such algorithms are effectuated in order to find the most relevant item amongst a large number of items.

<sup>10</sup> E.g. K.L. Devine, "Preserving Competition: in Multi-Sided Innovative Markets: How do You Solve a Problem like Google?", *N.C.J.L. & Tech.*, vol. 10, ed. 1, pp 59-118, p. 66. Organic search results are also referred to as editorial or algorithmic search results, J. Battelle, *The Search. How Google and Its Rivals Rewrote the Rules of Business and Transformed Our Culture*, London, Nicholas Breakley Publishing, 2005, p. 117.

<sup>11</sup> L. Page, "Method for node ranking in a linked database", Patent nr. 6,285,999, filed on 9 January 1998, awarded on 4 September 2001, available online at <patft.uspto.gov/netacgi/nph-Parser?Sect1=PTO1&Sect2=HITOFF&d=PALL&p=1&u=%2Fnethtml%2FPTO%2Fsrchnum.htm&r=1&f=G&l=50&s1=6285999.PN.&OS=PN/6285999&RS=PN/6285999> (accessed 18 September 2014). PageRank is an algorithm, a formula or process that allows to solve various issues, be they mathematical, purely hypothetical or actual.

<sup>12</sup> See further, *infra*, par. IV.3.4.6.

<sup>13</sup> Allegedly, it was due to 11 September 2001, when searchers could not find anything on the terrorist attacks, because Google had indexed the particular web pages quite some time before that; see Google, "The Evolution of Search", *Youtube* video, 27 November 2011, available online at <youtu.be/mTBShtwCnD4> (accessed 18 September 2014).

The patented PageRank algorithm accomplishes its task in the process that follows, which is the ordering and ranking of search results, after a search term, or *query*, has been entered into the engine.<sup>14</sup> Still, even though Google Search originally distinguished itself by this patented piece of technology, the PageRank algorithm is but one of the over 200 algorithms and factors to produce the most germane and appropriate outcomes to a query on Google Search.<sup>15</sup>

Hence, in short, Google indexes and caches the Web, and ranks its results. However, in the search engine, other relevant algorithms are employed to personalize search results. First, *browser cookies* are used for documenting preferences, such as blocking adult content or the display language, but also for assessing on which search results individual searchers actually clicked.<sup>16</sup> Consequently, cookies mirror or portray the searching behaviour of browsing individuals. And for Google, that is relevant, as cookies provide for preferred search options and for the possibility of pinpointing relevant advertising to customers; in short, they optimise the browsing experience.

Secondly, *server logs* of every entered query are made, which also gather information on the utilized browser, on the requesting IP address, and on the cookies connected to the query.<sup>17</sup> Considering that the IP address acts largely as a street address, due to its geographical distribution, every query can be assigned to a geographic location or region. Hence, aggregated data concerning the server logs can identify what was searched by which IP addresses.<sup>18</sup> Furthermore, by means of the click-through-rate, it can easily be verified which queries deliver the most clicks on ads.<sup>19</sup>

Thirdly, by logging in to a specific Google account, it allows the firm to aggregate more personal searching data of users and generate search results on the basis of that.<sup>20</sup> For all the accounts of other “Google” products, the company recently unified all its privacy policies, resulting in one database for all services in which all queries and other personalizing information is stored and utilized for providing for a personalized browsing experience.<sup>21</sup>

---

<sup>14</sup> S. Brin & L. Page, “The Anatomy of a Large-scale Hypertextual Web Search Engine”, *Computer Networks and ISDN Systems*, vol. 30, 1998, 107-117, p. 109-110.

<sup>15</sup> Google’s Inside Search, “How Search Works. From Algorithms to Answers”, available online at <[google.com/intl/en/insidesearch/howsearchworks/thestory](http://google.com/intl/en/insidesearch/howsearchworks/thestory)> (accessed 18 September 2014)

<sup>16</sup> Browser cookies are small text files which are placed by the server on the individual’s computer or browser folder, containing a string of characters that allows the website to recognise the browsing software when it enters the website. Depending on the type, different information is transferred. See for a list of the cookies that Google uses Google Inc., “Types of cookies used by Google”, available online at <[google.com/policies/technologies/types/](http://google.com/policies/technologies/types/)> (accessed 18 September 2014).

<sup>17</sup> IP can be seen as the street address on the internet. Every routing device is assigned a specific IP address. As these are managed and distributed on a global scale, the IP address of every router is uniquely discernible. Moreover, large, so-called “blocks” of IP are distributed and redistributed geographically, enabling location by IP. For more information, see e.g. RIPE NCC Database, “Understanding IP Addressing”, available online at <[www.ripe.net/internet-coordination/press-centre/understanding-ip-addressing](http://www.ripe.net/internet-coordination/press-centre/understanding-ip-addressing)> (accessed 18 September 2014).

<sup>18</sup> K. Owen, “The power of where: using IP geolocation to create instant local connections online”, *Econsultancy.com*, 25 September 2012, available online at <[econsultancy.com/nl/blog/10761-the-power-of-where-using-ip-geolocation-to-create-instant-local-connections-online](http://econsultancy.com/nl/blog/10761-the-power-of-where-using-ip-geolocation-to-create-instant-local-connections-online)> (accessed 18 September 2014).

<sup>19</sup> The click through rate or CTR is the ratio between the number of clicks on and the number of impressions/displays of the advertisement. A high click ratio on a specific ad will mean that more clicks are delivered compared to a relatively small number of displays.

<sup>20</sup> Furthermore, Google offers a “suite of Google applications”, such as Google Calendar, Mail, Drive and Docs, to be provided on the domain of an enterprise or institution, see G. Phelan, “10 top Dutch universities adopt Google Apps for Education”, *Google Enterprise* blog entry, 15 June 2012, available online at <[googleenterprise.blogspot.nl/2012/06/10-top-dutch-universities-adopt-google.html](http://googleenterprise.blogspot.nl/2012/06/10-top-dutch-universities-adopt-google.html)> (accessed 18 September 2014).

<sup>21</sup> See also R. Livne, “Just ask Google for your flights, reservations, package delivery info and more”, 14 August 2013, *Google Blog* entry, available online at <[googleblog.blogspot.ca/2013/08/just-ask-google-for-your-flights.html](http://googleblog.blogspot.ca/2013/08/just-ask-google-for-your-flights.html)> (accessed 18 September 2014).

## II.3. Revenues

As established above, any consumer with a computer and an internet connection is able to browse to Google's search engine website, and to search through the enormous index of pages and other web content, thus benefiting from Google's service, without having to pay.<sup>22</sup> The question then is how Google generates revenue from these services. The central word in this sense, is advertising, most notably in the form of two advertising services, *Adwords* and *AdSense*.

In the primitive years after having been launched as search engine, in October 2000, Google introduced its advertising service, Adwords.<sup>23</sup> It came in two strands: on the one hand, vacant advertisements at the top of the page could be bought for a fixed price per impression (displays of the ad) set by Google, called *Adwords Premium*; on the other hand, advertisements next to the search results could be bought through a generalised second-price auctioned system, known as *Adwords Select*.<sup>24</sup> The latter was based not on costs per impression, but on costs-per-click, or CPC, by customers. Fundamental to either service is that advertisers bid on vacant slots visible near the results for specific or broader queries. Moreover, nowadays, the AdWords mechanism is mainly focused on the ad setting through auctions. The intricacies of this mechanism will be covered in the following chapter.<sup>25</sup>

Auctions are run as soon as a query is entered, and all ad slots near results are filled instantaneously; furthermore, a ranking algorithm, based on the bid as well as the quality of the ad, determines the location of the advertisement. Google advertises this system as being the perfect medium for both SME's and larger corporations to advertise on Google, as in this way larger corporations can focus on broader search terms and smaller enterprises will choose for more specialised search terms, fit to their niche products or services.<sup>26</sup> Also, because of a multitude of factors, auctions between competitors differ: e.g. the query entered, the selected words to which a competitor would like its ads to be displayed, the relevance or quality of the ad to the query entered (determined by Google's algorithms), the height of the bids, or the number of competitors at that moment make the ad market quite competitive.

The other large advertising service that Google is dependent on is based on websites that are associated with Google, and is called AdSense. It operates by placing relevant Google advertisements on websites administrated by third parties. Any private person having a website can reserve special portions of the website for Google's advertising purposes. For third parties, this also has a financial benefit: for every X number of advertisements displayed or clicked, the proprietor of the site gathers revenue from Google.<sup>27</sup> The administrator can choose the search terms with which it

---

<sup>22</sup> The economic and legal consequences of this will be covered in the following chapters.

<sup>23</sup> K. Vogel & C. McCaffrey, "Google Launches Self-Service Advertising Program", Googlepress Blogspot entry, 23 October 2000, available online at <googlepress.blogspot.nl/2000/10/google-launches-self-service.html> (accessed 18 September 2014). See also S. Levy, "Secret of Googlenomics: Data-Fueled Recipe Brews Profitability", *Wired Magazine*, 22 May 2009, available online at <wired.com/culture/culturereviews/magazine/17-06/nep\_googlenomics?currentPage=all> (accessed 18 September 2014).

<sup>24</sup> S. Levy, *In the Plex. How Google thinks, works, and shapes our lives*, New York, Simon and Schuster, 2011, p. 89 & 109.

<sup>25</sup> More specifically, in III.3.5.

<sup>26</sup> And it has ostensibly been very profitable, see the financial data on <investor.google.com/financial/tables.html> and <investor.google.com/earnings/2013/Q2\_google\_earnings.html> (accessed 18 September 2014).

<sup>27</sup> See also H.R. Varian, "Online Ad Auctions", *American Economic Review: Papers & Proceedings* 2009, 99:2, 430–434. In this article research, multiple references are made to the work of Varian; nevertheless, for all clarity, it should be revealed that from 2002, he has been employed by Google as the Chief Economist, see, e.g., Google Ventures, "Hal Varian. Advisor to Google Ventures", profile entry, available online at <googleventures.com/team/hal-varian> (accessed 18 September 2014).

associates the content the most; consequently, as is the same as with Adwords, after auctions are run, only the most relevant advertisements will be displayed on the pages.<sup>28</sup>

What is evident from these explanations is that Google regards one factor in this process of pivotal importance, namely the consumer of search engine services. In order for the corporation to thrive, its business model depends heavily on a larger audience to whom advertising can be targeted. Hence, the more users are routed through Google's search services, the more attractive it becomes for advertisers to place their advertisements on Google.<sup>29</sup> Moreover, the employed algorithms for Search and methods for advertising could have consequences for the dominance analysis in EU competition law.<sup>30</sup>

---

<sup>28</sup> H.R. Varian, Google, "Google Adwords Bidding Tutorial", *Youtube* video, 15 September 2009, available online at <[youtu.be/jRx7AMb6rZ0](https://youtu.be/jRx7AMb6rZ0)> (accessed 18 September 2014).

<sup>29</sup> More on this, *infra*, Chapter III.

<sup>30</sup> More on that, *infra*, Chapter IV.



### III. The Qualification of Google as Multi-Sided Platform

#### III.1. Introduction

Evidently, Google Inc. exploits a profitable business with its search engine algorithms. Outside of the technological workings of the algorithm, it therefore attracts the question how Search operates from an economic perspective. As will be shown, the search engine market operates along the lines of a fairly novel type of market, namely that of the *multi-sided platform market*.

Whereas the more “traditional” markets consist of multiple actors for supply and demand who meet each other on a market and thereby establish a price, in the more “novel” markets such a direct link is more diffuse.<sup>31</sup> Vast technological progress over the last decades, apart from bringing forth new products and services to the consumer public, has also had its impact on the concept of market definitions in economics.<sup>32</sup>

The above can be exemplified by the fierce competition between the Microsoft Disk Operating System and the Apple Macintosh or Apple Operating System a 20-odd years ago.<sup>33</sup> As a customer, the decision for either OS (irrespective of underlying computer hardware) would inevitably be based on the prices of both OS’s and the distinct qualities of the products; however, it would also depend on which of the customer’s friends and family members. For instance, compatibility issues could occur when transferring documents. Also, the possibility to share experiences with the system would be made easier when someone in the vicinity uses the same product. As a consequence, distinct ‘networks’ for the OS emerged, consisting of users bases that only opted for that particular product. Independent software developers would, then, find it important to reach the largest customer base possible; the larger the customer group, the more profitable it would be to invest in developing software for that particular OS. Consequently, OS’s have formed distinct market of themselves.

#### III.2. Multi-sided Platform Markets

These novel markets have sparked considerable academic debate over the recent years, in particular concerning two-sided or *multi-sided platform (MSP) markets*.<sup>34</sup> For instance, computer and software development is not the only industry: gaming consoles and game development, music streaming services, internet portals, and search engines are all markets that have apparently different economic characteristics compared to regular economic scrutiny.

As a consequence, the widespread emergence of these and similar markets has brought discussion on the emerging multi-sided theories. As of yet, academics have not come to clear understanding on the definition of and the precise conditions for this concept.<sup>35</sup> This article, therefore, adopts the following definition of a multi-sided platform, thereby also attempting to reconcile any existing controversies: a medium through which actors can *internalise externalities*, which gives rise to *network effects* and where the operator displays *bilateral market power*. After succinct explanation of the relevant components, this definition will be applied to Google Search.

---

<sup>31</sup> The example here would be a supermarket, buying its goods for a certain price and selling it to whoever enters the shop. Mutual competition among shops exert a negative pressure on the price to the consumer.

<sup>32</sup> Hereinafter, individual searchers of search engine platforms, and of Google in particular, are called “consumers”. Even though advertisers essentially are consumers of the Google Search platform as well, they are distinguished from the searching audience and solely depicted as “advertisers”.

<sup>33</sup> S.J. Liebowitz & S.E. Margolis, “Network Externality: An Uncommon Tragedy”, *Journal of Economic Perspectives*, vol. 8, nr. 2, Spring 1994, 133-150, p. 133.

<sup>34</sup> Introduced by D.S. Evans, “Multi-sided platform markets”, *Yale Journal on regulation*, vol. 20, 2003, 326-381.

<sup>35</sup> A. Hagiu & J. Wright, “Multi-Sided Platforms”, *Working Paper 12-024* of 12 October 2011 for Harvard Business School, available online at <[hbswk.hbs.edu/workingpapers/](http://hbswk.hbs.edu/workingpapers/)> (accessed 18 September 2014).

### III.2.1. Medium

The most logical and undisputed, potentially even overlooked, first aspect of an MSP, is the medium on or through which market (trans)actions run.<sup>36</sup> Whether the medium in question is an auctioning mechanism, on- or offline, an OS, a piece of hardware computer equipment, a newspaper, or a credit card, all (trans)actions should run via or on that medium, which can therefore be defined as the *platform*.<sup>37</sup>

### III.2.2. Internalizing externalities

Secondly, MSP markets emerge in order to *internalize* an externality that arises between various parties. This entails an enablement for one to communicate with, contract with, or contact an other, which would have been much more difficult, had the particular medium not existed.<sup>38</sup> Credit cards, for example, encompass ways of direct and reliable payment to merchants without the need for cash or a positive bank balance, and they give a lenient method of payment for customers, as they only pay the bill at the end of the month. From this also follows that separate services are provided to separate types of customers: for instance, calling and receiving calls, paying and receiving payment, or easily meeting single men and meeting single women, the services are distinct.

### III.2.3. Network effects

The third criterion, in particular, considers the existence or necessity of *indirect network externalities*. This concept demands more explanation, as it has delivered significant debate amongst scholars as well. Whereas *externalities* are the effects of production or consumption that are not accounted for in the cost price, *network externalities* concern the incremental increase of the benefit or disadvantage of increased production or consumption.<sup>39</sup> The figure below exemplifies this by ways of a simplified network.

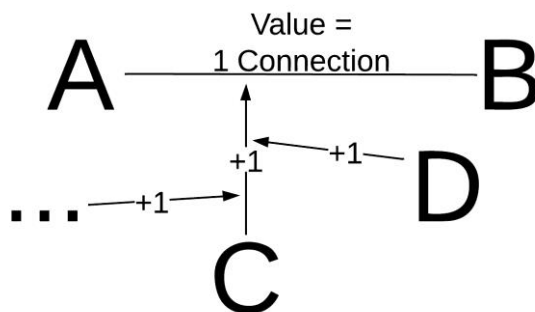

Diagram 3. Network Effects Exemplified

<sup>36</sup> A factor acknowledged by E.G. Weyl, "A Price Theory of Multi-Sided Platforms", *American Economic Review*, vol. 100, September 2010, p. 1644

<sup>37</sup> This condition, however, does not stand independently, because a platform for buyers and sellers to meet each other already exists. Nevertheless, it is for the following conditions that these specific platforms emerge; it is also why in this passage, reference will be made to multi-sided platform markets or MSP's and not to the often read "two-sided market", preventing the pitfall of the often-used argument against the existence of multi-sided markets that "every market is two-sided", see Hagiu & Wright 2011, p. 2.

<sup>38</sup> *Ibidem*. Without the platform, transaction costs would be very high for either party to find the other.

<sup>39</sup> The most prominent example is a telephone network. When persons A and B connect via a telephone line, the derived benefit amounts to one available connection for both A and B. Person C, however, when connecting to this mutual connection, benefits more, namely with the possibility to connect to two persons, instead of to only one. Hence, the value of being connected to the telephone network increases incrementally with every new connection, as person D will benefit with three connections, E with four, *et cetera*.

This theory can be complicated further, as network effects exist in two flavours: *direct* and *indirect*. In the simplified example above, the utility derived from being connected to the network increases directly with additional connections, meaning these are *direct network effects*. Nevertheless, telephone networks consist of different service providers (who might offer them on separate networks),<sup>40</sup> of callers, and of receivers.<sup>41</sup> Another example is heterosexual dating clubs, where the number of men present is dependent on the number of women willing to join such clubs.<sup>42</sup> Hence, those effects depend on the availability or actions of one of the two sides and are, therefore, called *indirect network effects*.<sup>43</sup>

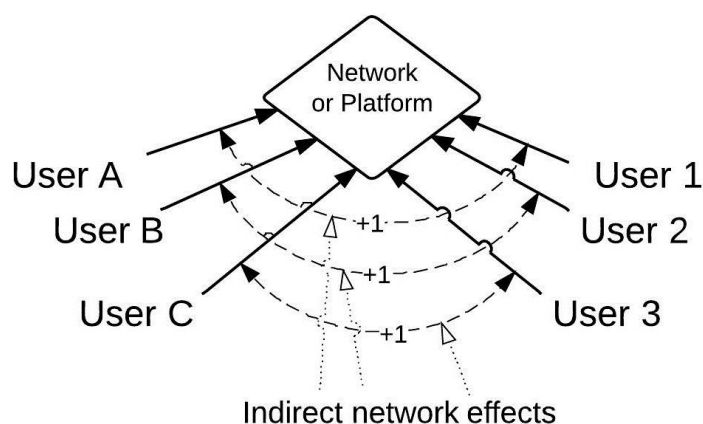

Diagram 4. Exemplification Of Indirect Network Effects

As established by Evans in one of the first articles discussing multi-sided platform markets, indirect network effects concern the establishing factor for MSP's.<sup>44</sup> In recent years, however, several authors have seemingly thought this demarcation to be inaccurate for defining MSP's.

Weyl, and Fleischer & Smith, amongst others, speak of cross network effects, and Weyl defines them as follows: “[u]sers’ benefits from participation depend on the extent of user participation on the other side of the market, which varies with market conditions”.<sup>45</sup> This might indicate that in order for the market to work, both sides have to be “on board”, meaning that the value for one side of the network or product used will increase as soon as participation on the other side increases.<sup>46</sup> It also implies that both sides value the participation of the other side equally.<sup>47</sup>

<sup>40</sup> T. Valletti, “Mobile Call Termination: A Tale of Two-Sided Markets”, *Communications and Strategies*, vol. 61, 2006, p. 61-77.

<sup>41</sup> Especially with regard to pricing schemes for receiving calls, the utility derived from the network by those connected may depend on the number of calls made and received; e.g. D. Jeon, J. Laffont & J. Tirole, “On the ‘Receiver-Pays’ Principle”, *The RAND Journal of Economics*, vol. 35, no. 1, Spring 2004, p. 85-110; more recently, Á.L. López, “Mobile termination rates and the receiver-pays regime”, *Information Economics and Policy*, vol. 23, is. 2, June 2011, p. 171–181;

<sup>42</sup> D.S. Evans, “Multi-sided platform markets”, *Yale Journal on regulation*, vol. 20, 2003, 326-381, p. 327 ff; in turn, derived from H.W. French, “Osaka Journal: Japanese Date Clubs take the Muss out of Mating”, *NY Times*, 13 February 2001, at A4.

<sup>43</sup> Also designated as *cross-group effects*, M. Armstrong, “Competition in two-sided markets”, *RAND Journal of Economics*, vol. 37, no. 3, Autumn 2006, p. 668–691.

<sup>44</sup> D.S. Evans, “Multi-sided Platform markets”, *Yale Journal on Regulation*, vol. 20, p. 332.

<sup>45</sup> E. Weyl, “Price Theory of Multi-sided Platforms”, *The American Economic Review*, vol. 100, no. 4, September 2010, p. 1644.

<sup>46</sup> See also, R. Fleischer & D.A. Smith, “Two-Sided Markets in the EU: An Attempted Demystification”, Working Paper at University of Chicago, 2012, p.2 available online at <home.uchicago.edu/~davidsmith/research/TSM2012.pdf> (accessed 18 September 2014).

<sup>47</sup> See pt. iv) in Weyl 2010, p. 1645.

In economic literature, in order for the platform to work efficiently, it has been established both sides have to be “on board”.<sup>48</sup> However, the crux is the start of the entire business operation, namely which side is the best to be attracted first, or how large one side has to be in order to gain sufficient interest of the other side.<sup>49</sup> This issue related to indirect networks effects is designated as the *chicken-and-egg* issue.<sup>50</sup> This hurdle for starting businesses is linked with the doctrine of barriers to entry in competition law, more of which is covered in section IV.3.4.

Hagiu and Wright, however, disagree entirely with this view. According to them, those definitions would either rule out, or include, entities/markets that would be contradicting the conditions, in other words the definitions would suffer from both under- as over-inclusiveness.<sup>51</sup> The argument by the authors is that if, on the one hand, those effects are requisite for at least one of the sides, any shop having multiple kinds of products and brands for sale would be included, because customers “value the number and variety of suppliers’ products carried by the retailer”, rendering the condition over-inclusive.<sup>52</sup> However, shops and supermarkets generally are no MSP’s, because upstream wholesalers or overarching distribution centres negotiate with producers; neither shops, nor consumers themselves do so. Hence, the medium in this sense does not enable direct contact between producer and consumer, preventing the the second criterion of this definition to be fulfilled.

On the other hand, the definition would suffer from under-inclusiveness when requiring the value of both sides, because, allegedly, it would fail to incorporate so-called advertisement-supported *media markets*, such as television channels, newspapers and internet search engines. The reason conveyed is that customers “do not care about” the number of advertisers on these platforms.<sup>53</sup> This argument seems to depart from the notion, that in order for positive network effects to be established on media markets, customers have to *enjoy* seeing or reading advertisements. The question, however, is whether that degree of likeability of advertisements amongst customers matters. What seems more important is the increase of *value* that an increase in advertisers has for consumers.

Customers value advertising on platforms, not only because it makes the platform affordable, but also because the advertising service benefits the customer. Indeed, customers enjoy the service that the media platform itself provides, namely the provision of content: no rational person would purchase a newspaper solely in order to read advertisements. Also, for instance, people enjoy watching television, and utilise search engines to gather information. Hence, the medium aims at the provision and acquiescence of content.

Nevertheless, every newspaper displays advertisements, whether provided free-of-charge or on paid subscription.<sup>54</sup> Advertisers aim to introduce new products and services or increase their awareness with a large audience in order to acquire sales. They know that displaying an ad or

---

<sup>48</sup> E.g. J. Rochet & J. Tirole, “Two-sided markets: a progress report”, *RAND Journal of Economics*, Vol. 37, No. 3, Autumn 2006, p. 645–667, p. 646 & 665, as referred to by D.S. Evans & R. Schmalensee, “The Industrial Organization of Markets with Two-Sided Platforms”, *Competition Policy International*, vol. 3, nr. 1, Spring 2007; also, Filistrucchi, Geradin & Van Damme, “Identifying Two-Sided Markets”, *TILEC Discussion paper*, 21 February 2012, p. 2, 6 and 7 available online at <ssrn.com/abstract=2008661>.

<sup>49</sup> Or, how both can be attracted at the same time; see, e.g., S.P. King, “*For the Student*, Two-Sided Markets”, *The Australian Economic Review*, vol. 46, nr. 2, p. 248.

<sup>50</sup> B. Caillaud & B. Jullien, “Chicken and Egg. Competition among Intermediation Service Providers,” *RAND Journal of Economics*, vol. 34, 2003, p. 521–552. See also, D. Sokoler, “How to Solve the Two-sided Platform Chicken-and-Egg Problem: A Great Harvest!”, *Online Economy* blog entry, available online at <onlineeconomy.org/how-to-solve-the-two-sided-platform-chicken-and-egg-problem-a-great-harvest>. See also, *infra*, par. IV.2.2.2.v.

<sup>51</sup> A. Hagiu & J. Wright 2011, p. 6.

<sup>52</sup> These, however, are not a form of platform market, because retailers or overarching distribution centres individually negotiate with producers, hence, there is no enabling of direct contact between producer and consumer. This renders the argument somewhat ineffective.

<sup>53</sup> A. Hagiu & J. Wright 2011, p. 6. See also, G. Luchetta, “Is the Google Platform a Two-Sided Market?”, 30 April 2012, p. 15-16, available online at <ssrn.com/abstract=2048683> (accessed 18 September 2014).

<sup>54</sup> As already affirmed by, e.g., W. M. Corden, “The Maximisation of Profit by a Newspaper”, *The Review of Economic Studies*, vol. 20, no. 3, 1952-1953, 181-190, p. 181-182.

commercial does not immediately result in the sale of a product (also known as *conversion*).<sup>55</sup> It both demands the right set of customers and a degree of convincing. By their investments in advertising, they increase the value of the network for new consumers, because the network can still be supplied for a low price at maintaining quality. Moreover, irrespective of their efficiency, advertisers succeed in their aim, because they meet a demand for relevant advertising.<sup>56</sup>

In economic terms, because transaction costs exist between advertiser (seller) and end user (buyer) – a buyer usually is unaware of a seller’s existence or its prices – the medium creating this awareness decreases transaction costs.<sup>57</sup> Also, because companies such as Google derive their income almost solely on the basis of advertising profits, it sufficiently proves that customers value (relevant) advertising.<sup>58</sup>

Furthermore, those who absolutely dislike advertisements and will never respond to them, yet who continue to use the medium are essentially *free riders* of the platform. They benefit from the network, from the affordability, and from the display of potentially beneficial products or services, though do not add value by responding to the advertisements.<sup>59</sup>

Lastly, in literature, the notion has been uttered that within media markets, two separate markets and two distinct types of customers would exist, namely the market for advertising and one for content.<sup>60</sup> This argument, however, seems unconvincing. For instance, with a newspaper, content and advertisements are usually displayed on one page. Also, strategically placed ads make it highly unlikely not to view them. What is important, but that is a business strategy decision made by the company, is the ratio and degree of visibility of ads versus the content that a medium wishes to display.<sup>61</sup> Hence, the services offered can be distinguished from one another, yet both exist on one market.

#### III.2.4. *Bilateral market power.*

The final characteristic of MSP’s is the ability for the operator of the platform to charge different prices to either side of the platform for using the platform, also known as an expression of the bilateral market power of the operator.<sup>62</sup> Whereas, for example, setting equal prices for men as for women would result in no singles dating in the club, the operator charges more for men and,

---

<sup>55</sup> As a matter of fact, in Europe, an increase of 1% in advertisement spenditure has a higher advertising elasticity than compared to the United States, R. Sethuraman, G.J. Tellis & R. A. Briesch, “How Well Does Advertising Work? Generalizations from Meta-Analysis of Brand Advertising Elasticities”, *Journal of Marketing Research*, vol. 48, June 2011, p. 457-471. See also H.R. Varian, “The Economics of Internet Search”, *Rivista di Politica Economica*, November-December 2006, p. 178.

<sup>56</sup> One way in which this is shown is by the bids that advertisers place on certain keywords. When a keyword to the product is more relevant, the higher the bid will turn out. The same could, therefore, be concluded for the attraction of advertisers to types of platforms, for instance the large amount of advertisements for internet connection subscriptions and smartphones in free newspapers. See e.g. Y. Chen & C. He, “Paid Placement: Advertising and Search on the Internet”, *NET Institute Working Paper* No. 06-02, September 2006, p. 2, available online at <ssrn.com/abstract=936472>. See also the website <getrelevantordie.com> or J. Cohen, “How do I know where to advertise?”, *A Smart Bear blog* entry of 5 June 2012, available online at <blog.asmartbear.com/begin-advertising.html> (accessed 18 September 2014).

<sup>57</sup> More importantly, the customer might not even have an idea of the existence of the product or service in the first place. Advertisements can not only create awareness, but also demand.

<sup>58</sup> See e.g. the 2013 Financial Tables on the Investor relations page of Google, totalling advertising revenue for 2013 at \$50.578.000,-, tables are available online at <http://investor.google.com/financial/2013/tables.html> (accessed 18 September 2014).

<sup>59</sup> Considering this an inherent consequence of advertisement-financed platforms, the matter of good advertising policy seems to become one of relevance, instead of appearance: the relevant announcements have to be shown to the relevant crowd in order to draw attention.

<sup>60</sup> E.g. G. Luchetta 2012, p. 3 ff.

<sup>61</sup> Long commercial blocks within a movie or TV show are generally perceived as irritable; the same can be said about the number of ads in free newspapers, making them similar to mere advertisement brochures.

<sup>62</sup> Weyl 2010, p. 1644.

relatively little to nothing for women upon joining. This not only makes the platform operational, but also potentially profitable.<sup>63</sup> This notion of price-setting is central to the getting “both sides on board” aspect of an MSP.<sup>64</sup> The following explains that this works in a peculiar fashion for Google.

One could argue that, once a platform functions properly, competition between these platforms becomes difficult, because of the indirect network effects and benefits derived. On the one hand, users are can be locked-in, experiencing switching costs. Nevertheless, on various aspects, competition for end users exists. For instance, in advertisement-supported markets, advertisers usually advertise on multiple platforms. Also, customers generally read more than one newspaper, either on- or offline, paid or for free. In the market for payment, people and merchants have or accept multiple ways of payment, such as credit or debit cards, or cash money. This phenomenon is often referred to as *multi-homing* by end-users.<sup>65</sup> The degree in which multi-homing occurs is essential for establishing abuse of dominance situations, as dominance is less likely to be established, whenever more consumers are likely to use similar platforms at the same time.<sup>66</sup>

### III.3. Application to Google Search

#### III.3.1. Introduction

Having explained the relevant general characteristics of MSP's, in the following section, Google Search will be tested according to this definition. Even though the literature is sincerely expanding on MSP theory,<sup>67</sup> by and large, Google Inc. remains uncovered.<sup>68</sup> Therefore, the following assesses the medium, explains the three-sidedness of the engine, as well as the various network effects separate sides exhibit. Lastly, the particular bilateral market power of the firm is covered.

#### III.3.2. The medium

The medium consists of the Google Search engine, accessible through <http://google.com/>, and of the AdWords and AdSense services, accessible via <http://google.com/adwords> and

---

<sup>63</sup> This is probably also why several authors refer to the price-setting as a form of cross-subsidization. J. Rochet and J. Tirole, “Platform Competition in Two-sided Markets”, *Journal of the European Economic Association*, June 2003, vol 1, ed. 4. p. 1017-1018. See also T. Eisenmann, G. Parker & M.W. Van Alstyne, “Strategies for Two-Sided Markets”, *Harvard Business Review*, vol. 84, October 2006, p. 94.

<sup>64</sup> D.S. Evans, “The Antitrust Economics Of Two-Sided Markets” , p. 2 and 50 ff., available online at <[ssrn.com/abstract=332022](http://ssrn.com/abstract=332022)> (accessed 18 September 2014). As the demand for one side, for instance video game developer, depends on the platform's (the video game console) other side, viz. the number of costumers, the platform operator could decide to demand a price from the game developer in order to have its software exploited on the medium. However, the willingness to pay for a consumer appears to be higher, when a console has numerous games. Hence, the console's operator would do best at establishing a lower price for software developers, therewith increasing the number of applications for the console, and charging a relatively higher price for customers.

<sup>65</sup> D.S. Evans, “The Antitrust Economics of Two-Sided Markets”, p. available online at <[ssrn.com/abstract=332022](http://ssrn.com/abstract=332022)> (accessed 18 September 2014). This concept originally was used to describe a device being able to connect to more than one computer network, providing for a more reliable IP network. The opposite is called *singlehoming*.

<sup>66</sup> See par. IV.3.4.3.

<sup>67</sup> E.g. the appendix in D.S. Evans & R. Schmalensee, “The Antitrust Analysis of Multi-Sided Platform Businesses”, p. 47, in: R. Blair & D. Sokol, eds., *Oxford Handbook on International Antitrust Economics*, Oxford University Press, 2014 (forthcoming).

<sup>68</sup> In various articles, it is simply mentioned as an example of two-sidedness. Cf. A. Hagiu, “Multi-Sided Platforms: From Microfoundations to Design and Expansion Strategies”, Working Paper 09-115, 23 February 2008, p. 5 & 6, available online at <[ssrn.com/abstract=1372754](http://ssrn.com/abstract=1372754)> (accessed 18 September 2014). Conversely, G. Luchetta 2013; C. Argentón & J. Prüfer, “Search Engine Competition with Network Externalities”, *Journal of Competition Law & Economics*, vol. 8, ed. 1, p. 73-105.

<http://google.com/adsense> respectively.<sup>69</sup> As such, three services are provided to three different types of users, making it a genuine multi-sided platform.<sup>70</sup>

### III.3.3. *Internalizing Externalities*

As its primary activity, Google crawls websites on the WWW and indexes them for free. For those that do not wish their web pages to be crawled, an opt-out is possible.<sup>71</sup> As a consequence, the website will not be incorporated in the crawling activities, and will not emerge on any search results: then, Google Search users will not be able to find the website.

The second side consists of end users, and the service is distinct from the typical media platform. Whereas radio and TV channels, and newspapers directly provide content to end users and advertisers, a search engine only provides the portal or the gateway to accessing the (online) content. The information that, moreover, is supplied with every displayed hyperlink is the cached material on Google's servers, and is neither complete nor current information.

Lastly, the third side of Google Search consists of the money makers, the advertisers. This ties with both the customer end and the index end of the search service. As mentioned previously, advertisement services are offered by Google Inc. not only next to the search results, but also on indexed web pages themselves. Furthermore, advertisers are not only large firms: any interested party can advertise for any keyword or combination of keywords to have a message supported by or advertised on Google.

---

<sup>69</sup> The search engine, moreover, extends further than merely the web page, as it has been integrated into multiple pieces of web browsing software as search box or integrated even into the address bar (Google Chrome). For simplicity's sake, and the sake of providing a clear diagram of the platform, these other forms the engine takes will not be taken into account in this research.

<sup>70</sup> Conversely, see K.L. Devine, "Preserving Competition in Multi-Sided Innovative Markets: How Do You Solve a Problem Like Google?", *North Carolina Journal of Law & Technology*, vol. 1, ed. 1, Fall 2008, p. 80; also G. Luchetta, "Is the Google Platform a Two-Sided Market?", 30 April 2012, available online at <[ssrn.com/abstract=2048683](http://ssrn.com/abstract=2048683)> (accessed 18 September 2014), and M.R. Patterson, "Google and Search Engine Market Power", *Harvard Journal of Law & Technology, Occasional Paper Series*, July 2013, p. 16-18.

<sup>71</sup> A website can indicate the preference not to be indexed by placing a text-file in the designated directory of the website, carrying the header "robots.txt". See for an explanation on how this works Robotstxt.org, "About /robots.txt", available online at <[robotstxt.org/robotstxt.html](http://robotstxt.org/robotstxt.html)> (accessed 18 September 2014). E.g., <http://example.com/robots.txt> contains a specific code, entailing a response to a web crawler that all content on the domain is not up for crawling or indexing. See also Google Support, "Block search indexing with meta tags", available online at <[support.google.com/webmasters/answer/93710?hl=en](http://support.google.com/webmasters/answer/93710?hl=en)>. For instance, the website for EU legislation <[eur-lex.europa.eu](http://eur-lex.europa.eu)> has opted out for the so-called Googlebot, e.g. on <[eur-lex.europa.eu/robots.txt?uri=CELEX:12008E102:EN:NOT](http://eur-lex.europa.eu/robots.txt?uri=CELEX:12008E102:EN:NOT)> (accessed 18 September 2014).

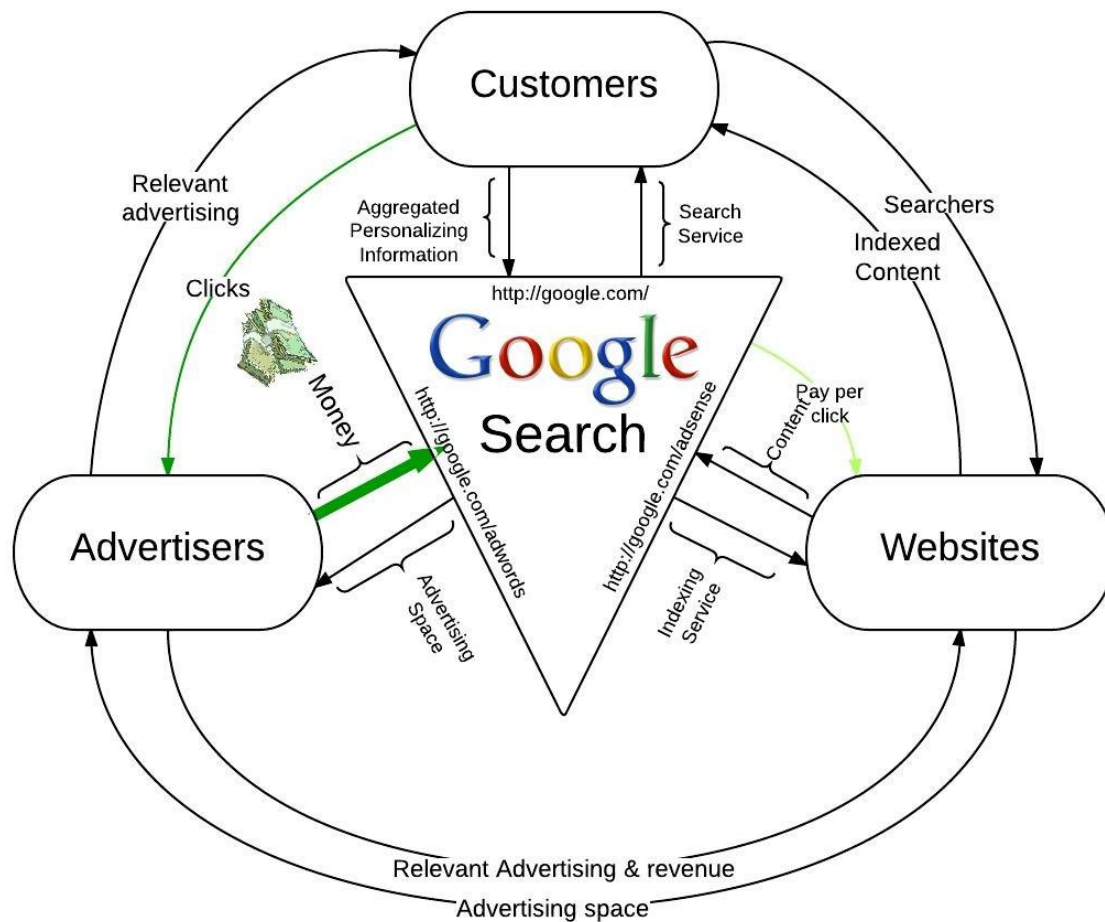

Diagram 5. The Google Search Platform

As the reader can hereby infer, these interlinked services make Google Search a three-sided platform, graphically illustrated in Diagram 5.<sup>72</sup> Via the search box, customers enter queries and are able to view and come in touch with advertisers and websites. Via AdWords, a company can reach out to consumers, and, via AdSense, websites can reach advertisers.<sup>73</sup>

#### III.3.4. Network effects

In contrast to current economic theory on MSP's, the search engine is structured in such a manner that it displays both direct and indirect network effects. Irrespective of its (PageRank) algorithm, this might also explain the large popularity of Google. Because the platform consists of three sides, for each side the network effects should be assessed. Recalling the definition of direct network effects, it should mean that the value of the good or service should increase successively for new entrants. For both indexed websites and customers this holds true. The advertisers side experiences only indirect or same-side network effects.

<sup>72</sup> See also R. Pollock, "Is Google the Next Microsoft: Competition, Welfare and Regulation in Online Search", *Review of Network Economics*, vol. 9, ed. 4, 2010, article 4, p.7., and A. Lohse, "Comments on Google's Proposed Commitments to the European Commission", letter dated 27 May 2013, p.1, available online at <ruhr-uni-bochum.de/ls-hueffer/dls/Downloads/Google%20Statement.PDF> (accessed 18 September 2014).

<sup>73</sup> For websites, Google enables contact or visits, as it internalises the externality of the ability to be found on the internet, hence decreasing transaction costs. It works similarly for the advertising services, as ads are made visible to consumers searching for websites, which either focus on or are related to the initial query, in turn enabling contact and potentially contract. Vice versa, contact and contract with consumers is enabled by Google for both advertisers and indexed web pages.



First, the side of indexed websites benefits increasingly when more websites become crawled. The more websites are crawled, the more become indexed and the more can be reached by searchers. If more websites are indexed, one particular website will have to compete with a multitude of other websites in order to draw traffic. At first glance, it might seem that indexation of web material is counterproductive to the websites themselves.

However, irrespective of the behaviour of customers and advertisers, the value of the search engine with regard to the indexed websites will increase with every added web page, due to PageRank. On the basis of the algorithm, every website in the index is assessed on the number of links that link to it. As a consequence, when new websites are crawled and indexed, a renewal of the page rank assessment will take place; when the engine is used, the most relevant results will emerge.<sup>74</sup> Hence, every new piece of information, contained on new websites could lead to a reassessment of the search ranking results, improving the Google Search network and making it more valuable for websites to also join the network. Therefore, it can be concluded here that also websites experience direct network effects.

Similarly to the argument made with regard to the websites, new entering customers gain more by searching on Google. Using Google means inserting web searches into the Google Search box. As mentioned before, every time a query is entered, it is also stored and connected to the searcher's IP, cookies and other personalizing or localizing data. The algorithms of Google incorporate this data as factors for new searches. As such, Search "learns", supports and potentially improves the searching behaviour of persons, regions and even nations. Thus, every query directly leads to more valuable searching, independent from the actions or behaviour of other sides on the network, making it a direct network effect.<sup>75</sup>

Subsequently, for users of Search *indirect* network effects exist, which are related to the involvement of websites on the one hand, and of advertisers on the other. Regarding the former, if more websites are incorporated in a search, more results can be displayed. From a quantitative perspective, this will lead to a higher value for customers, because the opportunity to find a match to a query is boosted. Moreover, from a qualitative point of view, when more content is incorporated, the searching experience will become more diverse, meaning it would also make it more attractive to utilise Search for searchers otherwise uninterested. As a final remark, considering PageRank, if more websites are indexed, a more thorough analysis of websites is executed with respect to the query.

### *III.3.5. The unusual shape of Google's bilateral market power.*

Lastly, the bilateral market power of Google allows it to set differing prices for the several sides of the market. However, the fulfilment of this criterion takes on a uniquely different form compared to the described MSP's in literature. Both the services to end users and to websites are provided for free, whilst prices are charged to advertisers. Whereas, furthermore, most advertising schemes charge on the basis of the number of displays, in which the highest bidder takes the first spot and fills the slot, an advertiser on a search engine, as aptly described by Edelman e.a., "pays the search engine for sending the user to its web page", also known as pay-per-click or cost-per-click (PPC or CPC).<sup>76</sup>

Furthermore, Google arranges, rather than fixes, prices by ways of auctions. As extra icing on the cake, these ad auctions sit uniquely within general auctioning theory. In order to grasp the manner in which the firm sets the price to individual advertisers, which is according to a so-called *generalised second-price auctioning* mechanism, a comparison with several well-known auctions is displayed

---

<sup>74</sup> Whether it *de facto* displays the actually most relevant pages remains to be seen. Relevance, in this sense, is merely defined as "the page to which is linked the most", and actual relevance to the query entered might be doubtful.

<sup>75</sup> Cf. C. Argenton, & J. Prüfer, "Search Engine Competition with Network Externalities", *Journal of Competition Law & Economics*, vol. 8, ed. 1, 2012, 73-105, where they interpret the effects as a "peculiar (intertemporal) type of *indirect network externalities*", p. 76, and relate those to the learning curve hypothesis in economics, p. 80.

<sup>76</sup> B. Edelman, M. Ostrovsky & M. Schwarz, "Internet Advertising and the Generalized Second Price Auction: Selling Billions of Dollars Worth of Keywords", *NBER Working Paper no. 11765*, November 2005, p. 2.

first. Relevant in this sense is the manner in which the dominant strategy of bidders is addressed by different auctions.

### *III.3.5.1. Other auctions and dominant bidding strategy*

For a profit-maximizing undertaking employing an auction, the optimal dominant strategy of bidders has to be taken into account. With regard to the dominant strategy of bidders in well-known auctions, the value adhered to auctioned goods does not fully reflect the actual willingness to pay. In those auctions, the incentive for bidders has always been to bid lower than the actual value, in order to pay a lower price for the acquired good. Such auctions, in which bidders are confronted with either a descending (Dutch flower auctions) or an ascending (English art auctions) bid structure, therefore have a slightly downwards sloping effect as to the price.<sup>77</sup> This causes an incentive to cheat on the competition; in other words, the *dominant strategy* for every competitor within these auctions is to attach a lower than the true value to the bid.<sup>78</sup> This not only is the charm, but also the detriment of several auctioning mechanisms.

Further, the so-called *Vickrey* auction theoretically reflects the true value in a bid, allowing the highest bidder to take the lot, yet to pay the price of the second highest bid.<sup>79</sup> Cheating in the form of inserting a low bid would not be effective, because those bids would easily be outbid by competitors. The incentive for all players would then be to bid truthfully according to the value attached.<sup>80</sup>

A further developed auction called *Vickrey-Clarke-Groves* (VCG) auction organises bids where the ultimate price to pay was based on the externalities or loss of welfare caused by the winning bidder unto the other parties.<sup>81</sup> In other words, as stipulated by Edelman e.a., “each player’s payment is equal to the negative externality that he imposes on others, assuming that bids are equal to values”.<sup>82</sup> The relevance for Google in this sense, is that it utilizes a bid structure that incorporates both the *Vickrey* and *VCG* mechanisms. Google has a large audience of potential buyers to attract advertisers towards the auction; consequently, under those circumstances, advertisers will bid high. However, the entire search engine performs as the platform by ways of which the slots are sold. The following section on the Ad Auction bid structure explains this further.

### *III.3.5.2. The bid structure of Google Ad auctions*

As established, Google is a media platform. As regards pricing, a media platform does not set a fixed price on the advertising service, whereas other MSP’s do. The access to and use of Google is free for consumers and for websites. Only advertisers are charged, the price of which serves as leverage for or cross-subsidization of the other sides.

Nevertheless, this pricing and ranking of advertisers differs from the schemes used by other media platforms. The circulation of a newspaper or magazine gives an indication of the number of displays,

---

<sup>77</sup> Hence, those auctions are called Dutch respectively English auctions. The first often works by a clock that moves down from a high value; by pressing the button first, one can stop the clock at the desired price. The latter works by establishing an essentially low base price, and raising the price as bids are confirmed consecutively.

<sup>78</sup> D. Easley & J. Kleinberg, *Networks, Crowds, and Markets: Reasoning about a Highly Connected World*, Cambridge, Cambridge University Press 2010, p. 254 ff.

<sup>79</sup> W. Vickrey, “Counterspeculation, Auctions, and Competitive Sealed Tenders”, *The Journal of Finance*, vol. 16, ed. 1, March 1961, p. 8-37, available online at <jstor.org/stable/2977633> (accessed 18 September 2014). Supposedly he invented this type of auction. However, see D. Lucking-Reiley, “Vickrey Auctions in Practice: From Nineteenth-Century Philately to Twenty-First-Century E-Commerce,” *Journal of Economic Perspectives* vol. 14, ed. 3, Summer 2000, p. 183-192, describing the practice as dating back to the 1890s.

<sup>80</sup> *Idem*, p. 20.

<sup>81</sup> E.g., in I. Ashlagi, B. Edelman & H.S. Lee, “Competing Ad Auctions”, *Harvard Business School Working Paper*, no. 10-055, 27 September 2013.

<sup>82</sup> B. Edelman, M. Ostrovsky & M. Schwarz 2005, p. 8. However, the Vickrey and VCG mechanisms did not appear entirely feasible in real life. The mechanism, amongst other things, elicited collusion amongst bidding parties, collectively keeping bids and thus prices low, P. Klemperer, *Auctions Theory and Practice*, Princeton: Princeton University Press, 2004, p. 33, nt. 91 and 64, nt. 7.

forming the value of and price for placing an ad.<sup>83</sup> Also, TV shows or programs that are notable for drawing large publicity are known to drive up the price for commercials.<sup>84</sup> Similarly, the price for search advertising depends on the number of viewers. However, because the price is only established by the interested (*i.e.*, clicking) customer, prices are executed per individual click, thereby distinguishing them sufficiently from any other media platform.<sup>85</sup> In essence, search advertisements are not sold independently from the actions of individual users.

Google does not set any prices; it merely regulates the price-setting by ways of auctions. Billions of ad auctions are automatically run per day on the servers, which are executed after queries are entered.<sup>86</sup> Advertisers enter the keywords on which they wish to bid and connect these to their advertisement hyperlinks. The competition in the Google ad auction is based on CPC and on the so-called Quality Score, which is assessed on the relation between the keyword and the advertisement, such as the wording of the ad, the layout of the website, the click through rate (CTR) of customers to the website and multiple other, potentially secret, factors. Therefore, every advertiser is incentivised to provide for the most – in the widest sense – attractive web page in order to gain a higher or the highest position in the Sponsored Search Results list. As a consequence, the ‘price on search’ is never homogeneous.<sup>87</sup> This reveals one of two peculiarities of the auctions that Google runs, namely that the bid itself does not solely determine the highest rank. Another is that the price paid for a click is not based solely on the bid.

As stated, Google ad auctions seem to incorporate both the *Vickrey* and *VCG* mechanisms. They run on what in literature has been called the *generalised second-price auction*.<sup>88</sup> It is somewhat similar to the *Vickrey* auction, as originally, it let an advertiser pay the price of the advertiser on the slot below it. However, the distribution of slots is not solely based on the entered bid price. As mentioned above, the bid is multiplied by a so-called Quality Score.<sup>89</sup> Subsequently, various updates in the Google algorithms have altered and attempted at ameliorating the assessment of the ad quality and as such the positioning of advertisers in the auctions. This algorithmic assessment results in a factor by which the initial bid is multiplied, resulting in the ranking of the advertisements. An advertiser pays the minimum amount in order to retain its position.<sup>90</sup> In order to determine the price of a click at the quality score of the advertiser, it has to beat [bid] times [Quality Score] of the first competitor ranked below it.<sup>91</sup> Furthermore, it should be noted that it is an auction for clicks, and,

---

<sup>83</sup> It is an indication, because the number of subscription does not necessarily mean the number of readers. For instance, as written on the back of the Dutch free newspaper *Spits*, on average, a *Spits* is read by four different people a day, considering their distributed locations (stations, public buildings, etc.).

<sup>84</sup> E.g. D. Thompson, “Super Bowl Ads Are Still Super Cheap: \$4 Million for 30 Seconds Is a Bargain”, 1 February 2013, *The Atlantic*, available online at <[theatlantic.com/business/archive/2013/02/super-bowl-ads-are-still-super-cheap-4-million-for-30-seconds-is-a-bargain/272628](http://theatlantic.com/business/archive/2013/02/super-bowl-ads-are-still-super-cheap-4-million-for-30-seconds-is-a-bargain/272628)> (accessed 18 September 2014). See also S. Levy, *In the Plex. How Google thinks, works, and shapes our lives*, New York, Simon and Schuster, 2011, p. 330.

<sup>85</sup> Nevertheless, the price on these auctions can reach quite phenomenal heights, as well, see NowSourcing, “Who Buys All Those Google Ads?”, *Visual.ly* information graphic, available online at <[visual.ly/who-buys-all-those-google-ads](http://visual.ly/who-buys-all-those-google-ads)> (accessed 18 September 2014).

<sup>86</sup> H.R. Varian, “How auctions set prices”, *Google Official Blog entry*, 12 May 2008, available online at <[googleblog.blogspot.nl/2008/05/how-auctions-set-ad-prices.html](http://googleblog.blogspot.nl/2008/05/how-auctions-set-ad-prices.html)> (accessed 18 September 2014).

<sup>87</sup> Cf. M.R. Patterson 2013, p. 8.

<sup>88</sup> D. Easley & J. Kleinberg 2010, p. 254 ff., and B. Edelman, M. Ostrovsky & M. Schwarz 2005, p. 6 ff.

<sup>89</sup> See, e.g., Google Support, “Check and understand Quality Score”, under “How we calculate Quality Score”, available online at <[support.google.com/adwords/answer/2454010?hl=en&from=10215&rd=1](http://support.google.com/adwords/answer/2454010?hl=en&from=10215&rd=1)> (accessed 18 September 2014). Originally, only the CTR was multiplied with the bid. That is the number of clicks divided by the number of displays/impressions of the advertisement times a hundred percent, or  $CTR = (\text{number of clicks} / \text{number of displays}) \times 100$ ; see H.R. Varian, “How Google Adwords Works and What You Have to Do to Succeed with It”, *Youtube video*, available online at <[youtu.be/1KMe6BoIEiQ](http://youtu.be/1KMe6BoIEiQ)> (accessed 18 September 2014).

<sup>90</sup> Which, therefore, is similar to, yet different from the *Vickrey* auction, where the bidder pays the exact bid below him.

<sup>91</sup> S. Levy, “Secret of Googlenomics: Data-Fueled Recipe Brews Profitability”, *Wired Magazine*, 22 May 2009, available online at <[wired.com/culture/culturereviews/magazine/17-06/nep\\_googlenomics](http://wired.com/culture/culturereviews/magazine/17-06/nep_googlenomics)> (accessed 18 September 2014).

therefore, many executed auctions/rankings merely result in displays, not in clicked advertisements, and not in sales to Google.

An example can clarify the theory explained. Imagine three advertising slots available for a particular query, and four bidding advertisers. The bids and the Quality score (in the second and third column) are fictitious, and the Ad Rank, rank and CPC are derived by ways of the formulas.<sup>92</sup>

Bidder	Bid	Q.S.	Ad Rank	Rank	CPC
1	€6,5	2	13	4	n/a
2	€5,-	9	45	1	€2,-
3	€3,-	6	18	2	€2,67
4	€2,-	8	16	3	€1,63

Diagram 6. Table of an Ad Auction for 3 Available Slots

When a query is entered, Google runs these auctions, by assessing the relevant keywords in the query, determining the number of slots available, the number of advertisers who have associated their bids with the entered keyword(s), the quality scores, and assembles the ranking. All this literally happens in the blink of an eye. From the table it follows that all bidders pay below their initial bid, yet the actual cost of the highest ranked bidder is lower than that of the second highest bidder (2 vs. 2,67), due to its higher Quality Score. Consequently, not only could competition for the highest bids follow, but also for the improvement of the advertiser's website and advert, as it could decrease the price that it has to pay.<sup>93</sup>

Allegedly, however, this auctioning mechanism relapses in the initial problem as signified by Vickrey, which is not stating the price at the actual value of the item.<sup>94</sup> Individual advertisers rather set their bids on the basis of revenue/profit they can make with the advertising mechanism. Profits are only gained in the number of sold products or services. Those who choose to operate on AdWords base their true value not only on the value of the bid alone, but also invest time and effort (and thus, money) in the quality of the advertisement, so-called opportunity costs.

The above is an explanation of Google's price-setting market power, which is no power in and of itself, but more a role that offers the mechanisms that allow individual users to set the price on Search. Ultimately, this full description and elaboration on the utilization and profitability of the auctions by and for Google serves as a sound example of why multi-sided platforms can be profitable, without keeping fixed the sum of charged prices for both sides.<sup>95</sup> With the market forces at play on all sides of the platform, Google has turned out to be an exceedingly profitable player on the world market. The sum of the cost of a click and the price of searching or indexing is never fixed, yet has enabled price competition for the highest ad slots.<sup>96</sup>

In summary, Google utilises an auction as the price-setting mechanism for the platform of Google Search. With it, the firm enables parties to establish the right price for the growing number of advertisers *vis-à-vis* a growing number of end users, due to market forces and network effects. The auction is, therefore, dependent on three factors, which coincide with the three sides on which Google is active. The mechanism needs customers to click, advertisers to advertise and (good) websites or (good) organic search results to attract customers again, to provide for advertising space,

<sup>92</sup> In order for bidder 2 to stay at the top ranked position, it must pay  $3 \times 6 \div 9 = €2,-$ , in which  $3 \times 6$  equals the bid and Q.S. of bidder 3. For bidder 4, the same formula applies with respect to bidder 1's bid and Q.S.:  $6,5 \times 2 \div 8 = €1,625$ .

<sup>93</sup> Cf. M.R. Patterson 2013, p. 21.

<sup>94</sup> H.R. Varian, "The Economics of Internet Search," *Rivista di Politica Economica*, November-December 2006, p. 17-18.

<sup>95</sup> Conversely, J.J. Rochet & J. Tirole, "Two-sided markets: a progress report", *RAND Journal of Economics*, Vol. 37, No. 3, Autumn 2006, p. 645-667, and L. Filistrucchi, "Identifying Two-Sided Markets", *TILEC Discussion Paper*, DP 2012-008, 21 February 2012, p. 6, available online at <ssrn.com/abstract=2008661> (accessed 18 September 2014).

<sup>96</sup> Witness the findings in the 2011 infographic on *Visual.ly*, *supra*, nt. 176.

as well as to influence the ad ranking. What can be concluded from this is that Google enables high price-setting for particular queries by attracting more potentially interested consumers, as well as using their aggregated personalizing data to drive up prices conform market effects, giving the customer a crucial role in Google's Search platform. Google, thus, does not set prices as any other MSP operator does, but it influences the bidding relationship between number of advertisers and the number of clients it serves, confirming its bi- or even trilateral market power.

### **III.4. Conclusion**

Within the scope of relatively standard MSP definitions, Google as search engine assumes a currently unique role as three-sided platform, utilizing its auction-based second-pricing mechanism on a medium that is rife with network effects. Even though in this article only Google Search is scrutinised, and Google has, in the course of the last decade, introduced a large number of novel products and services, this model can either be applied independently to Search, but also to the ancillary products that Google offers. Arguably,<sup>97</sup> this leads to new network effects, constantly attracting new customers to the Search platform, satisfying advertisers. Moreover, it could be that the integration of novel software, products, algorithms etc. to Google's platform leads to stronger network effects and, therefore, has an even further multiplied attraction on platform users. In part, the following chapter will focus on these potential dominance-establishing factors, by discussing the legal framework on dominance within European competition law.

---

<sup>97</sup> K.L. Devine, "Preserving Competition in Multi-Sided Innovative Markets: How Do You Solve a Problem Like Google?", *North Carolina Journal of Law & Technology*, vol. 1, ed. 1, Fall 2008, p. 83-84.

## **IV. The Qualification of Google as Dominant Undertaking in Online Search.**

### **IV.1. Introduction**

As corporations grow, competition agencies become triggered to supervise the underlying markets. Additionally, due to current and on-going technological and economic progress, novel markets have arisen which experience strong innovations, as well as vigorous competition. As an exception, over the past 15 years, Google has provided search engine services on a worldwide scale and has maintained a constant financial growth, where many others have failed to do so. As a consequence, the curiosity of European and other competition law agencies has been sparked.

In order for competition law to be applicable, however, various steps have to be taken. As a research into all these aspects is too broad for an article of this proportions, in this research, only two of these steps shall be examined. The relevant, overarching question for applying European competition law is whether or not a company such as Google can be categorised as dominant. Essential in this sense, which also connects to the former chapter, is the role attributed to the network effects that the Google Search algorithms display. As economic concepts form part of competition law analyses, network effects with regard to generating dominant positions deserve attention. Other relevant aspects in the legal assessment, such as the consideration that Google does not directly charge searchers for its services, and therefore might not be seen as an undertaking, shall not be covered in this section. It shall be taken as given that Google performs its role as undertaking under the EU competition rules.

A subsidiary aim of this chapter, however, is to clarify that classic methodology in the application and enforcement of rules on dominance has become old-fashioned. Whereas competition agencies might be triggered to enforce the competition law, they appear to be insufficiently capable of doing so with respect to the novel markets. The failure of classic market analysis methodology is therefore also addressed in this chapter, forming part of the larger dominance assessment of Google's Search platform. The shift that the European Commission has therefore taken towards Commitments Decisions is also covered.

The approach of the chapter is as follows: by ways of assessing the treaty provisions and the relevant case law, a market assessment is introduced in section 3.2 (subsections 1-5). This forms the answer to the legal question underlying the assessment of Google's potential dominant position. In section 3.2.6, the dominance analysis is pursued, in which definitions of dominance by several academics are explained, as well as various barriers to entry are brought to the fore, the most prominent of which are network effects. These aspects are interpreted in the light of discovered case law. Lastly, in section 3.3., an elaboration on the Google Commitments procedure is given.

### **IV.2. The law of dominance in the EU**

Generally, when confronted with a legal issue, a lawyer or legal scholar will commence his or her research by analysing the basic framework that the particular applicable law has. Legal bases, extrapolated rules and authoritative interpretations layering on each other usually form such a framework. Subsequently, the issue at hand is approached, according to the derived legal structure.

It might be that the legal approach for an antitrust issue has been structured by ways of identifying the market, subsequently of determining the relevant competitors and of assessing their positions and specific conditions in the market that may or may not make one competitor dominant, and then, of judging the conduct of the dominant undertaking in particular. Still, the contents of each concept appear to differ from market to market, from competitor to competitor and from conduct to conduct. Therefore, one abstracted question is, for instance, whether a uniform definition can be found with which practice can work.

Considering that common sense suggests multi-sided platforms are not incorporated in any competition case what so ever, though network effects are, a more specific question then becomes whether article 102 TFEU gives a prominent enough role for network effects by ways of which to assess the Google Search algorithm.

The definitions for dominance and abuse have been given in various cases, yet, do not constitute a sound, workable body of law without further interpretation. Below, apart from a display of the law on dominance, it will also be shown that the employment of Google's search algorithm will pose a problem for the application and interpretation of the law as it stands.

#### *IV.2.1. Treaty provision*

As the facts have been explained thoroughly enough in the previous sections, the legal qualification comes down to a form of unilateral action performed by one undertaking, Google Inc., and further, by the employment of its Search algorithm. Unilateral conduct on markets has the potential of triggering the application of European Union competition policy, most notably Art. 102 TFEU. To be precise, for fully assessing a competition case, the aspects of abuse, undertaking, dominance, the relevance for the internal market and the affect for the trade between Member states have to be addressed. In the remainder of this section, however, only the concept of dominance is covered, focusing mostly on network effects.

#### *IV.2.2. Case law.*

Dominance is a concept which has neither been defined nor otherwise legally authoritatively interpreted by the European legislative and enforcement branch.<sup>98</sup> Over the course of the European Union history, this task has, therefore, been fulfilled by the European Court of Justice (hereinafter: "the Court") in various cases, which concept has been found equally applicable to the concepts enshrined in the Treaties on European Union and on the Functioning of the European Union.<sup>99</sup>

The foundation of the dominance analysis was laid down by the Court in the *United Brands* case, stating the following:

*"The dominant position referred to in this Article relates to a position of economic strength enjoyed by an undertaking which enables it to prevent effective competition being maintained on the relevant market by giving it the power to behave to an appreciable extent independently of its competitors, customers and ultimately of its consumers [emphasis added]"*<sup>100</sup>

Subsequently, the ruling was reiterated by the Court in *Hoffmann-La Roche* with the following, added, paragraph and has since then been established as standing law:

*"Such a position does not preclude some competition, which it does where there is a monopoly or quasi-monopoly, but enables the undertaking which profits by it, if not to determine, at least to have an appreciable influence on the conditions under which that competition will develop, and in any case to act largely in disregard of it so long as such conduct does not operate to its detriment."*<sup>101</sup>

Lastly, with regard to the legal framework, once an undertaking becomes or is dominant, the Court bestows a special responsibility upon it, which was introduced in the *Michelin* case. The relevant part reads as follows:

<sup>98</sup> R. Nazzini, *The Foundations of European Union Competition Law: The Objective and Principles of Article 102*, Oxford, OUP 2013, chapter 10, p. 329.

<sup>99</sup> ECJ, Case C-52/09 of 17 February 2011, *Konkurrensverket v TeliaSonera Sverige AB*, ECLI:EU:C:2011:83, par. 20-23.

<sup>100</sup> ECJ, Case 27/76 of 14 February 1978, *United Brands Company v. Commission (UBC)*, ECLI:EU:C:1978:22, par. 65.

<sup>101</sup> ECJ, Case 85/76 of 13 February 1979, *Hoffmann-La Roche & Co AG v. Commission of the European Communities (HLR)*, ECLI:EU:C:1979:36, par. 38-39.

*“A finding that an undertaking has a dominant position is not in itself a recrimination but simply means that, irrespective of the reasons for which it has such a dominant position, the undertaking concerned has a special responsibility not to allow its conduct to impair genuine undistorted competition on the common market.”*<sup>102</sup>

This means that, even though having a dominant position itself is not prohibited, as soon as the respective entity is aware of its dominant status on the market, it cannot continue and behave as it would under (normal) competitive market conditions. These practices could lead to exploit consumers being exploited, competitors being excluded or its dealing partners to be discriminated against, which might damage competition, competitors and ultimately, consumers.<sup>103</sup>

Before conducting any further research into the existence of a dominant position, it is, according to the definition given in *UBC*, necessary to establish the relevant market on which Google is likely to be active. A market definition itself might already give an indication of a dominant position, as it depends on the narrowness of the definition whether only one active entity can be defined or multiple.

#### *IV.2.3. Defining the relevant market*

Logically, before an undertaking can be seen as dominant, the relevant market has to be defined. If no market exists, then the rules governing dominant positions are impossible to apply. A proper guidance tool in the definition of the relevant market is the Commission Notice that was set up to this exact purpose.<sup>104</sup> It divides the definition in a criterion concerning the relevant product market, and in one concerning the relevant geographic market.<sup>105</sup>

##### *IV.2.3.1. The relevant products market*

The relevant product market defines which goods or services exert competitive pressures between certain entities. It builds the foundation for assessing whether one of these entities is a dominant undertaking.<sup>106</sup> The matter boils down to a question of the relevant characteristics and intended use of the specific product, as well as the degree of interchangeability between that and similar products.<sup>107</sup>

For a preliminary concept of a market, a good starting point for assessing the structure is formed by elaborating on the characteristics. It provides insights on the technical comparability of the products on a market. To that end, the following first assesses the characteristics of the online search services, after which it elaborates on further existing comparability analyses as applied by the European Commission.

##### *IV.2.3.1.i. Characteristics of Search*

The classic way of analysing the relevant market focuses on the characteristics and intended use of the product alone.<sup>108</sup> However, predominantly judging merely on those aspects could lead to a too broad definition of the market, as products that share general characteristics can be part of different

---

<sup>102</sup> ECJ, Case 322/81 of 09 November 1981, *Nederlandsche Banden-Industrie Michelin & French Republic v European Commission* (Michelin), ECLI:EU:C:1983:313, par. 57. Also joined Cases C-395/96 P and C-396/96 P of 16 March 2000, *Compagnie Maritime Belge Transports e.a. v Commission*, ECLI:EU:C:2000:132, par. 37.

<sup>103</sup> See all standing case law on the dominant position summed up in the ECJ, Case C-209/10 of 27 March 2012, *Post Danmark A/S v. Konkurrencerådet*, ECLI:EU:C:2012:172, paras. 21-24.

<sup>104</sup> Commission Notice on the Definition of the relevant Market for the Purposes of Community Competition Law, 1997, *OJ* C372/3.

<sup>105</sup> *Idem*, p. 5, paras. 7-8.

<sup>106</sup> A. Jones & B. Sufrin 2012, p. 293.

<sup>107</sup> *Idem*, p. 63-65; ECJ, Case 6/72 of 21 February 1973, *Europemballage Corporation and Continental Can Company Inc. v Commission of the European Communities* (Continental Can), ECLI:EU:C:1975:50, par. 32; *HLR* case, par. 28; *Michelin* case, par 37.

<sup>108</sup> A. Jones & B. Sufrin 2012, p.75.



markets, yet fall under the same categorization.<sup>109</sup> Also, the Commission regarded this method to be inadequate in demonstrating actual demand substitutability.<sup>110</sup>

From the end user or searcher perspective, the service of the firms in question is the provision of an online search engine. Essentially and more specifically, the characteristics are the categorization and display of online search results, as well as the artificial intelligence with which the engine responds to entered queries. It is logical that end users want to find relevant web content through search engines, and receiving utmost precise and relevant results. Hence, logically reasoned, competition for customers entails competition for the most sophisticated search engine algorithm.

The mentioned relevant search services can be horizontal as well as vertical. However, the latter services are also offered by innumerable, smaller suppliers: from news sites, forums, to general web portals, each web site moderator can employ a searching method on specific intranet web pages for instance. Whereas, general, horizontal and vertical web crawlers are only capable of accessing a website's homepage, yet do not have the access rights (as digitally granted by a system or network moderator) to further investigate the website in question, these typical vertical search services are only offered with respect to one domain or a restricted number of domains.<sup>111</sup> From a demand-side characteristics perspective, therefore, the definition of the market in this sense would become too broad if it only incorporated vertical search. See diagram 14 for a graphical distinction between horizontal and vertical search services.

---

<sup>109</sup> *Ibidem.*

<sup>110</sup> Commission Notice on the Definition of the relevant Market for the Purposes of Community Competition Law, 1997, *OJ C372/3*, p. 10, pt. 36.

<sup>111</sup> For instance, an internet search engine is incapable of indexing no pages on *nestor.rug.nl*, apart from those which are accessible through a guest account.

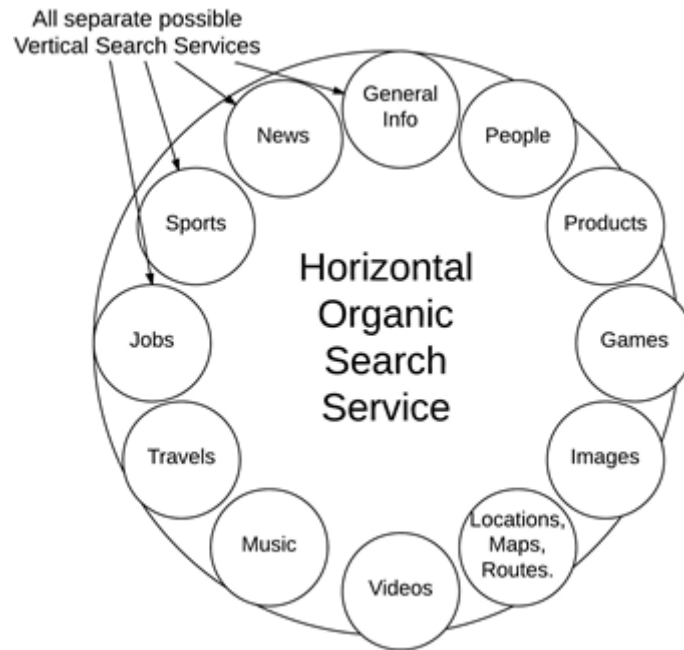

Diagram 7. Distinction between Horizontal and Vertical Search Services.

However, and this relates to the other criterion for assessing the relevant services market, the demand by end users is strongly linked to the other sides of the multi-sided platform, *viz.* websites and advertisements.<sup>112</sup> These network effects affect the market definition, as without one of the sides, the entire service will and cannot be provided as is. Stated more explicitly, with regard to the interchangeability of the search service, the demand by searchers is dependent on the number of indexed websites and the number of advertisers.<sup>113</sup> For instance, a search engine with an index of only one website would not attract queries, hence, would not attract advertisers. Similarly, an engine with one interested advertiser would neither make it financially worthwhile to supply search services to the masses without concordant payment, nor make it attractive to easily search for or find lucrative deals. The former indicates that the end user or searcher perspective alone is insufficient for a complete and correct market analysis. As such, a market analysis that incorporates network effects is to be applauded.

Moreover, considering Google has employed an auction-based pricing strategy, the price-setting is accomplished by participants on the advertising side themselves, and it is therefore up to the bidding results of the auctions which price is decisive for a particular query. It might be the case that Google, by supplying this service to advertisers, has distinguished itself in this sense from potential competitors, yet it adds to the intertwinement of the platform market, making it more difficult to legally regard the services as separate.<sup>114</sup>

Both in the crawling and indexing of websites, the organization and display of search results, and the manner of advertising, this horizontal-vertical distinction exists. As mentioned in the previous chapter, horizontal crawlers search for general links, which are in turn utilised by a general, horizontal search query in order to deliver general search results, receiving generalised advertising. Therefore, on the basis of the three-sided characteristics of online search, we can define the market

<sup>112</sup> See the Google platform diagram, nr. 5. Also, *infra*, par. IV.3.4.2. for the approach of the Commission and Court of Justice of the EU on this point.

<sup>113</sup> Cf. Noel, Michael D. and Evans, David S., “Analyzing Market Definition and Power in Multi-sided Platform Markets”, SSRN paper, 21 October 2005, p. 38-39, available online at <dx.doi.org/10.2139/ssrn.835504> (accessed 18 September 2014)

<sup>114</sup> Cf. *infra*, par. IV.3.3.

from a consumer perspective as being the provision of an indexing, search and advertising service, both in both horizontal as vertical dimension.

#### *IV.2.3.1.ii. Demand-side substitutability*

The second aspect in order to mark the boundaries of the market is a form of substitutability analysis. To this end, not only characteristics are used, but also economic tests that establish the matter of demand side substitutability or elasticity. The main formula that tests this is the SSNIP-test, involving a small but significant nontransitory increase in price, also known as the hypothetical monopolist test.<sup>115</sup> When the price of product X is raised by 5 or 10%, it can be measured to what extent consumers will revert to product Y. As will be shown, such an analysis is difficult for the market in which Google is active, because a predefined or fixed price for the mentioned service in the market does not exist. Until now, no online search service has ever been provided against payment: all providers have found financing through other means. This would make a SSNIP-like test difficult to apply. Nevertheless, in the following, the possibility of applying the SSNIP in a different form will be argued, either by pricing search or by changing the pricing strategies.

#### *IV.2.3.1.iii. Pricing search*

Introducing a direct price for search will likely expose a high demand elasticity of the platform. For instance, if searchers would have to pay even a really small, fixed price per search, the logical effect would be that a huge amount of searchers would move away from the engines in question and choose either different ones (those not incorporated in the market definition on the basis of characteristics) or choose other methods of finding online information. Indeed, indicating a high degree of substitutability between services would be a correct formulation of the market. Nevertheless, considering the direct price on search for all parties having been zero from its inception onwards, it entails a market in which the price is not an element of competition. Therefore, pricing search by ways of cross-elasticity would not be a suitable way of assessing the market.

Because of the free supply of online search, no new supplier of these online services has considered changing to a paid service.<sup>116</sup> The effect such a change would have on consumers can and likely will have a detrimental effect on the traffic the engine will experience. Also, as indicated before, the number of customers, on one side, affects the demand of customers on the other side of the network. However, not only would a price on search deter a large number of customers from using online search, the rebounding effect of a declining interest of advertisers in the search engine would have a downward spiral effect on the demand for users of the search engine altogether; such would, then, render an analysis along these change of price methods completely insufficient, as the intrinsic connection between one customer side and the other is not taken into account with the SSNIP test.

Furthermore, the effect of price increases on (online) advertisers is not clear. This issue has been acknowledged, before, by the Commission with regard to Google in the online advertising business.<sup>117</sup> In the Google/Double Click merger Decision, the EC unequivocally stated it remained unclear to what extent online advertisers are affected by a price change, and continued with an investigation of the characteristics and more reasoned substitutability of the various online ads, utilizing respondent surveys.<sup>118</sup> The current investigation of the Google practices might indicate similar difficulties, as the commitments made by Google have been published on the Commission's

---

<sup>115</sup> S. Bishop & M. Walker, p. 111 ff.

<sup>116</sup> There are examples of multi-sided platform markets, in which operators of the platform decided to change the pricing policy, introducing a price for one side of the platform at the benefit of the other, e.g. of RealNetworks in T. Eisenmann, G. Parker & M.W. Van Alstyne, "Strategies for Two-Sided Markets", *Harvard Business Review*, October 2006, p. 100-101.

<sup>117</sup> Commission Decision of 11 March 2008, case No M.4731, *Google/DoubleClick*, C(2008) 927 final.

<sup>118</sup> Commission Decision of 11/03/2008, case No M.4731, *Google/DoubleClick*, pt. 44-56.

web site, yet a thorough market analysis or any substantive decision as to the search engines market remains forthcoming.<sup>119</sup>

If the indirect pricing method of the platform itself is considered, this would have a similar detrimental effect. An indirect increase in the price of search would entail either charging a higher price for advertising or increasing the available slots per search, making more advertisers pay. The idea behind Google's auction-based second pricing mechanism is to stimulate competition amongst advertisers. Scarcity in the number of available slots not only fuels higher prices that advertisers are willing to pay, but also ascertains a higher chance of success for luring in customers. More choice for consumers, in this sense, means fewer clicks on the individual links, hence generating less revenue, and so, not necessarily raising the price of search. Also, the question remains whether an increased number of (neatly displayed) advertisements next to the search results effectively deters customers.<sup>120</sup> Hence, with the similar feedback mechanism as mentioned in the previous paragraph, this would advance a declined inclination of advertising online and would not assess the genuine demand substitutability for search engines.

All in all, the SSNIP or critical loss analysis is not an apt mechanism to define substitutability of this service in this market. As rightfully mentioned by Jones and Sufrin, "if critical loss analysis is applied in the usual way it leads to the (incorrect) definition of excessively narrow markets".<sup>121</sup> This, of course, does not mean that a user does not encounter any form of price, when using a search engine. The amount of information that an individual user, by simply seeking and accessing certain web pages, supplies to the engines in whatever manner, might form a impair the popularity of the engine. An engine that purports itself as a fully privacy-safeguarding search service provider might have a competitive advantage over the ones that store aggregated or personalized data. However, for competition law purposes, these effects are difficult to be measured.<sup>122</sup>

As proposed by various authors, a different interchangeability test should therefore be applied, in order to prevent assessing these markets on characteristics and intended use alone.<sup>123</sup> In other words, currently, the market as concerns the demand side substitutability can only be assessed on the basis of the characteristics and intended use of search engines.

#### *IV.2.3.1.iv. Bishop and Walker analysis*

In general, without disrupting the division in demand-side and supply-side substitutability, Bishop and Walker make several remarks as to the antitrust scrutiny for two-sided markets. They warn for the all too quick conclusion that two-sided markets need a different appraisal compared to the current competition law market share analyses.<sup>124</sup>

The authors provide, *inter alia*, the example of supermarkets. They argue them as being two-sided markets, yet which are subjected to general antitrust scrutiny.<sup>125</sup> The definition given to MSP's in this article, however, differs from the one adhered to by Bishop and Walker. A supermarket, according to Bishop & Walker is defined as a two-sided market, solely because of network effects: the more suppliers provide products to a supermarket, the more customers would be interested in visiting the store. In turn, that would have positive influence on new suppliers. Nevertheless, no form

<sup>119</sup> To the annoyance of scholars, see e.g. P. Ibáñez Colomo, "Exclusionary Effects in Google: Are They Relevant at All for the Outcome of the Case?", *Chilling Competition* blog entry, 30 December 2013, available online at <[chillingcompetition.com/2013/12/30/exclusionary-effects-in-google-are-they-relevant-at-all-for-the-outcome-of-the-case/](http://chillingcompetition.com/2013/12/30/exclusionary-effects-in-google-are-they-relevant-at-all-for-the-outcome-of-the-case/)> (accessed 18 September 2014).

<sup>120</sup> Or advertisers, for that matter, See the Google/Double Click Merger Decision, pt. 44-56.

<sup>121</sup> A. Jones & B. Sufrin, *EU Competition Law*, 4<sup>th</sup> ed., Oxford, OUP 2011, p. 81.

<sup>122</sup> Factors to take account of in that sense are not only the relationship between the demand for search services and the amount of specific personalizing data, but also the elasticity between it.

<sup>123</sup> D.S. Evans & M. Noel, "Defining Antitrust Markets when Firms Operate Two-Sided Platforms", *Colum. Bus. L. Rev.*, vol. 667, 2005, p. 694-695.

<sup>124</sup> S. Bishop & M. Walker, *The Economics of EC Competition Law: Concepts, Application and Measurement*, London, Sweet & Maxwell, 2010, p. 93.

<sup>125</sup> *Idem*, p. 95.

of horizontal relationships is being established by the supermarket. A customer of a supermarket is not enabled to directly negotiate with the supplier of a certain product.<sup>126</sup> For instance, on the credit card market, a customer is able to directly execute a payment to a merchant via the card; a slightly more obscure example, on OS markets, it is possible for end users to exchange software or build software for the OS and trade it via the OS. These are enabled direct relations, for which a supermarket does not provide.<sup>127</sup>

Outside of this element, the network effects displayed by supermarkets are not that strong. Every marketplace entrant or supermarket exploiter experiences space constraints. As a consequence, only up to a certain extent, products can be varied or increased in number. Especially with internet businesses, the possible relations that can be established extend to immensely larger proportions, amounting to significantly intensified network effects.

Hence, the statement might be true that one should not think too quickly that any encountered two-sided market demands a separate analysis, and that the general rules do not apply. Nevertheless, the main concern in the argument made by Bishop and Walker does not seem to lean so heavily on the application of the competition law rules, but more on what exactly constitutes a genuine two-sided market. Therefore, it is logical that Bishop and Walker mention the regular application of competition law to supermarkets, because these are no real two-sided markets.<sup>128</sup>

Considering the argument, however, falling short on substantive evidence, it seems that two-sided markets are in need of a separate or new competition law analysis and framework. In order to find out if, for the market for online search, this is the case, the research here progresses by elaborating on the supply side perspective, from the view of the platform operators that provide the search services.

#### *IV.2.3.1.v. Supply-side substitutability - barriers to entry*

Whereas the emphasis generally is laid on the demand side substitutability, the supply-side substitutability can be a complementing analysis so as to properly define the market.<sup>129</sup> Separately from the demand side substitutability, new entrants next to the existing engines could be willing to start providing the same or similar services on the market. In order to establish which online services act as substitutes for firms, several barriers to entering the online search market are relevant.

The particular issues for this criterion are that for new entrants, the proverbial ‘chicken-and-egg’ problem arises, as well as that a high degree of particular technical knowledge and expertise is demanded, leaving aside even the significant financial investments that have to be made. The willingness of new firms to enter this particular market are quite dependent on these hurdles, hence, turning them into true potential barriers to entry exist.<sup>130</sup>

As established, most search services are embedded on a particular website, such as a news channel’s website, a legal magazine or an online forum. The hurdles for a supplier of small-scale, often vertical, search engine to becoming a horizontal search engine might seem small. With respect to necessary coding knowledge, it might not seem difficult to expand the former search services to a larger online community, as essentially any search engine has an indexed database of all located files, a separate catalogue that both places the indexed pages in an order as well as stores all search

---

<sup>126</sup> Also, a physical store is limited in space, whereas a digital platform such as an operating system can offer a substantial amount of software. The same goes for the online search platforms, indexing the entire web, an amount of information that no library on earth currently could give space to.

<sup>127</sup> Also, considering the aforementioned over-inclusiveness of the definition, if a supermarket would be included in the category, any grocer would become a two-sided market, as well as every physical marketplace – the more suppliers for a grocer, the more interested customers and vice versa; the more grocers on a market, the more it would attract customers and vice versa.

<sup>128</sup> L. Filistrucchi, D. Geradin, E. van Damme, “Identifying Two-sided Markets”, TILEC Discussion Paper DP 2012-008, 21 February 2012, p. 3 & 8 and references, available online at <ssrn.com/abstract=2008661> (accessed 18 September 2014).

<sup>129</sup> *Continental Can* case, paras. 34-36.

<sup>130</sup> Cf. R. O’Donoghue & A.J. Padilla, *The Law and Economics of Article 82 EC*, Oxford & Portland, Oregon, Hart Publishing 2006, p. 117

requests, and an algorithm/formula that matches the query with the results. However, the platform has to engage on a massively larger scale, and would have to take account of various other factors if it is willing to compete effectively with existing engines. Both with respect to needed infrastructure, as well as specific knowledge of formulating intricate algorithms, large investments are necessary – also considering the velocity with which the industry is moving – and can form quite an obstruction for entrants.

In order to become a separate search engine, these smaller engines would need separate web space, a proper domain and URL, a new web application, and necessary stable infrastructure that allows for the efficient handling of more data traffic. When the difference between offline and online cataloguing services are considered, the argument can be raised that for web service providers a large portion of this infrastructure and of these elements has already been accomplished. For remoter services, such as various offline library or cataloguing services, the financial hurdles could be seen as more substantial, rendering those services insufficiently substitutable for Web search engines.

The specific knowledge and infrastructural requirements have been mentioned for larger firms, in order to immediately become established as a significant engine. Nevertheless, the same essentially applies for anyone: the specific coding knowledge might be available online, often even actively facilitated by the larger market participants,<sup>131</sup> but it does not imply that it is easy to start an online web search engine. It demands computational power, a great deal of data storage potential, as well as numerous stable connections.

Contrastingly, the established online search engines provide specific vertical search services outside of their own online services. For instance, Yahoo, Bing and Google provide physical mapping services of the entire world or significant parts of them, even as close as street level.<sup>132</sup> Also, the engines provide small-scale, domain-based vertical search services as well.<sup>133</sup> Several larger websites, forums etc. have a search function that utilises indexing methods by one of the larger global search engines. Moreover, Google is known to even ‘enhance’ another broad organic search engine, America Online (AOL).<sup>134</sup> Hence, it appears to be a form of vertical integration that is possible for larger corporations, yet reality has not provided examples in which it happened the other way round.

Apart from existing competitors having deep pockets, and despite several structural algorithm updates having been published, a new entrant will also encounter various potentially crucial patents, regulatory barriers, such as Google’s pivotal PageRank. Also, a large degree of uncertainty relating to the competition’s engines and algorithms still remains intact. Not only is it alleged that, for instance, Google updates its algorithms 500 to 600 times a year,<sup>135</sup> many of the (200) factors incorporated in its search algorithm remain undisclosed. Any form of reverse engineering for competitors is, therefore, highly complicated, making competition constantly susceptible to change and innovation.<sup>136</sup> This would significantly rule in favour of Google’s practices, and the search engines industry in general.

---

<sup>131</sup> Various updates on Google’s algorithms have been published online, such as Google Panda, and Google Hummingbird, e.g., Moz.com, “Google Algorithm Change History”, available online at <moz.com/google-algorithm-change> (accessed 18 September 2014).

<sup>132</sup> Yahoo Street Level, <help.yahoo.com/kb/index?locale=en\_US&y=PROD&page=content&id=SLN15940>, Google Streetview, <instantstreetview.com> and Bing Streetside, <microsoft.com/maps/streetside.aspx> (accessed 18 September 2014).

<sup>133</sup> As, e.g., is powered by the Google Custom Search Engine, <google.com/cse/>.

<sup>134</sup> See the “enhanced by Google Search” on AOL.com, e.g., <search.aol.com/aol/search?query=Example> (accessed 18 September 2014).

<sup>135</sup> E.g., Google Inc., “Facts about Google and Competition”, available online at <google.com/competition/howgooglesearchworks.html>, and SEOmoz, “Google Algorithm Change History,” available online at <moz.com/google-algorithm-change> (accessed 18 September 2014).

<sup>136</sup> P. Iyer & B. Courtney, “Google: Online Search & the Battle for Clicks”, *Sloan Fellows Program in Innovation & Global Leadership* paper, 1 May 2005, p. 5, available online at <dspace.mit.edu/bitstream/handle/1721.1/56570/15-912Spring-2005/OcwWeb/Sloan-School-of-Management/15-912Spring-2005/Projects/index.htm>. See also Speech

Therefore, to only a small extent, other service providers can or are willing to switch so as to become an online search engine and vice versa; such would seem to enlarge the defined market to a small extent. Nevertheless, other barriers to entry, for instance *switching costs*, have a say in the full supply-side substitutability. In essence, switching costs are factors to be taken into account with demand-side substitutability,<sup>137</sup> yet they are also convenient when it comes to assessing the market from a supply-side perspective. As mentioned by the Market Definition Notice of the EC, if substantial obstacles to switching demand exist, “the Commission will not consider two *prima facie* demand substitutes as belonging to one single product market”.<sup>138</sup>

#### IV.2.3.1.vi. *Is competition one click away?*

“If our users don’t like what we’re doing, they can easily switch to a competitor with just one click. We think users should be able to move their personal data to competing services, and we take measures to earn our users’ loyalty by building good products and continually improving them, not by locking in users artificially.”<sup>139</sup>

This statement on one of Google’s websites makes it seem as though competition for a majority of the customers is not only facilitated by engines, but is also actively pursued by consumers. The ability to switch to a competitor incorporates both concepts of potential and actual competition. It implies the idea of *switching costs* for consumers. If it is extremely difficult or economically disadvantageous to switch from one search engine to another, consumers might not be inclined to switch. Hence, it would become unattractive for a newcomer to enter the market, since the clientele is ‘locked’ in.<sup>140</sup> At the same time, the adagio states that the only cost for a customer to switch would be a single click: if that holds true, it would amount to nearly naught costs, and make the market highly volatile and more lucrative for new entrants.

First of all, it holds true that all search engines facilitate the direct finding of the competitors.<sup>141</sup> A simple entered query and a click is essentially all it takes for an end user to locate and use a competitor’s services. Therefore, the possibility for a customer to switch is not actively impeded by any competitor; however, other forces are at play that could impede or prevent actual switching.

Whereas the mentioned costs are focused on the customer or consumer, if he or she is locked-in, this would also affect new competitors, making it a barrier to entry. In online search, the foremost consumer-related barriers to entry involve the existence of network effects. As the formulated algorithms enable a constantly evolving (and potentially self-improving) searching experience, consumers will keep benefiting directly from using one engine only. The likeliness of finding the correct result is decreased whenever customers switch, which is why network effects are also called demand-side economies of scale.<sup>142</sup> Switching customers would therefore not only be detrimental to the improvement of an online search engine service, but also to that individual user’s experience.

---

by EU Commissioner for Competition J. Almunia, “The Google antitrust case: what is at stake?”, Speech, Brussels, 1 October 2013, SPEECH/13/768, p. 3, available online at <europa.eu/rapid/press-release\_SPEECH-13-768\_en.htm?locale=FR> (accessed 18 September 2014).

<sup>137</sup> Considering for instance the placement in A. Jones & B. Sufrin 2012, p. 72.

<sup>138</sup> EC Notice on the Definition of Relevant Market for the Purposes of Community Competition Law, OJ C372/03, pt. 42.

<sup>139</sup> Google Inc., “Competition is one click away – and we make it easy to switch”, available online at <google.com/publicpolicy/issues/competition.html> (accessed 18 September 2014).

<sup>140</sup> R.G. Harris, “The Role of Switching Costs in the Markets for PC Operating Systems, Online Search, Internet Access and Mobile Service: Implications for Australian Competition and Consumer protection Policy”, *Competition in the Online Environment paper*, Melbourne Business School, 28 November 2012, p. 5, available online at <works.bepress.com/Robert\_g\_harris/5> (accessed 18 September 2014). See also, A.E. Edlin & R.G. Harris, “The Role of Switching Costs in Antitrust Analysis: A Comparison of Microsoft and Google”, 15 *Yale J.L. & Tech.* 169, Spring 2013, p. 176 ff. For clarity, both researches have been financed by Google Inc, yet the opinions are the authors’.

<sup>141</sup> Any query carrying the name of a competitor will result in a top hit designating the website of that competitor.

<sup>142</sup> M.L. Katz & C. Shapiro, “Technology Adoption in the Presence of Network Externalities”, *Journal of Political Economy*, vol. 94, no. 4, August 1986, p. 824. See also R.A. Posner, “Antitrust in the New Economy”, John M. Olin

It might be that the consumer has insufficient knowledge of such technological developments, as the changes in experience are gradual and minor.<sup>143</sup> This could, therefore, limit network effects; however, this unawareness can be connected to the fact that the bulk of searches are basic, short queries which often simply pertain to the name of a particular website, such as “Facebook” or “Yahoo!”<sup>144</sup>. For this substantial bulk of non-complicated queries, consumer inertia has an impeding effect on competition, as there is no logical reason to switch to a different or new search engine, when the former delivers exactly the same results. By and large, such affirms the network effects and raises switching costs.

However, the term “switching” in this sense might not be wholly appropriate, because switching seems as if a customer abandons one provider and fully opts for another. Especially in markets of these and other freely accessible web services, users are prone to using more than one engine simultaneously. It is an effect that is often described as *multi-homing*, a term originally used in IP-computing theory, to define a network or system being connected to two or more separate internet providers: in case one of those connections failed, the other would still be running, hence making it possible to remain connected and continuously reachable.<sup>145</sup> The same is the case for the search platform market, and for various other MSP markets, such as for credit cards and OS software.<sup>146</sup>

Multi-homing is generally associated with network effects.<sup>147</sup> The latter will be strengthened, in absence of the former. The association has everything to do with interoperability. For instance, individual telecommunication networks experience decreased network effects, when end user A, for the same price, can reach both end user B on the home network, and C on an external network, which is exploited by a different provider. With regard to connectivity, it does not matter for any of the customers which network to choose, as all can reach one another. The interoperability between the multiple networks hence decreases the positive influence any network individually has on customers. This means that being active on more than one network is detrimental to active participants on either network, provided that both are equal in size.<sup>148</sup> Interoperability decreases multi-homing costs, yet multi-homing decreases network effects.<sup>149</sup>

Indeed, the aforementioned argument that search engines facilitate searching for and finding of competitors counts in favour of low multi-homing costs for end users. Also, there appears to be evidence that customers actually are multi-homing.<sup>150</sup> Moreover, on every search engine, any competitor is shown as top result, meaning every search term for the competition, upon request, inevitably leads to the competition. On top of that, no financial barrier to switch is imposed on an end user. Therefore, in theory at least, barriers between competitors do not appear to exist; such

---

Law & Economics Working Paper No. 106, November 2000, p. 3, available online at <ssrn.com/abstract=249316> (accessed 18 September 2014).

<sup>143</sup> Whether a consumer is inclined to use a search engine more when he or she knows that the searching experience will improve with continuing use is uncertain, so full benefits are possibly not always derived.

<sup>144</sup> See the Google Trends depicting, *inter alia*, Facebook, Youtube, Google, Hotmail & Yahoo as top searches throughout, generated from January 2004 until January 2014 at <google.com/trends/explore#date=1%2F2004%2012m&cmpt=q> (accessed 18 September 2014).

<sup>145</sup> E.g., T. Hau, D. Burghardt & W. Brenner, “Multi-homing, content delivery networks, and the market for Internet connectivity”, *Telecommunications Policy*, vol. 35, nr. 6, July 2011, p. 532–542.

<sup>146</sup> People generally have several bank cards, or have a computer and a video game console.

<sup>147</sup> See generally, M.L. Katz & B. Keating, “Network Effects, Switching Costs, and Competition In Unified Communications”, Cisco Systems Inc. commissioned paper, November 5 2012, available online at <newsroom.cisco.com/documents/10157/1142732/Katz\_and\_Keating\_on\_Compatibility\_Competition\_UCC.pdf> (accessed 18 September 2014).

<sup>148</sup> A larger network would still be more interesting for the majority of users and new customers, having a possibility of becoming the largest fairly quickly, so-called market tipping towards one undertaking.

<sup>149</sup> Interoperability will be further discussed, section 3.2.6.7.

<sup>150</sup> M.L. Katz, “Network Effects and Switching Costs in Online Search”, University of Berkeley Powerpoint slides, talk of 16 June 2011. Nevertheless, in this talk, he equals search engines that I refer to as generalized online search engines to other vertical search-related engines, such as Facebook (search for individuals), Expedia (search for travels) and Amazon (search for products).



would then also point towards a highly volatile market. This will be further covered in the part covering dominance under Art. 102 TFEU.

Some final remarks which will also return in the section on dominance, concern first the currently strong affection that large online search engines show towards introducing new services and integrating these in the main service.<sup>151</sup> This is a phenomenon described by Richard Posner as the New Economy, in which established services, in order to remain competitive, are linked to new services, reinforcing the potentially dominant position of the main service. For instance, if a consumer were to switch completely from Google to another service provider, the specific services/products he would miss are for instance accounts (for storage, or for e-mail), the indexed database, the historically built-up, personalised data information of the searcher, therefore the entirely personalised searching experience it might not have at the competitor's.

Secondly, high-technology markets such as the one Google is active on are known to 'tip' towards one undertaking or platform.<sup>152</sup> This usually means that consumers grow aware of one undertaking being the most developed, and choose to adopt its technology.<sup>153</sup> For instance, the search engine market in the EU seems completely swamped by Google's influence, whereas the US market displays a more dispersed image, with other competitors.<sup>154</sup> Therefore, consumers are prone to inertia, and freely locking themselves in. Various reasons are possible, since numerous non-price related switching costs are possible to be applied in the generalised online search industries.

#### *IV.2.3.1.vii. Conclusion on the relevant product market*

Regarding the difficulties in exactly defining the relevant market for MSP firms such as Google, competition law agencies also appear to be in a quandary. A more economic and thorough manner of assessing a market would be preferred, yet is not consistently applied. This 'more economic approach' by the European Commission is generally associated with a more consumer welfare-oriented method. It judges the effects of conduct by undertakings, instead of merely focussing on the static market definitions. Also, academics are not unison on whether or not such a static market analysis should be applied at all.<sup>155</sup>

Still, to give the following some footing, it is appropriate to define the market as narrow as the following. Optimally, the definition of the relevant market incorporates the horizontal or generalised tracing/crawling, caching, and indexing of websites, the display and generation of search results on the basis of entered queries in an online application that provides for adjacent advertising.

On the basis of these characteristics, it is possible to distinguish this market from various vertical search providers, such as Facebook, Expedia, or MapQuest. Also, it distinguishes this market sufficiently from the numerous smaller intranet (vertical) search service providers, from cataloguing

---

<sup>151</sup> A. Jones & B. Sufrin 2012, p. 79.

<sup>152</sup> A. Gawer & M.A. Cusumano, "How Companies Become Platform Leaders", *MIT Sloan Management Review*, 01 January 2008, p. 28 & 32, available online at <[sloanreview.mit.edu/article/how-companies-become-platform-leaders](http://sloanreview.mit.edu/article/how-companies-become-platform-leaders)> (accessed 18 September 2014).

<sup>153</sup> J. Farrell & P. Klemperer, "Coordination and Lock-In: Competition with Switching Costs and Network Effects", Chapter 31 in: M. Armstrong & R. Porter, eds., *Handbook of Industrial Organization*, vol. 3, Elsevier 2007, p. 1975. In another sense, consumers might be inert of the 'better' product or competitor, but massively choose one particular undertaking. Known examples for this are the QWERTY keyboard, and VHS and Betamax tapes, see F. Zhu and M. Iansiti, "Entry into Platform-based Markets", *Strategic Management Journal*, vol. 33, 2012, p. 100, 102. Bishop & Walker 2010, p. 95, and Farrell & Klemperer 2007, p. 2028-2029.

<sup>154</sup> See, e.g., the statistics generated on <[gs.statcounter.com/#search\\_engine-eu-yearly-2008-2013-bar](http://gs.statcounter.com/#search_engine-eu-yearly-2008-2013-bar)>, which statistics are based on aggregate data collected by StatCounter on a sample exceeding 15 billion page views per month collected from across the StatCounter network of more than 3 million websites.

<sup>155</sup> E.g. E. Arrezzo, "Is there a Role for Market Definition and Dominance in an effects-based Approach?" in: M. Mackenrodt, B. Conde Gallego & S. Enchelmaier, eds., *Abuse of Dominant Position: New Interpretation, New Enforcement Mechanisms?* Berlin, Springer-Verlag 2008, p. 47-49; see also, D. Guellec, B. van Pottelsberghe de la Potterie, & N. van Zeebroeck. "Patent as a Market Instrument", Chapter 4 in: D. Guellec & B. van Pottelsberghe de la Potterie, eds., *The Economics of the European Patent System. IP Policy for Innovation and Competition*, Oxford, OUP 2007, p. 95.

and information organizing entities, such as physical libraries or printed encyclopaedia, and from other ‘offline’ data centres, for instance multiple advertisement supported data carriers (TV and Newspapers). Even though for both end users and hypothetical competitors, these and other service could be considered as substitutes for the services on this market, they are sufficiently separated from it. From here onwards, the entities active on the market will, therefore, be referred to as either “horizontal online search engines (HOSEs)” or “generalised online search engines (GOSEs)”. Nevertheless, before allocating market shares to the entities concerned, the entities should be designated by ways of the relevant geographic market.

#### *IV.2.3.2. The relevant geographic market.*

The second element of the market definition relates to its geographic scope. The Commission Notice states on this the following: '[t]he relevant geographic market comprises the area in which the undertakings concerned are involved in the supply and demand of products or services, in which the conditions of competition are sufficiently homogeneous and which can be distinguished from neighbouring areas because the conditions of competition are appreciably different in those area'.<sup>156</sup> For horizontal online search engines, the market is operational on a worldwide scale, not only because the mentioned engines are reachable from all over the world, but are also utilised in every part of the world.

In various parts of the world, other GOSEs are active that would match the criteria as set above, such as the Chinese Baidu, the Russian Yandex, or America Online. These, however, are not incorporated in this assessment, because they compete only on their respective territory with the worldwide search engines. As a consequence, the following competitors can be defined: Yahoo! Search, Microsoft’s Bing, and Google Search, as these all operate on a global scale.

### **IV.3. Is Google Inc. dominant?**

The case law explained in par. IV.2.2. seems to elucidate the concept “dominance” in quite elaborate sentences. Nevertheless, these generally do not serve as a handle for assessing dominance in every Article 102 TFEU case. Despite the rulings, dominance is regarded as “nebulous”<sup>157</sup>, “not self-explanatory”,<sup>158</sup> and even interpreted as impossibly to be proven definitively by competition authorities or by private parties.<sup>159</sup> As a consequence, competition authorities and legal academics in the literature devised their own methods for grappling with this concept. Below, five of these will be described and discussed, not in the first place to draw a benchmark with which the remainder of the research is compared, but also to exemplify the disunity among the various authors and the general legal uncertainty for potentially dominant companies. The latter will be elucidated further in the subsequent sections, concerning the difficulty on allocating market shares in online search, as well on various barriers to entry. A scrutiny of, *inter alia*, network effects, multi-homing, and interoperability, as discussed in chapter III, will return in that section on the assessment of dominance in the case-law of the EU.

#### *IV.3.1. Five perspectives on dominance.*

First, the European Commission in its Enforcements Priorities Guidance Communication puts heavy emphasis on the ability to raise prices.<sup>160</sup> It opens the section on the assessment of dominance,

---

<sup>156</sup> Commission Notice on the Definition of the relevant Market for the Purposes of Community Competition Law, 1997, *OJ* C372/3, par. 8.

<sup>157</sup> A. Jones & B. Sufrin 2012, p. 286

<sup>158</sup> R. Nazzini 2012, p. 329.

<sup>159</sup> Bishop & Walker 2010, p. 233.

<sup>160</sup> European Commission, Guidance on the Commission’s Enforcement Priorities in Applying Article 82 of the EC Treaty to Abusive Exclusionary Conduct by Dominant Undertakings, 2009 *OJ* C45/7 (Guidance on enforcement priorities), par. 9-15. The Notices and Guidelines etc. are not authoritative interpretations, but regarded as soft law,

designated as “Market power”, with the reiteration of the standing law in *Michelin, UBC & HLR*.<sup>161</sup> It follows with the consideration that a dominant undertaking is one “which is capable of profitably increasing prices above the competitive level for a significant period of time.”<sup>162</sup> In short, the Commission regards the ability to change price as the prevailing interpretation for a dominant position.<sup>163</sup> Moreover, price is interpreted as shorthand for other factors of competition, such as output, innovation, variety or quality of products.

The second interpretation is given by Jones & Sufrin, who touch upon dominance fairly superficially: they regard that dominance is generally interpreted as “substantial market power which enables the undertaking concerned to profitably raise prices about (sic) the competitive level over a significant period of time.”<sup>164</sup> Substantial market power, further, is the ability to price above short-run marginal cost.<sup>165</sup>

As a third, Whish & Bailey read in the case law of the ECJ on a dominant position that dominance is equal to the economic concept of (substantial) market power.<sup>166</sup> Furthermore, earlier on in their book, they refer to market power, next to the *power over price*, as also including “other ways in which competition can be restricted, for example [...] limiting output, suppressing innovation, reducing the variety or quality of goods or services or [...] depriving consumers of choice, all of which are clearly inimical to consumer welfare”.<sup>167</sup> This seems to be derived directly from par. 11 of the Communication from the Commission Guidance Communication.

Fourth, Bishop & Walker depart from the same logic, by equating dominance with (significant) market power.<sup>168</sup> Their definition of market power, on the one hand, contains “the ability of a firm or group of firms to raise price, through the restriction of output, above the level that would prevail under competitive conditions and thereby to enjoy increased profits from the actions”.<sup>169</sup>

On the other hand, as opposed to *pricing* power, both authors tend to a different form of dominance, one which has received attention in US competition policy, namely *exclusionary* power.<sup>170</sup> The US Supreme Court in the case *US v. Du Pont* of 1956, stated that “monopoly power is the power to control prices or exclude competition”, and has since then been used as a test for dominance.<sup>171</sup> Krattenmaker, Lande & Salop turned these into two methods of anticompetitive power, namely “raising one’s own prices or raising competitors’ costs”.<sup>172</sup> Bishop and Walker find this second role also compatible with the ECJ rulings, regarding “the power to act independently” as being equal to “the notion of being able to exclude competitors”.<sup>173</sup>

---

rules of conduct of general application. See S. Lefevre, “Interpretative Communications and the Implementation of Community Law at National Level”, *ELRev* 2004, vol. 29, ed. 6, p. 809. See also A. Jones & B. Sufrin 2011, p. 114-115, and L. Senden, *Soft law in European Community Law. Its Relationship to Legislation*, Hart Publishing Ltd, Oxford 2003, p. 3.

<sup>161</sup> Guidance on enforcement priorities, par. 9-10.

<sup>162</sup> *Idem*, par. 11.

<sup>163</sup> A. Jones & B. Sufrin 2012, p. 290.

<sup>164</sup> *Idem*, p. 355. See also e.g. A. Coscelli & G. Edwards, “Dominance and Market Power in EU Competition Law Enforcement”, Chapter 8 in: I. Lianos & D. Geradin, eds, *Handbook on European Competition Law. Substantive Aspects*, Cheltenham, Edward Elgar Publishing Inc. 2013, p. 351-353.

<sup>165</sup> A. Jones & B. Sufrin 2012, p. 61.

<sup>166</sup> R. Whish & D. Bailey, *Competition Law*, 7<sup>th</sup> Edition, New York, Oxford University Press 2012, p. 180.

<sup>167</sup> *Idem*, p. 25. Nevertheless, the sources referred to do not account for this extended definition.

<sup>168</sup> Bishop & Walker 2010, p. 227. See also Whish & Bailey 2012, p. 180.

<sup>169</sup> Bishop & Walker 2010, p. 52-53.

<sup>170</sup> *Idem*, p. 91

<sup>171</sup> US Supreme Court, case 351 U.S. 377 of 11 June 1956, *United States v. E.I. du Pont de Nemours Co* (Cellophane), pt. 25: “Monopoly power is the power to control prices or exclude competition”.

<sup>172</sup> T.G. Krattenmaker, R.H. Lande & S.C. Salop, “Monopoly Power and Market Power in Antitrust Law”, *Geo. L. J.*, 1987-1988, vol. 76, p. 241

<sup>173</sup> Bishop & Walker 2010, p. 92.

The fifth and final perspective in this comparison is Nazzini's chapter on single dominance.<sup>174</sup> In it, he interprets the definition somewhat along the line of Bishop & Walker's *exclusionary power*, and he gives arguably the most comprehensive (and complex) view on the establishment of dominance under current EU Competition law. He describes two models by which he believes dominance is to be defined. The one he explains as a structuralist model, equal to substantial and durable market power, the other as a more behavioural, dynamic model, defining dominance "as the ability to harm competition".<sup>175</sup> The structuralist model he derives from the case law of *UBC, Hoffmann-La Roche* and of the Court of First Instance's (CFI) ruling in *General Electric*.<sup>176</sup> The behavioural model is the application by analogy of the ability to harm competition as used in non-horizontal merger cases to the concept of dominance in the abuse of dominance terminology.<sup>177</sup>

The distinction between these models is derived from the Court's teleological reasoning in its *United Brands* ruling.<sup>178</sup> However, despite him introducing them as separate models by which to assess dominance, Nazzini intertwines the models around the word "independently" in the ruling.<sup>179</sup> On the relationship, he states: "[t]he ability for a firm with no substantial and durable market power to harm competition is too remote a possibility to justify the risk of error and over-deterrence that the application of Article 102 to any firm with some degree of market power would entail. Many firms are capable of profitably increasing prices above the competitive level but would be unlikely to have the ability to harm long-term social welfare." In other words, it is necessary for applying Art. 102 TFEU that a threshold exists for grading market power. The "risk of error and over-deterrence" Nazzini mentions, refers to also known as Type 1 errors, or false positives.<sup>180</sup>

This reasoning links with the idea of introducing a more economic approach in the application of article 102 TFEU. To be in favour of this approach, which essentially consists of a consumer welfare-led effects-based analysis with respect to article 102 TFEU, would entail wanting to abandon static legal concepts and frameworks; antitrust should, instead, predominantly take account of (economic) *effects* of certain behaviour on a market in order to come to a prohibition.<sup>181</sup> Notably, effects in this sense entail the consequences of certain market conduct, and, therefore, 'effects-based' is also conduct-based, which would imply an abandoning of the concept of dominance, and focusing solely on abuse.<sup>182</sup>

Furthermore, this 'more economic approach', is regarded, on the one hand, as a potential solution to over-enforcement of competition rules and as a safeguard against type 1 errors.<sup>183</sup> On the other, however, as indicated by Nazzini amongst others, the approach might also cause exactly those same errors by only focusing on effects, which would make legal concepts such as dominance a necessary

---

<sup>174</sup> R. Nazzini, *The Foundations of European Union Competition Law: The Objective and Principles of Article 102*, Oxford, OUP 2013, chapter 10, p. 329-360. See also, M. de la Mano, R. Nazzini & H. Zenger, "Chapter 4: Article 102", p. 356 ff., in: J. Faull & A. Nikpay, eds. *The EU Law of Competition*, 3<sup>rd</sup> edition, Oxford, OUP 2012.

<sup>175</sup> *Idem*, p. 330.

<sup>176</sup> CFI, case T-210/01 of 14 December 2005, *General Electric Company v Commission of the European Communities*, ECLI:EU:T:2005:456. This article will account for the change in the Court structure, after the Lisbon treaty was enforced, re-establishing the CFI as the General Court.

<sup>177</sup> Non-horizontal mergers are generally directed by the EC Guidelines on the assessment of non-horizontal mergers under the Council Regulation on the control of concentrations between undertakings, *OJ* 2008/C 265/07.

<sup>178</sup> R. Nazzini 2012, p. 330-331.

<sup>179</sup> *Idem*, p. 344.

<sup>180</sup> A. Jones & B. Sufrin 2012, p. 59.

<sup>181</sup> See e.g. M. Kellerbauer, "The Commission's new enforcement priorities in applying article 82 EC to dominant companies' exclusionary conduct: a shift towards a more economic approach?" *ECLR*, vol. 31, 2010 ed. 5, p. 175-186.

<sup>182</sup> Economic Advisory Group on Competition Policy (EAGCP), "Report by the EAGCP - An economic approach to Article 82", 14-15 July 2005, available online at <[ec.europa.eu/dgs/competition/economist/eagcp\\_july\\_21\\_05.pdf](http://ec.europa.eu/dgs/competition/economist/eagcp_july_21_05.pdf)> (accessed 18 September 2014).

<sup>183</sup> R. Whish & D. Bailey 2012, p. 193-194.

filter.<sup>184</sup> Moreover, complex and time-consuming economic tests might not be workable for national competition authorities, as they experience budgetary constraints. This is then likely to lead to under-enforcement or type 2 errors, so-called false negatives.<sup>185</sup>

It could, therefore, be argued that there is no reason to change from predominant perspective in antitrust law, as the more economic approach, in one way or the other, results in the same potential errors.<sup>186</sup> The application of Art. 102 TFEU in the more economic sense or not, would then both lead to prevention of false positives, as well as false negatives. The relevance for the research at hand is that the above explains the disparity in interpretations that the law and case law gives rise to, and the various perspectives that researchers provide. These definitions embody the same ambivalence at which generally European competition law is applied.<sup>187</sup> And that might be problematic with regard to the rule of law on which the European Union is based, as well as to the climate for undertakings in the EU in general.<sup>188</sup>

Nevertheless, the effect of a lack of any strict interpretations of competition rules might be that potential dominant undertakings act more on their toes, in order not to infringe the rules. Fines are or can be extensive and the threat of being fined would amount to higher subservience to the law, whatever its contents may be.<sup>189</sup> This, for instance, might also explain the settlement culture that Google has taken with regard to various cases, for instance with the offered commitments the European Commission demanded from Google, without properly defining of what exactly it can accuse Google.<sup>190</sup>

#### *IV.3.2. Does pricing power determine dominance?*

Currently, the main interpretation on dominance attributes a strong role to an undertaking's influence on the price of the product.<sup>191</sup> This interpretation, however, seems to focus on those industries in which competition on price is more or less self-evident. In novel industries such as Google's, direct or fixed prices on provided services are next to impossibly attributable. They differ per query, per moment, per region, per advertiser and per so many other factors that are weighed in the ultimate establishment of the price, and essentially are not paid for by the search results themselves, but only for the clicks that sponsored search results deliver. Therefore, if competition law agencies wish to deal with these new industries, that basic notion underlying Art. 102 TFEU analyses should be reappraised. Especially with the Google platform, the focus on price or output does not seem to be the correct assessment method, and should therefore be abandoned.

Considering that the Court has not been so straightforward in its definition in *UBC*, authors or authorities that believe the above interpretation is the prevailing one as regards the assessment of dominance should all the more reappraise their definition. The manner, namely, in which in *UBC* the idea of acting independently of competitors, customers and consumers was introduced, is a broader one than merely interpretable as price-setting, output-reducing or innovation-controlling capabilities of a firm, which idea will be set out below.

---

<sup>184</sup> A. Jones & B. Sufrin 2012, p. 59, and A. Coscelli & G. Edwards, p. 353.

<sup>185</sup> M. Kellerbauer 2010, p. 176.

<sup>186</sup> A quote by Mae West, acting as the Frisco Doll in the 1936 movie *Klondike Annie* may be applicable, stating: "when I'm caught between two evils, I generally like to take the one I never tried."

<sup>187</sup> A. Jones & B. Sufrin 2012, p. 59.

<sup>188</sup> Art. 2 of the Treaty on European Union.

<sup>189</sup> However, no fines will initially be imposed under a Commitments Decision procedure, Art. 9 Reg. 1/2003. See section 3.3.

<sup>190</sup> Google Inc., Commitments in Case COMP/C-3/39.740 – *Foundem and others*, 3 April 2013. See section IV.4 for more information on the Google Commitments procedure.

<sup>191</sup> Which statement is all the more and literally supported by e.g. Unilateral Conduct Working Group, "Chapter 3: Assessment of Dominance", *ICN Unilateral Conduct Workbook*, The Hague, May 2011, pt. 5&6.

### IV.3.3. Market shares

In general, market shares are used and interpreted as a general indication of market power.<sup>192</sup> In several cases, moreover, it has been decided by the Courts that the larger a share of the market an undertaking has, the lower the threshold will be for a presumption of dominance.<sup>193</sup> However, the Commission acknowledged in the *WorldCom/MCI* Merger Decision that, at least for Internet revenues, “the absence of consistent reporting standards for data which is produced, means that there is no reliable publicly available estimate of the size of either the Internet sector as a whole or of any relevant sub-sector”.<sup>194</sup> This indicates a general difficulty in defining market shares for any internet-based market.<sup>195</sup>

Competition in online search exists on various aspects, such as the number of searchers, of queries and of associated accounts; however, the easiest method for allocating market shares, is the one based on turnover, in this case specifically the turnover or revenue gained through electronic advertising. As also indicated by the *WorldCom* Decision, especially with regard to the online industries at hand, general market share analysis poses difficulties. First, it only makes sense to allocate shares, when a relevant market has been defined.<sup>196</sup> Considering that the GOSE market analysis does not have such a solid basis, an assessment of the market shares also loses traction.

Secondly, market shares are generally based on firms’ turnovers in a predefined period, usually of one calendar year.<sup>197</sup> As the money-making aspect of the platforms available in online search is online advertisement, it seems reasonable to allocate shares on the basis of the revenue in online search advertising. However, the turnover in online advertising by the companies is not with all competitors fully generated by ways of the supplied GOSE service.<sup>198</sup> For instance, Microsoft’s Bing Search is a vertically integrated undertaking under Microsoft; hence, the turnover made by Microsoft in the advertising industry might not be fully attributable to Bing. Also, Yahoo! and Bing operate in a combined advertisers marketplace, the Yahoo Bing Network, in which also firms as Facebook, Amazon, Monster, or networks such as The Wall Street Journal Digital Network are incorporated.<sup>199</sup>

Lastly, if turnover is not a good method by ways of which to address market shares for GOSEs, other aspects, such as the number of executed searches or number of end users, are also troublesome.<sup>200</sup> For instance, when calculating the number of searches per engine, these fluctuate per day, and, what is more, billions are executed per day. Also, most searches are not to be designated as high-quality, because they serve as link-through queries to websites such as Facebook or other. Another example would be the number of search users. One could calculate the number of searchers for each respective search engine and allocate market shares on the basis of that. However, this

---

<sup>192</sup> R. O’Donoghue & A. Jorge Padilla, *The Law and Economics of Article 82 EC*, Oxford, Hart Publishing 2006, p. 109 ff.

<sup>193</sup> CFI, case T-219/99 of 17 December 2003, *British Airways plc v Commission of the European Communities*, ECLI:EU:T:2003:343, pars. 210-217, in which the CFI regarded BA dominant in the market of 1998 with a share of 39.7%; and ECJ, case C-62/86 of 3 July 1991, *AKZO Chemie BV v. Commission of the European Communities*, ECLI:EU:C:1991:286, par. 60, in which the Court regarded a presumption of dominance to exist, where an undertaking has a share of at least 50%.

<sup>194</sup> Commission decision of 8 July 1998 in case IV/M.1069, *WorldCom/MCI*, C(1998) 1887 final, par. 95. See also R. O’Donoghue & A.J. Padilla 2006, p. 111, drawing the conclusion that “determining market shares in markets subject to constant technological innovation is often difficult”.

<sup>195</sup> Cf. M.R. Patterson 2013, p. 6-7.

<sup>196</sup> R. O’Donoghue & A. Jorge Padilla 2006, p. 109.

<sup>197</sup> See the Commission Notice on the Definition of the Relevant Market, pt. 53. Cf. R. O’Donoghue & A. Jorge Padilla 2006, p. 109-110. In the current research, market shares were calculated by gathering the revenue of Quarterly generated revenue, in order to provide an up to date as possible market share overview.

<sup>198</sup> Or is so mentioned on their websites, under [Investor Relations].

<sup>199</sup> See the Yahoo Bing Network on <yahoobingnetwork.com/en/about> (accessed 18 September 2014).

<sup>200</sup> See generally, M. Rato & N. Petit, “Abuse of Dominance in Technology-Enabled Markets: Established Standards Reconsidered?”, *European Competition Journal*, vol. 9, ed. 1, May 2013, p. 11-12.

would also be unsatisfactory, because the industry is prone to the aforementioned multi-homing, which will be discussed more thoroughly in the following of this chapter.

Whereas the Court has considered market share analysis in itself as not decisive in the assessment of dominance,<sup>201</sup> it still remains a point of departure. And even though for the GOSE industry it is a difficult hurdle, in the current research, market shares have been calculated and addressed on the basis of quarterly turnover of the last five years in the online advertising industry, simply to give an indication of scope. See Table 5 and the accompanying Diagram 15.

	2008	2009	2010	2011	2012	2013
Yahoo <sup>202</sup>	\$1.786	\$1.575	\$1.601	\$1.217	\$1.201	\$1.139
MS Bing <sup>203</sup>	\$603	\$843	\$566	\$667	\$707	\$832
Google <sup>204</sup>	\$5.351	\$5.756	\$7.032	\$9.335	\$10.860	\$12.542
Total	\$8.069	\$8.531	\$9.849	\$11.873	\$13.762	\$15.959

Diagram 9. Market Shares of Online Search Engines, on Third Quarterly Revenues in millions

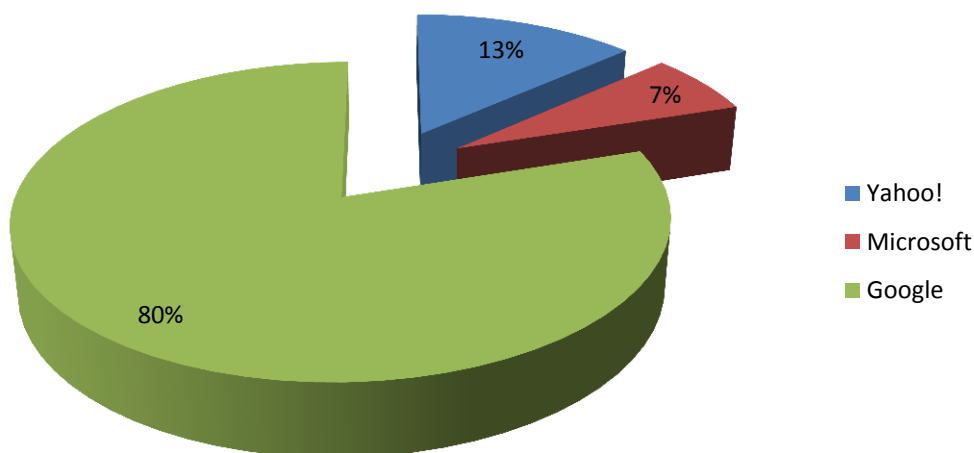

Diagram 8. Market Shares of Generalized Online Search Engines

#### IV.3.4. Barriers to entry.

Considering the difficulty of appropriately defining the market in the GOSE industries, it becomes complicated to allocate market shares. It appears that the relationship between the market shares and the industries of the current research is too rigid and static.<sup>205</sup> Attaching a percentage to a competitor does not give any insight in the competitive forces that the particular competitor endures. Also, considering the market's volatility, an image of the GOSE market of today might not likely reflect an image of the market tomorrow. This all the more justifies a stronger role to be attributed to the factors that exist aside of market shares, rendering individual market share calculation less significant.

<sup>201</sup> ECJ, Case 85/76, *HLR*, pars. 38–40.

<sup>202</sup> Third Quarter revenue for Yahoo!, under [GAAP revenue], available online at <investor.yahoo.net/results.cfm>.

<sup>203</sup> Third Quarter revenue for Microsoft Bing, under [Online Services Division], available online at <microsoft.com/investor/EarningsAndFinancials/Earnings/PressReleaseAndWebcast/FY13/Q4/default.aspx>.

<sup>204</sup> Third Quarter revenue for Google Search, under [Total Advertising Revenues], available online at <investor.google.com/financial/tables.html>.

<sup>205</sup> Potentially because of the same methods as used for the assessment of a market, giving rise to the Cellophane Fallacy for instance.

For example, Nazzini's market power methods intricately account for this, as well. The two Nazzini methods, as derived from the *UBC* ruling, are intertwined by the word "independently": this means that an undertaking should have "economic strength", be able to influence or harm competition and be able to do so, independently.<sup>206</sup> That last word indicates "the inability of the rational market conduct of rivals, customers, and ultimately, consumers to prevent the dominant undertaking from harming competition".<sup>207</sup> Independence, therefore, adheres to the contestability of the market<sup>208</sup> and of the undertaking's position.<sup>209</sup> This would again come down to barriers to entry of the GOSE market, with a specific relevance for the undertaking's, *i.e.* Google's, position.

In general, a market that experiences low barriers to entry weakens the position of a potentially dominant undertaking, because then, more undertakings are incentivised to enter that market, and larger pressure will rest on existing competitors for maintaining their position.<sup>210</sup> Barriers to entry have already been covered in the part on establishing the relevant market. Now, the influence of the barriers to entry, specifically as far as network effects are concerned, should be applied to the GOSE market. This will entail a reasoning that incorporates developed market entities as regards technology and financial progress, network effects themselves, multi-homing, adoption of technologies and market tipping, interoperability, and a novel method, which will be designated as networked innovation.

#### *IV.3.4.1. Technology and financial progress.*

The existence of economically and technologically advanced undertakings reinforces their own position. The GOSE market seems to have this threshold, not only with regard to available knowledge, but also regarding the infrastructure that is needed in order to run such an operation.<sup>211</sup> This concentration of technical expertise, of economic and structural resources poses large initial investments for entering, competing platforms. The threshold, moreover, becomes all the higher over time, as innovation in these industries seems to take exponential leaps in current day and age.<sup>212</sup> Hence, Google could be experienced as a behemoth to new entrants, considering its potentially superior algorithm, numerous other online services, the number of takeovers and its numerous updates of those services, which could deter entry.

#### *IV.3.4.2. Network effects.*

A market that experiences strong network effects strengthens the position of any existing competitor, making it more complicated for new entrants to conquer ground in that market. The case law has not come up with many examples in which network effects are sufficiently addressed. Below, however, some cases and several decisions will be researched, that give rise to a growing awareness with the Courts and European Commission of the importance of network effect analysis. The cases are the following, covering MasterCard and its interchange fee, Microsoft and its illegal tying and interoperability practices, the Microsoft/Skype Merger Decision as well as the Skype case.

---

<sup>206</sup> R. Nazzini 2012, p. 344.

<sup>207</sup> *Ibidem*.

<sup>208</sup> W.J. Baumol, "Contestable Markets and the Theory of Industry Structure", *The American Economic Review*, vol. 72, no. 1, March 1982, p. 1-15 and W.J. Baumol, J.C. Panzar and R.D. Willig, "Contestable Markets: An Uprising in the Theory of Industry Structure: Reply", *The American Economic Review*, vol. 73, no. 3, June 1983, p. 491-496.

<sup>209</sup> R. Nazzini 2012, p. 344.

<sup>210</sup> E.g. A. Coscelli & G. Edwards, "Dominance and Market Power in EU Competition Law Enforcement", Chapter 8 in: I. Lianos & D. Geradin, eds, *Handbook on European Competition Law. Substantive Aspects*, Cheltenham, Edward Elgar Publishing Inc. 2013, p. 361.

<sup>211</sup> Cf. M.R. Patterson 2013, p. 6.

<sup>212</sup> This is a reasoning that does not run along the lines of the 'superior technology' argument, see A. Jones & B. Sufirin 2012, p. 343, in which it is regarded that having a superior technology is an indication of dominance.



The first example from the case law is the *MIF* case.<sup>213</sup> It was referred to by Jones & Sufrin under the heading of two-sided market analyses being used in European Court rulings.<sup>214</sup> It concerned a case of a decision by an association of undertakings, MasterCard Inc., a case that would be relevant for the application of Art. 101, par. 1 and 3 TFEU; still, the considerations on network effects might also pose some valuable insights for the analysis of dominance. This ruling focused on so-called interchange fees charged for cross-border payments via credit card networks. In short, interchange fees are levies on credit card payment transactions, paid between banks.<sup>215</sup>

A credit card in itself constitutes a two-sided market: as more merchants allow for paying via credit card, the more attractive it becomes for consumers to acquire and purchase with such a card and *vice versa*. In the words of the Court, “*the extent of merchants’ acceptance of cards and the number of cards in circulation each affects the other*”.<sup>216</sup> However, this reasoning merely exemplifies a so-called closed payment cards system, where cardholders and merchants directly act via the credit card agent.<sup>217</sup> Conversely, in an open payment cards system, credit card companies charge royalties and membership fees to two types of financial institutions. The first type are *issuing* banks that have a relationship with the cardholders, and the other type are *acquiring* banks that have a relationship with merchants.<sup>218</sup> With every payment from a card holder to a merchant, the Issuing bank transfers the money to the acquiring bank, which then transfers it to the merchant. However, a certain percentage of the transferred sum is deducted as fee for the credit card service by the acquiring bank. Of that deducted percentage, a portion is sent to the issuing bank (the interchange fee). Consequently, the acquiring bank is paid by the Issuing bank See Diagram 10 for a graphic exemplification of such an open system.

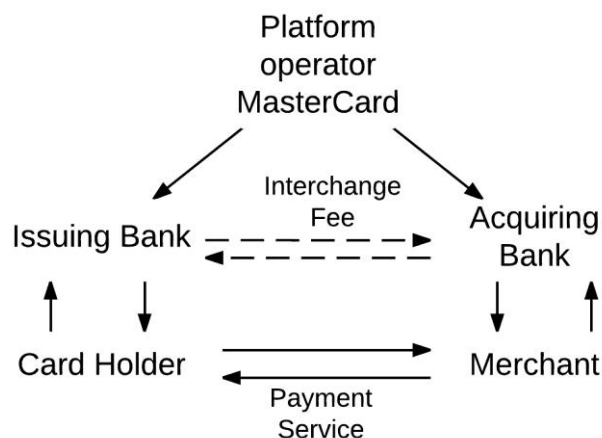

Diagram 10. Open, Four-party Credit card systems.

Essentially, the entire market consists of two two-sided markets: one is upstream, involving the two types of banks, and one is downstream, involving merchants and cardholders.<sup>219</sup> On the

<sup>213</sup> GC, case T-111/08 of 24 May 2012, *MasterCard, Inc. and Others v European Commission* (MIF), ECLI:EU:T:2012:260, appeal in case C-382/12 P, *MasterCard, Inc. and Others v European Commission* (MIF), ECLI:EU:C:2014:2201.

<sup>214</sup> A. Jones & B. Sufrin 2011, p. 81.

<sup>215</sup> For more information, see, e.g., T.J. Zywicki, “The Economics of Payment Card Interchange Fees and the Limits of Regulation”, *ICLE Financial Regulatory Program White Paper Series*, 2 June 2010, p. 26-28 and for a thorough figure, US Government Accountability Office, “Credit Cards. Rising Interchange Fees Have Increased Costs for Merchants, but Options for Reducing Fees Pose Challenges”, Report to Congressional Addressees, November 2009, GAO-10-45, p. 8, available online at <gao.gov/new.items/d1045.pdf> (accessed 18 September 2014).

<sup>216</sup> *MIF* case, par. 176.

<sup>217</sup> An example of this type of agent is American Express, see, e.g., online at <about.americanexpress.com/oc/whoware> (accessed 18 September 2014).

<sup>218</sup> T.J. Zywicki 2010, p. 26-28.

<sup>219</sup> Cf. A. Jones & B. Sufrin 2012, p. 81.

upstream market, different card schemes compete so as to persuade the financial institutions to adopt their network. On the downstream market, the banks offer the complete payment services to consumers. Hence, network effects act also on the upstream level: the more issuing banks exist, the more attractive it will become for another bank to become an acquiring bank in the credit card operator's network, and *vice versa*.<sup>220</sup>

The General Court did not take notice of this point. Rather on the contrary, the GC opined that the sides of that particular market should not be considered conjointly, because the services provided to cardholders and to merchants can be distinguished and holders and merchants exert separate competitive pressures on the two respective types of banks.<sup>221</sup> Essentially, in this case, the existence of network effects seemed not to be relevant for the assessment of the market.<sup>222</sup>

In the recent appeal procedure, however, the ECJ, nuanced the GC judgment, by stating that “the economic and legal context of the coordination concerned includes [...] the two-sided nature of Mastercard's open payment system, particularly since it is undisputed that there is interaction between the two sides of that system.”<sup>223</sup> Nevertheless, the Court did not continue with assessing this criterion, as the arguments raised by the parties concerned the pro-competitive aspects of the MIF, which cannot be raised in the assessment under art. 101 par. 1 TFEU.

Similarly, the recent appeal in the *Groupement des Cartes Bancaires* case, covered the importance of markets with a two-sided nature. It concerned a similar credit card system as in *MIF*, and particular agreements by the Groupement, three so-called pricing measures as regards the activities of issuing banks were regarded as restrictions by object under the current Art. 101 par 1 TFEU.<sup>224</sup> The Commission defined the relevant market as that for issuing payment cards. Under Art. 101 par. 1 TFEU, the coordination in question should be assessed according to “the content of its provisions, its objectives and the economic and legal context” in which it can be placed.<sup>225</sup> Further, the “nature of the goods or services affected” should be incorporated in such an assessment, and also “the real conditions of the functioning and structure of the market or markets in question”.<sup>226</sup> The particular relevant phrase in this sense, the ECJ specifies that “all relevant aspects of the economic and legal context of the coordination under consideration, “all the more so, when, as in the present case, there are interactions between the two facets of a two-sided system”.”<sup>227</sup>

Even though these decisions by the Courts of the EU have been made with regard to assessments under Art. 101 TFEU, and they concern a different (two-sided) market, they could have implications for the dominance assessment under art. 102 TFEU. For Google Inc. that could entail that, more specifically under a contestability analysis, all sides of the platform have to be considered. Such a reasoning, hence, has significant consequences for the current assessment in the Google Commitments procedure, with regard to the alleged abusive behaviour. The market for advertising, and the market for provision of content should not be allowed to be construed separately from one another, but judged as a whole.

A next case in point where network effects played a crucial role is *Microsoft* and the tying of its media player software to its operating system Windows, and the refusal to supply interoperability

---

<sup>220</sup> This would be another example of indirect network effects.

<sup>221</sup> *MIF* case, par. 177. For other arguments, see the reasoning continued in paras. 178-182.

<sup>222</sup> See also GC, case T-461/07 of 14 April 2011, *Visa Europe Ltd and Visa International Service v European Commission*, ECLI:EU:T:2011:181, paras. 16-17.

<sup>223</sup> *MIF* case, par. 179.

<sup>224</sup> ECJ, Case C-67/13 P of 11 September 2014, *Groupement des Cartes Bancaires (CB) v. European Commission* (Groupement des CB), ECLI:EU:C:2014:2204

<sup>225</sup> *Groupement des CB* case, par. 53.

<sup>226</sup> *Ibidem*, referring to ECJ, Case C-32/11, *Allianz Hungária Biztosító Zrt. And Others v. Gazdasági Versenyhivatal*, ECLI:EU:C:2013:160, par. 36.

<sup>227</sup> *Groupement des CB* case, paras. 78 and 79.

information of Windows to other systems.<sup>228</sup> The facts of *Microsoft* revolve around two markets: one market concerned client PC operating systems (OS). The Decision and the Court ruling defined an OS as “‘system software’ which controls the basic functions of the computer and enables the user to make use of the computer and run application software on it”.<sup>229</sup> To the non-technologically skilled consumer, an OS itself is practically useless. Application software has to be installed and executed on it. Hence, the chicken-and-egg issue here plays between software developers and customers. The more applications that are available for a particular OS, the more attractive it becomes for consumers to buy and utilise the OS. Again, this is an example of indirect network effects.

The other market concerned work group server systems. Those were defined as “operating systems designed and marketed to deliver collectively ‘basic infrastructure services’ to relatively small numbers of client PCs connected to small or medium-sized networks”.<sup>230</sup> On that market, the network effects relate to the availability of technicians, or system operators, who are capable of maintaining the network and the necessary software. The easier it is for a group of customers to acquire a skilled technician, the higher the inclination to purchase a work group server system; the other way round, a technician would be more willing to become skilled at providing maintenance services of that particular type of software, if the OS is a popular product.<sup>231</sup>

In the EC Decision, which was confirmed by the CFI judgment, the existence of network effects was seen as the pivotal barrier to entry, both to the client PC operating systems and to the work group servers market: “[t]he nature of the barriers to entry in the client PC operating system market serves to reinforce the conclusion that Microsoft holds a dominant position in this market. These barriers to entry derive from the network effects in the market”.<sup>232</sup> In the ruling, the CFI stated that “those network effects derive, first, from the fact that users like platforms on which they can use a large number of applications and, second, from the fact that software designers write applications for the client PC operating systems that are the most popular among users”.<sup>233</sup>

In all, the above seems to indicate that network effects are important factors which can reinforce or establish a dominant undertaking. However, the case law is currently too thin from which to fully derive a standing rule. Moreover, as the following will show, the establishment of network effects itself is not sacrosanct for dominance, economically speaking.

Further, as established with respect to Google, on multiple sides of the platform network effects are extant. As covered in section III.3.4, direct network effects among end users entering queries algorithmically reinforce the use of the search engine for new end users; also, indirect network effects among end users and websites, among web sites and advertisers, and among advertisers and users reinforce the addition of actors on all sides. This could augment a large market share to potential dominance of Google in the GOSE market.

#### IV.3.4.3. Multi-homing.

A highly recent case, in which Microsoft was also a notable player, is Skype. The *Skype* case is an example of multi-homing, and is the first case in which the Court uses this terminology.<sup>234</sup> In general, a market that experiences strong multi-homing effects weakens individual network effects, and with it, weakens the position of a potentially dominant firm. This is sensible, because if a consumer opts for using two networks instead of one, both networks gain a user; as a consequence, both networks benefit equally, though neither receives an advantage over the other. In *Skype*, the

---

<sup>228</sup> CFI, case T-201/04 of 17 September 2007, *Microsoft Corp. v Commission of the European Communities* (Microsoft (Tying and Interoperability)), ECLI:EU:T:2007:289.

<sup>229</sup> *Idem*, par. 24.

<sup>230</sup> *Idem*, par. 25.

<sup>231</sup> EC Prohibition Decision of 24 March 2004 in case COMP/C-3/37.792, *Microsoft*, C(2004)900 final, par. 515-522.

<sup>232</sup> *Idem*, par. 448-451.

<sup>233</sup> *Idem*, par. 31, and par. 33.

<sup>234</sup> GC, case T-79/12 of 11 December 2013, *Cisco Systems, Inc. and Messagenet SpA v European Commission* (Skype), ECLI:EU:T:2013:635.

General Court assessed this phenomenon by examining the filed application by two firms for annulment of the Commission Decision that approved the takeover of Skype by Microsoft.<sup>235</sup>

The relevant facts concerned two markets, one for internet-based communications services aimed at the general public and one for those aimed at undertakings. A particular feature of the markets, which is also relevant for the current Google investigation, is that “most of the services are provided for free”.<sup>236</sup> With regard to the merged entity, the General Court says the following: “[i]n so far as users expect to receive consumer communications services free of charge, the potential for the new entity to set its pricing policy freely is significantly restricted.”<sup>237</sup> Also, “if the new entity decided to stop innovating in terms of its communications services, it would also run the risk of reducing their attractiveness given the level of innovation on the market in question”.<sup>238</sup> In other words, in this particular trade, a large firm cannot be considered dominant, irrespective of its (current) market share, when it cannot change price or reduce the degree of innovation to its benefit.

The General Court, subsequently, proceeds with assessing the network effects.<sup>239</sup> Network effects in voice and video communication software markets are direct: the more users a piece of audio or video messaging software has, the more attractive it becomes for new users to join, hence existing users attract the same type of users. This could reinforce a dominant position. The GC rightfully acknowledges that competing platforms experience the same effects, which therefore, not necessarily detract from a dominant network. Nevertheless, the reasoning the GC adheres to is most likely only applicable to a market with equally-sized networks. If a large network, however, competes with a smaller network, it will be more favourable for new users to ‘adopt’ the network with the largest user base. This will be further discussed, below.

The Commission utilised Facebook data to state that users engage in regular two-way interaction with four to six people.<sup>240</sup> This information, however, says nothing about which four to six people are communicating. Person A<sub>1</sub> might communicate with acquaintances A<sub>2</sub> to A<sub>6</sub>; however, friend A<sub>2</sub> might communicate with friend A<sub>1</sub> and persons B<sub>1</sub> to B<sub>5</sub>, accounting for a completely different group. Hence, the conclusion by the Commission that, therefore, groups can easily move between services does not strike root.<sup>241</sup> The decision to switch networks will predominantly be an individual decision and not by groups as a whole. The General Court seems to acknowledge this, by stating that “no economic or technical obstacle” exists that either prevents *small groups* switching or prevents *users* from simultaneously using more than one piece of communication software.<sup>242</sup> Subsequently, the GC, relying on the information provided by the Commission’s Decision, acknowledges multi-homing to detract from potential network effects existent on the markets, and therefore detract from potential dominance.<sup>243</sup>

A consecutive, potentially controversial, consideration by the General Court is given in par. 96 of the *Skype* case. It states that, despite earlier decisions by the Commission, the case in point was not characterised by “the presence of technical or economic constraints preventing users from downloading several communications software programs at the same time”. The Court is arguably sufficiently clear in distinguishing this case from the *Microsoft (Tying & Interoperability)* case.<sup>244</sup>

However, essentially, that same phrase seems to be applicable to the case of Microsoft’s Windows Media Player having been decided upon as illegally tied to its Windows OS. At the time of those

---

<sup>235</sup> EC Decision in Case No M.6281 on 07 October 2011, *Microsoft/Skype Merger*, C(2011)7279.

<sup>236</sup> *Idem*, par. 66.

<sup>237</sup> *Skype* case, par. 73.

<sup>238</sup> *Ibidem*, and par. 92.

<sup>239</sup> *Idem*, par. 74 ff. See also comment, *supra*, nt. 186.

<sup>240</sup> *Microsoft/Skype Merger* Decision, Par. 92.

<sup>241</sup> *Ibidem*.

<sup>242</sup> *Skype* case, par. 80.

<sup>243</sup> *Idem*, par. 81.

<sup>244</sup> *Idem*, par. 96.

proceedings,<sup>245</sup> consumers on the WWW surely would have advanced enough, to such an extent as to not be constrained from downloading and using various existing (free) media players. At that time, internet access had become widely available and an increasing number of people had started downloading files and software from the WWW. Still, the Commission opined that “downloading is not a channel which can be compared in efficiency to [...] pre-installation.”<sup>246</sup>

Arguably, therefore, the Commission, as confirmed by the General Court,<sup>247</sup> jumps to conjectural conclusions in the two cases with regard to network effects and multi-homing. It construes network effects, that legally, technically, and economically are not proven. Proper evidence, ruling out the possibility that multi-homing exists on the market lacks in the Commission’s and Court’s assessment. As a consequence of this ambivalence, it is up until now entirely uncertain what the law entails with regard to network effects and multi-homing. With respect to the rule of law, this is an extremely undesirable situation; moreover, it is a situation that in the longer term might have detrimental consequences for the climate for businesses in the EU.<sup>248</sup>

With regard to Skype, possible tying or bundling situations were also considered.<sup>249</sup> However, it was decided that many alternatives to Skype exist,<sup>250</sup> and people increasingly prefer online messaging services that are “part of a broader user experience”, such as Facebook, Google+, *et cetera*.<sup>251</sup> This rendered bundling and tying as not impeding consumer harm.<sup>252</sup> Hence, arguably, these circumstances did not exist to such an extent for WMP at its respective time. Furthermore, a part of the decision on declaring the tying of WMP illegal was the option that it could not be uninstalled.<sup>253</sup> Also, the decision shows an emphasis on the aim of protecting competitors, and not of consumers. Irrespective of the software being provided for free, alternative suppliers will be at a competitive disadvantage if consumers receive WMP as directly tied to Windows.<sup>254</sup> Hence, it might be that the actual harm to consumers was fully equal to what was regarded by the Commission in the *Microsoft/Skype* Merger Decision.

Considering the increased availability of multiple music streaming, downloading, and sharing apps, websites and programs, nowadays, it could be argued that under current economic and technological developments, Microsoft would be allowed to tie a media player to its OS. Still, it would be infringing the old Decision. That would, apart inconsistent logic, not account for any legal certainty for undertakings in the European Union.

In short, as can be derived from the case law until thus far, network effects can and seemingly will have a significant role in the assessments of dominance, both in the Decisions of the Commission, as in the rulings of the Courts. Furthermore, considering that also multi-homing is becoming a point of reference in the assessments, this points at a more economic approach, that moves further away from

---

<sup>245</sup> Perhaps not when the infringement commenced, *viz.*, in May 1999, see EC Prohibition Decision of 24 March 2004 in case COMP/C-3/37.792, *Microsoft*, C(2004)900 final, par. 793.

<sup>246</sup> *Idem*, par. 859. The EC might have a point, by stating that “downloading a media player enables users to add a second media player to their PC and not to replace WMP, [which] cannot detract from the fact that WMP is always pre-installed on Windows PCs” (par. 860), for, e.g., streaming online media, competing media players always were an optional addition to any previously or pre-installed media player, for instance Apple’s Quicktime Player. Also, considering the variety of available formats to export the media files to, some media players offered the operability that others did and still do not. See as an indicative list, Wikipedia.org, “List of File Formats: Sound and Music”, page last modified on 26 February 2014, available online at <en.wikipedia.org/wiki/List\_of\_file\_formats#Sound\_and\_music> (accessed 18 September 2014).

<sup>247</sup> *Microsoft (Tying & Interoperability)* case, paras. 1036-1037.

<sup>248</sup> Arguably, the shift towards a more consumer welfare-oriented approach has changed the opinions by the Commission; in essence, however, the law should not change, because of a change of enforcement priority.

<sup>249</sup> *Microsoft/Skype* Merger Decision, par. 137 & 138.

<sup>250</sup> *Idem*, par. 152.

<sup>251</sup> *Idem*, par. 153.

<sup>252</sup> *Idem*, par. 154.

<sup>253</sup> *Microsoft Tying & Interoperability* Decision, par. 829.

<sup>254</sup> *Idem*, par. 830-833.

original static market (share) analysis and more towards (potential) effects on the market. The aforementioned rules and extrapolations of the rulings and decisions also seem to point at a high threshold before regarding Google as a dominant undertaking, let alone the conduct that the company displays as being abusive. It remains to be seen in future cases what the prevailing stance of EU Competition Law will be on network effects and multi-homing. Moreover, some potentially relevant aspects for assessing dominance are covered neither in the rulings, nor in the Decisions. These are adoption of technologies and market tipping, and networked innovations, which concepts will be addressed in the following sections. Subsequently, the recent Google commitments procedure is covered.

#### *IV.3.4.4. Adoption and Market tipping*

A market where the chance of ‘tipping’, depending on whether a current form of technology, a product, or something else is adopted by the designated audience, is present, can establish a dominant undertaking, almost in the sense of a natural monopoly.<sup>255</sup> The idea of markets tipping is another consequence of network effects.<sup>256</sup> As networks grow in size, more users will be attracted to that particular platform. Economically, this can be explained with the incremental benefit increase: as the network increases in size, the benefit that any new user would derive from the network is sufficiently larger than that same user would have at the much smaller network. A large network, logically, attracts more users at the same time, than a tiny network will. The positive feedback loops that network effects entail, hence, support this tipping process.

In some instances, adoption of a particular technology or product becomes factual standard, such as happened with the VHS tapes and DVD discs.<sup>257</sup> Both this and the risk of markets tipping are economic factors that, up until now, the Courts have not regarded as relevant. For instance, the assessment of the Skype action for annulment did not lead to such an interpretation.<sup>258</sup> On the contrary, the General Court in *Skype* has not progressed beyond merely identifying market shares, network effects, and multi-homing.<sup>259</sup>

Tipping markets can be detrimental to innovation of the particular product, because, when, for some reason or other, end users favour a piece of technology that is inferior on its technological sophistication, and the market tips towards that undertaking, a different piece of potentially superior technology in that respect might become lost. The tipped market entity might, then, also not have the incentive to innovate further.<sup>260</sup> Furthermore, when many people adopt that technology, it becomes difficult for a competing, more sophisticated product to conquer ground.<sup>261</sup> By and large, network

---

<sup>255</sup> C. Argenton & J. Prüfer, “Search Engine Competition with Network Externalities”, *Journal of Competition Law & Economics*, vol 8, ed. 1, p. 80.

<sup>256</sup> S. Andes, “Making the Market: How Interoperability and Tipping Points Can Influence Network Size”, *The Heinz Journal*, vol. 9, ed. 2, 4 May 2012, available online via <[journal.heinz.cmu.edu/category/archives/vol9issue2](http://journal.heinz.cmu.edu/category/archives/vol9issue2)> (accessed 18 September 2014).

<sup>257</sup> E.g., M. L. Katz and C. Shapiro, “Technology Adoption in the Presence of Network Externalities”, *Journal of Political Economy*, vol. 94, no. 4, August 1986, p. 822-841.

<sup>258</sup> See, for instance, the references on tipping by Microsoft in the *Microsoft (Tying & Interoperability)* case, in paras.1002, 1003, 1021 and 1291, defined as the “complete elimination of competition” by the Commission in par. 1019.

<sup>259</sup> *Skype* case, paras. 65-83.

<sup>260</sup> T. Hossain, D. Minor, J. Morgan, “Competing Matchmakers: An Experimental Analysis”, *Management Science*, vol. 57, ed. 11, February 2010, p. 1913-1925. See also T. DeChant, “Why Markets Tip to One Platform (or Not). Uncovering the secrets of market tipping”, 2 February 2012, *KelloggInsight* entry, available online at <[insight.kellogg.northwestern.edu/article/why\\_markets\\_tip\\_to\\_one\\_platform\\_or\\_not](http://insight.kellogg.northwestern.edu/article/why_markets_tip_to_one_platform_or_not)> (accessed 18 September 2014).

<sup>261</sup> An incompatible innovation allegedly should be “ten times better”, also referred to as the 10X rule of thumb, C. Shapiro & H.R. Varian, *Information Rules. A Strategic Guide to the Network Economy*, Boston, Harvard Business School Press 1998, p. 196.

effects prevent users from switching or starting to use a product that has a small user base, yet that is in and of itself a better product.<sup>262</sup>

The further risk is that the tipped market will abandon the original market and the innovations that came with it, entailing a locked-in new market from which returning is a difficult option.<sup>263</sup> An example for this is of newer computer hardware currently not being equipped any longer with CD- or DVD-reading technology, arguably because the majority of people streams their music online, downloads software or stores all its information in ‘the cloud’. The risk of a market tipping would therefore be a considerable factor to take into account in dominance assessments.<sup>264</sup> For certain Member States in the European Union, for instance, the presence and utilization by end users of Google on the market for GOSEs seems to indicate a tipped market in favour of the company.<sup>265</sup> Still, it does not necessarily mean that a tipped market is a dominance market, or that a company is fully to blame for the behaviour of, inert, consumers.

#### *IV.3.4.5. Interoperability.*

As a final point, interoperability is noteworthy to mention for assessing dominance.<sup>266</sup> A market that has a high degree of interoperability among various networks, platforms, or engines, will experience decreased individual network effects, a lower chance of tipping and therefore a lower chance of creating or sustaining dominance.<sup>267</sup> For example, if a consumer can install the exact same software, in even the same format on differing operating systems, it would essentially matter less for him or her which OS to choose initially. That market would, further, be less locked-in with respect to downstream service providers that initially opt for one platform.<sup>268</sup> The most famous example is the one 2,5 billion consumers utilise regularly, if not every day: the internet or data communication that is operable across all platforms, devices, *et cetera*. A more recent example would be the standardization of uniform USB chargers for data-enabled mobile phones.<sup>269</sup>

Search engines work on every web browser software, on every OS platform and most likely on any type of computer hardware. Moreover, due to the internet, the engine is reachable from practically all over the world and, especially with regard to Google, is translated into numerous

---

<sup>262</sup> Even though, e.g. the BlackBerry Messenger app might have better functionality and security than for instance WhatsApp Messenger (both messaging apps are available on Android OS-enabled smartphones), a large number of consumers continue using the latter. See e.g. I. Soans, “What BBM on Android, iOS has what WhatsApp doesn’t”, *Firstpost* blog entry, 10 September 2013, available online at <[firstpost.com/blogs/what-bbm-on-android-ios-will-have-that-whatsapp-doesnt-1098791.html](http://firstpost.com/blogs/what-bbm-on-android-ios-will-have-that-whatsapp-doesnt-1098791.html)> (accessed 18 September 2014).

<sup>263</sup> *Idem*. This phenomenon is also referred to as *path dependence*, and was exemplified by the choice of the world for starting and continuing to utilize the QWERTY keyboard at a computer, e.g. P. David, “Clio and the economics of QWERTY”, *American Economic Review*, vol. 75, ed. 2, p. 332–337 and S. Liebowitz & S. Margolis, “The fable of the keys”, *Journal of Law & Economics*, 1990, vol. 33, ed. 1, p. 1–25.

<sup>264</sup> In other words, as indicated by M. Rato & N. Petit 2013, p. 14, “the road to dominance may matter”.

<sup>265</sup> For instance, Google could in that sense be regarded as tipped, considering its presence on the GOSE market in the Netherlands, see e.g., Global Stats Stat Counter, Search Engine Use from 2008-2014, graph available online at <[gs.statcounter.com/#search\\_engine-NL-yearly-2008-2014-bar](http://gs.statcounter.com/#search_engine-NL-yearly-2008-2014-bar)> (accessed 18 September 2014).

<sup>266</sup> See, e.g. E. Brousseau, “Multi-level governance of the digital space: does a “second rank” institutional framework exist?” Chapter 22, in: E. Brousseau & N. Curien, eds., *Internet and Digital Economics. Principles, Methods and Applications*, Cambridge, Cambridge University Press, 2007, p. 634 ff. See also, D.F. Spulber, “Innovation Economics: the Interplay among Technology Standards, Competitive Conduct, and Economic Performance”, *Journal of Competition Law & Economics*, vol. 9, ed. 4, p. 777–82, particularly p. 789-790.

<sup>267</sup> M. L. Katz & B. Keating, “Network Effects, Switching Costs, and Competition in Unified Communications”, Working paper commissioned by Cisco Inc., 5 November 2012, available online at <[newsroom.cisco.com/documents/10157/1142732/Katz\\_and\\_Keating\\_on\\_Compatibility\\_Competition\\_UCC.pdf](http://newsroom.cisco.com/documents/10157/1142732/Katz_and_Keating_on_Compatibility_Competition_UCC.pdf)> (accessed 18 September 2014).

<sup>268</sup> See also M. Rato & N. Petit, “Abuse of Dominance in Technology-Enabled Markets: Established Standards Reconsidered?”, *European Competition Journal*, vol. 9, ed. 1, May 2013, p.13-14.

<sup>269</sup> As was enshrined in a Memorandum of Understanding, signed by fourteen mobile phone manufacturers, European Commission, “One Charger for all – The story”, 09 February 2010, available online at <[ec.europa.eu/enterprise/sectors/rtte/chargers/story/index\\_en.htm](http://ec.europa.eu/enterprise/sectors/rtte/chargers/story/index_en.htm)> (accessed 18 September 2014).

languages and respective domains. In essence, one could wonder how much more interoperability one could want. However, this is interoperability from one perspective, as in that the engine can be operated from anywhere, on essentially any computer device. From a different perspective, however, Google has its own index of the WWW, utilises its own search algorithms, and keeps several of the factors secret, although publishes many of its algorithm updates online. However, the bottom line is that the GOSE market has multiple indices, multiple advertising networks and multiple search applications. All of those are generally not interoperable with one another; hence, for both a website administrator, an online advertiser, and a search engine user, the choice would matter for the respective side of the platform, and therefore, no interoperability exists.

Nevertheless, on numerous other aspects, Google considers integration and interoperability. For instance, on the integration of other pieces of software, it allows documents made by Microsoft Word (.doc or .docx) to be converted to Google Doc format and back, allows .mp3 and, for example, .pdf files to be played respectively read via with a certain downstream service of Google. Also, on the upstream level, several core coding parts of the engine are released as so-called *open source*, allowing anyone with a coding background to tweak or ameliorate the engine, making it a product of the public. Many of these precise, down- and upstream interoperability aspects are arguably decisive for whether the market or the entities on the market allow for strong interoperability. As of yet, none of these aspects are taken into account in an abuse of dominance case.

#### *IV.3.4.6. Networked innovation.*

The business models that can be witnessed over the last decade consist of market competitors that either employ a successful piece of technology or that build a system, platform, or further pieces of technology that display strong network effects. They seem to occur foremost on or around the previously defined infrastructure of the internet and the WWW. The markets seem to experience tipping more and more in favour of increasingly larger undertakings. However, considering the fast pace in which all these markets develop themselves, an influential undertaking, today, needs innovations in order to expand business or remain large, tomorrow.

The markets in question have been previously defined, namely as so-called markets of the *new economy*.<sup>270</sup> One phenomenon extant in these markets is that competition between undertakings is not based on the price of a particular product, or on the degree of innovation in a particular strand, but on compatibility itself. As described by Jones & Sufrin, “the high technology markets of the new economy are characterised by dynamic competition, where the threat to existing products comes from new products.”<sup>271</sup> Hence, large corporations introduce multiple products or ancillary services, which are connected, voluntarily or not, to the existing dominant product.

For instance, Google Inc. commenced with the employment of a highly successful and profitable search algorithm on the World Wide Web. Shortly after, a web browser toolbar was introduced. Then, in the following order, several products were introduced, that allowed people to search for images, products, or books; an email client was introduced, a picture sharing platform, mapping, and an online messenger application.<sup>272</sup> This allowed the company to not only attract new consumers to use these new applications, but also to maintain existing consumers of Google’s search services.

The example from the case law is Microsoft, which is a more vertically integrated example than Google’s. Generally, a purchased piece of OEM (Original Equipment Manufacturer) computer hardware comes with a preinstalled version of the Windows OS, which in turn has a preinstalled version of Internet Explorer that might automatically set Bing as a home page that favours its own

---

<sup>270</sup> E.g. A. Jones & B. Sufrin 2012, p. 57-58, 79 & 352-354. For further information, see W. Lazonick, “Evolution of the New Economy business model”, Chapter 2 in: E. Brousseau & N. Curien, eds., *Internet and Digital Economics*, Cambridge, Cambridge University Press 2007.

<sup>271</sup> A. Jones & B. Sufrin 2012, p. 79.

<sup>272</sup> Google Timeline, available online at <[google.com/about/company/timeline](http://google.com/about/company/timeline)> (accessed 18 September 2014).



vertical searching applications. Each level of further vertical integration connects to the former, directing flows of customers of one particular level to the other, further downstream level.

What is more, the potentially further-reinforcing factor of Google's position as a GOSE is that many of the introduced downstream services display network effects themselves. The integration of these particular types of software, having network effects, with software that in itself displays network effects, might create a further reinforcing effect for undertakings, creating or reinforcing dominance. Most downstream examples are messaging and socializing applications such as Google+ and Microsoft Skype, email clients such as Gmail or Hotmail, streaming services such as Google Play Music, YouTube, sharing platforms such as Picasa for images, and booking platforms such as Google's Products, Hotel Search, Restaurant or Flight Search engines. Further upstream entails the Android OS by Google, Microsoft's Bing search engine, the Chromebook by Google and for instance currently the provision of internet access and connection services by Google, Google Fiber.<sup>273</sup> Essentially, it concerns the conjunction of the concept of the New Economy markets with the concept of network effects: introducing new products that display strong network effects by themselves, in order not only to challenge existing competitors in the particular market of the introduced product, but also to reinforce the potentially dominant position on the original product.

#### IV.4. Google investigation

The final paragraphs in this chapter are dedicated to the Google investigation by the European Commission. Before the finishing of this article, the EC announced to close the investigation on the potential abuse of dominance allegations as committed by Google.<sup>274</sup> Not much background information was, and still is, provided about the Commission's probe.<sup>275</sup> It began with complaints by various other (vertical) search service providers, alleging to be unfavourably treated by Google, both in the organic and in the sponsored search results.<sup>276</sup> The investigation was allegedly incited by approximately twenty complainants, amongst which *Foundem*, *Fairsearch.org* and *Microsoft*.<sup>277</sup>

The nature of the investigation foremost revolved around potential abuse of dominance of Google Search by deliberately treating competing vertical search service (VSS) providers unfavourably. Simultaneously, Google was accused of favouring own specific search services over competing search services in the result pages. Allegedly, this was accomplished by lowering the Quality Score of the respective competitors.<sup>278</sup> The mentioned vertical services related to price comparisons (for instance, on products, hotels, and flights), which Google had incorporated in the results by ways of its Universal Search.<sup>279</sup> The Commission, furthermore, investigated three other concerns, namely, one, the use of third party website content in Google search services (e.g. user reviews or other data) without prior authorisation. Two, it researched exclusivity obligations that Google allegedly imposed on advertising partners (websites under AdSense), and, three, supposed restrictions for advertisers to convey their advertising campaigns from Google AdWords to competing ad networks.<sup>280</sup>

The procedure followed up until now, is generally referred to as a Commitments Decision procedure. In Regulation 1/2003, the rules on implementing (now) Artt. 101 and 102 TFEU are

<sup>273</sup> See on <fiber.google.com/about/> (accessed 18 September 2014).

<sup>274</sup> EC, "Antitrust: Commission obtains from Google comparable display of specialised search rivals", Press release Brussels, 5 February 2014, IP/14/116.

<sup>275</sup> E.g., A. Lamadrid de Pablo, "Search Engines Google & Competition Law", PowerPoint Presentation, 8 February 2013, slide 17, available online via <chillingcompetition.com/2013/02/12/materials-from-the-gclc-lunch-talk-on-google> (accessed 18 September 2014).

<sup>276</sup> EC, "Antitrust: Commission probes allegations of antitrust violations by Google", Press release, Brussels, 30 November 2010, IP/10/1624.

<sup>277</sup> A. Lamadrid de Pablo 2013, slide 15.

<sup>278</sup> EC IP/10/1624.

<sup>279</sup> *Ibidem*.

<sup>280</sup> EC. Opening of Proceedings notification in case AT. 39740. See also, EC, Communication from the Commission in Case AT.39740 of 26 April 2013 (Google Market Test Notice), *OJ C* 120/09, p. 22-23.

mentioned. The so-called Commitments Decisions that can be issued by the EC are based on Art. 9 Reg. 1/2003, which states that, where the Commission *intends* to adopt a termination of infringement Decision, as stipulated in Art. 7 Reg. 1/2003, the undertakings under scrutiny can offer commitments to adhere to the alleged infringements by the EC, which the EC can document in a Decision. As a consequence of the word “intends”, Commitments decisions do not have to find or even give evidence for an infringement of competition as respected by Art. 101 or 102 TFEU; all they address is the commitments given by undertakings in response to concerns by the Commission that competition might be infringed in a particular industry.<sup>281</sup> Furthermore, no fine is initially imposed, only when the commitments as enshrined in the Decision are not adhered to by the designated undertaking.<sup>282</sup>

With regard to the legal basis of the Commitments procedure, it is relevant to refer to the case *Alrosa*.<sup>283</sup> In this case, the ECJ explained the relation between Art. 7 and 9 Reg. 1/2003, with regard to legal review. Subject of the litigation were proposed commitments by the two largest producers and suppliers of diamonds on the world market, Alrosa Company Ltd and De Beers SA.<sup>284</sup> Alrosa pleaded a breach of Art. 9 and of the principle of proportionality, which the GC acknowledged.<sup>285</sup> The appeal by the Commission led to the annulment of the GC’s ruling, in which the ECJ ruled that the GC had “encroached on the discretion by the Commission instead of reviewing the lawfulness of its assessment.”<sup>286</sup> The ECJ stated that the aim of Art. 9 was to address the Commission’s concerns after a preliminary assessment.<sup>287</sup> This is different from Art. 7’s aim of putting an end to an established infringement. The EC, therefore, has the legal discretion to ascertain which commitments it finds fitting to its concerns.<sup>288</sup> As regards legal review, the Courts are merely allowed to evaluate whether the Commission’s assessment is manifestly incorrect.<sup>289</sup>

As an example of the longevity (and perhaps also the complexity) of the Google case, the followed procedure currently spans almost four years: the Commission’s investigation opened in November 2010, after it had received a number of complaints.<sup>290</sup> Four concerns as regards Google’s practices were uttered by the Commission in May 2012.<sup>291</sup> Respectively, Google proposed commitments and amendments in April and October 2013, and in January 2014.<sup>292</sup> Currently, a Commitments Decision is still several months away from being adopted by the European Commission.<sup>293</sup>

---

<sup>281</sup> EC, “Antitrust: Commission obtains from Google comparable display of specialised search rivals”, Press release, Brussels, 5 February 2014, IP/14/116, p. 2.

<sup>282</sup> An example of which is Microsoft and EC, Fines Decision of 6 March 2013 for failure to comply with the Commitments Decision of 16 December 2009 in case COMP/C-3/39.530 – *Microsoft (Tying and Interoperability)*, C(2013) 1210 final, revolving around the illegal tying of Internet Explorer to its OS.

<sup>283</sup> ECJ, case C-441/07 P of 29 June 2010, *European Commission v. Alrosa Company Ltd* (Alrosa), ECLI:EU:C:2010:377.

<sup>284</sup> *Idem*, par. 6.

<sup>285</sup> *Idem*, par. 7 & 12.

<sup>286</sup> *Idem*, par. 67

<sup>287</sup> *Idem*, par. 46.

<sup>288</sup> *Idem*, par. 61.

<sup>289</sup> *Idem*, par. 42.

<sup>290</sup> Currently, the Commission states that 18 formal complaints are under investigation, see EC Press Release, IP/14/116, p. 2.

<sup>291</sup> J. Almunia, “Statement of VP Almunia on the Google antitrust investigation”, Brussels, 21 May 2012, SPEECH/12/372.

<sup>292</sup> Google Inc., Commitments In Case COMP/C-3/39.740 - *Foundem and others*, April 3 2013. The updated proposals have not been made available on the website of the EC; hence, for the October 2013 Commitments, see, e.g., <blogs.ft.com/brusselsblog/files/2013/11/annex-v-commitment-proposal.pdf>. For the January 2014 Commitments, see e.g. <services.google.com/fh/files/blogs/google\_commitments\_full\_2014.pdf> (accessed 18 September 2014).

<sup>293</sup> EC, “Antitrust: Commission obtains from Google comparable display of specialised search rivals- Frequently asked questions”, Memo, 5 February 2014, MEMO/14/87, p.3.

In the following, the contents of the Commitments procedure are covered, preceded by several preliminary remarks on the characteristics of the procedure. In the contents section, a comparison is drawn between the first solution proposed by Google on the incorporation of rival vertical search services in Google's rankings, and the essential facilities doctrine in EU competition law.

#### *IV.4.1. Preliminary remarks.*

As these procedures for tackling competition concerns by the Commission not address any legal aspects beforehand, such as dominance, from a legal perspective, these decisions would seem to have no foundation whatsoever in competition or abuse of dominance law. Any legal hurdle is simply overcome by focusing on the effects in the market, the conduct of the undertaking and potentially foregone benefit for the consumer. Nevertheless, it is one of the options that the Commission has, influenced by a more competition policy-oriented approach.

It makes perfect sense that competition issues in modern times should be addressed as quickly and aptly as possible, and that the Art. 9 decisions are a relatively time-efficient method in order to negotiate on competitive conditions and safeguard consumer welfare in a particular industry. However, those offered commitments should be based on law, as the Union is founded on the rule of law, as Article 2 of the Treaty on European Union prescribes. Where such is completely or largely absent, as is in the case of Google's search algorithm and vertical search services, any Decision taken will not provide for *legal* certainty with regard to the respected undertakings.

Furthermore, with regard to the timeliness of the intervention, the same conclusion has to be drawn that no actual certainty is instated by the Commission. The Google VSS case has taken over three years in preparations and negotiations, and the Commitments Decision is yet to be written. As many of Google's adversaries in the procedure will utilise their right to go to Court, or at least have expressed their inclination to do so, it will take even more time before actual infringements will be uncovered. Hence, no actual certainty exists up until intervention by the Courts, as restricted as they may be. Consequently, the approach taken by the Commission, to wit, issuing more Commitments Decisions in high-technology or technology-enabled cases and industries with the aim of speeding up procedures and restoring competitive balances in markets, might turn out to be more counterproductive than beneficial for legal certainty.

Considering their nature, the commitments procedures might also not contribute to more or healthier competition. As acknowledged in *Alrosa*, companies "consciously accept" that their commitments may extend further than what the Commission is able to impose under Art. 7 Reg. 1/2003.<sup>294</sup> However, without a thorough legal or economic analysis, market entities that are under strong competitive pressures commit to restoring something to which they are not legally bound, let alone which is economically proven to be disrupted or even cause of reasonable concern.

#### *IV.4.2. Contents*

The procedure and the offered commitments have mostly focused on the first issue, which, therefore, also forms the centre of attention in this section. With the installation of Google's Universal Search, several algorithmic changes have taken place. Amongst these is the introduction of specific query-related boxes, that, depending on the query, are incorporated in the search results. The boxes indicate the responses of certain Google VSS to the particular query and invite the user to utilise that particular Google search service.<sup>295</sup>

This algorithmic update has had the consequence of prominently offering the utilisation of a Google downstream service, favoured over the general search engine optimised results. Competing VSS providers have not received these advantages, and, therefore, allege to experience unfair

---

<sup>294</sup> *Alrosa* case, par. 48.

<sup>295</sup> For instance, a query in the form of a sum or formula will display a box with the calculation; results for "dogs" will incorporate a box in the results that indicates pictures of dogs; "Gangnam Style" will incorporate YouTube clip pictures.

competition with Google's services. The firm appears not to have decreased the number of search results displayed on the first page nor to have altered the manner in which these are displayed.<sup>296</sup> Also, competing services could, still, by ways of effective Search Engine Optimization, reach top results; however, they opine to have a right to be favourably displayed in the Universal Search algorithm and results. Moreover, those rival results should be displayed prominently and distinctly from Google's services, so as to provide a choice for consumers.

#### *IV.4.2.1. The commitments*

In its Commitments document, Google has provided extensive declarations of the ways in which it will change its algorithms, and of its willingness to cooperate as swiftly as possible with the European Commission.<sup>297</sup> As there is little difference between the Commitments of April, of October 2013 and of January 2014, only the last will be discussed here. Essentially, Google promises to alter the design for Google EEA Search domains, effectuating several measures when a query entered in the *Google General Search Input Feature* (the engine) results in the application of so-called *Google Specialised Results Triggers* (the algorithmic response to queries, potentially leading to Google Specialised Search Results Pages).

Google will display its own VSS (more) distinctly from the normal, generalised Search content, for instance by using different graphics, and will display them clearly as Google services.<sup>298</sup> Also, where applicable, the firm will clearly advertise and link to alternatives, which it selects and ranks differently from its regular advertisement or organic search results ranking.<sup>299</sup> This counts both for desktop as mobile browsing applications.<sup>300</sup> Further, it will be applicable to all Google web domains in the EEA.<sup>301</sup>

In response to the other claims, Google has proposed an opt-out form for web administrators that do not wish Google to crawl any content from their website. This can both be on a full-domain basis, or only for a particular sub-domain.<sup>302</sup> For instance, it would be made possible for online weather applications to prevent Google from incorporating their information in its Search Weather OneBox.<sup>303</sup> A similar opt-out is enabled for the product, restaurants, hotels and travel VSS with regard to a list of predefined data, by ways of an HTML component that can be incorporated on the designated VSS web pages.<sup>304</sup>

Further, the opt-outs shall not be used in any way to affect the indexation or ranking order of any of the web services.<sup>305</sup> Also, with regard to the other points of accusation, Google will remove exclusivity conditions from contracts with AdSense advertisers. This enables website operators to also attract advertisements from competing ad networks;<sup>306</sup> likewise, advertisers are also enabled to multi-home with respect to move so-called User Campaign Data to competing ad networks.<sup>307</sup> A Monitoring Trustee will be appointed by Google and the Commission which will supervise Google's compliance.<sup>308</sup>

---

<sup>296</sup> Whether Google actually altered its Quality Score for competing services, or otherwise unfavourably and artificially disqualified the competing services, has not been made public.

<sup>297</sup> Google Commitments, p. 1, "to avoid the time, inconvenience, and expense of on-going proceedings".

<sup>298</sup> *Idem*, p. 2, pt. 2.

<sup>299</sup> *Idem*, selection principles and criteria in Annex 1, especially under "Auction Mechanism".

<sup>300</sup> Google Commitments, p. 4, pt. 5 (b).

<sup>301</sup> *Idem*, p. 8, pt. 26, under "Google EEA Search Domains".

<sup>302</sup> *Idem*, p. 6, pt. 11.

<sup>303</sup> The URL <google.nl/search?q=weather+ groningen> displays a box in Google's search results, consisting of information crawled from several weather services.

<sup>304</sup> Google Commitments, p. 7, pt. 18, in conjunction with Annex 5.

<sup>305</sup> *Idem*, p. 6-7, e.g., pts. 13, 15, 21.

<sup>306</sup> *Idem*, p. 10-13, pts. 27-32

<sup>307</sup> *Idem*, p.13-15, pts. 33-38.

<sup>308</sup> *Idem*, p. 15-21, pts. 41-71.

The Commitments relate only to the mentioned products, hotels, restaurants and flight search services. For other VSS, be it for persons (Google+), for mapping services in general (Google Maps), for images (Google Image Search) or for many other VSS that Google holds, the Commission has regarded either that the services provided by Google are efficient in and of themselves, or are in general not urging for the provision of consumer choice.<sup>309</sup>

#### *IV.4.2.2. Essential facilities doctrine?*

Whereas the previous section covered the contents of the Commitments, addressing the four concerns of the Commission, the solution of the granted access to Google's vertical search service is of particular relevance. Especially with regard to assessing the dominance of a player on a market, the so-called *essential facilities doctrine* is often adhered to.<sup>310</sup> The question, however, is whether or not Google possesses an essential facility, let alone whether the firm is obliged to grant access to it.

This doctrine concerns particular types of abuse of dominance cases, in which a dominant undertaking holds a certain facility, be it a distribution or transportation network, or a particular IP right. A competitor on a downstream service experiences an obstruction to competition on that downstream market, because it is not granted equal access compared to the vertically integrated downstream service.<sup>311</sup> Google is supposedly operating both on an upstream market, in which it holds the essential facility for distributing downstream VSS (the GOSE), and on a downstream market, in which it favours its own services by displaying them more prominently than competing services.<sup>312</sup>

The mentioned claimants and the Commission, under the guise of consumer choice, indirectly opine that Google is refusing access to the search engine services. Essentially, however, they desire to be ranked higher, in order to attract more attention to their respective services, without paying for it.<sup>313</sup> Nevertheless, all competitors have access to Google, apart from those who wish not to be indexed; what is more, they are indexed for free.<sup>314</sup> Under normal circumstances, they would have to improve their website to an extent that would optimise their search engine listing.<sup>315</sup> Also, if they wish to improve their position by ways of paying for it, such is possible through Google's AdWords services.<sup>316</sup>

---

<sup>309</sup> No official statement as such has been released by the European Commission or other party, but T. Graf, one of the lawyers at the side of Google in this investigation, revealed this after his presentation "The EU Google Investigation. A Remedy In Search Of A Problem", at the AIJA conference in Bruges, 7 February 2014, available online at <commissions.aija.org/antitrust/files/Graf-The-EU-Google-Investigation.pdf> (accessed 18 September 2014).

<sup>310</sup> Which is a specific type of refusal to supply access to a dominant undertaking's, see e.g. A. Jones & B. Sufrin 2012, p. 486 ff., or R. Whish & D. Bailey 2012, p. 697 ff.

<sup>311</sup> S. Anderman, "The Epithet that Dares not Speak its Name: The essential Facilities Concept in Article 82 EC and IPRs after the *Microsoft* Case", in: A. Ezrachi, eds., *Article 82 EC: Reflections on its recent Evolution*, Oxford, Hart Publishing 2009, p. 88-89.

<sup>312</sup> Other authors have commenced applying the essential facilities framework on search engines, such as Google as well. See, e.g., F. Pasquale, G.A. Manne, J. Grimmelmann & E. Goldman, "Chapter 7: Is Search Now An Essential Facility?" in: B. Szoka & A. Marcus, *The Next Digital Decade: Essays on the Future of the Internet*, Washington D.C., TechFreedom 2010, p. 399-474.

<sup>313</sup> The argument mentioned here was derived from Landgericht Hamburg, Beschluss of 04 April 2013, *Verband Wetterdienstleister v. Google*, reference 408 HKO 36/13.

<sup>314</sup> *Idem*, p. 5

<sup>315</sup> A process called SEO or Search Engine Optimization, relating to the manner by ways of which a web page can increase its rank in organic search results.

<sup>316</sup> Sources report that in connection to the offered commitments, Google will also organize a special type of AdWords auction, arranged solely for the involved parties' VSS's. See A. White, "Google Ends EU Antitrust Probe Pledging Rival Links", 6 February 2014, *Bloomberg Technology*, available online at <bloomberg.com/news/2014-02-05/google-clinches-eu-antitrust-pact-with-pledge-over-rivals-links.html> (accessed 18 September 2014). Hence, the complainants' service providers will be favoured advertisers.

Not for nothing, the case law in the EU has brought forward a substantial threshold before prohibiting a refusal to supply access to an essential facility.<sup>317</sup> Access to particular facilities can stifle innovation for the undertaking concerned. Also, it can prevent efficiencies from being passed down to consumers, as the granting of equal access will cost a monopoly a share of its customers. Generally, the conditions are as follows: it has to concern the creation of a new product; the access to the facility has to be indispensable (no substitute is available); not having access has to eliminate all further competition; and the refusal to supply access is not objectively justifiable.<sup>318</sup>

In this respect, the Landgericht Hamburg decided recently in a case involving similar facts against Google's Weather OneBox.<sup>319</sup> In short, the court decided that the applicant (Verband Deutscher Wetterdienstleister) had no grounds for receiving injunctive relief, because Google is to be awarded *decisional discretion* for adapting its engine, in order to make the engine more attractive to competing engine users.<sup>320</sup> Google directly experiences the consequences of any change in its algorithm, and withholding a company from innovating as it regards as beneficial for combating the competition it experiences (on the upstream level) is not what the concept competition on the merits entails.<sup>321</sup>

## IV.5. Conclusion

The law covering dominance in the European Union is not self-evident. The rules and case law on dominant positions remain quite open for interpretation, and as far as clear rules can be derived, for novel markets it delivers issues both on market definitions and on dominance analyses. This chapter did not essentially strive for incorporating economic theories in competition law analyses. However, due to the incompleteness of the law in this respect and the necessity of legal certainty, EU competition law as regards dominance has to move and is actually doing so. As such, classic, static, methodologies underlying the Commission's assessments have to be reappraised.

Irrespective of the irregularities, under current competition law, it is not possible to regard Google as dominant in the market for search engines. Network effects might exist on the various sides of Google's network, yet users on all sides multi-home as well. There is no fixed price on Search or on crawling, and in a Google auction framework, advertisers decide on the price they are willing to pay in order to stay on their respective ad ranks. Moreover, considering the recent case law, there is no technical or economic barrier for consumers to switch from service provider. Hence, switching costs are low, meaning any consumer is free to choose its provider, a goal to which the EU law enforcers strongly adhere.

---

<sup>317</sup> ECJ, Joined cases 6 and 7/73 of 6 March 1974, *Istituto Chemioterapico Italiano S.p.A. and Commercial Solvents Corporation v Commission of the European Communities*, ECLI:EU:C:1974:18, para. 25; ECJ, case 311/84 of 3 October 1985, *Centre belge d'études de marché - Télémarketing (CBEM) v SA Compagnie luxembourgeoise de télédiffusion (CLT) and Information publicité Benelux (IPB)*, ECLI:EU:C:1985:394, paras. 25-27.; and ECJ, Joined cases C-241/91 P and C-242/91 P of 6 April 1995, *Radio Telefis Eireann (RTE) and Independent Television Publications Ltd (ITP) v Commission of the European Communities (Magill)*, ECLI:EU:C:1995:98, paras. 49-56. See also S. Anderman 2009.

<sup>318</sup> ECJ, case C-7/97 of 26 November 1998, *Oscar Bronner GmbH & Co. KG v Mediaprint Zeitungs- und Zeitschriftenverlag GmbH & Co. KG, Mediaprint Zeitungsvertriebsgesellschaft mbH & Co. KG and Mediaprint Anzeigengesellschaft mbH & Co. KG (Bronner)*, ECLI:EU:C:1998:569, par. 40-41.

<sup>319</sup> When "weather" (accessed 18 September 2014) is entered in Google Search, on the basis of the IP connected to the query, it will provide a thorough overview of the weather conditions in your vicinity in a box at the top of the results page. See Landgericht Hamburg, Beschluss vom 04 April 2013, *Verband Wetterdienstleister v. Google*, reference 408 HKO 36/13.

<sup>320</sup> In the authoritative German translation: "[w]obei der Antragsgegnerin zu 1. als Betreiberin der Suchmaschine eine *Einschätzungsprärogative* zuzubilligen ist, da sie es ist, die auch die Folgen einer etwaigen Fehleinschätzung zu tragen hätte. [italics added]". *Idem*, p.4

<sup>321</sup> In the authoritative German translation: "[a]nders formuliert: [Google] soll auf die von ihr für richtig gehaltene Innovation verzichten müssen [...] Es liegt auf der Hand, dass ein richtig verstandener Leistungswettbewerb dies keinesfalls erfordert." *Idem*, p. 3-4.

The conclusion on dominance has important implications for the decision on abuse. Legally, an establishment of dominance is necessary before assessing the conduct on the market.<sup>322</sup> A non-dominant undertaking is, therefore, not capable of infringing Art. 102 TFEU. Nevertheless, by stating its concerns in the Commitments procedure, the Commission implies that Google in fact is dominant. Furthermore, the inertia of consumers – and the pressure from downstream VSS providers – has led the Commission to regard equal access for competitors necessary. The clicking behaviour of the majority of consumers on search engines, which does not go beyond the first results page and the first clickable item, was the main concern for the EC to instigate these proceedings. Apparently, only when a competitor is listed on page one, it will be seen a serious competitor.<sup>323</sup> At the time of this writing, the actual final commitments made by Google are not yet disclosed in a Commission Decision.<sup>324</sup> However, at the outset it should be noted that Google provides indexing services to all websites for free, hence provides them with the possibility to be found by users which are not yet acquainted with the particular service. When Google incorporates information from third party web pages in its search boxes, without authorization and without users being directed towards the particular pages, this will then account for a loss of traffic of the respective service. Hence, that is logical to be addressed, as Google benefits from this.<sup>325</sup> In essence, it boils down to an obscured principal-agent issue, in which the Commission and the respective entity both seem to have no clear view on the rules. Moreover, the Commission seems to have degraded from enforcing principal of competition rules, to an agent that is subject to industry interests. In other words, competition procedures have become another possibility by ways of which the giants of the internet and software industry can compete with each other.

---

<sup>322</sup> As was established in *Continental Can*, par. 32.

<sup>323</sup> However, it remains to be seen whether this is because search engines respond more properly to queries, or whether end users “understand” search engines and the way information can be gathered, better. If a query does not lead to the first hits being relevant results, then it is likely due to the quality of the query entered, and not only due to the quality of the algorithm.

<sup>324</sup> EC Press Release, “Antitrust: Commission obtains from Google comparable display of specialised search rivals”, 5 February 2014, Brussels, IP/14/116. See also EC Memo, “Antitrust: Commission obtains from Google comparable display of specialised search rivals- Frequently asked questions”, 5 February 2014, MEMO/14/87.

<sup>325</sup> In the US FTC Settlement, Google committed to “refrain from misappropriating online content from so-called “vertical” websites that focus on specific categories such as shopping or travel for use in its own vertical offerings”, see FTC, “Google Agrees to Change Its Business Practices to Resolve FTC Competition Concerns In the Markets for Devices Like Smart Phones, Games and Tablets, and in Online Search”, 3 January 2013, available online at <[ftc.gov/news-events/press-releases/2013/01/google-agrees-change-its-business-practices-resolve-ftc](http://ftc.gov/news-events/press-releases/2013/01/google-agrees-change-its-business-practices-resolve-ftc)> (accessed 18 September 2014). This, however, does not seem to have been the content of the Commission’s probe.

## V. Conclusion

In little over sixty years, technological developments with regard to computers, internetworking and the World Wide Web have drawn considerable consumer and business interest. Complex formulas, protocols and algorithms have made it possible for any European citizen with an internet connection to search for and to acquire whatever information is available pretty much anywhere in the world. The desire to mutually connect and share information has created close to innumerable web pages, and various physical and software-based, interconnected networks. Online search, forming one of these networks, has not only proven to meet a staggering demand for indexation and categorization of online web content, but also to be a fruitful business for connecting people to this information.

Economic theories on multi-sided platforms are still in development; however, a mainstream concept of multi-sided markets can be abstracted and applied to online search. By ways of these, Google Search successfully performs as a three-sided platform market, mutually drawing consumers to websites and to advertisers. The role that network effects play on these platforms is likely to have a continuous, perhaps even evolving effect on economic thought, and potentially also on competition law thought.

The research into the law and case law of the European Union on the application of network effects and potential dominance has shown that economic theories not necessarily lead the law, as, for instance, is shown in the *MIF* case. This would confirm the Bishop and Walker opinion that not every two-sided market should lead to a reappraisal of antitrust assessments. In the case of online search, however, it is indicated that classic methodology is not satisfactorily applicable, and should therefore change. Still, this indication is based on law that is relatively undeveloped; insofar as current law is applicable and definable, Google Inc. cannot be regarded as dominant on the market for generalised online search engines.

Whereas, generally, law enforcement shuts the stable door when the horse has bolted, competition law procedures have difficulties in correcting current market processes in a timely manner. Quick Art. 102 TFEU procedures are recommended for quickly-evolving markets. By Commission prerogative, infringement procedures are seemingly utilised less; instead, Commitments procedures have taken their place. However, these are merely subject to marginal judicial review by the Courts, as was ruled in *Alrosa*, and limited legal certainty can, therefore, be derived from the coming Google Commitments procedure. In all, not a fully satisfying picture.

In short, from technological, economic and legal perspectives, the online search market is complex to identify and to distinguish from neighbouring, interwoven markets. Consequently, for these and similar markets, it requires time, effort and expertise to take all these hurdles. The ultimate solution would be a legal model or framework by ways of which competition law enforcing agencies could swiftly address the concerns discovered in markets, where both legal and economic theories are incorporated. That will be a challenge for the future.

Consequently, with regard to the main research question, it must be held that the current methodological framework, both on defining markets and on assessing dominant positions is insufficient for addressing issues in the market/markets for online search. Whether the main research question can be answered to full gratification, or what the solution to the problem should be, are questions that further research (and more case law) should address. As the case law of EU Competition law in this area is rather thin, it would be sensible to pursue a continuing research into comparative law of the United States and European Union on this topic. In conclusion, the following is evident: the conundrum that Google Incorporated has posed to standing competition law and its procedures, is a query that no simple Google search can solve.