

University of Groningen

Genetic and clinical characterisation of arrhythmogenic cardiomyopathy

Zwaag, Paul Arjen van der

IMPORTANT NOTE: You are advised to consult the publisher's version (publisher's PDF) if you wish to cite from it. Please check the document version below.

Document Version

Publisher's PDF, also known as Version of record

Publication date:

2012

[Link to publication in University of Groningen/UMCG research database](#)

Citation for published version (APA):

Zwaag, P. A. V. D. (2012). *Genetic and clinical characterisation of arrhythmogenic cardiomyopathy*. s.n.

Copyright

Other than for strictly personal use, it is not permitted to download or to forward/distribute the text or part of it without the consent of the author(s) and/or copyright holder(s), unless the work is under an open content license (like Creative Commons).

The publication may also be distributed here under the terms of Article 25fa of the Dutch Copyright Act, indicated by the "Taverne" license. More information can be found on the University of Groningen website: <https://www.rug.nl/library/open-access/self-archiving-pure/taverne-amendment>.

Take-down policy

If you believe that this document breaches copyright please contact us providing details, and we will remove access to the work immediately and investigate your claim.

Downloaded from the University of Groningen/UMCG research database (Pure): <http://www.rug.nl/research/portal>. For technical reasons the number of authors shown on this cover page is limited to 10 maximum.

Genetic and clinical characterisation of arrhythmogenic cardiomyopathy

Paul van der Zwaag

ISBN: 978-90-367-5752-2

ISBN: 978-90-367-5753-9 (E-book)

Cover design: Rieuwerd Tillema

The cover shows a model of the phospholamban gene, created during 'De Nacht van Kunst & Wetenschap' in the Der Aa-kerk in Groningen, 4 June 2011 (photo: Leen van Wijngaarden, Fablab Groningen).

Layout and printing: Optima Grafische Communicatie, Rotterdam, the Netherlands

© Copyright: Paul van der Zwaag, 2012

All rights reserved. No part of this thesis may be reproduced in any form or by any means, electronic, mechanical, by photocopying, recording, or otherwise, without prior written permission of the author. The copyrights of the publications remain with the publisher.

Financial support by the Graduate School of Medical Sciences of the University Medical Center Groningen and University of Groningen and the Dutch Heart Foundation for the publication of this thesis is gratefully acknowledged.

The research described in this thesis was supported by a grant of the Dutch Heart Foundation (DHF-2007B132).

*funded by the
dutch heart foundation*





rijksuniversiteit
 groningen

Genetic and clinical characterisation of arrhythmogenic cardiomyopathy

Proefschrift

ter verkrijging van het doctoraat in de
 Medische Wetenschappen
 aan de Rijksuniversiteit Groningen
 op gezag van de
 Rector Magnificus, dr. E. Sterken,
 in het openbaar te verdedigen op
 maandag 19 november 2012
 om 12.45 uur

door

Paul Arjen van der Zwaag

geboren op 28 januari 1983
 te Groningen

Promotores: Prof.dr. R.M.W. Hofstra
Prof.dr. M.P. van den Berg

Copromotores: Dr. J.D.H. Jongbloed
Dr. J.P. van Tintelen

Beoordelingscommissie: Prof.dr. V.V.A.M. Knoers
Prof.dr. J.E. Saffitz
Prof.dr. A.A.M. Wilde

Paranimfen:

Peter van den Akker
Evert Wieringa

Aan mijn ouders

TABLE OF CONTENTS

1	General introduction	9
	Aims and outline of this thesis	24
2	Haplotype sharing test maps genes for familial cardiomyopathies <i>Clin Genet.</i> 2011;79:459-67.	47
3	Clinical and genetic characterisation of patients with arrhythmogenic right ventricular dysplasia/cardiomyopathy caused by a plakophilin 2 splice mutation <i>Cardiology.</i> In press.	65
4	Recurrent and founder mutations in the Netherlands – Plakophilin 2 p.Arg79X mutation causing arrhythmogenic right ventricular cardiomyopathy/dysplasia <i>Neth Heart J.</i> 2010;18:583-91.	81
5	A genetic variants database for arrhythmogenic right ventricular dysplasia/cardiomyopathy <i>Hum Mutat.</i> 2009;30:1278-83.	99
6	Arrhythmogenic right ventricular dysplasia/cardiomyopathy – Pathogenic desmosome mutations in index patients predict outcome of family screening. Dutch arrhythmogenic right ventricular dysplasia/cardiomyopathy genotype-phenotype follow-up study <i>Circulation.</i> 2011;123:2690-700.	117

7	Phospholamban R14del mutation in patients diagnosed with dilated cardiomyopathy or arrhythmogenic right ventricular cardiomyopathy: Evidence supporting the concept of arrhythmogenic cardiomyopathy <i>Eur J Heart Fail. In press.</i>	145
8	Recurrent and founder mutations in the Netherlands – Phospholamban p.Arg14del mutation causes arrhythmogenic cardiomyopathy <i>Manuscript in preparation</i>	175
9	Left-dominant arrhythmogenic cardiomyopathy in a large family: Associated desmosomal or non-desmosomal genotype? <i>Submitted</i>	191
10	Summary	209
	General discussion	215
	List of abbreviations	236
	List of authors and affiliations	238
	List of publications	244
	Nederlandse samenvatting	246
	Curriculum vitae	252
	Dankwoord	254

1

General introduction

Aims and outline of this thesis

GENERAL INTRODUCTION

Cardiomyopathies are an important cause of heart disease, affecting an estimated 40,000 (0.25%) individuals in the Netherlands.¹ They are characterised by abnormal myocardial structure and/or function. Other non-genetic causes that could result in the observed myocardial abnormality must first be excluded in order to make the diagnosis. Examples of these are coronary artery disease, hypertension, valvular disease, myocarditis and congenital heart disease. Different cardiomyopathy subtypes can be recognised: hypertrophic, dilated, arrhythmogenic, and restrictive cardiomyopathy.² According to the classification system proposed by the European Society of Cardiology, it is not clear whether left ventricular non-compaction cardiomyopathy (NCCM) is a separate cardiomyopathy. However, the classification system proposed by the American Heart Association includes NCCM as a separate entity and also includes cardiac ion channel disorders and channelopathies.^{2,3}

In 1990, the first mutation underlying cardiomyopathy was identified in the β -myosin heavy chain (*MYH7*) gene in a large family with hypertrophic cardiomyopathy (HCM).^{4,5} Since then, mutations in over 60 genes have been associated with cardiomyopathies (Figure 1 and Table 1). The inheritance pattern of cardiomyopa-

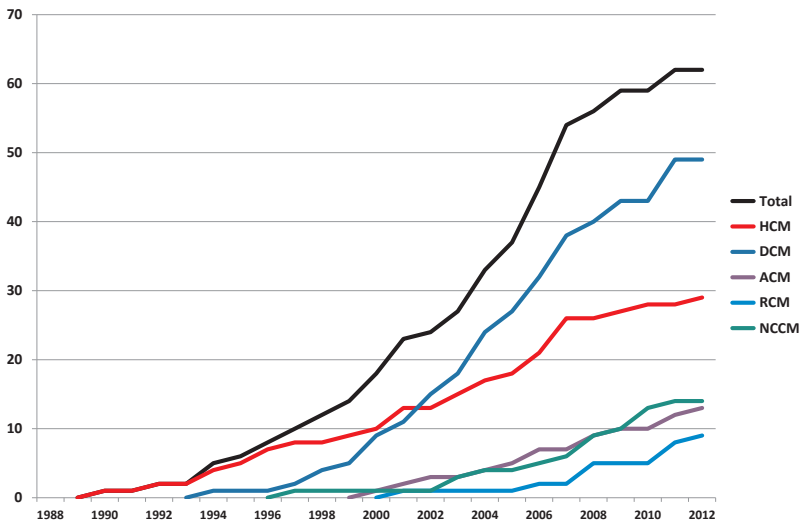

Figure 1 Total number of genes associated with one or more cardiomyopathy subtype reported since 1990. The total number of associated cardiomyopathy genes is shown by the black line. Per cardiomyopathy subtype the novel associated genes are listed since the first publication in 1990 of a mutation in the *MYH7* gene in HCM by Geisterfer-Lowrance et al.⁵ Since many genes have been associated with multiple cardiomyopathy subtypes, the line of the total number of associated genes is not the sum of all lines of the cardiomyopathy subtypes (see Table 1).

Table 1 Genes associated with one or more cardiomyopathy subtypes

Gene	Name	Locus	OMIM	HCM	DCM	ACM	RCM	NCCM	References
<i>ABCC9</i>	ATP-binding cassette 9	12p12.1	601439		x				67
<i>ACT1</i>	Actin, alpha cardiac muscle	15q14	102540	x	x		x	x	68-77
<i>ACTN2</i>	Actinin, alpha 2	1q43	102573	x	x				78-80
<i>ANKRD1</i>	Ankyrin repeat domain-containing protein 1	10q23.3	609599	x	x				81-83
<i>BAG3</i>	BCL2-associated athanogene 3	10q26.11	603883		x				84,85
<i>CALR3</i>	Calreticulin 3	19p13.11	611414	x					86
<i>CASQ2</i>	Calsequestrin	1p13.1	114251	x				x	77,86
<i>CAV3</i>	Caveolin 3	3p25.3	601253	x	x				87-89
<i>CRYAB</i>	Crystallin alpha-B	11q23.1	123590		x				90
<i>CSRP3</i>	Cysteine- and glycine-rich protein 3	11p15.1	600824	x	x				70,78,80,91-94
<i>DES</i>	Desmin	2q35	125660		x	x	x		29,48,49,95-103
<i>DMD</i>	Dystrophin	Xp21.2	300377		x				104-107
<i>DSC2</i>	Desmocollin 2	18q12.1	125645			x			22,25,26,28,31,108-112
<i>DSG2</i>	Desmoglein 2	18q12.1	125671		x	x			21,24-26,28,31,38,111,113-116
<i>DSP</i>	Desmoplakin	6p24.3	125647		x	x		x	19,24-26,28,31,62,113,116-120
<i>DTNA</i>	Dystrobrevin alpha	18q12.1	601239					x	121
<i>EMD</i>	Emerin	Xq28	300384		x				122
<i>EYA4</i>	Eyes absent 4	6q23.2	603550		x				123
<i>FHL2</i>	Four-and-a-half LIM domains 2	2q12	602633		x				124
<i>FKRP</i>	Fukutin-related protein	19q13.32	606596		x				125-128
<i>FKTN</i>	Fukutin	9q31.2	607440		x				129
<i>GATAD1</i>	GATA zinc finger domain-containing protein 1	7q21.2	614518		x				130
<i>GLA</i>	Galactosidase alpha	Xq22.1	300644	x					131-135
<i>ILK</i>	Integrin-linked kinase	11p15.4	602366		x				136
<i>JPH2</i>	Junctophilin 2	20q13.12	605267	x					137,138
<i>JUP</i>	Junction plakoglobin	17q21.2	173325		x	x			16,23-25,28,113,139
<i>LAMA4</i>	Laminin alpha-4	6q21	600133		x				136
<i>LAMP2</i>	Lysosome-associated membrane protein 2	Xq24	309060	x	x				140-146
<i>LDB3</i>	LIM domain binding 3	10q23.2	605906	x	x			x	77,78,94,121,147-149
<i>LMNA</i>	Lamin A/C	1q22	150330		x	x		x	54,77,150-154
<i>MYBPC3</i>	Myosin-binding protein C	11p11.2	600958	x	x			x	69-72,77,152,155-168
<i>MYH6</i>	Myosin heavy chain 6	14q11.2	160710	x	x				152,166,169
<i>MYH7</i>	Myosin heavy chain 7	14q11.2	160760	x	x		x	x	5,69-72,74,94,152,153,158,162-167,170-176
<i>MYL2</i>	Myosin light chain 2	12q24.11	160781	x			x		158,163,177-179
<i>MYL3</i>	Myosin light chain 3	3p21.31	160790	x			x		70,71,158,163,177,179,180
<i>MYLK2</i>	Myosin light chain kinase 2	20q13.3	606566	x					181
<i>MYOZ2</i>	Myozenin 2	4q26	605602	x					182
<i>MYPN</i>	Myopalladin	10q21.1	608517	x	x		x		183,184
<i>NEXN</i>	Nexilin	1p31.1	613121	x	x				185,186

Table 1 Genes associated with one or more cardiomyopathy subtypes (continued)

Gene	Name	Locus	OMIM	HCM	DCM	ACM	RCM	NCCM	References
<i>PDLIM3</i>	PDZ and LIM domain protein 3	4q35.1	605889		x				187
<i>PKP2</i>	Plakophilin 2	12p11.21	602861		x	x			20,24-26,28,31,113,116,188-191
<i>PLN</i>	Phospholamban	6q22.31	172405	x	x	x		x	77,86,192-196
<i>PRKAG2</i>	Protein kinase AMP-activated, gamma-2	7q36.1	602743	x					69,143,197,198
<i>PSEN1</i>	Presenilin 1	14q24.2	104311		x				199
<i>PSEN2</i>	Presenilin 2	1q42.13	600759		x				166,199
<i>RBM20</i>	RNA-binding motif protein 20	10q25.2	613171		x				153,200-202
<i>RYR2</i>	Ryanodine receptor 2	1q43	180902		x	x			42,203
<i>SCN5A</i>	Sodium channel, type V, alpha subunit	3p22.2	600163		x	x		x	94,152,166,204-209
<i>SGCD</i>	Sarcoglycan, delta	5q33.3	601411		x				210,211
<i>TAZ</i>	Tafazzin	Xq28	300394		x			x	77,121,149,212-215
<i>TBX20</i>	T-box 20	7p14.2	606061		x				216
<i>TCAP</i>	Titin-cap	17q12	604488	x	x				78,92,94,217
<i>TGFB3</i>	Transforming growth factor, beta 3	14q24.3	190230			x			41
<i>TMEM43</i>	Transmembrane protein 43	3p25	612048			x			218
<i>TMPO</i>	Thymopoietin	12q23.1	188380		x				219
<i>TNNC1</i>	Troponin C	3p21.1	191040	x	x				152,220-224
<i>TNNI3</i>	Troponin I	19q13.42	191044	x	x		x	x	68-72,74,75,77,152,153,158,162,163,171,175,225-230
<i>TNNT2</i>	Troponin T2	1q32.1	191045	x	x		x	x	68-71,75-77,94,152,153,158,162,165,166,171,173,222,231-234
<i>TPM1</i>	Tropomyosin 1	15q22.2	191010	x	x		x	x	68,70,72,77,152,168,171,179,231,232,235-237
<i>TTN</i>	Titin	2q31.2	188840	x	x	x			50-53,238-240
<i>TXNRD2</i>	Thioredoxin reductase 2	22q11.21	606448		x				241
<i>VCL</i>	Vinculin	10q22.2	193065	x	x				78,242-244

HCM indicates hypertrophic cardiomyopathy; DCM, dilated cardiomyopathy; ACM, arrhythmic cardiomyopathy; RCM, restrictive cardiomyopathy; NCCM, non-compaction cardiomyopathy.

thies is most commonly autosomal dominant, but autosomal recessive, X-linked and mitochondrial inheritance patterns have also been observed. Inherited cardiomyopathies are characterised by incomplete and age-related penetrance. The proportion of individuals carrying a mutation (genotype) with associated clinical symptoms (phenotype) increases with age, but virtually never reaches 100%. Incomplete penetrance implies that some mutation carriers will remain unaffected during their entire life. The onset of symptoms is usually after adolescence or in early adulthood, but children with severe forms of cardiomyopathy have been described. Some of these cases have been associated with multiple mutations.^{6,7} A selection bias has led to the situation that the first publications described the most severely affected cardiomyopathy patients. However, subsequent studies also included patients with

a milder phenotype, pointing out that these disorders may not be as severe as initially believed, although the course can still be very grave. The range in both type and severity of the disease between individuals carrying the same mutation, even within the same family, is called variable expression.⁸

Inherited cardiomyopathies are not only clinically variable; the genetic background is also heterogeneous. For each cardiomyopathy, multiple disease genes have been identified. Mutations in several genes, especially in those genes coding for sarcomeric proteins, can cause different cardiomyopathy subtypes (Table 1 and Figure 2). Since 1990, the number of genes associated with one or multiple forms

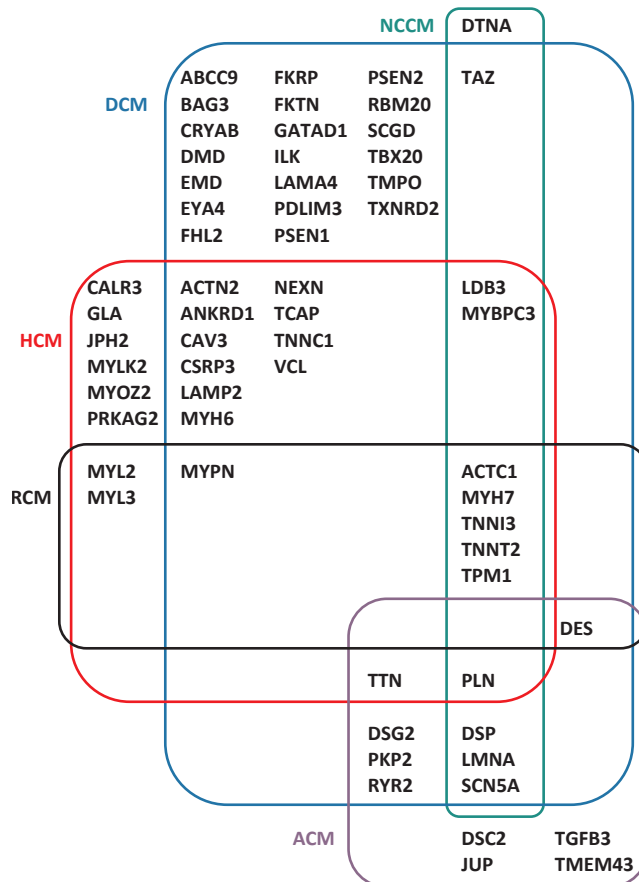

Figure 2 Genetic heterogeneity and overlap in genes causing cardiomyopathies. This figure shows the genes underlying hypertrophic cardiomyopathy (HCM), dilated cardiomyopathy (DCM), arrhythmogenic cardiomyopathy (ACM), restrictive cardiomyopathy (RCM), and non-compaction cardiomyopathy (NCCM). The genes correspond with Table 1. The figure is based on Van Spaendonck et al. (2008)⁶⁵ and Jongbloed et al. (2011).⁶⁶

of cardiomyopathy has increased rapidly (Figure 1). This thesis focuses on the genetic and clinical aspects of arrhythmogenic cardiomyopathy (ACM), which will be discussed in more detail below.

Arrhythmogenic cardiomyopathy

In 1982, Marcus et al. described a comprehensive series of patients diagnosed with “right ventricular dysplasia”. These patients were characterised by life-threatening ventricular arrhythmias, originating from the right ventricle (RV).⁹ The cause of the disease was believed to be a developmental defect of the myocardial tissue of the RV, resulting in the use of the term “right ventricular dysplasia”. However, the finding that the RV myocardium is subject to cell death and is subsequently replaced by fibrous and fatty tissue, which interferes with electrical conduction of the heart and results in arrhythmias, later led to the concept of arrhythmogenic right ventricular cardiomyopathy (ARVC).¹⁰ In addition to this classic form of ARVC, biventricular and left-dominant forms have been recognised.^{11,12} Nowadays, the encompassing term “arrhythmogenic cardiomyopathy” (ACM) is increasingly used. Men are more frequently affected than women and the estimated prevalence in the general population ranges from 1 in 1,000 to 1 in 5,000.¹³

An international task force proposed diagnostic criteria for ARVC in 1994.¹⁴ These clinical criteria comprise six different categories, including structural and histological findings, depolarisation and repolarisation abnormalities, arrhythmias, and family history. Major and minor criteria were defined for each category. A diagnosis can be made if a patient fulfils two major criteria, one major and two minor criteria, or four minor criteria, all from different categories. These 1994 criteria were found to be highly specific but not sensitive enough. To overcome this issue, the criteria were modified in 2010, while maintaining the six different categories and including the results of genetic studies (Table 2).¹⁵

Table 2 Revised task force criteria for the diagnosis of ARVC[#]

Major	Minor
I. Global or regional dysfunction and structural alterations*	
<p>By 2D echo:</p> <ul style="list-style-type: none"> • Regional RV akinesia, dyskinesia, or aneurysm • <i>and</i> 1 of the following (end diastole): <ul style="list-style-type: none"> - PLAX RVOT ≥ 32 mm (corrected for body size [PLAX/BSA] ≥ 19 mm/m²) - PSAX RVOT ≥ 36 mm (corrected for body size [PSAX/BSA] ≥ 21 mm/m²) - <i>or</i> fractional area change $\leq 33\%$ <p>By MRI:</p> <ul style="list-style-type: none"> • Regional RV akinesia or dyskinesia or dyssynchronous RV contraction • <i>and</i> 1 of the following: <ul style="list-style-type: none"> - Ratio of RV end-diastolic volume to BSA ≥ 110 mL/m² (male) or ≥ 100 mL/m² (female) - <i>or</i> RV ejection fraction $\leq 40\%$ <p>By RV angiography:</p> <ul style="list-style-type: none"> • Regional RV akinesia, dyskinesia, or aneurysm 	<p>By 2D echo:</p> <ul style="list-style-type: none"> • Regional RV akinesia or dyskinesia • <i>and</i> 1 of the following (end diastole): <ul style="list-style-type: none"> - PLAX RVOT ≥ 29 to < 32 mm (corrected for body size [PLAX/BSA] ≥ 16 to < 19 mm/m²) - PSAX RVOT ≥ 32 to < 36 mm (corrected for body size [PSAX/BSA] ≥ 18 to < 21 mm/m²) - <i>or</i> fractional area change > 33 to $\leq 40\%$ <p>By MRI:</p> <ul style="list-style-type: none"> • Regional RV akinesia or dyskinesia or dyssynchronous RV contraction • <i>and</i> 1 of the following: <ul style="list-style-type: none"> - Ratio of RV end-diastolic volume to BSA ≥ 100 to < 110 mL/m² (male) or ≥ 90 to 100 mL/m² (female) - <i>or</i> RV ejection fraction $> 40\%$ to $\leq 45\%$
II. Tissue characterisation	
<ul style="list-style-type: none"> • Residual myocytes $< 60\%$ by morphometric analysis (or $< 50\%$ if estimated), with fibrous replacement of the RV free wall myocardium in ≥ 1 sample, with or without fatty replacement of tissue on endomyocardial biopsy 	<ul style="list-style-type: none"> • Residual myocytes 60% to 75% by morphometric analysis (or 50% to 65% if estimated), with fibrous replacement of the RV free wall myocardium in ≥ 1 sample, with or without fatty replacement of tissue on endomyocardial biopsy
III. Repolarisation abnormalities	
<ul style="list-style-type: none"> • Inverted T waves in right precordial leads (V₁, V₂, and V₃) or beyond in individuals > 14 years of age (in the absence of complete right bundle-branch block QRS ≥ 120 ms) 	<ul style="list-style-type: none"> • Inverted T waves in leads V₁ and V₂ in individuals > 14 years of age (in the absence of complete right bundle-branch block) or in V₄, V₅, or V₆ • Inverted T waves in leads V₁, V₂, V₃, and V₄ in individuals > 14 years of age in the presence of complete right bundle-branch block
IV. Depolarisation/conduction abnormalities	
<ul style="list-style-type: none"> • Epsilon wave (reproducible low-amplitude signals between end of QRS complex to onset of the T wave) in the right precordial leads (V₁ to V₃) 	<ul style="list-style-type: none"> • Late potentials by SAECC in ≥ 1 of 3 parameters in the absence of a QRS duration of ≥ 110 ms on the standard ECG • Filtered QRS duration (fQRS) ≥ 114 ms • Duration of terminal QRS < 40 μV (low-amplitude signal duration) ≥ 38 ms • Root-mean-square voltage of terminal 40ms < 20 μV • Terminal activation duration of QRS ≥ 55 ms measured from the nadir of the S wave to the end of the QRS, including R', in V₁, V₂, or V₃, in the absence of complete right bundle-branch block

Table 2 Revised task force criteria for the diagnosis of ARVC[#] (continued)

Major	Minor
V. Arrhythmias	
<ul style="list-style-type: none"> • Non-sustained or sustained ventricular tachycardia of left bundle-branch morphology with superior axis (negative or indeterminate QRS in leads II, III, and aVF and positive in lead aVL) 	<ul style="list-style-type: none"> • Non-sustained or sustained ventricular tachycardia of RV outflow configuration, left bundle-branch block morphology with inferior axis (positive QRS in leads II, III, and aVF and negative in lead aVL) or of unknown axis • 500 ventricular extrasystoles per 24 hours (Holter)
VI. Family history	
<ul style="list-style-type: none"> • ARVC confirmed in a first-degree relative who meets current Task Force criteria • ARVC confirmed pathologically at autopsy or surgery in a first-degree relative • Identification of a pathogenic mutation[†] categorised as associated or probably associated with ARVC in the patient under evaluation 	<ul style="list-style-type: none"> • ARVC confirmed in a second-degree relative who meets current Task Force criteria • History of ARVC in a first-degree relative in whom it is not possible or practical to determine whether the family member meets current Task Force criteria • Premature sudden death (<35 years of age) due to suspected ARVC in a first-degree relative • ARVC confirmed pathologically or by current Task Force criteria in second-degree relative

PLAX indicates parasternal long-axis view; RVOT, RV outflow tract; BSA, body surface area; PSAX, parasternal short-axis view; aVF, augmented voltage unipolar left foot lead; and aVL, augmented voltage unipolar left arm lead. Diagnostic terminology for the revised criteria: definite diagnosis: 2 major, or 1 major and 2 minor criteria, or 4 minor criteria from the different categories; borderline: 1 major and 1 minor, or 3 minor criteria from the different categories; possible: 1 major or 2 minor criteria from different categories.

* Hypokinesia is not included in this or subsequent definitions of RV regional wall motion abnormalities for the proposed modified criteria.

† A pathogenic mutation is a DNA alteration associated with ARVC that alters, or is expected to alter, the structure or function of the encoded protein or that has demonstrated linkage to the disease phenotype in a conclusive pedigree and is unobserved or rare in a large non-ARVC control population.

[#] Adapted from Marcus et al. (2010).¹⁵

Genetic aspects of ACM

ACM is a familial disease in at least 50% of cases.¹³ This has led to the assumption that ACM is a genetically determined cardiomyopathy, but it was not until 2000 that a homozygous mutation in the gene encoding the desmosomal protein plakoglobin (*JUP*) was identified in patients with a recessive form of ACM with skin abnormalities, i.e. palmoplantar keratosis and woolly hair. This was called Naxos disease, after the Greek island where these patients were living.¹⁶ In the same year, a homozygous mutation in desmoplakin (*DSP*), encoding another desmosomal protein, was identified in patients from Ecuador with dilated cardiomyopathy and comparable skin abnormalities to Naxos disease.¹⁷ This disease is called Carvajal syndrome and is named after the physician who first described these families.¹⁸ In 2002, a mutation in the same *DSP* gene was identified in an autosomal dominant form of ACM.¹⁹ Since then, screening of other genes encoding desmosomal proteins in non-syndromal

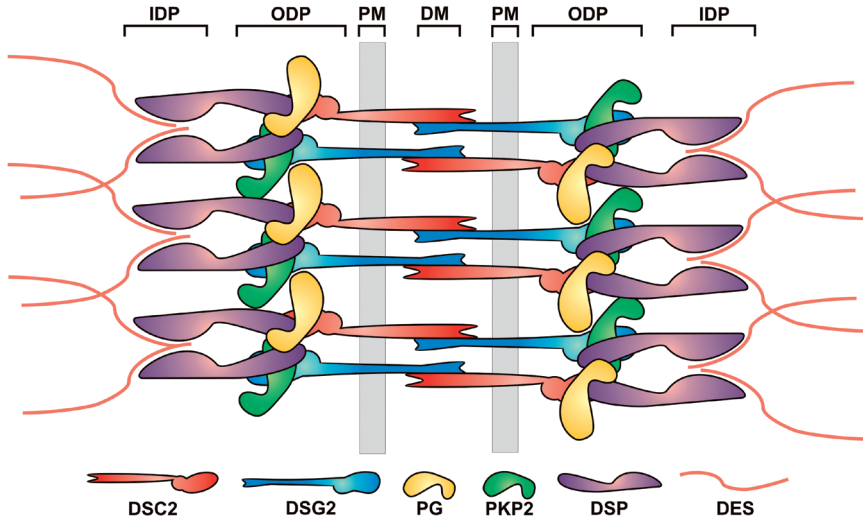

Figure 3 Schematic representation of the molecular organisation of cardiac desmosomes. A model of the relative organisation of major desmosome components is presented. The plasma membrane-bound (PM) desmocollin 2 (DSC2) and desmoglein 2 (DSG2) proteins interact via their extracellular domains at the dense midline (DM) in the extracellular space between adjacent cells. Their cytoplasmic domains interact with plakoglobin (PG) and plakophilin 2 (PKP2) in the outer dense plaque (ODP). Also in the ODP, PKP2 and PG interact with the N-terminal domain of desmoplakin (DSP). The C-terminus of desmoplakin anchors intermediate filaments, mainly desmin (DES), at the inner dense plaque (IDP).⁴⁰

ACM cases has resulted in the identification of mutations in plakophilin 2 (*PKP2*), desmocollin 2 (*DSC2*), desmoglein 2 (*DSG2*), and plakoglobin (*JUP*).²⁰⁻²³

The proper function and structure of cardiac myocytes, and also epithelial cells of the skin, is preserved by cell adhesion junctions in the intercalated discs, located between adjacent cells. The intercalated disc contains three different intercellular connections: gap junctions, responsible for electric coupling between cells, adherens junctions, and desmosomes, which provide mechanical coupling by linking the cytoplasmic actin and intermediate filaments, respectively. Furthermore, the desmosome plays a crucial role in organising and maintaining the intercalated disk itself, thereby also preserving the electrical coupling between cells (Figure 3).

The identification of a mutation in a patient with ACM is of great importance, since it has several consequences. It can confirm the diagnosis and it is also the starting point for cascade family screening for the identified mutation. Family members who are found to be a carrier of the mutation should be screened at regular intervals to pick up early symptoms and/or signs attributable to the disease. These individuals can then benefit from appropriate treatment such as medication or an implantable cardioverter defibrillator (ICD). Family members who are found not to carry the identified pathogenic mutation can be dismissed from frequent follow-ups

Table 3 Comprehensive screening of desmosomal genes in ACM cohorts

Cohort			Results of mutational analysis						
Country	Year	No. of patients	<i>PKP2</i>	<i>DSC2</i>	<i>DSG2</i>	<i>DSP</i>	<i>JUP</i>	>1	Total
United States ²⁴	2009	82	39%	0%	4%	1%	1%	7%	52%
Denmark ²⁵	2010	55	11%	5%	4%	2%	2%	9%	33%
France/Switzerland ²⁶	2010	135	30%	1%	7%	4%	0%	4%	46%
Canada ²⁷	2010	23	22%	0%	4%	4%	0%	13%	43%
United States/Italy ²⁸	2010	198	11%	2%	3%	2%	1%	8%	26%
Germany ^{29*}	2010	12	42%	8%	17%	0%	0%	0%	67%
Finland ³⁰	2011	29	10%	0%	3%	3%	NS	0%	17%
The Netherlands ³¹	2011	149	51%	1%	3%	1%	0%	2%	58%
United Kingdom ^{32†}	2011	97						8%	58%
Total		780	28%	2%	4%	2%	1%	6%	44%

NS indicates not studied. Single mutations are listed per gene. The percentage of multiple mutations in the same gene (compound heterozygosity or homozygous) or in different genes (digenic inheritance) is indicated by '>1'. * in this cohort, one mutation in *DES* was also found. † single genes mutations not specified.

and reassured about their own risks as well as those for their children. The identification of a mutation could also confirm a suspected diagnosis of ACM in a patient whose clinical features are inconclusive.

Desmosomal genes in ACM

An overview of the results of comprehensive desmosomal screening in nine different cohorts is listed in Table 3.²⁴⁻³² Taken together, a mutation in one or more of the desmosomal genes can be identified in 44% of patients with ACM, with the large majority found in the *PKP2* gene. Notably, multiple mutations in the same gene or in different genes can be identified in 6% of ACM patients, but often it is not clear whether all these identified mutations are truly pathogenic. It is important to realise that a sequence variant in one of the desmosomal genes is not by definition a pathogenic mutation. Numerous single nucleotide polymorphisms are present in these genes and the pathogenicity of many novel variants is unclear, leading to the terms “variant of unknown significance” and “unclassified variant”. Nonsense mutations, both in-frame and frame-shift insertion or deletion mutations, and splice site mutations are generally considered pathogenic unless identified as polymorphisms. To determine whether missense mutations can be classified as pathogenic, several aspects need to be considered: the absence of the mutation in ethnically matched controls, co-segregation with the phenotype in pedigrees, considerable differences in physicochemical properties of the amino acids, evolutionary conservation of amino acids across several species, their presence in an evolutionary conserved

region, and localisation in a domain predicted or proven to be functionally important. Several software programs are available to predict the effect of a mutation, such as Sorting Intolerant From Tolerant (SIFT) and Polymorphism Phenotyping (PolyPhen).^{33,34} These programs, however, often yield contradictory results, thereby hampering the interpretation and classification of variants.³⁵

Kaplinger and colleagues screened *PKP2*, *DSC2*, *DSG2*, *DSP*, and *TMEM43* in 427 unrelated, ostensibly healthy, subjects from various racial and ethnic backgrounds. They found a mutation in 69 of them (16%).³⁶ They annotated any variant uniquely identified in one control as a “mutation”, as well as any variant observed in only ACM cases but absent in the controls. In the ACM cases a mutation was identified in 102 of 175 (58%). However, the percentage of missense mutations in the control cohort and the ACM cohort was 16% and 21%, respectively, and not significantly different. Truncating mutations and multiple mutations were found to be likely ACM-associated, but so-called radical mutations were also present in 0.5% of the control subjects.³⁶ In a Finnish population sample of 6,334 individuals, 31 (0.5%) were found to carry a *PKP2* mutation that had been identified in ACM patients.³⁰ A truncating mutation in *DSC2* (p.Ala897LysfsX4), previously reported as pathogenic,²² was later identified in multiple control cohorts and may now be considered a rare variant, insufficient to cause ACM, but possibly affecting phenotypic expression of concomitant ACM mutations.³⁷ Furthermore, it is unlikely that reported pathogenic mutations in exon 6 of the *PKP2* gene are truly pathogenic, since the *PKP2* isoform containing exon 6 is not expressed in the heart.³⁸ Finally, synonymous mutations, i.e. sequence changes in the coding region of a gene that do not change the amino acid sequence, can be pathogenic, for instance by creating a cryptic splice site, eventually resulting in a change at the protein level.³⁹

Non-desmosomal genes in ACM

The identification of mutations in the five desmosomal proteins has led to the postulation of ACM as a ‘desmosomal disease’.^{20,40} However, mutations in genes encoding non-desmosomal proteins have also been implicated. Two families with a mutation in the 5' or 3' untranslated region of the transforming growth factor beta 3 gene (*TGFB3*) were described. These mutations led to increased expression of *TGFB3*, which has a pro-fibrotic activity.⁴¹ Since then however, no other mutations in *TGFB3* have been identified in ACM families.

Missense mutations in the gene encoding the cardiac ryanodine receptor (*RYR2*), a calcium release channel in the sarcoplasmic reticulum, have been described in Italian families with a distinct form of ACM, characterised by exercise-induced ventricular arrhythmias and a high penetrance.⁴² *RYR2* mutations have also been identified in families with catecholaminergic polymorphic ventricular tachycardia

(CPVT),^{43,44} and whether *RYR2* mutations should be considered as causative in ACM is questionable.

A founder mutation in the gene encoding the transmembrane protein 43 (*TMEM43*) was identified in several families from Newfoundland, Canada. This form of ACM was found to be fully penetrant with prominent left ventricular (LV) involvement and men developing a phenotype at a younger age than women.⁴⁵ The same mutation has also been reported in an ACM family from Denmark.⁴⁶ It has been hypothesised that the *TMEM43* mutation causes fibrofatty replacement of the myocardium by influencing the adipogenic transcription factor PPAR γ .⁴⁵

Desmin is the major intermediate filament protein of both cardiac and skeletal muscle and it binds to the desmosome at the intercalated disc. Mutations in the desmin gene (*DES*) can cause both isolated and combined forms of skeletal myopathies, cardiomyopathies and cardiac conduction disease.⁴⁷ In addition, patients with a mutation in the *DES* gene who fulfilled the diagnostic criteria for ACM have been described.^{29,48,49}

Titin, the largest human protein known, is a giant myofibril and it is expressed in cardiac and skeletal muscle. Titin is encoded by the *TTN* gene, which contains 363 exons. *TTN* mutations have previously been reported in DCM and HCM,^{50,51} but comprehensive sequence analysis in large series of patients has long been impractical due to the large size of the gene. In 2011, complete *TTN* screening identified mutations in 7 out of 38 ACM families and conduction disease was present in 11 out of 14 mutation carriers.⁵² Recently, truncating *TTN* mutations were identified in 25% of familial DCM cases and in 18% of sporadic DCM cases.⁵³ If this is confirmed in other cohorts, *TTN* mutations would be the most common cause of DCM, especially since the role of non-truncating mutations in the reported cohort still needs to be elucidated.⁵³ Notably, the reported ACM-associated *TTN* mutations are all non-truncating mutations.⁵²

Mutations in the gene encoding the nuclear envelope protein lamin A/C (*LMNA*) can also cause very variable phenotypes, ranging from syndromes of premature aging to neuromuscular diseases. *LMNA* mutations causing cardiac disease typically result in DCM associated with atrial arrhythmia and atrioventricular block, resulting in progressive heart failure and sudden cardiac death. In addition, mutations were identified in four families with severe ACM, and associated with conduction disease in two probands.⁵⁴

Biopsy studies and functional assays

The mere presence of a novel missense mutation is clearly insufficient to label such a mutation as pathogenic and the interpretation of a missense mutation in an ACM

patient is therefore challenging. Additional evidence from assays using patient material and functional studies can be of great help in the interpretation of mutations.

Decreased connexin 43 expression and abnormal co-localisation with PKP2 was found in immunofluorescent studies on endomyocardial-biopsy samples from four ACM patients with *PKP2* mutations.⁵⁵ Immunohistochemical analysis of biopsy samples from ACM patients, both with and without desmosomal gene mutations, showed diffusely reduced signal levels for plakoglobin at the intercalated discs.⁵⁶ The reduced plakoglobin at intercalated discs has been identified as a sensitive marker for ACM, but not with complete specificity, since these reduced signals have also been observed in patients with sarcoidosis and giant cell myocarditis.⁵⁷ These are highly arrhythmogenic forms of myocarditis, suggesting that, at least in part, shared pathophysiological processes involving the cardiac desmosome underlie these different diseases. It has been suggested that plakoglobin is mainly redistributed from the intercalated discs to other cellular pools, illustrating that abnormal localisation is the cardinal feature and that protein degradation plays only a secondary role.⁵⁸

Functional studies using full-length human *DSG2* constructs expressed in neonatal rat cardiomyocytes were performed for three missense mutations in *DSG2*.⁵⁹ These mutations did not affect the binding to plakoglobin, suggesting that the observed loss of plakoglobin immunoreactivity is not simply the result of a change in binding affinity caused by a missense mutation, but rather a more complex mechanism, such as post-translational modifications.⁵⁹ Both nuclear localisation of plakoglobin and reduced canonical Wnt/beta-catenin signalling have been shown to be the result of suppression of desmoplakin expression. As a consequence, increased expression of adipogenic and fibrogenic genes leads to adipocyte development instead of myocyte development.⁶⁰

Animal models

Several animal models of ACM have been shown to recapitulate important aspects of the human disease phenotype. Most of these models were not based on specific human mutations but on knock-out mouse models or embryonic morpholino knockdown zebrafish models.⁶¹ In the first animal study on specific ACM related mutations, attempts to generate cardiac-specific transgenic mouse models with the DSP mutations p.Val30Met or p.Gln90Arg failed, probably due to embryonic lethality. However, transgenic mice with cardiac-restricted overexpression of the DSP mutation p.Arg2834His showed increased cardiomyocyte apoptosis, cardiac fibrosis, lipid accumulation, and biventricular enlargement and cardiac dysfunction.⁶² Transgenic mice carrying the equivalent of the human p.Asn266Ser mutation in *DSG2* also recapitulated the clinical features of ACM. The model showed the full phenotypic spectrum, including sudden death, ventricular arrhythmias, cardiac

dysfunction, and biventricular dilatation and aneurysms.⁶³ In another animal study, mice overexpressing the truncated plakoglobin protein identified in Naxos disease,¹⁶ demonstrated fibrofatty replacement, cardiac dysfunction, and premature death. Reduced membrane localisation and reduced binding to desmosome proteins DSP and DSG2 was also observed.⁶⁴

The understanding of the pathophysiological mechanisms underlying ACM has increased greatly since the identification of mutations in genes encoding desmosomal proteins and the subsequent *in vitro* and *in vivo* studies. However, the interpretation of the genetic basis of the disease, the role of environmental factors such as exercise, and the variable clinical picture seen in ACM patients still pose a challenge to researchers and to clinicians taking care of the patients and families affected by this disease.

AIMS AND OUTLINE OF THIS THESIS

In arrhythmogenic cardiomyopathy (ACM), comprehensive screening of the five desmosomal genes identifies a pathogenic mutation in about half of all patients. In addition, mutations in several non-desmosomal genes have been identified, illustrating the genetic heterogeneity of ACM. In the other half of the ACM patients, no genetic cause can be established at the moment. The identification of a mutation is of great importance, since it has several consequences. It can confirm a suspected diagnosis in a patient whose clinical features are inconclusive, and moreover, it is also the starting point of cascade family screening for the specific mutation. This will identify the family members at risk, who should be screened at regular intervals to enable early detection of symptoms and/or signs attributable to the disease and possibly lead to initiating treatment to prevent deterioration of the disease. Family members who are found not to carry the identified pathogenic mutation can be dismissed from frequent follow-up and reassured about their own risks as well as the risks for their children.

From a scientific point of view, the elucidation of the genetic basis of ACM will provide novel insights into the disease mechanisms. These insights will help us to better understand the pathogenesis and the variability of the disease. Ultimately, this knowledge could be the foundation on which gene-specific and patient-specific options for treatment and management can be built. This ultimate goal will only be reached by collecting as much data as possible, by collaborating with cardiologists, geneticists, pathologists, biologists, technicians, bioinformaticians, and other clinicians and researchers from dedicated centres all over the world.

This thesis presents genetic and clinical studies in patients with ACM and their families. Considering the importance of identifying a mutation in these patients, the aims of this thesis were:

1. To further clarify the genetic basis of arrhythmogenic cardiomyopathy by searching for novel genes and mutations; and
2. To study the clinical picture of arrhythmogenic cardiomyopathy, especially in familial cases.

24

Outline

The first part of this thesis describes genetic studies and phenotypic characterisation in ACM. Chapter 2 describes the application of the haplotype-sharing test to identify disease-causing mutations, possibly in novel genes. A family with ACM and a family with dilated cardiomyopathy (DCM) were analysed using the haplotype-sharing test. Known ACM- and DCM-related genes (*PKP2* and *MYH7*) were found

to be located in the largest shared haplotypes among affected individuals within a pedigree and were sequenced, leading to the identification of a mutation in both these genes. In Chapter 3 the clinical characteristics of the *PKP2* mutation carriers from the previous chapter are described and molecular studies on this *PKP2* splice mutation are presented. Chapter 4 describes the largest series of patients with the same founder mutation in the *PKP2* gene (c.235C>T; p.Arg79X). The clinical variability and age-related penetrance, hallmarks of ACM, are well illustrated by the phenotypic descriptions of the mutation carriers. In Chapter 5 the genetic variants database for ACM (available from www.arvcdatabase.info) is described in detail. This freely available online database lists the genetic variants found in genes associated with ACM and is a digital repository for both molecular data and all publications containing additional information on clinical and/or genetic data of listed variants. Chapter 6 reports a large cohort of Dutch ACM families collected in all the university medical centres in the Netherlands. This chapter describes the genotype-phenotype relationships and highlights the impact of mutation screening for family members of the identified index patients.

The second part of this thesis focuses on the identification of a founder mutation in the phospholamban gene (*PLN* c.40_42delAGA; p.Arg14del) in a large number of Dutch patients with ACM and/or DCM. The clinical characteristics of index patients carrying this mutation are outlined in Chapter 7. This chapter illustrates the overlap between different cardiomyopathy subtypes, *in casu* DCM and ACM, underscoring the importance of a molecular diagnosis in patients with inherited cardiomyopathy. This founder mutation is further described in Chapter 8, which shows the geographical distribution of mutation carriers in the Netherlands. The region of origin in the Dutch population was also analysed using information on the birthplaces of ancestors who were proven or likely carriers of the mutation. In Chapter 9 a large pedigree with ACM is studied. The originally identified mutation in *PKP2* (c.419C>T; p.Ser140Phe) was found not to co-segregate with the phenotype and additional studies revealed that the *PLN* p.Arg14del mutation was the pathogenic mutation in this pedigree. Meticulous phenotypic characterisation of the mutation carriers revealed that there was no evidence of a disease-causing contribution from the *PKP2* variant.

Chapter 10 comprises the summary and general discussion of this thesis and outlines the future perspectives and possible directions for further genetic studies in inherited cardiomyopathies. It also considers the recent technological advances and their promises and limitations.

REFERENCES

1. Brochure Cardiomyopathie. versie 1.4. Den Haag: Nederlandse Hartstichting; 2011.
2. Elliott P, Andersson B, Arbustini E, Bilinska Z, Cecchi F, Charron P, Dubourg O, Kuhl U, Maisch B, McKenna WJ, Monserrat L, Pankuweit S, Rapezzi C, Seferovic P, Tavazzi L, Keren A. Classification of the cardiomyopathies: a position statement from the European Society Of Cardiology Working Group on Myocardial and Pericardial Diseases. *Eur Heart J.* 2008;29:270-6.
3. Maron BJ, Towbin JA, Thiene G, Antzelevitch C, Corrado D, Arnett D, Moss AJ, Seidman CE, Young JB. Contemporary definitions and classification of the cardiomyopathies: an American Heart Association Scientific Statement from the Council on Clinical Cardiology, Heart Failure and Transplantation Committee; Quality of Care and Outcomes Research and Functional Genomics and Translational Biology Interdisciplinary Working Groups; and Council on Epidemiology and Prevention. *Circulation.* 2006;113:1807-16.
4. Jarcho JA, McKenna W, Pare JA, Solomon SD, Holcombe RF, Dickie S, Levi T, Donis-Keller H, Seidman JG, Seidman CE. Mapping a gene for familial hypertrophic cardiomyopathy to chromosome 14q1. *N Engl J Med.* 1989;321:1372-8.
5. Geisterfer-Lowrance AA, Kass S, Tanigawa G, Vosberg HP, McKenna W, Seidman CE, Seidman JG. A molecular basis for familial hypertrophic cardiomyopathy: a beta cardiac myosin heavy chain gene missense mutation. *Cell.* 1990;62:999-1006.
6. Jeschke B, Uhl K, Weist B, Schroder D, Meitinger T, Dohlemann C, Vosberg HP. A high risk phenotype of hypertrophic cardiomyopathy associated with a compound genotype of two mutated beta-myosin heavy chain genes. *Hum Genet.* 1998;102:299-304.
7. Lekanne Deprez RH, Muurling-Vlietman JJ, Hruđa J, Baars MJ, Wijnaendts LC, Stolte-Dijkstra I, Alders M, van Hagen JM. Two cases of severe neonatal hypertrophic cardiomyopathy caused by compound heterozygous mutations in the MYBPC3 gene. *J Med Genet.* 2006;43:829-32.
8. Watkins H, Ashrafian H, Redwood C. Inherited cardiomyopathies. *N Engl J Med.* 2011;364:1643-56.
9. Marcus FI, Fontaine GH, Guiraudon G, Frank R, Laurenceau JL, Malergue C, Grosgeat Y. Right ventricular dysplasia: a report of 24 adult cases. *Circulation.* 1982;65:384-98.
10. Richardson P, McKenna W, Bristow M, Maisch B, Mautner B, O'Connell J, Olsen E, Thiene G, Goodwin J, Gyrfas I, Martin I, Nordet P. Report of the 1995 World Health Organization/International Society and Federation of Cardiology Task Force on the Definition and Classification of cardiomyopathies. *Circulation.* 1996;93:841-2.
11. Corrado D, Basso C, Thiene G, McKenna WJ, Davies MJ, Fontaliran F, Nava A, Silvestri F, Blomstrom-Lundqvist C, Wlodarska EK, Fontaine G, Camerini F. Spectrum of clinicopathologic manifestations of arrhythmogenic right ventricular cardiomyopathy/dysplasia: a multicenter study. *J Am Coll Cardiol.* 1997;30:1512-20.
12. Sen-Chowdhry S, Syrris P, Ward D, Asimaki A, Sevdalis E, McKenna WJ. Clinical and genetic characterization of families with arrhythmogenic right ventricular dysplasia/cardiomyopathy provides novel insights into patterns of disease expression. *Circulation.* 2007;115:1710-20.
13. Basso C, Corrado D, Marcus FI, Nava A, Thiene G. Arrhythmogenic right ventricular cardiomyopathy. *Lancet.* 2009;373:1289-300.
14. McKenna WJ, Thiene G, Nava A, Fontaliran F, Blomstrom-Lundqvist C, Fontaine G, Camerini F. Diagnosis of arrhythmogenic right ventricular dysplasia/cardiomyopathy. Task Force of the Working Group Myocardial and Pericardial Disease of the European Society of Cardiology and of the Scientific Council on Cardiomyopathies of the International Society and Federation of Cardiology. *Br Heart J.* 1994;71:215-8.

15. Marcus FI, McKenna WJ, Sherrill D, Basso C, Bauce B, Bluemke DA, Calkins H, Corrado D, Cox MG, Daubert JP, Fontaine G, Gear K, Hauer R, Nava A, Picard MH, Protonotarios N, Saffitz JE, Sanborn DM, Steinberg JS, Tandri H, Thiene G, Towbin JA, Tsatsopoulou A, Wichter T, Zareba W. Diagnosis of arrhythmogenic right ventricular cardiomyopathy/dysplasia: proposed modification of the task force criteria. *Circulation*. 2010;121:1533-41.
16. McKoy G, Protonotarios N, Crosby A, Tsatsopoulou A, Anastasakis A, Coonar A, Norman M, Baboonian C, Jeffery S, McKenna WJ. Identification of a deletion in plakoglobin in arrhythmogenic right ventricular cardiomyopathy with palmoplantar keratoderma and woolly hair (Naxos disease). *Lancet*. 2000;355:2119-24.
17. Norgett EE, Hatsell SJ, Carvajal-Huerta L, Cabezas JC, Common J, Purkis PE, Whittock N, Leigh IM, Stevens HP, Kelsell DP. Recessive mutation in desmoplakin disrupts desmoplakin-intermediate filament interactions and causes dilated cardiomyopathy, woolly hair and keratoderma. *Hum Mol Genet*. 2000;9:2761-6.
18. Carvajal-Huerta L. Epidermolytic palmoplantar keratoderma with woolly hair and dilated cardiomyopathy. *J Am Acad Dermatol*. 1998;39:418-21.
19. Rampazzo A, Nava A, Malacrida S, Beffagna G, Bauce B, Rossi V, Zimbello R, Simionati B, Basso C, Thiene G, Towbin JA, Danieli GA. Mutation in human desmoplakin domain binding to plakoglobin causes a dominant form of arrhythmogenic right ventricular cardiomyopathy. *Am J Hum Genet*. 2002;71:1200-6.
20. Gerull B, Heuser A, Wichter T, Paul M, Basson CT, McDermott DA, Lerman BB, Markowitz SM, Ellinor PT, MacRae CA, Peters S, Grossmann KS, Drenckhahn J, Michely B, Sasse-Klaassen S, Birchmeier W, Dietz R, Breithardt G, Schulze-Bahr E, Thierfelder L. Mutations in the desmosomal protein plakophilin-2 are common in arrhythmogenic right ventricular cardiomyopathy. *Nat Genet*. 2004;36:1162-4.
21. Pilichou K, Nava A, Basso C, Beffagna G, Bauce B, Lorenzon A, Frigo G, Vettori A, Valente M, Towbin J, Thiene G, Danieli GA, Rampazzo A. Mutations in desmoglein-2 gene are associated with arrhythmogenic right ventricular cardiomyopathy. *Circulation*. 2006;113:1171-9.
22. Syrris P, Ward D, Evans A, Asimaki A, Gandjbakhch E, Sen-Chowdhry S, McKenna WJ. Arrhythmogenic right ventricular dysplasia/cardiomyopathy associated with mutations in the desmosomal gene desmocollin-2. *Am J Hum Genet*. 2006;79:978-84.
23. Asimaki A, Syrris P, Wichter T, Matthias P, Saffitz JE, McKenna WJ. A novel dominant mutation in plakoglobin causes arrhythmogenic right ventricular cardiomyopathy. *Am J Hum Genet*. 2007;81:964-73.
24. Den Haan AD, Tan BY, Zikusoka MN, Llado LI, Jain R, Daly A, Tichnell C, James C, Amat-Alarcon N, Abraham T, Russell SD, Bluemke DA, Calkins H, Dalal D, Judge DP. Comprehensive desmosome mutation analysis in North Americans with arrhythmogenic right ventricular dysplasia/cardiomyopathy. *Circ Cardiovasc Genet*. 2009;2:428-35.
25. Christensen AH, Benn M, Bundgaard H, Tybjaerg-Hansen A, Haunso S, Svendsen JH. Wide spectrum of desmosomal mutations in Danish patients with arrhythmogenic right ventricular cardiomyopathy. *J Med Genet*. 2010;47:736-44.
26. Fressart V, Duthoit G, Donal E, Probst V, Deharo JC, Chevalier P, Klug D, Dubourg O, Delacretaz E, Cosnay P, Scanu P, Extramiana F, Keller D, Hidden-Lucet F, Simon F, Bessirard V, Roux-Buisson N, Hebert JL, Azarine A, Casset-Senon D, Rouzet F, Lecarpentier Y, Fontaine G, Coirault C, Frank R, Hainque B, Charron P. Desmosomal gene analysis in arrhythmogenic right ventricular dysplasia/cardiomyopathy: spectrum of mutations and clinical impact in practice. *Europace*. 2010;12:861-8.

27. Barahona-Dussault C, Benito B, Campuzano O, Iglesias A, Leung TL, Robb L, Talajic M, Brugada R. Role of genetic testing in arrhythmogenic right ventricular cardiomyopathy/dysplasia. *Clin Genet*. 2010;77:37-48.
28. Xu T, Yang Z, Vatta M, Rampazzo A, Beffagna G, Pilichou K, Scherer SE, Saffitz J, Kravitz J, Zareba W, Danieli GA, Lorenzon A, Nava A, Bauce B, Thiene G, Basso C, Calkins H, Gear K, Marcus F, Towbin JA, Multidisciplinary Study of Right Ventricular Dysplasia Investigators. Compound and digenic heterozygosity contributes to arrhythmogenic right ventricular cardiomyopathy. *J Am Coll Cardiol*. 2010;55:587-97.
29. Klauke B, Kossmann S, Gaertner A, Brand K, Stork I, Brodehl A, Dieding M, Walhorn V, Anselmetti D, Gerdes D, Bohms B, Schulz U, Zu Knyphausen E, Vorgerd M, Gummert J, Milting H. De novo desmin-mutation N116S is associated with arrhythmogenic right ventricular cardiomyopathy. *Hum Mol Genet*. 2010;19:4595-607.
30. Lahtinen AM, Lehtonen E, Marjamaa A, Kaartinen M, Helio T, Porthan K, Oikarinen L, Toivonen L, Swan H, Jula A, Peltonen L, Palotie A, Salomaa V, Kontula K. Population-prevalent desmosomal mutations predisposing to arrhythmogenic right ventricular cardiomyopathy. *Heart Rhythm*. 2011;8:1214-21.
31. Cox MG, van der Zwaag PA, van der Werf C, van der Smagt JJ, Noorman M, Bhuiyan ZA, Wiesfeld AC, Volders PG, van Langen IM, Atsma DE, Dooijes D, van den Wijngaard A, Houweling AC, Jongbloed JD, Jordaens L, Cramer MJ, Doevendans PA, de Bakker JM, Wilde AA, van Tintelen JP, Hauer RN. Arrhythmogenic right ventricular dysplasia/cardiomyopathy: pathogenic desmosome mutations in index-patients predict outcome of family screening: Dutch arrhythmogenic right ventricular dysplasia/cardiomyopathy genotype-phenotype follow-up study. *Circulation*. 2011;123:2690-700.
32. Quarta G, Muir A, Pantazis A, Syrris P, Gehmlich K, Garcia-Pavia P, Ward D, Sen-Chowdhry S, Elliott PM, McKenna WJ. Familial evaluation in arrhythmogenic right ventricular cardiomyopathy: impact of genetics and revised task force criteria. *Circulation*. 2011;123:2701-9.
33. Ng PC and Henikoff S. Predicting deleterious amino acid substitutions. *Genome Res*. 2001;11:863-74.
34. Ramensky V, Bork P, Sunyaev S. Human non-synonymous SNPs: server and survey. *Nucleic Acids Res*. 2002;30:3894-900.
35. Tavtigian SV, Greenblatt MS, Lesueur F, Byrnes GB. In silico analysis of missense substitutions using sequence-alignment based methods. *Hum Mutat*. 2008;29:1327-36.
36. Kapplinger JD, Landstrom AP, Salisbury BA, Callis TE, Pollevick GD, Tester DJ, Cox MG, Bhuiyan Z, Bikker H, Wiesfeld AC, Hauer RN, van Tintelen JP, Jongbloed JD, Calkins H, Judge DP, Wilde AA, Ackerman MJ. Distinguishing arrhythmogenic right ventricular cardiomyopathy/dysplasia-associated mutations from background genetic noise. *J Am Coll Cardiol*. 2011;57:2317-27.
37. De Bortoli M, Beffagna G, Bauce B, Lorenzon A, Smaniotta G, Rigato I, Calore M, Li Mura IE, Basso C, Thiene G, Lanfranchi G, Danieli GA, Nava A, Rampazzo A. The p.A897KfsX4 frameshift variation in desmocollin-2 is not a causative mutation in arrhythmogenic right ventricular cardiomyopathy. *Eur J Hum Genet*. 2010;18:776-82.
38. Gandjbakhch E, Fressart V, Bertaux G, Faivre L, Simon F, Frank R, Fontaine G, Villard E, Coirault C, Hainque B, Charron P. Sporadic arrhythmogenic right ventricular cardiomyopathy/dysplasia due to a de novo mutation. *Europace*. 2009;11:379-81.
39. Awad MM, Dalal D, Tichnell C, James C, Tucker A, Abraham T, Spevak PJ, Calkins H, Judge DP. Recessive arrhythmogenic right ventricular dysplasia due to novel cryptic splice mutation in PKP2. *Hum Mutat*. 2006;27:1157.

40. Van Tintelen JP, Hofstra RM, Wiesfeld AC, van den Berg MP, Hauer RN, Jongbloed JD. Molecular genetics of arrhythmogenic right ventricular cardiomyopathy: emerging horizon? *Curr Opin Cardiol.* 2007;22:185-92.
41. Beffagna G, Occhi G, Nava A, Vitiello L, Ditadi A, Basso C, Bauce B, Carraro G, Thiene G, Towbin JA, Danieli GA, Rampazzo A. Regulatory mutations in transforming growth factor-beta3 gene cause arrhythmogenic right ventricular cardiomyopathy type 1. *Cardiovasc Res.* 2005;65:366-73.
42. Tiso N, Stephan DA, Nava A, Bagattin A, Devaney JM, Stanchi F, Larderet G, Brahmabhatt B, Brown K, Bauce B, Muriago M, Basso C, Thiene G, Danieli GA, Rampazzo A. Identification of mutations in the cardiac ryanodine receptor gene in families affected with arrhythmogenic right ventricular cardiomyopathy type 2 (ARVD2). *Hum Mol Genet.* 2001;10:189-94.
43. Priori SG, Napolitano C, Tiso N, Memmi M, Vignati G, Bloise R, Sorrentino V, Danieli GA. Mutations in the cardiac ryanodine receptor gene (hRyR2) underlie catecholaminergic polymorphic ventricular tachycardia. *Circulation.* 2001;103:196-200.
44. Laitinen PJ, Brown KM, Piippo K, Swan H, Devaney JM, Brahmabhatt B, Donarum EA, Marino M, Tiso N, Viitasalo M, Toivonen L, Stephan DA, Kontula K. Mutations of the cardiac ryanodine receptor (RyR2) gene in familial polymorphic ventricular tachycardia. *Circulation.* 2001;103:485-90.
45. Merner ND, Hodgkinson KA, Haywood AF, Connors S, French VM, Drenckhahn JD, Kupprion C, Ramadanova K, Thierfelder L, McKenna W, Gallagher B, Morris-Larkin L, Bassett AS, Parfrey PS, Young TL. Arrhythmogenic right ventricular cardiomyopathy type 5 is a fully penetrant, lethal arrhythmic disorder caused by a missense mutation in the TMEM43 gene. *Am J Hum Genet.* 2008;82:809-21.
46. Christensen AH, Andersen CB, Tybjaerg-Hansen A, Haunso S, Svendsen JH. Mutation analysis and evaluation of the cardiac localization of TMEM43 in arrhythmogenic right ventricular cardiomyopathy. *Clin Genet.* 2011;80:256-64.
47. Van Tintelen JP, van Gelder IC, Asimaki A, Suurmeijer AJ, Wiesfeld AC, Jongbloed JD, van den Wijngaard A, Kuks JB, Spaendonck-Zwarts KY, Notermans N, Boven L, van den Heuvel F, Veenstra-Knol HE, Saffitz JE, Hofstra RM, van den Berg MP. Severe cardiac phenotype with right ventricular predominance in a large cohort of patients with a single missense mutation in the DES gene. *Heart Rhythm.* 2009;6:1574-83.
48. Otten E, Asimaki A, Maass A, van Langen IM, van der Wal A, de Jonge N, van den Berg MP, Saffitz JE, Wilde AA, Jongbloed JD, van Tintelen JP. Desmin mutations as a cause of right ventricular heart failure affect the intercalated disks. *Heart Rhythm.* 2010;7:1058-64.
49. Hedberg C, Melberg A, Kuhl A, Jenne D, Oldfors A. Autosomal dominant myofibrillar myopathy with arrhythmogenic right ventricular cardiomyopathy 7 is caused by a DES mutation. *Eur J Hum Genet.* 2012;20:984-5.
50. Gerull B, Gramlich M, Atherton J, McNabb M, Trombitas K, Sasse-Klaassen S, Seidman JG, Seidman C, Granzier H, Labeit S, Frenneaux M, Thierfelder L. Mutations of TTN, encoding the giant muscle filament titin, cause familial dilated cardiomyopathy. *Nat Genet.* 2002;30:201-4.
51. Satoh M, Takahashi M, Sakamoto T, Hiroe M, Marumo F, Kimura A. Structural analysis of the titin gene in hypertrophic cardiomyopathy: identification of a novel disease gene. *Biochem Biophys Res Commun.* 1999;262:411-7.
52. Taylor M, Graw S, Sinagra G, Barnes C, Slavov D, Brun F, Pinamonti B, Salcedo EE, Sauer W, Pyxaras S, Anderson B, Simon B, Bogomolovas J, Labeit S, Granzier H, Mestroni L. Genetic variation in titin in arrhythmogenic right ventricular cardiomyopathy-overlap syndromes. *Circulation.* 2011;124:876-85.

53. Herman DS, Lam L, Taylor MR, Wang L, Teekakirikul P, Christodoulou D, Conner L, DePalma SR, McDonough B, Sparks E, Teodorescu DL, Cirino AL, Banner NR, Pennell DJ, Graw S, Merlo M, Di Lenarda A, Sinagra G, Bos JM, Ackerman MJ, Mitchell RN, Murry CE, Lakdawala NK, Ho CY, Barton PJ, Cook SA, Mestroni L, Seidman JG, Seidman CE. Truncations of titin causing dilated cardiomyopathy. *N Engl J Med.* 2012;366:619-28.
54. Quarta G, Syrris P, Ashworth M, Jenkins S, Zuborne Alapi K, Morgan J, Muir A, Pantazis A, McKenna WJ, Elliott PM. Mutations in the Lamin A/C gene mimic arrhythmogenic right ventricular cardiomyopathy. *Eur Heart J.* 2012;33:1128-36.
55. Fidler LM, Wilson GJ, Liu F, Cui X, Scherer SW, Taylor GP, Hamilton RM. Abnormal connexin43 in arrhythmogenic right ventricular cardiomyopathy caused by plakophilin-2 mutations. *J Cell Mol Med.* 2009;13:4219-28.
56. Asimaki A, Tandri H, Huang H, Halushka MK, Gautam S, Basso C, Thiene G, Tsatsopoulou A, Protonotarios N, McKenna WJ, Calkins H, Saffitz JE. A new diagnostic test for arrhythmogenic right ventricular cardiomyopathy. *N Engl J Med.* 2009;360:1075-84.
57. Asimaki A, Tandri H, Duffy ER, Winterfield JR, Mackey-Bojack S, Picken MM, Cooper LT, Wilber DJ, Marcus FI, Basso C, Thiene G, Tsatsopoulou A, Protonotarios N, Stevenson WG, McKenna WJ, Gautam S, Remick DG, Calkins H, Saffitz JE. Altered desmosomal proteins in granulomatous myocarditis and potential pathogenic links to arrhythmogenic right ventricular cardiomyopathy. *Circ Arrhythm Electrophysiol.* 2011;4:743-52.
58. Gehmlich K, Syrris P, Reimann M, Asimaki A, Ehler E, Evans A, Quarta G, Pantazis A, Saffitz JE, McKenna WJ. Molecular changes in the heart of a severe case of arrhythmogenic right ventricular cardiomyopathy caused by a desmoglein-2 null allele. *Cardiovasc Pathol.* 2012;21:275-82.
59. Gehmlich K, Asimaki A, Cahill TJ, Ehler E, Syrris P, Zachara E, Re F, Avella A, Monserrat L, Saffitz JE, McKenna WJ. Novel missense mutations in exon 15 of desmoglein-2: role of the intracellular cadherin segment in arrhythmogenic right ventricular cardiomyopathy? *Heart Rhythm.* 2010;7:1446-53.
60. Garcia-Gras E, Lombardi R, Giocondo MJ, Willerson JT, Schneider MD, Khoury DS, Marian AJ. Suppression of canonical Wnt/beta-catenin signaling by nuclear plakoglobin recapitulates phenotype of arrhythmogenic right ventricular cardiomyopathy. *J Clin Invest.* 2006;116:2012-21.
61. McCauley MD and Wehrens XH. Animal models of arrhythmogenic cardiomyopathy. *Dis Model Mech.* 2009;2:563-70.
62. Yang Z, Bowles NE, Scherer SE, Taylor MD, Kearney DL, Ge S, Nadvoretzkiy VV, DeFreitas G, Carabello B, Brandon LI, Godsel LM, Green KJ, Saffitz JE, Li H, Danieli GA, Calkins H, Marcus F, Towbin JA. Desmosomal dysfunction due to mutations in desmoplakin causes arrhythmogenic right ventricular dysplasia/cardiomyopathy. *Circ Res.* 2006;99:646-55.
63. Pilichou K, Remme CA, Basso C, Campian ME, Rizzo S, Barnett P, Scicluna BP, Baucé B, van den Hoff MJ, de Bakker JM, Tan HL, Valente M, Nava A, Wilde AA, Moorman AF, Thiene G, Bezzina CR. Myocyte necrosis underlies progressive myocardial dystrophy in mouse *dsg2*-related arrhythmogenic right ventricular cardiomyopathy. *J Exp Med.* 2009;206:1787-802.
64. Lombardi R, da Graca Cabreira-Hansen M, Bell A, Fromm RR, Willerson JT, Marian AJ. Nuclear plakoglobin is essential for differentiation of cardiac progenitor cells to adipocytes in arrhythmogenic right ventricular cardiomyopathy. *Circ Res.* 2011;109:1342-53.
65. Van Spaendonck-Zwarts KY, van den Berg MP, van Tintelen JP. DNA analysis in inherited cardiomyopathies: current status and clinical relevance. *Pacing Clin Electrophysiol.* 2008;31:546-9.
66. Jongbloed JD, Pósfalvi A, Kerstjens-Frederikse W, Sinke RJ, van Tintelen JP. New clinical molecular diagnostic methods for congenital and inherited heart disease. *Expert Opin Med Diagn.* 2011;5:9-24.

67. Bienengraeber M, Olson TM, Selivanov VA, Kathmann EC, O’Cochlain F, Gao F, Karger AB, Ballew JD, Hodgson DM, Zingman LV, Pang YP, Alekseev AE, Terzic A. ABCC9 mutations identified in human dilated cardiomyopathy disrupt catalytic KATP channel gating. *Nat Genet.* 2004;36:382-7.
68. Van Driest SL, Ellsworth EG, Ommen SR, Tajik AJ, Gersh BJ, Ackerman MJ. Prevalence and spectrum of thin filament mutations in an outpatient referral population with hypertrophic cardiomyopathy. *Circulation.* 2003;108:445-51.
69. Morita H, Rehm HL, Menesses A, McDonough B, Roberts AE, Kucherlapati R, Towbin JA, Seidman JG, Seidman CE. Shared genetic causes of cardiac hypertrophy in children and adults. *N Engl J Med.* 2008;358:1899-908.
70. Andersen PS, Havndrup O, Hougs L, Sorensen KM, Jensen M, Larsen LA, Hedley P, Thomsen AR, Moolman-Smook J, Christiansen M, Bundgaard H. Diagnostic yield, interpretation, and clinical utility of mutation screening of sarcomere encoding genes in Danish hypertrophic cardiomyopathy patients and relatives. *Hum Mutat.* 2009;30:363-70.
71. Kaski JP, Syrris P, Esteban MT, Jenkins S, Pantazis A, Deanfield JE, McKenna WJ, Elliott PM. Prevalence of sarcomere protein gene mutations in preadolescent children with hypertrophic cardiomyopathy. *Circ Cardiovasc Genet.* 2009;2:436-41.
72. Maron BJ, Maron MS, Semsarian C. Double or compound sarcomere mutations in hypertrophic cardiomyopathy: a potential link to sudden death in the absence of conventional risk factors. *Heart Rhythm.* 2012;9:57-63.
73. Olson TM, Michels VV, Thibodeau SN, Tai YS, Keating MT. Actin mutations in dilated cardiomyopathy, a heritable form of heart failure. *Science.* 1998;280:750-2.
74. Boda U, Vadapalli S, Calambur N, Nallari P. Novel mutations in beta-myosin heavy chain, actin and tropinin-I genes associated with dilated cardiomyopathy in Indian population. *J Genet.* 2009;88:373-7.
75. Kaski JP, Syrris P, Burch M, Tome-Esteban MT, Fenton M, Christiansen M, Andersen PS, Sebire N, Ashworth M, Deanfield JE, McKenna WJ, Elliott PM. Idiopathic restrictive cardiomyopathy in children is caused by mutations in cardiac sarcomere protein genes. *Heart.* 2008;94:1478-84.
76. Klaassen S, Probst S, Oechslin E, Gerull B, Krings G, Schuler P, Greutmann M, Hurlimann D, Yegitbasi M, Pons L, Gramlich M, Drenckhahn JD, Heuser A, Berger F, Jenni R, Thierfelder L. Mutations in sarcomere protein genes in left ventricular noncompaction. *Circulation.* 2008;117:2893-901.
77. Hoedemaekers YM, Caliskan K, Michels M, Frohn-Mulder I, van der Smagt JJ, Phefferkorn JE, Wessels MW, ten Cate FJ, Sijbrands EJ, Dooijes D, Majoor-Krakauer DF. The importance of genetic counseling, DNA diagnostics, and cardiologic family screening in left ventricular noncompaction cardiomyopathy. *Circ Cardiovasc Genet.* 2010;3:232-9.
78. Theis JL, Bos JM, Bartleson VB, Will ML, Binder J, Vatta M, Towbin JA, Gersh BJ, Ommen SR, Ackerman MJ. Echocardiographic-determined septal morphology in Z-disc hypertrophic cardiomyopathy. *Biochem Biophys Res Commun.* 2006;351:896-902.
79. Chiu C, Bagnall RD, Ingles J, Yeates L, Kennerson M, Donald JA, Jormakka M, Lind JM, Semsarian C. Mutations in alpha-actinin-2 cause hypertrophic cardiomyopathy: a genome-wide analysis. *J Am Coll Cardiol.* 2010;55:1127-35.
80. Mohapatra B, Jimenez S, Lin JH, Bowles KR, Coveler KJ, Marx JG, Chrisco MA, Murphy RT, Lurie PR, Schwartz RJ, Elliott PM, Vatta M, McKenna W, Towbin JA, Bowles NE. Mutations in the muscle LIM protein and alpha-actinin-2 genes in dilated cardiomyopathy and endocardial fibroelastosis. *Mol Genet Metab.* 2003;80:207-15.

81. Arimura T, Bos JM, Sato A, Kubo T, Okamoto H, Nishi H, Harada H, Koga Y, Moulik M, Doi YL, Towbin JA, Ackerman MJ, Kimura A. Cardiac ankyrin repeat protein gene (ANKRD1) mutations in hypertrophic cardiomyopathy. *J Am Coll Cardiol.* 2009;54:334-42.
82. Duboscq-Bidot L, Charron P, Ruppert V, Fauchier L, Richter A, Tavazzi L, Arbustini E, Wichter T, Maisch B, Komajda M, Isnard R, Villard E, EUROGENE Heart Failure Network. Mutations in the ANKRD1 gene encoding CARP are responsible for human dilated cardiomyopathy. *Eur Heart J.* 2009;30:2128-36.
83. Moulik M, Vatta M, Witt SH, Arola AM, Murphy RT, McKenna WJ, Borišek AM, Oka K, Labeit S, Bowles NE, Arimura T, Kimura A, Towbin JA. ANKRD1, the gene encoding cardiac ankyrin repeat protein, is a novel dilated cardiomyopathy gene. *J Am Coll Cardiol.* 2009;54:325-33.
84. Villard E, Perret C, Gary F, Proust C, Dilanian G, Hengstenberg C, Ruppert V, Arbustini E, Wichter T, Germain M, Dubourg O, Tavazzi L, Aumont MC, DeGroot P, Fauchier L, Trochu JN, Gibelin P, Aupetit JF, Stark K, Erdmann J, Hetzer R, Roberts AM, Barton PJ, Regitz-Zagrosek V, Cardiogenics Consortium, Aslam U, Duboscq-Bidot L, Meyborg M, Maisch B, Madeira H, Waldenström A, Galve E, Cleland JG, Dorent R, Roizes G, Zeller T, Blankenberg S, Goodall AH, Cook S, Tregouet DA, Tiret L, Isnard R, Komajda M, Charron P, Cambien F. A genome-wide association study identifies two loci associated with heart failure due to dilated cardiomyopathy. *Eur Heart J.* 2011;32:1065-76.
85. Arimura T, Ishikawa T, Nunoda S, Kawai S, Kimura A. Dilated cardiomyopathy-associated BAG3 mutations impair Z-disc assembly and enhance sensitivity to apoptosis in cardiomyocytes. *Hum Mutat.* 2011;32:1481-91.
86. Chiu C, Tebo M, Ingles J, Yeates L, Arthur JW, Lind JM, Semsarian C. Genetic screening of calcium regulation genes in familial hypertrophic cardiomyopathy. *J Mol Cell Cardiol.* 2007;43:337-43.
87. Hayashi T, Arimura T, Ueda K, Shibata H, Hohda S, Takahashi M, Hori H, Koga Y, Oka N, Imaizumi T, Yasunami M, Kimura A. Identification and functional analysis of a caveolin-3 mutation associated with familial hypertrophic cardiomyopathy. *Biochem Biophys Res Commun.* 2004;313:178-84.
88. Traverso M, Gazzero E, Assereto S, Sotgia F, Biancheri R, Stringara S, Giberti L, Pedemonte M, Wang X, Scapolan S, Pasquini E, Donati MA, Zara F, Lisanti MP, Bruno C, Minetti C. Caveolin-3 T78M and T78K missense mutations lead to different phenotypes in vivo and in vitro. *Lab Invest.* 2008;88:275-83.
89. Catteruccia M, Sanna T, Santorelli FM, Tessa A, Di Giacomo R, Sauchelli D, Verbo A, Lo Monaco M, Servidei S. Rippling muscle disease and cardiomyopathy associated with a mutation in the CAV3 gene. *Neuromuscul Disord.* 2009;19:779-83.
90. Inagaki N, Hayashi T, Arimura T, Koga Y, Takahashi M, Shibata H, Teraoka K, Chikamori T, Yamashina A, Kimura A. Alpha B-crystallin mutation in dilated cardiomyopathy. *Biochem Biophys Res Commun.* 2006;342:379-86.
91. Geier C, Perrot A, Ozcelik C, Binner P, Counsell D, Hoffmann K, Pilz B, Martiniak Y, Gehmlich K, van der Ven PF, Furst DO, Vornwald A, von Hodenberg E, Nurnberg P, Scheffold T, Dietz R, Osterziel KJ. Mutations in the human muscle LIM protein gene in families with hypertrophic cardiomyopathy. *Circulation.* 2003;107:1390-5.
92. Bos JM, Poley RN, Ny M, Tester DJ, Xu X, Vatta M, Towbin JA, Gersh BJ, Ommen SR, Ackerman MJ. Genotype-phenotype relationships involving hypertrophic cardiomyopathy-associated mutations in titin, muscle LIM protein, and telethonin. *Mol Genet Metab.* 2006;88:78-85.
93. Geier C, Gehmlich K, Ehler E, Hassfeld S, Perrot A, Hayess K, Cardim N, Wenzel K, Erdmann B, Krackhardt F, Posch MG, Osterziel KJ, Bublak A, Nagele H, Scheffold T, Dietz R, Chien KR, Spuler S, Furst DO, Nurnberg P, Ozcelik C. Beyond the sarcomere: CSRP3 mutations cause hypertrophic cardiomyopathy. *Hum Mol Genet.* 2008;17:2753-65.

94. Hershberger RE, Parks SB, Kushner JD, Li D, Ludwigsen S, Jakobs P, Nauman D, Burgess D, Partain J, Litt M. Coding sequence mutations identified in MYH7, TNNT2, SCN5A, CSR3P, LBD3, and TCAP from 313 patients with familial or idiopathic dilated cardiomyopathy. *Clin Transl Sci.* 2008;1:21-6.
95. Goldfarb LG, Park KY, Cervenakova L, Gorokhova S, Lee HS, Vasconcelos O, Nagle JW, Semino-Mora C, Sivakumar K, Dalakas MC. Missense mutations in desmin associated with familial cardiac and skeletal myopathy. *Nat Genet.* 1998;19:402-3.
96. Li D, Tapscoft T, Gonzalez O, Burch PE, Quinones MA, Zoghbi WA, Hill R, Bachinski LL, Mann DL, Roberts R. Desmin mutation responsible for idiopathic dilated cardiomyopathy. *Circulation.* 1999;100:461-4.
97. Dalakas MC, Park KY, Semino-Mora C, Lee HS, Sivakumar K, Goldfarb LG. Desmin myopathy, a skeletal myopathy with cardiomyopathy caused by mutations in the desmin gene. *N Engl J Med.* 2000;342:770-80.
98. Miyamoto Y, Akita H, Shiga N, Takai E, Iwai C, Mizutani K, Kawai H, Takarada A, Yokoyama M. Frequency and clinical characteristics of dilated cardiomyopathy caused by desmin gene mutation in a Japanese population. *Eur Heart J.* 2001;22:2284-9.
99. Taylor MR, Slavov D, Ku L, Di Lenarda A, Sinagra G, Carniel E, Haubold K, Boucek MM, Ferguson D, Graw SL, Zhu X, Cavanaugh J, Sucharov CC, Long CS, Bristow MR, Lavori P, Mestroni L, Familial Cardiomyopathy Registry, BEST (Beta-Blocker Evaluation of Survival Trial) DNA Bank. Prevalence of desmin mutations in dilated cardiomyopathy. *Circulation.* 2007;115:1244-51.
100. Van Tintelen JP, Van Gelder IC, Asimaki A, Suurmeijer AJ, Wiesfeld AC, Jongbloed JD, van den Wijngaard A, Kuks JB, van Spaendonck-Zwarts KY, Notermans N, Boven L, van den Heuvel F, Veenstra-Knol HE, Saffitz JE, Hofstra RM, van den Berg MP. Severe cardiac phenotype with right ventricular predominance in a large cohort of patients with a single missense mutation in the DES gene. *Heart Rhythm.* 2009;6:1574-83.
101. Zhang J, Kumar A, Stalker HJ, Virdi G, Ferrans VJ, Horiba K, Fricker FJ, Wallace MR. Clinical and molecular studies of a large family with desmin-associated restrictive cardiomyopathy. *Clin Genet.* 2001;59:248-56.
102. Arbustini E, Pasotti M, Pilotto A, Pellegrini C, Grasso M, Previtali S, Repetto A, Bellini O, Azan G, Scaffino M, Campana C, Piccolo G, Vigano M, Tavazzi L. Desmin accumulation restrictive cardiomyopathy and atrioventricular block associated with desmin gene defects. *Eur J Heart Fail.* 2006;8:477-83.
103. Pruszczyk P, Kostera-Pruszczyk A, Shatunov A, Goudeau B, Draminska A, Takeda K, Sambuughin N, Vicart P, Strelkov SV, Goldfarb LG, Kaminska A. Restrictive cardiomyopathy with atrioventricular conduction block resulting from a desmin mutation. *Int J Cardiol.* 2007;117:244-53.
104. Siciliano G, Fanin M, Angelini C, Pollina LE, Miorin M, Saad FA, Freda MP, Muratorio A. Prevalent cardiac involvement in dystrophin Becker type mutation. *Neuromuscul Disord.* 1994;4:381-6.
105. Feng J, Yan JY, Buzin CH, Sommer SS, Towbin JA. Comprehensive mutation scanning of the dystrophin gene in patients with nonsyndromic X-linked dilated cardiomyopathy. *J Am Coll Cardiol.* 2002;40:1120-4.
106. Todorova A, Constantinova D, Kremensky I. Dilated cardiomyopathy and new 16 bp deletion in exon 44 of the Dystrophin gene: the possible role of repeated motifs in mutation generation. *Am J Med Genet A.* 2003;120A:5-7.
107. Juan-Mateu J, Paradas C, Olive M, Verdura E, Rivas E, Gonzalez-Quereda L, Rodriguez MJ, Baiget M, Gallano P. Isolated cardiomyopathy caused by a DMD nonsense mutation in somatic mosaicism: genetic normalization in skeletal muscle. *Clin Genet.* 2011; Epub ahead of print.

108. Heuser A, Plovie ER, Ellinor PT, Grossmann KS, Shin JT, Wichter T, Basson CT, Lerman BB, Sasse-Klaassen S, Thierfelder L, MacRae CA, Gerull B. Mutant desmocollin-2 causes arrhythmogenic right ventricular cardiomyopathy. *Am J Hum Genet.* 2006;79:1081-8.
109. Beffagna G, De Bortoli M, Nava A, Salamon M, Lorenzon A, Zaccolo M, Mancuso L, Sigalotti L, Bauce B, Occhi G, Basso C, Lanfranchi G, Towbin JA, Thiene G, Danieli GA, Rampazzo A. Missense mutations in desmocollin-2 N-terminus, associated with arrhythmogenic right ventricular cardiomyopathy, affect intracellular localization of desmocollin-2 in vitro. *BMC Med Genet.* 2007;8:65.
110. Simpson MA, Mansour S, Ahnood D, Kalidas K, Patton MA, McKenna WJ, Behr ER, Crosby AH. Homozygous mutation of desmocollin-2 in arrhythmogenic right ventricular cardiomyopathy with mild palmoplantar keratoderma and woolly hair. *Cardiology.* 2009;113:28-34.
111. Bhuiyan ZA, Jongbloed JD, van der Smagt J, Lombardi PM, Wiesfeld AC, Nelen M, Schouten M, Jongbloed R, Cox MG, van Wolferen M, Rodriguez LM, van Gelder IC, Bikker H, Suurmeijer AJ, van den Berg MP, Mannens MM, Hauer RN, Wilde AA, van Tintelen JP. Desmoglein-2 and desmocollin-2 mutations in dutch arrhythmogenic right ventricular dysplasia/cardiomyopathy patients: results from a multicenter study. *Circ Cardiovasc Genet.* 2009;2:418-27.
112. Gehmlich K, Lambiase PD, Asimaki A, Ciaccio EJ, Ehler E, Syrris P, Saffitz JE, McKenna WJ. A novel desmocollin-2 mutation reveals insights into the molecular link between desmosomes and gap junctions. *Heart Rhythm.* 2011;8:711-8.
113. Garcia-Pavia P, Syrris P, Salas C, Evans A, Mirelis JG, Cobo-Marcos M, Vilches C, Bornstein B, Segovia J, Alonso-Pulpon L, Elliott PM. Desmosomal protein gene mutations in patients with idiopathic dilated cardiomyopathy undergoing cardiac transplantation: a clinicopathological study. *Heart.* 2011;97:1744-52.
114. Awad MM, Dalal D, Cho E, Amat-Alarcon N, James C, Tichnell C, Tucker A, Russell SD, Bluemke DA, Dietz HC, Calkins H, Judge DP. DSG2 mutations contribute to arrhythmogenic right ventricular dysplasia/cardiomyopathy. *Am J Hum Genet.* 2006;79:136-42.
115. Syrris P, Ward D, Asimaki A, Evans A, Sen-Chowdhry S, Hughes SE, McKenna WJ. Desmoglein-2 mutations in arrhythmogenic right ventricular cardiomyopathy: a genotype-phenotype characterization of familial disease. *Eur Heart J.* 2007;28:581-8.
116. Bauce B, Nava A, Beffagna G, Basso C, Lorenzon A, Smaniotto G, De Bortoli M, Rigato I, Mazzotti E, Steriotis A, Marra MP, Towbin JA, Thiene G, Danieli GA, Rampazzo A. Multiple mutations in desmosomal proteins encoding genes in arrhythmogenic right ventricular cardiomyopathy/dysplasia. *Heart Rhythm.* 2010;7:22-9.
117. Norgett EE, Hatsell SJ, Carvajal-Huerta L, Cabezas JC, Common J, Purkis PE, Whittock N, Leigh IM, Stevens HP, Kelsell DP. Recessive mutation in desmoplakin disrupts desmoplakin-intermediate filament interactions and causes dilated cardiomyopathy, woolly hair and keratoderma. *Hum Mol Genet.* 2000;9:2761-6.
118. Alcalai R, Metzger S, Rosenheck S, Meiner V, Chajek-Shaul T. A recessive mutation in desmoplakin causes arrhythmogenic right ventricular dysplasia, skin disorder, and woolly hair. *J Am Coll Cardiol.* 2003;42:319-27.
119. Bauce B, Basso C, Rampazzo A, Beffagna G, Daliento L, Frigo G, Malacrida S, Settimo L, Danieli G, Thiene G, Nava A. Clinical profile of four families with arrhythmogenic right ventricular cardiomyopathy caused by dominant desmoplakin mutations. *Eur Heart J.* 2005;26:1666-75.
120. Williams T, Machann W, Kuhler L, Hamm H, Muller-Hocker J, Zimmer M, Ertl G, Ritter O, Beer M, Schonberger J. Novel desmoplakin mutation: juvenile biventricular cardiomyopathy with left ventricular non-compaction and acantholytic palmoplantar keratoderma. *Clin Res Cardiol.* 2011;100:1087-93.

121. Xing Y, Ichida F, Matsuoka T, Isobe T, Ikemoto Y, Higaki T, Tsuji T, Haneda N, Kuwabara A, Chen R, Futatani T, Tsubata S, Watanabe S, Watanabe K, Hirono K, Uese K, Miyawaki T, Bowles KR, Bowles NE, Towbin JA. Genetic analysis in patients with left ventricular noncompaction and evidence for genetic heterogeneity. *Mol Genet Metab.* 2006;88:71-7.
122. Vohanka S, Vytopil M, Bednarik J, Lukas Z, Kadanka Z, Schildberger J, Ricotti R, Bione S, Toniolo D. A mutation in the X-linked Emery-Dreifuss muscular dystrophy gene in a patient affected with conduction cardiomyopathy. *Neuromuscul Disord.* 2001;11:411-3.
123. Schonberger J, Wang L, Shin JT, Kim SD, Depreux FF, Zhu H, Zon L, Pizard A, Kim JB, Macrae CA, Mungall AJ, Seidman JG, Seidman CE. Mutation in the transcriptional coactivator EYA4 causes dilated cardiomyopathy and sensorineural hearing loss. *Nat Genet.* 2005;37:418-22.
124. Arimura T, Hayashi T, Matsumoto Y, Shibata H, Hiroi S, Nakamura T, Inagaki N, Hinohara K, Takahashi M, Manatsu SI, Sasaoka T, Izumi T, Bonne G, Schwartz K, Kimura A. Structural analysis of four and half LIM protein-2 in dilated cardiomyopathy. *Biochem Biophys Res Commun.* 2007;357:162-7.
125. Krasnianski M, Neudecker S, Deschauer M, Zierz S. The clinical spectrum of limb-girdle muscular dystrophies type 2I in cases of a mutation in the "fukutin-related- protein"-gene. *Nervenarzt.* 2004;75:770-5.
126. Muller T, Krasnianski M, Witthaut R, Deschauer M, Zierz S. Dilated cardiomyopathy may be an early sign of the C826A Fukutin-related protein mutation. *Neuromuscul Disord.* 2005;15:372-6.
127. D'Amico A, Petrini S, Parisi F, Tessa A, Francalanci P, Grutter G, Santorelli FM, Bertini E. Heart transplantation in a child with LGMD2I presenting as isolated dilated cardiomyopathy. *Neuromuscul Disord.* 2008;18:153-5.
128. Bourteel H, Vermersch P, Cuisset JM, Maurage CA, Laforet P, Richard P, Stojkovic T. Clinical and mutational spectrum of limb-girdle muscular dystrophy type 2I in 11 French patients. *J Neurol Neurosurg Psychiatry.* 2009;80:1405-8.
129. Murakami T, Hayashi YK, Noguchi S, Ogawa M, Nonaka I, Tanabe Y, Ogino M, Takada F, Eriguchi M, Kotooka N, Campbell KP, Osawa M, Nishino I. Fukutin gene mutations cause dilated cardiomyopathy with minimal muscle weakness. *Ann Neurol.* 2006;60:597-602.
130. Theis JL, Sharpe KM, Matsumoto ME, Chai HS, Nair AA, Theis JD, de Andrade M, Wieben ED, Michels VV, Olson TM. Homozygosity mapping and exome sequencing reveal GATAD1 mutation in autosomal recessive dilated cardiomyopathy. *Circ Cardiovasc Genet.* 2011;4:585-94.
131. Ishii S, Sakuraba H, Suzuki Y. Point mutations in the upstream region of the alpha-galactosidase A gene exon 6 in an atypical variant of Fabry disease. *Hum Genet.* 1992;89:29-32.
132. Nakao S, Takenaka T, Maeda M, Kodama C, Tanaka A, Tahara M, Yoshida A, Kuriyama M, Hayashibe H, Sakuraba H. An atypical variant of Fabry's disease in men with left ventricular hypertrophy. *N Engl J Med.* 1995;333:288-93.
133. Yang CC, Lai LW, Whitehair O, Hwu WL, Chiang SC, Lien YH. Two novel mutations in the alpha-galactosidase A gene in Chinese patients with Fabry disease. *Clin Genet.* 2003;63:205-9.
134. Monserrat L, Gimeno-Blanes JR, Marin F, Hermida-Prieto M, Garcia-Honrubia A, Perez I, Fernandez X, de Nicolas R, de la Morena G, Paya E, Yague J, Egado J. Prevalence of fabry disease in a cohort of 508 unrelated patients with hypertrophic cardiomyopathy. *J Am Coll Cardiol.* 2007;50:2399-403.
135. Havndrup O, Christiansen M, Stoevring B, Jensen M, Hoffman-Bang J, Andersen PS, Hasholt L, Norremolle A, Feldt-Rasmussen U, Kober L, Bundgaard H. Fabry disease mimicking hypertrophic cardiomyopathy: genetic screening needed for establishing the diagnosis in women. *Eur J Heart Fail.* 2010;12:535-40.
136. Knoll R, Postel R, Wang J, Kratzner R, Hennecke G, Vacaru AM, Vakeel P, Schubert C, Murthy K, Rana BK, Kube D, Knoll G, Schafer K, Hayashi T, Holm T, Kimura A, Schork N, Toliat MR, Nurnberg P,

- Schultheiss HP, Schaper W, Schaper J, Bos E, Den Hertog J, van Eeden FJ, Peters PJ, Hasenfuss G, Chien KR, Bakkens J. Laminin-alpha4 and integrin-linked kinase mutations cause human cardiomyopathy via simultaneous defects in cardiomyocytes and endothelial cells. *Circulation*. 2007;116:515-25.
137. Matsushita Y, Furukawa T, Kasanuki H, Nishibatake M, Kurihara Y, Ikeda A, Kamatani N, Takeshima H, Matsuoka R. Mutation of junctophilin type 2 associated with hypertrophic cardiomyopathy. *J Hum Genet*. 2007;52:543-8.
 138. Landstrom AP, Weisleder N, Batalden KB, Bos JM, Tester DJ, Ommen SR, Wehrens XH, Claycomb WC, Ko JK, Hwang M, Pan Z, Ma J, Ackerman MJ. Mutations in JPH2-encoded junctophilin-2 associated with hypertrophic cardiomyopathy in humans. *J Mol Cell Cardiol*. 2007;42:1026-35.
 139. Antoniadou L, Tsatsopoulou A, Anastasakis A, Syrris P, Asimaki A, Panagiotakos D, Zambartas C, Stefanadis C, McKenna WJ, Protonotarios N. Arrhythmogenic right ventricular cardiomyopathy caused by deletions in plakophilin-2 and plakoglobin (Naxos disease) in families from Greece and Cyprus: genotype-phenotype relations, diagnostic features and prognosis. *Eur Heart J*. 2006;27:2208-16.
 140. Nishino I, Fu J, Tanji K, Yamada T, Shimojo S, Koori T, Mora M, Riggs JE, Oh SJ, Koga Y, Sue CM, Yamamoto A, Murakami N, Shanske S, Byrne E, Bonilla E, Nonaka I, DiMauro S, Hirano M. Primary LAMP-2 deficiency causes X-linked vacuolar cardiomyopathy and myopathy (Danon disease). *Nature*. 2000;406:906-10.
 141. Horvath J, Ketelsen UP, Geibel-Zehender A, Boehm N, Olbrich H, Korinthenberg R, Omran H. Identification of a novel LAMP2 mutation responsible for X-chromosomal dominant Danon disease. *Neuropediatrics*. 2003;34:270-3.
 142. Charron P, Villard E, Sebillon P, Laforet P, Maisonobe T, Dubocq-Bidot L, Romero N, Drouin-Garraud V, Frebourg T, Richard P, Eymard B, Komajda M. Danon's disease as a cause of hypertrophic cardiomyopathy: a systematic survey. *Heart*. 2004;90:842-6.
 143. Arad M, Maron BJ, Gorham JM, Johnson WH, Jr, Saul JP, Perez-Atayde AR, Spirito P, Wright GB, Kanter RJ, Seidman CE, Seidman JG. Glycogen storage diseases presenting as hypertrophic cardiomyopathy. *N Engl J Med*. 2005;352:362-72.
 144. Yang Z, McMahon CJ, Smith LR, Bersola J, Adesina AM, Breinholt JP, Kearney DL, Dreyer WJ, Denfield SW, Price JF, Grenier M, Kertesz NJ, Clunie SK, Fernbach SD, Southern JF, Berger S, Towbin JA, Bowles KR, Bowles NE. Danon disease as an underrecognized cause of hypertrophic cardiomyopathy in children. *Circulation*. 2005;112:1612-7.
 145. Sugie K, Yamamoto A, Murayama K, Oh SJ, Takahashi M, Mora M, Riggs JE, Colomer J, Iturriaga C, Meloni A, Lamperti C, Saitoh S, Byrne E, DiMauro S, Nonaka I, Hirano M, Nishino I. Clinicopathological features of genetically confirmed Danon disease. *Neurology*. 2002;58:1773-8.
 146. Taylor MR, Ku L, Slavov D, Cavanaugh J, Boucek M, Zhu X, Graw S, Carniel E, Barnes C, Quan D, Prall R, Lovell MA, Mierau G, Ruegg P, Mandava N, Bristow MR, Towbin JA, Mestroni L, Familial Cardiomyopathy Registry. Danon disease presenting with dilated cardiomyopathy and a complex phenotype. *J Hum Genet*. 2007;52:830-5.
 147. Vatta M, Mohapatra B, Jimenez S, Sanchez X, Faulkner G, Perles Z, Sinagra G, Lin JH, Vu TM, Zhou Q, Bowles KR, Di Lenarda A, Schimmenti L, Fox M, Chrisco MA, Murphy RT, McKenna W, Elliott P, Bowles NE, Chen J, Valle G, Towbin JA. Mutations in Cypher/ZASP in patients with dilated cardiomyopathy and left ventricular non-compaction. *J Am Coll Cardiol*. 2003;42:2014-27.
 148. Arimura T, Hayashi T, Terada H, Lee SY, Zhou Q, Takahashi M, Ueda K, Nouchi T, Hohda S, Shibutani M, Hirose M, Chen J, Park JE, Yasunami M, Hayashi H, Kimura A. A Cypher/ZASP mutation

- associated with dilated cardiomyopathy alters the binding affinity to protein kinase C. *J Biol Chem.* 2004;279:6746-52.
149. Marziliano N, Mannarino S, Nespoli L, Diegoli M, Pasotti M, Malattia C, Grasso M, Pilotto A, Porcu E, Raisaro A, Raineri C, Dore R, Maggio PP, Brega A, Arbustini E. Barth syndrome associated with compound hemizygoty and heterozygoty of the TAZ and LDB3 genes. *Am J Med Genet A.* 2007;143A:907-15.
 150. Fatkin D, MacRae C, Sasaki T, Wolff MR, Porcu M, Frenneaux M, Atherton J, Vidaillet HJ, Jr, Spudich S, De Girolami U, Seidman JG, Seidman C, Muntoni F, Muehle G, Johnson W, McDonough B. Missense mutations in the rod domain of the lamin A/C gene as causes of dilated cardiomyopathy and conduction-system disease. *N Engl J Med.* 1999;341:1715-24.
 151. Van Tintelen JP, Hofstra RM, Katerberg H, Rossenbacker T, Wiesfeld AC, du Marchie Sarvaas GJ, Wilde AA, van Langen IM, Nannenberg EA, van der Kooij AJ, Kraak M, van Gelder IC, van Veldhuisen DJ, Vos Y, van den Berg MP, Working Group on Inherited Cardiac Disorders, line 27/50, Interuniversity Cardiology Institute of The Netherlands. High yield of LMNA mutations in patients with dilated cardiomyopathy and/or conduction disease referred to cardiogenetics outpatient clinics. *Am Heart J.* 2007;154:1130-9.
 152. Rampersaud E, Siegfried JD, Norton N, Li D, Martin E, Hershberger RE. Rare variant mutations identified in pediatric patients with dilated cardiomyopathy. *Prog Pediatr Cardiol.* 2011;31:39-47.
 153. Millat G, Bouvagnet P, Chevalier P, Sebbag L, Dulac A, Dauphin C, Jouk PS, Delrue MA, Thambo JB, Le Metayer P, Seronde MF, Faivre L, Eicher JC, Rousson R. Clinical and mutational spectrum in a cohort of 105 unrelated patients with dilated cardiomyopathy. *Eur J Med Genet.* 2011;54:e570-5.
 154. Hermida-Prieto M, Monserrat L, Castro-Beiras A, Laredo R, Soler R, Peteiro J, Rodriguez E, Bouzas B, Alvarez N, Muniz J, Crespo-Leiro M. Familial dilated cardiomyopathy and isolated left ventricular noncompaction associated with lamin A/C gene mutations. *Am J Cardiol.* 2004;94:50-4.
 155. Watkins H, Conner D, Thierfelder L, Jarcho JA, MacRae C, McKenna WJ, Maron BJ, Seidman JG, Seidman CE. Mutations in the cardiac myosin binding protein-C gene on chromosome 11 cause familial hypertrophic cardiomyopathy. *Nat Genet.* 1995;11:434-7.
 156. Bonne G, Carrier L, Bercovici J, Cruaud C, Richard P, Hainque B, Gautel M, Labeit S, James M, Beckmann J, Weissenbach J, Vosberg HP, Fiszman M, Komajda M, Schwartz K. Cardiac myosin binding protein-C gene splice acceptor site mutation is associated with familial hypertrophic cardiomyopathy. *Nat Genet.* 1995;11:438-40.
 157. Carrier L, Bonne G, Barend E, Yu B, Richard P, Niel F, Hainque B, Cruaud C, Gary F, Labeit S, Bouhour JB, Dubourg O, Desnos M, Hagege AA, Trent RJ, Komajda M, Fiszman M, Schwartz K. Organization and sequence of human cardiac myosin binding protein C gene (MYBPC3) and identification of mutations predicted to produce truncated proteins in familial hypertrophic cardiomyopathy. *Circ Res.* 1997;80:427-34.
 158. Richard P, Charron P, Carrier L, Ledeuil C, Cheav T, Pichereau C, Benaiche A, Isnard R, Dubourg O, Burbani M, Gueffet JP, Millaire A, Desnos M, Schwartz K, Hainque B, Komajda M, EUROGENE Heart Failure Project. Hypertrophic cardiomyopathy: distribution of disease genes, spectrum of mutations, and implications for a molecular diagnosis strategy. *Circulation.* 2003;107:2227-32.
 159. Alders M, Jongbloed R, Deelen W, van den Wijngaard A, Doevendans P, Ten Cate F, Regitz-Zagrosek V, Vosberg HP, van Langen I, Wilde A, Dooijes D, Mannens M. The 2373insG mutation in the MYBPC3 gene is a founder mutation, which accounts for nearly one-fourth of the HCM cases in the Netherlands. *Eur Heart J.* 2003;24:1848-53.

160. Ehlermann P, Weichenhan D, Zehelein J, Steen H, Pribe R, Zeller R, Lehrke S, Zugck C, Ivandic BT, Katus HA. Adverse events in families with hypertrophic or dilated cardiomyopathy and mutations in the MYBPC3 gene. *BMC Med Genet.* 2008;9:95.
161. Ripoll Vera T, Monserrat Iglesias L, Hermida Prieto M, Ortiz M, Rodriguez Garcia I, Govea Callizo N, Gomez Navarro C, Rosell Andreo J, Gamez Martinez JM, Pons Llado G, Cremer Luengos D, Torres Marques J. The R820W mutation in the MYBPC3 gene, associated with hypertrophic cardiomyopathy in cats, causes hypertrophic cardiomyopathy and left ventricular non-compaction in humans. *Int J Cardiol.* 2010;145:405-7.
162. Millat G, Bouvagnet P, Chevalier P, Dauphin C, Jouk PS, Da Costa A, Prieur F, Bresson JL, Faivre L, Eicher JC, Chassaign N, Crehalet H, Porcher R, Rodriguez-Lafrasse C, Rousson R. Prevalence and spectrum of mutations in a cohort of 192 unrelated patients with hypertrophic cardiomyopathy. *Eur J Med Genet.* 2010;53:261-7.
163. Garcia-Pavia P, Vazquez ME, Segovia J, Salas C, Avellana P, Gomez-Bueno M, Vilches C, Gallardo ME, Garesse R, Molano J, Bornstein B, Alonso-Pulpon L. Genetic basis of end-stage hypertrophic cardiomyopathy. *Eur J Heart Fail.* 2011;13:1193-201.
164. Daehmlow S, Erdmann J, Knueppel T, Gille C, Froemmel C, Hummel M, Hetzer R, Regitz-Zagrosek V. Novel mutations in sarcomeric protein genes in dilated cardiomyopathy. *Biochem Biophys Res Commun.* 2002;298:116-20.
165. Moller DV, Andersen PS, Hedley P, Ersboll MK, Bundgaard H, Moolman-Smook J, Christiansen M, Kober L. The role of sarcomere gene mutations in patients with idiopathic dilated cardiomyopathy. *Eur J Hum Genet.* 2009;17:1241-9.
166. Morales A, Painter T, Li R, Siegfried JD, Li D, Norton N, Hershberger RE. Rare variant mutations in pregnancy-associated or peripartum cardiomyopathy. *Circulation.* 2010;121:2176-82.
167. Dellefave LM, Pytel P, Mewborn S, Mora B, Guris DL, Fedson S, Waggoner D, Moskowitz I, McNally EM. Sarcomere mutations in cardiomyopathy with left ventricular hypertrabeculation. *Circ Cardiovasc Genet.* 2009;2:442-9.
168. Probst S, Oechslin E, Schuler P, Greutmann M, Boye P, Knirsch W, Berger F, Thierfelder L, Jenni R, Klaassen S. Sarcomere gene mutations in isolated left ventricular noncompaction cardiomyopathy do not predict clinical phenotype. *Circ Cardiovasc Genet.* 2011;4:367-74.
169. Carniel E, Taylor MR, Sinagra G, Di Lenarda A, Ku L, Fain PR, Boucek MM, Cavanaugh J, Miodic S, Slavov D, Graw SL, Feiger J, Zhu XZ, Dao D, Ferguson DA, Bristow MR, Mestroni L. Alpha-myosin heavy chain: a sarcomeric gene associated with dilated and hypertrophic phenotypes of cardiomyopathy. *Circulation.* 2005;112:54-9.
170. Fananapazir L, Dalakas MC, Cyran F, Cohn G, Epstein ND. Missense mutations in the beta-myosin heavy-chain gene cause central core disease in hypertrophic cardiomyopathy. *Proc Natl Acad Sci U S A.* 1993;90:3993-7.
171. Erdmann J, Daehmlow S, Wischke S, Senyuva M, Werner U, Raible J, Tanis N, Dyachenko S, Hummel M, Hetzer R, Regitz-Zagrosek V. Mutation spectrum in a large cohort of unrelated consecutive patients with hypertrophic cardiomyopathy. *Clin Genet.* 2003;64:339-49.
172. Van Driest SL, Jaeger MA, Ommen SR, Will ML, Gersh BJ, Tajik AJ, Ackerman MJ. Comprehensive analysis of the beta-myosin heavy chain gene in 389 unrelated patients with hypertrophic cardiomyopathy. *J Am Coll Cardiol.* 2004;44:602-10.
173. Kamisago M, Sharma SD, DePalma SR, Solomon S, Sharma P, McDonough B, Smoot L, Mullen MP, Woolf PK, Wigle ED, Seidman JG, Seidman CE. Mutations in sarcomere protein genes as a cause of dilated cardiomyopathy. *N Engl J Med.* 2000;343:1688-96.

174. Karam S, Raboisson MJ, Ducreux C, Chalabreysse L, Millat G, Bozio A, Bouvagnet P. A de novo mutation of the beta cardiac myosin heavy chain gene in an infantile restrictive cardiomyopathy. *Congenit Heart Dis*. 2008;3:138-43.
175. Rai TS, Ahmad S, Ahluwalia TS, Ahuja M, Bahl A, Saikia UN, Singh B, Talwar KK, Khullar M. Genetic and clinical profile of Indian patients of idiopathic restrictive cardiomyopathy with and without hypertrophy. *Mol Cell Biochem*. 2009;331:187-92.
176. Hoedemaekers YM, Caliskan K, Majoor-Krakauer D, van de Laar I, Michels M, Witsenburg M, ten Cate FJ, Simoons ML, Dooijes D. Cardiac beta-myosin heavy chain defects in two families with non-compaction cardiomyopathy: linking non-compaction to hypertrophic, restrictive, and dilated cardiomyopathies. *Eur Heart J*. 2007;28:2732-7.
177. Poetter K, Jiang H, Hassanzadeh S, Master SR, Chang A, Dalakas MC, Rayment I, Sellers JR, Fananapazir L, Epstein ND. Mutations in either the essential or regulatory light chains of myosin are associated with a rare myopathy in human heart and skeletal muscle. *Nat Genet*. 1996;13:63-9.
178. Flavigny J, Richard P, Isnard R, Carrier L, Charron P, Bonne G, Forissier JF, Desnos M, Dubourg O, Komajda M, Schwartz K, Hainque B. Identification of two novel mutations in the ventricular regulatory myosin light chain gene (MYL2) associated with familial and classical forms of hypertrophic cardiomyopathy. *J Mol Med (Berl)*. 1998;76:208-14.
179. Caleshu C, Sakhuja R, Nussbaum RL, Schiller NB, Ursell PC, Eng C, De Marco T, McGlothlin D, Burchard EG, Rame JE. Furthering the link between the sarcomere and primary cardiomyopathies: restrictive cardiomyopathy associated with multiple mutations in genes previously associated with hypertrophic or dilated cardiomyopathy. *Am J Med Genet A*. 2011;155A:2229-35.
180. Olson TM, Karst ML, Whitby FG, Driscoll DJ. Myosin light chain mutation causes autosomal recessive cardiomyopathy with mid-cavitary hypertrophy and restrictive physiology. *Circulation*. 2002;105:2337-40.
181. Davis JS, Hassanzadeh S, Winitsky S, Lin H, Satorius C, Vemuri R, Aletras AH, Wen H, Epstein ND. The overall pattern of cardiac contraction depends on a spatial gradient of myosin regulatory light chain phosphorylation. *Cell*. 2001;107:631-41.
182. Osio A, Tan L, Chen SN, Lombardi R, Nagueh SF, Shete S, Roberts R, Willerson JT, Marian AJ. Myozenin 2 is a novel gene for human hypertrophic cardiomyopathy. *Circ Res*. 2007;100:766-8.
183. Purevjav E, Arimura T, Augustin S, Huby AC, Takagi K, Nunoda S, Kearney DL, Taylor MD, Terasaki F, Bos JM, Ommen SR, Shibata H, Takahashi M, Itoh-Satoh M, McKenna WJ, Murphy RT, Labeit S, Yamanaka Y, Machida N, Park JE, Alexander PM, Weintraub RG, Kitaura Y, Ackerman MJ, Kimura A, Towbin JA. Molecular basis for clinical heterogeneity in inherited cardiomyopathies due to myopalladin mutations. *Hum Mol Genet*. 2012;21:2039-53.
184. Duboscq-Bidot L, Xu P, Charron P, Neyroud N, Dilanian G, Millaire A, Bors V, Komajda M, Villard E. Mutations in the Z-band protein myopalladin gene and idiopathic dilated cardiomyopathy. *Cardiovasc Res*. 2008;77:118-25.
185. Wang H, Li Z, Wang J, Sun K, Cui Q, Song L, Zou Y, Wang X, Liu X, Hui R, Fan Y. Mutations in NEXN, a Z-disc gene, are associated with hypertrophic cardiomyopathy. *Am J Hum Genet*. 2010;87:687-93.
186. Hassel D, Dahme T, Erdmann J, Meder B, Hüge A, Stoll M, Just S, Hess A, Ehlermann P, Weichenhan D, Grimm M, Liptau H, Hetzer R, Regitz-Zagrosek V, Fischer C, Nurnberg P, Schunkert H, Katus HA, Rottbauer W. Nexilin mutations destabilize cardiac Z-disks and lead to dilated cardiomyopathy. *Nat Med*. 2009;15:1281-8.
187. Arola AM, Sanchez X, Murphy RT, Hasle E, Li H, Elliott PM, McKenna WJ, Towbin JA, Bowles NE. Mutations in PDLIM3 and MYOZ1 encoding myocyte Z line proteins are infrequently found in idiopathic dilated cardiomyopathy. *Mol Genet Metab*. 2007;90:435-40.

188. Syrris P, Ward D, Asimaki A, Sen-Chowdhry S, Ebrahim HY, Evans A, Hitomi N, Norman M, Pantazis A, Shaw AL, Elliott PM, McKenna WJ. Clinical expression of plakophilin-2 mutations in familial arrhythmogenic right ventricular cardiomyopathy. *Circulation*. 2006;113:356-64.
189. Van Tintelen JP, Entius MM, Bhuiyan ZA, Jongbloed R, Wiesfeld AC, Wilde AA, van der Smagt J, Boven LG, Mannens MM, van Langen IM, Hofstra RM, Otterspoor LC, Doevendans PA, Rodriguez LM, van Gelder IC, Hauer RN. Plakophilin-2 mutations are the major determinant of familial arrhythmogenic right ventricular dysplasia/cardiomyopathy. *Circulation*. 2006;113:1650-8.
190. Dalal D, Molin LH, Piccini J, Tichnell C, James C, Bomma C, Prakasa K, Towbin JA, Marcus FI, Spevak PJ, Bluemke DA, Abraham T, Russell SD, Calkins H, Judge DP. Clinical features of arrhythmogenic right ventricular dysplasia/cardiomyopathy associated with mutations in plakophilin-2. *Circulation*. 2006;113:1641-9.
191. Lahtinen AM, Lehtonen A, Kaartinen M, Toivonen L, Swan H, Widen E, Lehtonen E, Lehto VP, Kontula K. Plakophilin-2 missense mutations in arrhythmogenic right ventricular cardiomyopathy. *Int J Cardiol*. 2008;126:92-100.
192. Schmitt JP, Kamisago M, Asahi M, Li GH, Ahmad F, Mende U, Kranias EG, MacLennan DH, Seidman JG, Seidman CE. Dilated cardiomyopathy and heart failure caused by a mutation in phospholamban. *Science*. 2003;299:1410-3.
193. Haghighi K, Kolokathis F, Pater L, Lynch RA, Asahi M, Gramolini AO, Fan GC, Tsiapras D, Hahn HS, Adamopoulos S, Liggett SB, Dorn GW, 2nd, MacLennan DH, Kremastinos DT, Kranias EG. Human phospholamban null results in lethal dilated cardiomyopathy revealing a critical difference between mouse and human. *J Clin Invest*. 2003;111:869-76.
194. Haghighi K, Kolokathis F, Gramolini AO, Waggoner JR, Pater L, Lynch RA, Fan GC, Tsiapras D, Parekh RR, Dorn GW, 2nd, MacLennan DH, Kremastinos DT, Kranias EG. A mutation in the human phospholamban gene, deleting arginine 14, results in lethal, hereditary cardiomyopathy. *Proc Natl Acad Sci U S A*. 2006;103:1388-93.
195. DeWitt MM, MacLeod HM, Soliven B, McNally EM. Phospholamban R14 deletion results in late-onset, mild, hereditary dilated cardiomyopathy. *J Am Coll Cardiol*. 2006;48:1396-8.
196. Posch MG, Perrot A, Geier C, Boldt LH, Schmidt G, Lehmkuhl HB, Hetzer R, Dietz R, Gutberlet M, Haverkamp W, Ozcelik C. Genetic deletion of arginine 14 in phospholamban causes dilated cardiomyopathy with attenuated electrocardiographic R amplitudes. *Heart Rhythm*. 2009;6:480-6.
197. Blair E, Redwood C, Ashrafian H, Oliveira M, Broxholme J, Kerr B, Salmon A, Ostman-Smith I, Watkins H. Mutations in the gamma(2) subunit of AMP-activated protein kinase cause familial hypertrophic cardiomyopathy: evidence for the central role of energy compromise in disease pathogenesis. *Hum Mol Genet*. 2001;10:1215-20.
198. Arad M, Benson DW, Perez-Atayde AR, McKenna WJ, Sparks EA, Kanter RJ, McGarry K, Seidman JG, Seidman CE. Constitutively active AMP kinase mutations cause glycogen storage disease mimicking hypertrophic cardiomyopathy. *J Clin Invest*. 2002;109:357-62.
199. Li D, Parks SB, Kushner JD, Nauman D, Burgess D, Ludwigsen S, Partain J, Nixon RR, Allen CN, Irwin RP, Jakobs PM, Litt M, Hershberger RE. Mutations of presenilin genes in dilated cardiomyopathy and heart failure. *Am J Hum Genet*. 2006;79:1030-9.
200. Brauch KM, Karst ML, Herron KJ, de Andrade M, Pellikka PA, Rodeheffer RJ, Michels VV, Olson TM. Mutations in ribonucleic acid binding protein gene cause familial dilated cardiomyopathy. *J Am Coll Cardiol*. 2009;54:930-41.
201. Li D, Morales A, Gonzalez-Quintana J, Norton N, Siegfried JD, Hofmeyer M, Hershberger RE. Identification of novel mutations in RBM20 in patients with dilated cardiomyopathy. *Clin Transl Sci*. 2010;3:90-7.

202. Refaat MM, Lubitz SA, Makino S, Islam Z, Frangiskakis JM, Mehdi H, Gutmann R, Zhang ML, Bloom HL, MacRae CA, Dudley SC, Shalaby AA, Weiss R, McNamara DM, London B, Ellinor PT. Genetic variation in the alternative splicing regulator RBM20 is associated with dilated cardiomyopathy. *Heart Rhythm*. 2012;9:390-6.
203. Bhuiyan ZA, van den Berg MP, van Tintelen JP, Bink-Boelkens MT, Wiesfeld AC, Alders M, Postma AV, van Langen I, Mannens MM, Wilde AA. Expanding spectrum of human RYR2-related disease: new electrocardiographic, structural, and genetic features. *Circulation*. 2007;116:1569-76.
204. McNair WP, Ku L, Taylor MR, Fain PR, Dao D, Wolfel E, Mestroni L, Familial Cardiomyopathy Registry Research Group. SCN5A mutation associated with dilated cardiomyopathy, conduction disorder, and arrhythmia. *Circulation*. 2004;110:2163-7.
205. Olson TM, Michels VV, Ballew JD, Reyna SP, Karst ML, Herron KJ, Horton SC, Rodeheffer RJ, Anderson JL. Sodium channel mutations and susceptibility to heart failure and atrial fibrillation. *JAMA*. 2005;293:447-54.
206. Shi R, Zhang Y, Yang C, Huang C, Zhou X, Qiang H, Grace AA, Huang CL, Ma A. The cardiac sodium channel mutation delQKP 1507-1509 is associated with the expanding phenotypic spectrum of LQT3, conduction disorder, dilated cardiomyopathy, and high incidence of youth sudden death. *Europace*. 2008;10:1329-35.
207. McNair WP, Sinagra G, Taylor MR, Di Lenarda A, Ferguson DA, Salcedo EE, Slavov D, Zhu X, Caldwell JH, Mestroni L, Familial Cardiomyopathy Registry Research Group. SCN5A mutations associate with arrhythmic dilated cardiomyopathy and commonly localize to the voltage-sensing mechanism. *J Am Coll Cardiol*. 2011;57:2160-8.
208. Erkapic D, Neumann T, Schmitt J, Sperzel J, Berkowitsch A, Kuniss M, Hamm CW, Pitschner HF. Electrical storm in a patient with arrhythmogenic right ventricular cardiomyopathy and SCN5A mutation. *Europace*. 2008;10:884-7.
209. Shan L, Makita N, Xing Y, Watanabe S, Futatani T, Ye F, Saito K, Ibuki K, Watanabe K, Hirono K, Uese K, Ichida F, Miyawaki T, Origasa H, Bowles NE, Towbin JA. SCN5A variants in Japanese patients with left ventricular noncompaction and arrhythmia. *Mol Genet Metab*. 2008;93:468-74.
210. Tsubata S, Bowles KR, Vatta M, Zintz C, Titus J, Muhonen L, Bowles NE, Towbin JA. Mutations in the human delta-sarcoglycan gene in familial and sporadic dilated cardiomyopathy. *J Clin Invest*. 2000;106:655-62.
211. Karkkainen S, Miettinen R, Tuomainen P, Karkkainen P, Helio T, Reissell E, Kaartinen M, Toivonen L, Nieminen MS, Kuusisto J, Laakso M, Peuhkurinen K. A novel mutation, Arg71Thr, in the delta-sarcoglycan gene is associated with dilated cardiomyopathy. *J Mol Med (Berl)*. 2003;81:795-800.
212. D'Adamo P, Fassone L, Gedeon A, Janssen EA, Bione S, Bolhuis PA, Barth PG, Wilson M, Haan E, Orstavik KH, Patton MA, Green AJ, Zammarchi E, Donati MA, Toniolo D. The X-linked gene G4.5 is responsible for different infantile dilated cardiomyopathies. *Am J Hum Genet*. 1997;61:862-7.
213. Bleyl SB, Mumford BR, Thompson V, Carey JC, Pysker TJ, Chin TK, Ward K. Neonatal, lethal noncompaction of the left ventricular myocardium is allelic with Barth syndrome. *Am J Hum Genet*. 1997;61:868-72.
214. Ichida F, Tsubata S, Bowles KR, Haneda N, Uese K, Miyawaki T, Dreyer WJ, Messina J, Li H, Bowles NE, Towbin JA. Novel gene mutations in patients with left ventricular noncompaction or Barth syndrome. *Circulation*. 2001;103:1256-63.
215. Chen R, Tsuji T, Ichida F, Bowles KR, Yu X, Watanabe S, Hirono K, Tsubata S, Hamamichi Y, Ohta J, Imai Y, Bowles NE, Miyawaki T, Towbin JA, Noncompaction study collaborators. Mutation analysis of the G4.5 gene in patients with isolated left ventricular noncompaction. *Mol Genet Metab*. 2002;77:319-25.

216. Kirk EP, Sunde M, Costa MW, Rankin SA, Wolstein O, Castro ML, Butler TL, Hyun C, Guo G, Otway R, Mackay JP, Waddell LB, Cole AD, Hayward C, Keogh A, Macdonald P, Griffiths L, Fatkin D, Sholler GF, Zorn AM, Feneley MP, Winlaw DS, Harvey RP. Mutations in cardiac T-box factor gene TBX20 are associated with diverse cardiac pathologies, including defects of septation and valvulogenesis and cardiomyopathy. *Am J Hum Genet.* 2007;81:280-91.
217. Hayashi T, Arimura T, Itoh-Satoh M, Ueda K, Hohda S, Inagaki N, Takahashi M, Hori H, Yasunami M, Nishi H, Koga Y, Nakamura H, Matsuzaki M, Choi BY, Bae SW, You CW, Han KH, Park JE, Knoll R, Hoshijima M, Chien KR, Kimura A. Tcap gene mutations in hypertrophic cardiomyopathy and dilated cardiomyopathy. *J Am Coll Cardiol.* 2004;44:2192-201.
218. Merner ND, Hodgkinson KA, Haywood AF, Connors S, French VM, Drenckhahn JD, Kupprion C, Ramadanova K, Thierfelder L, McKenna W, Gallagher B, Morris-Larkin L, Bassett AS, Parfrey PS, Young TL. Arrhythmogenic right ventricular cardiomyopathy type 5 is a fully penetrant, lethal arrhythmic disorder caused by a missense mutation in the TMEM43 gene. *Am J Hum Genet.* 2008;82:809-21.
219. Taylor MR, Slavov D, Gajewski A, Vlcek S, Ku L, Fain PR, Carniel E, Di Lenarda A, Sinagra G, Boucek MM, Cavanaugh J, Graw SL, Ruegg P, Feiger J, Zhu X, Ferguson DA, Bristow MR, Gotzmann J, Foisner R, Mestroni L, Familial Cardiomyopathy Registry Research Group. Thymopoietin (lamina-associated polypeptide 2) gene mutation associated with dilated cardiomyopathy. *Hum Mutat.* 2005;26:566-74.
220. Hoffmann B, Schmidt-Traub H, Perrot A, Osterziel KJ, Gessner R. First mutation in cardiac troponin C, L29Q, in a patient with hypertrophic cardiomyopathy. *Hum Mutat.* 2001;17:524.
221. Landstrom AP, Parvatiyar MS, Pinto JR, Marquardt ML, Bos JM, Tester DJ, Ommen SR, Potter JD, Ackerman MJ. Molecular and functional characterization of novel hypertrophic cardiomyopathy susceptibility mutations in TNNC1-encoded troponin C. *J Mol Cell Cardiol.* 2008;45:281-8.
222. Mogensen J, Murphy RT, Shaw T, Bahl A, Redwood C, Watkins H, Burke M, Elliott PM, McKenna WJ. Severe disease expression of cardiac troponin C and T mutations in patients with idiopathic dilated cardiomyopathy. *J Am Coll Cardiol.* 2004;44:2033-40.
223. Van Spaendonck-Zwarts KY, van Tintelen JP, van Veldhuisen DJ, van der Werf R, Jongbloed JD, Paulus WJ, Dooijes D, van den Berg MP. Peripartum cardiomyopathy as a part of familial dilated cardiomyopathy. *Circulation.* 2010;121:2169-75.
224. Pinto JR, Siegfried JD, Parvatiyar MS, Li D, Norton N, Jones MA, Liang J, Potter JD, Hershberger RE. Functional characterization of TNNC1 rare variants identified in dilated cardiomyopathy. *J Biol Chem.* 2011;286:34404-12.
225. Kimura A, Harada H, Park JE, Nishi H, Satoh M, Takahashi M, Hiroi S, Sasaoka T, Ohbuchi N, Nakamura T, Koyanagi T, Hwang TH, Choo JA, Chung KS, Hasegawa A, Nagai R, Okazaki O, Nakamura H, Matsuzaki M, Sakamoto T, Toshima H, Koga Y, Imaizumi T, Sasazuki T. Mutations in the cardiac troponin I gene associated with hypertrophic cardiomyopathy. *Nat Genet.* 1997;16:379-82.
226. Mogensen J, Murphy RT, Kubo T, Bahl A, Moon JC, Klausen IC, Elliott PM, McKenna WJ. Frequency and clinical expression of cardiac troponin I mutations in 748 consecutive families with hypertrophic cardiomyopathy. *J Am Coll Cardiol.* 2004;44:2315-25.
227. Murphy RT, Mogensen J, Shaw A, Kubo T, Hughes S, McKenna WJ. Novel mutation in cardiac troponin I in recessive idiopathic dilated cardiomyopathy. *Lancet.* 2004;363:371-2.
228. Carballo S, Robinson P, Otway R, Fatkin D, Jongbloed JD, de Jonge N, Blair E, van Tintelen JP, Redwood C, Watkins H. Identification and functional characterization of cardiac troponin I as a novel disease gene in autosomal dominant dilated cardiomyopathy. *Circ Res.* 2009;105:375-82.

229. Kostareva A, Gudkova A, Sjoberg G, Morner S, Semernin E, Krutikov A, Shlyakhto E, Sejersen T. Deletion in TNNI3 gene is associated with restrictive cardiomyopathy. *Int J Cardiol.* 2009;131:410-2.
230. Mogensen J, Kubo T, Duque M, Uribe W, Shaw A, Murphy R, Gimeno JR, Elliott P, McKenna WJ. Idiopathic restrictive cardiomyopathy is part of the clinical expression of cardiac troponin I mutations. *J Clin Invest.* 2003;111:209-16.
231. Thierfelder L, Watkins H, MacRae C, Lamas R, McKenna W, Vosberg HP, Seidman JG, Seidman CE. Alpha-tropomyosin and cardiac troponin T mutations cause familial hypertrophic cardiomyopathy: a disease of the sarcomere. *Cell.* 1994;77:701-12.
232. Watkins H, McKenna WJ, Thierfelder L, Suk HJ, Anan R, O'Donoghue A, Spirito P, Matsumori A, Moravec CS, Seidman JG. Mutations in the genes for cardiac troponin T and alpha-tropomyosin in hypertrophic cardiomyopathy. *N Engl J Med.* 1995;332:1058-64.
233. Villard E, Duboscq-Bidot L, Charron P, Benaiche A, Conraads V, Sylvius N, Komajda M. Mutation screening in dilated cardiomyopathy: prominent role of the beta myosin heavy chain gene. *Eur Heart J.* 2005;26:794-803.
234. Peddy SB, Vricella LA, Crosson JE, Oswald GL, Cohn RD, Cameron DE, Valle D, Loeys BL. Infantile restrictive cardiomyopathy resulting from a mutation in the cardiac troponin T gene. *Pediatrics.* 2006;117:1830-3.
235. Olson TM, Kishimoto NY, Whitby FG, Michels VV. Mutations that alter the surface charge of alpha-tropomyosin are associated with dilated cardiomyopathy. *J Mol Cell Cardiol.* 2001;33:723-32.
236. Lakdawala NK, Dellefave L, Redwood CS, Sparks E, Cirino AL, Depalma S, Colan SD, Funke B, Zimmerman RS, Robinson P, Watkins H, Seidman CE, Seidman JG, McNally EM, Ho CY. Familial dilated cardiomyopathy caused by an alpha-tropomyosin mutation: the distinctive natural history of sarcomeric dilated cardiomyopathy. *J Am Coll Cardiol.* 2010;55:320-9.
237. Chang B, Nishizawa T, Furutani M, Fujiki A, Tani M, Kawaguchi M, Ibuki K, Hirono K, Taneichi H, Uese K, Onuma Y, Bowles NE, Ichida F, Inoue H, Matsuoka R, Miyawaki T, Noncompaction study collaborators. Identification of a novel TPM1 mutation in a family with left ventricular noncompaction and sudden death. *Mol Genet Metab.* 2011;102:200-6.
238. Itoh-Satoh M, Hayashi T, Nishi H, Koga Y, Arimura T, Koyanagi T, Takahashi M, Hohda S, Ueda K, Nouchi T, Hiroe M, Marumo F, Imaizumi T, Yasunami M, Kimura A. Titin mutations as the molecular basis for dilated cardiomyopathy. *Biochem Biophys Res Commun.* 2002;291:385-93.
239. Gerull B, Atherton J, Geupel A, Sasse-Klaassen S, Heuser A, Frenneaux M, McNabb M, Granzier H, Labeit S, Thierfelder L. Identification of a novel frameshift mutation in the giant muscle filament titin in a large Australian family with dilated cardiomyopathy. *J Mol Med (Berl).* 2006;84:478-83.
240. Carmignac V, Salih MA, Quijano-Roy S, Marchand S, Al Rayess MM, Mukhtar MM, Urtizberea JA, Labeit S, Guicheney P, Leturcq F, Gautel M, Fardeau M, Campbell KP, Richard I, Estournet B, Ferreiro A. C-terminal titin deletions cause a novel early-onset myopathy with fatal cardiomyopathy. *Ann Neurol.* 2007;61:340-51.
241. Sibbing D, Pfeufer A, Perisic T, Mannes AM, Fritz-Wolf K, Unwin S, Sinner MF, Gieger C, Gloeckner CJ, Wichmann HE, Kremmer E, Schafer Z, Walch A, Hinterseer M, Nabauer M, Kaab S, Kastrati A, Schomig A, Meitinger T, Bornkamm GW, Conrad M, von Beckerath N. Mutations in the mitochondrial thioredoxin reductase gene TXNRD2 cause dilated cardiomyopathy. *Eur Heart J.* 2011;32:1121-33.
242. Vasile VC, Ommen SR, Edwards WD, Ackerman MJ. A missense mutation in a ubiquitously expressed protein, vinculin, confers susceptibility to hypertrophic cardiomyopathy. *Biochem Biophys Res Commun.* 2006;345:998-1003.

243. Vasile VC, Will ML, Ommen SR, Edwards WD, Olson TM, Ackerman MJ. Identification of a metavinculin missense mutation, R975W, associated with both hypertrophic and dilated cardiomyopathy. *Mol Genet Metab.* 2006;87:169-74.
244. Olson TM, Illenberger S, Kishimoto NY, Huttelmaier S, Keating MT, Jockusch BM. Metavinculin mutations alter actin interaction in dilated cardiomyopathy. *Circulation.* 2002;105:431-7.

2

Haplotype sharing test maps genes for familial cardiomyopathies

Paul A. van der Zwaag
J. Peter van Tintelen
Frans Gerbens[†]
Jan D.H. Jongbloed
Ludolf G. Boven
Jasper J. van der Smagt
Wilma P. van der Roest
Irene M. van Langen
Hennie Bikker
Richard N.W. Hauer
Maarten P. van den Berg
Robert M.W. Hofstra
Gerard J. te Meerman

[†] *Deceased 15 May 2008*

We dedicated this paper to Frans Gerbens, who contributed greatly to this work. To our sorrow he passed away during the course of these investigations.

ABSTRACT

Identifying a mutation in a heterogeneous disease such as inherited cardiomyopathy is a challenge because classical methods, like linkage analysis, can often not be applied since there are too few meioses between affected individuals. However, if affected individuals share the same causal mutation, they will also share a genomic region surrounding it. High-density genotyping arrays are able to identify such regions shared among affected individuals. We hypothesise that the longest shared haplotype is most likely to contain the disease-causing mutation.

We applied this method to two pedigrees: one with arrhythmogenic right ventricular cardiomyopathy (ARVC) and one with dilated cardiomyopathy (DCM), using high-density genome-wide SNP arrays. In the ARVC pedigree, the largest haplotype was located on chromosome 12 and contained a causative *PKP2* mutation. In the DCM pedigree, a causative *MYH7* mutation was present on a large shared haplotype on chromosome 14. We calculated that a pedigree containing at least seven meioses has a high chance of correctly detecting the mutation-containing haplotype as the largest.

Our data show that haplotype-sharing analysis can assist in identifying causative genes in families with low penetrance Mendelian diseases, in which standard tools cannot be used due to lack of sufficient pedigree information.

INTRODUCTION

Identifying a mutation in a heterogeneous disease is a challenge with potentially important clinical consequences, because it may direct treatment and facilitate identification of family members at risk. Cardiomyopathies are a clear example of such a disease. These are associated with mechanical and/or electrical dysfunction that usually exhibit inappropriate ventricular hypertrophy or dilatation and are frequently genetic.¹ Around 30, 20 and 10 genes, respectively, have been described underlying dilated cardiomyopathy (DCM [MIM#115200]), hypertrophic cardiomyopathy (HCM [MIM#192600]), and arrhythmogenic right ventricular cardiomyopathy (ARVC [MIM#107970]).²⁻⁶ The importance of identifying a mutation is illustrated by the fact that sudden death is more common in HCM patients carrying a troponin T gene (*TNNT2*) mutation,^{7,8} and in DCM patients carrying a lamin A/C gene (*LMNA*) mutation.⁹⁻¹²

The detection of a mutation also has important implications for family members. Cascade screening will identify mutation carriers, and early interventions, such as lifestyle modifications, use of medications, and implanting an ICD, will reduce morbidity and mortality. Excluding a mutation in family members will allow them to be dismissed from regular cardiological follow-up.^{13,14} In cardiomyopathies identifying a mutation is challenging and time-consuming and the yield from screening is small for most genes.¹⁵

In low penetrance Mendelian diseases, founder mutations are likely to occur and these are co-inherited with adjacent chromosomal regions which are identical-by-descent (IBD). IBD genomic regions can be found by high-density genome-wide SNP arrays. However, many shared haplotypes will be found, some of which will be identical-by-state (IBS) while others may be IBD. Such IBS haplotypes are commonly present in the general population and not associated with disease. In general, short haplotypes are common and either represent ancient IBD stretches of DNA, or are IBS. Larger shared haplotypes are younger and have a high probability of being IBD. Haplotypes with 15 or more polymorphic markers covering about 100,000 base pairs already have a substantial probability of being IBD.¹⁶ Mutant genes tend to have a common ancestor from a geographic subpopulation and will show extended haplotype sharing surrounding the mutant gene. It is this expected difference in length between IBS and IBD haplotypes that we use to identify disease loci.

To identify disease-associated haplotypes, we designed the haplotype-sharing test (HST), using high-density SNP array data. As a proof-of-principle, we applied the HST to two pedigrees: one consisting of four putative, remotely related families with autosomal dominant (AD) ARVC (Figure 1A), and one with AD DCM (Figure 1B).

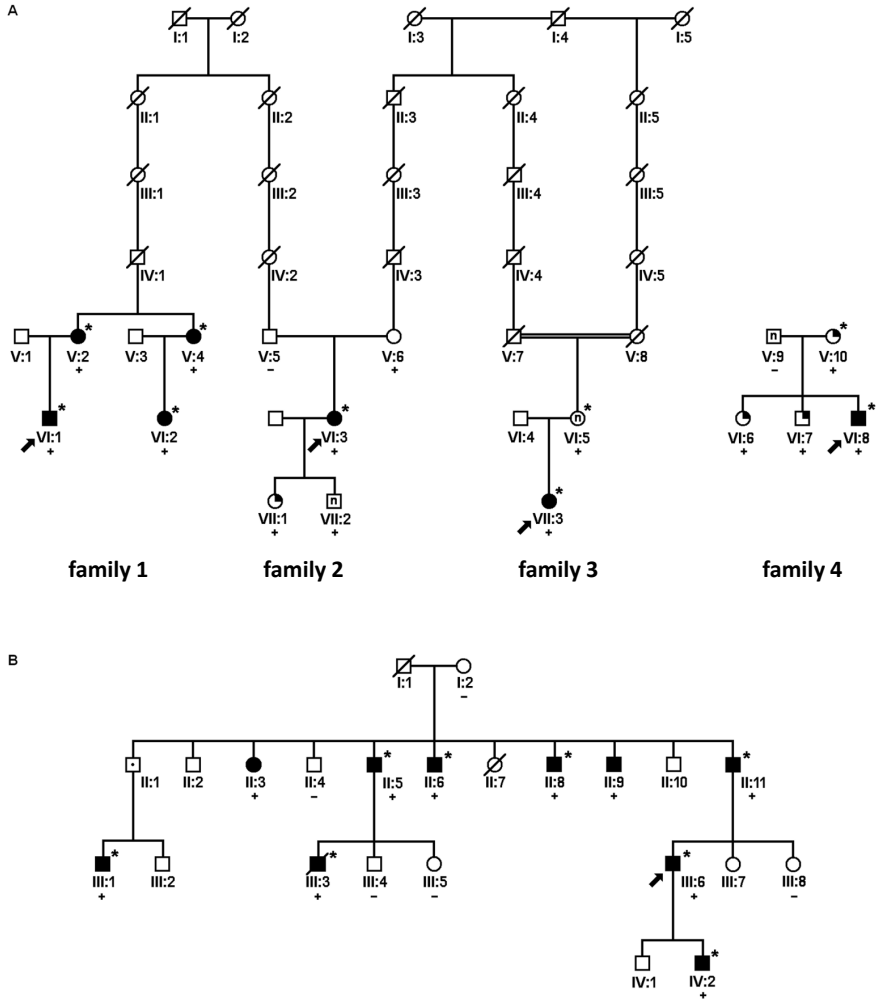

Figure 1 Pedigrees of the families with autosomal dominantly inherited ARVC (A) and of the family with autosomal dominantly inherited DCM (B). Circles indicate females; squares indicate males; a line through a symbol means deceased. Black symbols represent affected persons; dotted symbols represent obligate carriers, who cannot be labeled as affected because the individual has not been tested or the clinical signs are insufficient to fulfill the formal clinical criteria; upper quadrant blackened symbols denote individuals who did not fulfill the clinical criteria, but who did have abnormalities compatible with ARVC; individuals denoted with "n" had a normal cardiac evaluation.

* Genotype used for HST; +/- indicates the presence or absence of the *PKP2* c.2489+4A>C or *MYH7* p.Arg904Cys mutation, respectively.

MATERIALS AND METHODS

Clinical evaluation

Four small families with AD ARVC were investigated (Figure 1A). Three families could be traced back to two ancestral founder couples. Family 4 could not be linked to the pedigree, but their ancestors lived in the same geographical region, suggesting a possible founder mutation. DNA and clinical information was available for 16 individuals. From a four-generation family with AD DCM (Figure 1B) DNA and clinical information was available for 19 family members.

The studies were approved by the ethics committees of the UMC Utrecht and UMC Groningen and informed consent was obtained from all participants.

Genotype data

In the ARVC pedigree, genome-wide genotyping with the GeneChip® Mapping 10K SNP array (Xba131; Affymetrix, Santa Clara, CA, USA) was performed according to manufacturer's protocols. Data from the arrays were converted to genotypes using GeneChip® DNA analysis software 2.0 (Affymetrix).

In the DCM pedigree, genome-wide genotyping with the Human 610-Quad BeadChip® 610K SNP array (Illumina, San Diego, CA, USA) was performed according to manufacturer's protocols. Data from the arrays were converted to genotypes using GenomeStudio® data analysis software (Illumina).

Haplotype-sharing analysis

Using Microsoft® Office Excel 2007 (Microsoft, Redmond, WA, USA) software, the HST was developed to search for shared haplotypes. An algorithm checks for consistency of genotypes with shared risk haplotypes, using data from affected individuals and obligate carriers only. The algorithm starts at the p-telomere of a chromosome and compares all the genotypes of the first SNP. When all affected individuals share an allele for the SNP, the comparison continues with the next SNP. A run is terminated when a real inconsistency (i.e. opposite homozygosity) in a SNP occurs. After a run terminates, the algorithm computes the total number of SNPs and the length of the haplotype in Mb and cM, based on the deCODE genetic map.¹⁷ A new run starts with the following SNP. The algorithm scans all the SNPs on each chromosome and computes the lengths of all the shared haplotypes

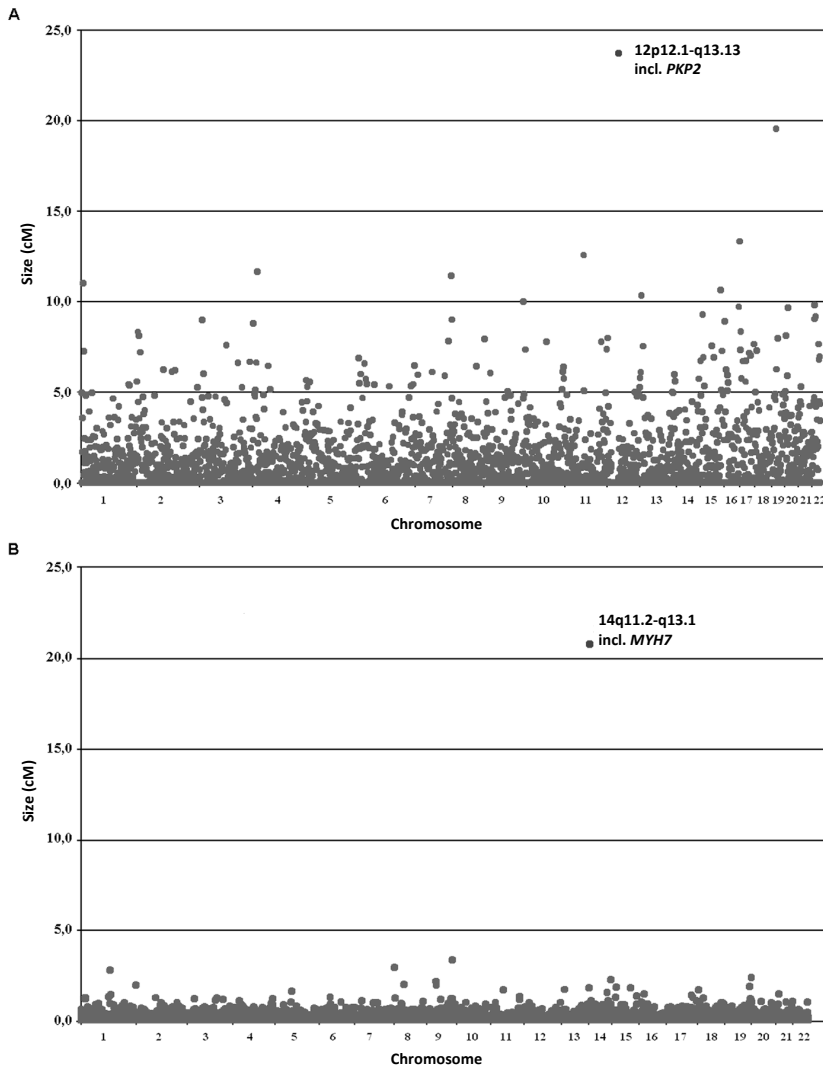

Figure 2 Haplotype length distribution across the genome. (A) After haplotype sharing analysis using a 10K SNP array in ARVC families 1-4. The largest region of 24.1 cM or 93 SNPs, flanked on either side by the SNP markers rs724903 and rs408435, pointed to chromosome 12p12.1-q13.13, where *PKP2* is localised. (B) After haplotype sharing analysis using a 610K SNP array in the DCM pedigree. The largest region of 20.8 cM or 2,707 SNPs, flanked on either side by the SNP markers rs11621148 and rs17101350, pointed to chromosome 14q11.2-q13.1, where *MYH7* is localised.

RESULTS

Haplotype sharing

In all four families of the ARVC pedigree, the HST revealed a largest haplotype run of 93 SNPs on chromosome 12, spanning 24.1 cM (Figure 2A and Table 1). This haplotype run was substantially larger than other areas which were most likely shared due to hidden distant ancestry or IBS (average shared haplotype length: 4.0 SNPs and 2.1 cM).

In the DCM pedigree, the HST revealed a largest haplotype run of 2,707 SNPs on chromosome 14, spanning 20.8 cM (Figure 2B). This haplotype run was also substantially larger than other areas (average shared haplotype length: 8.1 SNPs and 0.06 cM).

Gene finding

We looked for known disease-associated genes in the largest haplotypes. In the ARVC pedigree, the largest shared haplotype stretched over a 24.1 cM region (28.0 Mb), containing over 200 genes. Considering ARVC, the most likely candidate gene was the plakophilin 2 (*PKP2* [MIM#602861]) gene. This gene was identified as a highly prevalent ARVC-associated gene during the course of this study.^{18,19}

The largest shared haplotype in the DCM pedigree stretched over a 20.8 cM region (11.5 Mb), also containing over 200 genes. Considering DCM, the most likely candidate gene in this region was the cardiac beta myosin heavy chain (*MYH7* [MIM#160760]) gene.²⁰ *MYH7* (missense) mutations are found in 4-10% of patients with idiopathic DCM.²⁰⁻²⁵

Mutation identification

PKP2 mutation screening in patients from the ARVC pedigree revealed a pathogenic splice-site mutation c.2489+4A>C,²⁶ segregating with the disease. This mutation was identified as clinically relevant by reverse-transcription PCR (RT-PCR) in lymphocytes showing the absence of exon 12 in the *PKP2* transcript sequence in all affected subjects (data not shown). The absence of exon 12 leads to a frameshift in the coding sequence, resulting in an aberrant protein of 848 amino acids opposed to 863 amino acids for wild type *PKP2* isoform 2b.

MYH7 mutation screening in the proband from the DCM pedigree revealed a c.2710C>T missense mutation which changes a highly conserved hydrophilic and polar arginine residue into a hydrophobic and nonpolar cysteine residue in the corresponding *MYH7* protein (p.Arg904Cys). All available affected family members also carried this mutation, whereas unaffected family members did not.

Both mutations were absent in over 150 ethnically matched controls (300 alleles).

Table 1 The largest shared haplotype across some affected individuals from the ARVC pedigree (in grey)

SNPID	Position		Family 1				Family 2		Family 3		Family 3	
			VI:1		VI:2		VI:3		VII:3		VI:8	
			hap1	hap2	hap1	hap2	hap1	hap2	hap1	hap2	hap1	hap2
	Mb	cM										
rs724903	23.2	42.8	A	B	A	B	B	B	B	B	B	A
rs763853	23.2	42.8	A	A	A	A	A	A	A	A	A	A
#15 SNPs												
rs951821	28.7	51.3	A	A	B	A	A	A	A	A	A	A
rs1601981	29.0	51.5	A	B	B	B	A	B	A	B	A	B
rs986570	29.2	51.7	B	A	B	A	A	A	A	A	A	A
rs986569	29.2	51.7	B	A	B	A	A	A	A	A	A	A
rs958478	29.2	51.8	B	B	B	B	B	B	B	B	B	B
rs3862404	30.3	53.3	A	B	B	B	B	B	B	B	B	B
rs1429630	30.3	53.4	B	B	B	B	B	B	B	B	A	B
rs1320925	30.3	53.4	B	B	B	B	B	B	B	B	B	B
rs2114903	30.8	53.9	B	A	B	A	B	A	A	A	B	A
rs720480	31.0	54.0	B	A	B	A	A	A	B	A	A	A
rs724417	31.2	54.3	B	A	B	A	B	A	B	A	B	A
rs1844986	31.3	54.4	A	A	B	A	A	A	B	A	B	A
c.2489+4A>C	32.8	55.4	A	C	A	C	A	C	A	C	A	C
rs2133675	33.1	55.5	A	A	A	A	A	A	A	A	A	A
rs955648	33.1	55.5	A	B	A	B	A	B	A	B	A	B
rs1392339	33.1	55.5	A	B	A	B	A	B	A	B	A	B
rs1457677	33.3	55.6	B	A	B	A	B	A	B	A	B	A
rs2389173	33.3	55.6	B	B	B	B	B	B	B	B	B	B
rs1386934	33.7	55.6	A	B	B	B	B	A	A	B	B	B
rs1386937	33.8	55.7	B	A	A	A	B	A	B	A	A	A
rs1525895	33.9	55.7	A	B	B	B	A	B	A	B	A	B
rs8186671	36.5	56.1	B	B	B	B	B	B	B	B	B	B
rs8186802	36.5	56.1	A	A	A	A	A	A	A	A	A	A
rs4088478	36.5	56.1	A	A	A	A	A	A	A	A	A	A
rs8186742	36.5	56.1	A	A	A	A	A	A	A	A	A	A
#50 SNPs												
rs1316607	49.3	64.0	A	B	A	B	B	B	A	B	B	B
rs1902765	50.9	66.6	A	B	A	B	A	B	B	B	B	B
rs1791661	51.1	66.7	A	A	A	A	A	A	B	A	B	A
rs408435	51.2	66.9	A	B	A	B	B	B	A	B	B	A

The phase of heterozygous SNPs is inferred from the parental haplotypes (not listed), resulting in termination of the run after 93 SNPs (see VI:8). The identified mutation c.2489+4A>C is present on the shared haplotype.

Step-by-step analysis

Table 2 and Table 3 show the results of step-by-step haplotype-sharing analysis in both pedigrees. An analysis of only five individuals in each pedigree indicated the mutation-containing haplotype was indeed the largest. Additional individuals narrowed down the size of the shared haplotype, thereby decreasing the total number of genes to be considered. In the DCM pedigree, we predicted the size of the unrecombined area surrounding the mutation by using the formula: 200 cM / number of meioses.²⁷ The size of the haplotypes was comparable to the expected size.

Table 2 Step-by-step haplotype analysis of the ARVC pedigree^a

	IDs	Average haplotype		Largest haplotype		Rank PKP2 haplotype
		SNPs	cM	SNPs	cM	
Family 1	V:2/V:4/VI:1/VI:2	13.6	5.3	349	82.0	3
+ Family 2	+VI:3	7.3	3.1	217	52.9	1
+ Family 3	+VI:5/VII:3	4.9	2.3	120	31.6	1
+ Family 4	+V:10/VI:8	4.0	2.1	93	24.1	1

Family 1 was analysed first, with subsequent analysis of families 2–4

^a Including haplotypes >1 SNP, ranked according to their length in cM.

Table 3 Step-by-step haplotype analysis of the DCM pedigree^a

	IDs	Average haplotype		Largest haplotype		Calculated haplotype size ^b		Rank MYH7 haplotype
		SNPs	cM	SNPs	cM	meioses	cM	
Generation II	II:5/II:6/II:8/II:11	32.3	0.21	11129	78.4	4	50.0	9
+ offspring II:1	+III:1	17.5	0.12	3589 ^c	27.0	6	33.3	1
+ offspring II:5	+III:3	12.5	0.09	3089	27.0	7	28.6	1
+ offspring II:11	+III:6/IV:2	8.1	0.06	2707	20.8	9	22.2	1

Four members of generation II were analysed first, with subsequent analysis of their offspring

^a Including haplotypes >1 SNP, ranked according to their length in cM.

^b Based on the formula: 200 cM / number of meioses = size unrecombined area surrounding a mutation.²⁷

^c This haplotype is 16.5 cM

Requirement for HST

To establish the minimal number of affecteds within a pedigree to successfully apply the HST, we calculated all possible combinations of different numbers of meioses in the DCM pedigree. The results are shown in Table 4, illustrating that 5 or 6 meioses revealed the *MYH7* haplotype as the largest in 4/19 (21%) or 9/15 (60%) combinations, respectively. With 7 meioses, the *MYH7* haplotype is the largest in 8/9 (89%) combinations.

Table 4 Requirement for HST

	Rank <i>MYH7</i> haplotype	Largest haplotype cM		Rank <i>MYH7</i> haplotype	Largest haplotype cM
5 meioses:			6 meioses:		
II:5/II:6/II:8 + III:1	1	27.0	II:5/II:6/II:8 + IV:2	1	20.8
II:11 + III:1/III:3	1	35.1	II:5 + III:1 + IV:2	1	20.8
II:8 + III:1/III:6	1	47.4	II:6 + III:3 + IV:2	1	21.3
II:6/II:8 + IV:2	1	68.1	II:5/II:6/II:8/II:11 + III:1	1	27.0
III:3 + IV:2	2	31.6	II:6/II:8 + III:1/III:3	1	27.5
II:8 + III:1/III:3	2	37.5	II:8/II:11 + III:1/III:3	1	27.5
II:6/II:8/II:11 + III:1	2	46.0	II:6/II:11 + III:1/III:3	1	35.1
II:5/II:6 + IV:2	2	47.0	II:8 + III:1 + IV:2	1	47.0
II:6 + III:1/III:6	2	59.0	II:6/II:8 + III:1/III:6	1	47.4
III:1 + IV:2	2	74.1	II:8 + III:3 + IV:2	2	21.3
II:6 + III:1/III:3	2	82.4	III:1/III:3/III:6	2	21.8
II:5/II:6/II:11 + III:1	3	44.7	II:6 + III:1 + IV:2	2	52.1
II:6 + III:3/III:6	4	39.9	II:5/II:8 + III:1/III:6	3	21.2
II:5/II:8 + IV:2	4	40.8	II:6/II:8 + III:3/III:6	3	21.7
II:5/II:8/II:11 + III:1	4	43.3	II:5/II:6 + III:1/III:6	4	21.2
II:8 + III:3/III:6	5	47.7	Ranked 1st; Average size	9/15	28.9
II:6/II:8/II:11 + III:3	5	56.7	7 meioses:		
II:5/II:6/II:8 + III:6	7	37.7	II:5/II:6 + III:1 + IV:2	1	20.8
II:5 + III:1/III:6	7	47.0	II:5/II:8 + III:1 + IV:2	1	20.8
Ranked 1st; Average size	4/19	48.1	II:6/II:8 + III:3 + IV:2	1	21.3
			III:1/III:3 + IV:2	1	21.3
			II:6 + III:1/III:3/III:6	1	21.7
			II:8 + III:1/III:3/III:6	1	21.7
			II:6/II:8/II:11 + III:1/III:3	1	27.0
			II:6/II:8 + III:1 + IV:2	1	47.0
			II:5/II:6/II:8 + III:1/III:6	2	24.9
			Ranked 1st; Average size	8/9	25.2

Results of the HST for all possible combinations of different numbers of meioses in the DCM pedigree.

DISCUSSION

Rare Mendelian disorders have a mutational spectrum which is characterised by the presence of very few major mutations but a large number of very rare mutations. It is therefore reasonable to search for the presence of common mutant genes in patients with the same disease phenotype. It has been shown that haplotypes identical over 0.1 cM have a substantial probability of originating from a common founder.¹⁶ Such haplotypes can easily be detected with current high-density genotyping methods.

If two individuals have a common ancestor, they may share a haplotype that has been shortened by recombination but that is still of detectable size. The current density of whole genome screens is so high that shared haplotypes of a few hundred thousand base pairs will contain well over 30 SNPs. If rare Mendelian disorders are investigated, a common disease mutation may coalesce to a common ancestor well within 100 generations. Of course, for many genomic areas a random coalescence to recent ancestors may occur as well. Due to adverse selection, most descent lines with deleterious mutations will gradually be eliminated leading to shorter coalescence times to a common ancestor. The expectation is therefore that shared areas surrounding disease mutations will be larger in size than shared areas due to a common ancestor for a neutral genomic area. This leads to a heuristic principle: first investigate the largest areas shared between patients or obligate carriers for mutant genes. The carrier frequency of such areas in the population must be fairly low, making the association between a rare variant and a rare marker haplotype more likely under the hypothesis that the shared region harbors a mutant gene that has led to ascertainment of the individuals who carry them. Occasionally, however, recombinations will take place near the mutant position and the corresponding shared haplotype may become small. Fortunately the total size of shared haplotypes that could contain a mutant gene is often not so large, and may even be as small as the mapping interval used for linkage analysis with a sufficient number of meioses.

The results of our analyses confirm our hypothesis. Figure 2 shows the shared haplotypes identified in the pedigrees that were analysed using a 10K and a 610K SNP array. We identified many short IBS or perhaps IBD haplotypes with an average length of 4.0 SNPs (2.1 cM) and 8.1 SNPs (0.06 cM), respectively, and in both pedigrees we found one larger haplotype, of 24.1 cM (93 SNPs) and 20.8 cM (2707 SNPs), respectively. A common gene underlying ARVC, namely *PKP2*, was present in the largest haplotype of the ARVC pedigree. Screening of the *PKP2* gene revealed a pathogenic splice-site mutation.²⁶

In the DCM pedigree, the largest haplotype encompassed *MYH7*, a common gene underlying DCM. Screening revealed a missense mutation of a highly con-

served residue (p.Arg904Cys), with large physicochemical differences between the amino acids and which was shown to segregate with the disease in the pedigree. Furthermore, missense mutations in the surrounding residues 901, 905, 906, and 908 have been identified previously in HCM.²⁸⁻³¹

Based on the formula $200 \text{ cM} / \text{number of meioses}$, we expected the mutation-containing haplotype to be around 22.2 cM, which corresponds well with the observed haplotype of 20.8 cM. When performing classic linkage in this pedigree, the maximal LOD score could not exceed 2.4 ($(\text{no. of meioses}-1) \cdot \log 2$), illustrating that haplotype-sharing analysis can be a valuable tool in pedigrees too small for linkage analysis.

Our results show that haplotype-sharing analysis is a useful tool for narrowing down the area in which to search for a mutated gene. This might be particularly useful in genetically heterogeneous disorders. Moreover, we prove that the theoretical model proposed by Miyazawa et al. to use homozygosity mapping through haplotype analysis to identify shared segments, is indeed effective.³² More recently, others have described statistics-based methods that calculate the size of shared haplotypes to map genes in genotyped pedigrees.³³⁻³⁵ The advantage of these methods is that they extend the principle of homozygosity mapping for recessive inherited diseases to cases of AD diseases.

The results of the HST for different numbers of meioses in the DCM pedigree, suggest that 7 meioses have a high chance of correctly detecting the mutation-containing haplotype (Table 4). Using fewer meioses is however possible, but the risk of detecting a false-positive largest haplotype (i.e. not containing the mutated gene) is substantial. We therefore recommend to apply the HST in pedigrees with at least 7 meioses.

Identifying a large shared haplotype is relatively easy, since current molecular biology tools, such as SNP genotyping technology, easily yield hundreds of thousands of reliable genotypes. Subsequent mutational analysis can be done by sequencing, and current technology is powerful enough to investigate a few candidate regions and confirm the results, thereby contributing significantly to the clinical diagnosis of heritable diseases.

We found genes known to be associated with ARVC and DCM in the largest haplotypes of the studied pedigrees. Mutations in these genes could have been identified by a candidate gene approach, because mutations in *PKP2* and *MYH7* are frequently identified in these diseases.¹⁸⁻²⁵ When a candidate gene approach fails to identify a mutation, a novel disease gene could be identified by screening the largest haplotype. With the decline of costs for SNP arrays, the HST could prove to be more cost-effective than the screening of selected candidate genes.

We recommend haplotype-sharing analysis as a tool to assist in identifying genes in those low penetrance Mendelian diseases in which standard tools cannot be used due to lack of substantial pedigree information, or in which the mutation rate is low enough to expect founder mutations to be shared among patients. Identifying the largest shared haplotype can be used as a pre-screening method to identify candidate genes.

Acknowledgements

We thank Eric Hennekam for the genealogical investigations, and Jackie Senior for editing this manuscript. We are also indebted to Arthur Wilde, cardiologist, who performed the cardiological investigations in ARVC family 4 and to Chantal Conrath, who helped collect data from the families. Funding: Netherlands Heart Foundation (2003B062 and 2007B132).

REFERENCES

1. Maron BJ, Towbin JA, Thiene G, Antzelevitch C, Corrado D, Arnett D, Moss AJ, Seidman CE, Young JB. Contemporary definitions and classification of the cardiomyopathies: an American Heart Association Scientific Statement from the Council on Clinical Cardiology, Heart Failure and Transplantation Committee; Quality of Care and Outcomes Research and Functional Genomics and Translational Biology Interdisciplinary Working Groups; and Council on Epidemiology and Prevention. *Circulation*. 2006;113:1807-16.
2. Schonberger J and Seidman CE. Many roads lead to a broken heart: the genetics of dilated cardiomyopathy. *Am J Hum Genet*. 2001;69:249-60.
3. Taylor MR, Carniel E, Mestroni L. Cardiomyopathy, familial dilated. *Orphanet J Rare Dis*. 2006;1:27.
4. Taylor MR, Carniel E, Mestroni L. Familial hypertrophic cardiomyopathy: clinical features, molecular genetics and molecular genetic testing. *Expert Rev Mol Diagn*. 2004;4:99-113.
5. Morita H, Seidman J, Seidman CE. Genetic causes of human heart failure. *J Clin Invest*. 2005;115:518-26.
6. Awad MM, Calkins H, Judge DP. Mechanisms of disease: molecular genetics of arrhythmogenic right ventricular dysplasia/cardiomyopathy. *Nat Clin Pract Cardiovasc Med*. 2008;5:258-67.
7. Watkins H, McKenna WJ, Thierfelder L, Suk HJ, Anan R, O'Donoghue A, Spirito P, Matsumori A, Moravec CS, Seidman JG. Mutations in the genes for cardiac troponin T and alpha-tropomyosin in hypertrophic cardiomyopathy. *N Engl J Med*. 1995;332:1058-64.
8. Moolman JC, Corfield VA, Posen B, Ngumbela K, Seidman C, Brink PA, Watkins H. Sudden death due to troponin T mutations. *J Am Coll Cardiol*. 1997;29:549-55.
9. Fatkin D, MacRae C, Sasaki T, Wolff MR, Porcu M, Frenneaux M, Atherton J, Vidaillet HJ, Jr., Spudich S, De Girolami U, Seidman JG, Seidman C, Muntoni F, Muehle G, Johnson W, McDonough B. Missense mutations in the rod domain of the lamin A/C gene as causes of dilated cardiomyopathy and conduction-system disease. *N Engl J Med*. 1999;341:1715-24.
10. Van Berlo JH, de Voogt WG, van der Kooij AJ, van Tintelen JP, Bonne G, Yaou RB, Duboc D, Rossenbacker T, Heidebuchel H, de Visser M, Crijns HJ, Pinto YM. Meta-analysis of clinical characteristics of 299 carriers of LMNA gene mutations: do lamin A/C mutations portend a high risk of sudden death? *J Mol Med*. 2005;83:79-83.
11. Perrot A, Sigusch HH, Nagele H, Genschel J, Lehmkuhl H, Hetzer R, Geier C, Leon Perez V, Reinhard D, Dietz R, Josef Osterziel K, Schmidt HH. Genetic and phenotypic analysis of dilated cardiomyopathy with conduction system disease: demand for strategies in the management of presymptomatic lamin A/C mutant carriers. *Eur J Heart Fail*. 2006;8:484-93.
12. Pasotti M, Klersy C, Pilotto A, Marziliano N, Rapezzi C, Serio A, Mannarino S, Gambarin F, Favalli V, Grasso M, Agozzino M, Campana C, Gavazzi A, Febo O, Marini M, Landolina M, Mortara A, Piccolo G, Viganò M, Tavazzi L, Arbustini E. Long-term outcome and risk stratification in dilated cardiomyopathies. *J Am Coll Cardiol*. 2008;52:1250-60.
13. Hanson EL and Hershberger RE. Genetic counseling and screening issues in familial dilated cardiomyopathy. *J Genet Counseling*. 2001;10:397-415.
14. Van Tintelen JP, Hofstra RM, Wiesfeld AC, van den Berg MP, Hauer RN, Jongbloed JD. Molecular genetics of arrhythmogenic right ventricular cardiomyopathy: emerging horizon? *Curr Opin Cardiol*. 2007;22:185-92.
15. Hershberger RE, Lindenfeld J, Mestroni L, Seidman CE, Taylor MR, Towbin JA. Genetic evaluation of cardiomyopathy - a Heart Failure Society of America practice guideline. *J Card Fail*. 2009;15:83-97.

16. Nolte IM and Te Meerman GJ. The probability that similar haplotypes are identical by descent. *Ann Hum Genet.* 2002;66:195-209.
17. Kong A, Gudbjartsson DF, Sainz J, Jonsson GM, Gudjonsson SA, Richardsson B, Sigurdardottir S, Barnard J, Hallbeck B, Masson G, Shlien A, Palsson ST, Frigge ML, Thorgeirsson TE, Gulcher JR, Stefansson K. A high-resolution recombination map of the human genome. *Nat Genet.* 2002;31:241-7.
18. Gerull B, Heuser A, Wichter T, Paul M, Basson CT, McDermott DA, Lerman BB, Markowitz SM, Ellinor PT, MacRae CA, Peters S, Grossmann KS, Drenckhahn J, Michely B, Sasse-Klaassen S, Birchmeier W, Dietz R, Breithardt G, Schulze-Bahr E, Thierfelder L. Mutations in the desmosomal protein plakophilin-2 are common in arrhythmogenic right ventricular cardiomyopathy. *Nat Genet.* 2004;36:1162-4.
19. Van Tintelen JP, Entius MM, Bhuiyan ZA, Jongbloed R, Wiesfeld AC, Wilde AA, van der Smagt J, Boven LG, Mannens MM, van Langen IM, Hofstra RM, Otterspoor LC, Doevendans PA, Rodriguez LM, van Gelder IC, Hauer RN. Plakophilin-2 mutations are the major determinant of familial arrhythmogenic right ventricular dysplasia/cardiomyopathy. *Circulation.* 2006;113:1650-8.
20. Kamisago M, Sharma SD, DePalma SR, Solomon S, Sharma P, McDonough B, Smoot L, Mullen MP, Woolf PK, Wigle ED, Seidman JG, Seidman CE. Mutations in sarcomere protein genes as a cause of dilated cardiomyopathy. *N Engl J Med.* 2000;343:1688-96.
21. Daehmlow S, Erdmann J, Knueppel T, Gille C, Froemmel C, Hummel M, Hetzer R, Regitz-Zagrosek V. Novel mutations in sarcomeric protein genes in dilated cardiomyopathy. *Biochem Biophys Res Commun.* 2002;298:116-20.
22. Karkkainen S, Helio T, Jaaskelainen P, Miettinen R, Tuomainen P, Ylitalo K, Kaartinen M, Reissell E, Toivonen L, Nieminen MS, Kuusisto J, Laakso M, Peuhkurinen K. Two novel mutations in the beta-myosin heavy chain gene associated with dilated cardiomyopathy. *Eur J Heart Fail.* 2004;6:861-8.
23. Villard E, Duboscq-Bidot L, Charron P, Benaiche A, Conraads V, Sylvius N, Komajda M. Mutation screening in dilated cardiomyopathy: prominent role of the beta myosin heavy chain gene. *Eur Heart J.* 2005;26:794-803.
24. Hershberger RE, Parks SB, Kushner JD, Li D, Ludwigsen S, Jakobs P, Nauman D, Burgess D, Partain J, Litt M. Coding sequence mutations identified in MYH7, TNNT2, SCN5A, CSR3, LBD3, and TCAP from 313 patients with familial or idiopathic dilated cardiomyopathy. *Clin Transl Sci.* 2008;1:21-6.
25. Moller DV, Andersen PS, Hedley P, Ersboll MK, Bundgaard H, Moolman-Smook J, Christiansen M, Kober L. The role of sarcomere gene mutations in patients with idiopathic dilated cardiomyopathy. *Eur J Hum Genet.* 2009;17:1241-9.
26. Bhuiyan ZA, Jongbloed JD, van der Smagt J, Lombardi PM, Wiesfeld AC, Nelen M, Schouten M, Jongbloed R, Cox MG, van Wolferen M, Rodriguez LM, van Gelder IC, Bikker H, Suurmeijer AJ, van den Berg MP, Mannens MM, Hauer RN, Wilde AA, van Tintelen JP. Desmoglein-2 and desmocollin-2 mutations in Dutch arrhythmogenic right ventricular dysplasia/cardiomyopathy patients: Results from a multicenter study. *Circ Cardiovasc Genet.* 2009;2:418-27.
27. Te Meerman GJ, Van der Meulen MA, Sandkuijl LA. Perspectives of identity by descent (IBD) mapping in founder populations. *Clin Exp Allergy.* 1995;25 Supplement 2:97-102.
28. Epstein ND, Cohn GM, Cyran F, Fananapazir L. Differences in clinical expression of hypertrophic cardiomyopathy associated with two distinct mutations in the beta-myosin heavy chain gene. A 908Leu->Val mutation and a 403Arg->Gln mutation. *Circulation.* 1992;86:345-52.
29. Erdmann J, Daehmlow S, Wischke S, Senyuva M, Werner U, Raible J, Tanis N, Dyachenko S, Hummel M, Hetzer R, Regitz-Zagrosek V. Mutation spectrum in a large cohort of unrelated consecutive patients with hypertrophic cardiomyopathy. *Clin Genet.* 2003;64:339-49.

30. Perrot A, Schmidt-Traub H, Hoffmann B, Prager M, Bit-Avragim N, Rudenko RI, Usupbaeva DA, Kabaeva Z, Imanov B, Mirrakhimov MM, Dietz R, Wycisk A, Tendera M, Gessner R, Osterziel KJ. Prevalence of cardiac beta-myosin heavy chain gene mutations in patients with hypertrophic cardiomyopathy. *J Mol Med*. 2005;83:468-77.
31. Arad M, Penas-Lado M, Monserrat L, Maron BJ, Sherrid M, Ho CY, Barr S, Karim A, Olson TM, Kamisago M, Seidman JG, Seidman CE. Gene mutations in apical hypertrophic cardiomyopathy. *Circulation*. 2005;112:2805-11.
32. Miyazawa H, Kato M, Awata T, Kohda M, Iwasa H, Koyama N, Tanaka T, Huqun, Kyo S, Okazaki Y, Hagiwara K. Homozygosity haplotype allows a genomewide search for the autosomal segments shared among patients. *Am J Hum Genet*. 2007;80:1090-102.
33. Kong A, Masson G, Frigge ML, Gylfason A, Zusmanovich P, Thorleifsson G, Olason PI, Ingason A, Steinberg S, Rafnar T, Sulem P, Mouy M, Jonsson F, Thorsteinsdottir U, Gudbjartsson DF, Stefansson H, Stefansson K. Detection of sharing by descent, long-range phasing and haplotype imputation. *Nat Genet*. 2008;40:1068-75.
34. Leibon G, Rockmore DN, Pollak MR. A SNP streak model for the identification of genetic regions identical-by-descent. *Stat Appl Genet Mol Biol*. 2008;7:Article16.
35. Thomas A, Camp NJ, Farnham JM, Allen-Brady K, Cannon-Albright LA. Shared genomic segment analysis. Mapping disease predisposition genes in extended pedigrees using SNP genotype assays. *Ann Hum Genet*. 2008;72:279-87.

3

Clinical and genetic characterisation of patients with arrhythmogenic right ventricular dysplasia/cardiomyopathy caused by a plakophilin 2 splice mutation

Jasper J. van der Smagt*

Paul A. van der Zwaag*

J. Peter van Tintelen

Moniek G.P.J. Cox

Arthur A.M. Wilde

Irene M. van Langen

Amber Ummels

F.A.M. Hennekam

Dennis Dooijes

Frans Gerbens †

Hennie Bikker

Richard N.W. Hauer

Pieter A. Doevendans

** These authors contributed equally to this work*

† Deceased 15 May 2008

Cardiology. In press.

ABSTRACT

Objectives Arrhythmogenic right ventricular dysplasia/cardiomyopathy (ARVD/C) is characterised by fibrofatty replacement of cardiomyocytes. In around 50% of index-patients, a genetic predisposition is demonstrated. The purpose of this study was to examine a plakophilin 2 (*PKP2*) splice site mutation, c.2489+4A>C, identified in four separately ascertained Dutch ARVD/C families.

Methods Genealogical studies and comprehensive screening of five desmosomal genes were undertaken. Reverse transcriptase PCR (RT-PCR) and subsequent sequencing was performed.

Results An A to C change (c.2489+4A>C) near the splice-donor site of intervening sequence 12 of *PKP2* was found in all four families. Based on pedigree data and haplotype sharing, a common ancestor should be situated more than seven generations ago. RT-PCR demonstrated the presence of aberrant messenger RNA. Clinical manifestations ranged from severe disease to non-penetrance in elderly mutation carriers.

Conclusions This founder mutation in *PKP2* is predicted to lead to the presence of a dysfunctional *PKP2* protein, whereas most truncating mutations are expected to lead to loss of protein. Mutation carriers displayed a wide range in disease severity, suggesting that *PKP2* mutations alone are not sufficient to cause disease, which results in the variable expression and incomplete penetrance characteristic of ARVD/C mutations.

INTRODUCTION

Arrhythmogenic right ventricular dysplasia/cardiomyopathy (ARVD/C) is a disorder characterised by progressive replacement of cardiomyocytes by fibrofatty tissue, primarily in the right ventricle. Life-threatening ventricular arrhythmias originating from the right ventricle can be an early manifestation of the disease. Clinical diagnosis depends on fulfillment of Task Force Criteria,¹ for which modifications have recently been proposed.²

An important genetic contribution is evident from the fact that in 30-50% of cases one or more first-degree relatives also display signs of the disease.^{3,4} A large majority of mutations in ARVD/C patients has been found in genes encoding different components of the cardiac desmosome, i.e. plakophilin 2 (*PKP2*), desmocollin 2 (*DSC2*), desmoglein 2 (*DSG2*), desmoplakin (*DSP*), and plakoglobin (*JUP*),⁵⁻¹² suggesting that ARVD/C is primarily a disease of disturbed desmosomal function.^{13,14} Mutations in other genes have also been reported in ARVD/C, among others transmembrane protein 43 (*TMEM43*), desmin (*DES*), and titin (*TTN*),¹⁵⁻¹⁸ indicating genetic heterogeneity. In addition, several ARVD/C cases were found to be caused by multiple mutations in the same gene (compound heterozygosity) or mutations in different genes (digenic inheritance), which could result in an earlier onset and increased disease severity.¹⁹⁻²¹ The precise mechanisms by which mutations in these genes lead to the distinct ARVD/C phenotype remain, to a large extent, to be elucidated. Decreased desmosome numbers, structurally abnormal desmosomes, secondary effects on other intercalated disk structures, or impaired Wnt/beta-catenin signaling, resulting in increased expression of adipogenic and fibrogenic genes and fat-accumulation, may all contribute to the ARVD/C pathophysiology.²²⁻²⁴ However, regardless of the gene that is mutated, translocation of plakoglobin from the desmosome to the cytosol may be an important common step in disease causation.^{22,24,25}

It has been shown that mutations in *PKP2* are frequent in ARVD/C patients in the North-Western part of Europe and the US.^{5,7,26,27} In a cohort of Dutch ARVD/C patients up to 90% of *PKP2* mutations were found in cases of proven familial disease.²¹ Eight different recurrent *PKP2* mutations have been found in the Dutch population, accounting for 84% (41/49) of separately ascertained *PKP2* positive ARVD/C families. For some of them a shared *PKP2* haplotype has been demonstrated, while other families could be traced back to a common ancestor by genealogy, sometimes as far as ten generations ago.⁷ Therefore, it is likely that several different *PKP2* founder mutations segregate in the Netherlands, which may contribute to the high prevalence of *PKP2* mutations in Dutch ARVD/C patients.

Looking at the spectrum of different mutations reported in *PKP2*, it is evident that truncating mutations (nonsense and frameshift) are most frequent.²⁸ The classification of missense variants as pathogenic, in *PKP2* as well as in other genes, remains challenging without solid functional evidence.²⁹ Truncating mutations are predicted to lead to loss of PKP2 protein by nonsense mediated messenger-RNA decay (NMD), although mRNA studies done by Gerull *et al.* show that the identified splice mutations had detectable mRNA with frameshifts, resulting in premature termination codons, that may evade NMD.⁵ As a general rule, introduction of a stop codon more than 50-55 nucleotides upstream of the last exon-intron boundary of any gene will lead to the breakdown of messenger-RNA in vivo, resulting in only very little translation of the abnormal truncated protein.³⁰ This is an argument for haploinsufficiency (insufficient amounts of normal PKP2) as the predominant mechanism by which *PKP2* mutations predispose to disease, as opposed to a dominant negative effect due to the presence of abnormal PKP2 protein. Indeed, a western blot from a heart biopsy from a patient with *PKP2* mutation c.2076_2077delAA (p.Ser693CysfsX49) did not show detectable protein.⁵

This report discusses both the clinical characteristics of patients from four different families that were found to have an identical splice mutation (c.2489+4A>C) at the C-terminal end of the *PKP2* gene, and the possible mechanism by which it exerts its effect.

METHODS

Clinical evaluation

All index-patients and their relatives were evaluated at the Cardiology departments of the University Medical Centers in Utrecht and Amsterdam. Family members were evaluated following a genetic counseling procedure and after informed consent had been obtained. Evaluation consisted of at least physical examination, 12-lead ECG and echocardiography. Diagnosis was based on the recently modified ARVD/C Task Force Criteria (TFC).²

Genealogy

Since 1997 genealogical studies have been performed in newly ascertained ARVD/C cases, in order to select patients that could contribute to the finding of new ARVD/C loci, using identity by descent strategies.³¹ Investigations were carried out using community registries, starting from information on the grandparents as supplied by the index-patients.

Molecular genetic analyses

DNA was isolated from peripheral lymphocytes according to standard protocols. In index-patients the coding region of the *PKP2*, *DSC2*, *DSG2*, *DSP*, *JUP*, and *TMEM43* genes were analysed, using denaturing high-performance liquid chromatography (*PKP2*, *DSC2*, *DSG2*) as described previously,³² and/or direct sequencing (*DSP*, *JUP*, *TMEM43*). Direct sequencing was performed with a BigDye Terminator DNA sequencing kit (version 2.0) on a 3730 automated sequencer (Applied Biosystems, Foster City, California, USA). All sequences were analysed using SeqScape software (version 2.1.1, Applied Biosystems). In addition, multiplex ligation-dependent probe amplification analysis was performed to exclude large deletions in *PKP2* (SALSA multiplex ligation-dependent probe amplification kit P168 ARVC-PKP2, MRC Holland, Amsterdam, the Netherlands). Relatives of index-patients were only analysed for the presence of a previously identified mutation.

Total RNA was isolated from fresh blood samples from individual VII:6 and a control individual using PAXgene kit (QIAGEN Benelux, Venlo, the Netherlands) and subjected to random hexamer primed reverse transcriptase PCR (RT-PCR). The obtained cDNA products were amplified by PCR with primers specific for *PKP2* coding sequence. *PKP2* cDNA fragments were separated according to size using 2% agarose gel electrophoresis along with a 100bp DNA ladder (O'GeneRuler; Fermentas, Burlington, Canada). Both normal and aberrant fragments were gel purified and used for direct sequencing. Primers and PCR details are available upon request.

RESULTS

Genealogy

In families 2 and 3 (Figure 1) common ancestors were found, that were born around AD 1780. Family 1 could be linked to family 2, but a link with the common ancestors in families 2 and 3 could not be established. Family 4 could not be traced back to the same ancestors, yet all ancestors lived in the same region.

Molecular genetic analyses

Analysis of the entire coding regions of *PKP2*, *DSC2*, *DSG2*, *DSP*, *JUP*, and *TMEM43*, including exon-intron boundaries, in the four index-patients revealed a c.2489+4A>C mutation in the *PKP2* gene. Besides this intervening sequence mutation, no other mutations, including large deletions in *PKP2*, were found. The *PKP2* c.2489+4A>C mutation is within the splice donor consensus sequence. Splice prediction programs were inconclusive with respect to a predicted effect on splicing (Table 1). The mutation was absent in over 150 ethnically matched controls (300 alleles) and

not annotated in both dbSNP and the 1000genomes project databases (accessed October 10, 2011). In addition to the four index-patients, ten relatives were also found to carry the *PKP2* c.2489+4A>C mutation.

RT-PCR demonstrated the presence of an abnormal *PKP2* messenger RNA (Figure 2a), indicating that the effect of the c.2489+4A>C mutation is indeed through aberrant splicing. The abnormal *PKP2* messenger RNA lacks the entire exon 12 (190 base pairs) (Figure 2b). In the predicted protein a frameshift occurs that leads to stop codon 99 residues downstream, well within the 3'untranslated region of the *PKP2* gene. Therefore, all residues normally encoded by exons 12, 13 and 14 are missing from the abnormal transcript, but the predicted abnormal protein is only 15 residues shorter than the wild type protein (Figure 3). Since the stop codon occurs in the 3'untranslated region, the abnormal protein cannot be subjected to NMD.

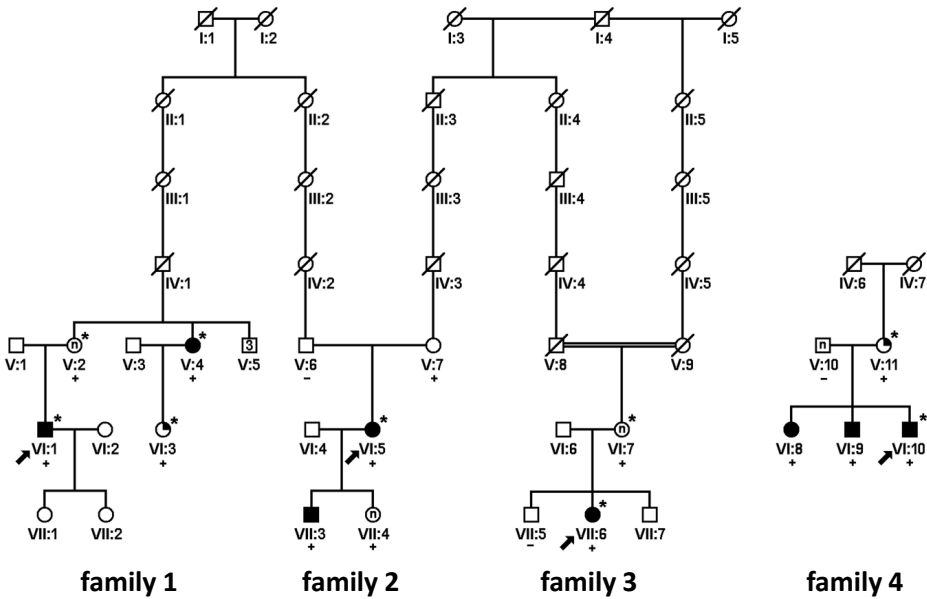

Figure 1 Pedigrees of families 1-4. Squares denote males, circles females. Black squares/circles denote individuals that satisfy the 2010 Task Force Criteria (TFC) for a clinical diagnosis of ARVD/C (≥ 4 points). Upper right quadrant blackened squares/circles denote individuals that did not fulfil the TFC, but did have abnormalities compatible with ARVD/C at their most recent cardiac examination. +/- indicates the presence or absence of the *PKP2* c.2489+4A>C mutation. Individuals denoted with "n" had a normal cardiac evaluation. Numbers in squares/circles denote the number of individuals. * Genotype used for haplotype sharing test, using SNP-array data.³³

Table 1 Results of splice prediction programs

Splice prediction program	Wildtype	c.2489+4A>C	
		mutation	Notes
NetGene2	0.93	0.91	Both 'Highly confident donor sites'
NNSPLICE 0.9	0.98	0.57	donor score cutoff = 0.40
Using Alamut Mutation Interpretation Software:			
SpliceSiteFinder-Like	73.60	62.81	
MaxEntScan	9.73	6.22	
GeneSplicer	2.54	1.02	

Results of the different prediction programs for the normal exon 12 donor splice site are shown.

Splice prediction are available from the following websites:

NetGene2: www.cbs.dtu.dk/services/NetGene2/;

NNSplice 0.9: www.fruitfly.org/seq_tools/splice.html;

MaxEntScan: genes.mit.edu/burgelab/maxent/Xmaxentscan_scoreseq.html;

GeneSplicer: www.cbcb.umd.edu/software/GeneSplicer/;

Alamut: www.interactive-biosoftware.com.

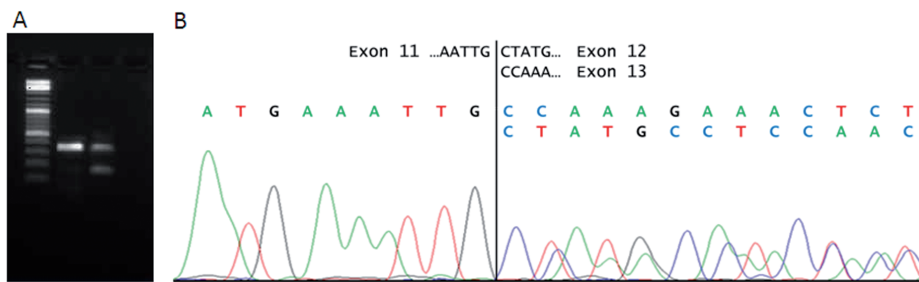

Figure 2 RT-PCR for the *PKP2* c.2489+4A>C mutation. (a) 2% Agarose gel electrophoresis showing cDNA products derived from mRNA of a control sample and index-patient VII:6. The first lane shows a 100bp ladder, followed by the control, the patient sample, and a blank with primers in exons 11 and 13. The expected normal cDNA product with primers in exons 11 and 13 is 335bp in length. The shorter transcript in the patient sample (lane 3) lacks exon 12 (190bp) as shown in Figure 2b. The bands in the patient sample show a ~1:1 ratio, indicating that preferred PCR of the shorter transcript, lacking exon 12, did not occur. This could indicate partial degradation of the mutated mRNA. (b) Sequencing of the cDNA derived from both the normally spliced transcript and the abnormally spliced transcript demonstrating the skipping of exon 12.

Clinical evaluation

All index-patients with the *PKP2* c.2489+4A>C mutation fulfilled the modified TFC for ARVD/C.² Figure 1 shows the pedigree of all families and clinical data on the *PKP2* c.2489+4A>C mutation carriers are summarised in Table 2. Index-patient 1 (VI:1) was admitted to the hospital at age 33 years with sustained monomorphic ventricular tachycardia (VT) (240/min) with left bundle branch block (LBBB) morphology during exercise. He experienced at least four other episodes of VT, but no

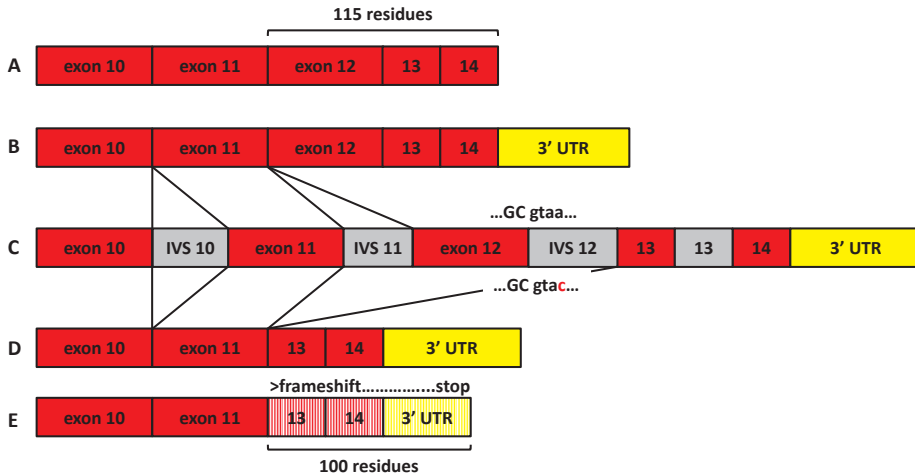

Figure 3 Aberrant splicing as a result of the *PKP2* c.2489+4A>C mutation. A and B represent the C-terminus of the normal *PKP2* protein and the normally spliced mRNA respectively. C depicts part of the genomic DNA of the *PKP2* gene (exons in red, introns (IVS) in grey, 3'untranslated region (UTR) in yellow) with the position of the wild type splice site above the bar and the mutated splice site below the bar. D and E show the aberrant splice product and the predicted abnormal protein respectively. The abnormal protein is only 15 amino acid residues shorter than the wild type protein.

syncope. Supraventricular tachycardias also occurred, caused by AV-nodal re-entry and provoked by premature ventricular complexes. Radiofrequency (RF) ablation was performed for the ventricular arrhythmias from the right ventricular outflow tract and for the AVNRT. He has been doing well on disopyramide medication for twelve years. Index-patient 2 (VI:5) has been known with frequent VT episodes with LBBB morphology since the age of 20, which were treated with RF-ablation. At age 36 she had an out of hospital cardiac arrest (OHCA) due to ventricular fibrillation (VF) while on sotalol. Subsequently an implantable cardioverter defibrillator (ICD) was implanted, which has delivered appropriate anti-tachycardia pacing and shocks. Index-patient 3 (VII:6) experienced a syncope at age 26 during exercise. She was admitted with a wide QRS complex tachycardia (250/min). Treatment with disopyramide was started. An AV-nodal re-entry tachycardia (AVNRT) was diagnosed at electrophysiological study, which was treated with RF-ablation, after a second arrhythmia episode. She has been free of symptoms for fourteen years. Index-patient 4 (VI:10) had an OHCA with VF at age 29. He received an ICD and was treated with metoprolol for VTs. At age 33 he experienced two episodes with electrical storms possibly triggered by a viral infection. Metoprolol was changed to sotalol and amiodarone was added. The patient has been doing well for nine years.

In addition to the four index-patients, two of the mutation positive family members developed clinical complaints likely related to ARVD/C, resulting in 6

Table 2 Clinical data on *PKP2* c.2489+4A>C mutation carriers

Individual (Figure 1)	Modified taskforce criteria for the diagnosis of ARVD/C														
	Sex	Onset age (yrs)	Age first evaluation (yrs)	Follow-up (yrs)	Events	Function	Tissue [*]	Repolarisation	Depolarisation	Arrhythmias	Family history	Task Force Criteria [‡]	Clinical Status	Treatment	Other
Family 1															
VI:1 [§]	M	33	33	12	VT	+			++	++	5	Aff	RF-ablation, disopyramide	Atypical AVNRT; no progression	
V:2	F	61	0	none						++	2	Pos	none	No follow-up	
V:4	F	69	7	none			++	++	++		6	Aff	anti-coagulant therapy	Paroxysmal AF; no progression	
VI:3	F	35	7	none			+		++		3	Bor	none	No progression	
Family 2															
VI:5	F	20	20	32	VT/VF/OHCA	++	++	++	++	++	10	Aff	RF-ablation, ICD, sotalol	Appropriate ICD-, good LV function.	
VII:3	M	17	11	none	++		+		++		5	Aff	none	Mild progression	
VII:4	F	15	11	none					++		2	Pos	none	No progression	
V:7	F													Not evaluated	
Family 3															
VII:6 [¶]	F	26	26	14	syncope	+	++	+	++	++	8	Aff	RF-ablation	Concurrent AVNRT; no progression	
VI:7	F	62	3	none					++		2	Pos	none	No progression	
Family 4															
VI:10	M	29	29	9	VF/OHCA	++	++	++	++		8	Aff	ICD, sotalol, amiodarone	Appropriate ICD-, mild progression	
V:11	F	59	9	none					++		2	Pos	none	Mild progression	
VI:8	F	40	33	9	near syncope	++			++		4	Aff	ICD	Evident progression	
VI:9	M	34	32	9	near syncope			++	++		4	Aff	ICD, sotalol	Mild progression	

* Not available, ‡ minor criteria yield 1 point and major criteria 2 points; for a definite diagnosis of ARVD/C a minimum of 4 points is required, 3 points indicate a borderline diagnosis and 2 points a possible diagnosis. § for this patient a biopsy was available; it showed fibrosis but no fat and was considered inconclusive, ¶ syncope probably resulting from AVNRT; thus far no symptoms have recurred after RF-ablation of AVNRT.

Abbreviations: AF = atrial fibrillation, Aff = affected, AVNRT = AV-nodal re-entry tachycardia, Bor = borderline, F = female, ICD = implantable cardioverter defibrillator, ICD- = ICD discharge, LBBB = left bundle branch block morphology, LV = left ventricle, M = male, NA = not available, nsVT = non-sustained ventricular tachycardia, OHCA = out of hospital cardiac arrest, Pos = possibly, RF = radiofrequency, RV = right ventricle, sVT = sustained ventricular tachycardia, VF = ventricular fibrillation, VT = ventricular tachycardia.

symptomatic mutation carriers. In family 4, a 34 year old male (VI:9), who had had no complaints at initial evaluation, received an ICD after he suffered a near syncope while already taking sotalol. Non-sustained polymorphic VTs of insufficient duration to warrant ICD therapy were subsequently recorded. His sister (VI:8) received an ICD shortly after she experienced a near syncope during a stressful event. Although without any signs of disease at initial evaluation at age 33, she developed aneurysmatic changes of the right ventricle in the course of nine years.

Remarkably, seven of the thirteen mutation carriers (age range at first evaluation 15-69 years) who were evaluated, were asymptomatic. In four of them only a major criterion for a positive family history was available, leading to a possible clinical status according to the modified taskforce criteria. In three of the asymptomatic carriers additional criteria were present, resulting in a borderline diagnosis in one and a definite diagnosis in two asymptomatic carriers.²

Left ventricular involvement was not systematically assessed in these families. Cardiac MRI was performed in five mutation carriers; all of them showed normal LV volumes and LV ejection fraction. None of them showed LV wall motion abnormalities or late gadolinium late enhancement. Index-patient VI-5 experienced a VT with RBBB morphology, but she had a normal LV function. Finally, none of the mutation carriers had isolated inverted T-waves in the left precordial leads V_4 - V_6 .

DISCUSSION

PKP2 mutations are a frequent cause of ARVD/C. The *PKP2* gene was first implicated in ARVD/C through a candidate-gene approach.⁵ The fact that the *PKP2* locus had not been previously found in linkage studies can be explained by low penetrance resulting in phenotype negative family members who were classified as unaffected, although they were in fact mutation carriers. Previously, the haplotype sharing test identified a shared haplotype on chromosome 12p12.1-q13.13, encompassing *PKP2*, as the largest shared haplotype in these families.³³ The haplotype sharing test compares the genotypes from SNP-arrays, using an affected-only strategy, to search for large shared haplotypes within pedigrees, most likely to contain a causative mutation. In these families, the haplotype sharing test indicated a common founder, who must have lived well before the 19th century. Based on pedigree data, it was estimated that the most recent common ancestor should be situated over seven generations ago. However, these are crude estimations since only four families were available. The actual age of the mutation could be considerably older. Little is known about the age of *PKP2* mutations. Our data show that mutations may have occurred many generations earlier, in absence of a family history of cardiac disease. The fact

that in some families we have been able to demonstrate common ancestors as far as 10 generations back by genealogy, suggests that reproductive fitness in ARVD/C is not significantly reduced.

The PKP2 c.2489+4A>C mutation seems to be relatively frequent in the Netherlands, being detected in four independently ascertained ARVD/C families, so far. Another five mutations (c.235C>T, c.397C>T, c.1211-1212dupT, c.2386T>C and c.2489+1G>A) in PKP2 have occurred at least as frequent in the Dutch ARVD/C cohort. Haplotype analysis and genealogy suggest that there also may be common founders contributing to these mutations, explaining the high prevalence of PKP2 mutations in Dutch ARVD/C patients.^{32,34}

The frequent occurrence of nonsense and frameshift mutations in PKP2 is indicative that the causative mechanism at the protein level is that of loss of normal PKP2 function, as most of these mutations are predicted to lead to NMD.²⁸ Gerull *et al*, while performing Western blot analysis on cardiac tissue in a patient with a PKP2 c.2076_2077delAA mutation, demonstrated reduced wild type PKP2, but were unable to demonstrate the predicted abnormal protein.⁵ This is in keeping with the concept of NMD in the heart. As the PKP2 c.2489+4A>C mutation cannot be subjected to NMD, it is predicted to lead to a dysfunctional PKP2 protein. However, we cannot exclude degradation of the abnormal protein through other mechanisms, which could still lead to haplo-insufficiency. If a dysfunctional protein is present, the last two conserved armadillo repeat regions would be disrupted, completely altering the C-terminal tail. The exact role of the C-terminal tail is unknown, while the N-terminal part of the protein is most important for binding other desmosomal proteins and targeting PKP2 to the plasma membrane.³⁵ The pathogenic effect of splice mutations may be ameliorated when the induced aberrant splicing is not absolute, as has been shown for the only recessive PKP2 mutation thus far.³⁶ In the absence of heterozygous polymorphisms in exons 12-14 of the PKP2 gene, the presence of a normal transcript from the diseased allele could not be assessed.

In total 14 patients with the PKP2 c.2489+4A>C mutation (4 males, 10 females), including index-patients, were identified in the four families. Despite the overrepresentation of female mutation carriers in this study, two out of four index-patients were males. Nine out of ten family members with a mutation had a cardiac work up. Only two of nine evaluated mutation positive family members developed clinical complaints (Table 2). Five family members fulfilled the modified TFC for ARVD/C. Incomplete penetrance and clinical variability are characteristic for ARVD/C,⁴ and are also seen in the families with the PKP2 c.2489+4A>C mutation. Compound heterozygosity or digenic inheritance for mutations in the desmosomal genes or in TMEM43 had been excluded as an explanation for this variability, but other genetic,

epigenetic or non-genetic factors, such as lifestyle, could have contributed to the clinical differences observed in these families.

Which preventive treatment modalities are justified in asymptomatic *PKP2* mutation carriers is currently undetermined. We suggest that they be followed up regularly in order to assess disease progression with annual echocardiography, Holter monitoring and exercise testing. Besides, additional cardiac MRI at intervals no longer than 5 years (or before implantation of an ICD) is deemed appropriate in the Netherlands.

Although we find molecular diagnosis in ARVD/C a useful tool in identifying persons at risk for developing ARVD/C, its value is still limited by the inability to accurately predict phenotype from genotype, especially when a missense variant is identified.²⁹ The fact that many identified *PKP2* mutation carriers will never experience life-threatening arrhythmias, emphasises the need for identifying both the truly pathogenic mutations as well as other genetic or environmental factors that play a role in disease causation. We believe that the described *PKP2* c.2489+4A>C mutation is pathogenic, based on its co-segregation with the ARVC/D phenotype, the absence of the mutation in controls as well as in the dbSNP and the 1000genomes project databases, the fact that the mutation is located on the largest shared haplotype, indicating a founder effect,³³ and the RT-PCR which demonstrated the presence of an abnormal *PKP2* messenger RNA (Figure 2a). As is the case for many other desmosomal mutations implicated in ARVC/D, the c.2489+4A>C mutation is characterised by incomplete penetrance, indicating that not all mutation carriers will develop the disease. The mutation is predicted to lead to the presence of a dysfunctional *PKP2* protein, whereas most truncating mutations are expected to lead to loss of protein. Mutation carriers displayed a wide range in disease severity, suggesting that *PKP2* mutations alone are not sufficient to cause disease.

Acknowledgements

We sincerely thank the families for their cooperation. Furthermore, we thank Dr. C. de Kovel for helping estimating the distance to the most recent common founder, Marcel R. Nelen, Mark M. Entius, and Richard A. Zewald for assistance with the molecular genetic analyses, Jackie Senior for editing the manuscript, and Dr. E.G. Weijers, cardiologist Groene Hart Ziekenhuis, Gouda, the Netherlands, for referring index-patient VII:6. This work was supported by a grant from the Netherlands Heart Foundation (2007B132).

REFERENCES

1. McKenna WJ, Thiene G, Nava A, Fontaliran F, Blomstrom-Lundqvist C, Fontaine G, Camerini F. Diagnosis of arrhythmogenic right ventricular dysplasia/cardiomyopathy. Task Force of the Working Group Myocardial and Pericardial Disease of the European Society of Cardiology and of the Scientific Council on Cardiomyopathies of the International Society and Federation of Cardiology. *Br Heart J*. 1994;71:215-8.
2. Marcus FI, McKenna WJ, Sherrill D, Basso C, Bauce B, Bluemke DA, Calkins H, Corrado D, Cox MG, Daubert JP, Fontaine G, Gear K, Hauer R, Nava A, Picard MH, Protonotarios N, Saffitz JE, Sanborn DM, Steinberg JS, Tandri H, Thiene G, Towbin JA, Tsatsopoulou A, Wichter T, Zareba W. Diagnosis of arrhythmogenic right ventricular cardiomyopathy/dysplasia: proposed modification of the task force criteria. *Circulation*. 2010;121:1533-41.
3. Marcus FI, Fontaine GH, Guiraudon G, Frank R, Laurenceau JL, Malergue C, Grosgeat Y. Right ventricular dysplasia: a report of 24 adult cases. *Circulation*. 1982;65:384-98.
4. Basso C, Corrado D, Marcus FI, Nava A, Thiene G. Arrhythmogenic right ventricular cardiomyopathy. *Lancet*. 2009;373:1289-300.
5. Gerull B, Heuser A, Wichter T, Paul M, Basson CT, McDermott DA, Lerman BB, Markowitz SM, Ellinor PT, MacRae CA, Peters S, Grossmann KS, Drenckhahn J, Michely B, Sasse-Klaassen S, Birchmeier W, Dietz R, Breithardt G, Schulze-Bahr E, Thierfelder L. Mutations in the desmosomal protein plakophilin-2 are common in arrhythmogenic right ventricular cardiomyopathy. *Nat Genet*. 2004;36:1162-4.
6. Dalal D, Molin LH, Piccini J, Tichnell C, James C, Bomma C, Prakasa K, Towbin JA, Marcus FI, Spevak PJ, Bluemke DA, Abraham T, Russell SD, Calkins H, Judge DP. Clinical features of arrhythmogenic right ventricular dysplasia/cardiomyopathy associated with mutations in plakophilin-2. *Circulation*. 2006;113:1641-9.
7. Van Tintelen JP, Entius MM, Bhuiyan ZA, Jongbloed R, Wiesfeld AC, Wilde AA, van der Smagt J, Boven LG, Mannens MM, van Langen IM, Hofstra RM, Otterspoor LC, Doevendans PA, Rodriguez LM, van Gelder IC, Hauer RN. Plakophilin-2 mutations are the major determinant of familial arrhythmogenic right ventricular dysplasia/cardiomyopathy. *Circulation*. 2006;113:1650-8.
8. Syrris P, Ward D, Evans A, Asimaki A, Gandjbakhch E, Sen-Chowdhry S, McKenna WJ. Arrhythmogenic right ventricular dysplasia/cardiomyopathy associated with mutations in the desmosomal gene desmocollin-2. *Am J Hum Genet*. 2006;79:978-84.
9. Heuser A, Plovie ER, Ellinor PT, Grossmann KS, Shin JT, Wichter T, Basson CT, Lerman BB, Sasse-Klaassen S, Thierfelder L, MacRae CA, Gerull B. Mutant desmocollin-2 causes arrhythmogenic right ventricular cardiomyopathy. *Am J Hum Genet*. 2006;79:1081-8.
10. Pilichou K, Nava A, Basso C, Beffagna G, Bauce B, Lorenzon A, Frigo G, Vettori A, Valente M, Towbin J, Thiene G, Danieli GA, Rampazzo A. Mutations in desmoglein-2 gene are associated with arrhythmogenic right ventricular cardiomyopathy. *Circulation*. 2006;113:1171-9.
11. Rampazzo A, Nava A, Malacrida S, Beffagna G, Bauce B, Rossi V, Zimbello R, Simonati B, Basso C, Thiene G, Towbin JA, Danieli GA. Mutation in human desmoplakin domain binding to plakoglobin causes a dominant form of arrhythmogenic right ventricular cardiomyopathy. *Am J Hum Genet*. 2002;71:1200-6.
12. Asimaki A, Syrris P, Wichter T, Matthias P, Saffitz JE, McKenna WJ. A novel dominant mutation in plakoglobin causes arrhythmogenic right ventricular cardiomyopathy. *Am J Hum Genet*. 2007;81:964-73.

13. Tsatsopoulou AA, Protonotarios NI, McKenna WJ. Arrhythmogenic right ventricular dysplasia, a cell adhesion cardiomyopathy: insights into disease pathogenesis from preliminary genotype-phenotype assessment. *Heart*. 2006;92:1720-3.
14. Van Tintelen JP, Hofstra RM, Wiesfeld AC, van den Berg MP, Hauer RN, Jongbloed JD. Molecular genetics of arrhythmogenic right ventricular cardiomyopathy: emerging horizon? *Curr Opin Cardiol*. 2007;22:185-92.
15. Merner ND, Hodgkinson KA, Haywood AF, Connors S, French VM, Drenckhahn JD, Kupprion C, Ramadanova K, Thierfelder L, McKenna W, Gallagher B, Morris-Larkin L, Bassett AS, Parfrey PS, Young TL. Arrhythmogenic right ventricular cardiomyopathy type 5 is a fully penetrant, lethal arrhythmic disorder caused by a missense mutation in the TMEM43 gene. *Am J Hum Genet*. 2008;82:809-21.
16. Van Tintelen JP, van Gelder IC, Asimaki A, Suurmeijer AJ, Wiesfeld AC, Jongbloed JD, van den Wijngaard A, Kuks JB, Spaendonck-Zwarts KY, Notermans N, Boven L, van den Heuvel F, Veenstra-Knol HE, Saffitz JE, Hofstra RM, van den Berg MP. Severe cardiac phenotype with right ventricular predominance in a large cohort of patients with a single missense mutation in the DES gene. *Heart Rhythm*. 2009;6:1574-83.
17. Klauke B, Kossmann S, Gaertner A, Brand K, Stork I, Brodehl A, Dieding M, Walhorn V, Anselmetti D, Gerdes D, Bohms B, Schulz U, Zu Knyphausen E, Vorgerd M, Gummert J, Milting H. De novo desmin-mutation N116S is associated with arrhythmogenic right ventricular cardiomyopathy. *Hum Mol Genet*. 2010;19:4595-607.
18. Taylor M, Graw S, Sinagra G, Barnes C, Slavov D, Brun F, Pinamonti B, Salcedo EE, Sauer W, Pyxaras S, Anderson B, Simon B, Bogomolovas J, Labeit S, Granzier H, Mestroni L. Genetic variation in titin in arrhythmogenic right ventricular cardiomyopathy-overlap syndromes. *Circulation*. 2011;124:876-85.
19. Xu T, Yang Z, Vatta M, Rampazzo A, Beffagna G, Pillichou K, Scherer S, Saffitz J, Kravitz J, Zareba W, Danieli G, Lorenzon A, Nava A, Bauce B, Thiene G, Basso C, Calkins H, Gear K, Marcus F, Towbin J. Compound and Digenic Heterozygosity Contributes to Arrhythmogenic Right Ventricular Cardiomyopathy. *J Am Coll Cardiol*. 2010;55:587-97.
20. Fressart V, Duthoit G, Donal E, Probst V, Deharo JC, Chevalier P, Klug D, Dubourg O, Delacretaz E, Cosnay P, Scanu P, Extramiana F, Keller D, Hidden-Lucet F, Simon F, Bessirard V, Roux-Buisson N, Hebert JL, Azarine A, Casset-Senon D, Rouzet F, Lecarpentier Y, Fontaine G, Coirault C, Frank R, Hainque B, Charron P. Desmosomal gene analysis in arrhythmogenic right ventricular dysplasia/cardiomyopathy: spectrum of mutations and clinical impact in practice. *Europace*. 2010;12:861-8.
21. Cox MG, van der Zwaag PA, van der Werf C, van der Smagt JJ, Noorman M, Bhuiyan ZA, Wiesfeld AC, Volders PG, van Langen IM, Atsma DE, Dooijes D, van den Wijngaard A, Houweling AC, Jongbloed JD, Jordaens L, Cramer MJ, Doevendans PA, de Bakker JM, Wilde AA, van Tintelen JP, Hauer RN. Arrhythmogenic right ventricular dysplasia/cardiomyopathy: pathogenic desmosome mutations in index-patients predict outcome of family screening: Dutch arrhythmogenic right ventricular dysplasia/cardiomyopathy genotype-phenotype follow-up study. *Circulation*. 2011;123:2690-700.
22. Kaplan SR, Gard JJ, Protonotarios N, Tsatsopoulou A, Spiliopoulou C, Anastasakis A, Squarcioni CP, McKenna WJ, Thiene G, Basso C, Brousse N, Fontaine G, Saffitz JE. Remodeling of myocyte gap junctions in arrhythmogenic right ventricular cardiomyopathy due to a deletion in plakoglobin (Naxos disease). *Heart Rhythm*. 2004;1:3-11.
23. Basso C, Czarnowska E, Della Barbera M, Bauce B, Beffagna G, Wlodarska EK, Pillichou K, Ramondo A, Lorenzon A, Wozniak O, Corrado D, Daliento L, Danieli GA, Valente M, Nava A, Thiene G, Rampazzo A. Ultrastructural evidence of intercalated disc remodelling in arrhythmogenic right

- ventricular cardiomyopathy: an electron microscopy investigation on endomyocardial biopsies. *Eur Heart J*. 2006;27:1847-54.
24. Garcia-Gras E, Lombardi R, Giocondo MJ, Willerson JT, Schneider MD, Khoury DS, Marian AJ. Suppression of canonical Wnt/beta-catenin signaling by nuclear plakoglobin recapitulates phenotype of arrhythmogenic right ventricular cardiomyopathy. *J Clin Invest*. 2006;116:2012-21.
 25. Asimaki A, Tandri H, Huang H, Halushka MK, Gautam S, Basso C, Thiene G, Tsatsopoulou A, Protonotarios N, McKenna WJ, Calkins H, Saffitz JE. A new diagnostic test for arrhythmogenic right ventricular cardiomyopathy. *N Engl J Med*. 2009;360:1075-84.
 26. Syrris P, Ward D, Asimaki A, Sen-Chowdhry S, Ebrahim HY, Evans A, Hitomi N, Norman M, Pantazis A, Shaw AL, Elliott PM, McKenna WJ. Clinical expression of plakophilin-2 mutations in familial arrhythmogenic right ventricular cardiomyopathy. *Circulation*. 2006;113:356-64.
 27. Den Haan AD, Tan B, Zikusoka M, Ibanez Llado L, Jain R, Daly A, Tichnell C, James C, Amat-Alarcon N, Abraham T, Russell S, Bluemke D, Calkins H, Dalal D, Judge D. Comprehensive desmosome mutation analysis in North Americans with arrhythmogenic right ventricular dysplasia/cardiomyopathy. *Circ Cardiovasc Genet*. 2009;2:428-35.
 28. Van der Zwaag PA, Jongbloed JD, van den Berg MP, van der Smagt JJ, Jongbloed R, Bikker H, Hofstra RM, van Tintelen JP. A genetic variants database for arrhythmogenic right ventricular dysplasia/cardiomyopathy. *Hum Mutat*. 2009;30:1278-83.
 29. Christensen AH, Benn M, Tybjaerg-Hansen A, Haunso S, Svendsen JH. Missense variants in plakophilin-2 in arrhythmogenic right ventricular cardiomyopathy patients--disease-causing or innocent bystanders? *Cardiology*. 2010;115:148-54.
 30. Lykke-Andersen J. mRNA quality control: Marking the message for life or death. *Curr Biol*. 2001;11:R88-91.
 31. Houwen RH, Baharloo S, Blankenship K, Raeymaekers P, Juyn J, Sandkuijl LA, Freimer NB. Genome screening for shared segments: mapping a gene for benign recurrent intrahepatic cholestasis. *Nat Genet*. 1994;8:380-6.
 32. Bhuiyan ZA, Jongbloed JD, van der Smagt J, Lombardi PM, Wiesfeld AC, Nelen M, Schouten M, Jongbloed R, Cox MG, van Wolferen M, Rodriguez LM, van Gelder IC, Bikker H, Suurmeijer AJ, van den Berg MP, Mannens MM, Hauer RN, Wilde AA, van Tintelen JP. Desmoglein-2 and desmocollin-2 mutations in Dutch arrhythmogenic right ventricular dysplasia/cardiomyopathy patients: Results from a multicenter study. *Circ Cardiovasc Genet*. 2009;2:418-27.
 33. Van der Zwaag PA, van Tintelen JP, Gerbens F, Jongbloed JD, Boven LG, van der Smagt JJ, van der Roest WP, van Langen IM, Bikker H, Hauer RN, van den Berg MP, Hofstra RM, te Meerman GJ. Haplotype sharing test maps genes for familial cardiomyopathies. *Clin Genet*. 2011;79:459-67.
 34. Van der Zwaag PA, Cox MG, van der Werf C, Wiesfeld AC, Jongbloed JD, Dooijes D, Bikker H, Jongbloed R, Suurmeijer AJ, van den Berg MP, Hofstra RM, Hauer RN, Wilde AA, van Tintelen JP. Recurrent and founder mutations in the Netherlands: Plakophilin-2 pArg79X mutation causing arrhythmogenic right ventricular cardiomyopathy/dysplasia. *Neth Heart J*. 2010;18:583-91.
 35. Chen X, Bonne S, Hatzfeld M, van Roy F, Green KJ. Protein binding and functional characterization of plakophilin 2. Evidence for its diverse roles in desmosomes and beta -catenin signaling. *J Biol Chem*. 2002;277:10512-22.
 36. Awad MM, Dalal D, Tichnell C, James C, Tucker A, Abraham T, Spevak PJ, Calkins H, Judge DP. Recessive arrhythmogenic right ventricular dysplasia due to novel cryptic splice mutation in PKP2. *Hum Mutat*. 2006;27:1157.

4

Recurrent and founder mutations in the Netherlands – Plakophilin 2 p.Arg79X mutation causing arrhythmogenic right ventricular cardiomyopathy/dysplasia

Paul A. van der Zwaag
Moniek G.P.J. Cox
Christian van der Werf
Ans C.P. Wiesfeld
Jan D.H. Jongbloed
Dennis Dooijes
Hennie Bikker
Roselie Jongbloed
Albert J.H. Suurmeijer
Maarten P. van den Berg
Robert M.W. Hofstra
Richard N.W. Hauer
Arthur A.M. Wilde
J. Peter van Tintelen

ABSTRACT

Background Arrhythmogenic right ventricular cardiomyopathy/dysplasia (ARVC/D) is an inherited cardiac disease with reduced penetrance and a highly variable expression. Mutations in the gene encoding plakophilin 2 (*PKP2*) are detected in about 50% of patients with ARVC/D. The p.Arg79X mutation in *PKP2* has been identified in Europe and North America and has been functionally characterised. We evaluated the prevalence of the p.Arg79X mutation in *PKP2* in the Dutch population.

Methods Twelve index patients and 41 family members were evaluated in three university hospitals in the Netherlands. The diagnosis of ARVC/D was established according to the recently revised Task Force Criteria. Segregation of the p.Arg79X mutation was studied and haplotypes were reconstructed to determine whether the p.Arg79X mutation was a recurrent or a founder mutation.

Results The p.Arg79X mutation in *PKP2* was identified in 12 index patients. Haplotype analysis revealed a shared haplotype among Dutch p.Arg79X mutation carriers, indicating a common founder. Six index patients (50%) had a first- or second-degree relative who had died of sudden cardiac death below 40 years of age. At age 60, only 60% of the mutation carriers actually experienced any symptoms. There was no significant difference in symptom-free survival and event-free survival between men and women.

Conclusions We identified the largest series of patients with the same desmosome gene mutation in ARVC/D reported to date. This p.Arg79X mutation in *PKP2* is a founder mutation in the Dutch population. The phenotypes of *PKP2* p.Arg79X mutation carriers illustrate the clinical variability and reduced penetrance often seen in ARVC/D.

INTRODUCTION

Arrhythmogenic right ventricular cardiomyopathy/dysplasia (ARVC/D) is an inherited cardiac disease, characterised by fibrofatty replacement of cardiomyocytes, primarily in the right ventricle (Figure 1A).^{1,2} The clinical presentation of ARVC/D is highly variable, ranging from asymptomatic to sudden cardiac death (SCD) and/or heart failure, even at a relatively young age.^{3,4} The clinical diagnosis of ARVC/D is based upon criteria originally proposed by an international Task Force in 1994;⁵ these have recently been modified to improve diagnostic sensitivity and maintain diagnostic specificity.⁶ The modified criteria include quantitative parameters for the imaging studies and tissue characterisation, revised ECG criteria, and genetic status. Applying the modified criteria to a Dutch cohort of patients with proven ARVC/D, their family members, and to patients with probable ARVC/D produced a major increase in the diagnostic yield of ARVC/D, especially due to the revised ECG criteria and the identification of pathogenic mutations.⁷ The estimated prevalence of ARVC/D ranges from 1:1000 to 1:5000, with men being more frequently affected than women. ARVC/D is familial in up to 50% of cases.^{1,8-12}

Since the identification of mutations in the genes encoding desmosomal proteins desmoplakin (DSP)¹³ and plakophilin 2 (PKP2),¹⁴⁻¹⁷ followed by mutations in desmocollin 2 (DSC2),¹⁸ desmoglein 2 (DSG2),¹⁹ and plakoglobin (JUP),²⁰ it has been recognised that ARVC/D is mainly a disorder of the cardiac desmosome (Figure 2), a cell adhesion complex residing in the intercalated disk of cardiomyocytes. Comprehensive screening of these genes encoding the proteins of this complex leads to the identification of a pathogenic mutation in approximately 40-60% of ARVC/D patients.^{7,21-23} PKP2 has the highest yield from mutational screening, being present in up to 55% of patients in the Netherlands and the USA in groups fulfilling the task force criteria.^{7,14-17}

The detection of a pathogenic mutation in a proband diagnosed with ARVC/D has important implications for family members. Cascade screening will identify previously unknown mutation carriers, enabling timely diagnosis and facilitating prevention of subsequent complications, thereby reducing morbidity and mortality. Excluding a pathogenic mutation in a family member justifies dismissal from regular cardiological follow-up.²⁴

To date, more than 140 different pathogenic mutations have been reported in ARVC/D patients.²⁵ In this series of the Netherlands Heart Journal on recurrent and founder mutations in the Netherlands, we describe the largest series of Dutch patients with the same desmosome gene mutation, the p.Arg79X mutation in PKP2. In addition, we discuss patients carrying this mutation by comparing them to patients with the same mutation described in the literature, and we illustrate

the clinical variability linked to this mutation. We also discuss functional analyses that have been performed to clarify the molecular and cellular consequences of the p.Arg79X mutation in PKP2.

PATIENTS AND METHODS

Clinical evaluation and diagnostic criteria

Twelve index patients carrying the p.Arg79X mutation were evaluated in one of the three university hospitals working on this study in the Netherlands. A total of 41 additional family members were also clinically and/or genetically evaluated. A history was taken from all the index patients, and they were evaluated by physical examination, 12-lead ECG, 24-hour Holter monitoring, exercise testing, and 2-dimensional transthoracic echocardiography. In addition, MRI, nuclear scintigraphy, signal-averaged ECG (SA-ECG), left and right ventricular cineangiography, electrophysiology study, and/or a right ventricular endomyocardial biopsy were performed in a subset of index patients.

The diagnosis of ARVC/D in index patients was established according to the modified task force criteria (TFC).⁶ A diagnosis of ARVC/D was considered definite if a patient fulfilled two major, one major and two minor, or four minor criteria. For each category, only one major or one minor criterion can be included. A diagnosis of ARVC/D was considered probable if only one major and one minor, or three minor criteria from different categories were present. ARVC/D was considered proven familial if at least one additional family member was found to fulfil the TFC. End points/events in follow-up were death due to a cardiac cause (including SCD) and an appropriate discharge of an implantable cardioverter defibrillator (ICD). These events, and ventricular tachycardia and syncope, were considered as symptoms for the Kaplan-Meier analysis.

The postal codes of all the p.Arg79X mutation carriers and of all the individuals who underwent *PKP2* sequence analysis in the Netherlands were plotted to study their geographical distribution.

Genetic evaluation

DNA for *PKP2* sequence analysis was isolated from peripheral blood samples according to standard protocols. *PKP2* primer sequences were obtained from Gerull et al,¹⁴ and mutational analysis was performed in all index patients, as described previously.¹⁷ Sequence analysis of *DSC2*, *DSG2*, *DSP*, and *JUP* was performed in six index patients, and in eight of twelve families we were able to study the segregation of the p.Arg79X mutation.

Haplotype analysis

To determine whether the p.Arg79X mutation is recurrent or has a common founder, we previously performed haplotype analysis in five p.Arg79X index patients, using five repeat markers within a region of 300,000 bp, including the entire genomic region of *PKP2*.¹⁷ For patients from the other seven families, the haplotypes were reconstructed using the same markers.

Statistical analysis

Kaplan-Meier analysis was used to determine the cumulative symptom-free and event-free survival in ARVC/D patients with the p.Arg79X mutation in *PKP2*. The log-rank test was used to compare the results for men versus women, with values

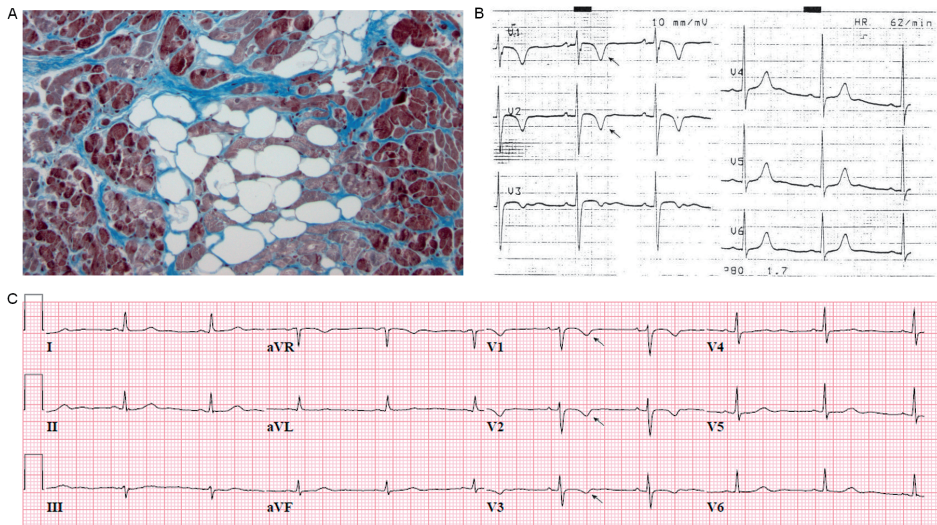

Figure 1 (A) Histology: high powered visualisation of fatty infiltration (white colour) and fibrous tissue (blue colour) surrounding atrophic cardiomyocytes and indicative of ARVC/D. (B) ECG of patient G1-III:1, obtained 8 months before the occurrence of SCD at the age of 27 years. The ECG showed inverted T waves in leads V_1 and V_2 (single arrow). (C) ECG of patient G1-II:1, obtained at age 56 years. The ECG showed inverted T waves in leads V_1 - V_3 (single arrow).

of $P < 0.05$ being considered significant. All data were analysed with the Statistical Package for Social Sciences (SPSS version 16.0; SPSS Inc., Chicago, Ill).

RESULTS

Clinical evaluation and diagnostic criteria

The age at initial presentation, diagnostic criteria, and follow-up of patients fulfilling the ARVC/D criteria are presented in Table 1 (see also Figure 3). Eleven index patients were diagnosed with definite ARVC/D. In patient G1-III:1, retrospective analysis of the ECG after SCD at the age of 27 years, showed inverted T waves in V1 and V2 (Figure 1B), which were also found in his mother's ECG (G1-II:1, see Figure 1C). One other index patient (A45-IV:8) was diagnosed with ARVC/D after SCD at the age of 25 years. Another index patient (A44-II:4) was diagnosed with probable ARVC/D.

Three of twelve index patients were women, with an average age at initial presentation of 37 years (22-66; median 29). Nine of the twelve index patients presented

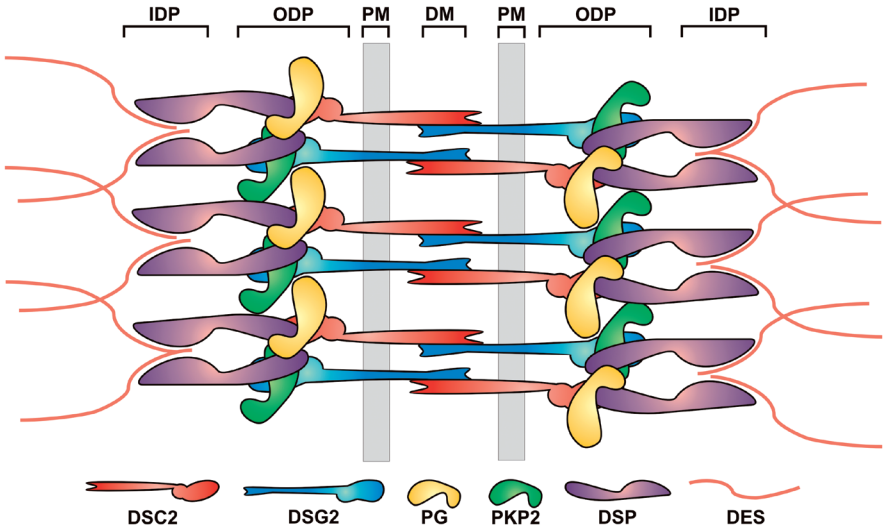

Figure 2 Schematic representation of the molecular organisation of cardiac desmosomes. A model of the relative organisation of major desmosome components is presented. The plasma membrane-bound (PM) desmocollin 2 (DSC2) and desmoglein 2 (DSG2) proteins interact via their extracellular domains at the dense midline (DM) in the extracellular space between adjacent cells. Their cytoplasmic domains interact with plakoglobin (PG) and plakophilin 2 (PKP2) in the outer dense plaque (ODP). Also in the ODP, PKP2 and PG interact with the N-terminal domain of desmoplakin (DSP). The C-terminus of desmoplakin anchors intermediate filaments, mainly desmin (DES), at the inner dense plaque (IDP).²⁴

with ventricular tachycardia (VT), one with syncope and two were diagnosed at autopsy.

In six families, at least one relative of the index patient fulfilled the TFC for the diagnosis of ARVC/D. Six index patients (50%) had a first- or second-degree relative with SCD (range 15-55 years).

Figure 4 shows the symptom-free and event-free survival for p.Arg79X mutation carriers; there is no statistically significant difference between men and women. At age 40, only 32% of the mutation carriers (37% of men, 14% of women) had experienced any symptoms; at age 60 this number had increased to 60% (65% of men, 54% of women). Notably, cascade screening identified three mutation carriers aged 70 or over (two males aged 70 and 80, one female aged 87), who had never experienced any symptoms. Heart failure was not a prominent feature in the p.Arg79X mutation carriers.

Immunohistochemical analysis of plakoglobin, based on the use of immunoperoxidase as described by Asimaki *et al*,²⁶ was performed on myocardial samples of patient III:1 from family G39. When compared to that of a myocardial sample of a control heart, a strong decrease of plakoglobin expression at the desmosomes, in both the right and left ventricle, was detected.

The geographical distribution of mutation carriers and the number of PKP2 analyses performed in the Netherlands are shown in Figure 5.

Genetic evaluation

The c.235C>T mutation in exon 2 of *PKP2* was identified in all 12 index patients, resulting at the protein level in a premature stop codon at position 79 (p.Arg79X). The p.Arg79X mutation occurs in 5% of all Dutch patients fulfilling the TFC (data not shown). The segregation of the p.Arg79X mutation was studied in eight families (Figure 3); we found that all family members with definite or probable ARVC/D for whom DNA was available carried the mutation. So far, comprehensive analysis of all five desmosomal genes was performed in six index patients (G01, G06, A01, A04, A25, U2); no additional mutations were found in *DSC2*, *DSG2*, *DSP*, and *JUP* in these patients.

Haplotype analysis

Haplotype analysis revealed a shared haplotype among all p.Arg79X mutation carriers (Table 2). These data strongly suggest that the p.Arg79X mutation originated from a common founder rather than being recurrent. The geographic distribution of the index patients carrying the p.Arg79X mutation in *PKP2* suggests that the mutation originated from the northern region of the Netherlands.

Table 1 Clinical characteristics of ARVC/D probands and family members with the p.Arg79X mutation

Task force criteria for the diagnosis of ARVC/D													
Family	Patient	p.Arg79X	Gender	Age at Onset	Presentation	Structural alteration	Tissue characterisation	Abnormal repolarisation	Abnormal depolarisation	Arrhythmias	Family history	TFC (major/minor)	Follow up, age
G01	III:1	*	M	27y	SCD		++	+	+	+	++	2/3	SCD, 27y
	II:1	*	F	53y	Fam.scr. 48y			++	+	+	++	2/2	
	II:3	*	F		Fam.scr. 50y			++			++	2/0	
	II:4	*	F		Fam.scr. 46y						++	1/0	
	III:3	*	M		Fam.scr. 29y				++		++	2/0	
G06	II:2 *	M	43y	VT				++	++	+	++	3/1	
	II:1 †	F	15y	SCD									SCD, 15y
	II:3 *	F	40y	Fam.scr. 40y				++		+	++	2/1	
G39	I:1 †	M	66y	VT	++					+	++	2/1	Death, 73y
	II:3 *	M	65y	Fam.scr. 48y	+			++			++	1/2	ICD, 66y
	III:1 *	M	21y	SCD	++	++					++	3/0	SCD, 21y
G40	II:1 *	M	56y	VT						++	++	2/0	ICD, 57y
G41	II:3 *	M	28y	VT				++		+	++	2/1	ICD, 39y
	II:2 †	M	29y	VT						+	++	1/1	~ICD, 36y
	III:2 *	M		Fam.scr. 06y							++	1/0	
A01	III:2 *	F	40y	VT	++			++	+	++	++	4/1	
	II:2 ‡	*	F		Fam.scr. 87y						++	1/0	
	II:3 ‡	*	M		Fam.scr. 80y						++	1/0	
A04	III:2 *	M	29y	VT				++		++	++	3/0	ICD, 33y
	II:3 ‡	*	M		Fam.scr. 70y						++	1/0	
A25	II:2 *	M	28y	VT	++					+	++	1/2	ICD, 28y
	II:1 *	F	50y	Syncope				++		+	++	2/1	
	II:3 ¶	†	M		Unknown								Death, 25y
	II:4 *	M		Fam.scr. 54y							++	1/0	
	III:1 *	M		Fam.scr. 31y							++	1/0	
	III:2 ‡	*	M		Fam.scr. 28y						++	1/0	
	III:6 *	F		Fam.scr. 25y							++	1/0	
A43	II:1 *	F	55y	Syncope	++			++		+	++	3/1	
	III:2 *	F		Fam.scr. 34y							++	1/0	
A44	II:4 *	M	25y	VT						+	++	1/1	
	I:2 ¶	*	F		Fam.scr. 84y						++	1/0	
	II:1 †	F	29y	SCD									SCD, 29y
A45	IV:8	*	F	25y	SCD					+	++	1/1	SCD, 25y
	II:1 †	F	51y	SCD									SCD, 51y
	II:2 †	M	46y	SCD									SCD, 46y
	III:1 †	M	20y	SCD									SCD, 20y
	III:4 *	F		Fam.scr. 80y							++	1/0	
	III:8 ¶	*	F		Unknown						++	1/0	Death, 67y

Table 1 Clinical characteristics of ARVC/D probands and family members with the p.Arg79X mutation

Task force criteria for the diagnosis of ARVC/D													
Family	Patient	p.Arg79X	Gender	Age at Onset	Presentation	Structural alteration	Tissue characterisation	Abnormal repolarisation	Abnormal depolarisation	Arrhythmias	Family history	TFC (major/minor)	Follow up, age
A45	III:9	*	M		Fam.scr. 70y					+	++	1/1	
	III:10	†	M	55y	SCD								SCD, 55y
	III:11	*	F		Fam.scr. 67y			++			++	2/0	
	IV:3	*	F		Fam.scr. 54y						++	1/0	
	IV:5	*	M		Fam.scr. 45y						++	1/0	
	IV:6	*	M		Fam.scr. 38y			++			++	2/0	ICD, 38y
	IV:9§	*	F		Unknown						++	1/0	
	IV:11	*	F		Fam.scr. 43y						++	1/0	
U02	II:4	*	M	22y	VT	++	++	++	++	++	++	5/0	SCD, 57y
	II:1	*	F	64y	Fam.scr. 60y	+		++	++	+	++	3/2	ICD, 64y
	II:2	*	M	48y	SCD						++	1/0	SCD, 48y
	III:1	*	F		Fam.scr. 29y				+		++	1/1	
	III:2	*	F		Fam.scr. 26y	++					++	2/0	
	III:4	*	F		Fam.scr. 25y	++				+	++	2/1	

* proven p.Arg79X mutation carrier; † likely p.Arg79X mutation carrier; ‡ asymptomatic, no cardiac examination performed; § no clinical data available; || diagnosed at autopsy; ++ indicates major criterion; +, minor criterion; TFC, number of major/minor criteria respectively; SCD, sudden cardiac death; Fam. scr., family screening; VT, ventricular tachycardia; ICD, implantable cardioverter defibrillator; ~ICD, appropriate ICD discharge.

Index patients are in bold. Family numbers correspond with Figure 3. Only the presence of a feature is indicated. End points are in *italics*.

DISCUSSION

We identified the p.Arg79X mutation in PKP2 in 12 index patients diagnosed with ARVC/D or probable ARVC/D; it is thus one of the most commonly detected PKP2 mutations in the Netherlands. Haplotype analysis strongly suggested a common founder. Gerull et al. identified the same mutation in 6 out of 120 probands of Western European descent, but could not identify shared haplotypes among these patients.¹⁴ In addition, Dalal et al. identified the same mutation in two female ARVC/D patients of North American Caucasian origin, but gave no further information regarding haplotype analysis.^{16,23} These observations suggest that the PKP2 p.Arg79X mutation is recurrent and that a founder effect is present in the Dutch population. A founder effect was also identified for three other PKP2 mutations in the same Dutch cohort (p.Gln133X, p.Cys796Arg, and c.2489+1G>A).¹⁷ However, no other studies have

reported founder mutations, although a few recurrent PKP2 mutations have been identified (e.g. p.Ser50fsX110, p.Val837fsX930, and c.2146-1G>C).¹⁴⁻¹⁷ The fact that other groups might have studied a more heterogeneous population may account for the lack of founder mutations in their cohorts.

Gerull et al. found the p.Arg79X mutation in six male index patients. All had a history of ventricular tachycardias, two had experienced cardiac arrest, but only one had a positive family history.¹⁴ The first patient from North America described by Dalal et al. was a female athlete who presented with syncope at age 28. Cardiac examination revealed mild global RV dilatation, T-wave inversions in leads V1-V3, late potentials on SA-ECG, a left bundle branch block type VT, and >1000 ventricular extrasystoles/24hrs. She had a negative family history.¹⁶ Their second patient was also a female but her age at onset and initial presentation were not reported.²³ In agreement with these observations, we found that nine of our twelve index patients were male and that VTs were present in the majority of cases (9/12). In our cohort, the effect of the p.Arg79X mutation in PKP2 was characterised by a remarkably high clinical variability, typical of ARVC/D; 13% (7/53) of our likely or proven mutation carriers died of SCD before age 30, while 40% did not experience any symptoms at age 60. In the mutation carriers with symptoms, VTs and SCD were prominent, although heart failure was not.

A possible explanation for this high variability may be the co-occurrence of more than one mutation in the desmosomal genes, which has been recognised in up to 8% of ARVC/D patients.^{22,23,27} These mutations can be present in different genes (digenic heterozygosity) or on different alleles of the same gene (compound heterozygosity). Theoretically, digenic or compound heterozygosity could explain the severe end of the phenotypic spectrum of the p.Arg79X mutation carriers. However, we found no second mutation in the six index patients we analysed comprehensively for the five genes encoding desmosomal proteins (in addition to *PKP2*, *DSC2*, *DSG2*, *DSP*, and *JUP*).

Although the number of identified mutations in PKP2 and other ARVC/D-related genes is still rapidly increasing, data on the functional effects at the cellular and molecular level are scarce. For the p.Arg79X mutation in PKP2, however, the consequences of the expression of the mutation have been studied, using neonatal rat ventricular myocytes.²⁸ This showed that the mutant protein failed to localise to the cell membrane, in contrast to endogenous PKP2 and DSP. The major cardiac gap junction protein connexin-43 (Cx43) was also reduced in this model. This was also true for HSP90, a protein that interacts with Cx43 and is known to be essential for the survival of cardiomyocytes.^{29,30} Finally, the expression of p.Arg79X led to the inability of the mutated PKP2 protein to interact with both DSP and Cx43. Together,

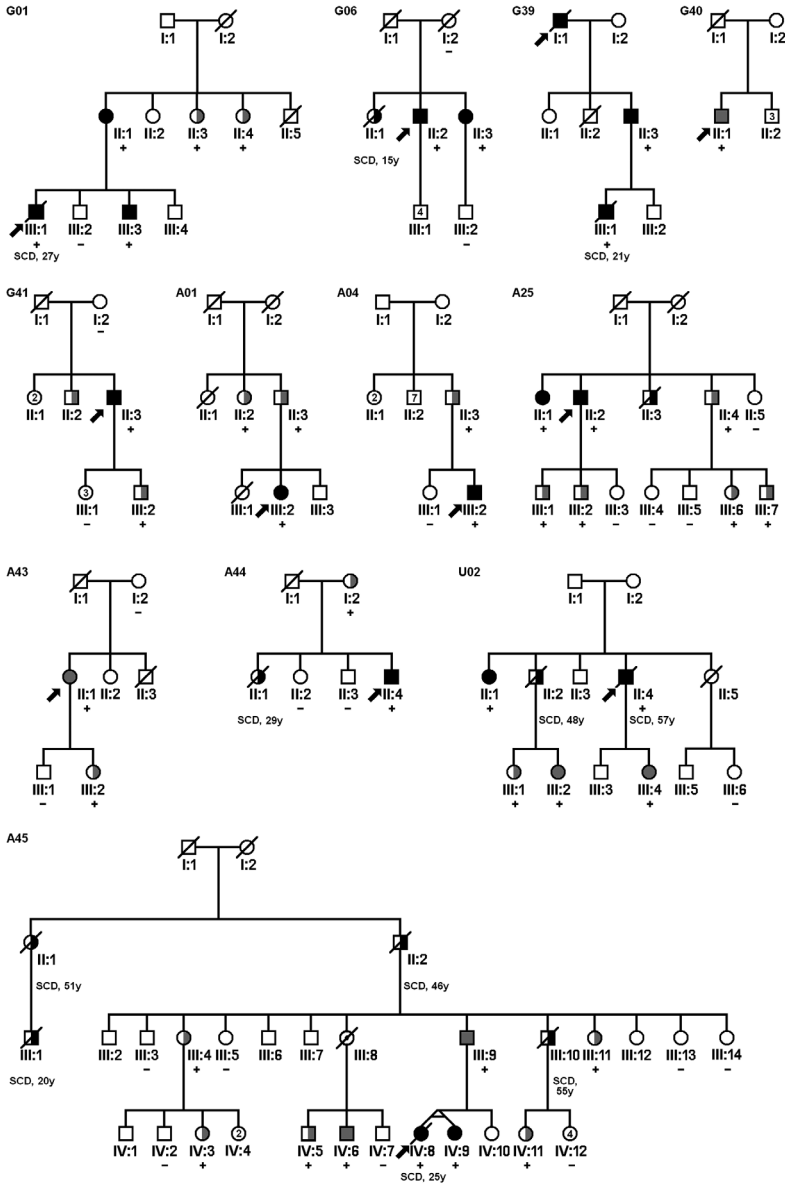

Figure 3 Pedigrees of the 12 families with the p.Arg79X mutation in PKP2. Squares indicate male family members, circles indicate female family members, slashes indicate deceased family members, and arrows indicate index patients. Solid black symbols indicate proven ARVC/D, solid grey symbols indicate probable ARVC/D, half-filled black symbols indicate SCD, half-filled grey symbols indicate mutation carriers identified through family screening, dotted symbols indicate obligate carriers, and open symbols indicate unaffected family members. Genotype results are indicated by (+) = p.Arg79X present and (-) = p.Arg79X absent.

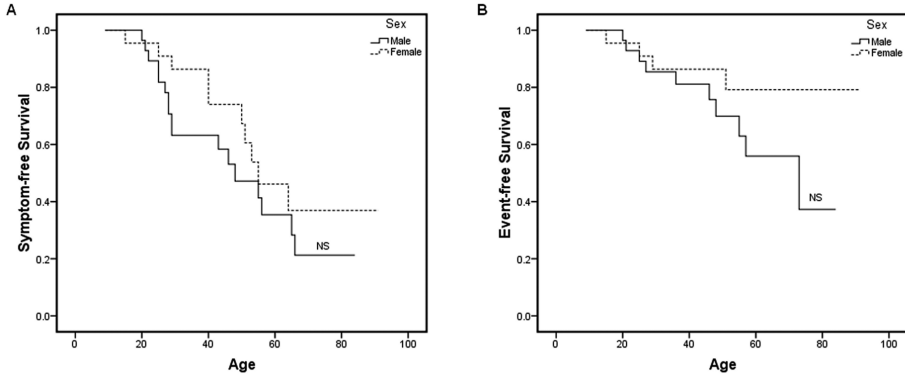

Figure 4 Kaplan-Meier survival analyses of p.Arg79X mutation carriers. (A) Symptom-free survival. (B) Event-free survival. Death due to a cardiac cause and an appropriate ICD-discharge are considered as events. These events as well as ventricular tachycardia and syncope are considered as symptoms.

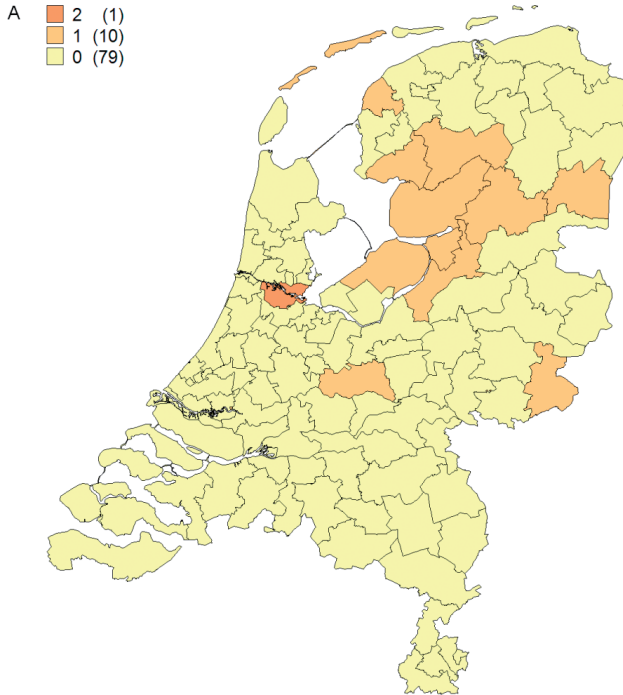

Figure 5A Postal code maps of the Netherlands. Distribution of index patients carrying the p.Arg79X in PKP2 in the Netherlands. The number of p.Arg79X mutation carriers is shown per region (in parenthesis: the number of regions, 90 in total). On average, each region contains 180,000 inhabitants.

Table 2 Haplotype (in grey) associated with the p.Arg79X mutation in the Dutch population

Position	Index patient																							
	G01	G06	G39	G40	G41	A01	A04	A25	A43	A44	A45*	U02												
32.700k	3	5	5	5	1	5	2	5	4	5	5	5	1	5	4	5	2	5	4	5	1	5	4	5
32.830k	2	6	1	6	5	6	4	6	2	6	2	6	7	6	5	6	3	6	7	6	7	6	2	6
c.235C>T	C	T	C	T	C	T	C	T	C	T	C	T	C	T	C	T	C	T	C	T	C	T	C	T
32.940k	1	2	3	2	1	2	3	2	1	2	1	2	1	2	1	2	1	2	1	2	1	2	1	2
32.970k	1	2	5	2	4	2	3	2	3	2	4	2	4	2	4	2	4	2	4	2	4	2	1	2
33.000k	1	2	2	2	1	2	10	2	8	1	4	2	8	2	2	2	2	2	8	2	9	2	6	2

The first column shows the genomic position of the markers and the c.235C>T, p.Arg79X mutation on chromosome 12. For each marker, the shortest haplotype is set at 1. The white and grey columns represent the two inherited haplotypes, one from each parent. Note that the index patient of family G41 has a different allele for the 33.000k marker.

* Haplotype analysed in IV:3 (not the index patient).

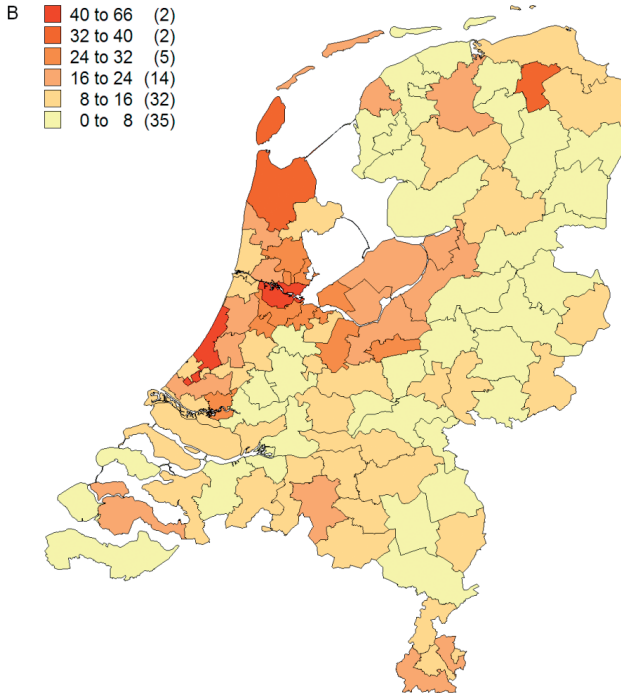

Figure 5B Postal code maps of the Netherlands. Overview of PKP2 analyses in ARVC/D patients in the Netherlands. The number of PKP2 analyses is shown per region (in parenthesis: the number of regions, 90 in total). On average, each region contains 180,000 inhabitants.

these results suggest that the p.Arg79X mutation leads to a loss of myocardial integrity characteristic of ARVC/D.²⁸

Finally, Asimaki et al. showed that immunohistochemical analysis of conventional endomyocardial biopsy samples appears to be both a highly sensitive and specific diagnostic test for ARVC/D, as was demonstrated in a group of 11 ARVC/D patients.²⁶ Reduced immunoreactive signal levels of plakoglobin and Cx43 were found to be a consistent feature in patients with ARVC/D. Although we found reduced signal levels for plakoglobin in one of the p.Arg79X mutation carriers, this was not a consistent finding in another series of patients (data not shown) and further studies are required to establish the possible role of immunohistochemical analysis in patients with ARVC/D.

CONCLUSIONS

In the majority of cases, ARVC/D is caused by mutations in genes encoding desmosomal proteins, especially PKP2. The PKP2 p.Arg79X mutation is a recurrent mutation in Europe and North America. We identified the p.Arg79X mutation in 12 Dutch index patients and showed that they share the same haplotype, strongly suggesting a founder effect in the Dutch population. The PKP2 p.Arg79X mutation carriers comprise the largest series of patients with the same desmosome gene mutation reported so far, and we illustrate that the clinical phenotype is highly variable, varying from SCD to non-penetrance.

Acknowledgements

We would like to thank Pieter Postema for his help in composing the postal code maps of the Netherlands, Ludolf Boven for technical assistance, and Jackie Senior for editing this manuscript. This study was financially supported by the Netherlands Heart Foundation (grants 2003B062, 2007B132 and 2007B139) and the Interuniversity Cardiology Institute of the Netherlands (project 06901).

REFERENCES

1. Marcus FI, Fontaine GH, Guiraudon G, Frank R, Laurenceau JL, Malergue C, Grosgeat Y. Right ventricular dysplasia: a report of 24 adult cases. *Circulation*. 1982;65:384-98.
2. Thiene G, Nava A, Corrado D, Rossi L, Pennelli N. Right ventricular cardiomyopathy and sudden death in young people. *N Engl J Med*. 1988;318:129-33.
3. Calkins H. Arrhythmogenic right-ventricular dysplasia/cardiomyopathy. *Curr Opin Cardiol*. 2006;21:55-63.
4. Marcus FI and Fontaine G. Arrhythmogenic right ventricular dysplasia/cardiomyopathy: a review. *Pacing Clin Electrophysiol*. 1995;18:1298-314.
5. McKenna WJ, Thiene G, Nava A, Fontaliran F, Blomstrom-Lundqvist C, Fontaine G, Camerini F. Diagnosis of arrhythmogenic right ventricular dysplasia/cardiomyopathy. Task Force of the Working Group Myocardial and Pericardial Disease of the European Society of Cardiology and of the Scientific Council on Cardiomyopathies of the International Society and Federation of Cardiology. *Br Heart J*. 1994;71:215-8.
6. Marcus FI, McKenna WJ, Sherrill D, Basso C, Bauce B, Bluemke DA, Calkins H, Corrado D, Cox MG, Daubert JP, Fontaine G, Gear K, Hauer R, Nava A, Picard MH, Protonotarios N, Saffitz JE, Sanborn DM, Steinberg JS, Tandri H, Thiene G, Towbin JA, Tsatsopoulou A, Wichter T, Zareba W. Diagnosis of arrhythmogenic right ventricular cardiomyopathy/dysplasia: proposed modification of the task force criteria. *Circulation*. 2010;121:1533-41.
7. Cox MG, van der Smagt JJ, Noorman M, Wiesfeld AC, Volders PG, van Langen IM, Atsma DE, Dooijes D, Houweling AC, Loh P, Jordaens L, Arens Y, Cramer MJ, Doevendans PA, van Tintelen JP, Wilde AA, Hauer RN. Arrhythmogenic right ventricular dysplasia/cardiomyopathy diagnostic task force criteria: impact of new task force criteria. *Circ Arrhythm Electrophysiol*. 2010;3:126-33.
8. Nava A, Bauce B, Basso C, Muriago M, Rampazzo A, Villanova C, Daliento L, Buja G, Corrado D, Danieli GA, Thiene G. Clinical profile and long-term follow-up of 37 families with arrhythmogenic right ventricular cardiomyopathy. *J Am Coll Cardiol*. 2000;36:2226-33.
9. Hamid MS, Norman M, Quraishi A, Firoozi S, Thaman R, Gimeno JR, Sachdev B, Rowland E, Elliott PM, McKenna WJ. Prospective evaluation of relatives for familial arrhythmogenic right ventricular cardiomyopathy/dysplasia reveals a need to broaden diagnostic criteria. *J Am Coll Cardiol*. 2002;40:1445-50.
10. Peters S, Trummel M, Meyners W. Prevalence of right ventricular dysplasia-cardiomyopathy in a non-referral hospital. *Int J Cardiol*. 2004;97:499-501.
11. Basso C, Corrado D, Marcus FI, Nava A, Thiene G. Arrhythmogenic right ventricular cardiomyopathy. *Lancet*. 2009;373:1289-300.
12. Marcus FI, Zareba W, Calkins H, Towbin JA, Basso C, Bluemke DA, Estes NA, III, Picard MH, Sanborn D, Thiene G, Wichter T, Cannom D, Wilber DJ, Scheinman M, Duff H, Daubert J, Talajic M, Krahn A, Sweeney M, Garan H, Sakaguchi S, Lerman BB, Kerr C, Kron J, Steinberg JS, Sherrill D, Gear K, Brown M, Severski P, Polonsky S, McNitt S. Arrhythmogenic right ventricular cardiomyopathy/dysplasia clinical presentation and diagnostic evaluation: results from the North American Multidisciplinary Study. *Heart Rhythm*. 2009;6:984-92.
13. Rampazzo A, Nava A, Malacrida S, Beffagna G, Bauce B, Rossi V, Zimbello R, Simonati B, Basso C, Thiene G, Towbin JA, Danieli GA. Mutation in human desmoplakin domain binding to plakoglobin causes a dominant form of arrhythmogenic right ventricular cardiomyopathy. *Am J Hum Genet*. 2002;71:1200-6.

14. Gerull B, Heuser A, Wichter T, Paul M, Basson CT, McDermott DA, Lerman BB, Markowitz SM, Ellinor PT, MacRae CA, Peters S, Grossmann KS, Drenckhahn J, Michely B, Sasse-Klaassen S, Birchmeier W, Dietz R, Breithardt G, Schulze-Bahr E, Thierfelder L. Mutations in the desmosomal protein plakophilin-2 are common in arrhythmogenic right ventricular cardiomyopathy. *Nat Genet.* 2004;36:1162-4.
15. Syrris P, Ward D, Asimaki A, Sen-Chowdhry S, Ebrahim HY, Evans A, Hitomi N, Norman M, Pantazis A, Shaw AL, Elliott PM, McKenna WJ. Clinical expression of plakophilin-2 mutations in familial arrhythmogenic right ventricular cardiomyopathy. *Circulation.* 2006;113:356-64.
16. Dalal D, Molin LH, Piccini J, Tichnell C, James C, Bomma C, Prakasa K, Towbin JA, Marcus FI, Spevak PJ, Bluemke DA, Abraham T, Russell SD, Calkins H, Judge DP. Clinical features of arrhythmogenic right ventricular dysplasia/cardiomyopathy associated with mutations in plakophilin-2. *Circulation.* 2006;113:1641-9.
17. Van Tintelen JP, Entius MM, Bhuiyan ZA, Jongbloed R, Wiesfeld AC, Wilde AA, van der Smagt J, Boven LG, Mannens MM, van Langen IM, Hofstra RM, Otterspoor LC, Doevendans PA, Rodriguez LM, van Gelder IC, Hauer RN. Plakophilin-2 mutations are the major determinant of familial arrhythmogenic right ventricular dysplasia/cardiomyopathy. *Circulation.* 2006;113:1650-8.
18. Heuser A, Plovie ER, Ellinor PT, Grossmann KS, Shin JT, Wichter T, Basson CT, Lerman BB, Sasse-Klaassen S, Thierfelder L, MacRae CA, Gerull B. Mutant desmocollin-2 causes arrhythmogenic right ventricular cardiomyopathy. *Am J Hum Genet.* 2006;79:1081-8.
19. Pilichou K, Nava A, Basso C, Beffagna G, Bauce B, Lorenzon A, Frigo G, Vettori A, Valente M, Towbin J, Thiene G, Danieli GA, Rampazzo A. Mutations in desmoglein-2 gene are associated with arrhythmogenic right ventricular cardiomyopathy. *Circulation.* 2006;113:1171-9.
20. Asimaki A, Syrris P, Wichter T, Matthias P, Saffitz JE, McKenna WJ. A novel dominant mutation in plakoglobin causes arrhythmogenic right ventricular cardiomyopathy. *Am J Hum Genet.* 2007;81:964-73.
21. Sen-Chowdhry S, Syrris P, McKenna WJ. Role of genetic analysis in the management of patients with arrhythmogenic right ventricular dysplasia/cardiomyopathy. *J Am Coll Cardiol.* 2007;50:1813-21.
22. Bhuiyan ZA, Jongbloed JD, van der Smagt J, Lombardi PM, Wiesfeld AC, Nelen M, Schouten M, Jongbloed R, Cox MG, van Wolferen M, Rodriguez LM, van Gelder IC, Bikker H, Suurmeijer AJ, van den Berg MP, Mannens MM, Hauer RN, Wilde AA, van Tintelen JP. Desmoglein-2 and desmocollin-2 mutations in Dutch arrhythmogenic right ventricular dysplasia/cardiomyopathy patients: Results from a multicenter study. *Circ Cardiovasc Genet.* 2009;2:418-27.
23. Den Haan AD, Tan BY, Zikusoka MN, Llado LI, Jain R, Daly A, Tichnell C, James C, Amat-Alarcon N, Abraham T, Russell SD, Bluemke DA, Calkins H, Dalal D, Judge DP. Comprehensive desmosome mutation analysis in North Americans with arrhythmogenic right ventricular dysplasia/cardiomyopathy. *Circ Cardiovasc Genet.* 2009;2:428-35.
24. Van Tintelen JP, Hofstra RM, Wiesfeld AC, van den Berg MP, Hauer RN, Jongbloed JD. Molecular genetics of arrhythmogenic right ventricular cardiomyopathy: emerging horizon? *Curr Opin Cardiol.* 2007;22:185-92.
25. Van der Zwaag PA, Jongbloed JD, van den Berg MP, van der Smagt JJ, Jongbloed R, Bikker H, Hofstra RM, van Tintelen JP. A genetic variants database for arrhythmogenic right ventricular dysplasia/cardiomyopathy. *Hum Mutat.* 2009;30:1278-83.
26. Asimaki A, Tandri H, Huang H, Halushka MK, Gautam S, Basso C, Thiene G, Tsatsopoulou A, Protonotarios N, McKenna WJ, Calkins H, Saffitz JE. A new diagnostic test for arrhythmogenic right ventricular cardiomyopathy. *N Engl J Med.* 2009;360:1075-84.

27. Xu T, Yang Z, Vatta M, Rampazzo A, Beffagna G, Pilichou K, Scherer SE, Saffitz J, Kravitz J, Zareba W, Danieli GA, Lorenzon A, Nava A, Bauce B, Thiene G, Basso C, Calkins H, Gear K, Marcus F, Towbin JA, Multidisciplinary Study of Right Ventricular Dysplasia Investigators. Compound and digenic heterozygosity contributes to arrhythmogenic right ventricular cardiomyopathy. *J Am Coll Cardiol*. 2010;55:587-97.
28. Joshi-Mukherjee R, Coombs W, Musa H, Oxford E, Taffet S, Delmar M. Characterization of the molecular phenotype of two arrhythmogenic right ventricular cardiomyopathy (ARVC)-related plakophilin-2 (PKP2) mutations. *Heart Rhythm*. 2008;5:1715-23.
29. Yun BG and Matts RL. Differential effects of Hsp90 inhibition on protein kinases regulating signal transduction pathways required for myoblast differentiation. *Exp Cell Res*. 2005;307:212-23.
30. Rodriguez-Sinovas A, Boengler K, Cabestrero A, Gres P, Morente M, Ruiz-Meana M, Konietzka I, Miro E, Totzeck A, Heusch G, Schulz R, Garcia-Dorado D. Translocation of connexin 43 to the inner mitochondrial membrane of cardiomyocytes through the heat shock protein 90-dependent TOM pathway and its importance for cardioprotection. *Circ Res*. 2006;99:93-101.

5

A genetic variants database for arrhythmogenic right ventricular dysplasia/cardiomyopathy

Paul A. van der Zwaag
Jan D.H. Jongbloed
Maarten P. van den Berg
Jasper J. van der Smagt
Roselie Jongbloed
Hennie Bikker
Robert M.W. Hofstra
J. Peter van Tintelen

ABSTRACT

Arrhythmogenic right ventricular dysplasia/cardiomyopathy (ARVD/C) is a hereditary cardiac disease, characterised by fibrofatty replacement of cardiomyocytes, ventricular tachyarrhythmias and premature sudden cardiac death. Mutations in genes encoding desmosomal proteins are the major cause of ARVD/C, yet the pathogenicity of identified variants is not always clear. We have therefore created an online database (<http://www.arvcdatabase.info>), providing information on variants in ARVD/C-associated genes.

We searched the literature using ARVD/C and its underlying genes (*DSC2*, *DSG2*, *DSP*, *JUP*, *PKP2*, *TGFB3*, *TMEM43*, *TP63*) as keywords. From the selected papers and our unpublished data, we collected details on the type of mutation and the information provided at the genetic and protein level. Entries are linked to a “details page” containing clinical data and the referred publication(s). To aid the interpretation of the effect of missense mutations, we provide data obtained from in silico prediction methods.

In May 2009 the ARVD/C database contained 481 variants in 8 genes, from 57 papers and abstracts. Of these, 144 variants are considered pathogenic, 73 are considered unknown/unclassified variants, and 264 have no known pathogenicity. Data can be added online. The database is converted into the Leiden Open Variation Database (LOVD) format, a tool for gene-centred collection and display of DNA variations.

The ARVD/C database will be useful for both researchers and clinicians. The database can be easily searched to determine if variants have been published and whether they are considered to be pathogenic. External users are invited to add information to improve the quantity and quality of the data entered.

INTRODUCTION

Arrhythmogenic right ventricular dysplasia/cardiomyopathy (ARVD/C) is a hereditary cardiac disease, generally characterised by fibrofatty replacement of cardiomyocytes, primarily in the right ventricle.^{1,2} The resulting disruption of normal myocardial architecture in ARVD/C patients can result in ventricular tachyarrhythmias, presenting as palpitations or syncope and sudden cardiac death (SCD) at a relatively young age.^{2,4} The clinical diagnosis of ARVD/C is based upon criteria proposed by an international task force in 1994.⁵ ARVD/C is a heterogeneous disease, marked by variable expression and incomplete penetrance that is usually transmitted as an autosomal dominant trait, although autosomal recessive transmission has been described.^{6,7}

In 2002, the first mutation causing non-syndromal ARVD/C was reported by Rampazzo *et al*:⁸ a mutation in the desmoplakin gene (*DSP*; MIM# 125647), encoding a component of the desmosome. It was however only after a breakthrough article by Gerull *et al*, describing 25 mutations in the cardiac desmosomal gene plakophilin 2 (*PKP2*; MIM# 602861),⁹ that the desmosome complex was considered the major structure in the cell which, when mutated, might cause ARVD/C (for a schematic representation of the desmosome complex see Figure 1). Many groups

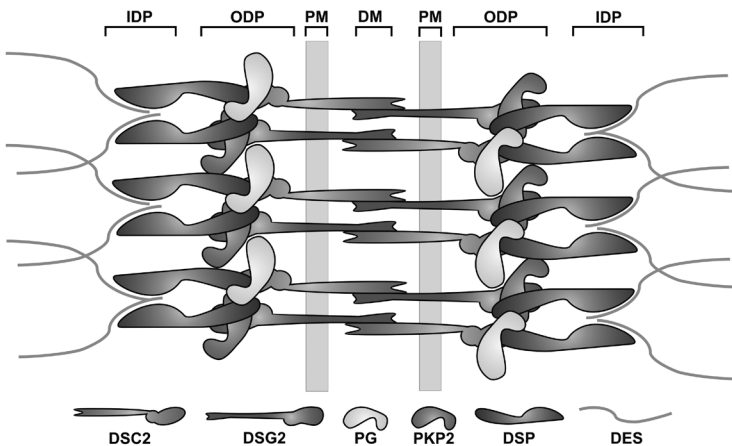

Figure 1 Schematic representation of the molecular organisation of cardiac desmosomes. A model of the relative organisation of major desmosome components is presented. The plasma membrane-bound (PM) desmocollin 2 (DSC2) and desmoglein 2 (DSG2) proteins interact via their extracellular domains at the dense midline (DM) in the extracellular space between adjacent cells. Their cytoplasmic domains interact with plakoglobin (PG) and plakophilin 2 (PKP2) in the outer dense plaque (ODP). Also in the ODP, PKP2 and PG interact with the N-terminal domain of desmoplakin (DSP). The C-terminus of desmoplakin anchors intermediate filaments, mainly desmin (DES), at the inner dense plaque (IDP).²⁰ See colour figure on page 18.

started screening genes encoding desmosome associated proteins and as a result, more putative disease-causing mutations in *PKP2* and *DSP*,¹⁰⁻¹⁴ as well as in the other desmosomal genes, desmocollin 2 (*DSC2*; MIM# 125645), desmoglein 2 (*DSG2*; MIM# 125671) and plakoglobin (*JUP*; MIM# 173325), were identified in patients with non-syndromal ARVD/C.¹⁵⁻¹⁹ Although ARVD/C is now considered to be a disorder of the cardiac desmosome,²⁰ some non-desmosomal genes have also been associated with ARVD/C. Mutations in both the 5' and 3' untranslated region (UTR) of the transforming growth factor β 3 gene (*TGFB3*; MIM# 190230), a mutation in the transmembrane protein 43 encoding gene (*TMEM43*; MIM# 612048), and a mutation in the tumour protein p63 gene (*TP63*; MIM# 603273) have been identified in families with ARVD/C.²¹⁻²³ In addition, mutations in the ryanodine receptor 2 gene (*RYR2*; MIM# 180902) were described in eight families with catecholaminergic polymorphic ventricular tachycardia (CPVT) and a highly penetrant form of ARVD/C.^{24,25} Whether this form of CPVT should be considered a primary form of ARVD/C remains the subject of debate.^{26,27} Furthermore, several linkage analyses identified loci not containing the above genes, but the causative gene has not been identified in the respective regions yet.²⁸⁻³¹

At present, over 140 disease-causing ARVD/C mutations have been published, the vast majority in genes encoding desmosomal proteins. Frameshift and nonsense mutations resulting in a premature stop codon and splice site mutations leading to aberrant splice products, found in patients with or suspected of having ARVD/C, are generally considered to be pathogenic. These types of mutations are often found in the major gene underlying ARVD/C, namely *PKP2*.^{9,13} In addition, many of the reported missense mutations are classified as pathogenic, though functional studies supporting these claims are often lacking. This classification is generally based on several criteria, such as the differences in physical and chemical properties of the amino acids involved in the respective substitution, the evolutionary conservation across several species of the particular amino acid and/or the region surrounding it, the localisation within a functionally important domain or in one that is predicted to be important, the absence of the respective mutation in control chromosomes, and (when known) cosegregation of the mutation with the disease in affected families. Notably, non-synonymous single nucleotide polymorphisms (SNPs) have been identified in the coding regions of all the genes known in ARVD/C.

Judging the putative pathogenic nature of missense mutations forms an important challenge for researchers worldwide. Because of clinical variability and age-dependent penetrance, as well as the absence of functional studies, the correct interpretation of the pathogenicity of such variants is difficult. However, establishing a clear classification will have important implications, since it will provide the possibility of cascade screening in family members, thereby identifying non-carriers

who can be dismissed from frequent cardiological follow-up. In addition, identifying a pathogenic mutation may help to correctly classify the clinical phenotype in equivocal cases, which are not unusual in ARVD/C. To facilitate the interpretation of variants, we have built a freely accessible online database, the ARVD/C Genetic Variants Database (www.arvcdatabase.info), containing all published variants in genes known to cause ARVD/C, as well as unpublished variants identified in our institute or in participating centres. Our publicly accessible database will greatly aid in verifying whether a certain mutation has been detected and/or published before and how it has been classified by others. It also provides the opportunity of online data submission to improve the quality and quantity of the data entered.

DATABASE STRUCTURE

We searched the literature in Entrez PubMed (www.ncbi.nlm.nih.gov/sites/entrez) using ARVD/C and its underlying genes (*DSC2*, *DSG2*, *DSP*, *JUP*, *PKP2*, *TGFB3*, *TMEM43*, *TP63*) as search terms. For a complete list of search terms used, see the website (www.arvcdatabase.info/general/searchterms.aspx). We only selected articles published in English and searched the listed references for additional relevant papers. In addition, we searched the abstracts from the scientific sessions of the American Heart Association and the congresses of the European Society of Cardiology since 2005. If the same results were published in both an abstract and an article, we have only referred to the article in our database. From the selected papers and abstracts we gathered mutation details, information at the gene level (the DNA change, exon and codon number) and at the protein level (the amino acid change, domain (if available), the type of mutation (deletion and/or insertion (frame shift), intronic, missense, nonsense, splice site, synonymous, untranslated region) and reported classification (pathogenic, unknown/unclassified variant or no known pathogenicity) of each mutation), as provided by the authors. All entries are linked to a details page, where additional clinical and functional data (if available) can be found, such as whether patients fulfil the task force criteria for the diagnosis of ARVD/C, if compound genotypes are present, as well as the frequency of identified variants in control chromosomes. All patient data have been extracted from published articles or articles submitted by our own group. Mutation names used are according to the nomenclature proposed by the Human Genome Variation Society (www.hgvs.org/mutnomen).³² Mutations are numbered according to the reference sequences (+1 = A of ATG) as listed in GenBank (www.ncbi.nlm.nih.gov/GenBank): *NM_024422* for *DSC2*, *NM_001943* for *DSG2*, *NM_004415* for *DSP*, *NM_021991* for *JUP*, *NM_004572* for *PKP2*, *NM_003239* for *TGFB3*, *NM_024334* for *TMEM43*, and

NM_003722 for TP63. To add known polymorphisms to the database we searched dbSNP (www.ncbi.nlm.nih.gov/SNP) to identify SNPs in the desmosomal genes and *TGFB3*, *TMEM43* and *TP63*. We selected all SNPs in coding regions and those in non-coding regions lying within 100 bases from the exon-intron boundaries of coding regions.

The classification of variants in our database is documented from the information published and the responsibility therefore remains with the respective authors, not with the curators. We have also provided the results of *in silico* prediction methods for the pathogenicity of all published missense variants, *i.e.* the Grantham score,³³ PolyPhen,³⁴ and SIFT.³⁵

The data thus collected were stored first in individual fields in an offline Microsoft Excel (Microsoft, Redmond, WA) worksheet. Porting to an online environment and interface programming have been described earlier.³⁶ A duplicate of our database is converted into the Leiden Open Variation Database (LOVD) format (www.lovd.nl/arvc), a gene-centred database platform which focuses on the collection and display of DNA sequence variations.³⁷

DATABASE FEATURES

On May 8th 2009, the database contained 481 variants from 8 different genes (41 for *DSC2*, 76 for *DSG2*, 131 for *DSP*, 26 for *JUP*, 124 for *PKP2*, 23 for *TGFB3*, 28 for *TMEM43* and 32 for *TP63*). The different reported classifications per type of mutation are listed in Table 1.

The database can be consulted at www.arvcdatabase.info through a user-friendly interface. The search result can be selected per gene, reported classification, mutation type and number per page. The results are automatically sorted by gene, but custom sorting is available. The number of clinical reports describing a specific variant is displayed for each variant. If a variant is only documented in dbSNP, the number of clinical reports is given as '0'. Currently, 57 articles and abstracts are cited, containing 289 reports of and identifying 191 different variants. All cited references are listed with a link to the variant(s) described, as well as a link to the corresponding PubMed entry. Another 107 unpublished variants are added to our database. Clicking the 'Show Details' link results in the display of a details page, as shown in Figure 2.

The database will be updated with data from new articles from Entrez PudMed search results using the search terms as listed on the website, which are automatically updated and emailed to the curators. Updates to the database will be reported on the homepage ("News") and are stored in the news archive. This feature is

Table 1 Number of different types of variants per reported classification^a

Variant	Reported Classification			Total
	Pathogenic	Unclassified Variant	No known pathogenicity	
Insertion/deletion	44	1	5	50
Intronic	-	1	134	135
Missense	52	44	60	156
Nonsense	27	-	-	27
Splice Site	19	-	-	19
Synonymous	- ^b	24	50	74
Untranslated region	2	3	15	20
Total	144	73	264	481

^a All variants in the 8 genes (*DSC2*, *DSG2*, *DSP*, *JUP*, *PKP2*, *TGFB3*, *TMEM43*, *TP63*) entered in the database on May 8th 2009 are listed in the table.

^b The *PKP2* mutation p.Gly828Gly, which appears to be a synonymous variant, is in fact a cryptic splice mutation.⁶³ It is therefore classified as a pathogenic splice site mutation.



University Medical Center Groningen

[Login](#)

Department of Genetics - Cardiogenetics Research Group

SEARCH DATABASE	SUBMIT DATA	CONTACT US	UMCG GENETICS	REFERENCES	FORUM	OTHER
---------------------------------	-----------------------------	----------------------------	-------------------------------	----------------------------	-----------------------	-----------------------

Details of mutation PKP2:S140F



Gene	Mutation	DNA change	Protein change	Exon	Locus	Type	Reported Classification	Grantham Score	SIFT	PolyPhen	Domain	LOVD ID
PKP2	S140F	c.419C>T	p.Ser140Phe	3	12p11	Missense	Pathogenic	155	Tolerated	Benign	N-terminus	PKP2_00018

Clinical reports of this mutation in patients and controls

Article	Controls	Patient	# Affected Relatives	Notes
Dalal et al. Journal of the American College of Cardiology 2009;53:1289-99.	0/0	TFC+	1	Proband: digenic and compound heterozygote: PKP2 S140F, PKP2 c.2146-1G>C and DSG2 V56M. Offspring has different combinations of two of these mutations
Sen-Chowdhry et al. Journal of the American College of Cardiology 2008;52:2175-87.	0/0	LDAC	0	Proposed criteria for incorporation in new TFC
Wlodarska et al. European Heart Journal 2008;29(Suppl):163.	0/200	TFC+		
Koopmann et al. Heart Rhythm 2007;4:752-5.	1/76	BS		reported as polymorphism; 38 Brugada syndrome probands were studied, i.e. not healthy controls.
Dalal et al. Circulation 2006;113:1641-9.	0/0	TFC+		
Svrris et al. Circulation 2006;113:356-64.	0/400	TFC+	3	
Gerull et al. Nature Genetics 2004;36:1162-4.	0/500	TFC+		

SNP reports

No SNP reports found.

Figure 2 The 'details' page for the *PKP2* variant p.Ser140Phe. In addition to the search result list, the articles reporting this variant, with a link to their corresponding PubMed entry, information about the frequency of the mutation in healthy controls, whether reported patient(s) fulfil task force criteria (notably, LDAC = left-dominant arrhythmogenic cardiomyopathy), the number of affected relatives, and additional information (notes) are listed. Colour figure can be viewed in the online version.

exemplified by the recent discussion on the pathogenicity of the p.Glu713Lys mutation in *DSG2*, published online in *Nat Clin Pract Cardiovasc Med* (see also below in the discussion section).^{7,38} The curators can add new data to the database through different editing tools, while external users can use an online submission form to

report findings. Submissions will be checked by the curators and completed if necessary. Although most entered data originates from peer-reviewed papers or dbSNP, unpublished data will be added to the database. These unpublished entries are variants identified in the curators' department and/or other participating centres, and are clearly labelled as such. Adding these unpublished variants to the database will provide users with the opportunity to check if a variant has been found in another laboratory. Contributors of unpublished data can be contacted via the curators of the database.

DISCUSSION

We have constructed a publicly accessible database containing genotype and phenotype data on variants found in genes known to cause ARVD/C. For clinicians the database can be used to assist the counselling of families with a detected variant, since it provides information on whether a certain variant has been classified as potentially pathogenic. In addition, we have provided *in silico* prediction methods to help in judging reported missense mutations, although these methods can yield contradictory results and are therefore not very reliable if there is no other evidence.³⁹ In the absence of other arguments or functional analyses, these programs should not be used to decide whether a sequence variation found in a patient underlies the respective disease, since the consequences of an erroneous prediction may be disastrous from the perspective of genetic counselling.⁴⁰

In principle, our database provides the reported classification of a mutation as indicated in the original article, however, the classification may change over time, as the result of information from new studies and reports. For example, recently two responses to a review article questioned the pathogenicity of a total of four missense mutations identified in *DSG2*.^{7,38,41-43} Following these publications we changed the reported classification of the p.Val158Gly, p.Glu713Lys and p.Val920Gly variants from 'pathogenic' to 'no known pathogenicity' and of the p.Val56Met variant from 'pathogenic' to 'unknown/unclassified variant'. These changes are traceable in the details page, including the new references. The reverse action is exemplified by the case described below. Bauce et al. reported a pathogenic mutation in *DSP*, p.Arg1775Ile, in a 37-year old woman diagnosed with ARVD/C based upon ECG alterations, a syncopal episode five years later with loss of consciousness (on sotalol therapy), and a recording of sustained ventricular tachycardia. The mutation was detected in three asymptomatic family members but not found in 200 control chromosomes.¹⁰ The same mutation is also reported in dbSNP (rs34738426), but

without population frequencies or validation data. Following the authors, our database reports this mutation as ‘pathogenic’.

The fact that ARVD/C is considered a desmosome cardiomyopathy is clearly reflected by the large number of desmosome gene variants in the database (397/480; 83%).²⁰ Moreover, from a total of 143 putative pathogenic mutations, 70 (49%) are reported in *PKP2*. These current figures are biased by the fact that, after the identification of many mutations in *PKP2*, we and others focussed the hunt for causative mutations in ARVD/C patients on desmosome or desmosome-related genes in particular. These figures might well need to be adjusted when novel ARVD/C-related but non-desmosomal genes, for example those in known ARVD/C loci, are identified and screened for mutations. An overview of all desmosomal gene variants and their distribution among the different genes is shown in Figure 3.

Syndromal ARVD/C, caused by mutations in the desmosomal genes *DSP* and *JUP*, have been described as Carvajal and Naxos syndromes, respectively;⁴⁴⁻⁴⁸ both are considered to be inherited in an autosomal recessive fashion.⁴⁹ Mutations in *TP63* are associated with several syndromes, with ectodermal dysplasia, orofacial clefting and limb malformations as the key characteristics.⁵⁰ However, putative

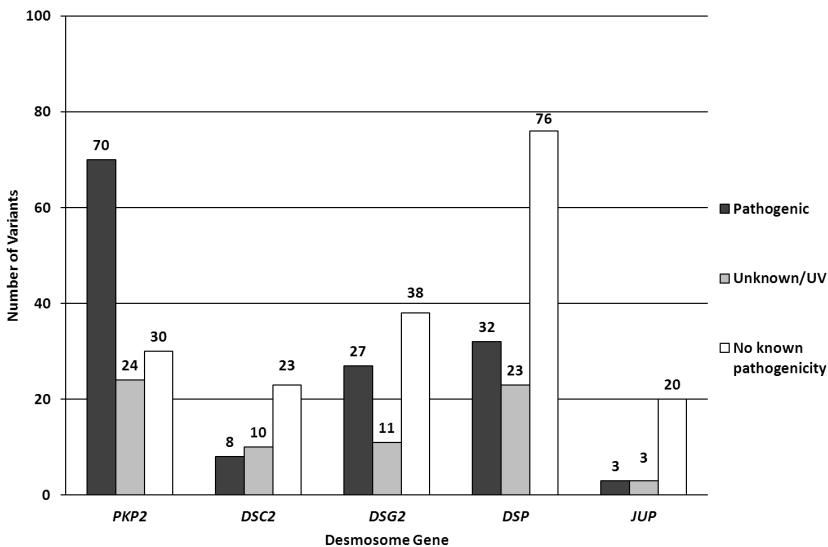

Figure 3 Distribution of desmosome variants in ARVD/C patients, sorted by reported classification.

syndromal ARVD/C caused by a mutation in *TP63* has been described once.²³ In our database we have included only those mutations causing syndromal forms that include ARVD/C or dilated cardiomyopathy and those causing non-syndromal ARVD/C.

Following an initial report of 24 cases of right ventricular dysplasia,¹ arrhythmogenic cardiomyopathy was originally considered a disorder of the right ventricle. Post-mortem studies have shown biventricular involvement⁵¹ and currently left ventricular involvement is increasingly being recognised, including forms with predominant left ventricular involvement. This is also referred to as left dominant arrhythmogenic cardiomyopathy and is often due to mutations in *DSP*.^{10,52-54} These mutations have also been incorporated into our database.

The co-occurrence of more than one mutation in desmosomal genes has been recognised, with different mutations being present in the same gene (compound heterozygosity) as well as in different genes (digenic inheritance).^{13,17,18,41,55-58} These compound genotypes have been documented in the database on the “details page” of the relevant mutations.

In a large cohort from Newfoundland, Canada, a missense mutation in *TMEM43* was recently identified.²² The form of ARVD/C in this cohort is characterised by complete penetrance of the disease, in men at the age of 63 and in women at the age of 76 years. Left ventricular enlargement was often a presenting feature. The authors hypothesised that dysregulation of the expression of the *TMEM43* gene, which contains a response element for PPAR γ (an adipogenic transcription factor), may explain the fibrofatty replacement of myocardium in the ARVD/C patients in this cohort. So far, no other pathogenic mutations in *TMEM43* have been reported.

We decided not to include the *RYR2* mutations in our database because of the debatable and specific clinical entity, including catecholaminergic polymorphic ventricular tachycardia (CPVT). A database containing mutations in CPVT and other inherited arrhythmias can be consulted at www.fsm.it/cardmoc.

Although over 100 pathogenic desmosomal mutations have been reported in ARVD/C, studies concerning the functional and structural consequences of specific mutations are rare. Kaplan et al. published two studies on syndromal ARVD/C caused by homozygous deletions in *DSP* and *JUP*, respectively.^{59,60} More recently, two studies on functional and structural effects of three frameshift, two missense and one nonsense *PKP2* mutation were published.^{61,62} Functional analyses are particularly valuable when the pathogenicity of missense mutations is considered, since these mutations, most likely, do not result in haploinsufficiency due to nonsense-mediated mRNA decay and/or the production of a truncated protein. When more functional data becomes available, we will include this in our database, providing new evidence for the classification of the mutation(s) studied.

Establishing the pathogenicity of a mutation is very important for the diagnosis of ARVD/C especially, since variable expression and non-penetrance are both hallmarks of the disease. The detection of a pathogenic mutation in a proband diagnosed with ARVD/C has important implications for the family members. Cascade screening will result in the identification of mutation carriers, enabling timely diagnosis and facilitating subsequent prevention of complications and reducing morbidity and mortality. Possible interventions are lifestyle changes, such as avoiding strenuous exercise, drug administration, and placing of an implantable cardioverter defibrillator (ICD). An extra advantage is that excluding a pathogenic mutation in other family members will allow them to be dismissed from regular cardiological follow-up.²⁰

CONCLUSION

We have created an online database containing all the known variants published in genes related to ARVD/C. Although the emphasis lies on desmosomal genes, mutations in non-desmosomal genes have been added to our database. Researchers and clinicians now have the possibility to quickly verify whether their mutation of interest has been published or identified elsewhere but unpublished and whether it is considered to be pathogenic. We would therefore encourage researchers to add their unpublished data to our database. The classification of a mutation and the sharing of these data have important clinical implications for both the proband and family members. These data may also lead to new insights into the molecular mechanisms underlying ARVD/C, thereby benefiting both clinicians and researchers.

Acknowledgements

We thank Jan Herman Veldkamp (www.aardworm.com) for help in developing this website and Jackie Senior for editing this manuscript. The work on this database was made possible by a grant from the Netherlands Heart Foundation (2007B132).

REFERENCES

1. Marcus FI, Fontaine GH, Guiraudon G, Frank R, Laurenceau JL, Malergue C, Grosgeat Y. Right ventricular dysplasia: a report of 24 adult cases. *Circulation*. 1982;65:384-98.
2. Thiene G, Nava A, Corrado D, Rossi L, Pennelli N. Right ventricular cardiomyopathy and sudden death in young people. *N Engl J Med*. 1988;318:129-33.
3. Marcus FI and Fontaine G. Arrhythmogenic right ventricular dysplasia/cardiomyopathy: a review. *Pacing Clin Electrophysiol*. 1995;18:1298-314.
4. Calkins H. Arrhythmogenic right-ventricular dysplasia/cardiomyopathy. *Curr Opin Cardiol*. 2006;21:55-63.
5. McKenna WJ, Thiene G, Nava A, Fontaliran F, Blomstrom-Lundqvist C, Fontaine G, Camerini F. Diagnosis of arrhythmogenic right ventricular dysplasia/cardiomyopathy. Task Force of the Working Group Myocardial and Pericardial Disease of the European Society of Cardiology and of the Scientific Council on Cardiomyopathies of the International Society and Federation of Cardiology. *Br Heart J*. 1994;71:215-8.
6. Hamid MS, Norman M, Quraishi A, Firoozi S, Thaman R, Gimeno JR, Sachdev B, Rowland E, Elliott PM, McKenna WJ. Prospective evaluation of relatives for familial arrhythmogenic right ventricular cardiomyopathy/dysplasia reveals a need to broaden diagnostic criteria. *J Am Coll Cardiol*. 2002;40:1445-50.
7. Awad MM, Calkins H, Judge DP. Mechanisms of disease: molecular genetics of arrhythmogenic right ventricular dysplasia/cardiomyopathy. *Nat Clin Pract Cardiovasc Med*. 2008;5:258-67.
8. Rampazzo A, Nava A, Malacrida S, Beffagna G, Bauce B, Rossi V, Zimbello R, Simionati B, Basso C, Thiene G, Towbin JA, Danieli GA. Mutation in human desmoplakin domain binding to plakoglobin causes a dominant form of arrhythmogenic right ventricular cardiomyopathy. *Am J Hum Genet*. 2002;71:1200-6.
9. Gerull B, Heuser A, Wichter T, Paul M, Basson CT, McDermott DA, Lerman BB, Markowitz SM, Ellinor PT, MacRae CA, Peters S, Grossmann KS, Drenckhahn J, Michely B, Sasse-Klaassen S, Birchmeier W, Dietz R, Breithardt G, Schulze-Bahr E, Thierfelder L. Mutations in the desmosomal protein plakophilin-2 are common in arrhythmogenic right ventricular cardiomyopathy. *Nat Genet*. 2004;36:1162-4.
10. Bauce B, Basso C, Rampazzo A, Beffagna G, Daliento L, Frigo G, Malacrida S, Settimo L, Danieli G, Thiene G, Nava A. Clinical profile of four families with arrhythmogenic right ventricular cardiomyopathy caused by dominant desmoplakin mutations. *Eur Heart J*. 2005;26:1666-75.
11. Syrris P, Ward D, Asimaki A, Sen-Chowdhry S, Ebrahim HY, Evans A, Hitomi N, Norman M, Pantazis A, Shaw AL, Elliott PM, McKenna WJ. Clinical expression of plakophilin-2 mutations in familial arrhythmogenic right ventricular cardiomyopathy. *Circulation*. 2006;113:356-64.
12. Dalal D, Molin LH, Piccini J, Tichnell C, James C, Bomma C, Prakasa K, Towbin JA, Marcus FI, Spevak PJ, Bluemke DA, Abraham T, Russell SD, Calkins H, Judge DP. Clinical features of arrhythmogenic right ventricular dysplasia/cardiomyopathy associated with mutations in plakophilin-2. *Circulation*. 2006;113:1641-9.
13. Van Tintelen JP, Entius MM, Bhuiyan ZA, Jongbloed R, Wiesfeld AC, Wilde AA, van der Smagt J, Boven LG, Mannens MM, van Langen IM, Hofstra RM, Otterspoor LC, Doevendans PA, Rodriguez LM, van Gelder IC, Hauer RN. Plakophilin-2 mutations are the major determinant of familial arrhythmogenic right ventricular dysplasia/cardiomyopathy. *Circulation*. 2006;113:1650-8.
14. Antoniadis L, Tsatsopoulou A, Anastasakis A, Syrris P, Asimaki A, Panagiotakos D, Zambartas C, Stefanadis C, McKenna WJ, Protonotarios N. Arrhythmogenic right ventricular cardiomyopathy

- caused by deletions in plakophilin-2 and plakoglobin (Naxos disease) in families from Greece and Cyprus: genotype-phenotype relations, diagnostic features and prognosis. *Eur Heart J*. 2006;27:2208-16.
15. Heuser A, Plovie ER, Ellinor PT, Grossmann KS, Shin JT, Wichter T, Basson CT, Lerman BB, Sasse-Klaassen S, Thierfelder L, MacRae CA, Gerull B. Mutant desmocollin-2 causes arrhythmogenic right ventricular cardiomyopathy. *Am J Hum Genet*. 2006;79:1081-8.
 16. Syrris P, Ward D, Evans A, Asimaki A, Gandjbakhch E, Sen-Chowdhry S, McKenna WJ. Arrhythmogenic right ventricular dysplasia/cardiomyopathy associated with mutations in the desmosomal gene desmocollin-2. *Am J Hum Genet*. 2006;79:978-84.
 17. Pilichou K, Nava A, Basso C, Beffagna G, Bauce B, Lorenzon A, Frigo G, Vettori A, Valente M, Towbin J, Thiene G, Danieli GA, Rampazzo A. Mutations in desmoglein-2 gene are associated with arrhythmogenic right ventricular cardiomyopathy. *Circulation*. 2006;113:1171-9.
 18. Awad MM, Dalal D, Cho E, Amat-Alarcon N, James C, Tichnell C, Tucker A, Russell SD, Bluemke DA, Dietz HC, Calkins H, Judge DP. DSG2 mutations contribute to arrhythmogenic right ventricular dysplasia/cardiomyopathy. *Am J Hum Genet*. 2006;79:136-42.
 19. Asimaki A, Syrris P, Wichter T, Matthias P, Saffitz JE, McKenna WJ. A novel dominant mutation in plakoglobin causes arrhythmogenic right ventricular cardiomyopathy. *Am J Hum Genet*. 2007;81:964-73.
 20. Van Tintelen JP, Hofstra RM, Wiesfeld AC, van den Berg MP, Hauer RN, Jongbloed JD. Molecular genetics of arrhythmogenic right ventricular cardiomyopathy: emerging horizon? *Curr Opin Cardiol*. 2007;22:185-92.
 21. Beffagna G, Occhi G, Nava A, Vitiello L, Ditadi A, Basso C, Bauce B, Carraro G, Thiene G, Towbin JA, Danieli GA, Rampazzo A. Regulatory mutations in transforming growth factor-beta3 gene cause arrhythmogenic right ventricular cardiomyopathy type 1. *Cardiovasc Res*. 2005;65:366-73.
 22. Merner ND, Hodgkinson KA, Haywood AF, Connors S, French VM, Drenckhahn JD, Kupprion C, Ramadanova K, Thierfelder L, McKenna W, Gallagher B, Morris-Larkin L, Bassett AS, Parfrey PS, Young TL. Arrhythmogenic right ventricular cardiomyopathy type 5 is a fully penetrant, lethal arrhythmic disorder caused by a missense mutation in the TMEM43 gene. *Am J Hum Genet*. 2008;82:809-21.
 23. Valenzise M, Arrigo T, De Luca F, Privitera A, Frigiola A, Carando A, Garelli E, Silengo M. R298Q mutation of p63 gene in autosomal dominant ectodermal dysplasia associated with arrhythmogenic right ventricular cardiomyopathy. *Eur J Med Genet*. 2008;51:497-500.
 24. Tiso N, Stephan DA, Nava A, Bagattin A, Devaney JM, Stanchi F, Larderet G, Brahmbhatt B, Brown K, Bauce B, Muriago M, Basso C, Thiene G, Danieli GA, Rampazzo A. Identification of mutations in the cardiac ryanodine receptor gene in families affected with arrhythmogenic right ventricular cardiomyopathy type 2 (ARVD2). *Hum Mol Genet*. 2001;10:189-94.
 25. Bauce B, Rampazzo A, Basso C, Bagattin A, Daliento L, Tiso N, Turrini P, Thiene G, Danieli GA, Nava A. Screening for ryanodine receptor type 2 mutations in families with effort-induced polymorphic ventricular arrhythmias and sudden death: early diagnosis of asymptomatic carriers. *J Am Coll Cardiol*. 2002;40:341-9.
 26. Danieli GA and Rampazzo A. Genetics of arrhythmogenic right ventricular cardiomyopathy. *Curr Opin Cardiol*. 2002;17:218-21.
 27. George CH, Jundi H, Thomas NL, Fry DL, Lai FA. Ryanodine receptors and ventricular arrhythmias: emerging trends in mutations, mechanisms and therapies. *J Mol Cell Cardiol*. 2007;42:34-50.

28. Severini GM, Krajcinovic M, Pinamonti B, Sinagra G, Fioretti P, Brunazzi MC, Falaschi A, Camerini F, Giacca M, Mestroni L. A new locus for arrhythmogenic right ventricular dysplasia on the long arm of chromosome 14. *Genomics*. 1996;31:193-200.
29. Rampazzo A, Nava A, Miorin M, Fonderico P, Pope B, Tiso N, Livolsi B, Zimbello R, Thiene G, Danieli GA. ARVD4, a new locus for arrhythmogenic right ventricular cardiomyopathy, maps to chromosome 2 long arm. *Genomics*. 1997;45:259-63.
30. Melberg A, Oldfors A, Blomstrom-Lundqvist C, Stalberg E, Carlsson B, Larsson E, Lidell C, Eeg-Olofsson KE, Wikstrom G, Henriksson KG, Dahl N. Autosomal dominant myofibrillar myopathy with arrhythmogenic right ventricular cardiomyopathy linked to chromosome 10q. *Ann Neurol*. 1999;46:684-92.
31. Li D, Ahmad F, Gardner MJ, Weilbaecher D, Hill R, Karibe A, Gonzalez O, Tapscott T, Sharratt GP, Bachinski LL, Roberts R. The locus of a novel gene responsible for arrhythmogenic right-ventricular dysplasia characterized by early onset and high penetrance maps to chromosome 10p12-p14. *Am J Hum Genet*. 2000;66:148-56.
32. Den Dunnen JT and Antonarakis SE. Mutation nomenclature extensions and suggestions to describe complex mutations: a discussion. *Hum Mutat*. 2000;15:7-12.
33. Grantham R. Amino acid difference formula to help explain protein evolution. *Science*. 1974;185:862-4.
34. Ramensky V, Bork P, Sunyaev S. Human non-synonymous SNPs: server and survey. *Nucleic Acids Res*. 2002;30:3894-900.
35. Ng PC and Henikoff S. Predicting deleterious amino acid substitutions. *Genome Res*. 2001;11:863-74.
36. Ou J, Niessen RC, Vonk J, Westers H, Hofstra RM, Sijmons RH. A database to support the interpretation of human mismatch repair gene variants. *Hum Mutat*. 2008;29:1337-41.
37. Fokkema IF, den Dunnen JT, Taschner PE. LOVD: easy creation of a locus-specific sequence variation database using an "LSDB-in-a-box" approach. *Hum Mutat*. 2005;26:63-8.
38. Milting H and Klauke B. Molecular genetics of arrhythmogenic right ventricular dysplasia/cardiomyopathy. *Nat Clin Pract Cardiovasc Med*. 2008;5:E1; author reply E2.
39. Tavtigian SV, Greenblatt MS, Lesueur F, Byrnes GB. In silico analysis of missense substitutions using sequence-alignment based methods. *Hum Mutat*. 2008;29:1327-36.
40. Tchernitchko D, Goossens M, Wajcman H. In silico prediction of the deleterious effect of a mutation: proceed with caution in clinical genetics. *Clin Chem*. 2004;50:1974-8.
41. Basso C, Czarnowska E, Della Barbera M, Bauce B, Beffagna G, Wlodarska EK, Pilichou K, Ramondo A, Lorenzon A, Wozniak O, Corrado D, Daliento L, Danieli GA, Valente M, Nava A, Thiene G, Rampazzo A. Ultrastructural evidence of intercalated disc remodelling in arrhythmogenic right ventricular cardiomyopathy: an electron microscopy investigation on endomyocardial biopsies. *Eur Heart J*. 2006;27:1847-54.
42. Syrris P, Ward D, Asimaki A, Evans A, Sen-Chowdhry S, Hughes SE, McKenna WJ. Desmoglein-2 mutations in arrhythmogenic right ventricular cardiomyopathy: a genotype-phenotype characterization of familial disease. *Eur Heart J*. 2007;28:581-8.
43. Posch MG, Posch MJ, Perrot A, Dietz R, Ozcelik C. Variations in DSG2: V56M, V158G and V920G are not pathogenic for arrhythmogenic right ventricular dysplasia/cardiomyopathy. *Nat Clin Pract Cardiovasc Med*. 2008;5:E1.
44. McKoy G, Protonotarios N, Crosby A, Tsatsopoulou A, Anastasakis A, Coonar A, Norman M, Baboonian C, Jeffery S, McKenna WJ. Identification of a deletion in plakoglobin in arrhythmogenic right ventricular cardiomyopathy with palmoplantar keratoderma and woolly hair (Naxos disease). *Lancet*. 2000;355:2119-24.

45. Norgett EE, Hatsell SJ, Carvajal-Huerta L, Cabezas JC, Common J, Purkis PE, Whittock N, Leigh IM, Stevens HP, Kelsell DP. Recessive mutation in desmoplakin disrupts desmoplakin-intermediate filament interactions and causes dilated cardiomyopathy, woolly hair and keratoderma. *Hum Mol Genet.* 2000;9:2761-6.
46. Alcalai R, Metzger S, Rosenheck S, Meiner V, Chajek-Shaul T. A recessive mutation in desmoplakin causes arrhythmogenic right ventricular dysplasia, skin disorder, and woolly hair. *J Am Coll Cardiol.* 2003;42:319-27.
47. Norgett EE, Lucke TW, Bowers B, Munro CS, Leigh IM, Kelsell DP. Early death from cardiomyopathy in a family with autosomal dominant striate palmoplantar keratoderma and woolly hair associated with a novel insertion mutation in desmoplakin. *J Invest Dermatol.* 2006;126:1651-4.
48. Uzumcu A, Norgett EE, Dindar A, Uyguner O, Nisli K, Kayserili H, Sahin SE, Dupont E, Severs NJ, Leigh IM, Yuksel-Apak M, Kelsell DP, Wollnik B. Loss of desmoplakin isoform I causes early onset cardiomyopathy and heart failure in a Naxos-like syndrome. *J Med Genet.* 2006;43:e5.
49. Schonberger J and Seidman CE. Many roads lead to a broken heart: the genetics of dilated cardiomyopathy. *Am J Hum Genet.* 2001;69:249-60.
50. Rinne T, Brunner HG, Van Bokhoven H. p63-associated disorders. *Cell Cycle.* 2007;6:262-8.
51. Gallo P, d'Amati G, Pelliccia F. Pathologic evidence of extensive left ventricular involvement in arrhythmogenic right ventricular cardiomyopathy. *Hum Pathol.* 1992;23:948-52.
52. Norman M, Simpson M, Mogensen J, Shaw A, Hughes S, Syrris P, Sen-Chowdhry S, Rowland E, Crosby A, McKenna WJ. Novel mutation in desmoplakin causes arrhythmogenic left ventricular cardiomyopathy. *Circulation.* 2005;112:636-42.
53. Sen-Chowdhry S, Syrris P, Ward D, Asimaki A, Sevdalis E, McKenna WJ. Clinical and genetic characterization of families with arrhythmogenic right ventricular dysplasia/cardiomyopathy provides novel insights into patterns of disease expression. *Circulation.* 2007;115:1710-20.
54. Sen-Chowdhry S, Syrris P, Prasad SK, Hughes SE, Merrifield R, Ward D, Pennell DJ, McKenna WJ. Left-dominant arrhythmogenic cardiomyopathy an under-recognized clinical entity. *J Am Coll Cardiol.* 2008;52:2175-87.
55. Lahtinen AM, Lehtonen A, Kaartinen M, Toivonen L, Swan H, Widen E, Lehtonen E, Lehto VP, Kontula K. Plakophilin-2 missense mutations in arrhythmogenic right ventricular cardiomyopathy. *Int J Cardiol.* 2008;126:92-100.
56. Yu CC, Yu CH, Hsueh CH, Yang CT, Juang JM, Hwang JJ, Lin JL, Lai LP. Arrhythmogenic right ventricular dysplasia: clinical characteristics and identification of novel desmosome gene mutations. *J Formos Med Assoc.* 2008;107:548-58.
57. Beffagna G, Bauce B, Lorenzon A, Nava A, Smaniotto G, De Bortoli M, Basso C, Thiene G, Thiene GA, Rampazzo A. Compound genotypes of two mutated genes in arrhythmogenic right ventricular cardiomyopathy. *Eur Heart J.* 2008;29; Supplement 1:162 (Abstract).
58. Rampazzo A, Bauce B, Beffagna G, Lorenzon A, Smaniotto G, De Bortoli M, Basso C, Thiene G, Danieli G, Nava A. Prevalence of desmosomal protein mutations and clinical features in a large cohort of unrelated consecutive patients affected with arrhythmogenic right ventricular cardiomyopathy. *Eur Heart J.* 2008;29; Supplement 1:737 (Abstract).
59. Kaplan SR, Gard JJ, Carvajal-Huerta L, Ruiz-Cabezas JC, Thiene G, Saffitz JE. Structural and molecular pathology of the heart in Carvajal syndrome. *Cardiovasc Pathol.* 2004;13:26-32.
60. Kaplan SR, Gard JJ, Protonotarios N, Tsatsopoulou A, Spiliopoulou C, Anastasakis A, Squarcioni CP, McKenna WJ, Thiene G, Basso C, Brousse N, Fontaine G, Saffitz JE. Remodeling of myocyte gap junctions in arrhythmogenic right ventricular cardiomyopathy due to a deletion in plakoglobin (Naxos disease). *Heart Rhythm.* 2004;1:3-11.

61. Fidler LM, Wilson GJ, Liu F, Cui X, Scherer SW, Taylor GP, Hamilton RM. Abnormal connexin43 in arrhythmogenic right ventricular cardiomyopathy caused by plakophilin-2 mutations. *J Cell Mol Med.* 2009;13:4219-28.
62. Joshi-Mukherjee R, Coombs W, Musa H, Oxford E, Taffet S, Delmar M. Characterization of the molecular phenotype of two arrhythmogenic right ventricular cardiomyopathy (ARVC)-related plakophilin-2 (PKP2) mutations. *Heart Rhythm.* 2008;5:1715-23.
63. Awad MM, Dalal D, Tichnell C, James C, Tucker A, Abraham T, Spevak PJ, Calkins H, Judge DP. Recessive arrhythmogenic right ventricular dysplasia due to novel cryptic splice mutation in PKP2. *Hum Mutat.* 2006;27:1157.

6

Arrhythmogenic right ventricular dysplasia/cardiomyopathy – Pathogenic desmosome mutations in index patients predict outcome of family screening: Dutch arrhythmogenic right ventricular dysplasia/cardiomyopathy genotype-phenotype follow-up study

Moniek G.P.J. Cox*
Paul A. van der Zwaag*
Christian van der Werf*
Jasper J. van der Smagt
Maartje Noorman
Zahir A. Bhuiyan
Ans C.P. Wiesfeld
Paul G.A. Volders
Irene M. van Langen
Douwe E. Atsma
Dennis Dooijes
Arthur van den Wijngaard
Arjan C. Houweling
Jan D.H. Jongbloed
Luc Jordaens
Maarten J. Cramer
Pieter A. Doevendans
Jacques M.T. de Bakker
Arthur A.M. Wilde
J. Peter van Tintelen
Richard N.W. Hauer

** These authors contributed equally to this work*

Circulation. 2011;123:2690-700.

ABSTRACT

Background Arrhythmogenic right ventricular dysplasia/cardiomyopathy (ARVD/C) is an autosomal dominant inherited disease with incomplete penetrance and variable expression. Causative mutations in genes encoding five desmosomal proteins are found in $\approx 50\%$ of ARVD/C index patients. Previous genotype-phenotype relation studies involved mainly overt ARVD/C index patients, so follow-up data on relatives are scarce.

Methods and Results One hundred forty-nine ARVD/C index patients (111 male patients; age, 49 ± 13 years) according to 2010 Task Force criteria and 302 relatives from 93 families (282 asymptomatic; 135 male patients; age, 44 ± 13 years) were clinically and genetically characterised. DNA analysis comprised sequencing of plakophilin 2 (*PKP2*), desmocollin 2, desmoglein 2, desmoplakin, and plakoglobin and multiplex ligation-dependent probe amplification (MLPA) to identify large deletions in *PKP2*. Pathogenic mutations were found in 87 index patients (58%), mainly truncating *PKP2* mutations, including three cases with multiple mutations. MLPA revealed three *PKP2* exon deletions. ARVD/C was diagnosed in 31% of initially asymptomatic mutation-carrying relatives and 5% of initially asymptomatic relatives of index patients without mutation. Prolonged terminal activation duration was observed more than negative T waves in V_1 to V_3 , especially in mutation-carrying relatives < 20 years of age. In 45% of screened families, ≥ 1 affected relatives were identified (90% with mutations).

Conclusions Pathogenic desmosomal gene mutations, mainly truncating *PKP2* mutations, underlie ARVD/C in the majority (58%) of Dutch index patients and even 90% of familial cases. Additional MLPA analysis contributed to discovering pathogenic mutations underlying ARVD/C. Discovering pathogenic mutations in index patients enables those relatives who have a 6-fold increased risk of ARVD/C diagnosis to be identified. Prolonged terminal activation duration seems to be a first sign of ARVD/C in young asymptomatic relatives.

INTRODUCTION

Arrhythmogenic right ventricular dysplasia/cardiomyopathy (ARVD/C) is histopathologically characterised by progressive fibrofatty replacement of myocardium, primarily of the right ventricle (RV).¹⁻³ Although familial occurrence was recognised in the first report, only in the last decade has the genetic substrate been identified in genes encoding desmosomal proteins.^{1,4-9} Desmosomes are protein complexes in the intercalated disk, among others responsible for mechanical coupling of cardiac myocytes. Their impairment leads to both mechanical and electric uncoupling of cardiomyocytes, followed by cell death with fibrofatty replacement.¹⁰⁻¹³ Both uncoupling and altered architecture result in activation delay, which is the pivotal mechanism for reentry and thus ventricular tachycardia (VT).¹⁴⁻¹⁶

ARVD/C usually shows an autosomal dominant inheritance pattern, with incomplete penetrance and highly variable clinical expression.^{1,17-20} Classically, index patients present between the second and fourth decades of life with VT originating from the RV. However, sudden death can occur as early as adolescence, whereas mutation carriers may also remain without any signs and symptoms into old age. It has been hypothesised that genetic modifiers could be responsible for this phenotypic variability.^{4,5,7,21-24}

One of the primary clinical challenges in ARVD/C is timely diagnosis of the concealed phase, when individuals are at risk for arrhythmias despite the absence of symptoms. Yet, previous studies on genotype-phenotype correlations involved mainly overt ARVD/C index patients.¹⁷⁻²⁴ Follow-up data on their relatives are scarce. Hence, the proportion of relatives who develop signs of ARVD/C and/or (fatal) arrhythmias is unknown.

Analysing multiple genes related to ARVD/C in all index patients is essential for both accurate diagnosis and appropriate family counseling and screening. More insight into the natural variability of the disease expression and phenotypic consequences of genetic findings of ARVD/C is required. We therefore sequenced all five desmosomal genes in 149 Dutch ARVD/C index patients. The 302 family members were screened for the pathogenic mutations identified in their respective index patients. All individuals were followed up for genotype-phenotype correlations to determine disease penetrance and expression, including arrhythmias and sudden death.

METHODS

Patient population

In total, 169 unrelated white Dutch index patients with ARVD/C diagnosed according to the recently modified diagnostic Task Force criteria (2010 TFC) or at autopsy were included.²⁵ An index patient was the first member of the family diagnosed with ARVD/C in whom DNA analysis was started. The diagnostic process included detailed clinical and family histories, a physical examination, a 12-lead ECG, exercise testing, chest x-ray, and 2-dimensional transthoracic echocardiography. If no VT had been recorded, 24-hour Holter monitoring was performed. Additional magnetic resonance imaging and/or left ventricular and RV cine-angiography was performed in 118 patients (70%), and electrophysiological studies were done in 105 patients (62%). See Table I in the Data Supplement for details on follow-up frequencies.

We also included 302 relatives of 93 index patients who underwent cardiologic evaluation comprising at least a detailed history, physical examination, 12-lead ECG, and 2-dimensional echocardiography. If performed, outcomes of exercise tests (in 59%), 24-hour Holter monitoring (in 66%), signal-averaged ECG (in 25%), and electrophysiological studies (12%), as well as additional imaging by magnetic resonance imaging and/or RV cine angiography (42%), were included.

All 169 families received genetic counseling and consented to both clinical evaluation according to 2010 TFC and genetic screening of ARVD/C-related genes.²⁵ Quantitative analyses were performed at the seven participating centers. Scoring was performed in the core laboratory in Utrecht, the Netherlands, and patients were included only if there were no signs of any other cardiac disease.

Diagnostic criteria

Routine 12-lead ECGs were done with a paper speed of 25 mm/s and low-pass filter at 100 Hz. Depolarisation and repolarisation abnormalities were analysed only while patients were off drugs. Epsilon wave was defined as a distinct deflection after the QRS complex had first returned to the isoelectric line.²⁶ Terminal activation duration (TAD) was determined as the longest value in V_1 to V_3 , from the nadir of the S wave to the end of all depolarisation deflections, and considered prolonged when ≥ 55 milliseconds.²⁷ Recordings of VT episodes, both spontaneous and induced by programmed electric stimulation during electrophysiological studies, were collected. Ventricular tachycardia morphologies were determined only if 12-lead ECGs were available. Tissue characterisations from biopsies were not taken into account, because analyses had not been performed as prescribed in the 2010 TFC.²⁵

DNA analysis

Genomic DNA was extracted from whole blood or paraffinembedded tissues as described previously.²³ Sufficient DNA was available in 149 patients (88%) for direct sequencing of *PKP2*, *DSG2*, *DSC2*, *DSP*, and *JUP*. In addition, multiplex ligation-dependent probe amplification analysis (MLPA) was performed to identify large deletions in *PKP2* (SALSA MLPA kit P168 ARVC-PKP2, MRC Holland, Amsterdam, the Netherlands). Primer sequences and polymerase chain reaction conditions are available on request.

Nonsense, frameshift, and splice-site mutations affecting positions -2, -1, +1, and +2, as well as *PKP2* exon deletions, were all labeled truncating and considered to be proven pathogenic unless identified as polymorphisms. To assess the possible pathogenic nature of missense mutations, we used the in silico predictive programs Sorting Intolerant From Tolerant (SIFT) and Polymorphism Phenotyping (PolyPhen), which use the following criteria: difference in physicochemical properties of amino acids in respective substitutions, evolutionary conservation of amino acids across several species, presence in an evolutionary conserved region, and localisation in a predicted or proven functionally important domain.^{28,29} Missense mutations were considered to be most likely pathogenic when both programs predicted the genetic variants to affect protein function by a tolerance index score of ≤ 0.05 (SIFT) and the classification “probably damaging” (PolyPhen).^{28,29} Variants suspected of pathogenicity also had to be absent in 200 ethnically matched (ie, white Dutch) control subjects after direct sequencing. When available, data on segregation were taken into account. Family members were screened only for the pathogenic mutation found in their respective index patient. For genotype-phenotype analyses, proven pathogenic and most likely pathogenic variants were together labeled pathogenic, and comparisons of truncating and missense mutations were made. All variants present in the general population with a frequency of $>1\%$ were considered to be sequence polymorphisms. Sequence variants that did not fulfill our criteria for pathogenicity and were not polymorphisms were labeled unclassified variants (UVs).

In this article, “patients with mutations” and “mutation carriers” refer to patients carrying pathogenic mutations as identified in this study.

Statistical analysis

Continuous variables were compared by use of the Student t test. Categorical variables were analysed by use of contingency tables and the Pearson χ^2 method. If the expected value was <5 , the Fisher exact test was used instead. To compensate for possible correlation of characteristics of relatives within families, mixed models with hierarchical structure of members within families were applied. When it was impossible to fit the data in these models owing to lack of variation within families,

Pearson χ^2 tests were applied instead on a family level (ie, on the presence/absence of characteristics within separate families). Descriptive statistics are reported as mean \pm SD and estimates as estimated value \pm SE. Values of $P < 0.05$ were considered statistically significant. PASW statistics 17.0 software (SPSS, Chicago, IL) was used for calculations.

RESULTS

Index patients

Initially, 169 ARVD/C patients fulfilled the 2010 TFC. Twenty patients were excluded because of incomplete DNA analyses. *PKP2*, *DSG2*, *DSC2*, *DSP*, and *JUP* were all screened in the remaining 149 patients (111 male patients; mean age at inclusion, 49 \pm 13 years). First presentation was at a median age of 37 years (range, 12 to 77 years), mostly with monomorphic VT ($n=122$, 82%). These VTs were sustained in 119 cases, and all but two had left bundle-branch block morphology (see Table 1). Presenting first symptoms were similar between men and women. Cardioverter-defibrillators were implanted in 95 patients (64%): in 57 directly after diagnosis and in 38 after 4 \pm 7 years of follow-up. During follow-up, four patients died of ventricular fibrillation (three without implantable cardioverterdefibrillators, one with electrical storm) and two died of progressive heart failure. Three patients were indicated for heart transplantation; one received a transplantation.

DNA analyses

All pathogenic mutations are summarised in Table 2, and UVs are summarised in Table II in the Data Supplement. In total, 87 index patients (58%) carried at least 1 mutation (89 in total: 70 truncating [68 *PKP2*] and 19 missense [12 *PKP2*] mutations). Single mutations were identified in 84 index patients (56%): 76 in *PKP2* (64 truncating), five in *DSG2*, two in *DSC2*, and one in *DSP*. In addition, three patients (2%) carried multiple mutations. Two had a truncating *PKP2* mutation and a *DSC2* or *DSP* missense mutation, and one carried a homozygous *DSC2* mutation (see Table III in the Data Supplement for details, including phenotypic characteristics). We identified 51 UVs in 49 patients (35 different ones; Table II in the Data Supplement). In 28 patients, the UV was carried in addition to a pathogenic mutation, and two patients carried two UVs. Table IV in the Data Supplement shows the combinations of pathogenic mutations and UVs per patient. Of the 35 UVs, 28 were missense variants, six were silent variants, and one was a frameshift variant. The *DSC2* frameshift variant p.Ala897LysfsX4 was considered a UV because it is located at the far end

Table 1 Clinical characteristics of arrhythmogenic right ventricular dysplasia/ cardiomyopathy index patients related to the presence or absence of pathogenic mutations

	Total (n=147)*		With mutation (n=87)		No mutation (n=60)		P
	n	%	n	%	n	%	
Male	110	75	62	71	48	80	0.284
Age at onset, mean±SD, y	37±14		35±13		40±14		0.042
Follow-up, mean±SD, y	12±9		13±10		11±7		0.191
Reason for first evaluation							
VT	122	82	72	83	47	78	
Aborted sudden death	12	8	8	9	4	7	
Prolonged syncope	2	1	1	1	1	2	
Sudden death of a relative	2	1	0	0	2	3	
Frequent PVCs	5	3	5	6	3	5	
Other	4	3	1	1	3	5	
TFC							
Epsilon wave†	22	18	14	18	8	17	0.153
Late potentials‡	44	54	22	50	22	59	0.395
Prolonged TAD†	78	62	44	56	34	72	0.734
Negative T waves							
V ₁ -V ₃ †	98	78	69	88	29	62	0.001
V ₁ -V ₂ †	8	6	5	6	3	6	1.000
V ₄ -V ₆ †	6	5	2	3	3	6	0.524
Ventricular fibrillation	12	8	8	9	4	7	0.281
VT with LBBB morphology	129	88	77	89	52	87	0.945
with superior axis	67	46	39	45	28	47	0.943
>500 PVCs/24h	33	22	20	23	13	22	0.969
Structural abnormalities							
major	86	59	55	63	31	52	0.198
minor	25	17	15	17	10	17	0.963

VT indicates ventricular tachycardia; PVC, premature ventricular complex; TFC, Task Force criteria; TAD, terminal activation duration; and LBBB, left bundle-branch block. P values are the difference between mutation carriers and noncarriers.

* Two patients were diagnosed after autopsy; therefore, no clinical data were available.

† ECGs done while the patients were off drugs were available for 125 index patients: 78 with and 47 without mutation.

‡ Late potentials were measured in 81 patients: 69 by signal-averaged ECG and 12 by mapping during electrophysiological studies.

of the gene and was found in eight patients and in 3 of 200 controls ($P=0.06$).²⁴ The DSG2 variant p.Val158Gly was predicted to be pathogenic by both SIFT and PolyPhen. However, we found this variant in 2 of 149 patients and 3 of 300 controls

Table 2 Pathogenic mutations

Gene	DNA change	Protein change	Type	PolyPhen (PSIC)*	SIFT†	Index patient, n	No. of family members symptomatic,	
							Yes	No
Proven pathogenic								
PKP2	Deletion exon 1-4		Deletion			1	1	7
	Deletion exon 1-14		Deletion			1		4
	Deletion exon 8		Deletion			1		
	c.148_151delACAG	p.Thr50SerfsX61	Frameshift			2		3
	c.235C>T	p.Arg79X	Nonsense			9	3	15
	c.258T>G	p.Tyr86X	Nonsense			1		
	c.397C>T	p.Gln133X	Nonsense			9	3	16
	c.917_918delCC	p.Pro318GlnfsX29	Frameshift			3	1	1
	c.1211_1212insT	p.Val406SerfsX	Frameshift			11	6	15
	c.1369_1372delCAAA	p.Gln457X	Nonsense			2		4
	c.1848C>A	p.Tyr616X	Nonsense			4		6
	c.2028G>A	p.Trp676X	Nonsense			1		1
	c.2034G>A	p.Trp678X	Nonsense			1		2
	c.2146-1G>C		Splice site			7		2
	c.2386T>C	p.Cys796Arg	Missense	++ (3.410)	0.03	11	1	17
	c.2421C>A	p.Tyr807X	Nonsense			1		
	c.2489+1G>A		Splice site			6	1	7
	c.2489+4A>C		Splice site			4		9
	c.2509delA	p.Ser837ValfsX94	Frameshift			1		
c.2544G>A	p.Trp848X	Nonsense			1	1		
DSC2	c.943-1G>A		Splice site			1		1
DSG2	c.378+2T>G		Splice site			1		
DSP	c.3337C>T	p.Arg1113X	Nonsense			1	1	
Most likely pathogenic								
PKP2	c.2062T>C	p.Ser688Pro	Missense	+	0.04	1		1
DSC2	c.608G>A	p.Arg203His	Missense	++ (2.295)	0.00‡	1		2
	c.942+3A>G§		Splice site			1		
	c.2587G>A	p.Gly863Arg	Missense	++ (2.492)	0.00‡	1		
DSG2	c.137G>A	p.Arg46Gln	Missense	++ (2.013)	0.00‡	2		4
	c.614C>T	p.Pro205Leu	Missense	++ (3.054)	0.00‡	1		
	c.874C>T	p.Arg292Cys	Missense	++ (2.759)	0.00‡	1		2
DSP	c.1982A>T	p.Asn661Ile	Missense	++ (2.073)	0.01‡	1		

* Polymorphism Phenotyping (PolyPhen) prediction: ++, probably damaging; +, possibly damaging; -, benign. PSIC indicates Position-Specific Independent Counts. † Sorting Intolerant From Tolerant (SIFT) prediction: Amino acids with scores <0.05 are predicted to be deleterious. For previous reports on pathogenicity, see van der Zwaag et al.³¹ ‡ This substitution may have been predicted to affect function just because the sequences used were not diverse enough. There is low confidence in this prediction. § The four splice-prediction programs used (SpliceSiteFinder, MaxEntScan, NNSPLICE, and GeneSplicer) indicated disruption of the splice donor site of *DSC2* exon 7.

($P=0.67$), and it has frequently been reported in other control populations.^{22,23,30,31} Therefore, we classified it as an UV.

Genotype-phenotype correlation

First, we compared the clinical characteristics of index patients with and without mutations independently of the number of variants (Table 1). Both groups showed a male predominance (71% and 80%), and age at the time of inclusion was similar (51 ± 13 and 49 ± 13 years).

Ventricular tachycardia and/or ventricular fibrillation was recorded in 134 of 149 index patients, showing similar frequencies among those with and without mutations. However, first arrhythmic events were documented at a significantly younger age in mutation carriers compared with noncarriers (median age, 35 versus 42 years; $P=0.042$; Figure 1). The three patients carrying two mutations had their first VT at 14, 17, and 20 years of age. A comparison of criteria in mutation carriers and noncarriers demonstrated no significant differences except that negative T waves in V_1 to V_3 occurred more often in mutation carriers (88% versus 62%; $P=0.001$).

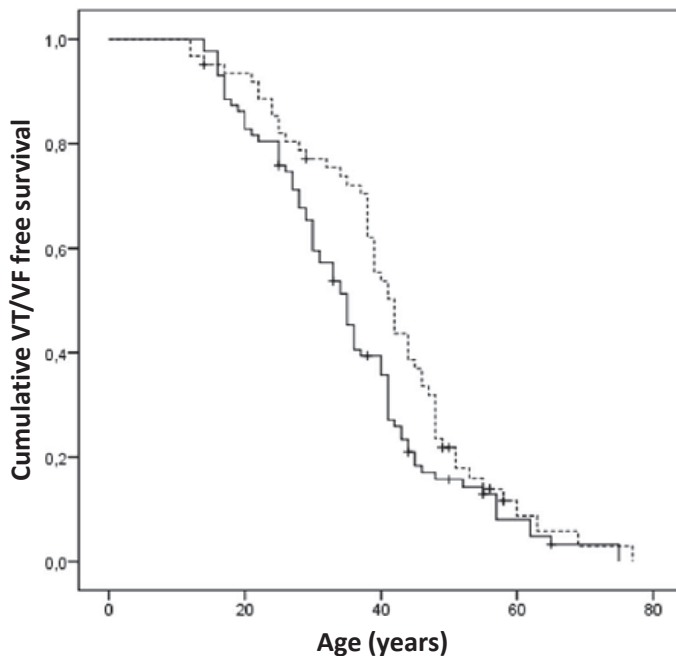

Figure 1 Ventricular tachycardia/ventricular fibrillation (VT/VF)–free survival of arrhythmogenic right ventricular dysplasia/ cardiomyopathy (ARVD/C) index patients with vs without mutations. Patients with a mutation experience their first arrhythmic event at a significantly younger age than those without a mutation. This age is even lower if a patient carries two mutations (see text).

None of the criteria could be explained by the type of mutation (truncating versus missense) except for prolonged TAD, which was observed more often in patients with missense mutations (13 of 15 versus 31 of 63).

Patients carrying a single UV did not differ from patients without mutations on any criterion or on age of first event. However, fewer patients with a single UV had negative T waves in V_1 to V_3 than patients with one mutation ($P=0.043$), but they were similar in every other respect. Likewise, patients carrying a UV together with a mutation did not differ from either patients with a single mutation or those with two mutations (see Table V in the Data Supplement for more details).

Family history of sudden cardiac death

Twenty-five index patients reported 30 relatives with sudden cardiac death (SCD). In 18 families of index patients with mutations, SCD had occurred in 19 relatives (16 male subjects). Autopsy was performed in six cases and revealed ARVD/C in all of them. In seven families of index patients without mutations, SCD had occurred in 11 relatives (eight male relatives). No autopsies had been performed. Mean ages at SCD were similar in families with and without mutations (28 years [range, 15 to 49 years] versus 32 years [range, 21 to 43 years]; $P=0.108$). However, all seven relatives with SCD at <20 years of age (23%) belonged to families with *PKP2* mutations (six truncating; Table 3).

Family members

Both genotypic and phenotypic data were available for analysis of 302 members from 93 different families (58 with and 35 without mutations).

Relatives symptomatic at first presentation

Twenty relatives from 18 families presented with cardiac symptoms before family screening was performed (13 men; mean age, 42 years [range, 20 to 71 years]). In 10 relatives, monomorphic left bundle-branch block VT was the first symptom. In addition, four family members had ventricular fibrillation (one was successfully resuscitated), three had prolonged syncope, two had palpitations and one had atrial fibrillation. Eighteen relatives fulfilled the 2010 TFC, and 18 carried pathogenic mutations (all *PKP2*, 16 truncating; Table 2 and Figure 2).

Table 3 Relatives <20 years of age with sudden death or arrhythmogenic right ventricular dysplasia/ cardiomyopathy signs

Age, y	Sex	PKP2 mutation in family	PKP2 mutation	Autopsy	TFC identified
Sudden cardiac death					
15	Male	c.235C>T		No	
16	Male	c.2489+1G>A‡		No	
16	Male	c.2489+1G>A‡		No	
17	Male	c.2386T>C		Yes (ARVD/C)	
17	Male	c.397C>T		No	
17	Male	c.1211-1212insT		Yes (ARVD/C)	
18	Female	c.2421C>A		Yes (ARVD/C)	
Family screening*					
14	Male		Deletion exons 1-4		Prolonged TAD
17	Male		c.1211-1212insT		Prolonged TAD; >500 PVCs/24h
18	Male		c.2489+4A>C		Prolonged TAD
18	Male		c.2386T>C		Prolonged TAD
19	Female		c.148_151delACAG		Prolonged TAD
15	Male		c.1369_1372delCAAA		Negative T waves in V1-V2
19	Female		c.2386T>C		Negative T waves in V1-V2

TFC indicates Task Force criteria; ARVD/C, arrhythmogenic right ventricular dysplasia/cardiomyopathy; TAD, terminal activation duration; and PVC, premature ventricular complex. *Age after follow-up. ‡From the same family. Mutations were found in none of the other genes. All mutations were truncating, except missense c.2386T>C.

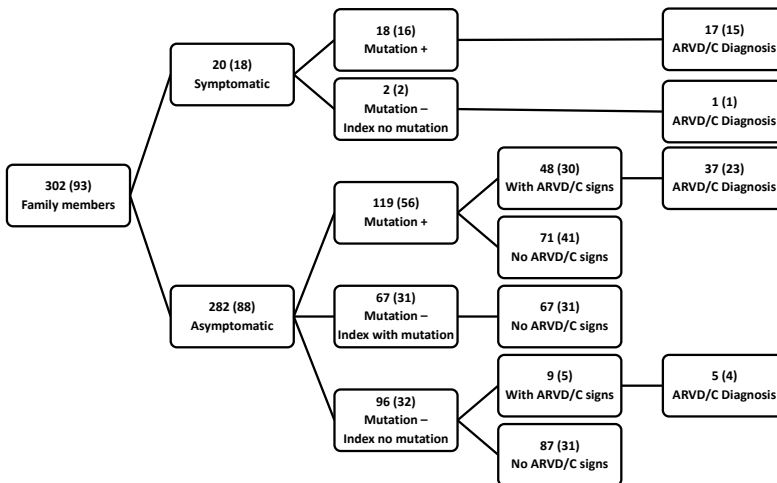

Figure 2 Schematic representation of relatives demonstrating the distribution of arrhythmogenic right ventricular dysplasia/cardiomyopathy (ARVD/C) signs and symptoms as well as mutations. Numbers in parentheses indicate the number of different families. In total, a diagnosis of ARVD/C was made in 60 family members from 42 different families.

Family screening of asymptomatic relatives

The remaining 282 asymptomatic relatives (123 male subjects, 44%) were evaluated in the course of family screening. Mean age at first clinical examination was 39 ± 18 years, and follow-up 4 ± 4 years, which was similar for male and female subjects. In 119 members (42%) from 56 families, pathogenic mutations were identified: in 111 *PKP2* (93%; 78% truncating), five *DSG2*, and three *DSC2* (Table 2 and Figure 2).

Table 4 shows the results of family screening in the 282 initially asymptomatic family members. Most criteria were perceived either exclusively or considerably more often in mutation carriers. Because of the low presence of characteristics and low variation in families, mixed models could not be applied to these data. To

Table 4 Clinical characteristics of asymptomatic arrhythmogenic right ventricular dysplasia/cardiomyopathy relatives related to the presence or absence of pathogenic mutations

	Total (n=282)		With mutation (n=119)		No mutation				P*
					index patient with mutation (n=67)		index patient no mutation (n=96)		
					n	%	n	%	
Male	123	44	45	38	32	48	47	49	0.096
Age at first evaluation, mean \pm SD, y	39 \pm 18		39 \pm 18		40 \pm 18		38 \pm 17		0.419
Follow-up, mean \pm SD, y	4 \pm 4		4 \pm 3		4 \pm 3		3 \pm 3		0.131
ARVD/C diagnosis	42 (27)	15	37 (23)	31	0	0	5 (4)	5	0.004
Epsilon wave	4 (4)	1	4 (4)	3	0	0	0	0	0.292
Late potentials†	8 (8)	10	6 (6)	21	0	0	2 (2)	2	0.047
Prolonged TAD	34 (26)	12	26 (21)	22	0	0	8 (5)	8	0.030
Negative T waves									
V ₁ -V ₃	20 (18)	7	19 (17)	16	0	0	1	1	0.002
V ₁ -V ₂	7 (6)	2	6 (5)	5	0	0	1	1	0.410
V ₄ -V ₆	3 (2)	1	0	0	0	0	3 (2)	3	0.130
VT with LBBB morphology									
with superior axis	2 (2)	1	2 (2)	2	0	0	0	0	0.532
with inferior axis	9 (9)	3	9 (9)	8	0	0	0	0	0.023
>500 PVCs/24h	34 (19)	12	23 (14)	19	0	0	9 (5)	9	0.304
Structural abnormalities									
major	12 (11)	4	10 (9)	8	0	0	2 (2)	2	0.315
minor	10 (7)	4	10 (7)	8	0	0	0	0	0.045

ARVD/C indicates arrhythmogenic right ventricular dysplasia/cardiomyopathy; TAD, terminal activation duration; VT, ventricular tachycardia; LBBB, left bundle-branch block; PVC, premature ventricular complex.

*Difference between families of relatives with mutation vs relatives of index patients without mutation.

Numbers in parentheses indicate the numbers of different families.

†Late potentials were measured in 77 patients: 29 with and 48 without mutation.

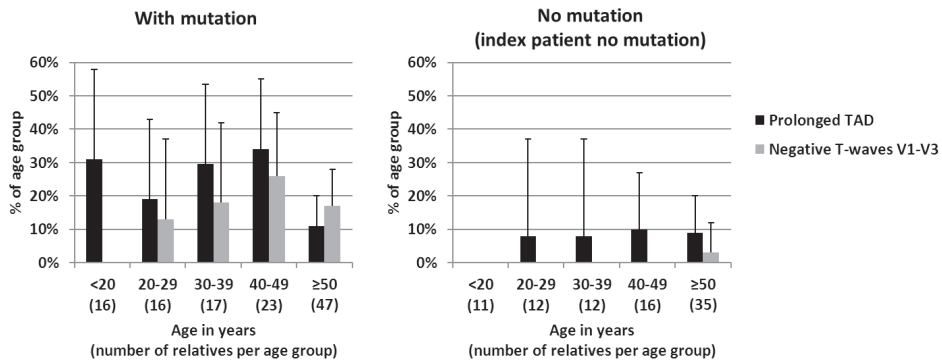

Figure 3 Presence of prolonged terminal activation duration (TAD) and negative T waves in V₁ to V₃ per age group in relatives with mutation vs relatives from index patients without mutation. Prolonged TAD was already present in many young relatives, with similar frequencies among all age groups ($P=0.269$). On the contrary, negative T waves were present more frequently with increasing age, almost exclusively in mutation carriers. Numbers in parentheses indicate the numbers of relatives per age group.

recognise the possible dependence of relatives and their phenotypes among families, statistical analyses were performed at the family level (ie, families were scored positive for separate criteria if present in ≥ 1 relative; Table 4). Strikingly, prolonged TAD was observed in more cases than negative T waves in V₁ to V₃. This difference varied with age (Figure 3). Relatives <20 years of age had no negative T waves in V₁ to V₃, but prolonged TAD was already observed in five of seven young relatives with signs of ARVD/C (Table 3).

VTs were recorded in nine initially asymptomatic relatives (3%) from eight families. All carried PKP2 mutations (7 truncating; Table 4). Five women (mean age 51 years [range, 34 to 70 years]) had hemodynamically well-tolerated nonsustained left bundle-branch block VT during their first exercise tests. The other four (one female) had VT after a mean follow-up of 4.0 years (2 to 8 years at a mean age of 43 years [range 34 to 56 years]). Two left bundlebranch block VTs were sustained with rates of 220 and 240 bpm, and resulted in syncope.

Altogether, 57 family members (20%) from 35 families showed signs of ARVD/C because they fulfilled ≥ 1 criteria besides those concerning family history. This group comprised more women than men (39 versus 18; $P=0.04$), and their mean age after follow-up was 47 ± 16 years. Forty-eight (84%) carried pathogenic mutations (all PKP2, 41 truncating), and the remaining nine belonged to families with no identified mutation. Fourteen relatives with an unremarkable first clinical evaluation developed signs of ARVD/C after a mean follow-up of 4.2 years (range, 1 to 10 years). For family members up to 50 years of age, a higher age was associated with

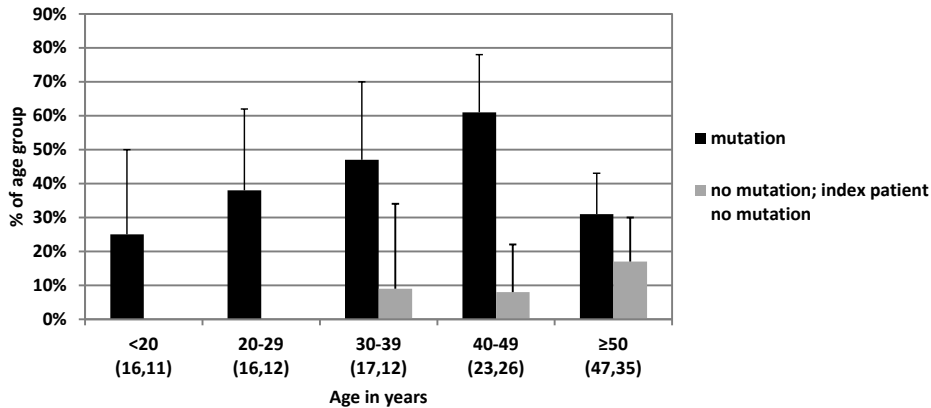

Figure 4 Relatives showing any sign of arrhythmogenic right ventricular dysplasia/ cardiomyopathy, ie, meeting ≥ 1 criteria besides those concerning family history, divided into age groups. With increasing age, higher percentages of relatives showed signs of disease except in at the highest age. Numbers between parentheses indicate numbers of relatives per age group, with and without mutation, respectively.

an increased prevalence of ARVD/C signs, in contrast to family members ≥ 50 years of age (Figure 4).

Forty-two initially asymptomatic family members from 27 families were diagnosed with ARVD/C: at first evaluation in 34 patients and after a mean follow-up of 5.0 years (range, 2 to 10 years) in eight patients. This group had a mean age at diagnosis of 39 ± 15 years and comprised 29 females (69%).

Familial risk of ARVD/C

In initially asymptomatic relatives, ARVD/C was diagnosed in 5% (5 of 96) when their index patient had no identified mutation and 20% (37 of 119+67) when their index patient had a mutation; all 37 also carried mutations (Figure 2). Thus, identifying a mutation in an index patient implies a relative risk for ARVD/C diagnosis in their asymptomatic relatives of 3.8 ± 1.6 . This risk increases to as much as 6.0 ± 2.4 for mutation-carrying relatives compared with relatives of index patients without a mutation (37 of 119 versus 5 of 96).

When the symptomatic and asymptomatic mutation-carrying relatives were combined, 54 of 137 (39%) had an ARVD/C diagnosis compared with 6 of 98 relatives of index patients without mutations (6%).

Of the 93 families in which ≥ 2 members, including the index patient, were examined, 42 had familial ARVD/C (45%; 38 with mutations, all *PKP2*, 33 truncating). Thus, *PKP2* mutations were identified in 90% of familial ARVD/C cases.

DISCUSSION

Here, we report the results of follow-up of a large number of ARVD/C families, including comprehensive DNA analysis. In 87 of 149 ARVD/C index patients (58%), pathogenic mutations were identified, predominantly truncating *PKP2*. ARVD/C was diagnosed in 60 of 302 family members (18 symptomatic, 42 asymptomatic), of whom 54 (90%) carried pathogenic mutations (all *PKP2*, 47 truncating). Identifying a pathogenic mutation in an index patient predicts outcome in relatives. Compared with relatives of index patients without mutations, mutation-carrying relatives have a 6-fold risk of ARVD/C diagnosis, markedly enhanced risk of ventricular arrhythmias in analysed relatives, and earlier onset of ARVD/C signs and symptoms (for concurrent numbers, see Table 4 and Figure 4). In young relatives <20 years of age, sudden death and signs of ARVD/C occurred exclusively in *PKP2* mutation carriers. Prolonged TAD, a marker of activation delay, appeared to be an early ARVD/C sign.

Pathogenicity of DNA variants

The large majority of DNA variations were truncating *PKP2* mutations. Notably, in this first study applying MLPA on a large scale in ARVD/C patients, large *PKP2* deletions were identified in three cases. This mutational yield of 2%, which is comparable to the sequencing of *DSC2* or *DSG2*, underscores the importance of performing this additional analysis. Notably, because this has not been tested, we cannot exclude the possibility that large deletions might be present in other desmosomal genes in patients that are as yet without a pathogenic mutation.

The fact that a significant proportion of genetic variants remains unclassified represents a gap in risk assessment for index patients, and UVs are noninformative for family screening. However, establishing pathogenic effects of missense variants is difficult and requires well-validated functional assays, which are not widely available and are highly complex to perform. Linkage and segregational studies can be helpful to establish pathogenicity. Yet, low frequency of variants, small family size, and age-dependent penetrance hamper the use of these methods.

Previous studies on mutations in *DSC2*, *DSG2*, and *DSP* used different criteria to define the pathogenicity of DNA variants. The largest studies used criteria of absence in control subjects and/or occurrence in a functionally important domain, alteration of conserved amino acids, or cosegregation with disease in a family.^{21,22,30} Thus, in contrast to our study, none of these studies used all the possible predictive strategies together. Consequently, the variants p.Thr335Ala and p.Val392Ile in *DSG2* and p.Gln90Arg in *DSP* were previously classified as pathogenic, but with our definition, they were classified as UVs.^{21,22}

Index patients

In this study of white Dutch patients, *PKP2* was by far the most important contributor to mutation yield (found in 52% of patients, 90% of pathogenic mutations). Previous studies reported *PKP2* mutations in 19% to 45% of ARVD/C patients and mutations in other desmosomal genes in 1% to 12%.^{21,22,31,32} These differences can be due to various causes, such as the presence of founder mutations, use of different definitions for pathogenicity, regional differences in other genetic and nongenetic causes, and strictness in applying the TFC.^{6,19} New genetic techniques, such as high-density genotyping array with haplotype sharing or exome sequencing, might elucidate new genes involved in ARVD/C.³³ This will improve the distinction between familial and sporadic ARVD/C cases and ameliorate risk stratification for relatives.

Our study suggests that UVs as defined here do not result in a more severe phenotype or earlier onset of ARVD/C. However, most UVs were found only in single patients; therefore, comparisons on the level of individual variants were not possible. Because the pathogenic influence of UVs is unknown, relatives were not tested for these variants. Consequently, it cannot be ruled out that, within families, carrying a specific UV is a risk factor for disease development.

Index patients were included only if they fulfilled the 2010 TFC. Consequently, this obviously affected population cannot be regarded as representative of the variable disease expression. Therefore, analysis of asymptomatic family members was crucial.

Family members

The large majority (84%) of initially asymptomatic family members showing signs of ARVD/C carried desmosomal gene mutations (90% truncating, all *PKP2*). Overall, we found no differences between carriers of truncating and missense mutations. In four families with ≥ 2 members diagnosed with ARVD/C and in whom no mutations were identified, a genetic cause is highly suspected.

Negative T waves in V_1 to V_3 have always been considered the most sensitive ECG abnormality in ARVD/C.¹⁷⁻²⁰ However, in family members, we observed the new criterion of prolonged TAD more often and at younger age (Figure 3). In four of seven family members < 20 years of age with signs of ARVD/C, prolonged TAD was the only clinical abnormality observed. Longer periods of follow-up are needed to demonstrate the disease progression after prolonged TAD is found and whether it is a good predictive marker of arrhythmias and SCD.

Disease penetrance

Because ARVD/C is a progressive disease with age-related penetrance, it seems counterintuitive that the percentage of family members showing any signs of ARVD/C

was lower in those ≥ 50 years of age than in their younger counterparts. Because individuals ≥ 50 years of age are also at higher risk of coronary artery disease, those already seeing a cardiologist may not have been referred for family screening.

Cohorts of ARVD/C index patients universally demonstrate a male predominance.¹⁸⁻²¹ Interestingly, among the asymptomatic family members in this study, women were affected more often than men. Apparently, men with ARVD/C experience arrhythmias and die suddenly at a younger age and thus are more likely to be the index patient. The underlying mechanism is not yet known, but strenuous exercise by men and the prevention of programmed cell death in cardiac myocytes in women due to estradiol are believed to play a role.³⁴

At first examination, 43 of 282 asymptomatic family members (15%) already showed any sign of disease, including nonsustained VT in five patients and >500 premature ventricular complexes in 24 hours in 30 patients. Because relatives with these arrhythmias were asymptomatic, the age of onset is unknown. Besides, only four relatives (all mutation carriers) went on to develop VT during follow-up. Therefore, it was not possible to calculate the annual risk of arrhythmias or to identify predictive risk factors other than carrying a pathogenic mutation. Longer periods of follow-up of large series of relatives who initially have no signs of disease are needed to provide this insight. Large multicenter studies are required to achieve this.

Contrary to our study, all previous genotype-phenotype analyses in ARVD/C families separately addressed mutations in different desmosomal genes and involved only a few families. We found that 66 of 137 mutation-carrying family members (48%) showed some sign of ARVD/C, with ARVD/C diagnosis made according to 2010 TFC in 39%. No direct comparison with other studies can be made, because different sets of diagnostic criteria were used. However, similar numbers of affected relatives with *PKP2* mutations were reported by Dalal et al.³⁵ and Syrris et al.²⁰ (49% and 47%, respectively). Other family studies have also reported high percentages of relatives diagnosed with ARVD/C: 58% in *DSG2*, 75% in *DSC2*, and 54% in *DSP* mutation carriers. However, these studies comprised only 8, 2, and 4 families, respectively.^{8,30,36}

Study limitations

Sequence alterations were divided into pathogenic or UVs according to arbitrarily defined criteria. However, in the absence of any data on pathogenicity, conclusions regarding the utility of genetic testing are speculative.

All index patients were offered family screening, regardless of their mutational status. However, relatives of 93 of 149 fully genotyped index patients (62%) underwent both clinical and genetic screening. Although there is no such indication, this might potentially create a bias in the population of relatives studied. Not all relatives

underwent all the diagnostic tests, as indicated in the Methods section. All family members included in this study underwent at least 2-dimensional echocardiography to screen for RV structural abnormalities. Additional magnetic resonance imaging was performed in only a minority of cases, so minor abnormalities might have been missed. Late potentials were measured in 25% of relatives, but activation delay was measured by means of prolonged TAD in all relatives.

Thirty-six relatives of mutation-carrying index patients were not clinically evaluated because they appeared to be noncarriers; thus, they could not be included in this study. Consequently, of families with pathogenic mutations, more relatives with mutations were included than without mutations (119 versus 67).

CONCLUSIONS

In this large follow-up study in Dutch ARVD/C families, pathogenic desmosomal gene mutations were found in the majority of ARVD/C index patients (58%); these were mainly truncating *PKP2* mutations, with multiple mutations in 2% of cases. Performing MLPA also is important, because its mutational yield is comparable to the sequencing of *DSG2* or *DSC2*. Mutation carriers presented at a younger age than noncarriers; this age was even lower when multiple mutations were identified.

In total, 20% of initially asymptomatic relatives who underwent family screening showed some sign of ARVD/C (84% mutation carriers), mainly ECG abnormalities. Mutation-carrying relatives had an earlier onset of signs and symptoms, a markedly increased risk of arrhythmias, and a 6-fold increased risk of ARVD/C diagnosis. Familial cases were identified in 45% of the families screened. Prolonged TAD seems to be an early marker of RV abnormalities, especially in mutation-carrying relatives <20 years of age.

Acknowledgements

We thank Marcoen Scholten, Peter Loh, Bert Baars, Geert-Jan Kimman, Maarten van den Berg, Karin de Boer, and Isabelle van Gelder for their contributions to the patient screening and referrals; Jackie Senior for editing this manuscript; and Paul Westers for statistical analyses. This study was supported by the Netherlands Heart Foundation (grants 2007B132 and 2007B139), Interuniversity Cardiology Institute of the Netherlands (project 06901), ZorgOnderzoek Nederland Medische Wetenschappen (grant 120610013), and Van Ruyven Foundation.

CLINICAL PERSPECTIVE

Arrhythmogenic right ventricular dysplasia/cardiomyopathy (ARVD/C) usually shows an autosomal dominant inheritance pattern, with incomplete penetrance and variable clinical expression. Classically, index patients present between the second and fourth decade of life with right ventricular tachycardia. However, sudden death can occur at adolescence, whereas mutation-carriers may remain without signs and symptoms up to high age. Previous genotype-phenotype studies mainly involved overt index patients. Data on, mainly asymptomatic, relatives were scarce. To gain insight in the full spectrum of the disease, 149 ARVD/C index patients and 302 of their relatives were genotypically and phenotypically characterised. DNA analysis comprised sequencing of desmosomal genes *PKP2*, *DSC2*, *DSG2*, *DSP*, and *JUP* and multiplex ligation-dependent probe amplification (MLPA) to identify large deletions in *PKP2*.

Pathogenic mutations were identified in 87 of 149 (58%) ARVD/C index patients, mainly truncating *PKP2* mutations with multiple mutations in 2% of cases. MLPA appeared important to perform additionally: its 2% mutational yield was comparable to sequencing of *DSG2* or *DSC2*. Identification of mutations in index patients had major consequences for the concurrent relatives. Of the 57 of 282 (20%) initially asymptomatic relatives that showed any sign of ARVD/C, 84% carried a mutation. These 48 mutation carriers not only had earlier onset of disease signs and symptoms than non-carriers, but also a markedly increased risk of arrhythmias and six-fold risk of ARVD/C diagnosis. Familial cases were identified in 45% of families screened. Prolonged TAD seemed an early marker of ARVD/C, as it was observed more often than negative T-waves in V_1 - V_3 , especially in mutation-carrying relatives younger than 20 years.

REFERENCES

1. Marcus FI, Fontaine GH, Guiraudon G, Frank R, Laurenceau JL, Malergue C, Grosogeat Y. Right ventricular dysplasia: a report of 24 adult cases. *Circulation*. 1982;65:384-98.
2. Corrado D, Basso C, Thiene G, McKenna WJ, Davies MJ, Fontaliran F, Nava A, Silvestri F, Blomstrom-Lundqvist C, Wlodarska EK, Fontaine G, Camerini F. Spectrum of clinicopathologic manifestations of arrhythmogenic right ventricular cardiomyopathy/dysplasia: a multicenter study. *J Am Coll Cardiol*. 1997;30:1512-20.
3. Basso C, Thiene G, Corrado D, Angelini A, Nava A, Valente M. Arrhythmogenic right ventricular cardiomyopathy. Dysplasia, dystrophy, or myocarditis? *Circulation*. 1996;94:983-91.
4. McKoy G, Protonotarios N, Crosby A, Tsatsopoulou A, Anastasakis A, Coonar A, Norman M, Baboonian C, Jeffery S, McKenna WJ. Identification of a deletion in plakoglobin in arrhythmogenic right ventricular cardiomyopathy with palmoplantar keratoderma and woolly hair (Naxos disease). *Lancet*. 2000;355:2119-24.
5. Rampazzo A, Nava A, Malacrida S, Beffagna G, Bauce B, Rossi V, Zimbello R, Simionati B, Basso C, Thiene G, Towbin JA, Danieli GA. Mutation in human desmoplakin domain binding to plakoglobin causes a dominant form of arrhythmogenic right ventricular cardiomyopathy. *Am J Hum Genet*. 2002;71:1200-6.
6. Gerull B, Heuser A, Wichter T, Paul M, Basson CT, McDermott DA, Lerman BB, Markowitz SM, Ellinor PT, MacRae CA, Peters S, Grossmann KS, Drenckhahn J, Michely B, Sasse-Klaassen S, Birchmeier W, Dietz R, Breithardt G, Schulze-Bahr E, Thierfelder L. Mutations in the desmosomal protein plakophilin-2 are common in arrhythmogenic right ventricular cardiomyopathy. *Nat Genet*. 2004;36:1162-4.
7. Pilichou K, Nava A, Basso C, Beffagna G, Bauce B, Lorenzon A, Frigo G, Vettori A, Valente M, Towbin J, Thiene G, Danieli GA, Rampazzo A. Mutations in desmoglein-2 gene are associated with arrhythmogenic right ventricular cardiomyopathy. *Circulation*. 2006;113:1171-9.
8. Syrris P, Ward D, Evans A, Asimaki A, Gandjbakhch E, Sen-Chowdhry S, McKenna WJ. Arrhythmogenic right ventricular dysplasia/cardiomyopathy associated with mutations in the desmosomal gene desmocollin-2. *Am J Hum Genet*. 2006;79:978-84.
9. Asimaki A, Syrris P, Wichter T, Matthias P, Saffitz JE, McKenna WJ. A novel dominant mutation in plakoglobin causes arrhythmogenic right ventricular cardiomyopathy. *Am J Hum Genet*. 2007;81:964-73.
10. Asimaki A, Tandri H, Huang H, Halushka MK, Gautam S, Basso C, Thiene G, Tsatsopoulou A, Protonotarios N, McKenna WJ, Calkins H, Saffitz JE. A new diagnostic test for arrhythmogenic right ventricular cardiomyopathy. *N Engl J Med*. 2009;360:1075-84.
11. Basso C, Czarnowska E, Della Barbera M, Bauce B, Beffagna G, Wlodarska EK, Pilichou K, Ramondo A, Lorenzon A, Wozniak O, Corrado D, Daliento L, Danieli GA, Valente M, Nava A, Thiene G, Rampazzo A. Ultrastructural evidence of intercalated disc remodelling in arrhythmogenic right ventricular cardiomyopathy: an electron microscopy investigation on endomyocardial biopsies. *Eur Heart J*. 2006;27:1847-54.
12. Oxford EM, Musa H, Maass K, Coombs W, Taffet SM, Delmar M. Connexin43 remodeling caused by inhibition of plakophilin-2 expression in cardiac cells. *Circ Res*. 2007;101:703-11.
13. Garcia-Gras E, Lombardi R, Giocondo MJ, Willerson JT, Schneider MD, Khoury DS, Marian AJ. Suppression of canonical Wnt/beta-catenin signaling by nuclear plakoglobin recapitulates phenotype of arrhythmogenic right ventricular cardiomyopathy. *J Clin Invest*. 2006;116:2012-21.

14. De Bakker JM, van Capelle FJ, Janse MJ, Tasseron S, Vermeulen JT, de Jonge N, Lahpor JR. Slow conduction in the infarcted human heart. 'Zigzag' course of activation. *Circulation*. 1993;88:915-26.
15. Cabo C, Pertsov AM, Baxter WT, Davidenko JM, Gray RA, Jalife J. Wave-front curvature as a cause of slow conduction and block in isolated cardiac muscle. *Circ Res*. 1994;75:1014-28.
16. Fast VG and Kleber AG. Role of wavefront curvature in propagation of cardiac impulse. *Cardiovasc Res*. 1997;33:258-71.
17. Hamid MS, Norman M, Quraishi A, Firoozi S, Thaman R, Gimeno JR, Sachdev B, Rowland E, Elliott PM, McKenna WJ. Prospective evaluation of relatives for familial arrhythmogenic right ventricular cardiomyopathy/dysplasia reveals a need to broaden diagnostic criteria. *J Am Coll Cardiol*. 2002;40:1445-50.
18. Dalal D, Molin LH, Piccini J, Tichnell C, James C, Bomma C, Prakasa K, Towbin JA, Marcus FI, Spevak PJ, Bluemke DA, Abraham T, Russell SD, Calkins H, Judge DP. Clinical features of arrhythmogenic right ventricular dysplasia/cardiomyopathy associated with mutations in plakophilin-2. *Circulation*. 2006;113:1641-9.
19. Van Tintelen JP, Entius MM, Bhuiyan ZA, Jongbloed R, Wiesfeld AC, Wilde AA, van der Smagt J, Boven LG, Mannens MM, van Langen IM, Hofstra RM, Otterspoor LC, Doevendans PA, Rodriguez LM, van Gelder IC, Hauer RN. Plakophilin-2 mutations are the major determinant of familial arrhythmogenic right ventricular dysplasia/cardiomyopathy. *Circulation*. 2006;113:1650-8.
20. Syrris P, Ward D, Asimaki A, Sen-Chowdhry S, Ebrahim HY, Evans A, Hitomi N, Norman M, Pantazis A, Shaw AL, Elliott PM, McKenna WJ. Clinical expression of plakophilin-2 mutations in familial arrhythmogenic right ventricular cardiomyopathy. *Circulation*. 2006;113:356-64.
21. Den Haan AD, Tan BY, Zikusoka MN, Llado LI, Jain R, Daly A, Tichnell C, James C, Amat-Alarcon N, Abraham T, Russell SD, Bluemke DA, Calkins H, Dalal D, Judge DP. Comprehensive desmosome mutation analysis in North Americans with arrhythmogenic right ventricular dysplasia/cardiomyopathy. *Circ Cardiovasc Genet*. 2009;2:428-35.
22. Bauce B, Nava A, Beffagna G, Basso C, Lorenzon A, Smaniotto G, De Bortoli M, Rigato I, Mazzotti E, Steriotis A, Marra MP, Towbin JA, Thiene G, Danieli GA, Rampazzo A. Multiple mutations in desmosomal proteins encoding genes in arrhythmogenic right ventricular cardiomyopathy/dysplasia. *Heart Rhythm*. 2010;7:22-9.
23. Bhuiyan ZA, Jongbloed JD, van der Smagt J, Lombardi PM, Wiesfeld AC, Nelen M, Schouten M, Jongbloed R, Cox MG, van Wolferen M, Rodriguez LM, van Gelder IC, Bikker H, Suurmeijer AJ, van den Berg MP, Mannens MM, Hauer RN, Wilde AA, van Tintelen JP. Desmoglein-2 and desmocollin-2 mutations in Dutch arrhythmogenic right ventricular dysplasia/cardiomyopathy patients: Results from a multicenter study. *Circ Cardiovasc Genet*. 2009;2:418-27.
24. Fressart V, Duthoit G, Donal E, Probst V, Deharo JC, Chevalier P, Klug D, Dubourg O, Delacretaz E, Cosnay P, Scanu P, Extramiana F, Keller D, Hidden-Lucet F, Simon F, Bessirard V, Roux-Buisson N, Hebert JL, Azarine A, Casset-Senon D, Rouzet F, Lecarpentier Y, Fontaine G, Coirault C, Frank R, Hainque B, Charron P. Desmosomal gene analysis in arrhythmogenic right ventricular dysplasia/cardiomyopathy: spectrum of mutations and clinical impact in practice. *Europace*. 2010;12:861-8.
25. Marcus FI, McKenna WJ, Sherrill D, Basso C, Bauce B, Bluemke DA, Calkins H, Corrado D, Cox MG, Daubert JP, Fontaine G, Gear K, Hauer R, Nava A, Picard MH, Protonotarios N, Saffitz JE, Sanborn DM, Steinberg JS, Tandri H, Thiene G, Towbin JA, Tsatsopoulou A, Wichter T, Zareba W. Diagnosis of arrhythmogenic right ventricular cardiomyopathy/dysplasia: proposed modification of the task force criteria. *Circulation*. 2010;121:1533-41.

26. Fontaine G, Umemura J, Di Donna P, Tsezana R, Cannat JJ, Frank R. Duration of QRS complexes in arrhythmogenic right ventricular dysplasia. A new non-invasive diagnostic marker. *Ann Cardiol Angeiol (Paris)*. 1993;42:399-405.
27. Cox MG, Nelen MR, Wilde AA, Wiesfeld AC, van der Smagt JJ, Loh P, Cramer MJ, Doevendans PA, van Tintelen JP, de Bakker JM, Hauer RN. Activation delay and VT parameters in arrhythmogenic right ventricular dysplasia/cardiomyopathy: toward improvement of diagnostic ECG criteria. *J Cardiovasc Electrophysiol*. 2008;19:775-81.
28. Ramensky V, Bork P, Sunyaev S. Human non-synonymous SNPs: server and survey. *Nucleic Acids Res*. 2002;30:3894-900.
29. Ng PC and Henikoff S. SIFT: Predicting amino acid changes that affect protein function. *Nucleic Acids Res*. 2003;31:3812-4.
30. Syrris P, Ward D, Asimaki A, Evans A, Sen-Chowdhry S, Hughes SE, McKenna WJ. Desmoglein-2 mutations in arrhythmogenic right ventricular cardiomyopathy: a genotype-phenotype characterization of familial disease. *Eur Heart J*. 2007;28:581-8.
31. Van der Zwaag PA, Jongbloed JD, van den Berg MP, van der Smagt JJ, Jongbloed R, Bikker H, Hofstra RM, van Tintelen JP. A genetic variants database for arrhythmogenic right ventricular dysplasia/cardiomyopathy. *Hum Mutat*. 2009;30:1278-83.
32. Xu T, Yang Z, Vatta M, Rampazzo A, Beffagna G, Pilichou K, Scherer SE, Saffitz J, Kravitz J, Zareba W, Danieli GA, Lorenzon A, Nava A, Bauce B, Thiene G, Basso C, Calkins H, Gear K, Marcus F, Towbin JA, Multidisciplinary Study of Right Ventricular Dysplasia Investigators. Compound and digenic heterozygosity contributes to arrhythmogenic right ventricular cardiomyopathy. *J Am Coll Cardiol*. 2010;55:587-97.
33. Van der Zwaag PA, van Tintelen JP, Gerbens F, Jongbloed JD, Boven LG, van der Smagt JJ, van der Roest WP, van Langen IM, Bikker H, Hauer RN, van den Berg MP, Hofstra RM, te Meerman GJ. Haplotype sharing test maps genes for familial cardiomyopathies. *Clin Genet*. 2011;79:459-67.
34. Pelzer T, Schumann M, Neumann M, deJager T, Stimpel M, Serfling E, Neyses L. 17beta-estradiol prevents programmed cell death in cardiac myocytes. *Biochem Biophys Res Commun*. 2000;268:192-200.
35. Dalal D, James C, Devanagondi R, Tichnell C, Tucker A, Prakasa K, Spevak PJ, Bluemke DA, Abraham T, Russell SD, Calkins H, Judge DP. Penetrance of mutations in plakophilin-2 among families with arrhythmogenic right ventricular dysplasia/cardiomyopathy. *J Am Coll Cardiol*. 2006;48:1416-24.
36. Bauce B, Basso C, Rampazzo A, Beffagna G, Daliento L, Frigo G, Malacrida S, Settimo L, Danieli G, Thiene G, Nava A. Clinical profile of four families with arrhythmogenic right ventricular cardiomyopathy caused by dominant desmoplakin mutations. *Eur Heart J*. 2005;26:1666-75.

Supplementary data

Table I Follow-up frequencies of index patients and relatives

	Index Patients (n=147)		Relatives (n=302)	
	mean±SD	median (range)	mean±SD	median (range)
Intervals (years) between				
Visits	0.5±0.3	0.3 (0.2-1.2)	1.1±0.6	1 (0.3-5.0)
Echocardiography	3.6±2.3	2.8 (1.0-9.0)	1.7±1.5	1 (1.0-12)
Exercise Tests	3.1±2.0	2.5 (0.8-9.0)	2.6±2.1	2 (1.0-10)
24h Holter	5.1±4.7	2.5 (0.8-16)	2.6±2.0	2 (1.0-10)

Table II Unclassified variants

Gene	DNA change	Protein change	Type	PolyPhen (PSIC) [‡]	SIFT [†]	Index patients, n
Unclassified Variants						
PKP2	c.76G>A	p.Asp26Asn	Missense	+ (1.593)	0.15	2
	c.174G>T	p.Glu58Asp	Missense	- (1.248)	0.42	1
	c.759C>T	p.=	Silent			1
	c.1378G>A	p.Asp460Asn	Missense	- (0.0)	0.45	1
DSG2	c.1807A>C	p.Ile603Leu	Missense	- (1.157)	0.20	1
	c.1914G>T	p.Gln638His	Missense	+ (1.710)	0.01 [‡]	1
	c.2194T>G	p.Leu732Val	Missense	- (0.197)	0.15	2
	c.2393G>A	p.Arg798Gln	Missense	- (0.716)	0.00 [‡]	1
	c.2686_2687dupGA	p.Ala897LysfsX4	Frameshift			8
DSG2	c.445G>T	p.Val149Phe	Missense	+ (1.747)	0.00 [‡]	1
	c.473T>G	p.Val158Gly	Missense	++ (2.470)	0.00 [‡]	2
	c.783T>A	p.=	Silent			1
	c.889G>A	p.Asp297Asn	Missense	+ (1.951)	0.00 [‡]	1
	c.1003A>G	p.Thr335Ala	Missense	+ (1.559)	0.00 [‡]	3
	c.1072G>A	p.Ala358Thr	Missense	+ (1.760)	0.00 [‡]	1
	c.1174G>A	p.Val392Ile	Missense	- (0.813)	0.14	1
	c.1303G>A	p.Asp435Asn	Missense	- (1.459)	0.19	1
	c.1480G>A	p.Asp494Asn	Missense	+ (1.790)	0.00 [‡]	1
	c.2137G>A	p.Glu713Lys	Missense	+ (1.632)	0.09	1
	c.2194T>G	p.Phe732Val	Missense	- (0.217)	0.56	1
	c.2623A>G	p.Met875Val	Missense	- (0.682)	0.65	1
	c.2759T>G	p.Val920Gly	Missense	+ (1.936)	0.21	1
	DSP	c.105G>A	p.=	Silent		
c.269A>G		p.Gln90Arg	Missense	- (1.432)	0.00 [‡]	1
c.1696G>A		p.Ala566Thr	Missense	- (1.227)	0.00 [‡]	1
c.2346C>T		p.=	Silent			1
c.4372C>G		p.Arg1458Gly	Missense	+ (1.727)	0.03 [‡]	1
c.4775A>G		p.Lys1592Arg	Missense	- (1.047)	0.00 [‡]	1

Table II Unclassified variants (continued)

Gene	DNA change	Protein change	Type	PolyPhen (PSIC) [‡]	SIFT [†]	Index patients, n
<i>JUP</i>	c.5218G>A	p.Glu1740Lys	Missense	- (1.267)	0.00 [‡]	2
	c.5498A>T	p.Glu1833Val	Missense	+ (1.942)	0.00 [‡]	1
	c.6449C>G	p.Ala2150Gly	Missense	- (0.986)	0.08	1
	c.297G>A	p.=	Silent			1
	c.1359G>T	p.Glu453Asp	Missense	+ (1.616)	0.00 [‡]	1
	c.1563A>G	p.=	Silent			2
	c.1942G>A	p.Val648Ile	Missense	- (0.417)	1.00	1

* PolyPhen prediction: ++ probably damaging; + possibly damaging; - benign; PSIC indicates Position-Specific Independent Counts. † Sorting Intolerant From Tolerant (SIFT) prediction: Amino acids with scores < 0.05 are predicted to be deleterious. For previous reports on pathogeneity: see reference 31; ‡ This substitution may have been predicted to affect function just because the sequences used were not diverse enough. There is low confidence in this prediction.

Table III Clinical characteristics of ARVD/C probands with two pathogenic mutations

Sex	Mutations	Age first VT (years)	Depolarisation Abnormalities			Repolarisation Abnormalities		Arrhythmias	Structural Abnormalities
			ε	LP	TAD	Negative T waves V ₁ -V ₃	LBBB VT		
v	<i>PKP2</i> c.917-918delCC <i>DSC2</i> c.2587G>A					++	+	++	
v	<i>PKP2</i> c.2489+4A>C <i>DSP</i> c.1982A>T	20	++		+	++	++	++	
v	<i>DSC2</i> c.608G>A* <i>DSC2</i> c.608G>A*	17	++		+	++	+	++	

ε = epsilon waves, LP= late potentials, TAD = prolonged terminal activation duration; LBBB VT: ventricular tachycardia with left bundle branch block morphology
+ minor criterion, ++ major criterion; * homozygous, parents were first degree cousins

Table IV Combinations of pathogenic mutations and/or unclassified variants

<i>PKP2</i>	<i>DSC2</i>	<i>DSG2</i>	<i>DSP</i>	<i>JUP</i>
2 Mutations				
c.917_918delCC	c.2587G>A			
c.2489+4A>C			c.1982A>T	
	c.608G>A*			
1 Mutation + 1 UV				
deletion exon 8	c.2686_2687dupGA			
deletion exon 1-14		<i>c.1072G>A</i>		
c.148_151delACAG	c.2686_2687dupGA			
c.235C>T	c.2686_2687dupGA			
c.235C>T		<i>c.1003A>G</i>		
c.235C>T		<i>c.1174G>A</i>		
c.397C>T		<i>c.1480G>A</i>		
c.397C>T		<i>c.2623A>G</i>		
c.397C>T		<i>c.2759T>G</i>		
c.917_918delCC		<i>c.473T>G</i>		
c.1211-1212insT	<i>c.2194T>G</i>			
c.1211-1212insT	c.2686_2687dupGA			
c.1211-1212insT			<i>c.269A>G</i>	
c.1211-1212insT			<i>c.5218G>A</i>	
c.1848C>A				<i>c.1942G>A</i>
c.2146-1G>C			<i>c.1696G>A</i>	
c.2386T>C		<i>c.1003A>G</i>		
c.2386T>C				<i>c.297G>A</i>
c.2421C>A	c.2686_2687dupGA			
c.2489+1G>A		<i>c.1303G>A</i>		
c.2489+4A>C			<i>c.5218G>A</i>	
c.2489+1G>A				<i>c.1563A>G</i>
c.2544G>A	c.2686_2687dupGA			
	c.943-1G>A		<i>c.6449C>G</i>	
		c.874C>T	<i>c.2346C>T</i>	
		c.137G>A + c.473T>G		
		c.137G>A + c.473T>G		
			c.3337C>T + c.4372C>G	
2 UVs				
	<i>c.2194T>G</i>	<i>c.1174G>A</i>		
		<i>c.445G>T</i>		<i>c.1359G>T</i>

UV= unclassified variant; In bold: (most likely) pathogenic mutations; In *italics*: missense and silent variants.

* homozygous, parents were first degree cousins

Table V Clinical characteristics of ARVD/C index patients related to pathogenic mutations and unclassified variants

	Mutations and unclassified variants (UVs)				
	0	UV	1	1+UV	2
n	40	20	55	29	3
% male	81	76	78	66	0
Age of onset (years±SD)	41±14	38±12	35±12	34±15	17±3
	n (%)	n (%)	n (%)	n (%)	n (%)
Epsilon wave †	7 (24)	1 (6)	10 (19)	2 (7)	2 (67)
Late potentials ‡	14 (47)	8 (67)	11 (31)	11 (52)	0
Prolonged TAD†	24 (83)	10 (56)	30 (57)	12 (52)	2 (67)
Negative T waves V₁-V₃ †	18 (62)	11 (61)	45 (85)	21 (72)	3 (100)
Negative T waves V₁-V₂ †	1 (3)	2 (11)	4 (8)	1 (3)	0
Negative T waves V₄-V₆ †	1 (3)	2 (11)	1 (2)	1 (3)	0
LBBB VT superior axis	17 (43)	11 (55)	24 (44)	14 (48)	1 (33)
LBBB VT	34 (85)	18 (90)	48 (87)	26 (90)	3 (100)
>500 PVCs per 24h	9 (23)	4 (20)	14 (25)	5 (17)	1 (33)
Structural major TFC	17 (43)	14 (70)	32 (58)	20 (69)	3 (100)
Structural minor TFC	8 (20)	2 (10)	12 (22)	3 (10)	0

† ECGs while off drugs were available for 125 probands; ‡ In 81 patients late potentials were measured: 69 by SAECC, 12 by mapping during EPS; TAD: terminal activation duration, LBBB VT: ventricular tachycardia with left bundle branch block morphology, PVCs: premature ventricular complexes, TFC: Task Force Criteria.

7

Phospholamban R14del mutation in patients diagnosed with dilated cardiomyopathy or arrhythmogenic right ventricular cardiomyopathy: Evidence supporting the concept of arrhythmogenic cardiomyopathy

Paul A. van der Zwaag
Ingrid A.W. van Rijsingen
Angeliki Asimaki
Jan D.H. Jongbloed
Dirk J. van Veldhuisen
Ans C.P. Wiesfeld
Moniek G.P.J. Cox
Laura. T. van Lochem
Rudolf A. de Boer
Robert M.W. Hofstra
Imke Christiaans
Karin Y. van Spaendonck-Zwarts
Ronald H. Lekanne dit Deprez
Daniel P. Judge
Hugh Calkins
Albert J.H. Suurmeijer
Richard N.W. Hauer
Jeffrey E. Saffitz
Arthur A.M. Wilde
Maarten P. van den Berg
J. Peter van Tintelen

Eur J Heart Fail. In Press.

ABSTRACT

Aims To investigate whether phospholamban gene (*PLN*) mutations underlie patients diagnosed with either arrhythmogenic right ventricular cardiomyopathy (ARVC) or idiopathic dilated cardiomyopathy (DCM).

Methods and Results We screened a cohort of 97 ARVC and 257 DCM unrelated index patients for *PLN* mutations and evaluated their clinical characteristics. *PLN* mutation R14del was identified in 12 (12%) ARVC patients and in 39 (15%) DCM patients. Haplotype analysis revealed a common founder, estimated to be between 575 and 825 years old. A low voltage ECG was present in 46% of R14del carriers. Compared to R14del- DCM patients, R14del+ DCM patients more often demonstrated appropriate ICD discharge (47% vs. 10%, $P<0.001$), cardiac transplantation (18% vs. 2%, $P<0.001$), and a family history of sudden cardiac death (SCD) <50 years (36% vs. 16%, $P=0.007$). We observed a similar pattern in the ARVC patients although this was not statistically significant. The average age of 26 family members who died of SCD was 37.7yr. Immunohistochemistry in available myocardial samples revealed absent/depressed plakoglobin levels at intercalated disks in five of seven (71%) R14del+ ARVC samples, but in only one of nine (11%) R14del+ DCM samples ($P=0.03$).

Conclusions The *PLN* R14del founder mutation is present in a substantial number of patients clinically diagnosed with DCM or ARVC. R14del+ patients diagnosed with DCM showed an arrhythmogenic phenotype and SCD at young age can be the presenting symptom. These findings support the concept of 'arrhythmogenic cardiomyopathy'.

INTRODUCTION

Idiopathic dilated cardiomyopathy (DCM) and arrhythmogenic right ventricular cardiomyopathy (ARVC) are clinically heterogeneous diseases of the myocardium, associated with mechanical and/or electrical dysfunction.¹ Clinically, ARVC is characterised by ventricular arrhythmias, predominantly from the right ventricle (RV) and sudden cardiac death, often preceding structural changes.²⁻⁵ DCM, on the other hand, is characterised by left ventricular (LV) contractile dysfunction and progressive heart failure, with arrhythmias often being present but less prominent.⁶ The management strategies of ARVC and DCM therefore differ. For ARVC, the aim is to prevent sudden cardiac death and ventricular tachycardia, by using an implantable cardioverter defibrillator (ICD) or anti-arrhythmic pharmacological treatment.³ The management of DCM is mainly directed at treating heart failure symptoms and preventing disease progression and related complications.^{6,7} ICD implantation as primary prevention is recommended in patients in New York Heart Association (NYHA) functional class II or III, who are receiving optimal medical therapy and have an LV ejection fraction $\leq 30\%$ (American College of Cardiology/American Heart Association; ACC/AHA) or $\leq 35\%$ (European Society of Cardiology; ESC).^{7,8}

Although considered separate entities by both the AHA and the ESC,^{1,9} DCM and ARVC have overlapping clinical features. Classic ARVC shows primarily RV involvement. However, histopathologic and functional LV involvement is present in 76%-84% of ARVC patients. Also left-dominant forms exist leading to the postulation that left-dominant arrhythmogenic cardiomyopathy is a separate entity.^{10,11} Finally, at the molecular level (desmosomal proteins, gap junctions) both ventricles are affected in a similar way in ARVC.¹² The principal discriminating feature of left-dominant arrhythmogenic cardiomyopathy from DCM would be the predisposition to ventricular arrhythmias in early stages of the disease, disproportionate to the morphological abnormalities and impaired systolic function.^{5,11,13} Conversely, deteriorating RV function is a strong predictor of worse outcome in DCM.¹⁴

Comprehensive screening of desmosomal genes in ARVC patients has identified pathogenic mutations in 40-58% of clearly affected patients.¹⁵⁻¹⁷ Given the clinical overlap between ARVC and DCM, we focused on non-desmosomal genes known to lead to DCM with an arrhythmogenic phenotype and which could potentially explain genetically unsolved ARVC cases. So far, mutations in over 30 different genes have been reported to cause DCM,^{6,18} including the gene encoding phospholamban (*PLN*). *PLN* is a regulator of the sarcoplasmic reticulum Ca^{2+} -ATPase (SERCA2a) pump in cardiac muscle and thus important for maintaining Ca^{2+} homeostasis.¹⁹ In DCM, three different *PLN* mutations have been identified;²⁰⁻²³ the cardiac phenotype of *PLN* mutation carriers was characterised by the presence of malignant ventricular

arrhythmias and interstitial fibrosis. We therefore screened both DCM and ARVC patients for *PLN* mutations and compared their clinical and genetic characteristics.

METHODS

Patients

A cohort of index patients, referred to Departments of Clinical Genetics of three university hospitals (University Medical Center Groningen, Academic Medical Center Amsterdam, and University Medical Center Utrecht, the Netherlands), by the attending cardiologist (heart failure specialists or cardiac electrophysiologists), was evaluated. No index patient within the cohort had a known familial relationship with any other index patient in the cohort. Retrospectively, available data on medical history, physical examination, 12-lead ECG, echocardiography, Holter monitoring, exercise testing, signal-averaged ECG, nuclear scintigraphy, magnetic resonance imaging and/or RV-angiography studies were collected. Age of presentation was defined as the age when the first symptoms or signs most likely to be attributable to the disease occurred. For DCM, the diagnostic criteria by Mestroni *et al.* were used.²⁴ For ARVC, recently modified task force criteria were used.²⁵ Two patients who did not fulfil the modified criteria because histomorphometric analyses of myocardial tissue had not been performed, were nonetheless considered as having ARVC, since they were previously diagnosed with ARVC, based on original task force criteria. The study complied with the Declaration of Helsinki and was approved by the local institutional review committees and informed consent was obtained from all participants.

Electrocardiograms

ECGs from index patients and their relatives were analysed and interpreted in a blinded fashion by two cardiologists (R.A.d.B and M.P.v.d.B.) Low voltage on the ECG was defined as QRS peak-to-peak amplitude in leads I, II, and III being less than 0.5mV.

Genetic analysis

Genomic DNA was isolated from peripheral blood samples according to standard protocols. Bidirectional direct sequencing of the coding region of *PLN* was performed in all index patients using a BigDye Terminator DNA sequencing kit (version 2.0) on a 3730 Genetic Analyzer (Applied Biosystems, Foster City, CA, U.S.A.). To assess the prevalence of *PLN* mutations in a United States cohort, 46 desmosomal

gene negative ARVC index patients were screened. A total of 473 anonymous ethnically matched controls were also screened.

Nine microsatellite markers around *PLN* were selected for haplotype analysis. Primers and conditions are available upon request. The availability of DNA of relatives enabled the verification of the phase and reconstruction of haplotypes. Haplotype analysis was also performed in previously described DCM families from Greece and Germany.^{22,23} The method described by Machado et al. was used to calculate the age of the haplotype.²⁶

Besides *PLN* analysis, DCM index patients were screened for mutations in the most frequently mutated genes in DCM: *LMNA*, *MYH7*, and *TNNT2*. All ARVC index patients were also screened for mutations in *PKP2*, *DSC2*, *DSG2*, *DSP*, and *JUP*. Primers and PCR conditions are available upon request.

Immunohistochemistry and histology

Formalin-fixed, paraffin-embedded myocardium samples were available from a subset of the ARVC and DCM patients carrying a *PLN* mutation and were used for immunohistochemical staining. Samples were analysed and interpreted in a blinded fashion. Information regarding antibodies and immunohistochemical protocols has been described before.¹² Available complete hearts from transplant procedures or autopsies were analysed for signs of lipofibromatosis.

Statistical analysis

Mutation rates in patients versus controls, clinical characteristics and ECG parameters of mutation-carrying index patients versus non-carriers were compared by either the Student's t-test or Fisher's exact test. Values of $P < 0.05$ were considered significant. All the data were analysed with PASW 18.0 software (SPSS, Chicago, IL, U.S.A.).

RESULTS

Patients and genetic analysis

A total of 354 unrelated index patients were evaluated; 257 diagnosed with DCM and 97 with ARVC. A 3bp deletion of *PLN* (c.40_42delAGA; p.R14del) was identified in 39 (15%) DCM index patients and 12 (12%) ARVC index patients. R14del was found in one of 473 control samples ($P < 10^{-18}$). None of the 39 R14del+ DCM patients had a mutation in *LMNA*, *MYH7*, or *TNNT2*, and none of the 12 R14del+ ARVC patients had a mutation in *PKP2*, *DSC2*, *DSG2*, *DSP*, or *JUP*. In addition, one of 46 (2%) ARVC index patients from the United States also carried the *PLN* R14del mutation.

Table 1 Modified task force criteria for the diagnosis of ARVC and Mestroni criteria for the diagnosis of DCM in *PLN R14del* mutation carriers

Index patient	Modified Task Force Criteria for ARVC							Mestroni DCM Criteria		
	Function	Tissue*	Repolarisation	Depolarisation	Rhythm	Family history	TfC (maj/min)	LVEF <45%	FS <25%	LVEDD >117%
DCM										
D01							0/0	++	++	++
D02			+		+		0/2	++		++
D03			+	+	+		0/3	++	++	++
D04 [‡]			+		+		0/2	++	++	+
D05							0/0	++	++	++
D06			+		+		0/2	++		++
D07			+		+		0/2	++	++	++
D08 [‡]					+		0/1	++	++	
D09			+	+	+		0/3	++	++	++
D10			+		+		0/2	++	++	++
D11							0/0	++	++	++
D12							0/0	++	++	++
D13			+		+		0/2	++	++	++
D14			+				0/1	++	++	++
D15							0/0	++	++	++
D16			+				0/1	++	++	++
D17					+		0/1	++	++	++
D18							0/0	++	++	++
D19							0/0	++	++	++
D20							0/0	++	++	++
D21							0/0	++	++	++
D22			++		+		1/1	++	+	++
D23			+				0/1	++		++
D24					+		0/1	++	++	++
D25			+		+		0/2	++		++
D26			+				0/1	++		++
D27			+		+		0/2	++	++	++
D28			+		+		0/2	++		++
D29					+		0/1	++	++	++
D30							0/0	++	++	++
D31			+				0/1	++	++	++
D32			+				0/1	++	++	++
D33							0/0	++	++	++
D34			+	+	+		0/3	++	++	++
D35			+		++		1/1	++		++
D36			+		+		0/2	++	++	++
D37					+		0/1	++		++
D38			+		+		0/2	++	++	++
D39			+		+		0/2	++		++

Table 1 Modified task force criteria for the diagnosis of ARVC and Mestroni criteria for the diagnosis of DCM in *PLN R14del* mutation carriers (continued)

Index patient	Modified Task Force Criteria for ARVC							Mestroni DCM Criteria		
	Function	Tissue*	Repolarisation	Depolarisation	Rhythm	Family history	TFC (maj/min)	LVEF <45%	FS <25%	LVEDD >117%
ARVC										
A01	++		++		+	++	3/1	++		
A02	++		++	+	++		3/2	++		
A03			+		+	++	1/2			
A04	++		++	+	+		2/2			
A05			++	+	+		1/2			
A06			++	++	+		2/1			
A07			++		++	+	2/1			
A08	++			++	+		2/1	++		
A09	++		++	++			3/0	++		
A10#				+	+	+	0/3			
A11				+	+	++	1/2			
A12#	+		+	+			0/3			
USA			+		+	++	1/2			

++ Indicates major criterion; +, minor criterion; only the presence of a criterion is indicated; LVEDD, left ventricular end-diastolic diameter; LVEF: left ventricular ejection fraction; FS, fractional shortening; TFC, modified task force criteria;

A definite diagnosis ARVC is fulfilled by the presence of 2 major, or 1 major plus 2 minor criteria or 4 minor criteria from different groups.; Borderline diagnosis: 1 major and 1 minor or 3 minor criteria from different categories; possible diagnosis: 1 major or 2 minor criteria from different categories.²⁵

The diagnosis of DCM is based on the presence of two major criteria: 1. LVEF <45% and/or FS <25%, and 2. LVEDD >117% of the predicted value corrected for age and body surface area. The diagnosis of familial DCM is made in the presence of ≥ 2 affected individuals in a single family or in the presence of a first-degree relative, with well documented unexplained sudden death at <35 years of age. Members of families with familial DCM are considered affected in the presence of the major criteria or LVEDD >117% +one minor criterion or three minor criteria.²⁴

* Not available, since available biopsies were all taken from the interventricular septum instead of the RV free wall and histomorphometric analyses had not been performed. † LVEDD <117%; affected familial DCM cases. # Fulfilled the original TFC but not the modified TFC, because histomorphometric analyses of myocardial tissue had not been performed.

Haplotype analysis was performed in 36 (71%) of the Dutch R14del+ index patients, the patient from the United States, and in published Greek and German DCM families.^{22,23} A shared haplotype for five markers in a 1.2 Mb region surrounding *PLN* was found, although in two patients either the size of one or more markers had changed or a recombination had occurred. The parental ancestry of the R14del+ patient from the United States was German/Norwegian. The Greek patients had a different haplotype (See Supplementary Table S1). Allowing 25 years per generation, the age of the haplotype containing the mutation is estimated to be between 575 and 825 years old.

Clinical data

Detailed clinical data of all 52 R14del+ patients (51 Dutch, 1 American) are given in Supplementary Table S2. Twenty-nine (56%) were female, the mean age at presentation was 44.3 ± 12.6 year, and mean follow-up was 9.2 (range 0-26) years. The R14del+ index patients mainly presented with ventricular tachycardia/fibrillation (VT/VF) (n=18), heart failure (n=11) or syncope (n=3), or were identified after family screening following sudden cardiac death (n=7). Notably, three of five patients who presented with VF were <30yr. Table 1 lists the ARVC and DCM criteria for all 52 R14del+ index patients. When evaluating retrospectively, five R14del+ patients diagnosed with DCM had a borderline diagnosis of ARVC (i.e. 1 major and 1 minor or 3 minor criteria) and 12 had a possible diagnosis of ARVC (2 minor criteria) at the time of DCM diagnosis. A criterion for abnormal repolarisation was present in 23 (59%) and a criterion for arrhythmia in 22 (56%). A description of arrhythmias present at baseline in R14del+ DCM patients is given in Supplementary Table S3. In summary, a sustained or non-sustained VT or VF was present at baseline in 18/39 (46%). In addition, although this is not an ARVC criterion as such, 15 (38%) R14del+ DCM patients showed RV dilatation. At time of ARVC diagnosis, four R14del+ ARVC patients had impaired LV systolic function; none of them had LV dilatation.

A clinical diagnosis of DCM was made in family members of 21 of 39 (54%) DCM index patients, whereas in family members of 2 of 13 (15%) ARVC index patients a clinical diagnosis of ARVC was made. None of the DCM index patients had a family member with the clinical diagnosis of ARVC; one ARVC index patient had a parent diagnosed with DCM. The average age of the 26 family members who died of SCD was 37.7yr. Details on family history are given in Supplementary Table S4.

For both the DCM and ARVC groups, R14del+ index patients did not differ from R14del- index patients regarding age at presentation or sex (data not shown). Figure 1 shows their arrhythmia-related characteristics. Compared to R14del- DCM patients, R14del+ DCM patients more often had a positive family history for sudden cardiac death below age 50 in first- and second-degree relatives and more often

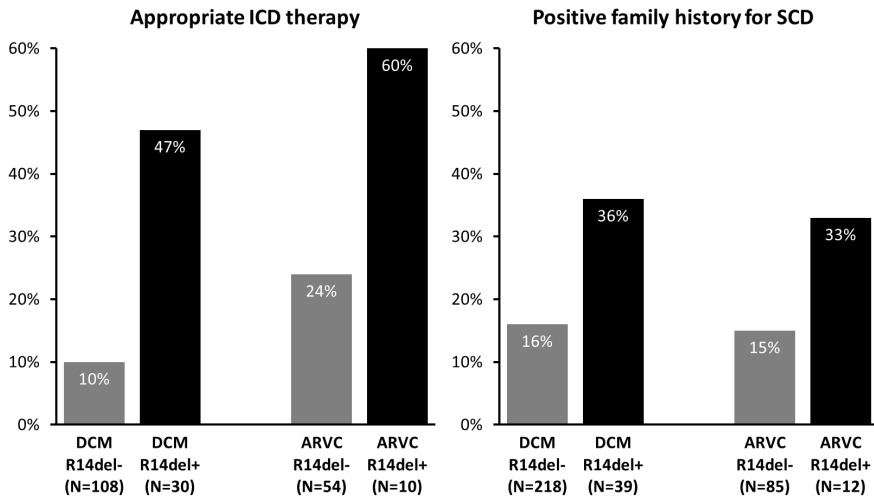

Figure 1 Arrhythmia related characteristics for both the DCM and ARVC groups. The left panel shows the rates of appropriate ICD discharge in patients carrying an ICD. In the DCM cohort, 108 *PLN* R14del- patients and 30 *PLN* R14del+ index patients underwent ICD implantation (48% vs. 77%, $P=0.003$) and in the ARVC cohort, these numbers were 54 and 10 (64% vs. 83%, $P=0.21$), respectively. The difference in the rates of appropriate ICD discharge reached statistical significance for the DCM cohort (10% vs. 47%, $P<0.001$), but not for the ARVC cohort (24% vs. 60%, $P=0.053$). The right panel shows family history for sudden cardiac death <50 years in first- and second-degree relatives. This difference reached statistical significance for the DCM cohort (16% vs. 36%, $P=0.007$), but not for the ARVC cohort (15% vs. 33%, $P=0.22$).

experienced an appropriate ICD discharge. Furthermore, R14del+ DCM patients more often underwent cardiac transplantation (18% vs. 2%, $P<0.001$).

Within the ARVC group, R14del mutation carriers had more severe arrhythmia characteristics yet these were not statistically significant when compared to non-carriers. Comparing R14del+ DCM patients to R14del+ ARVC patients did not reveal differences in these parameters.

Electrocardiograms

In 46% of *PLN* R14del+ index patients a low voltage ECG at baseline was found. Inverted T waves as listed in the modified task force criteria for ARVC,²⁵ were present in 29 (57%) patients, 19 of them showed inverted T waves in the left precordial leads (V4-V6) (Supplementary Table S5). Holter monitoring was performed in 40 R14del+ index patients; >500 ventricular extrasystoles per 24 hours, another diagnostic ARVC criterion, were present in 26 (65%).

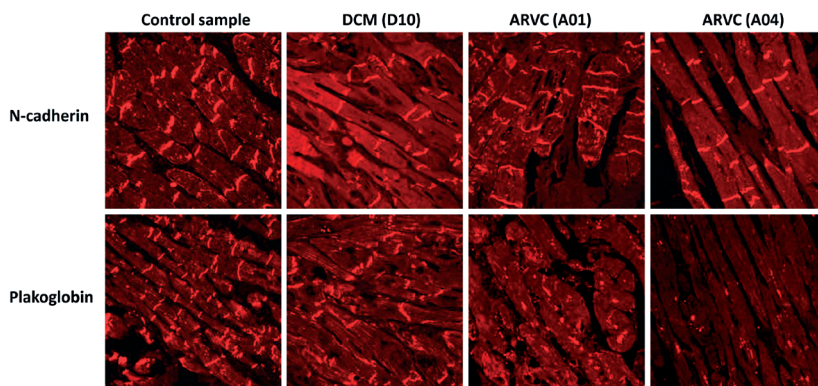

Figure 2 Immunofluorescence images of endomyocardial-biopsy samples from two patients (A01 and A04) diagnosed with ARVC and one with DCM (D10), all carrying the *PLN* R14del mutation, compared to a control sample. Representative images from a blinded analysis of endomyocardial-biopsy samples show that immunoreactive signal levels for plakoglobin in two subjects with ARVC differ from the signal levels in a control subject and a subject with DCM. N-cadherin serves as a tissue control marker. Numbers in parentheses correspond to the subject numbers in Table S2 in the Data Supplement.

Table 2 Immunohistochemical diagnoses in blinded analysis of cardiac specimens from patients with DCM and ARVC, carrying the *PLN* R14del mutation

Family ID	Patient	Sample type	Immunofluorescent signal for Plakoglobin	Diagnostic Test
D01	1st degree relative	RV biopsy	normal	negative
D03	Index	RV biopsy	depressed	positive
D08	Index	explanted heart	normal	negative
D09	Index	RV biopsy	normal	negative
D10	Index	RV biopsy	normal	negative
D11	2nd degree relative	RV biopsy	normal	negative
D15	Index	RV biopsy	normal	negative
D16	1st degree relative	autopsy	normal	negative
D20	Index	RV biopsy	normal	negative
A01	Index	RV biopsy	absent	positive
A02	Index	RV biopsy	absent	positive
A03	Index	RV biopsy	absent	positive
A04	Index	RV biopsy	absent	positive
A06	Index	RV biopsy	normal	negative
A10	Index	RV biopsy	normal	negative
A11	Index	RV biopsy	very depressed	positive

Family ID corresponds with index patients. Patient denotes index patient or the degree of relationship of an affected family member. RV indicates right ventricle. Positive diagnostic tests are in bold.

Immunohistochemistry and histology

Immunohistochemistry revealed absent or markedly reduced immunoreactive signal levels for the desmosomal protein plakoglobin at intercalated disks in 5 of 7 (71%) R14del+ ARVC samples. However, only 1 of 9 (11%) R14del+ DCM samples showed depressed signal levels ($P=0.03$) (Figure 2 and Table 2). An overview of reported histological findings in RV biopsies from *PLN* R14del index patients are given in Supplementary Table S6.

DISCUSSION

The distinction of DCM and ARVC as separate clinical entities, which is made by both the AHA and the ESC,^{1,9} has important implications for clinical practice, guiding both diagnostics and treatment. However, the considerable overlap encountered between different disease subtypes is an inevitable limitation of any classification.¹ The main finding of this study is that patients clinically labelled with different diagnoses (i.e. DCM or ARVC) based upon accepted clinical criteria, carry an identical mutation: *PLN* R14del. This specific mutation has extensively been studied in a mouse model by Haghighi *et al*; transgenic mice overexpressing this mutation exhibited depressed cardiac function, histopathologic abnormalities (fibrosis) and premature death, recapitulating the phenotype of the family they described.²²

As phospholamban is a Ca^{2+} -ATPase regulator, Ca^{2+} homeostasis might play an important role in the pathogenesis in R14del+ patients. Ca^{2+} regulates the assembly and disassembly of the desmosome: it is likely that both extracellular and cytoplasmic Ca^{2+} levels are important for cell-cell junction formation.²⁷ Superinhibition of SERCA2a activity by mutant *PLN* leads to reduced Ca^{2+} uptake into the sarcoplasmic reticulum,²² which could consequently result in desmosomal disassembly due to elevated cytoplasmic Ca^{2+} levels and/or impaired Ca^{2+} homeostasis.

Phenotype of R14del mutation carriers

The R14del mutation has previously been associated with a low-voltage ECG,²³ which was also present in 46% of the R14del+ index patients described in this study. The substrate for these low-voltage ECGs and the observed arrhythmogenic phenotype may be the presence of cardiac fibrosis, which was a frequent finding at histological examination and has also been found in the R14del mouse model.²²

When compared to non-carrier DCM patients, patients diagnosed with DCM carrying *PLN* R14del exhibit an arrhythmogenic phenotype. This is reflected by high rates of ventricular tachycardia/fibrillation as presenting symptom, appropriate ICD interventions and positive family history for premature sudden cardiac death. In

addition, more R14del+ DCM patients underwent cardiac transplantation compared to R14del- DCM patients, further attesting to the malignancy of this mutation. R14del+ patients diagnosed with ARVC showed a severe arrhythmogenic phenotype comparable to non-carrier ARVC patients.

Two different diagnoses or a single entity?

In cardiological practice, the diagnostic label of either DCM or ARVC is often determined by the initial presentation e.g. heart failure symptoms or arrhythmias, and this was probably also the case in the patients presented in this study. Those presenting with symptomatic ventricular arrhythmias were probably analysed with ARVC in mind, whereas patients with asymptomatic arrhythmias could have progressed towards heart failure and were more likely to be diagnosed as DCM. Ventricular ectopy and nonsustained VT could have been asymptomatic and not all patients diagnosed with DCM underwent Holter monitoring to detect arrhythmias. Follow-up by either an electrophysiologist in case of an ARVC diagnosis or heart failure-oriented cardiologist in case of a DCM diagnosis, may have led to findings that seemed to confirm whichever diagnosis was first considered. However, in retrospect a clear overlap was already present at the time of diagnosis (Table 1). In addition to similar arrhythmia related characteristics (Figure 1), five R14del+ DCM patients had a borderline diagnosis of ARVC and 12 had a possible diagnosis of ARVC at the time of DCM diagnosis. Moreover, RV dilatation was present in 15 (38%) R14del+ DCM patients. Conversely, four R14del+ ARVC patients had impaired LV systolic function. These clinical findings suggest a single yet variable disease entity rather than two separate diagnoses, which is in agreement with the finding of a single underlying mutation, i.e. *PLN* R14del.

Taken together, our results support the concept of ‘arrhythmogenic cardiomyopathy’ as an entity encompassing ARVC, including left dominant arrhythmogenic cardiomyopathy, and arrhythmogenic forms of DCM.^{5,28}

Immunohistochemical differences

Within this *PLN* R14del related arrhythmogenic cardiomyopathy spectrum on the immunohistochemical level, samples from *PLN* R14del+ patients diagnosed with ARVC showed reduced plakoglobin signal levels in the majority (5 of 7) of cases, which is compatible with previous observations in ARVC,¹² whereas only one of nine R14del+ patients with a clinical diagnosis of DCM showed identical findings ($P=0.03$). Diminished plakoglobin signal at intercalated disks appears to track with the ARVC phenotype rather than genotypes. Other unknown genetic, epigenetic, or environmental factors, such as strenuous exercise, may either cause reduced plakoglobin levels, guiding the phenotype towards ARVC related manifestations (and

diagnosis), or alternatively, these factors lead to a more arrhythmogenic phenotype leading to a clinical diagnosis of ARVC and secondary reduced plakoglobin levels. We have excluded the co-occurrence of mutations in desmosomal genes in the ARVC patients as a cause for the reduced plakoglobin levels. Failure of plakoglobin to localise correctly in ARVC suggests a final common pathway in which desmosomal instability, caused by mutations in genes encoding either desmosomal proteins or other proteins such as *PLN*, leads to a subcellular redistribution of plakoglobin, which is believed to play a pivotal role in altered signalling pathways.^{5,29}

Implications for diagnostics and therapy

By providing evidence for the concept of arrhythmogenic cardiomyopathy, our results may have important diagnostic implications. The modified task force criteria for ARVC diagnosis are not designed to discriminate between different cardiomyopathy subtypes and do not contain a criterion for LV involvement with the exception of inverted T waves in V4-6,²⁵ while RV involvement is not included in the criteria for DCM.²⁴ We therefore call for the formulation of criteria for the diagnosis of arrhythmogenic cardiomyopathy, encompassing ARVC and arrhythmogenic forms of DCM. Regarding the therapeutic implications, the ESC's 2008 heart failure guidelines recommended ICD implantation for primary prevention in non-ischemic cardiomyopathy, to reduce mortality in patients with an LV ejection fraction $\leq 35\%$, in NYHA functional class II or III.⁸ In our cohort, 44% of R14del+ DCM patients carrying an ICD had experienced an appropriate shock. This warrants caution with R14del+ DCM patients with a relatively preserved LV function ($>30\text{-}35\%$).

Study limitations

As mentioned above, in DCM patients, RV function and arrhythmias were not systematically investigated, as was the case for LV function in ARVC patients, reflecting everyday clinical practice. In addition, the included patients had all been referred to tertiary referral centers, and thus possibly reflecting the more severe end of the disease spectrum. Family members were not systematically investigated in this study.

Global relevance

We identified the *PLN* R14del founder mutation in a substantial percentage of Dutch ARVC and DCM patients (12% and 15%, respectively), and were able to confirm this in an ARVC patient from the United States. The haplotype containing this mutation was estimated to be over 575 years old, showing that all R14del+ mutation carriers are distantly related, and was also present in patients from the United States and Germany. In addition, emigration of Dutch mutation carriers in the 19th and early 20th century, not only to the United States but also to Canada, South-Africa, Austra-

lia and New-Zealand, could have resulted in R14del mutation carriers on multiple continents.

CONCLUSION

This is the first study to describe a role for *PLN* in ARVC. R14del+ patients diagnosed with DCM showed an arrhythmogenic phenotype. These findings support the concept of 'arrhythmogenic cardiomyopathy'.

Acknowledgements

We thank the patients and their relatives who made this work possible, Dr. M.G. Posch and Dr. E.G. Kranias for providing DNA samples, and Jackie Senior for editing the manuscript. This study was supported by grants from the Netherlands Heart Foundation (2007B132), the Van Buchem Foundation, and the National Institutes of Health (HL102361).

REFERENCES

1. Maron BJ, Towbin JA, Thiene G, Antzelevitch C, Corrado D, Arnett D, Moss AJ, Seidman CE, Young JB. Contemporary definitions and classification of the cardiomyopathies: an American Heart Association Scientific Statement from the Council on Clinical Cardiology, Heart Failure and Transplantation Committee; Quality of Care and Outcomes Research and Functional Genomics and Translational Biology Interdisciplinary Working Groups; and Council on Epidemiology and Prevention. *Circulation*. 2006;113:1807-16.
2. Thiene G, Nava A, Corrado D, Rossi L, Pennelli N. Right ventricular cardiomyopathy and sudden death in young people. *N Engl J Med*. 1988;318:129-33.
3. Basso C, Corrado D, Marcus FI, Nava A, Thiene G. Arrhythmogenic right ventricular cardiomyopathy. *Lancet*. 2009;373:1289-300.
4. Marcus FI, Zareba W, Calkins H, Towbin JA, Basso C, Bluemke DA, Estes NA, III, Picard MH, Sanborn D, Thiene G, Wichter T, Cannom D, Wilber DJ, Scheinman M, Duff H, Daubert J, Talajic M, Krahn A, Sweeney M, Garan H, Sakaguchi S, Lerman BB, Kerr C, Kron J, Steinberg JS, Sherrill D, Gear K, Brown M, Severski P, Polonsky S, McNitt S. Arrhythmogenic right ventricular cardiomyopathy/dysplasia clinical presentation and diagnostic evaluation: results from the North American Multidisciplinary Study. *Heart Rhythm*. 2009;6:984-92.
5. Saffitz JE. The pathobiology of arrhythmogenic cardiomyopathy. *Annu Rev Pathol*. 2011;6:299-321.
6. Jefferies JL and Towbin JA. Dilated cardiomyopathy. *Lancet*. 2010;375:752-62.
7. Hunt SA. ACC/AHA 2005 guideline update for the diagnosis and management of chronic heart failure in the adult: a report of the American College of Cardiology/American Heart Association Task Force on Practice Guidelines (Writing Committee to Update the 2001 Guidelines for the Evaluation and Management of Heart Failure). *J Am Coll Cardiol*. 2005;46:e1-82.
8. Dickstein K, Cohen-Solal A, Filippatos G, McMurray JJ, Ponikowski P, Poole-Wilson PA, Stromberg A, van Veldhuisen DJ, Atar D, Hoes AW, Keren A, Mebazaa A, Nieminen M, Priori SG, Swedberg K. ESC guidelines for the diagnosis and treatment of acute and chronic heart failure 2008: the Task Force for the diagnosis and treatment of acute and chronic heart failure 2008 of the European Society of Cardiology. Developed in collaboration with the Heart Failure Association of the ESC (HFA) and endorsed by the European Society of Intensive Care Medicine (ESICM). *Eur J Heart Fail*. 2008;10:933-89.
9. Elliott P, Andersson B, Arbustini E, Bilinska Z, Cecchi F, Charron P, Dubourg O, Kuhl U, Maisch B, McKenna WJ, Monserrat L, Pankuweit S, Rapezzi C, Seferovic P, Tavazzi L, Keren A. Classification of the cardiomyopathies: a position statement from the European Society Of Cardiology Working Group on Myocardial and Pericardial Diseases. *Eur Heart J*. 2008;29:270-6.
10. Corrado D, Basso C, Thiene G, McKenna WJ, Davies MJ, Fontaliran F, Nava A, Silvestri F, Blomstrom-Lundqvist C, Wlodarska EK, Fontaine G, Camerini F. Spectrum of clinicopathologic manifestations of arrhythmogenic right ventricular cardiomyopathy/dysplasia: a multicenter study. *J Am Coll Cardiol*. 1997;30:1512-20.
11. Sen-Chowdhry S, Syrris P, Ward D, Asimaki A, Sevdalis E, McKenna WJ. Clinical and genetic characterization of families with arrhythmogenic right ventricular dysplasia/cardiomyopathy provides novel insights into patterns of disease expression. *Circulation*. 2007;115:1710-20.
12. Asimaki A, Tandri H, Huang H, Halushka MK, Gautam S, Basso C, Thiene G, Tsatsopoulou A, Protonotarios N, McKenna WJ, Calkins H, Saffitz JE. A new diagnostic test for arrhythmogenic right ventricular cardiomyopathy. *N Engl J Med*. 2009;360:1075-84.

13. Sen-Chowdhry S, Syrris P, Prasad SK, Hughes SE, Merrifield R, Ward D, Pennell DJ, McKenna WJ. Left-dominant arrhythmogenic cardiomyopathy an under-recognized clinical entity. *J Am Coll Cardiol*. 2008;52:2175-87.
14. La Vecchia L, Varotto L, Zanolla L, Spadaro GL, Fontanelli A. Right ventricular function predicts transplant-free survival in idiopathic dilated cardiomyopathy. *J Cardiovasc Med*. 2006;7:706-10.
15. Sen-Chowdhry S, Syrris P, McKenna WJ. Role of genetic analysis in the management of patients with arrhythmogenic right ventricular dysplasia/cardiomyopathy. *J Am Coll Cardiol*. 2007;50:1813-21.
16. Den Haan AD, Tan B, Zikusoka M, Ibanez Llado L, Jain R, Daly A, Tichnell C, James C, Amat-Alarcon N, Abraham T, Russell S, Bluemke D, Calkins H, Dalal D, Judge D. Comprehensive desmosome mutation analysis in North Americans with arrhythmogenic right ventricular dysplasia/cardiomyopathy. *Circ Cardiovasc Genet*. 2009;2:428-35.
17. Cox MG, van der Zwaag PA, van der Werf C, van der Smagt JJ, Noorman M, Bhuiyan ZA, Wiesfeld AC, Volders PG, van Langen IM, Atsma DE, Dooijes D, van den Wijngaard A, Houweling AC, Jongbloed JD, Jordaens L, Cramer MJ, Doevendans PA, de Bakker JM, Wilde AA, van Tintelen JP, Hauer RN. Arrhythmogenic right ventricular dysplasia/cardiomyopathy: pathogenic desmosome mutations in index-patients predict outcome of family screening: Dutch arrhythmogenic right ventricular dysplasia/cardiomyopathy genotype-phenotype follow-up study. *Circulation*. 2011;123:2690-700.
18. Judge DP and Johnson NM. Genetic evaluation of familial cardiomyopathy. *J Cardiovasc Trans Res*. 2008;1:144-54.
19. MacLennan DH and Kranias EG. Phospholamban: a crucial regulator of cardiac contractility. *Nat Rev Mol Cell Biol*. 2003;4:566-77.
20. Schmitt JP, Kamisago M, Asahi M, Li GH, Ahmad F, Mende U, Kranias EG, MacLennan DH, Seidman JG, Seidman CE. Dilated cardiomyopathy and heart failure caused by a mutation in phospholamban. *Science*. 2003;299:1410-3.
21. Haghighi K, Kolokathis F, Pater L, Lynch RA, Asahi M, Gramolini AO, Fan GC, Tsiapras D, Hahn HS, Adamopoulos S, Liggett SB, Dorn GW, MacLennan DH, Kremastinos DT, Kranias EG. Human phospholamban null results in lethal dilated cardiomyopathy revealing a critical difference between mouse and human. *J Clin Invest*. 2003;111:869-76.
22. Haghighi K, Kolokathis F, Gramolini AO, Waggoner JR, Pater L, Lynch RA, Fan GC, Tsiapras D, Parekh RR, Dorn GW, MacLennan DH, Kremastinos DT, Kranias EG. A mutation in the human phospholamban gene, deleting arginine 14, results in lethal, hereditary cardiomyopathy. *Proc Natl Acad Sci U S A*. 2006;103:1388-93.
23. Posch MG, Perrot A, Geier C, Boldt LH, Schmidt G, Lehmkuhl HB, Hetzer R, Dietz R, Gutberlet M, Haverkamp W, Ozcelik C. Genetic deletion of arginine 14 in phospholamban causes dilated cardiomyopathy with attenuated electrocardiographic R amplitudes. *Heart Rhythm*. 2009;6:480-6.
24. Mestroni L, Maisch B, McKenna WJ, Schwartz K, Charron P, Rocco C, Tesson F, Richter A, Wilke A, Komajda M. Guidelines for the study of familial dilated cardiomyopathies. *Eur Heart J*. 1999;20:93-102.
25. Marcus FI, McKenna WJ, Sherrill D, Basso C, Bauce B, Bluemke DA, Calkins H, Corrado D, Cox MG, Daubert JP, Fontaine G, Gear K, Hauer R, Nava A, Picard MH, Protonotarios N, Saffitz JE, Sanborn DM, Steinberg JS, Tandri H, Thiene G, Towbin JA, Tsatsopoulou A, Wichter T, Zareba W. Diagnosis of arrhythmogenic right ventricular cardiomyopathy/dysplasia: proposed modification of the Task Force Criteria. *Eur Heart J*. 2010;31:806-14.
26. Machado PM, Brandao RD, Cavaco BM, Eugenio J, Bento S, Nave M, Rodrigues P, Fernandes A, Vaz F. Screening for a BRCA2 rearrangement in high-risk breast/ovarian cancer families: evidence for a founder effect and analysis of the associated phenotypes. *J Clin Oncol*. 2007;25:2027-34.

27. Yin T and Green KJ. Regulation of desmosome assembly and adhesion. *Semin Cell Dev Biol.* 2004;15:665-77.
28. Sen-Chowdhry S, Morgan RD, Chambers JC, McKenna WJ. Arrhythmogenic cardiomyopathy: etiology, diagnosis, and treatment. *Annu Rev Med.* 2010;61:233-53.
29. Li J, Swope D, Raess N, Cheng L, Muller EJ, Radice GL. Cardiac tissue-restricted deletion of plakoglobin results in progressive cardiomyopathy and activation of {beta}-catenin signaling. *Mol Cell Biol.* 2011;31:1134-44.

Supplementary data

Table S1 Shared haplotype surrounding the *PLN* gene in R14del index patients

Marker	Position	Index patient															
		D01	D02	D03	D04	D05	D06	D07	D08	D09	D10	D11	D12	D13	D14	D15	D16
D6S303	116.050K	227	227	235	235	225	231	233	233	233	227	235	227	227	235	235	
PLN-650K	118.250K	394	396	394	390	394	394	394	390	394	390	394	390	394	396	394	
PLN-200K	118.700K	439	439	439	443	439	439	439	439	439	443	439	443	439	443	439	
PLN-50K	118.850K	288	288	288	284	288	290	288	294	288	286	288	294	288	284	288	
PLN-R14del	118.900K	+	-	+	-	+	-	+	-	+	-	+	-	+	-	+	
PLN+200K	119.100K	339	337	339	351	339	339	339	355	339	353	339	355	339	357	339	
D6S304	119.450K	237	249	237	237	237	245	237	231	237	237	237	237	237	237	231	
D6S412	120.550K	203	205	203	203	203	203	203	209	203	203	207	209	203	205	209	
Marker	Position	Index patient															
		D09	D10	D11	D12	D13	D14	D15	D16	D17	D18	D19	D20	D21	D22	D23	D24
D6S303	116.050K	233	233	225	225	227	227	227	233	227	227	233	233	235	235	233	
PLN-650K	118.250K	394	394	394	394	394	396	394	394	394	396	394	394	394	394	392	
PLN-200K	118.700K	439	443	439	443	439	443	439	437	439	441	439	441	439	441	439	
PLN-50K	118.850K	288	288	288	286	288	286	286	284	288	294	288	292	288	290	288	
PLN-R14del	118.900K	+	-	+	-	+	-	+	-	+	-	+	-	+	-	+	
PLN+200K	119.100K	339	339	339	359	339	337	347	351	339	353	339	337	339	337	339	
D6S304	119.450K	237	237	237	241	237	237	237	247	237	237	237	249	237	237	231	
D6S412	120.550K	203	203	205	209	203	209	203	211	203	209	203	203	203	207	205	
Marker	Position	Index patient															
		D17	D18	D19	D20	D21	D22	D23	D24	A01	A02	A03	A04	A05	A06	A07	A08
D6S303	116.050K	227	227	227	233	233	235	227	227	227	237	229	229	233	233	235	
PLN-650K	118.250K	394	390	394	396	394	384	394	390	394	396	394	394	394	394	388	
PLN-200K	118.700K	439	443	439	437	439	443	439	443	439	445	439	437	439	437	439	
PLN-50K	118.850K	288	288	288	288	288	288	288	290	288	286	288	290	288	290	288	
PLN-R14del	118.900K	+	-	+	-	+	-	+	-	+	-	+	-	+	-	+	
PLN+200K	119.100K	339	359	339	357	339	351	339	359	339	339	339	339	339	337	339	
D6S304	119.450K	237	237	237	237	237	237	237	237	237	249	237	249	237	231	237	
D6S412	120.550K	203	203	203	209	203	205	203	203	203	203	203	209	203	205	203	
Marker	Position	Index patient															
		A01	A02	A03	A04	A05	A06	A07	A08	A01	A02	A03	A04	A05	A06	A07	A08
D6S303	116.050K	227	227	233	233	227	227	227	227	227	237	229	229	233	233	235	
PLN-650K	118.250K	394	390	394	390	394	396	394	392	394	394	394	394	394	394	394	
PLN-200K	118.700K	439	443	439	441	439	441	439	441	439	437	439	441	439	437	439	
PLN-50K	118.850K	288	288	288	292	288	290	288	298	288	286	288	294	288	288	288	
PLN-R14del	118.900K	+	-	+	-	+	-	+	-	+	-	+	-	+	-	+	
PLN+200K	119.100K	339	339	339	337	339	353	339	341	339	355	339	341	339	349	339	
D6S304	119.450K	237	249	237	249	237	249	237	249	237	235	237	249	237	249	237	
D6S412	120.550K	203	203	203	203	203	205	203	205	203	203	205	205	203	195	207	

Table S1 Shared haplotype surrounding the *PLN* gene in R14del index patients (continued)

Marker	Position	Index patient												Greece	
		A09		A10		A11		A12		USA		Germany			
D6S303	116.050K	235	235	235	235	235	235	235	235	225	231	227	227	233	233
PLN-650K	118.250K	394	394	394	394	394	388	394	394	394	394	394	396	390	396
PLN-200K	118.700K	439	441	439	441	439	443	439	441	439	445	439	441	443	437
PLN-50K	118.850K	288	290	288	288	288	292	288	276	288	290	288	290	286	288
PLN-R14del	118.900K	+	-	+	-	+	-	+	-	+	-	+	-	+	-
PLN+200K	119.100K	339	337	339	335	339	335	339	349	337	337	339	339	355	355
D6S304	119.450K	237	249	237	247	237	237	237	249	237	249	237	245	241	249
D6S412	120.550K	203	205	NA	NA	203	205	205	209	203	207	205	195	203	209

The shared haplotype is in grey. For patient D12, it is most likely that the size of the first proximal marker (PLN-50K) had changed. For patients D12 and the one from the United States (USA), either the size of the first distal marker (PLN+200K) had changed or a recombination had occurred. The identical haplotype found in two patients from the German pedigree, previously published by Posch et al.²³ is also shown. Two *PLN* R14del mutation carriers from the Greek pedigree, previously published by Haghighi et al.²² carried another haplotype, as shown in the box. The position on chromosome 6 is listed.

Table S2 Clinical characteristics of *PLN* R14del index patients

Index patient	Sex	Age at Onset, yrs	Presentation	Age at ICD implantation, yrs ^a	Follow-Up, yrs	End point, age
DCM						
D01	F	59	Arrhythmia	65 (secondary)	10	ICD-, 68; Death#, 69
D02	F	54	HF		12	Death#, 65
D03	F	45	VF	48 (secondary)	17	ICD-, 52; HTx, 53
D04	F	41	AVNRT	46 (primary)	13	
D05	F	46	VT	60 (primary)	18	HTx, 62
D06	M	30	Syncope	30 (primary)	5	ICD-, 32
D07	M	51	HF	58 (primary)	8	Death#, 59
D08	F	40	Arrhythmia	56 (primary)	24	ICD-, 57; HTx, 62
D09	M	48	VT	48 (secondary)	13	ICD-, 48
D10	F	41	Syncope	41 (secondary)	7	ICD-, 43
D11	F	47	Screening [†]	48 (primary)	4	ICD-, 50; Death#, 51
D12	M	46	HF		7	
D13	M	49	Arrhythmia	50 (primary)	9	ICD-, 54; Death#, 58
D14	F	49	Screening [†]	50 (primary)	5	
D15	F	53	HF		3	
D16	M	55	HF	55 (primary)	2	
D17	M	56	Arrhythmia	58 (primary)	6	
D18	F	70	HF	70 (primary)	2	
D19	F	49	VT		26	HTx, 59
D20	F	47	HF	47 (primary)	2	Death#, 49
D21	M	54	Arrhythmia		17	HTx, 60
D22	F	33	Fam. scr.	50 (primary)	20	
D23	F	26	VF	26 (secondary)	3	ICD-, 27
D24	F	45	Syncope	46 (primary)	3	
D25	F	38	Chest pain	43 (secondary)	9	ICD-, 43
D26	F	39	Fam. scr.		19	
D27	M	39	Arrhythmia	40 (primary)	3	ICD-, 40; Death#, 42
D28	F	55	HF	58 (primary)	7	Death#, 62
D29	F	28	Peripartum		18	HTx, 32
D30	M	58	HF	60 (primary)	7	
D31	F	45	HF	45 (primary)	0	
D32	M	55	Collapse	55 (primary)	0	
D33	M	86	AV block		4	Death, 91
D34	M	20	VF	29 (secondary)	9	ICD-, 29
D35	F	29	VT	37 (primary)	9	ICD-, 37; HTx, 38
D36	F	45	Fam. scr.		11	
D37	M	22	VF	32 (secondary)	1	ICD-, 33
D38	M	42	VT	63 (primary)	23	Death#, 65
D39	M	61	VT	62 (primary)	4	ICD-, 64; Death#, 66

Table S2 Clinical characteristics of *PLN R14del* index patients (continued)

Index patient	Sex	Age at Onset,	Presentation	Age at ICD implantation, Follow-Up,		End point, age
		yrs		yrs [^]	yrs	
ARVC						
A01	F	39	VT	38 (secondary)	7	ICD~, 39
A02	M	58	VT	58 (secondary)	9	ICD~, 65
A03	M	49	Fam. scr.	49 (primary)	10	
A04	F	22	Arrhythmia	22 (primary)	8	ICD~, 23; Death [#] , 30
A05	M	43	VT	43 (primary)	3	
A06	M	22	VT		14	
A07	F	50	Fam. scr.	50 (primary)	9	ICD~, 51
A08	M	24	VT	35 (primary)	19	HTx, 43; Death [#] 43
A09	M	51	VT		8	Death [#] , 59
A10	M	38	VT	38 (primary)	11	ICD~, 46
A11	F	29	Fam. scr.	29 (primary)	10	
A12	F	41	VF	41 (secondary)	16	ICD~, 46
USA	F	38	Fam. scr.	38 (primary)	4	

AVNRT indicates AV nodal re-entry tachycardia; Fam. scr, family screening (following SCD); HF, heart failure; HTx, heart transplantation; ICD, implantable cardioverter defibrillator; ICD~, appropriate ICD discharge; SCD, sudden cardiac death; VF, ventricular fibrillation; VT, ventricular tachycardia.

[^]Whether an ICD was as implanted for primary or secondary prevention is stated between brackets.

^{*}Arrhythmia not specified in medical records; [#] Cause of death was terminal heart failure (D01, D07, D11, D13, D20, D28, D38, A04, A09), VF (D27), post-HTx (A08), or unknown (D02); [†] Medical screening; after transient ischemic attack (D11), before operative procedure (D14).

Table S3 Description of baseline arrhythmia's in R14del+ patients with DCM

Index patient	VT's at baseline exercise testing	VT's at baseline 24h Holter ECG	No of VES at baseline 24h Holter ECG
D01	No	NA	NA
D02	NA	No	>1000
D03	No	nsVT; polymorphic	500-1000
D04	No	nsVT; polymorphic	>1000
D05	NA	NA	NA
D06	NA	No	>1000
D07	No	No	500-1000
D08	No	nsVT; unknown morphology	>1000
D09	sVT; RBBB morphology	No	<500
D10	No	No	>1000
D11	No	NA	NA
D12	No	No	NA
D13	nsVT; unknown morphology	NA	NA
D14	No	NA	NA
D15	No	No	>1000
D16	No	nsVT; unknown morphology	NA
D17	nsVT; RBBB morphology	nsVT; unknown morphology	500-1000
D18	No	NA	NA
D19	No	No	<500
D20	NA	NA	NA
D21	No	NA	NA
D22	No	No	>1000
D23	No	NA	NA
D24	No	No	500-1000
D25	No	nsVT; unknown morphology	NA
D26	No	No	<500
D27	No	No	>1000
D28	NA	No	500-1000
D29	NA	nsVT; unknown morphology	NA
D30	No	No	<500
D31	NA	NA	NA
D32	No	NA	NA
D33	NA	NA	NA
D34	No	No	>1000
D35	No	nsVT; unknown morphology	>1000
D36	No	nsVT; unknown morphology	500-1000
D37	No	No	>1000
D38	No	nsVT; unknown morphology	NA
D39	No	nsVT; unknown morphology	NA

nsVT indicates non-sustained ventricular tachycardia; RBBB, right bundle branch block; sVT, sustained ventricular tachycardia; VES; ventricular extrasystoles.

Table S4 Family history of *PLN* R14del index patients

Index patient	Symptom. Relatives, n	Description of affected family members	Age of family members with SCD, yrs
DCM			
D01	1	Child DCM, died at age 32	
D02			
D03	3	Sib HTx for CM and VTs; Sib ventricular arrhythmia	
D04	5	Sib DCM, died at age 39; Cousin DCM, died at age 35	39 (1 st)
D05	2	Sib DCM; Parent HF	
D06	1	Sib DCM	
D07	1	Sib DCM	
D08	1	Sib DCM, died at age 52	
D09	1	Sib SCD at age 31	31 (1 st)
D10	1	Grandparent SCD at age 56	56 (2 nd)
D11	2	Cousin HTx for DCM; Cousin CPR for VF	
D12	1	Grandparent SCD at age 40	40 (2 nd)
D13			
D14	2	Parent DCM; Sib SCD at age 37	37 (1 st)
D15			
D16	2	Parent DCM, died at age 77; Sib SCD at age 33	33 (1 st)
D17	1	Child SCD at age 26, CM at PM	26 (1 st)
D18	2	Child SCD at age 32, CM at PM; Sib DCM	32 (1 st)
D19	3	Cousin's child SCD at age 37; Cousin VF	37 (4 th); 58 (3 rd)
D20			
D21	1	Sib HF, died at age 75	
D22	2	Sib DCM, SCD at age 25, Cousin SCD at age 22	25 (1 st); 22 (4 th)
D23	2	Parent DCM; Aunt HTx for DCM	
D24	2	Sib DCM, died at age 45	
D25			
D26	5	Parent ventr. arrhythmia, died at age 59; Uncle SCD at age 35	35 (2 nd)
D27	3	Parent mild DCM, SCD at age 44	44 (1 st)
D28	1	Sib DCM	
D29			
D30	2	Child DCM, died at age 42	
D31	2	Parent HTx for DCM; Uncle SCD at age 58	58 (2 nd)
D32	2	Parent DCM, died at age 47; Uncle DCM, died at age 49	
D33	3	Three children DCM: SCD at age 27; died at age 51; died at age 52	27 (1 st)
D34	3	Parent HF, died at age 50; Sib SCD at age 38	38 (1 st)
D35	3	Sib DCM, died at age 35; Parent DCM	
D36	3	Sib VF/HF, died at age 56; Sib SCD at age 36; Uncle SCD at age 40	36 (1 st); 40 (2 nd)
D37	1		
D38	1		
D39		Sib HF, died at age 74; Sib HF; died at age 83	

Table S4 Family history of *PLN R14del* index patients (continued)

Index patient	Symptom. Relatives, n	Description of affected family members	Age of family members with SCD, yrs
ARVC			
A01	3	Sib HTx for ARVC; Sib ventricular arrhythmia	
A02	1	Sib ventricular arrhythmia	
A03	2	Child SCD at age 25, ARVC at PM	25 (1 st)
A04	1	Parent ventricular arrhythmia	
A05			
A06	1	Parent DCM, died at age 48	
A07	1	Sib SCD at age 27	27 (1 st)
A08			
A09	1		
A10	1	Sib SCD at age 33	33 (1 st)
A11	5	Sib SCD at age 34, ARVC at PM; Aunt SCD at age 40, Cousin ARVC	34 (1 st), 40 (2 nd)
A12			
USA	3	Parent SCD at age 57, Grandparent SCD at age 50	57 (1 st), 50 (2 nd)

CPR indicates cardiopulmonary resuscitation; HF, heart failure; HTx, heart transplantation; ICD, implantable cardioverter defibrillator; PM, post-mortem examination; SCD, sudden cardiac death; VF, ventricular fibrillation; VT, ventricular tachycardia. Between brackets: degree related to index patient.

Table S5 Baseline ECG characteristics of *PLN R14del* index patients

	N=51
Female sex	28 (55%)
Age (yrs)	46.2 ± 12.4
Sinus rhythm	45 (88%)
Atrial rhythm	3 (6%)
Atrial fibrillation	3 (6%)
Ventricular rate (/min)	70 ± 12
PR interval (ms)	176 ± 34
QRS duration (ms)	102 ± 28
QT _{corrected} (ms) [^]	419 ± 25
Intraventricular conduction disorders	17 (33%)
RBBB	6 (12%)
Other	11 (22%)
T wave inversion – as listed in modified task force criteria	29 (57%)
in V ₁ -V ₃ or beyond; RBBB absent ^{**}	4 (8%)
in V ₁ -V ₄ ; RBBB present [*]	6 (12%)
in V ₄ -V ₆ ; RBBB absent [*]	19 (37%)
TAD of QRS >55 ms, in V ₁ -V ₃ , RBBB absent [*]	2 (4%)
Low voltage; QRS in I, II, III <0.5mV [^]	18 (46%)

RBBB indicates right bundle branch block; TAD, terminal activation duration. For continuous variables, values are listed as mean ± SD. For discrete variables, values are listed as N (%).

^{**} Task force criteria major criterion; ^{*} Task force criteria minor criterion; [^] After exclusion of 12 index patients with a QRS duration > 110ms.

Table S6 Reported findings from RV biopsies from *PLN R14del* index patients

Index patient	Histological findings
DCM	
D02	Two biopsies without clear abnormalities.
D03	Interstitial fibrosis, lipomatosis and hypertrophy; differential diagnosis: cardiomyopathy/ ARVC.
D09	Minor reactive adaptations compatible with hypertrophy; insufficient indications for ARVC.
D10	Interstitial fibrosis; no indications for ARVC.
D15	Aspecific myocyte hypertrophy and limited interstitial fibrosis; lipofibromatosis in a single biopsy.
D20	Myocyte hypertrophy and limited interstitial fibrosis; compatible with cardiomyopathy.
D25	Some hypertrophic and slightly irregular arranged cardiomyocytes; extensive intersitial fibrosis.
D34	Lipomatosis and fibrosis.
D38	Hypertrofic cardiac muscle with locally interstitial fibrosis.
ARVC	
A01	Myocyte hypertrophy with fibrolipomatosis, compatible with ARVC.
A02	Histology fairly typical for ARVC.
A03	Focal interstitial fibrosis, no evident increase of adipocytes.
A04	Fibrosis, some adipocytes, compatible with ARVC.
A05	Small areas with lipofibromatosis, compatible with ARVC.
A06	Histology compatible with ARVC.
A10	In one of two 2 biopsies a small focus of adipocytes, interstitial fibrosis, compatible with ARVC.
A11	Remarkable increase of fat and connective tissue, compatible with ARVC.

The RV biopsies were not systematically studied. The original reported conclusions from pathologists from different centers are listed in this table.

8

Recurrent and founder mutations in the Netherlands – Phospholamban p.Arg14del mutation causes arrhythmogenic cardiomyopathy

Paul A. van der Zwaag
Ingrid A.W. van Rijsingen
Renée de Rooter
Eline A. Nannenbergh
Judith A. Groeneweg
Jan G. Post
Richard N.W. Hauer
Isabelle C. van Gelder
Maarten P. van den Berg
Pim van der Harst
Arthur A.M. Wilde
J. Peter van Tintelen

Manuscript in preparation

ABSTRACT

Background Recently, we showed that the c.40_42delAGA (p.Arg14del) mutation in the phospholamban (*PLN*) gene can be identified in 10-15% of Dutch patients with dilated cardiomyopathy or arrhythmogenic cardiomyopathy. The arrhythmogenic burden of the p.Arg14del mutation was illustrated by the high rate of appropriate ICD discharges and a positive family history for sudden cardiac death.

Methods Our goal was to evaluate the geographical distribution and the origin of this specific mutation in the Netherlands and to get an estimation of the prevalence in a Dutch population cohort. Therefore, we investigated the postal codes of the places of residence of *PLN* p.Arg14del mutation carriers and places of birth of their ancestors. In addition, a large population-based cohort (PREVEND) was screened for the presence of this mutation.

Results By April 2012, we had identified 101 probands carrying the *PLN* p.Arg14del mutation. A total of 358 family members were also found to carry this mutation, resulting in a total of 459 mutation carriers. The majority of mutation carriers live in the northern part of the Netherlands and analysing their grandparents' places of birth indicated that the mutation likely originated in the eastern part of the province of Friesland. In the PREVEND cohort we identified six heterozygous *PLN* p.Arg14del mutation carriers out of 8,267 subjects (0.07%).

Conclusion The p.Arg14del mutation in the *PLN* gene is the most frequently identified mutation in Dutch cardiomyopathy patients. The mutation that arose 575-825 years ago is likely to have originated from the northeastern part of the province of Friesland and is highly prevalent in the general population in the northern part of the Netherlands.

INTRODUCTION

Inherited cardiomyopathies are genetically heterogeneous disorders of the heart which often develop during adolescence or early adult life.¹ Cardiomyopathies are grouped into different categories, based on their functional and morphological properties and subdivisions can be made according to the genetic basis.^{2,3} Genetic overlap between cardiomyopathies is well-recognised. Hypertrophic cardiomyopathy (HCM) is characterised by a thickened wall of the left ventricle,⁴ and mutations in any of nine genes encoding sarcomeric proteins can be found in 30-65% of HCM patients worldwide.⁵⁻⁷ However, mutations in these genes can also be identified in 18% of patients with dilated cardiomyopathy (DCM),⁸ which is characterised by left ventricular dilatation and contractile dysfunction. Arrhythmogenic right ventricular cardiomyopathy (ARVC) is another cardiomyopathy subtype, characterised by fibrofatty replacement of cardiomyocytes, primarily in the right ventricle.⁹ In addition to this classic right ventricular subtype, biventricular involvement and left ventricular predominance have been described.¹⁰ ARVC is considered to be mainly a “disease of the desmosome”, a cell-cell adhesion complex.¹¹ Screening of desmosomal genes has identified mutations in 40-58% of patients diagnosed with ARVC, but also in 5% of patients in a DCM cohort from the United Kingdom.¹²⁻¹⁵ The observed clinical and genetic overlap between ARVC and DCM has led to the postulation of arrhythmogenic cardiomyopathy as the encompassing entity.¹⁶

Of the cardiomyopathies, DCM is genetically the most heterogeneous; in addition to the sarcomere genes, more than 30 genes have been identified in DCM families.¹⁷ One of the genes implicated in DCM encodes phospholamban (PLN), a calcium handling protein in the sarcoplasmic reticulum of cardiac muscle.¹⁸ A number of mutations have been identified, leading to a highly variable phenotype, ranging from cardiac death in early adulthood to middle-aged asymptomatic mutation carriers.^{19,20}

The yield from screening cardiomyopathy populations for *PLN* mutations is generally very low, ranging from 0.08% to 0.38% in selected cohorts.²¹⁻²⁵ Surprisingly, we identified the *PLN* p.Arg14del mutation not only in 13% (31/240) of Dutch patients diagnosed with DCM, but also in 12% (12/97) of Dutch patients diagnosed with ARVC.²⁶ The arrhythmogenic burden of the p.Arg14del mutation was illustrated by the high rate of appropriate ICD discharges and a positive family history for sudden cardiac death. Furthermore, p.Arg14del mutation carriers more frequently underwent cardiac transplantation, compared to patients with familial DCM.²⁶ Cascade screening has identified dozens of family members carrying the same mutation. Both variable expression and age-dependent penetrance, which are hallmarks of all inherited cardiomyopathies, are characteristic of the p.Arg14del mutation.

Recurrent and founder mutations in the Netherlands causing cardiac disease have been described in a series of the *Netherlands Heart Journal*.^{7,27-30} Here, we report our analysis of the origin of the p.Arg14del mutation, both by geographic region using postal code maps, and by age using haplotype analysis. Furthermore, we screened a large population-based cohort for the presence of the p.Arg14del mutation to get an impression of the potential number of mutation carriers in the Netherlands.

MATERIALS AND METHODS

Genetic evaluation

Sequencing analysis and haplotype analysis for the *PLN* p.Arg14del mutation has been described elsewhere.²⁶ To estimate the age of the haplotype, the linkage disequilibrium between the mutation and recombinant microsatellite markers was calculated and the recombination fraction from the distances between the mutation and microsatellite markers was determined, enabling estimation of the number of generations since a mutation had occurred.³¹

Postal code analysis

The postal codes of the places of residence of all *PLN* p.Arg14del mutation carriers were plotted to study their geographical distribution. To study the region where the mutation likely originated, we used a scoring system based on the birthplaces of the grandparents of the proband carrying the *PLN* p.Arg14del mutation. Without any additional genetic results, each grandparent had a chance of 1 in 4 of being a carrier of the mutation and therefore a score of $\frac{1}{4}$ was applied to the postal code of each grandparent's place of birth. If it was known whether the mutation was inherited either paternally or maternally, that pair of grandparents had a chance of 1 in 2 of being a carrier of the mutation and a score of $\frac{1}{2}$ was applied to the postal codes of their places of birth. If it was proven which grandparent was the carrier of the mutation, a score of 1 was applied to the postal code for their place of birth. The sum of all the scores per postal code area was plotted. These analyses were based on the PC2 code (the first two numbers of the postal code) of the mutation carriers and their grandparents. Data were visualised with MapInfo Professional (MapInfo, Toronto, Canada).

Cohort study

A large population-based cohort from the city of Groningen, in the north of the Netherlands, the Prevention of Renal and Vascular ENd-stage Disease (PREVEND) cohort (N = 8,267), was screened for the presence of the *PLN* p.Arg14del mutation. The PREVEND study was designed to prospectively investigate the association between urinary albumin excretion and renal and cardiovascular outcome in the general population. The study protocol is described in elsewhere.^{32,33} In the period 1997-1998, 8,592 participants were enrolled in the study and DNA samples were available for 8,267 participants. The PREVEND study was approved by the local medical ethics committee and conducted in accordance with the Declaration of Helsinki.

Mutation detection

The prevalence of the *PLN* p.Arg14del mutation in the PREVEND cohort was evaluated using KASPar[®] PCR SNP genotyping system (KBiosciences, Herts, UK). All the 8,267 available DNA samples were screened for the mutation.

RESULTS

Genetic evaluation

By April 2012, we had identified 101 unique probands carrying the *PLN* p.Arg14del mutation. A total of 358 family members were found to carry the same mutation, resulting in a total of 459 mutation carriers and an average of 4.5 (range 1-17) mutation carriers per family.

Haplotype analysis was performed in 49 of the 101 Dutch *PLN* p.Arg14del families and in three families from the United States, Germany and Greece.²⁶ A shared haplotype for five markers in a 1.2 Mb region surrounding *PLN* was found, although patients from the Greek family with the p.Arg14del mutation carried another haplotype (Table 1). Allowing 25 years per generation, the age of the 'Dutch' haplotype containing the mutation is estimated to be between 575 and 825 years old.²⁶

Table 1 Shared haplotype surrounding the *PLN* gene for the p.Arg14del mutation carriers from the Netherlands, Germany and the US

Marker	Position	DCM Index patients											
		D02		D04		D06		D08		D10		D12	
D6S303	116.050K	235	235	233	233	227	235	235	235	233	233	227	233
PLN-650K	118.250K	394	396	394	390	394	390	394	394	394	394	394	394
PLN-200K	118.700K	439	439	439	439	439	443	439	445	439	443	439	437
PLN-50K	118.850K	288	288	288	294	288	294	288	296	288	286	286	284
PLN-R14del	118.900K	+	-	+	-	+	-	+	-	+	-	+	-
PLN+200K	119.100K	339	337	339	355	339	355	339	341	339	339	351	347
D6S304	119.450K	237	249	237	231	237	237	237	231	237	241	237	247
D6S412	120.550K	203	205	203	209	203	203	205	209	205	209	203	211

Marker	Position	ARVC Index patients											
		A01		A03		A05		A07		A09		A11	
D6S303	116.050K	227	227	227	227	227	237	233	233	235	235	235	235
PLN-650K	118.250K	394	390	394	396	394	394	394	394	394	394	394	388
PLN-200K	118.700K	439	443	439	441	439	437	439	437	439	441	439	443
PLN-50K	118.850K	288	288	288	290	288	286	288	288	288	290	288	292
PLN-R14del	118.900K	+	-	+	-	+	-	+	-	+	-	+	-
PLN+200K	119.100K	339	339	339	353	339	355	339	349	339	337	339	335
D6S304	119.450K	237	249	237	249	237	235	237	249	237	249	237	237
D6S412	120.550K	203	203	203	205	203	203	203	195	203	205	203	205

Marker	Position	Non-Dutch Index patients											
		US		Germany				Greece					
D6S303	116.050K	225	231			227	227			233	233		
PLN-650K	118.250K	394	394			394	396			390	396		
PLN-200K	118.700K	439	445			439	441			443	437		
PLN-50K	118.850K	288	290			288	290			286	288		
PLN-R14del	118.900K	+	-			+	-			+	-		
PLN+200K	119.100K	337	337			339	339			355	355		
D6S304	119.450K	237	249			237	245			241	249		
D6S412	120.550K	203	207			205	195			203	209		

The shared haplotype in a selection of *PLN* p.Arg14del probands is marked in grey.

For patient D12, the size of the first proximal marker (PLN-50K) had most likely changed. For patients D12 and the one from the United States (US), either the size of the first distal marker (PLN+200K) had changed or a recombination had occurred. The identical haplotype, found in two patients from the German pedigree published by Posch et al.,³⁴ is also shown. Two *PLN* p.Arg14del mutation carriers from the Greek pedigree published by Haghighi et al.²¹ carried another haplotype, as shown in the box. The position on chromosome 6 is listed. DCM indicates dilated cardiomyopathy; ARVC arrhythmogenic right ventricular cardiomyopathy.

Postal code analysis

The geographic distribution of the place of residence of the mutation carriers is plotted in Figure 1, which shows that the majority of the identified carriers live in the northern part of the Netherlands and in the province of Noord-Holland, and that the numbers decrease gradually towards the south.

To determine the origin of the Dutch founder haplotype containing the PLN p.Arg14del mutation, we analysed the place of birth of the proband's grandparents and scored the corresponding postal codes according to their chance of being the grandparent carrying the mutation. Data on these places of birth were available for 60 of the 101 probands and the results are shown in Figure 2. We found that the majority of ancestors came from the eastern part of the province Friesland.

The phenotypes of *PLN* p.Arg14del mutation carriers vary greatly, not only between families, but also within the same family, as illustrated by the family shown in Figure 3A and Table 2. The proband III:1 was diagnosed with ARVC at age 21. She sought medical attention after experiencing palpitations. She presented with a low-voltage ECG with ventricular bigeminy and monomorphic ventricular extrasystoles from the right ventricular outflow tract (Figure 3B). During the course of 9 years follow-up, she developed progressive heart failure and experienced several appropriate ICD discharges because of ventricular tachyarrhythmias. She was placed on the waiting list for a cardiac transplantation, but died at age 30. Her mother, who also carried the PLN p.Arg14del mutation, had recordings of non-sustained VTs on 24h Holter ECG monitoring, but her evaluation was otherwise unremarkable. The grandfather, also a mutation carrier, died at age 75 without ever seeking medical attention because of possible cardiac problems. The proband's two sisters (age 30 and 27 when last evaluated) were found to be carriers of the *PLN* p.Arg14del mutation and are being monitored frequently, but have not experienced any symptoms, although the oldest sister demonstrated 1,100 premature ventricular complexes on 24h Holter monitoring (Table 2).

Cohort study

In the PREVEND cohort we identified six heterozygous PLN p.Arg14del mutation carriers out of 8,267 subjects (0.07%). These PLN p.Arg14del mutation carriers (age at baseline 48 ± 16 years; 4 males) did not have a clinically manifested cardiomyopathy at baseline. Three mutation carriers were diagnosed with hypertension at baseline, and three were diagnosed with diabetes mellitus. One subject (male, age at baseline 69 years) developed heart failure during the 10-year follow-up period; the others had not experienced heart failure at a mean age of 53.4 years. None of the six mutation carriers were diagnosed with atrial fibrillation or left ventricular hypertrophy on the ECG. The set-up of the database provided no additional cardiological data.

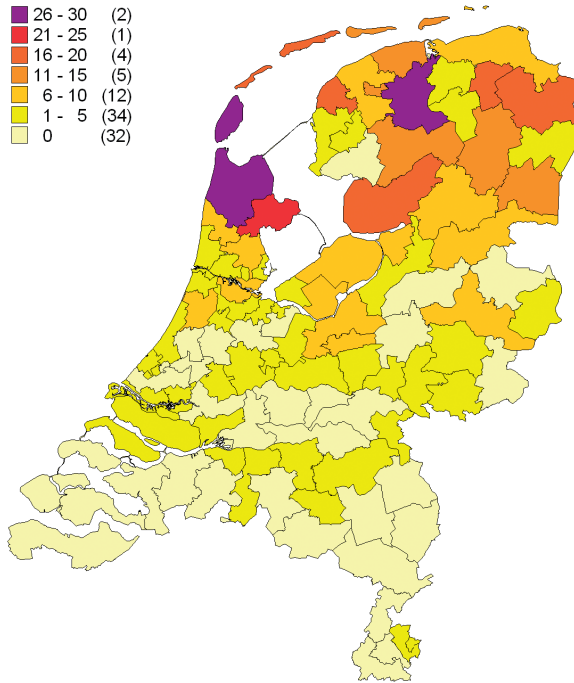

Figure 1 Postal code map showing the distribution of *PLN* p.Arg14del mutation carriers in the Netherlands. The number of *PLN* p.Arg14del mutation carriers per region is shown (in parenthesis: the number of postal code regions, 90 in total). On average, each region contains 180,000 inhabitants.

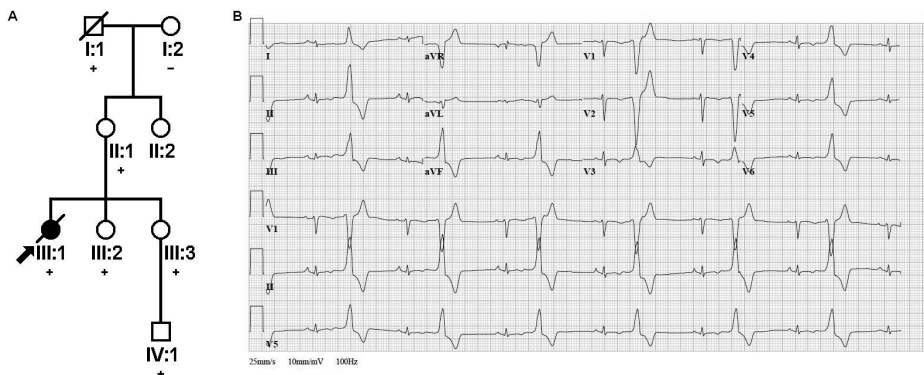

Figure 3 (A) Pedigree of a family carrying the *PLN* p.Arg14del mutation, illustrating the variability of the phenotype. Squares indicate male family members, circles indicate female family members, slashes indicate deceased, and the arrow points to the index patient. The solid black symbol indicates proven ARVC, while open symbols indicate clinically unaffected family members. Genotype results are shown by the p.Arg14del mutation present (+) or absent (-). (B) Baseline ECG of patient III:1, diagnosed with ARVC. The ECG shows signs of both DCM and ARVC: low voltage, ventricular bigeminy with left branch, left axis morphology (suggesting right ventricular outflow tract origin) and negative T-waves in the precordial leads.

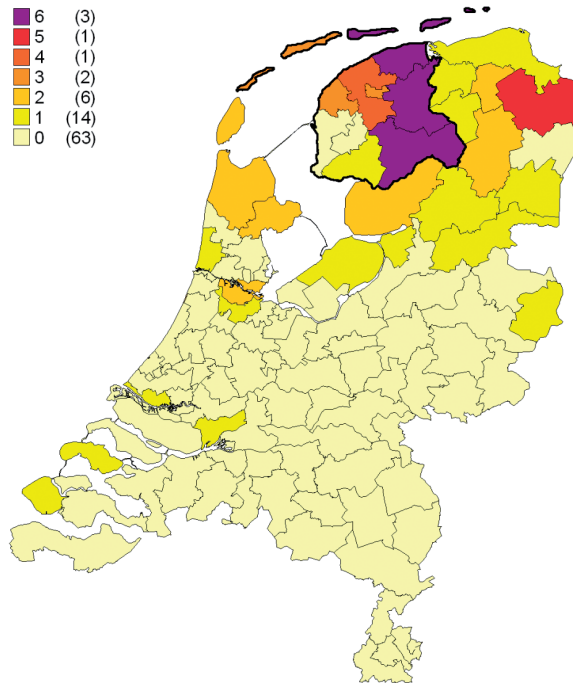

Figure 2 Postal code map illustrating the likely origin of the founder haplotype containing the *PLN* p.Arg14del mutation. The number of points based on the grandparents' birthplaces is shown (in parenthesis: the number of postal code regions, 90 in total). On average, each region contains 180,000 inhabitants. The province of Friesland is enclosed by the bold border.

Table 2 Clinical characteristics of the family members shown in Figure 3

ID	Sex	Age at 1st evaluation	Results at 1st evaluation	Follow-up	Notes
I:1	M	NA	NA	NA	†75 yrs
I:2	F	77 yrs	24h ECG showed PVCs; echocardiography normal	NA	
II:1	F	43 yrs	24h-ECG showed non-sustained VT; echocardiography normal	11 yrs	No progression
II:2	F	NA	NA	NA	
III:1	F	21 yrs	Low voltage ECG; abnormal SA-ECG; 15,000 PVCs on 24h ECG; sustained VT on EPS; fibrofatty replacement on cardiac biopsy; diagnosed with ARVC; ICD implanted	9 yrs	†30 yrs; died of heart failure while on waiting list for HTx
III:2	F	20 yrs	Family screening; no abnormalities	10 yrs	1,100 PVCs on 24h ECG
III:3	F	17y	Family screening; no abnormalities	10 yrs	Delivered a healthy boy at 28 yrs
IV:1	M	NA	NA	NA	

EPS indicates electrophysiology study; HTx cardiac transplantation; ICD implantable cardioverter defibrillator; PVC premature ventricular complex; SA-ECG signal averaged ECG; VT ventricular tachycardia. NA not available.

DISCUSSION

The p.Arg14del mutation in the *PLN* gene is the most frequently identified mutation in cardiomyopathy patients in the Netherlands. Mutation carriers showed high rates of appropriate ICD discharges, cardiac transplantation and a positive family history for sudden cardiac death.²⁶ This mutation has also been identified in cohorts in other countries, such as Germany, Spain, Greece, Canada, and the United States.^{21,22,34,35} (and personal communications M. Gollob & R. Hamilton). The German family and an ARVC patient from the United States carried the same haplotype surrounding the *PLN* gene as the patients from the Netherlands. The Greek patients carried another haplotype, illustrating that the *PLN* p.Arg14del mutation is recurrent, with at least two different haplotypes identified. All the Dutch patients carried the same haplotype and we estimated this haplotype to be between 575 and 825 years old. Although we have identified the founder effect of the *PLN* p.Arg14del mutation in the Netherlands, we cannot exclude that its origin is foreign, due to immigration from Germany, Belgium, France or Spain for example, especially considering the age of the mutation.³⁶ The emigration in the 19th and early 20th century of *PLN* p.Arg14del mutation carriers from the Netherlands or from other Northern European countries to the United States and Canada has likely resulted in the presence of this mutation in North America. Dutch mutation carriers could also have emigrated to South Africa, Australia and New Zealand. The presence of the p.Arg14del mutation needs to be confirmed in genetic studies in these countries.

To estimate the geographical origin of the p.Arg14del mutation, we used a scoring method based on the places of birth of the probands' grandparents. This scoring system revealed the eastern part of the province Friesland as the most likely area of origin of the p.Arg14del mutation in the Netherlands (Figure 2). Most current mutation carriers live in the northern part of the Netherlands including the province of Noord-Holland, i.e. close to the origin of the mutation, and a gradual decline towards the southern part of the Netherlands can be seen in Figure 1. As has been shown for other founder mutations in the Netherlands, including some described in the *NHJ* series,^{7,27-30} the migration of much of the Dutch population, and therefore mutation carriers, has been fairly limited and the distribution of current mutation carriers already gives a clear indication of its origin.

Following the identification of the p.Arg14del mutation in cardiomyopathy patients, we sought to identify whether the mutation was also present in a large population-based cohort from the northern Netherlands that had not been selected for the presence of cardiomyopathy or other cardiac diseases. Six of 8,267 subjects (0.07%) were identified as mutation carriers, suggesting that the mutation could be present in approximately 1:1,400 individuals in the northern part of the Netherlands.

Postal code analysis suggested a lower frequency towards the south. By April 2012, the population of the three northern provinces of Groningen, Friesland and Drenthe was 1.7 million.³⁷ Given these numbers, approximately 1,250 *PLN* p.Arg14del mutation carriers are suspected to live in these provinces. The prevalence of the mutation in other provinces is expected to be lower, but since they have larger populations (e.g. 2.7 million in the province of North Holland), the total number of Dutch *PLN* p.Arg14del carriers is likely to be more than 2,000. Cascade family screening is ongoing and will probably identify several hundred more carriers.

The age at inclusion (48 ± 16 years) of these carriers illustrates the age-dependent penetrance and variable expression of the p.Arg14del mutation. Since the onset of mutation-related symptoms (mean age 44.4 years) is well after the start of their reproductive age,²⁶ many mutation carriers had already had children, explaining the continued high prevalence of the mutation. This mean age is likely to be biased, since the index patients usually mark the severe end of the disease spectrum. Some index patients had had a child who had died of sudden cardiac death at a much younger age than their age of onset.

Following the arrhythmogenic profile of the *PLN* p.Arg14del mutation, primary prevention by implanting an ICD could be beneficial for mutation carriers. We aim to determine the risk factors which will identify individuals at high risk for life-threatening ventricular arrhythmias. Identification of independent risk factors would enable the selection of *PLN* p.Arg14del mutation carriers who are most likely to benefit from an ICD, while the absence of such risk factors in other carriers would justify alternative treatment options. We have setup the PHOspholamban RElated CARDiomyopathy STudy (PHORECAST, www.phorecast.nl) to evaluate the possible risk factors for life-threatening ventricular arrhythmias. This study will be of great importance for all p.Arg14del mutation carriers as well as their cardiologists, who are faced with a great variability of symptoms and large clinical differences, both between and within affected families.

Acknowledgements

We thank all the patients and their relatives who made this work possible, Hennie Bikker, Dennis Dooijes, Marielle E. van Gijn, Arjan Houweling, Jan D.H. Jongbloed, Marjon A. Slegtenhorst, and Arthur van den Wijngaard for providing results of DNA sequence analyses, and Jackie Senior for editing the manuscript. This study was supported by a grant from the Netherlands Heart Foundation (2007B132).

REFERENCES

1. Watkins H, Ashrafian H, Redwood C. Inherited cardiomyopathies. *N Engl J Med*. 2011;364:1643-56.
2. Maron BJ, Towbin JA, Thiene G, Antzelevitch C, Corrado D, Arnett D, Moss AJ, Seidman CE, Young JB. Contemporary definitions and classification of the cardiomyopathies: an American Heart Association Scientific Statement from the Council on Clinical Cardiology, Heart Failure and Transplantation Committee; Quality of Care and Outcomes Research and Functional Genomics and Translational Biology Interdisciplinary Working Groups; and Council on Epidemiology and Prevention. *Circulation*. 2006;113:1807-16.
3. Elliott P, Andersson B, Arbustini E, Bilinska Z, Cecchi F, Charron P, Dubourg O, Kuhl U, Maisch B, McKenna WJ, Monserrat L, Pankuweit S, Rapezzi C, Seferovic P, Tavazzi L, Keren A. Classification of the cardiomyopathies: a position statement from the European Society Of Cardiology Working Group on Myocardial and Pericardial Diseases. *Eur Heart J*. 2008;29:270-6.
4. Thierfelder L, Watkins H, MacRae C, Lamas R, McKenna W, Vosberg HP, Seidman JG, Seidman CE. Alpha-tropomyosin and cardiac troponin T mutations cause familial hypertrophic cardiomyopathy: a disease of the sarcomere. *Cell*. 1994;77:701-12.
5. Richard P, Charron P, Carrier L, Ledeuil C, Cheav T, Pichereau C, Benaiche A, Isnard R, Dubourg O, Burban M, Gueffet JP, Millaire A, Desnos M, Schwartz K, Hainque B, Komajda M, EUROGENE Heart Failure Project. Hypertrophic cardiomyopathy: distribution of disease genes, spectrum of mutations, and implications for a molecular diagnosis strategy. *Circulation*. 2003;107:2227-32.
6. Van Driest SL, Ommen SR, Tajik AJ, Gersh BJ, Ackerman MJ. Sarcomeric genotyping in hypertrophic cardiomyopathy. *Mayo Clin Proc*. 2005;80:463-9.
7. Christiaans I, Nannenberg EA, Dooijes D, Jongbloed RJ, Michels M, Postema PG, Majoor-Krakauer D, van den Wijngaard A, Mannens MM, van Tintelen JP, van Langen IM, Wilde AA. Founder mutations in hypertrophic cardiomyopathy patients in the Netherlands. *Neth Heart J*. 2010;18:248-54.
8. Hershberger RE, Norton N, Morales A, Li D, Siegfried JD, Gonzalez-Quintana J. Coding sequence rare variants identified in MYBPC3, MYH6, TPM1, TNNC1, and TNNI3 from 312 patients with familial or idiopathic dilated cardiomyopathy. *Circ Cardiovasc Genet*. 2010;3:155-61.
9. Basso C, Corrado D, Marcus FI, Nava A, Thiene G. Arrhythmogenic right ventricular cardiomyopathy. *Lancet*. 2009;373:1289-300.
10. Sen-Chowdhry S, Syrris P, Ward D, Asimaki A, Sevdalis E, McKenna WJ. Clinical and genetic characterization of families with arrhythmogenic right ventricular dysplasia/cardiomyopathy provides novel insights into patterns of disease expression. *Circulation*. 2007;115:1710-20.
11. Van Tintelen JP, Hofstra RM, Wiesfeld AC, van den Berg MP, Hauer RN, Jongbloed JD. Molecular genetics of arrhythmogenic right ventricular cardiomyopathy: emerging horizon? *Curr Opin Cardiol*. 2007;22:185-92.
12. Sen-Chowdhry S, Syrris P, McKenna WJ. Role of genetic analysis in the management of patients with arrhythmogenic right ventricular dysplasia/cardiomyopathy. *J Am Coll Cardiol*. 2007;50:1813-21.
13. Den Haan AD, Tan B, Zikusoka M, Ibanez Llado L, Jain R, Daly A, Tichnell C, James C, Amat-Alarcon N, Abraham T, Russell S, Bluemke D, Calkins H, Dalal D, Judge D. Comprehensive desmosome mutation analysis in North Americans with arrhythmogenic right ventricular dysplasia/cardiomyopathy. *Circ Cardiovasc Genet*. 2009;2:428-35.
14. Cox MG, van der Zwaag PA, van der Werf C, van der Smagt JJ, Noorman M, Bhuiyan ZA, Wiesfeld AC, Volders PG, van Langen IM, Atsma DE, Dooijes D, van den Wijngaard A, Houweling AC, Jongbloed JD, Jordaens L, Cramer MJ, Doevendans PA, de Bakker JM, Wilde AA, van Tintelen JP, Hauer RN. Arrhythmogenic right ventricular dysplasia/cardiomyopathy: pathogenic desmosome mutations in

- index-patients predict outcome of family screening: Dutch arrhythmogenic right ventricular dysplasia/cardiomyopathy genotype-phenotype follow-up study. *Circulation*. 2011;123:2690-700.
15. Elliott P, O'Mahony C, Syrris P, Evans A, Rivera SC, Sheppard MN, Carr-White G, Pantazis A, McKenna WJ. Prevalence of desmosomal protein gene mutations in patients with dilated cardiomyopathy. *Circ Cardiovasc Genet*. 2010;3:314-22.
 16. Sen-Chowdhry S, Morgan RD, Chambers JC, McKenna WJ. Arrhythmogenic cardiomyopathy: etiology, diagnosis, and treatment. *Annu Rev Med*. 2010;61:233-53.
 17. Dellefave L and McNally EM. The genetics of dilated cardiomyopathy. *Curr Opin Cardiol*. 2010;25:198-204.
 18. MacLennan DH and Kranias EG. Phospholamban: a crucial regulator of cardiac contractility. *Nat Rev Mol Cell Biol*. 2003;4:566-77.
 19. Schmitt JP, Kamisago M, Asahi M, Li GH, Ahmad F, Mende U, Kranias EG, MacLennan DH, Seidman JG, Seidman CE. Dilated cardiomyopathy and heart failure caused by a mutation in phospholamban. *Science*. 2003;299:1410-3.
 20. Haghghi K, Kolokathis F, Pater L, Lynch RA, Asahi M, Gramolini AO, Fan GC, Tsiapras D, Hahn HS, Adamopoulos S, Liggett SB, Dorn GW, MacLennan DH, Kremastinos DT, Kranias EG. Human phospholamban null results in lethal dilated cardiomyopathy revealing a critical difference between mouse and human. *J Clin Invest*. 2003;111:869-76.
 21. Haghghi K, Kolokathis F, Gramolini AO, Waggoner JR, Pater L, Lynch RA, Fan GC, Tsiapras D, Parekh RR, Dorn GW, MacLennan DH, Kremastinos DT, Kranias EG. A mutation in the human phospholamban gene, deleting arginine 14, results in lethal, hereditary cardiomyopathy. *Proc Natl Acad Sci U S A*. 2006;103:1388-93.
 22. DeWitt MM, MacLeod HM, Soliven B, McNally EM. Phospholamban R14 deletion results in late-onset, mild, hereditary dilated cardiomyopathy. *J Am Coll Cardiol*. 2006;48:1396-8.
 23. Chiu C, Tebo M, Ingles J, Yeates L, Arthur JW, Lind JM, Semsarian C. Genetic screening of calcium regulation genes in familial hypertrophic cardiomyopathy. *J Mol Cell Cardiol*. 2007;43:337-43.
 24. Landstrom AP, Adekola BA, Bos JM, Ommen SR, Ackerman MJ. PLN-encoded phospholamban mutation in a large cohort of hypertrophic cardiomyopathy cases: summary of the literature and implications for genetic testing. *Am Heart J*. 2011;161:165-71.
 25. Medeiros A, Biagi DG, Sobreira TJ, de Oliveira PS, Negrao CE, Mansur AJ, Krieger JE, Brum PC, Pereira AC. Mutations in the human phospholamban gene in patients with heart failure. *Am Heart J*. 2011;162:1088,1095.e1.
 26. Van der Zwaag PA, van Rijsingen IA, Asimaki A, Jongbloed JD, van Veldhuisen DJ, Wiesfeld AC, Cox MG, van Lochem LT, de Boer RA, Hofstra RM, Christiaans I, van Spaendonck-Zwarts KY, Lekanne Dit Deprez RH, Judge DP, Calkins H, Suurmeijer AJ, Hauer RN, Saffitz JE, Wilde AA, van den Berg MP, van Tintelen JP. Phospholamban R14del mutation in patients diagnosed with dilated cardiomyopathy or arrhythmogenic right ventricular cardiomyopathy: evidence supporting the concept of arrhythmogenic cardiomyopathy. *Eur J Heart Fail*. 2012; doi:10.1093/eurjhf/hfs119.
 27. Postema PG, Van den Berg M, Van Tintelen JP, Van den Heuvel F, Grundeken M, Hofman N, Van der Roest WP, Nannenberga EA, Krapels IP, Bezzina CR, Wilde A. Founder mutations in the Netherlands: SCN5a 1795insD, the first described arrhythmia overlap syndrome and one of the largest and best characterised families worldwide. *Neth Heart J*. 2009;17:422-8.
 28. Van der Zwaag PA, Cox MG, van der Werf C, Wiesfeld AC, Jongbloed JD, Dooijes D, Bikker H, Jongbloed R, Suurmeijer AJ, van den Berg MP, Hofstra RM, Hauer RN, Wilde AA, van Tintelen JP. Recurrent and founder mutations in the Netherlands: Plakophilin-2 pArg79X mutation causing arrhythmogenic right ventricular cardiomyopathy/dysplasia. *Neth Heart J*. 2010;18:583-91.

29. Van den Wijngaard A, Volders P, Van Tintelen JP, Jongbloed JD, van den Berg MP, Lekanne Deprez RH, Mannens MM, Hofmann N, Slegtenhorst M, Dooijes D, Michels M, Arens Y, Jongbloed R, Smeets BJ. Recurrent and founder mutations in the Netherlands: cardiac Troponin I (TNNI3) gene mutations as a cause of severe forms of hypertrophic and restrictive cardiomyopathy. *Neth Heart J*. 2011;19:344-51.
30. Van Spaendonck-Zwarts KY, van der Kooi AJ, van den Berg MP, Ippel EF, Boven LG, Yee WC, van den Wijngaard A, Brusse E, Hoogendijk JE, Doevendans PA, de Visser M, Jongbloed JD, van Tintelen JP. Recurrent and founder mutations in the Netherlands: the cardiac phenotype of DES founder mutations p.S13F and p.N342D. *Neth Heart J*. 2012;20:219-28.
31. Machado PM, Brandao RD, Cavaco BM, Eugenio J, Bento S, Nave M, Rodrigues P, Fernandes A, Vaz F. Screening for a BRCA2 rearrangement in high-risk breast/ovarian cancer families: evidence for a founder effect and analysis of the associated phenotypes. *J Clin Oncol*. 2007;25:2027-34.
32. Hillege HL, Janssen WM, Bak AA, Diercks GF, Grobbee DE, Crijs HJ, Van Gilst WH, De Zeeuw D, De Jong PE, Prevend Study Group. Microalbuminuria is common, also in a nondiabetic, nonhypertensive population, and an independent indicator of cardiovascular risk factors and cardiovascular morbidity. *J Intern Med*. 2001;249:519-26.
33. Linssen GC, Bakker SJ, Voors AA, Gansevoort RT, Hillege HL, de Jong PE, van Veldhuisen DJ, Gans RO, de Zeeuw D. N-terminal pro-B-type natriuretic peptide is an independent predictor of cardiovascular morbidity and mortality in the general population. *Eur Heart J*. 2010;31:120-7.
34. Posch MG, Perrot A, Geier C, Boldt LH, Schmidt G, Lehmkuhl HB, Hetzer R, Dietz R, Gutberlet M, Haverkamp W, Ozcelik C. Genetic deletion of arginine 14 in phospholamban causes dilated cardiomyopathy with attenuated electrocardiographic R amplitudes. *Heart Rhythm*. 2009;6:480-6.
35. Gomez Milanés I, Garcia-Molina E, Sabater-Molina M, Perez I, Ayala JM, Ruiz-Espejo F, Lopez Cuenca D, Martínez P, Gimeno JR, Valdes M. R14Del, a Dutch phospholamban mutation in a Spanish family. Genotype-phenotype aspects. *Eur Heart J*. 2012;33;Supplement 1:877 (Abstract).
36. Zeegers MP, van Poppel F, Vlietinck R, Spruijt L, Ostrer H. Founder mutations among the Dutch. *Eur J Hum Genet*. 2004;12:591-600.
37. Statline; Centraal Bureau voor de Statistiek. Available at <http://statline.cbs.nl>. Accessed 24/06/2012.

9

Left-dominant arrhythmogenic cardiomyopathy in a large family: Associated desmosomal or non- desmosomal genotype?

Judith A. Groeneweg*
Paul A. van der Zwaag*
Jan D.H. Jongbloed
Moniek G.P.J. Cox
Rudolf A. de Boer
Jeroen F. van der Heijden
Toon A.B. van Veen
William J. McKenna
J. Peter van Tintelen
Dennis Dooijes
Richard N.W. Hauer

** These authors contributed equally to this work*

Submitted

ABSTRACT

Introduction Arrhythmogenic cardiomyopathy (ACM) is considered a predominantly right ventricular (RV) desmosomal disease. However, left-dominant forms due to desmosomal gene mutations, including *PKP2* variant c.419C>T (p.Ser140Phe), have been described. Recently, a non-desmosomal phospholamban (*PLN*) mutation (c.40_42delAGA; p.Arg14del) has been identified causing dilated cardiomyopathy and arrhythmias. By cosegregation analysis of *PKP2* variant p.Ser140Phe versus *PLN* mutation p.Arg14del we aimed to gain more insight into pathogenicity.

Methods and Results A Dutch family (13 family members, median age 49, range 34-71 years) with ventricular tachycardia underwent meticulous phenotypic characterisation and screening of five desmosomal genes (*PKP2*, *DSC2*, *DSG2*, *DSP*, *JUP*) and *PLN*. Six family members fulfilled 2010 ACM Task Force Criteria. Seven had signs of left ventricular (LV) involvement (inverted T waves in V₄-V₆, LV wall motion abnormalities and late enhancement, reduced LV ejection fraction), including six family members with proven ACM. *PKP2* p.Ser140Phe was found as a single variant in three, combined with *PLN* p.Arg14del in three others. *PLN* mutation p.Arg14del was found in nine family members, including the six with ACM and all seven with LV involvement. *PLN* p.Arg14del was found as single mutation in six, and combined with *PKP2* p.Ser140Phe in three others. A low voltage ECG was seen in four of nine *PLN* mutation-carriers. None of the *PKP2* single variant carriers showed any sign of RV or LV involvement.

Conclusion In this family, *PLN* mutation p.Arg14del cosegregates with ACM and with electrocardiographic and structural LV abnormalities. There was no evidence of disease causing contribution of the *PKP2* variant p.Ser140Phe.

INTRODUCTION

In the classical description, arrhythmogenic right ventricular dysplasia/cardiomyopathy (ARVD/C) was characterised by ventricular arrhythmias of right ventricular origin with fibrofatty replacement of cardiomyocytes, predominantly in the right ventricle (RV).¹⁻⁴ More recently, patients and families with ventricular arrhythmia and similar ARVD/C histopathologic changes in the left ventricle (LV) have been recognised and described as left-dominant arrhythmogenic cardiomyopathy (LDAC).⁵ Mutations in desmosomal genes cause both ARVD/C and LDAC and at the molecular level both ventricles and the interventricular septum are similarly affected by down-regulation and altered distribution of intercalated disk proteins.⁶⁻⁸ The designation “arrhythmogenic cardiomyopathy” is now the preferred terminology when the clinical presentation of a cardiomyopathy is predominantly with arrhythmia rather than heart failure.⁹

Arrhythmogenic cardiomyopathy (ACM) is considered a hereditary disease primarily due to mutations in genes encoding cardiac desmosomal proteins. Desmosomes are protein complexes located in the intercalated disk which are important for mechanical integrity.¹⁰ Desmosomal dysfunction with loss of mechanical cell-cell adhesion leads to down-regulation of other intercalated disk proteins, i.e. gap junction proteins (connexin43) and sodium channels (Nav1.5).^{7,11} These alterations give rise to electrical cell-cell uncoupling and slow conduction respectively, thereby providing a substrate for *early* activation delay and thus re-entrant ventricular tachyarrhythmia.^{7,8,10,12-20} Presumably, at a *later stage* myocyte loss and fibrofatty replacement will have a major impact on tissue architecture, giving rise to zig-zag conduction pathways and load mismatch, further contributing to enhanced activation delay.^{8,12-14}

Pathogenic mutations in five known desmosomal genes are related to right, left, and biventricular forms of ACM: plakophilin 2 (*PKP2*), desmoplakin (*DSP*), plakoglobin (*JUP*), desmoglein 2 (*DSG2*), and desmocollin 2 (*DSC2*).^{15,21-27} In approximately 60% of Dutch ACM patients a pathogenic desmosomal mutation is found, predominantly in the *PKP2* gene.^{20,22}

The *PKP2* variant c.419C>T (p.Ser140Phe) is a missense variant which alters one amino acid. It has been reported to be associated with both classical right-sided ACM, and with a left-dominant form.^{5,21,28} This variant has been identified in individual patients who, according to the Task Force Criteria (TFC), have ACM.^{5,21,28-34} *PKP2* p.Ser140Phe has also been identified in 5 families with ACM.^{21,28,30,32}

However, the pathogenicity of this variant is not supported by *in silico* prediction algorithms Sorting Intolerant from Tolerant (SIFT) and Polymorphism Phenotyping-2 (PolyPhen-2).^{35,36} SIFT and PolyPhen-2 predict a tolerated (0.17) and benign

(0.001) effect of the missense variant on PKP2 protein function. No functional tests to assess pathogenicity have been performed thus far.

This report presents a family with monomorphic ventricular tachycardia (VT) with two potentially causative mutations, the desmosomal PKP2 variant p.Ser140Phe and a recently identified mutation c.40_42delAGA (p.Arg14del) in the non-desmosomal phospholamban (*PLN*) gene. *PLN* is involved in calcium homeostasis and mutation carriers are phenotypically characterised by low voltage electrocardiograms, ventricular arrhythmias, and contractile dysfunction.³⁷⁻⁴⁰

The aim of the study was to gain insight into the pathogenicity of the PKP2 variant p.Ser140Phe by cosegregation analysis of the PKP2 variant p.Ser140Phe versus the *PLN* mutation p.Arg14del.

METHODS

Study population

A Dutch family of four generations and 30 family members, 13 of whom were available for screening (median age 46, range 34-71 years, four men), with VT underwent meticulous phenotypic characterisation and mutation analysis.

Clinical evaluation

Standard patient evaluation included detailed assessment of clinical and family history, physical examination, and 12-lead ECG (while off drugs). In the presence of cardiac symptoms and/or an abnormal ECG, analysis was extended with 48-hour ambulatory ECG monitoring (11/13), maximal treadmill exercise testing (7/13), chest X-ray (5/11), 2D-transthoracic echocardiography (11/13), magnetic resonance imaging (MRI; 8/13) including delayed enhancement (DE; 6/13) analysis, and in a minority, LV/RV cine-angiography (3/13), electrophysiologic study (EPS; 3/13), and endomyocardial biopsy (2/13). Diagnosis of ACM was according to the revised 2010 TFC.⁴¹ Family members were further analysed for LV abnormalities. LV involvement was considered positive in the presence of at least one of the following: negative T waves in left precordial leads V_4 - V_6 , LV wall motion abnormalities (akinesia or dyskinesia) and/or DE in the LV on imaging studies, and left ventricular ejection fraction (LVEF) < 50%.

Molecular analysis

Genomic DNA was extracted from peripheral blood as described before.²⁰ Direct sequence analysis of all coding regions and intron/exon boundaries of the five known desmosomal genes *PKP2*, *DSP*, *JUP*, *DSG2*, *DSC2*, and in addition *PLN* was

performed in the index patient. The remaining 12 family members available for screening were analysed for the *PKP2* variant and the *PLN* mutation found in the index patient. Primer sequences and PCR conditions are available on request.

RESULTS

Family

At age 51, the index patient (III:8, see pedigree in Figure 1) presented with a poorly tolerated monomorphic VT with right bundle branch block (RBBB) morphology, right axis deviation, and cycle length 230 ms. Clinical analysis showed low voltage ECG (voltages <0.5mV in standard leads), and a structurally normal heart on cine-angiography and echocardiography with LVEF 62%. At age 63, she presented again with a hemodynamically poorly tolerated VT with the same morphology and axis, but remarkably longer cycle length (while off drugs) of 350 ms (Figure 2). By then, the LVEF had deteriorated to 32%. The ECG repeatedly showed markedly low voltages in the standard leads (Figure 3). Left and right ventricular cine-angiogram revealed dyskinesia at the LV apex, and akinesia inferiorly of the tricuspid valve with poor RV function. Coronary angiogram (CAG) was unremarkable. The clinical VT was inducible with programmed electrical stimulation (PES) in the RV apex (cycle

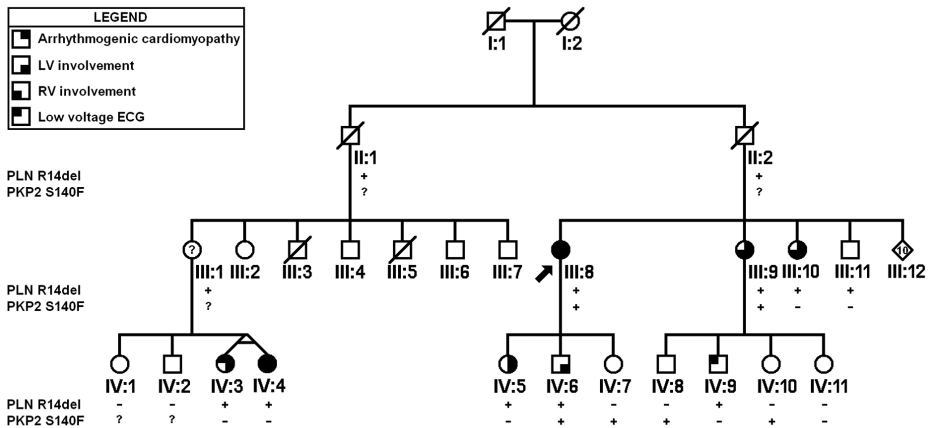

Figure 1 Pedigree of the Dutch family with *PKP2* variant c.419C>T (p.Ser140Phe) and *PLN* mutation c.40_42delAGA (p.Arg14del). No other desmosomal mutations identified in the index patient (arrow). In addition, 12 family members screened for *PKP2* variant and *PLN* mutation carrier status. Phenotypic characterisation with regard to arrhythmogenic cardiomyopathy (ACM) diagnosis with left ventricular (LV) and right ventricular (RV) involvement, and presence of low voltages (voltages <0.5mV in standard leads). Square: male, circle: female, +: mutation carrier, -: non-carrier, ?: *PKP2* not screened, diagonal line: deceased.

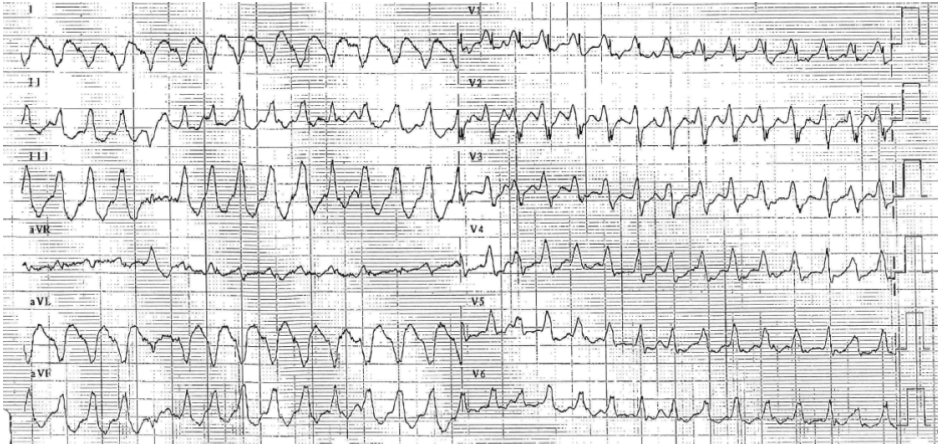

Figure 2 ECG of the index patient (III:8) at second presentation. 12-lead ECG recording (while off drugs) of monomorphic ventricular tachycardia with right bundle branch block morphology, right axis deviation and cycle length 350 ms at second presentation of index patient at age 63.

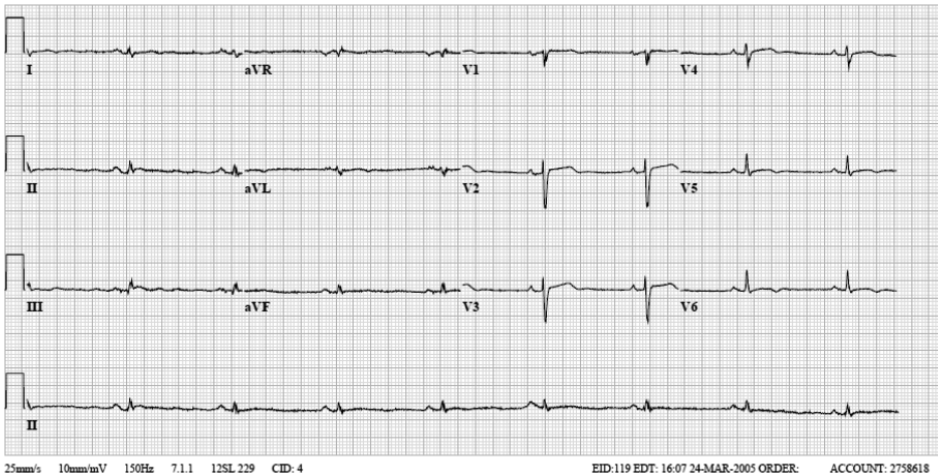

Figure 3 ECG of the index patient (III:8) while off drugs. Outstanding are the low voltages (voltages <0.5mV in standard leads).

length 600 ms and two extrastimuli). In addition, two other RBBB VT morphologies were inducible during PES. All VT episodes could be terminated by burst pacing. Management included implantation of a cardioverter defibrillator (ICD). Heart failure became more prominent at age 64, with a clinical decline in condition when she developed atrial fibrillation.

Family screening was initiated after the index patient's second presentation. There were no sudden cardiac deaths in the family. Family members of the first and

second generation reached old age. Findings in the family are summarised in Table 1.

Her sister (III:9) had an abnormal ECG and atypical chest pain since age 58 (CAG normal). The ECG showed negative T waves in leads V₁-V₆ (Figure 4). 24-Hour

Table 1 Genotype-phenotype correlation

Family member	III:10	III:11	IV:3	IV:4	IV:5	IV:9	III:8	III:9	IV:6	IV:7	IV:8	IV:10	IV:11
Age(years)	64	62	46	46	46	40	71	66	44	42	42	37	34
Molecular genetics													
PLN	+	+	+	+	+	+	+	+	+				
PKP2							+	+	+	+	+	+	
ECG													
Low Volt			+	+		+	+						
V ₁ -V ₃								+					
V ₄ -V ₆	+		+	+	+			+	+				
ProL. TAD													
Arrhythmias													
LBBB VT				+	+			+					
RBBB VT							+						
>500 VES	+		+	+	+		+			na			na
Imaging													
WMA RV				+			+	+					na
WMA LV	+						+						na
DE RV		na		+			na			na	na	na	na
DE LV		na			+		na	+		na	na	na	na
RVEF(%)	33	na	47	32	na	54	na	47	56	na	na	na	na
LVEF(%)	50	na	50	51	58	60	32	60	68	na	na	na	na
Diagnosis													
ACM	+		+	+	+		+	+					
RV inv.	+			+			+	+					
LV inv.	+		+	+	+		+	+	+				

Only the presence of a feature is indicated, by a '+' sign. Family members are sorted based on their genetic results and numbered according to pedigree (Figure 1) with age (years) noted below family number.

PLN: phospholamban. PKP2: plakophilin 2. Low Volt: low voltages on ECG, voltages <0.5mV in standard leads. V₁-V₃: negative T waves in leads V₁-V₃. V₄-V₆: negative T waves in leads V₄-V₆. ProL. TAD: prolonged terminal activation duration (≥55 ms). LBBB VT: VT with left bundle branch block morphology. RBBB VT: VT with right bundle branch block morphology. 500 VES: fulfilment of Task Force criterion >500 ventricular extrasystoles/24hour. WMA: wall motion abnormalities (akinesia/dyskinesia). DE: delayed enhancement. RV: right ventricle. LV: left ventricle. RVEF: right ventricular ejection fraction. LVEF: left ventricular ejection fraction. ACM: arrhythmogenic cardiomyopathy. RV/LV inv.: RV/LV involvement. na: not applicable.

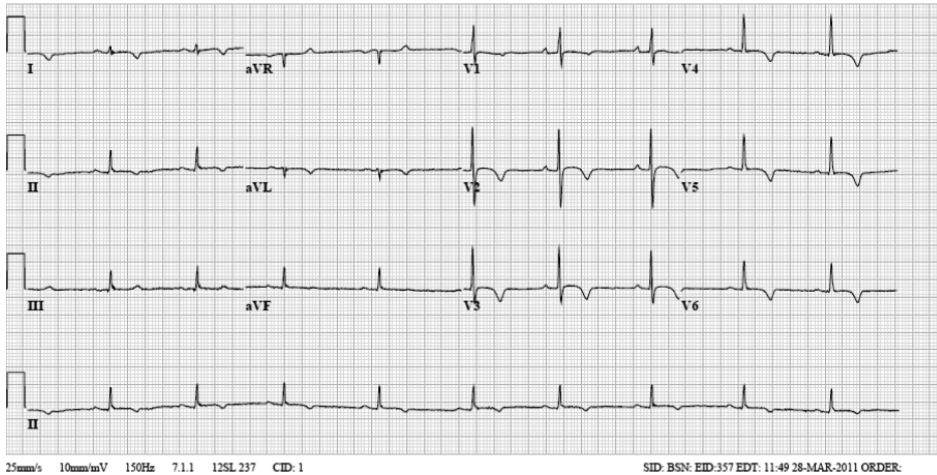

Figure 4 ECG of the sister (III:9) of the index patient while off drugs. Remarkable are the negative T waves in leads V1-V6, a major criterion according to Task Force Criteria for arrhythmogenic cardiomyopathy.

ECG showed ventricular ectopy (238/24hour) with left bundle branch block (LBBB) morphology. MRI demonstrated a dyskinetic area in the RV and delayed enhancement in the lateral wall of the LV, with LVEF 60%. At age 65, ventricular ectopy increased to 493/24hour and non-sustained VT (NSVT) episodes were recorded. During PES no arrhythmias were inducible, late potentials were found in outflow tract, basal-anterior, and inferior-apical region of the RV, and voltage mapping revealed multiple sites with endocardial low voltages (voltages $\leq 1.5\text{mV}$ in bipolar recordings). Endomyocardial biopsy showed normal endomyocardium. Analysis was followed by ICD implantation.

Another sister (III:10) had negative T waves in V_2 - V_6 , frequent ventricular ectopy (3379/24hour), and reduced RV function (RVEF 33%), with LVEF 50%. A brother of the index patient (III:11), aged 62 years, had a normal ECG and structurally normal heart on echocardiography and MRI.

The eldest daughter of the index patient (IV:5) had palpitations. She had negative T waves in V_2 - V_6 , frequent ventricular ectopy (2431/24hour), NSVT episodes, and DE in the inferior and lateral region of the LV apex. No arrhythmias were inducible with PES, voltage mapping demonstrated low endocardial voltages in anterior outflow tract, and inferior free-wall region of the RV. Endomyocardial biopsy showed normal myocardium. An ICD was implanted. The son of the index patient (IV:6) did not have any cardiac complaints, his ECG however, showed negative T waves in V_3 - V_6 , MRI analysis showed a wider RV (47mm) than LV (45mm) but no other signs of ACM. His sister (IV:7) was asymptomatic with a normal ECG and echocardiogram.

The eldest son (IV:8) of the sister (III:9) of the index patient was asymptomatic with normal ECG. His brother (IV:9) had a history of palpitations but without

documented episodes of tachycardia. His ECG showed low voltages but no inverted T waves. Exercise testing and MRI analysis revealed no abnormalities with good systolic function of both ventricles. Their sister (IV:10) was asymptomatic with normal ECG and echocardiogram. The youngest of these siblings (IV:11) was asymptomatic, and the ECG was normal.

Both cousins of the index patient, monozygotic twins (IV:3 and IV:4) were evaluated. At age 43, patient IV:3 showed a low voltage ECG with inverted T waves in V_4 - V_6 , frequent ventricular ectopy (1042/24hour), and normal ventricular function with RVEF 47% and LVEF 50%. Her sister (IV:4) had low voltages and negative T waves in V_4 - V_6 , RV wall motion abnormalities and DE, a reduced RV function with RVEF 32%, and LVEF 51%.

Diagnosis of arrhythmogenic cardiomyopathy and LV involvement

According to revised 2010 TFC, ACM was diagnosed in 6 family members (III:8, III:9, III:10, IV:3, IV:4, IV:5; median age 55, range 46-71 years; all women), as shown in Table 1 (see also Figure 1). Diagnosis in this family was based on major and minor criteria for family history, depolarisation and repolarisation abnormalities, ventricular arrhythmias, and either global or regional dysfunction and structural alterations of the RV.

LV involvement was identified in seven family members (III:8, III:9, III:10, IV:3, IV:4, IV:5, IV:6; median age 46, range 44-71 years; see Table 1). Those seven included the six family members with ACM diagnosis. One family member (IV:6) with LV abnormalities and prominent ventricular ectopy (407/24 hour) had only one major and one minor criterion, based on family history and inverted T waves in left precordial leads, and therefore did not meet the diagnosis of ACM.

DNA analyses

In DNA of the index patient, sequence analysis of all five desmosomal genes and of the non-desmosomal gene PLN resulted in the identification of the PKP2 variant p.Ser140Phe and the PLN mutation p.Arg14del. No other mutation was identified in the index patient.

PKP2 p.Ser140Phe was identified as single variant in three family members (IV:7, IV:8, IV:10; median age 42, range 37-42 years). PLN mutation p.Arg14del was identified in nine family members, as single mutation in 6 family members (III:10, III:11, IV:3, IV:4, IV:5, IV:9, median age 46, range 40-64 years), and combined with the PKP2 variant in three others (III:8, III:9, IV:6; median age 66, range 44-71 years).

Genotype-phenotype correlation

All six family members with ACM diagnosis carried the PLN mutation p.Arg14del, four of them as single mutation (III:10, IV:3, IV:4, IV:5; see pedigree Figure 1). Moreover, all seven patients with LV involvement were PLN p.Arg14del positive. PLN mutation carriers often had a low voltage ECG (voltages <0.5 mV in standard leads; 4/9 mutation carriers; see Table 1), and frequently had inverted T waves in V_4 - V_6 (6/9 mutation carriers). In contrast, none of the PKP2 single variant carriers (IV:7, IV:8, IV:10, aged 42, 42, and 37) showed any sign of RV or LV involvement.

DISCUSSION

PLN cosegregation and mutation carrier characteristics

Cosegregation analysis of PKP2 variant p.Ser140Phe versus PLN mutation p.Arg14del demonstrated that the PLN mutation cosegregates with ACM diagnosis and electrocardiographic and structural LV abnormalities. In this family, mutation carriers were often identified by the presence of low voltage ECGs. In addition, PLN mutation carriers with ACM had RV and LV involvement, negative T waves in V_4 - V_6 , and wall motion abnormalities and/or DE in the LV.

It is remarkable that none of the PLN mutation carriers in this family showed prolonged terminal activation duration (TAD), or epsilon waves in V_1 - V_3 , primarily representing activation delay in the RV outflow tract, whereas prolonged TAD was identified previously in 71% of patients with classical ACM, i.e. ARVD/C.¹⁹ These observations suggest that PLN mutation carriers form a specific subgroup of ACM patients.

The p.Arg14del mutation results in the deletion of a highly conserved residue and is not found in large control populations.^{38,39} PLN gene mutations have previously been associated with low voltages on ECG recordings, with ventricular tachyarrhythmias, and contractile dysfunction in dilated cardiomyopathy (DCM) patients.^{37,38,40} The attenuated amplitudes on ECG recordings were found irrespective of structural abnormalities on imaging studies.^{38,40} In our study, patient IV:9 had low voltages without any MRI abnormalities, including DE analysis. Similar patients in whom the electrocardiographic and arrhythmic abnormalities were the earliest disease manifestation have been reported, as have patients in whom arrhythmia and MRI late enhancement preceded ECG or structural imaging abnormalities.⁶ Therefore a mutation specific process leading to fibrosis and ultimately arrhythmias or heart failure has been hypothesised. Low voltages in the absence of fibrosis could indicate electrical changes due to chronic increased intracellular calcium levels.⁴⁰ The exact mechanism of the low voltages on ECG remains to be elucidated. As in classical

forms of ACM, modifying factors are important in the clinical presentation of PLN mutation carriers. The monozygotic twins IV:3 and IV:4 are clinically different, with markedly reduced RV function in patient IV:4 and preserved RV function in patient IV:3. In addition, family member III:11, aged 62 years, did not show any sign of RV or LV disease. At this stage, the potential role of environmental factors and genetic modifiers is still obscure.

PKP2 cosegregation

Initial molecular genetic screening of the five known desmosomal genes identified the missense variant p.Ser140Phe in the PKP2 gene. The literature on PKP2 p.Ser140Phe (Table 2), presents conflicting data. The variant is found in healthy controls, in individual ACM or DCM patients, and in families with ACM. Identification in controls appears infrequent, and the overrepresentation in ACM patients and families has been considered suggestive of a disease-modifying or even pathogenetic role of the variant.^{21,28,30}

The findings in this study challenge this suggested classification. In our Dutch family the PKP2 variant was the only variant identified after genetic screening of the five desmosomal genes. Nevertheless, the daughter of the index patient had ventricular arrhythmias and structural changes in the LV but did not carry the variant. Furthermore, three family members already aged 37, 42, and 42 years, with PKP2 p.Ser140Phe as the sole variant did not display any sign of RV or LV involvement. Since the single PKP2 variant carriers were all from the youngest generation, a selection bias due to age-related penetrance is possible, but unlikely since these individuals were aged around 40 years. However, in individuals with a PLN mutation a modifier effect of the additional PKP2 variant, suggested by the overrepresentation of the variant in patients in the literature, can not be excluded. Nonetheless, there is no evidence of an individual disease causing contribution of the single PKP2 variant p.Ser140Phe in this family.

Several arguments support the non-pathogenicity of the single PKP2 variant. *In silico* prediction algorithms do not support pathogenic classification of the p.Ser140Phe variant. The variant affects a mildly conserved residue and the resulting phenylalanine at position 140 is found at that position in other species.^{15,30} Second, in a study by Christensen et al. this variant is found in 3 out of 55 ACM patients but also in 5 out of 650 healthy controls.^{30,31} Moreover, the individual ACM patient first described in the study by Dalal et al. carrying the variant, was also carrying a second, pathogenic mutation in *PKP2* (c.2146-1G>C), and an unclassified variant in *DSG2* (c.166G>A p. Val56Met).^{29,32,42} In addition, the cosegregation of the PKP2 p.Ser140Phe variant has been studied in five families with ACM: Syrris et al. and later Sen-Chowdry et al. described a family of three generations with sudden cardiac

death, VT, and structural alterations in the RV and LV, with affected patients carrying PKP2 p.Ser140Phe.^{21,28} Nonetheless, a first degree relative had structural abnormalities in the RV and NSVT but did not carry the variant. Similar are the results of a study of Christensen et al. and a study by Xu et al., who described the variant in ACM patients but established that there is incomplete cosegregation in three distinct families.^{30,32}

Table 2 Literature on PKP2 variant p.Ser140Phe

Article	TFC	Genes tested	Prevalence in		Cosegregation analysis	Reported classification	Reported before
			controls	patients			
Garcia-Pavia et al. 2011. ⁴³	DCM	<i>PKP2, DSC2, DSG2, DSP, JUP</i>	0/200	1/89	No cosegregation	Mutation	
Christensen et al. 2010. ^{30,31}	1994	<i>PKP2, DSC2, DSG2, DSP, JUP, TGFB3</i>	5/650	3/55	One proband digenic heterozygous, family members noncarriers	Modifier, rare variant	
Elliott et al. 2010. ⁴⁴	DCM	<i>PKP2, DSC2, DSG2, DSP, JUP</i>	0/200	3/100*	No analysis	Mutation	
Fressart et al. 2010. ³⁴	1994	<i>PKP2, DSC2, DSG2, DSP, JUP</i>	0/300	1/135	No analysis	Variant of unknown significance	
Xu et al. 2010. ³²	1994	<i>PKP2, DSC2, DSG2, DSP, JUP, DES</i>	0/700	1/198**	Incomplete cosegregation	Variant	Dalal et al. 2006
Sen-Chowdry et al. 2007. ²⁸	#	<i>PKP2, DSC2, DSG2, DSP, JUP</i>	0/0	2/200	Incomplete cosegregation in one family	Mutation	Syrris et al. 2006
Koopmann et al. 2007. ⁴⁵	BrS	<i>PKP2, JUP</i> †	1/75	1/38	No analysis	Polymorphism	
Dalal et al. 2006. ²⁹	1994	<i>PKP2</i>	0/200	1/58	No analysis	Mutation	
Syrris et al. 2006. ²¹	1994	<i>PKP2</i> ‡	0/200	1/100	Incomplete cosegregation	Mutation	
Gerull et al. 2004. ¹⁵	1994	<i>PKP2</i>	0/250	1/120	No analysis	Mutation	

TFC: Task Force Criteria for ACM diagnosis, 1994: original criteria, 2010: new revised criteria, DCM: criteria for dilated cardiomyopathy, BrS: Criteria for diagnosis of Brugada syndrome. Genes: *PKP2*: plakophilin 2, *DSP*: desmoplakin, *JUP*: plakoglobin, *DSG2*: desmoglein 2, *DSC2*: desmocollin 2, *TGFB3*: tumor growth factor beta3, *DES*: desmine, *SCN5A*: sodium channel5a. # used Task Force guidelines from Corrado et al.⁴⁶ and modified criteria for familial ACM diagnosis from Hamid et al.⁴⁷ †: When *SCN5A* was negative, *PKP2* and *JUP* were tested, ‡: When *DSP* and *JUP* were negative, *PKP2* was tested, *: 1 patient also carried *DSP* c.8134G>A; p.Ala2712Thr, **: proband is digenic (*DSG2* c.166G>A; p.Val56Met) and compound heterozygous (*PKP2* c.419C>T; p.Ser140Phe and c.2146-1G>C).

Desmosomal disease in this family?

The non-desmosomal PLN mutation p.Arg14del cosegregates with ACM diagnosis and LV abnormalities whereas the desmosomal PKP2 variant p.Ser140Phe does not. ACM is usually associated with desmosomal gene mutations. There is limited knowledge on the pathogenic mechanism of non-desmosomal PLN mutations in ACM patients. Down-regulation of the desmosomal protein plakoglobin has been hypothesised as a final common pathway for the ACM phenotype.^{8,20} The PLN mutation may have indirect effects on cardiac desmosomes, thus explaining the ACM phenotype.

Limitations

Only one family with 13 family members was available for cosegregation analysis of PKP2 p.Ser140Phe versus PLN p.Arg14del. This study should be extended in other families. Moreover, functional analysis should be performed to assess the apparent non-pathogenicity of PKP2 variant p.Ser140Phe demonstrated in this study. However, cosegregation analysis demonstrated cosegregation of the PLN mutation with the diagnosis of ACM and LV involvement. Available evidence did not reveal other mutations as causal for the familial ACM in this family.

CONCLUSION

A PLN mutation cosegregates with the diagnosis of ACM and with electrocardiographic and structural LV abnormalities. Mutation carriers are phenotypically characterised by low voltages and inverted T waves in left precordial leads on the ECG. In this family, there is no evidence of individual disease causing contribution of the single p.Ser140Phe variant in PKP2.

Acknowledgements

The authors are grateful to the family members for their effort, interest, and cooperation. This study was supported by the Netherlands Heart Foundation (grants 2007B132 and 2007B139), Interuniversity Cardiology Institute of the Netherlands (project 06901), and the Heart Lung Foundation Utrecht. WJM acknowledges a proportion of funding from the Department of Health's NIHR Biomedical Research Centres funding scheme.

REFERENCES

1. Marcus FI, Fontaine GH, Guiraudon G, Frank R, Laurenceau JL, Malergue C, Grosgeat Y. Right ventricular dysplasia: a report of 24 adult cases. *Circulation*. 1982;65:384-98.
2. Thiene G, Nava A, Corrado D, Rossi L, Pennelli N. Right ventricular cardiomyopathy and sudden death in young people. *N Engl J Med*. 1988;318:129-33.
3. Basso C, Thiene G, Corrado D, Angelini A, Nava A, Valente M. Arrhythmogenic right ventricular cardiomyopathy. Dysplasia, dystrophy, or myocarditis? *Circulation*. 1996;94:983-91.
4. Corrado D, Basso C, Thiene G, McKenna WJ, Davies MJ, Fontaliran F, Nava A, Silvestri F, Blomstrom-Lundqvist C, Wlodarska EK, Fontaine G, Camerini F. Spectrum of clinicopathologic manifestations of arrhythmogenic right ventricular cardiomyopathy/dysplasia: a multicenter study. *J Am Coll Cardiol*. 1997;30:1512-20.
5. Sen-Chowdhry S, Syrris P, Prasad SK, Hughes SE, Merrifield R, Ward D, Pennell DJ, McKenna WJ. Left-dominant arrhythmogenic cardiomyopathy an under-recognized clinical entity. *J Am Coll Cardiol*. 2008;52:2175-87.
6. Norman M, Simpson M, Mogensen J, Shaw A, Hughes S, Syrris P, Sen-Chowdhry S, Rowland E, Crosby A, McKenna WJ. Novel mutation in desmoplakin causes arrhythmogenic left ventricular cardiomyopathy. *Circulation*. 2005;112:636-42.
7. Oxford EM, Musa H, Maass K, Coombs W, Taffet SM, Delmar M. Connexin43 remodeling caused by inhibition of plakophilin-2 expression in cardiac cells. *Circ Res*. 2007;101:703-11.
8. Asimaki A, Tandri H, Huang H, Halushka MK, Gautam S, Basso C, Thiene G, Tsatsopoulou A, Protonotarios N, McKenna WJ, Calkins H, Saffitz JE. A new diagnostic test for arrhythmogenic right ventricular cardiomyopathy. *N Engl J Med*. 2009;360:1075-84.
9. Ackerman MJ, Priori SG, Willems S, Berul C, Brugada R, Calkins H, Camm AJ, Ellinor PT, Gollob M, Hamilton R, Hershberger RE, Judge DP, Le Marec H, McKenna WJ, Schulze-Bahr E, Semsarian C, Towbin JA, Watkins H, Wilde A, Wolpert C, Zipes DP, Heart Rhythm Society (HRS), European Heart Rhythm Association (EHRA). HRS/EHRA expert consensus statement on the state of genetic testing for the channelopathies and cardiomyopathies: this document was developed as a partnership between the Heart Rhythm Society (HRS) and the European Heart Rhythm Association (EHRA). *Europace*. 2011;13:1077-109.
10. Kaplan SR, Gard JJ, Carvajal-Huerta L, Ruiz-Cabezas JC, Thiene G, Saffitz JE. Structural and molecular pathology of the heart in Carvajal syndrome. *Cardiovasc Pathol*. 2004;13:26-32.
11. Sato PY, Musa H, Coombs W, Guerrero-Serna G, Patino GA, Taffet SM, Isom LL, Delmar M. Loss of plakophilin-2 expression leads to decreased sodium current and slower conduction velocity in cultured cardiac myocytes. *Circ Res*. 2009;105:523-6.
12. De Bakker JM, van Capelle FJ, Janse MJ, Tasseron S, Vermeulen JT, de Jonge N, Lahpor JR. Slow conduction in the infarcted human heart. 'Zigzag' course of activation. *Circulation*. 1993;88:915-26.
13. Cabo C, Pertsov AM, Baxter WT, Davidenko JM, Gray RA, Jalife J. Wave-front curvature as a cause of slow conduction and block in isolated cardiac muscle. *Circ Res*. 1994;75:1014-28.
14. Fast VG and Kleber AG. Role of wavefront curvature in propagation of cardiac impulse. *Cardiovasc Res*. 1997;33:258-71.
15. Gerull B, Heuser A, Wichter T, Paul M, Basson CT, McDermott DA, Lerman BB, Markowitz SM, Ellinor PT, MacRae CA, Peters S, Grossmann KS, Drenckhahn J, Michely B, Sasse-Klaassen S, Birchmeier W, Dietz R, Breithardt G, Schulze-Bahr E, Thierfelder L. Mutations in the desmosomal protein plakophilin-2 are common in arrhythmogenic right ventricular cardiomyopathy. *Nat Genet*. 2004;36:1162-4.

16. Saffitz JE. Dependence of electrical coupling on mechanical coupling in cardiac myocytes: insights gained from cardiomyopathies caused by defects in cell-cell connections. *Ann N Y Acad Sci.* 2005;1047:336-44.
17. Basso C, Czarnowska E, Della Barbera M, Bauce B, Beffagna G, Wlodarska EK, Pilichou K, Ramondo A, Lorenzon A, Wozniak O, Corrado D, Daliento L, Danieli GA, Valente M, Nava A, Thiene G, Rampazzo A. Ultrastructural evidence of intercalated disc remodelling in arrhythmogenic right ventricular cardiomyopathy: an electron microscopy investigation on endomyocardial biopsies. *Eur Heart J.* 2006;27:1847-54.
18. Garcia-Gras E, Lombardi R, Giocondo MJ, Willerson JT, Schneider MD, Khoury DS, Marian AJ. Suppression of canonical Wnt/beta-catenin signaling by nuclear plakoglobin recapitulates phenotype of arrhythmogenic right ventricular cardiomyopathy. *J Clin Invest.* 2006;116:2012-21.
19. Cox MG, Nelen MR, Wilde AA, Wiesfeld AC, van der Smagt JJ, Loh P, Cramer MJ, Doevendans PA, van Tintelen JP, de Bakker JM, Hauer RN. Activation delay and VT parameters in arrhythmogenic right ventricular dysplasia/cardiomyopathy: toward improvement of diagnostic ECG criteria. *J Cardiovasc Electrophysiol.* 2008;19:775-81.
20. Cox MG, van der Zwaag PA, van der Werf C, van der Smagt JJ, Noorman M, Bhuiyan ZA, Wiesfeld AC, Volders PG, van Langen IM, Atsma DE, Dooijes D, van den Wijngaard A, Houweling AC, Jongbloed JD, Jordaens L, Cramer MJ, Doevendans PA, de Bakker JM, Wilde AA, van Tintelen JP, Hauer RN. Arrhythmogenic right ventricular dysplasia/cardiomyopathy: pathogenic desmosome mutations in index-patients predict outcome of family screening: Dutch arrhythmogenic right ventricular dysplasia/cardiomyopathy genotype-phenotype follow-up study. *Circulation.* 2011;123:2690-700.
21. Syrris P, Ward D, Asimaki A, Sen-Chowdhry S, Ebrahim HY, Evans A, Hitomi N, Norman M, Pantazis A, Shaw AL, Elliott PM, McKenna WJ. Clinical expression of plakophilin-2 mutations in familial arrhythmogenic right ventricular cardiomyopathy. *Circulation.* 2006;113:356-64.
22. Van Tintelen JP, Entius MM, Bhuiyan ZA, Jongbloed R, Wiesfeld AC, Wilde AA, van der Smagt J, Boven LG, Mannens MM, van Langen IM, Hofstra RM, Otterspoor LC, Doevendans PA, Rodriguez LM, van Gelder IC, Hauer RN. Plakophilin-2 mutations are the major determinant of familial arrhythmogenic right ventricular dysplasia/cardiomyopathy. *Circulation.* 2006;113:1650-8.
23. Rampazzo A, Nava A, Malacrida S, Beffagna G, Bauce B, Rossi V, Zimbello R, Simionati B, Basso C, Thiene G, Towbin JA, Danieli GA. Mutation in human desmoplakin domain binding to plakoglobin causes a dominant form of arrhythmogenic right ventricular cardiomyopathy. *Am J Hum Genet.* 2002;71:1200-6.
24. McKoy G, Protonotarios N, Crosby A, Tsatsopoulou A, Anastasakis A, Coonar A, Norman M, Baboonian C, Jeffery S, McKenna WJ. Identification of a deletion in plakoglobin in arrhythmogenic right ventricular cardiomyopathy with palmoplantar keratoderma and woolly hair (Naxos disease). *Lancet.* 2000;355:2119-24.
25. Asimaki A, Syrris P, Wichter T, Matthias P, Saffitz JE, McKenna WJ. A novel dominant mutation in plakoglobin causes arrhythmogenic right ventricular cardiomyopathy. *Am J Hum Genet.* 2007;81:964-73.
26. Pilichou K, Nava A, Basso C, Beffagna G, Bauce B, Lorenzon A, Frigo G, Vettori A, Valente M, Towbin J, Thiene G, Danieli GA, Rampazzo A. Mutations in desmoglein-2 gene are associated with arrhythmogenic right ventricular cardiomyopathy. *Circulation.* 2006;113:1171-9.
27. Syrris P, Ward D, Evans A, Asimaki A, Gandjbakhch E, Sen-Chowdhry S, McKenna WJ. Arrhythmogenic right ventricular dysplasia/cardiomyopathy associated with mutations in the desmosomal gene desmocollin-2. *Am J Hum Genet.* 2006;79:978-84.

28. Sen-Chowdhry S, Syrris P, Ward D, Asimaki A, Sevdalis E, McKenna WJ. Clinical and genetic characterization of families with arrhythmogenic right ventricular dysplasia/cardiomyopathy provides novel insights into patterns of disease expression. *Circulation*. 2007;115:1710-20.
29. Dalal D, Molin LH, Piccini J, Tichnell C, James C, Bomma C, Prakasa K, Towbin JA, Marcus FI, Spevak PJ, Bluemke DA, Abraham T, Russell SD, Calkins H, Judge DP. Clinical features of arrhythmogenic right ventricular dysplasia/cardiomyopathy associated with mutations in plakophilin-2. *Circulation*. 2006;113:1641-9.
30. Christensen AH, Benn M, Tybjaerg-Hansen A, Haunso S, Svendsen JH. Missense variants in plakophilin-2 in arrhythmogenic right ventricular cardiomyopathy patients--disease-causing or innocent bystanders? *Cardiology*. 2010;115:148-54.
31. Christensen AH, Benn M, Bundgaard H, Tybjaerg-Hansen A, Haunso S, Svendsen JH. Wide spectrum of desmosomal mutations in Danish patients with arrhythmogenic right ventricular cardiomyopathy. *J Med Genet*. 2010;47:736-44.
32. Xu T, Yang Z, Vatta M, Rampazzo A, Beffagna G, Pilichou K, Scherer SE, Saffitz J, Kravitz J, Zareba W, Danieli GA, Lorenzon A, Nava A, Bauce B, Thiene G, Basso C, Calkins H, Gear K, Marcus F, Towbin JA, Multidisciplinary Study of Right Ventricular Dysplasia Investigators. Compound and digenic heterozygosity contributes to arrhythmogenic right ventricular cardiomyopathy. *J Am Coll Cardiol*. 2010;55:587-97.
33. Tan BY, Jain R, den Haan AD, Chen Y, Dalal D, Tandri H, Amat-Alarcon N, Daly A, Tichnell C, James C, Calkins H, Judge DP. Shared desmosome gene findings in early and late onset arrhythmogenic right ventricular dysplasia/cardiomyopathy. *J Cardiovasc Transl Res*. 2010;3:663-73.
34. Fressart V, Duthoit G, Donal E, Probst V, Deharo JC, Chevalier P, Klug D, Dubourg O, Delacretaz E, Cosnay P, Scanu P, Extramiana F, Keller D, Hidden-Lucet F, Simon F, Bessirard V, Roux-Buisson N, Hebert JL, Azarine A, Casset-Senon D, Rouzet F, Lecarpentier Y, Fontaine G, Coirault C, Frank R, Hainque B, Charron P. Desmosomal gene analysis in arrhythmogenic right ventricular dysplasia/cardiomyopathy: spectrum of mutations and clinical impact in practice. *Europace*. 2010;12:861-8.
35. Adzhubei IA, Schmidt S, Peshkin L, Ramensky VE, Gerasimova A, Bork P, Kondrashov AS, Sunyaev SR. A method and server for predicting damaging missense mutations. *Nat Methods*. 2010;7:248-9.
36. Ng PC and Henikoff S. Predicting deleterious amino acid substitutions. *Genome Res*. 2001;11:863-74.
37. Haghghi K, Kolokathis F, Pater L, Lynch RA, Asahi M, Gramolini AO, Fan GC, Tsiapras D, Hahn HS, Adamopoulos S, Liggett SB, Dorn GW, MacLennan DH, Kremastinos DT, Kranias EG. Human phospholamban null results in lethal dilated cardiomyopathy revealing a critical difference between mouse and human. *J Clin Invest*. 2003;111:869-76.
38. Haghghi K, Kolokathis F, Gramolini AO, Waggoner JR, Pater L, Lynch RA, Fan GC, Tsiapras D, Parekh RR, Dorn GW, 2nd, MacLennan DH, Kremastinos DT, Kranias EG. A mutation in the human phospholamban gene, deleting arginine 14, results in lethal, hereditary cardiomyopathy. *Proc Natl Acad Sci U S A*. 2006;103:1388-93.
39. DeWitt MM, MacLeod HM, Soliven B, McNally EM. Phospholamban R14 deletion results in late-onset, mild, hereditary dilated cardiomyopathy. *J Am Coll Cardiol*. 2006;48:1396-8.
40. Posch MG, Perrot A, Geier C, Boldt LH, Schmidt G, Lehmkuhl HB, Hetzer R, Dietz R, Gutberlet M, Haverkamp W, Ozcelik C. Genetic deletion of arginine 14 in phospholamban causes dilated cardiomyopathy with attenuated electrocardiographic R amplitudes. *Heart Rhythm*. 2009;6:480-6.
41. Marcus FI, McKenna WJ, Sherrill D, Basso C, Bauce B, Bluemke DA, Calkins H, Corrado D, Cox MG, Daubert JP, Fontaine G, Gear K, Hauer R, Nava A, Picard MH, Protonotarios N, Saffitz JE, Sanborn DM, Steinberg JS, Tandri H, Thiene G, Towbin JA, Tsatsopoulou A, Wichter T, Zareba W. Diagnosis of

- arrhythmogenic right ventricular cardiomyopathy/dysplasia: proposed modification of the task force criteria. *Circulation*. 2010;121:1533-41.
42. Den Haan AD, Tan BY, Zikusoka MN, Llado LI, Jain R, Daly A, Tichnell C, James C, Amat-Alarcon N, Abraham T, Russell SD, Bluemke DA, Calkins H, Dalal D, Judge DP. Comprehensive desmosome mutation analysis in North Americans with arrhythmogenic right ventricular dysplasia/cardiomyopathy. *Circ Cardiovasc Genet*. 2009;2:428-35.
 43. Garcia-Pavia P, Syrris P, Salas C, Evans A, Mirelis JG, Cobo-Marcos M, Vilches C, Bornstein B, Segovia J, Alonso-Pulpon L, Elliott PM. Desmosomal protein gene mutations in patients with idiopathic dilated cardiomyopathy undergoing cardiac transplantation: a clinicopathological study. *Heart*. 2011;97:1744-52.
 44. Elliott P, O'Mahony C, Syrris P, Evans A, Rivera SC, Sheppard MN, Carr-White G, Pantazis A, McKenna WJ. Prevalence of desmosomal protein gene mutations in patients with dilated cardiomyopathy. *Circ Cardiovasc Genet*. 2010;3:314-22.
 45. Koopmann TT, Beekman L, Alders M, Meregalli PG, Mannens MM, Moorman AF, Wilde AA, Bezzina CR. Exclusion of multiple candidate genes and large genomic rearrangements in SCN5A in a Dutch Brugada syndrome cohort. *Heart Rhythm*. 2007;4:752-5.
 46. Corrado D, Fontaine G, Marcus FI, McKenna WJ, Nava A, Thiene G, Wichter T. Arrhythmogenic right ventricular dysplasia/cardiomyopathy: need for an international registry. Study Group on Arrhythmogenic Right Ventricular Dysplasia/Cardiomyopathy of the Working Groups on Myocardial and Pericardial Disease and Arrhythmias of the European Society of Cardiology and of the Scientific Council on Cardiomyopathies of the World Heart Federation. *Circulation*. 2000;101:E101-6.
 47. Hamid MS, Norman M, Quraishi A, Firoozi S, Thaman R, Gimeno JR, Sachdev B, Rowland E, Elliott PM, McKenna WJ. Prospective evaluation of relatives for familial arrhythmogenic right ventricular cardiomyopathy/dysplasia reveals a need to broaden diagnostic criteria. *J Am Coll Cardiol*. 2002;40:1445-50.

10

Summary
General discussion

SUMMARY

Arrhythmogenic cardiomyopathy is a progressive, heritable myocardial disorder resulting in ventricular arrhythmias and sudden cardiac death, but also in end-stage heart failure.¹ Initially, it was believed that the disease resulted from abnormal development of the right ventricle, resulting in the term “right ventricular dysplasia”.² Early publications described involvement of the right ventricle, which was considered the classic subtype of the disease. More recently however, involvement of both ventricles and left ventricular predominance have been described.³⁻⁵ The terms “right ventricular” and “dysplasia” seem to be outdated and the preferred term for this type of inherited cardiomyopathy is now “arrhythmogenic cardiomyopathy” (ACM). The disease usually presents in young adolescence or early adulthood, but a diagnosis in children under the age of 10 years is rare.^{6,7} Genetic causes, mainly mutations in genes encoding for desmosomal proteins, can be identified in about 50% of cases.

The first part of this thesis describes genetic studies and phenotypic characterisation in ACM. Chapter 2 describes the application of the haplotype-sharing test to identify disease-causing mutations. Many families affected with a subtype of cardiomyopathy are too small to perform classical linkage analysis. We therefore performed the haplotype-sharing test to search for large shared segments in the individuals’ genomes that are most likely to contain the causative mutation in a family. Affected individuals will have inherited the haplotype with this mutation from a common ancestor. The common ancestor could be from several generations ago, so that the affected individuals might be unaware of the fact that they are related to each other. DNA from proven affected family members was genotyped using single nucleotide polymorphism (SNP) arrays and the data from these analyses were combined to search for shared haplotypes. Both a family with ACM and a family with dilated cardiomyopathy (DCM) were analysed using the haplotype-sharing test. In both pedigrees, we searched for mutations in the genes located in the largest shared haplotypes and we were able to identify mutations in *PKP2* and *MYH7*, respectively. Furthermore, we calculated that with a pedigree containing at least seven meioses, the chances are high that the largest shared haplotype will be the one to contain the causative mutation. This proof-of-principle study showed that the haplotype-sharing test can assist in identifying causative genes in families with low penetrance Mendelian diseases, in which standard tools cannot be used because of insufficient pedigree information. The haplotype-sharing test can also be used if a common ancestor is suspected based on the place of birth of the individuals, even if they are not known to be related.

Chapter 3 describes molecular studies on the *PKP2* mutation identified in chapter 2, together with the clinical data of the mutation carriers. The identified *PKP2* splice site mutation (c.2489+4A>C) is predicted to lead to the expression of a dysfunctional *PKP2* protein, rather than a loss-of-function protein. The clinical manifestations in mutation carriers ranged from severe disease to non-penetrance in elderly mutation carriers. This study suggests that this *PKP2* mutation alone is not sufficient to cause disease and that other genetic and/or environmental factors also contribute to the development of the disease. This exemplifies the variable expression and incomplete penetrance characteristic of ACM.

Founder mutations are frequently identified in Dutch patients with inherited cardiac diseases. Chapter 4 describes the largest series of patients with the same founder mutation in the *PKP2* gene (p.Arg79X). Twelve index patients and 41 family members were evaluated. Haplotype analysis revealed a shared haplotype among all mutation carriers, indicating a common founder. Sudden cardiac death (SCD) in individuals younger than 40 years of age had occurred in 50% of these families, while only 60% of the mutation carriers had experienced any symptoms by age 60, again illustrating the clinical variability and reduced penetrance in ACM.

The pathogenicity of identified genetic variants in ACM patients is not always clear. In Chapter 5, the genetic variants database for ACM (available from www.arvcdatabase.info) is described in detail. This freely available, online database lists the genetic variants in genes associated with ACM and is a digital repository for both molecular data and all the publications containing additional information on clinical and/or genetic data of identified variants. In June 2012, the database contained 856 variants and data from 111 publications. The database has been proven to be useful: since its launch in October 2008, it has been visited 125,000 times by 11,500 returning visitors from more than 50 countries.

Chapter 6 reports a large cohort of Dutch ACM families, collected in all the university medical centres in the Netherlands. To gain more insight into the natural variability of the disease expression and phenotypic consequences of genetic findings in ACM, all five desmosomal genes were sequenced in 149 Dutch ACM index patients. In total, 302 family members were screened for carriership of the identified pathogenic mutations in their family. Pathogenic mutations were found in 58% of index patients; these were mainly truncating *PKP2* mutations but included three cases with *PKP2* exon deletions. A *PKP2* mutation could be identified in 90% of families with more than one affected individual. The discovery of a pathogenic mutation in index patients enabled the identification of those relatives who have a 6-fold increased risk of developing ACM, justifying regularly monitoring for early symptoms.

The second part of this thesis focuses on the identification of a founder mutation in the phospholamban gene (PLN p.Arg14del) in a substantial number of Dutch patients with ACM and/or DCM. The clinical characteristics of index patients carrying this mutation are outlined in Chapter 7. A cohort of 97 unrelated ACM index patients and 257 unrelated DCM index patients was screened for *PLN* mutations. The p.Arg14del mutation was identified in 12% of ACM patients and in 15% of DCM patients in the Netherlands. This is the highest single mutation yield reported in Dutch cardiomyopathy patients. Patients carrying the PLN p.Arg14del mutation presented with a low voltage ECG in 46% of cases and demonstrated an arrhythmogenic phenotype, with high rates of appropriate implantable cardioverter defibrillator (ICD) discharges, cardiac transplantation, and a family history of sudden cardiac death. The average age of 26 family members who died of SCD was 37.7 years. Surprisingly, immunohistochemical analysis in myocardial samples, considered a diagnostic test for ACM, revealed absent or depressed plakoglobin levels at intercalated disks in five of seven (71%) p.Arg14del ACM samples, but in only one of nine (11%) p.Arg14del DCM samples. This chapter illustrates how one mutation can result in different clinical diagnoses, in this case both ACM and DCM, and that there is an overlap between these inherited cardiomyopathy subtypes.

The geographical distribution of carriers of this PLN founder mutation in the Netherlands is described in Chapter 8. Haplotype analysis revealed a common founder, estimated to be between 575 and 825 years old. Over 450 carriers have been identified and the majority live in the northern part of the Netherlands, including the province of Noord-Holland. Analysis of their grandparents' places of birth indicated that the mutation likely originated in the eastern part of the province Friesland. Screening of a large population-based cohort (PREVEND) for the presence of this mutation identified six PLN p.Arg14del mutation carriers out of 8,267 subjects (0.07%). These findings illustrated that the PLN p.Arg14del mutation is highly prevalent in the general population in the northern part of the Netherlands and that this mutation is also one of the most prevalent cardiomyopathy related genes in other parts of the Netherlands.

In Chapter 9, a large pedigree with ACM was studied. A previously identified mutation in *PKP2* (p.Ser140Phe) was found not to co-segregate with the disease in this family. After meticulous phenotypic characterisation, we could find no evidence that the *PKP2* variant contributed to the disease. However, the PLN p.Arg14del mutation was present in all family members with ACM and all of them had left ventricular involvement. Out of nine identified mutation carriers, four also had a low voltage ECG.

In patients with inherited cardiomyopathy the identification of a pathogenic mutation can confirm the diagnosis and subsequently asymptomatic relatives can be identified after cascade family screening. Clinical geneticists are at the heart of multidisciplinary teams consisting of genetic counsellors, molecular geneticists, cardiologists, pathologists, neurologists, and researchers, who together care for cardiomyopathy patients and their families. Following the recent advances in genetic research, as addressed in the General discussion, many novel mutations will be identified and counselling these families will become increasingly difficult. A challenging future lies ahead for clinical geneticists and their colleagues, but their patients and families will benefit from the progress that will be made by dealing with these challenges.

GENERAL DISCUSSION

In the last two decades, genetic research in families with cardiomyopathy has rapidly shifted from basic science towards routine clinical application, thereby changing the clinical practice. For instance, it has resulted in the fact that nowadays genetic counselling is recommended for all patients and their relatives with cardiomyopathy.⁸ The yield of genetic testing for cardiomyopathies ranges from <20% for restrictive cardiomyopathy to around 60% for hypertrophic cardiomyopathy.⁸ This means that currently no mutation can be identified in 40-80% of index patients with a suspected inherited form of cardiomyopathy. It is important to realise that not all forms of idiopathic cardiomyopathy are genetic. Unknown environmental factors could cause isolated or even familial cases of cardiomyopathy in the absence of a pathogenic mutation, so a yield of 100% is highly unlikely. Another factor that hampers genetic analyses in cardiomyopathy patients is the genetic heterogeneity. This is especially the case in dilated cardiomyopathy (DCM) where nearly 50 genes have now been identified, but most of these genes are found to hold mutations in only a small percentage of cases or even in single families. The recent identification of truncating titin gene (*TTN*) mutations in 25% of familial DCM cases is the exception to this rule.⁹ Due to the high costs and laborious tests, many cardiomyopathy patients will usually be screened for mutations in only a few genes. As a result, only the genes that supposedly account for the highest percentage of cases are being analysed. Sequence analysis of the remaining genes is hardly ever performed, and a definite diagnosis cannot be made in many cases.¹⁰ In general, it is rare that we have any clinical clues to guide the genetic screening in inherited cardiomyopathies. Examples of phenotypical information that could guide specific genetic testing are the presence of cardiac conduction disorders in ACM or DCM, which are frequently observed in patients with mutations in the *LMNA*, *DES*, and *SCN5A* genes,¹¹⁻¹³ or relatively less hypertrophy in patients with HCM caused by mutations in the *TNNT2* gene.¹⁴ Moreover, mutations can be present in more than one gene and the number of mutations can sometimes be related to the clinical impact; the involvement of two or three genes is usually associated with a more severe clinical picture.¹⁵⁻¹⁹

The identification of multiple mutations that can be associated with the phenotype poses a great challenge for clinical and molecular geneticists. Cardiomyopathies have previously been considered to be monogenic disorders, but the presence of multiple mutations indicates a more complex genetic background. A pathogenic mutation could be potentiated by other variants present in the same gene, in other genes, or even in the intergenic region. On the other hand, additional mutations could also reduce the strength of a pathogenic mutation. The presence of such additional mutations could explain the large clinical variability seen in patients and

within families with inherited cardiomyopathies. At the same time, this illustrates the importance of correctly interpreting the identified variants. Although *in silico* prediction programs and co-segregation analysis can assist, a lack of functional data and animal models hampers our interpretation of the mutations identified. Frequency data on identified mutations can be helpful, but large series of well-characterised patients are needed to establish enhancing or reducing effects between mutations.

The gathering of genetic data is rapidly becoming easier but, as a result, the classification and interpretation is becoming more and more challenging. To establish the effects of variants of unknown significance, we need to perform large-scale functional studies, but these are expensive and laborious. Gehmlich et al. studied *DSC2* mutations identified in ACM patients by expressing mutant proteins in multiple cellular systems.²⁰ A Western blot of the p.Thr275Met mutant protein, expressed in COS-1 cells, showed an impaired maturation process from the uncleaved precursor form to the cleaved mature form. The p.Arg203Cys protein was only detected in the precursor form. Localisation studies of the *DSC2* mutants in the cardiac cell line HL-1 showed that the p.Thr275Met protein was able to localise in the desmosomes, but a shift towards vesicular and Golgi apparatus localisation was observed. The p.Arg203Cys protein failed to localise at the cell borders and was absent from desmosomal structures.²⁰ These results show how functional assays could aid in the interpretation of (missense) mutations.

The study of mutations in zebrafish (*Danio rerio*) could be another approach for systematic mutation screens. Zebrafish that carried human Nexilin (*NEXN*) mutations, introduced by PCR mutagenesis, showed a similar cardiac pathology as human *NEXN* mutation carriers, including induced Z-disk damage and heart failure, confirming the disease-causing nature of these mutations.²¹

These approaches are not yet available for large-scale use, due to the needed time and resources. A model that classifies identified mutations without the need of additional experiments would be very helpful in this era of rapid emerging genetic data. A classification system combining *in silico* prediction methods and a structural model with phenotypic and segregation data to predict *CHD7* missense variants in CHARGE syndrome has been published.²² The model led to a more confident prediction of pathogenicity. Such a model could also be useful for the classification of missense variants in cardiomyopathy related genes. The incorporation of segregation studies, however, is difficult in inherited cardiomyopathies, since carriers of pathogenic mutations associated with cardiomyopathy could be mildly affected or even unaffected, given the variable expression and incomplete penetrance. The confirmation of model-based predictions by functional assays would be a powerful method to prove the strength and reliability of a model.

Given the challenges in the interpretation of variants, counselling patients and their families will also become increasingly difficult. Multiple variants are being identified in cardiomyopathy patients and the effects of these variants, both private and in combination with others, are often not yet understood. However, the identification of a pathogenic mutation can be of great clinical significance for the index patient under evaluation, because some genes are associated with important phenotypes such as early onset and/or sudden cardiac death, which could be prevented by placing an implantable cardioverter defibrillator.^{23,24} Much effort and resources are needed to correctly interpret identified variants. When a variant is classified as disease-causing or disease-contributing, cascade genetic screening of family members can be initiated. Those family members who are found not to be a carrier of the identified mutation(s) can be dismissed from frequent follow-up, further illustrating the importance of genetic testing in patients with cardiomyopathy.²⁵

The study of induced pluripotent stem cells (iPSCs), derived from patients with inherited cardiomyopathy, offers an opportunity for creating disease-specific cellular models to investigate underlying mechanisms. Generated cardiomyocytes from iPSCs derived from DCM patients carrying a mutation (p.Arg173Trp) in the *TNNT2* gene recapitulated the morphological and functional phenotypes of DCM to some extent.²⁶ Compared to controls, these cardiomyocytes exhibited altered calcium regulation and decreased contractility. Treatment with β -adrenergic blockers improved the function of iPSC-derived cardiomyocytes from DCM patients, illustrating that these cells may serve as a useful platform for exploring the effects of identified mutations and disease mechanisms.²⁶ In another study, generated cardiomyocytes from iPSCs from a patient with ACM, carrying a p.Leu614Pro mutation in the *PKP2* gene, showed reduced cell surface localisation of desmosomal proteins and a more adipogenic phenotype.²⁷ These patient-specific cells may therefore be a useful tool to study these cardiomyopathies and although iPSC-studies cannot discriminate between multiple mutations identified in one patient, these studies could prove to be useful in selecting specific therapeutic options.

Mutation detection arrays

After years of serial testing of one or a few genes at a time, several customised resequencing arrays have recently been developed to sequence large numbers of genes in parallel, in a cost-efficient manner. Analysis of all coding exons, splice site junctions and 5' untranslated regions of 12 genes in 38 unrelated HCM patients led to the identification of a pathogenic mutation in 60% of familial cases and in 10% of sporadic cases.²⁸ A similar approach was applied in 73 previously tested DCM patients, who were screened for mutations in 19 genes using the 'DCM CardioChip'. Combined with previously published data, the authors calculated a clinical sensitiv-

ity for this chip of 26-29% (notably, the chip did not include the *TTN* gene).²⁹ Since not many clear genotype-phenotype relationships have been identified that can guide the genetic screening in inherited cardiomyopathies, sequencing of multiple genes in the same experiment is a reasonable approach to adopt and several arrays/chips are now commercially available.

Next-generation sequencing

Rapid technological advances have led to the application of novel platforms which supersede the array/chip techniques. The introduction of so-called next-generation sequencing (NGS) has led to spectacular developments in genetic research. Sanger sequencing is currently being replaced by different sequencing technologies able to rapidly sequence millions of nucleotides in multiple samples in parallel. Next-generation techniques are based on library preparation: Genomic DNA is randomly broken into small fragments. These fragments are hybridised using a library containing the sequences of the genes of interest. In the next step, these fragments are amplified and sequenced. Imaging techniques and bioinformatics tools enable the generation of large volumes of sequence data and the identification of mutations in the patient's DNA. The risk of false-positive results (i.e. erroneously reported mutations which are not actually present) due to technical and bioinformatical limitations of these methods means the reported mutations must be confirmed, which is still done by Sanger sequencing.³⁰ These targeted platforms can generate a large coverage (the number of reads covering a specific DNA sequence), thereby lowering the risk of false-positives. In our first series of 96 cardiomyopathy patients, we found no false-positives after confirming 40 identified variants. In addition, we identified all the 91 variants previously detected using Sanger sequencing (unpublished data).

Targeted enrichment of DNA fragments encoding known (or suspected) disease genes is a promising application of NGS in the field of inherited cardiomyopathies.¹⁰ A proof-of-principle study analysed 47 cardiomyopathy-related genes in five HCM and five DCM patients. The targeted approach was applied to increase the coverage of the genomic regions of interest, i.e. the 47 genes, which was increased more than 2,000-fold compared to the whole genome. A pathogenic mutation was identified in six of these ten patients.³¹ The authors stated that the results can be made available within two weeks and the testing costs less than \$1,800 (€1,500). In our laboratory, using a targeted approach containing 50 cardiomyopathy genes, the results can be available within three weeks and cost around €400 for the enrichment kit and sequencing chemicals, but excluding salaries and overhead.

Sequencing of dozens of genes in a single experiment will lead to the identification of several previously unknown variants, of which only one or a few will be probably pathogenic. On average, we identified three novel variants (range 0-11)

in our series of 96 cardiomyopathy patients (unpublished data). Multiple affected family members could be studied to gain more insight in the pathogenicity of the identified variants. A variant present in all affected individuals but absent in healthy family members and controls is more likely to be pathogenic, but variants that are only identified in some or even only one of the affected family members could still contribute to the disease in that individual. The interpretation of identified variants is, as mentioned above, a major challenge and will likely be the bottleneck in genetic studies of inherited cardiomyopathies. Much more data will become available with the increased speed and lower costs of next-generation sequencing, but the interpretation of many novel variants requires expertise, time and additional studies, which are often not readily available.

A drawback of any custom-made approach is that they will unavoidably miss the genes that are identified after the panel has been designed. In 2011 three novel cardiomyopathy genes were discovered (Figure 1 in Chapter 1),³²⁻³⁵ illustrating the rapid developments being made in inherited cardiomyopathies.

Exome sequencing

The disadvantage of the non-incorporated genes in custom panels can be overcome by targeting the entire protein-coding sequence of the genome, called the 'exome'. The exome encompasses ~1% of the genome and includes 180,000 exons from more than 20,000 genes. After enrichment of the exome, similar NGS techniques can be applied as described above. Since all coding regions are targeted in exome sequencing, a large number of variants are identified for each sample. Typically, each exome contains between 20,000 and 50,000 variants.³⁶ Multiple bioinformatical filtering steps have to be applied to limit the number of potential disease-causing variants. Quality control steps will exclude those variants that have insufficient coverage, i.e. only a few sequence reads are aligned at a certain position, or are of low confidence, e.g. because only a low percentage of the reads contain a supposedly heterozygous variant. Non-coding variants and synonymous variants are usually filtered out, although non-coding variants in the promoter or untranslated region of a gene could be pathogenic and synonymous variants could influence mRNA splicing. Together with the exclusion of known variants from databases such as dbSNP, the 1000 Genomes Project, the Genome of the Netherlands project and/or in-house databases, the initial number of variants will be reduced by ~99%. However, filtering merely based on the presence in a database carries the risk that truly pathogenic variants may be excluded, since these pathogenic variants can be listed in the databases (known for dbSNP) and because recessive variants with relatively large carrier frequencies could also be listed. After these filtering steps, the remaining 150-500

private and potentially pathogenic variants will need further (*in silico*) analysis to single out the causative mutation or mutations.³⁶

Exome sequencing has been shown to be a very powerful tool in identifying disease-causing genes in a variety of Mendelian disorders.³⁷ In particular, mutations in autosomal recessive diseases and *de novo* mutations in autosomal dominant diseases have been identified using this approach in recent years. In cases of recessively inherited disorders and suspected consanguinity, the pathogenic mutations are most likely homozygous. When there is no evidence of consanguinity, the pathogenic variants could be compound heterozygous, i.e. two different mutations in both alleles of the same gene. Notably, homozygous mutations can also be identified in the absence of consanguinity. Prioritising for genes with two mutations can reduce the number of candidate genes to as few as seven or less, using a sample from only a single patient.³⁸⁻⁴¹

As with recessive disorders, the identification of *de novo* mutations has been shown to be feasible with exome sequencing, using a trio design with sequencing of the parents and the affected offspring. Sporadic diseases with a reduced reproductive capacity could be recessive, but could also be caused by *de novo* autosomal dominant mutations. These mutations can be selected by filtering out all variants that are present in the parents' exomes. This strategy has been used to identify mutations in mental retardation, autism, and schizophrenia.⁴²⁻⁴⁴ The reported rates of *de novo* coding mutations ranged from 0.75 to 0.90 per trio in these studies, which is in agreement with the calculation that, on average, a newborn has 50 to 100 *de novo* mutations in his or her genome, resulting in approximately 0.86 *de novo* amino acid-altering mutations.⁴⁵

The identification of a mutation in an autosomal dominant pedigree is more difficult, since all shared heterozygous variants could be disease-causing. However, successful cases in which the causative mutation was found have recently been reported: In a family with autosomal dominantly inherited amyotrophic lateral sclerosis, exome sequencing was combined with linkage analysis to identify the causative mutation.⁴⁶ In a large family with Charcot-Marie-Tooth disease, exome sequencing in three affected individuals, separated by eight meioses, identified only one variant shared by each individual.⁴⁷

220

Exome sequencing for cardiomyopathies

Unfortunately, the powerful strategies mentioned in the previous section are not very suitable for the genetically heterogeneous inherited cardiomyopathies, since they are mostly autosomal dominantly inherited and the affected families are often small. *De novo* mutations have been described in cases of cardiomyopathy,⁴⁸⁻⁵² but they occur infrequently although they seem to be more prevalent in children with

restricted cardiomyopathy.^{53,54} However, assuming a *de novo* mutation in a cardiomyopathy patient is dangerous, since incomplete penetrance could well explain the absence of a phenotype in a parent who is a carrier of the causative mutation.

To apply exome sequencing in families with autosomal dominant diseases such as inherited cardiomyopathies, additional steps need to be taken. Combining exome sequencing with linkage strategies is a possible solution to this problem. In a family with recessively inherited cardiomyopathy, linkage analysis and homozygosity mapping identified the disease locus on chromosome 7q21. Exome sequencing of two affected sisters revealed a single shared homozygous missense mutation in the *GATAD1* gene, located on the 7q21 locus.³⁴ We have shown that a haplotype-sharing test (HST) using SNP-arrays can help in identifying shared loci which are most likely to contain the causative mutation. In the reported families, cardiomyopathy associated genes were located in these regions and mutations in *PKP2* and *MYH7* were identified.⁵⁵ In another family with dilated cardiomyopathy, by applying the HST and exome sequencing, we identified a *TTN* mutation located in the second-largest shared haplotype.⁵⁶ A similar approach identified a *TTN* mutation in four patients with hereditary myopathy with early respiratory failure, who were later found to share a haplotype containing the *TTN* gene, indicating a common ancestor.⁵⁷

Since classic linkage analysis is often not feasible in cardiomyopathy families, due to the small family sizes and the incomplete penetrance, a combined approach of the HST and exome sequencing, preferably with sequencing of at least two affected family members, could be successful. Even in small families, the HST could be useful, since each informative meiosis excludes 50% of the genome. Although the studies mentioned above used SNP arrays for the haplotyping or linkage studies, it is possible to infer haplotypes from the available exome data from multiple family members. This has been shown for the autosomal recessive hyperphosphatasia-mental retardation syndrome.⁵⁸

Exome data could also be used for a targeted approach. In this case there is no targeted capturing of genes associated with cardiomyopathy, but a targeted bioinformatics filtering for variants in any of these cardiomyopathy-related genes. At the moment, this may be more expensive and laborious, and more important, current exome enrichment strategies still result in incomplete representation and coverage of exons of interest, which would result in clinically relevant mutations being missed (see also below). However, when these strategies are improved, an advantage of exome sequencing will be that newly reported disease genes can be studied using the already available data without the need to perform new experiments. With falling costs, exome sequencing will eventually be replaced by whole-genome sequencing, enabling the study of the non-coding part of the genome, in addition to the exome.

Drawbacks of exome sequencing

Although exome sequencing will be successfully applied in many more Mendelian diseases in the coming years, there are a number of drawbacks that need to be recognised. The definition of the exome is not a strict or universal one. Different commercial exome platforms target different exonic segments; the comparison of Nimblegen, Agilent, and Illumina platforms showed that the targeted regions ranged from 44 Mb to 62 Mb and from 188,000 exons to 300,000 exons.^{59,60} So depending on the selected platform, the gene(s) and/or exon(s) containing the disease-causing mutation(s) could not be targeted at all and therefore these mutations will not be identified using that platform. When taking a 10-fold coverage as a minimum, the overall targeting efficiency for each platform (at 80 million reads), ranged from 96.8% for Nimblegen, to 90.0% for Illumina, and 89.6% for Agilent.⁶⁰ This shows that up to 10% of the exome would not pass the quality control filters if set at ≥ 10 fold coverage for a large (80 million reads) dataset, so in one out of ten cases, the causative mutation might be missed due to a lack of coverage. To overcome this issue, more reads could be sequenced but this will mean higher costs.

The filtering steps used could also filter out the mutation due to bioinformatic problems, e.g. the presence of the mutation in a control cohort such as dbSNP. If the mutation is a synonymous variant which results in cryptic RNA splicing, this variant is also likely to be excluded during filtering. Large insertions or deletions might also be missed, although these can be detected by using array-comparative genomic hybridisation (array-CGH) or might be detected by still to be developed bioinformatical tools that will be able to deduce copy number information from exome data. In addition, when the cause of the disease is located outside the exome, i.e. in the non-coding region of the genome, this will not be targeted with an exome platform. To search for variants outside the coding regions, whole-genome sequencing could be performed. As for exome sequencing, performing whole-genome sequencing will result in very large amounts of data that cannot be easily interpreted at the moment, although whole-genome sequencing will become more informative in the future and could also be applied for genome-wide association studies and linkage analysis. With falling costs, a transition from exome sequencing to whole-genome sequencing can be anticipated. The non-targeted whole-genome sequencing approach will result in a more proportionate distribution of sequence reads and therefore in higher coverage.

Genetic strategy for cardiomyopathies

A scheme for the genetic analysis of patients diagnosed with cardiomyopathy is shown in Figure 1. Depending on the phenotype and the costs, one or a few candidate genes with a known high yield in the population could be screened first. In

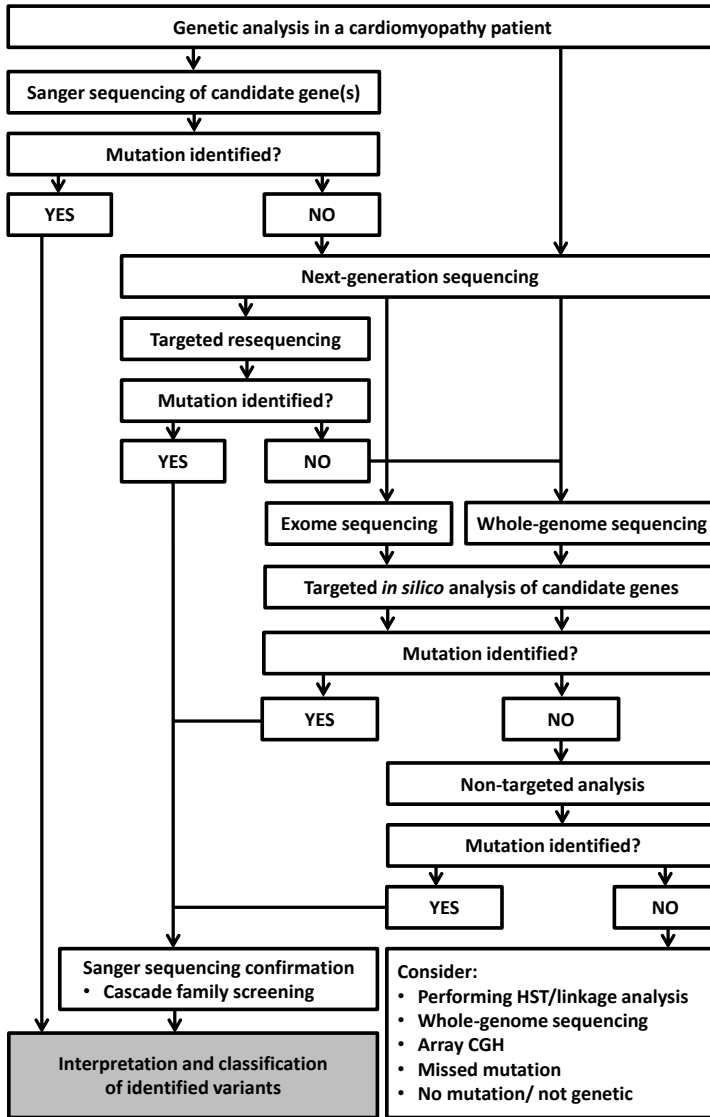

Figure 1 Schematic overview for the genetic analysis in inherited cardiomyopathies. Sanger sequencing of one or a few candidate genes should be considered first. If not performed or no mutations are identified, different next-generation sequencing strategies could be used, depending on the available resources. Targeted analysis could be performed using targeted enrichment or after targeted filtering of exome or whole-genome data. If no mutation is identified, several options could be considered, e.g. missing a mutation due to erroneous filtering. The interpretation and classification of the identified variants is the ultimate and most challenging step in the identification of pathogenic mutations in inherited cardiomyopathies.

patients with ACM, this would mean that sequencing of the *PKP2* gene, and the *PLN* gene in the case of Dutch ancestors, should be performed first, especially in familial Dutch cases, which are in 90% of cases caused by *PKP2* mutations,⁶¹ and the remaining 10% is almost completely caused by *PLN* mutations (unpublished data). If no causative mutation can be identified or multiple mutations are expected, as is the case in about 6% of ACM patients (see Introduction; Table 3), or as could be indicated by the severity of the disease, a targeted analysis could be performed. A targeted approach as a first step is justified for DCM patients, since so many genes are associated with the disease. It depends on the available resources whether this could be done by targeted enrichment of the known cardiomyopathy genes or by exome sequencing with targeted filtering. Although we have not identified any false-positive variants using our targeted approach, Sanger sequencing could be used to confirm true-positive calls and can subsequently be used for co-segregation analysis and cascade screening in family members. If no mutation is identified, the haplotype-sharing test or another type of linkage analysis should preferably be combined with exome sequencing. This requires sampling of additional affected family members. If no mutation can be identified using these strategies, several other options can be considered. First, the option that the disease is not genetic, which should of course be considered from the start, but it becomes more likely after extensive genetic research has not pinpointed a genetic cause. Second, the genetic cause could have been missed due to one of the reasons mentioned in the previous section and alternative techniques like array-CGH should be considered. Third, future developments could help identify a mutation in a patient. These could be: (a) genetic findings, e.g. non-coding variants identified using whole-genome sequencing and/or epigenetic changes (i.e. heritable changes in gene expression without changes in their coding sequence). Examples of such changes are histone modification and DNA methylation.⁶² (b) clinical developments in the family of a patient could also provide new insight; if more family members go on to develop the disease the likely success of haplotype sharing and filtering for shared variants will increase. So, after a certain period, a family could be re-evaluated, using new information.

Risk stratification and personalised medicine

224

The implementation of exome or whole-genome sequencing will have a large impact on patient care. The identification of a genetic cause for the disease is only the starting point of the influence of genetic information. It can aid in making a more accurate diagnosis and prognosis, in choosing treatment options, and further enables other family members at risk for the disease to be identified. Genetic information can also be important in the risk stratification of inherited cardiomyopathies. In a

study on risk factors for malignant ventricular arrhythmias in carriers of mutations in the *LMNA* gene, the presence of a truncating or splice mutation was found to be an independent risk factor, when compared to missense mutations.⁶³ Another example is the long QT syndrome type 1 (LQTS1), a disease characterised by a prolonged QT interval and life-threatening arrhythmias, caused by mutations in the *KCNQ1* gene. SNPs in the 3' untranslated region of the *KCNQ1* gene were found to greatly modify disease severity in LQTS1 patients.⁶⁴ Compared with LQTS type 2 and type 3, beta-blocker therapy is more efficient in patients with LQTS1, illustrating a genotype-specific response and the importance of knowing the mutated gene.⁶⁵ Although these are illustrative examples, risk-stratification and treatment strategies based on the genetic background will remain unavailable for the majority of patients with inherited cardiomyopathies until large-scale collaborative studies have been performed. Given the genetic heterogeneity of the cardiomyopathies, this will be a great challenge.

In pharmacogenomics, genetic variation is being used to tailor drug therapies. These variations could modulate the pharmacokinetics of a drug, e.g. by slowing down its metabolism, resulting in increased availability of the compound and thus requiring a lower maintenance dose. A well-known cardiovascular example is the anti-coagulant drug warfarin: polymorphisms in three genes have been identified as influencing the appropriate dose of warfarin and dosage regimens based on the genotype data have been shown to reduce the risk of hospitalisation.^{66,67} Over 2,000 genes have been suggested to be involved in drug response, but the pharmacogenomics of cardiovascular disease is not yet established in clinical practice.⁶⁸ With the increasing emergence of genetic information, the use of pharmacogenomics will progress, but we should be cautious about being too optimistic, because it may prove to be like gene-therapy, which seemed very promising at first, but turned out to be much more difficult than anticipated. For instance, in pharmacogenomics we cannot exclude that proven effects of certain polymorphisms are enhanced or undone by other genetic variants that remain to be elucidated.

A nice example on the incorporation of whole-genome sequencing in risk assessment was published recently.⁶⁹ The authors reported the presence of 69 pharmacogenomic variants, of which 63 had previously been reported and six were novel but located in genes related to drug response. Furthermore, they used the genotype status for SNPs that have been associated in numerous genome-wide association studies to estimate disease probabilities for 55 diseases. For 15 of these diseases, the genetic risk was increased or decreased, defined by a likelihood ratio of >2 or <0.5 , based on the genotype data.⁶⁹

Several companies are nowadays offering SNP genotyping arrays to calculate personalised genetic risks directly to consumers. With the decreasing costs, such

companies will be offering exome or whole-genome sequencing in the near future. Patients will bring their own genetic data to their appointment with a clinical geneticist or other medical doctor, who will be expected to be able to judge these data in an appropriate way. Even though the significance of many variants will remain unknown for a long time, well-known pathogenic mutations will also be revealed and these will need appropriate interpretation and management. Clinical geneticists and genetic counsellors are trained to counsel patients and families about their genetic risks. Ideally, individuals are being counselled about their risks and the consequences of test results before genetic testing is started. With increasing uptake of commercially available genetic tests, however, more and more individuals will not seek genetic counselling until after genetic testing. These companies could hire geneticists to deal with questions from their consumers, but clinical geneticists and other health care professionals need to be aware that the impact of genetic information will rapidly increase. A boom could be expected, but even likely this is followed by decreased enthusiasm of consumers when they realise that at the moment much of their genetic data is non-informative or not interpretable with the current knowledge.

Taken together, the rapid progress in genetics in recent years will revolutionise the field of medicine, offering great opportunities to improve the care of patients but at the same time introducing many challenges. The available exome or whole-genome data of patients will contain many variants of unknown significance. Correct interpretation of these variants will need reliable prediction models and preferably large-scale functional assays, which will form the new bottleneck in the genetic assessment of patients. In the case of arrhythmogenic cardiomyopathy, in the five desmosomal genes alone, multiple variants are expected to be present in 6% of patients. In theory, these additional variants could explain the clinical variability seen between patients and within families, but in practice the weight of each variant and their possible interactions are very hard to determine. The presence of a pathogenic mutation in a patient with arrhythmogenic cardiomyopathy indicates a risk for a malignant course of the disease, but genotype-specific treatment is, as yet, unavailable.

It is important to note is that non-targeted approaches such as exome and whole-genome sequencing could identify mutations in genes not related (or not yet known to be related) to the disease, but which could be clinically relevant. An example of such an accidental finding would be the identification of a mutation in the *BRCA1* gene, which conveys an increased risk of breast cancer and ovarian cancer. Genetic counselling is therefore of the utmost importance. Not all patients want to know their risk of other diseases than the reason they sought medical help

for, even if surveillance and treatment options are available, illustrating the need for proper counselling and informed consent. Whether or not there is a duty for the physician to recontact the patient on discovering something which may, or certainly, impact their (later) health is part of an unresolved legal and ethical discussion.⁷⁰

In theory, insurance companies could use genetic data to assess the risks of individuals and increase their premium, or even exclude individuals at higher risk. To protect individuals from discrimination by life or health insurance companies on the basis of their genetic information, genetic non-discrimination legislation has now been introduced in most European countries, beginning in 1990 in Belgium. Since 2008, the United States has a federal law called the Genetic Information Non-discrimination Act to protect against genetic discrimination for employment and health insurance.⁷¹ In the Netherlands, insurance companies are also restricted in the use of genetic information of their clients. A survey among hypertrophic cardiomyopathy (HCM) mutation carriers showed that they frequently encounter problems when applying for insurances, often in the case of manifest disease, but the risk assessment of insurance companies is largely justified. However, 5% of mutations carriers encountered potentially unjustified problems, indicating the necessity to monitor the application of the existing laws and regulations by insurance companies.⁷² Furthermore, updates of current legislation could be needed to accommodate emerging genetic data.

To keep up with the pace of genetic progress, we need to further combine clinical care with genomic and basic research in order to unravel new molecular pathways underlying diseases and new treatment options. The functional characterisation of novel variants is laborious work but it is proving indispensable. A challenging future lies ahead for clinical geneticists and genetic counsellors who will be confronted with increasing amounts of genetic data, often lacking a well-argued interpretation. We need to be aware of the risks of genetic discrimination and the challenges posed by accidental findings. With these challenges in mind, the sharing of data in large, freely accessible databases or biobanks and large-scale international collaborations are essential. These steps will prevent that the ongoing progress in genetic research remains limited to the scientific community and should guarantee that patients will also benefit from our shared efforts.

REFERENCES

1. Basso C, Corrado D, Marcus FI, Nava A, Thiene G. Arrhythmogenic right ventricular cardiomyopathy. *Lancet*. 2009;373:1289-300.
2. Marcus FI, Fontaine GH, Guiraudon G, Frank R, Laurenceau JL, Malergue C, Grosgeat Y. Right ventricular dysplasia: a report of 24 adult cases. *Circulation*. 1982;65:384-98.
3. Corrado D, Basso C, Thiene G, McKenna WJ, Davies MJ, Fontaliran F, Nava A, Silvestri F, Blomstrom-Lundqvist C, Wlodarska EK, Fontaine G, Camerini F. Spectrum of clinicopathologic manifestations of arrhythmogenic right ventricular cardiomyopathy/dysplasia: a multicenter study. *J Am Coll Cardiol*. 1997;30:1512-20.
4. Sen-Chowdhry S, Syrris P, Ward D, Asimaki A, Sevdalis E, McKenna WJ. Clinical and genetic characterization of families with arrhythmogenic right ventricular dysplasia/cardiomyopathy provides novel insights into patterns of disease expression. *Circulation*. 2007;115:1710-20.
5. Sen-Chowdhry S, Syrris P, Prasad SK, Hughes SE, Merrifield R, Ward D, Pennell DJ, McKenna WJ. Left-dominant arrhythmogenic cardiomyopathy an under-recognized clinical entity. *J Am Coll Cardiol*. 2008;52:2175-87.
6. Dalal D, Nasir K, Bomma C, Prakasa K, Tandri H, Piccini J, Roguin A, Tichnell C, James C, Russell SD, Judge DP, Abraham T, Spevak PJ, Bluemke DA, Calkins H. Arrhythmogenic right ventricular dysplasia: a United States experience. *Circulation*. 2005;112:3823-32.
7. Baucé B, Rampazzo A, Basso C, Mazzotti E, Rigato I, Steriotis A, Beggagna G, Lorenzon A, De Bortoli M, Pilichou K, Marra MP, Corbetti F, D'Aliento L, Iliceto S, Corrado D, Thiene G, Nava A. Clinical phenotype and diagnosis of arrhythmogenic right ventricular cardiomyopathy in pediatric patients carrying desmosomal gene mutations. *Heart Rhythm*. 2011;8:1686-95.
8. Ackerman MJ, Priori SG, Willems S, Berul C, Brugada R, Calkins H, Camm AJ, Ellinor PT, Gollob M, Hamilton R, Hershberger RE, Judge DP, Le Marec H, McKenna WJ, Schulze-Bahr E, Semsarian C, Towbin JA, Watkins H, Wilde A, Wolpert C, Zipes DP, Heart Rhythm Society (HRS), European Heart Rhythm Association (EHRA). HRS/EHRA expert consensus statement on the state of genetic testing for the channelopathies and cardiomyopathies: this document was developed as a partnership between the Heart Rhythm Society (HRS) and the European Heart Rhythm Association (EHRA). *Europace*. 2011;13:1077-109.
9. Herman DS, Lam L, Taylor MR, Wang L, Teekakirikul P, Christodoulou D, Conner L, DePalma SR, McDonough B, Sparks E, Teodorescu DL, Cirino AL, Banner NR, Pennell DJ, Graw S, Merlo M, Di Lenarda A, Sinagra G, Bos JM, Ackerman MJ, Mitchell RN, Murry CE, Lakdawala NK, Ho CY, Barton PJ, Cook SA, Mestroni L, Seidman JG, Seidman CE. Truncations of titin causing dilated cardiomyopathy. *N Engl J Med*. 2012;366:619-28.
10. Jongbloed JD, Pósfalvi A, Kerstjens-Frederikse W, Sinke RJ, van Tintelen JP. New clinical molecular diagnostic methods for congenital and inherited heart disease. *Expert Opin Med Diagn*. 2011;5:9-24.
11. Van Tintelen JP, Hofstra RM, Katerberg H, Rossenbacker T, Wiesfeld AC, du Marchie Sarvaas GJ, Wilde AA, van Langen IM, Nannenbergh EA, van der Kooij AJ, Kraak M, van Gelder IC, van Veldhuisen DJ, Vos Y, van den Berg MP, Working Group on Inherited Cardiac Disorders, line 27/50, Interuniversity Cardiology Institute of The Netherlands. High yield of LMNA mutations in patients with dilated cardiomyopathy and/or conduction disease referred to cardiogenetics outpatient clinics. *Am Heart J*. 2007;154:1130-9.
12. Van Tintelen JP, van Gelder IC, Asimaki A, Suurmeijer AJ, Wiesfeld AC, Jongbloed JD, van den Wijngaard A, Kuks JB, Spaendonck-Zwarts KY, Notermans N, Boven L, van den Heuvel F, Veenstra-Knol HE, Saffitz JE, Hofstra RM, van den Berg MP. Severe cardiac phenotype with right ventricular

- predominance in a large cohort of patients with a single missense mutation in the DES gene. *Heart Rhythm*. 2009;6:1574-83.
13. McNair WP, Ku L, Taylor MR, Fain PR, Dao D, Wolfel E, Mestroni L, Familial Cardiomyopathy Registry Research Group. SCN5A mutation associated with dilated cardiomyopathy, conduction disorder, and arrhythmia. *Circulation*. 2004;110:2163-7.
 14. Varnava AM, Elliott PM, Baboonian C, Davison F, Davies MJ, McKenna WJ. Hypertrophic cardiomyopathy: histopathological features of sudden death in cardiac troponin T disease. *Circulation*. 2001;104:1380-4.
 15. Van Driest SL, Vasile VC, Ommen SR, Will ML, Tajik AJ, Gersh BJ, Ackerman MJ. Myosin binding protein C mutations and compound heterozygosity in hypertrophic cardiomyopathy. *J Am Coll Cardiol*. 2004;44:1903-10.
 16. Fressart V, Duthoit G, Donal E, Probst V, Deharo JC, Chevalier P, Klug D, Dubourg O, Delacretaz E, Cosnay P, Scanu P, Extramiana F, Keller D, Hidden-Lucet F, Simon F, Bessirard V, Roux-Buisson N, Hebert JL, Azarine A, Casset-Senon D, Rouzet F, Lecarpentier Y, Fontaine G, Coirault C, Frank R, Hainque B, Charron P. Desmosomal gene analysis in arrhythmogenic right ventricular dysplasia/cardiomyopathy: spectrum of mutations and clinical impact in practice. *Europace*. 2010;12:861-8.
 17. Girolami F, Ho CY, Semsarian C, Baldi M, Will ML, Baldini K, Torricelli F, Yeates L, Cecchi F, Ackerman MJ, Olivetto I. Clinical features and outcome of hypertrophic cardiomyopathy associated with triple sarcomere protein gene mutations. *J Am Coll Cardiol*. 2010;55:1444-53.
 18. Bauce B, Nava A, Beffagna G, Basso C, Lorenzon A, Smaniotto G, De Bortoli M, Rigato I, Mazzotti E, Steriotis A, Marra MP, Towbin JA, Thiene G, Danieli GA, Rampazzo A. Multiple mutations in desmosomal proteins encoding genes in arrhythmogenic right ventricular cardiomyopathy/dysplasia. *Heart Rhythm*. 2010;7:22-9.
 19. Xu T, Yang Z, Vatta M, Rampazzo A, Beffagna G, Pilichou K, Scherer SE, Saffitz J, Kravitz J, Zareba W, Danieli GA, Lorenzon A, Nava A, Bauce B, Thiene G, Basso C, Calkins H, Gear K, Marcus F, Towbin JA, Multidisciplinary Study of Right Ventricular Dysplasia Investigators. Compound and digenic heterozygosity contributes to arrhythmogenic right ventricular cardiomyopathy. *J Am Coll Cardiol*. 2010;55:587-97.
 20. Gehmlich K, Syrris P, Peskett E, Evans A, Ehler E, Asimaki A, Anastasakis A, Tsatsopoulou A, Vouliotis AI, Stefanadis C, Saffitz JE, Protonotarios N, McKenna WJ. Mechanistic insights into arrhythmogenic right ventricular cardiomyopathy caused by desmocollin-2 mutations. *Cardiovasc Res*. 2011;90:77-87.
 21. Hassel D, Dahme T, Erdmann J, Meder B, Hugel A, Stoll M, Just S, Hess A, Ehlermann P, Weichenhan D, Grimm M, Liptau H, Hetzer R, Regitz-Zagrosek V, Fischer C, Nurnberg P, Schunkert H, Katus HA, Rottbauer W. Nexilin mutations destabilize cardiac Z-disks and lead to dilated cardiomyopathy. *Nat Med*. 2009;15:1281-8.
 22. Bergman JE, Janssen N, van der Sloot AM, de Walle HE, Schoots J, Rendtorff ND, Tranebjaerg L, Hoefsloot LH, van Ravenswaaij-Arts CM, Hofstra RM. A novel classification system to predict the pathogenic effects of CHD7 missense variants in CHARGE syndrome. *Hum Mutat*. 2012;33:1251-60.
 23. Van Berlo JH, de Voogt WG, van der Kooij AJ, van Tintelen JP, Bonne G, Yaou RB, Duboc D, Rossenbacker T, Heidebuchel H, de Visser M, Crijns HJ, Pinto YM. Meta-analysis of clinical characteristics of 299 carriers of LMNA gene mutations: do lamin A/C mutations portend a high risk of sudden death? *J Mol Med*. 2005;83:79-83.

24. Mogensen J, Murphy RT, Shaw T, Bahl A, Redwood C, Watkins H, Burke M, Elliott PM, McKenna WJ. Severe disease expression of cardiac troponin C and T mutations in patients with idiopathic dilated cardiomyopathy. *J Am Coll Cardiol.* 2004;44:2033-40.
25. Van Tintelen JP, Hofstra RM, Wiesfeld AC, van den Berg MP, Hauer RN, Jongbloed JD. Molecular genetics of arrhythmogenic right ventricular cardiomyopathy: emerging horizon? *Curr Opin Cardiol.* 2007;22:185-92.
26. Sun N, Yazawa M, Liu J, Han L, Sanchez-Freire V, Abilez OJ, Navarrete EG, Hu S, Wang L, Lee A, Pavlovic A, Lin S, Chen R, Hajjar RJ, Snyder MP, Dolmetsch RE, Butte MJ, Ashley EA, Longaker MT, Robbins RC, Wu JC. Patient-specific induced pluripotent stem cells as a model for familial dilated cardiomyopathy. *Sci Transl Med.* 2012;4:130ra47.
27. Ma D, Wei H, Lu J, Ho S, Zhang G, Sun X, Oh Y, Tan SH, Ng ML, Shim W, Wong P, Liew R. Generation of patient-specific induced pluripotent stem cell-derived cardiomyocytes as a cellular model of arrhythmogenic right ventricular cardiomyopathy. *Eur Heart J.* 2012;Epub ahead of print.
28. Fokstuen S, Lyle R, Munoz A, Gehrig C, Lerch R, Perrot A, Osterziel KJ, Geier C, Beghetti M, Mach F, Sztajzel J, Sigwart U, Antonarakis SE, Blouin JL. A DNA resequencing array for pathogenic mutation detection in hypertrophic cardiomyopathy. *Hum Mutat.* 2008;29:879-85.
29. Zimmerman RS, Cox S, Lakdawala NK, Cirino A, Mancini-DiNardo D, Clark E, Leon A, Duffy E, White E, Baxter S, Alaamery M, Farwell L, Weiss S, Seidman CE, Seidman JG, Ho CY, Rehm HL, Funke BH. A novel custom resequencing array for dilated cardiomyopathy. *Genet Med.* 2010;12:268-78.
30. Metzker ML. Sequencing technologies - the next generation. *Nat Rev Genet.* 2010;11:31-46.
31. Meder B, Haas J, Keller A, Heid C, Just S, Borries A, Boisguerin V, Scharfenberger-Schmeer M, Stahler P, Beier M, Weichenhan D, Strom TM, Pfeufer A, Korn B, Katus HA, Rottbauer W. Targeted next-generation sequencing for the molecular genetic diagnostics of cardiomyopathies. *Circ Cardiovasc Genet.* 2011;4:110-22.
32. Norton N, Li D, Rieder MJ, Siegfried JD, Rampersaud E, Zuchner S, Mangos S, Gonzalez-Quintana J, Wang L, McGee S, Reiser J, Martin E, Nickerson DA, Hershberger RE. Genome-wide studies of copy number variation and exome sequencing identify rare variants in BAG3 as a cause of dilated cardiomyopathy. *Am J Hum Genet.* 2011;88:273-82.
33. Villard E, Perret C, Gary F, Proust C, Dilanian G, Hengstenberg C, Ruppert V, Arbustini E, Wichter T, Germain M, Dubourg O, Tavazzi L, Aumont MC, DeGroot P, Fauchier L, Trochu JN, Gibelin P, Aupetit JF, Stark K, Erdmann J, Hetzer R, Roberts AM, Barton PJ, Regitz-Zagrosek V, Cardiogenics Consortium, Aslam U, Duboscq-Bidot L, Meyborg M, Maisch B, Madeira H, Waldenstrom A, Galve E, Cleland JG, Dorent R, Roizes G, Zeller T, Blankenberg S, Goodall AH, Cook S, Tregouet DA, Tiret L, Isnard R, Komajda M, Charron P, Cambien F. A genome-wide association study identifies two loci associated with heart failure due to dilated cardiomyopathy. *Eur Heart J.* 2011;32:1065-76.
34. Theis JL, Sharpe KM, Matsumoto ME, Chai HS, Nair AA, Theis JD, de Andrade M, Wieben ED, Michels VV, Olson TM. Homozygosity mapping and exome sequencing reveal GATAD1 mutation in autosomal recessive dilated cardiomyopathy. *Circ Cardiovasc Genet.* 2011;4:585-94.
35. Sibbing D, Pfeufer A, Perisic T, Mannes AM, Fritz-Wolf K, Unwin S, Sinner MF, Gieger C, Gloeckner CJ, Wichmann HE, Kremmer E, Schafer Z, Walch A, Hinterseer M, Nabauer M, Kaab S, Kastrati A, Schomig A, Meitinger T, Bornkamm GW, Conrad M, von Beckerath N. Mutations in the mitochondrial thioredoxin reductase gene TXNRD2 cause dilated cardiomyopathy. *Eur Heart J.* 2011;32:1121-33.
36. Gilissen C, Hoischen A, Brunner HG, Veltman JA. Disease gene identification strategies for exome sequencing. *Eur J Hum Genet.* 2012;20:490-7.

37. Bamshad MJ, Ng SB, Bigham AW, Tabor HK, Emond MJ, Nickerson DA, Shendure J. Exome sequencing as a tool for Mendelian disease gene discovery. *Nat Rev Genet.* 2011;12:745-55.
38. Pierce SB, Walsh T, Chisholm KM, Lee MK, Thornton AM, Fiumara A, Opitz JM, Levy-Lahad E, Klevit RE, King MC. Mutations in the DBP-deficiency protein HSD17B4 cause ovarian dysgenesis, hearing loss, and ataxia of Perrault Syndrome. *Am J Hum Genet.* 2010;87:282-8.
39. Gilissen C, Arts HH, Hoischen A, Spruijt L, Mans DA, Arts P, van Lier B, Steehouwer M, van Reeuwijk J, Kant SG, Roepman R, Knoers NV, Veltman JA, Brunner HG. Exome sequencing identifies WDR35 variants involved in Sensenbrenner syndrome. *Am J Hum Genet.* 2010;87:418-23.
40. Musunuru K, Pirruccello JP, Do R, Peloso GM, Guiducci C, Sougnez C, Garimella KV, Fisher S, Abreu J, Barry AJ, Fennell T, Banks E, Ambrogio L, Cibulskis K, Kernytzky A, Gonzalez E, Rudzicz N, Engert JC, DePristo MA, Daly MJ, Cohen JC, Hobbs HH, Altshuler D, Schonfeld G, Gabriel SB, Yue P, Kathiresan S. Exome sequencing, ANGPTL3 mutations, and familial combined hypolipidemia. *N Engl J Med.* 2010;363:2220-7.
41. Murdock DR, Clark GD, Bainbridge MN, Newsham I, Wu YQ, Muzny DM, Cheung SW, Gibbs RA, Ramocki MB. Whole-exome sequencing identifies compound heterozygous mutations in WDR62 in siblings with recurrent polymicrogyria. *Am J Med Genet A.* 2011;155A:2071-7.
42. Vissers LE, de Ligt J, Gilissen C, Janssen I, Steehouwer M, de Vries P, van Lier B, Arts P, Wieskamp N, del Rosario M, van Bon BW, Hoischen A, de Vries BB, Brunner HG, Veltman JA. A de novo paradigm for mental retardation. *Nat Genet.* 2010;42:1109-12.
43. O'Roak BJ, Deriziotis P, Lee C, Vives L, Schwartz JJ, Girirajan S, Karakoc E, Mackenzie AP, Ng SB, Baker C, Rieder MJ, Nickerson DA, Bernier R, Fisher SE, Shendure J, Eichler EE. Exome sequencing in sporadic autism spectrum disorders identifies severe de novo mutations. *Nat Genet.* 2011;43:585-9.
44. Xu B, Roos JL, Dexheimer P, Boone B, Plummer B, Levy S, Gogos JA, Karayiorgou M. Exome sequencing supports a de novo mutational paradigm for schizophrenia. *Nat Genet.* 2011;43:864-8.
45. Lynch M. Rate, molecular spectrum, and consequences of human mutation. *Proc Natl Acad Sci U S A.* 2010;107:961-8.
46. Johnson JO, Mandrioli J, Benatar M, Abramzon Y, Van Deerlin VM, Trojanowski JQ, Gibbs JR, Brunetti M, Gronka S, Wu J, Ding J, McCluskey L, Martinez-Lage M, Falcone D, Hernandez DG, Arepalli S, Chong S, Schymick JC, Rothstein J, Landi F, Wang YD, Calvo A, Mora G, Sabatelli M, Monsurro MR, Battistini S, Salvi F, Spataro R, Sola P, Borghero G, ITALSGEN Consortium, Galassi G, Scholz SW, Taylor JP, Restagno G, Chio A, Traynor BJ. Exome sequencing reveals VCP mutations as a cause of familial ALS. *Neuron.* 2010;68:857-64.
47. Weedon MN, Hastings R, Caswell R, Xie W, Paszkiewicz K, Antoniadis T, Williams M, King C, Greenhalgh L, Newbury-Ecob R, Ellard S. Exome sequencing identifies a DYNC1H1 mutation in a large pedigree with dominant axonal Charcot-Marie-Tooth disease. *Am J Hum Genet.* 2011;89:308-12.
48. Watkins H, Thierfelder L, Hwang DS, McKenna W, Seidman JG, Seidman CE. Sporadic hypertrophic cardiomyopathy due to de novo myosin mutations. *J Clin Invest.* 1992;90:1666-71.
49. Watkins H, Anan R, Coviello DA, Spirito P, Seidman JG, Seidman CE. A de novo mutation in alpha-tropomyosin that causes hypertrophic cardiomyopathy. *Circulation.* 1995;91:2302-5.
50. Kimura A, Harada H, Park JE, Nishi H, Satoh M, Takahashi M, Hiroi S, Sasaoka T, Ohbuchi N, Nakamura T, Koyanagi T, Hwang TH, Choo JA, Chung KS, Hasegawa A, Nagai R, Okazaki O, Nakamura H, Matsuzaki M, Sakamoto T, Toshima H, Koga Y, Imaizumi T, Sasazuki T. Mutations in the cardiac troponin I gene associated with hypertrophic cardiomyopathy. *Nat Genet.* 1997;16:379-82.
51. Gandjbakhch E, Fressart V, Bertaux G, Faivre L, Simon F, Frank R, Fontaine G, Villard E, Coirault C, Hainque B, Charron P. Sporadic arrhythmogenic right ventricular cardiomyopathy/dysplasia due to a de novo mutation. *Europace.* 2009;11:379-81.

52. Klauke B, Kossmann S, Gaertner A, Brand K, Stork I, Brodehl A, Dieding M, Walhorn V, Anselmetti D, Gerdes D, Bohms B, Schulz U, Zu Knyphausen E, Vorgerd M, Gummert J, Milting H. De novo desmin-mutation N116S is associated with arrhythmic right ventricular cardiomyopathy. *Hum Mol Genet.* 2010;19:4595-607.
53. Mogensen J, Kubo T, Duque M, Uribe W, Shaw A, Murphy R, Gimeno JR, Elliott P, McKenna WJ. Idiopathic restrictive cardiomyopathy is part of the clinical expression of cardiac troponin I mutations. *J Clin Invest.* 2003;111:209-16.
54. Kaski JP, Syrris P, Burch M, Tome-Esteban MT, Fenton M, Christiansen M, Andersen PS, Sebire N, Ashworth M, Deanfield JE, McKenna WJ, Elliott PM. Idiopathic restrictive cardiomyopathy in children is caused by mutations in cardiac sarcomere protein genes. *Heart.* 2008;94:1478-84.
55. Van der Zwaag PA, van Tintelen JP, Gerbens F, Jongbloed JD, Boven LG, van der Smagt JJ, van der Roest WP, van Langen IM, Bikker H, Hauer RN, van den Berg MP, Hofstra RM, te Meerman GJ. Haplotype sharing test maps genes for familial cardiomyopathies. *Clin Genet.* 2011;79:459-67.
56. Sinke RJ, Almomani R, Posafalvi A, van Spaendonck-Zwarts KY, van den Berg MP, Sikkema-Raddatz B, van Tintelen JP, Wang J, Jongbloed JD. Whole-exome sequencing identifies a novel nonsense mutation in the *TTN* gene in a large Dutch family with DCM. *Eur J Hum Genet.* 2012;20 supplement 1:302 (Abstract).
57. Ohlsson M, Hedberg C, Bradvik B, Lindberg C, Tajsharghi H, Danielsson O, Melberg A, Udd B, Martinsson T, Oldfors A. Hereditary myopathy with early respiratory failure associated with a mutation in A-band titin. *Brain.* 2012;135:1682-94.
58. Krawitz PM, Schweiger MR, Rodelsperger C, Marcelis C, Kolsch U, Meisel C, Stephani F, Kinoshita T, Murakami Y, Bauer S, Isau M, Fischer A, Dahl A, Kerick M, Hecht J, Kohler S, Jager M, Grunhagen J, de Condor BJ, Doelken S, Brunner HG, Meinecke P, Passarge E, Thompson MD, Cole DE, Horn D, Roscioli T, Mundlos S, Robinson PN. Identity-by-descent filtering of exome sequence data identifies PIGV mutations in hyperphosphatasia mental retardation syndrome. *Nat Genet.* 2010;42:827-9.
59. Majewski J, Schwartzentruber J, Lalonde E, Montpetit A, Jabado N. What can exome sequencing do for you? *J Med Genet.* 2011;48:580-9.
60. Clark MJ, Chen R, Lam HY, Karczewski KJ, Chen R, Euskirchen G, Butte AJ, Snyder M. Performance comparison of exome DNA sequencing technologies. *Nat Biotechnol.* 2011;29:908-14.
61. Cox MG, van der Zwaag PA, van der Werf C, van der Smagt JJ, Noorman M, Bhuiyan ZA, Wiesfeld AC, Volders PG, van Langen IM, Atsma DE, Dooijes D, van den Wijngaard A, Houweling AC, Jongbloed JD, Jordaens L, Cramer MJ, Doevendans PA, de Bakker JM, Wilde AA, van Tintelen JP, Hauer RN. Arrhythmogenic right ventricular dysplasia/cardiomyopathy: pathogenic desmosome mutations in index-patients predict outcome of family screening: Dutch arrhythmogenic right ventricular dysplasia/cardiomyopathy genotype-phenotype follow-up study. *Circulation.* 2011;123:2690-700.
62. Egger G, Liang G, Aparicio A, Jones PA. Epigenetics in human disease and prospects for epigenetic therapy. *Nature.* 2004;429:457-63.
63. Van Rijsingen IA, Arbustini E, Elliott PM, Mogensen J, Hermans-van Ast JF, van der Kooij AJ, van Tintelen JP, van den Berg MP, Pilotto A, Pasotti M, Jenkins S, Rowland C, Aslam U, Wilde AA, Perrot A, Pankuweit S, Zwinderman AH, Charron P, Pinto YM. Risk factors for malignant ventricular arrhythmias in lamin a/c mutation carriers a European cohort study. *J Am Coll Cardiol.* 2012;59:493-500.
64. Amin AS, Giudicessi JR, Tijssen AJ, Spanjaart AM, Reckman YJ, Klemens CA, Tanck MW, Kapplinger JD, Hofman N, Sinner MF, Muller M, Wijnen WJ, Tan HL, Bezzina CR, Creemers EE, Wilde AA, Ackerman MJ, Pinto YM. Variants in the 3' untranslated region of the *KCNQ1*-encoded Kv7.1 potas-

- sium channel modify disease severity in patients with type 1 long QT syndrome in an allele-specific manner. *Eur Heart J*. 2012;33:714-23.
65. Saenen JB and Vrints CJ. Molecular aspects of the congenital and acquired Long QT Syndrome: clinical implications. *J Mol Cell Cardiol*. 2008;44:633-46.
 66. Epstein RS, Moyer TP, Aubert RE, O Kane DJ, Xia F, Verbrugge RR, Gage BF, Teagarden JR. Warfarin genotyping reduces hospitalization rates results from the MM-WES (Medco-Mayo Warfarin Effectiveness study). *J Am Coll Cardiol*. 2010;55:2804-12.
 67. Salari K, Watkins H, Ashley EA. Personalized medicine: hope or hype? *Eur Heart J*. 2012;.
 68. Verschuren JJ, Trompet S, Wessels JA, Guchelaar HJ, de Maat MP, Simoons ML, Jukema JW. A systematic review on pharmacogenetics in cardiovascular disease: is it ready for clinical application? *Eur Heart J*. 2012;33:165-75.
 69. Ashley EA, Butte AJ, Wheeler MT, Chen R, Klein TE, Dewey FE, Dudley JT, Ormond KE, Pavlovic A, Morgan AA, Pushkarev D, Neff NF, Hudgins L, Gong L, Hodges LM, Berlin DS, Thorn CF, Sangkuhl K, Hebert JM, Woon M, Sagreiya H, Whaley R, Knowles JW, Chou MF, Thakuria JV, Rosenbaum AM, Zaranek AW, Church GM, Greely HT, Quake SR, Altman RB. Clinical assessment incorporating a personal genome. *Lancet*. 2010;375:1525-35.
 70. Pyeritz RE. The coming explosion in genetic testing--is there a duty to recontact? *N Engl J Med*. 2011;365:1367-9.
 71. Van Hoyweghen I and Horstman K. European practices of genetic information and insurance: lessons for the Genetic Information Nondiscrimination Act. *JAMA*. 2008;300:326-7.
 72. Christiaans I, Kok TM, van Langen IM, Birnie E, Bonsel GJ, Wilde AA, Smets EM. Obtaining insurance after DNA diagnostics: a survey among hypertrophic cardiomyopathy mutation carriers. *Eur J Hum Genet*. 2010;18:251-3.

List of abbreviations

List of authors and affiliations

List of publications

Nederlandse samenvatting

Curriculum vitae

Dankwoord

LIST OF ABBREVIATIONS

ACM	arrhythmogenic cardiomyopathy
AD	autosomal dominant
AF	atrial fibrillation
AHA	American Heart Association
ARVD/C	arrhythmogenic right ventricular dysplasia/cardiomyopathy
AVNRT	AV-nodal re-entry tachycardia
CAG	coronary angiogram
cM	centiMorgan
CPVT	catecholaminergic polymorphic ventricular tachycardia
Cx43	connexin 43
DCM	dilated cardiomyopathy
DES	desmin
DSC2	desmocollin 2
DSG2	desmoglein 2
DSP	desmoplakin
ECG	electrocardiogram
EPS	electrophysiology study
ESC	European Society of Cardiology
HCM	hypertrophic cardiomyopathy
HF	heart failure
HST	haplotype sharing test
HTx	heart transplantation
IBD	identical-by-descent
IBS	identical-by-state
ICD	implantable cardioverter defibrillator
JUP	plakoglobin
LBBB	left bundle branch block
LD	linkage disequilibrium
LDAC	left-dominant arrhythmogenic cardiomyopathy
LMNA	lamin A/C
LV	left ventricle/ventricular
LVEDD	left ventricular end-diastolic diameter
LVEF	left ventricular ejection fraction
Mb	megabase
MLPA	multiplex ligation-dependent probe amplification
MRI	magnetic resonance imaging
MYH7	beta myosin heavy chain

NCCM	non-compaction cardiomyopathy
NMD	nonsense mediated decay
nsVT	non-sustained ventricular tachycardia
NYHA	New York Heart Association
OHCA	out of hospital cardiac arrest
PHORECAST	PHOspholamban RElated CArdiomyopathy STudy
PKP2	plakophilin 2
PLN	phospholamban
PolyPhen	Polymorphism Phenotyping
PVC	premature ventricular complex
RBBB	right bundle branch block
RCM	restrictive cardiomyopathy
RT-PCR	reverse-transcription polymerase chain reaction
RV	right ventricle/ventricular
RVEF	right ventricular ejection fraction
SA-ECG	signal-averaged ECG
SCD	sudden cardiac death
SERCA2a	sarcoplasmic reticulum Ca ²⁺ -ATPase
SIFT	Sorting Intolerant From Tolerant
SNP	single nucleotide polymorphism
sVT	sustained ventricular tachycardia
TAD	terminal activation duration
TFC	task force criteria
TMEM43	transmembrane protein 43
TTN	titin
UTR	untranslated region
UV	unclassified variant
VES	ventricular extrasystole
VF	ventricular fibrillation
VT	ventricular tachycardia

LIST OF AUTHORS AND AFFILIATIONS

Angeliki Asimaki, Department of Pathology, Beth Israel Deaconess Medical Center and Harvard Medical School, Boston, United States

Douwe E. Atsma, Department of Cardiology, Leiden University Medical Center, Leiden, the Netherlands

Jacques M.T. de Bakker, Department of Medical Physiology, University Medical Center Utrecht, Utrecht and Interuniversity Cardiology Institute of the Netherlands, Utrecht, the Netherlands

Maarten P. van den Berg, Department of Cardiology, University Medical Center Groningen, University of Groningen, Groningen and Interuniversity Cardiology Institute of the Netherlands, Utrecht, the Netherlands

Zahir A. Bhuiyan, Department of Cardiology, Heart Failure Research Center, Academic Medical Center, Amsterdam, the Netherlands

Hennie Bikker, Department of Clinical Genetics, Academic Medical Center, Amsterdam, the Netherlands

Rudolf A. de Boer, Department of Cardiology, University Medical Center Groningen, University of Groningen, Groningen, the Netherlands

Ludolf G. Boven, Department of Genetics, University Medical Center Groningen, University of Groningen, Groningen, the Netherlands

Hugh Calkins, Department of Cardiology, Johns Hopkins University School of Medicine, Baltimore, United States

Imke Christiaans, Department of Clinical Genetics, Academic Medical Center, Amsterdam, the Netherlands

Moniek G.P.J. Cox, Department of Cardiology, University Medical Center Utrecht, Utrecht and Interuniversity Cardiology Institute of the Netherlands, Utrecht, the Netherlands

Maarten J. Cramer, Department of Cardiology, University Medical Center Utrecht, Utrecht, the Netherlands

Pieter A. Doevendans, Department of Cardiology, University Medical Center Utrecht, Utrecht and Interuniversity Cardiology Institute of the Netherlands, Utrecht, the Netherlands

Dennis Dooijes, Department of Medical Genetics, University Medical Center Utrecht, Utrecht, the Netherlands

Isabelle C. van Gelder, Department of Cardiology, University Medical Center Groningen, University of Groningen, Groningen, the Netherlands

Frans Gerbens, Department of Genetics, University Medical Center Groningen, University of Groningen, Groningen, the Netherlands

Judith A. Groeneweg, Department of Cardiology, University Medical Center Utrecht, Utrecht, the Netherlands

Pim van der Harst, Department of Cardiology, University Medical Center Groningen, University of Groningen, Groningen and Department of Genetics, University Medical Center Groningen, University of Groningen, Groningen, the Netherlands

Richard N.W. Hauer, Department of Cardiology, University Medical Center Utrecht, Utrecht and Interuniversity Cardiology Institute of the Netherlands, Utrecht, the Netherlands

Jeroen F. van der Heijden, Department of Cardiology, University Medical Center Utrecht, Utrecht, the Netherlands

F.A.M. Hennekam, Department of Medical Genetics, University Medical Center Utrecht, Utrecht, the Netherlands

Robert M.W. Hofstra, Department of Genetics, University Medical Center Groningen, University of Groningen, Groningen and Department of Clinical Genetics, Erasmus Medical Center, Rotterdam, the Netherlands

Arjan C. Houweling, Department of Clinical Genetics, VU University Medical Center, Amsterdam, the Netherlands

Jan D.H. Jongbloed, Department of Genetics, University Medical Center Groningen, University of Groningen, Groningen, the Netherlands

Roselie Jongbloed, Department of Clinical Genetics, Maastricht University Medical Center, Maastricht, the Netherlands

Luc Jordaens, Department of Cardiology, Leiden University Medical Center, Leiden, the Netherlands

Daniel P. Judge, Department of Cardiology, Johns Hopkins University School of Medicine, Baltimore, United States

Irene M. van Langen, Department of Genetics, University Medical Center Groningen, University of Groningen, Groningen, the Netherlands

Ronald H. Lekanne dit Deprez, Department of Clinical Genetics, Academic Medical Center, Amsterdam, the Netherlands

Laura. T. van Lochem, Department of Clinical Genetics, Academic Medical Center, Amsterdam, the Netherlands

William J. McKenna, Institute of Cardiovascular Science, University College London and The Heart Hospital, London, United Kingdom

Gerard J. te Meerman, Department of Genetics, University Medical Center Groningen, University of Groningen, Groningen, the Netherlands

Eline A. Nannenberg, Department of Clinical Genetics, Academic Medical Center, Amsterdam, the Netherlands

240

Maartje Noorman, Department of Medical Physiology, University Medical Center Utrecht, Utrecht and Interuniversity Cardiology Institute of the Netherlands, Utrecht, the Netherlands

Jan G. Post, Department of Medical Genetics, University Medical Center Utrecht, Utrecht, the Netherlands

Ingrid A.W. van Rijsingen, Department of Cardiology, Heart Failure Research Center, Academic Medical Center, Amsterdam, the Netherlands

Wilma P. van der Roest, Department of Genetics, University Medical Center Groningen, University of Groningen, Groningen, the Netherlands

Renée de Ruiter, Department of Cardiology, University Medical Center Groningen, University of Groningen, Groningen, the Netherlands

Jeffrey E. Saffitz, Department of Pathology, Beth Israel Deaconess Medical Center and Harvard Medical School, Boston, United States

Jasper J. van der Smagt, Department of Medical Genetics, University Medical Center Utrecht, Utrecht, the Netherlands

Karin Y. van Spaendonck-Zwarts, Department of Genetics, University Medical Center Groningen, University of Groningen, Groningen and Department of Clinical Genetics, Academic Medical Center, Amsterdam, the Netherlands

Albert J.H. Suurmeijer, Department of Pathology, University Medical Center Groningen, University of Groningen, Groningen, the Netherlands

J. Peter van Tintelen, Department of Genetics, University Medical Center Groningen, University of Groningen, Groningen and Durrer Cardiogenetic Research Center, Utrecht, the Netherlands

Amber Ummels, Department of Medical Genetics, University Medical Center Utrecht, Utrecht, the Netherlands

Toon A.B. van Veen, Department of Medical Physiology, University Medical Center Utrecht, the Netherlands

Dirk J. van Veldhuisen, Department of Cardiology, University Medical Center Groningen, University of Groningen, Groningen, the Netherlands

Paul G.A. Volders, Department of Cardiology, Maastricht University Medical Center, Maastricht, the Netherlands

Christian van der Werf, Department of Cardiology, Heart Failure Research Center, Academic Medical Center, Amsterdam, the Netherlands

Ans C.P. Wiesfeld, Department of Cardiology, University Medical Center Groningen, University of Groningen, Groningen, the Netherlands

Arthur van den Wijngaard, Department of Clinical Genetics, Maastricht University Medical Center, Maastricht, the Netherlands

Arthur A.M. Wilde, Department of Cardiology, Heart Failure Research Center, Academic Medical Center, Amsterdam and Interuniversity Cardiology Institute of the Netherlands, Utrecht, the Netherlands

Paul A. van der Zwaag, Department of Genetics, University Medical Center Groningen, University of Groningen, Groningen, the Netherlands

LIST OF PUBLICATIONS

Groeneweg JA,* **van der Zwaag PA,*** Jongbloed JD, Cox MG, de Boer RA, van der Heijden JF, van Veen TA, McKenna WJ, van Tintelen JP, Dooijes D, Hauer RN.

Left-dominant arrhythmogenic cardiomyopathy in a large family: associated desmosomal or non-desmosomal genotype? *Submitted.*

Van der Smagt JJ,* **van der Zwaag PA,*** van Tintelen JP, Cox MG, Wilde AA, van Langen IM, Ummels A, Hennekam FA, Dooijes D, Gerbens F, Bikker H, Hauer RN, Doevendans PA.

Clinical and genetic characterisation of patients with arrhythmogenic right ventricular dysplasia/cardiomyopathy caused by a plakophilin 2 splice mutation. *Cardiology.* In press.

Van der Zwaag PA, van Rijsingen IA, Asimaki A, Jongbloed JD, van Veldhuisen DJ, Wiesfeld AC, Cox MG, van Lochem LT, de Boer RA, Hofstra RM, Christiaans I, van Spaendonck-Zwarts KY, Lekanne dit Deprez RH, Judge DP, Calkins H, Suurmeijer AJ, Hauer RN, Saffitz JE, Wilde AA, van den Berg MP, van Tintelen JP.

Phospholamban R14del mutation in patients diagnosed with dilated cardiomyopathy or arrhythmogenic right ventricular cardiomyopathy: evidence supporting the concept of arrhythmogenic cardiomyopathy. *Eur J Heart Fail.* In press.

Van der Zwaag PA, van Tintelen JP.

Counsel the genotype, treat the phenotype. *Eur J Heart Fail.* 2011;13:1159-60.

Cox MG,* **van der Zwaag PA,*** van der Werf C,* van der Smagt JJ, Noorman M, Bhuiyan ZA, Wiesfeld AC, Volders PG, van Langen IM, Atsma DE, Dooijes D, van den Wijngaard A, Houweling AC, Jongbloed JD, Jordaens L, Cramer MJ, Doevendans PA, de Bakker JM, Wilde AA, van Tintelen JP, Hauer RN.

Arrhythmogenic right ventricular dysplasia/cardiomyopathy: pathogenic desmosome mutations in index-patients predict outcome of family screening: Dutch arrhythmogenic right ventricular dysplasia/cardiomyopathy genotype-phenotype follow-up study. *Circulation.* 2011;123:2690-700.

Van der Zwaag PA, van Tintelen JP, Gerbens F, Jongbloed JD, Boven LG, van der Smagt JJ, van der Roest WP, van Langen IM, Bikker H, Hauer RN, van den Berg MP, Hofstra RM, te Meerman GJ.

Haplotype sharing test maps genes for familial cardiomyopathies. *Clin Genet.* 2011;79:459-67.

Van der Zwaag PA, Cox MG, van der Werf C, Wiesfeld AC, Jongbloed JD, Dooijes D, Bikker H, Jongbloed R, Suurmeijer AJ, van den Berg MP, Hofstra RM, Hauer RN, Wilde AA, van Tintelen JP.

Recurrent and founder mutations in the Netherlands: Plakophilin-2 p.Arg79X mutation causing arrhythmogenic right ventricular cardiomyopathy/dysplasia. *Neth Heart J*. 2010;18:583-91.

Hobbs RP, Han SY, **van der Zwaag PA**, Bolling MC, Jongbloed JD, Jonkman MF, Getsios S, Paller AS, Green KJ.

Insights from a desmoplakin mutation identified in lethal acantholytic epidermolysis bullosa. *J Invest Dermatol*. 2010;130:2680-3

Van der Zwaag PA, Dijkhuizen T, Gerssen-Schoorl KB, Colijn AW, Broens PM, Flapper BC, van Ravenswaaij-Arts CM.

An interstitial duplication of chromosome 13q31.3q32.1 further delineates the critical region for postaxial polydactyly type A2. *Eur J Med Genet*. 2010;53:45-9.

Van der Zwaag PA, Jongbloed JD, van den Berg MP, van der Smagt JJ, Jongbloed R, Bikker H, Hofstra RM, van Tintelen JP.

A genetic variants database for arrhythmogenic right ventricular dysplasia/cardiomyopathy. *Hum Mutat*. 2009;30:1278-83.

Van der Zwaag PA, Jongbloed JD, van den Berg MP, Jonkman MF, van Tintelen JP.

Letter regarding the article: "R298Q mutation of p63 gene in autosomal dominant ectodermal dysplasia associated with arrhythmogenic right ventricular cardiomyopathy" by Valenzise et al. *Eur J Med Genet*. 2009;52:277.

* These authors contributed equally to this work

NEDERLANDSE SAMENVATTING

Genetische en klinische karakterisering van aritmogene cardiomyopathie

Aritmogene cardiomyopathie is een progressieve, erfelijke hartspierziekte die kan leiden tot ventriculaire ritmestoornissen en plotse hartdood, maar ook tot eindstadium hartfalen.¹ Aanvankelijk dacht men dat de ziekte het gevolg was van “rechter ventrikel dysplasie”, een abnormale ontwikkeling van de rechter ventrikel.² De eerste publicaties beschreven de betrokkenheid van de rechter ventrikel en dit werd beschouwd als het klassieke type van deze ziekte. Recenter zijn echter ook publicaties verschenen waarin betrokkenheid van beide ventrikels of vooral de linker ventrikel is beschreven.³⁻⁵ De termen “rechter ventrikel” en “dysplasie” lijken dus achterhaald en de naam “aritmogene cardiomyopathie” (ACM) heeft nu de voorkeur voor deze vorm van een erfelijke hartspierziekte. ACM openbaart zich meestal tijdens de adolescentie of bij jonge volwassenen en een diagnose bij kinderen onder de 10 jaar is zeldzaam.^{6,7} De prevalentie in de algemene bevolking wordt geschat op 1:1.000 – 1:5.000.² Een erfelijke oorzaak, meestal een mutatie in een gen coderend voor een eiwit dat onderdeel uitmaakt van het desmosoom, kan worden aangetoond in ca. 50% van de gevallen.

Het eerste deel van dit proefschrift bestaat uit genetische studies en beschrijvingen van het klinisch beeld van ACM. Hoofdstuk 2 beschrijft de toepassing van de haplo-type-sharing test om ziekteverwekkende mutaties op te sporen. Veel families met een erfelijke hartspierziekte zijn te klein voor klassieke linkage analyse, een vorm van genetisch koppelingsonderzoek. Daarom hebben we de haplotype-sharing test ontwikkeld om in families te zoeken naar grote gedeelde stukken van het genoom, die het meest waarschijnlijk de ziekteverwekkende mutatie bevatten. Aangedane familieleden hebben een haplotype (een combinatie van allelen op een chromosoom) met deze mutatie geërfd van een gezamenlijke voorouder. Deze voorouder kan vele generaties terug geleefd hebben, met als gevolg dat aangedane personen niet altijd weten dat zij verwant zijn aan elkaar. Het DNA van bewezen aangedane familieleden is gegenotypeerd met behulp van single nucleotide polymorphism (SNP) arrays en de resultaten zijn gecombineerd om te zoeken naar gedeelde haplotypes. Zowel een familie met ACM als een familie met dilaterende cardiomyopathie (DCM) is geanalyseerd met de haplotype-sharing test. In beide stambomen hebben we gezocht naar gemuteerde genen in het grootste gedeelde haplotype en hebben we mutaties kunnen aantonen in respectievelijk het *PKP2* gen en het *MYH7* gen. Bovendien hebben we uitgerekend dat een stamboom met minimaal zeven meioses een goede kans biedt om een mutatie te vinden in het grootste gedeelde

haplotype. Deze 'proof-of-principle' studie toonde aan dat de haplotype-sharing test kan bijdragen aan het identificeren van de ziekteverwekkende mutatie in families met laag penetrante Mendeliaanse aandoeningen, waar standaard methoden tekort schieten vanwege te kleine stambomen. De haplotype-sharing test kan ook worden toegepast als een gedeelde voorouder niet bekend is, maar wel wordt verondersteld, bijvoorbeeld als patiënten uit dezelfde regio afkomstig zijn.

Hoofdstuk 3 beschrijft moleculaire studies naar de *PKP2* mutatie die is gevonden in hoofdstuk 2 en de klinische gegevens van de dragers van deze mutatie. De aangetoonde *PKP2* splice site mutatie (c.2489+4A>C) leidt naar verwachting tot de expressie van een *PKP2* eiwit met een gestoorde functie en niet tot een eiwit met een verminderde functie. Het klinisch beeld van mutatiedragers varieerde van ernstig aangedaan tot non-penetrantie (de ziekte komt niet tot uiting) op hoge leeftijd. Dit onderzoek suggereert dat alleen een *PKP2* mutatie onvoldoende is om ACM te veroorzaken en dat andere genetische en/of omgevingsfactoren ook bijdragen aan het ontwikkelen van deze ziekte. Deze studie is een goed voorbeeld van de variabele expressie en de onvolledige penetrantie die beide kenmerkend zijn voor ACM.

Een founder mutatie, eenzelfde mutatie die afkomstig is van een verre voorouder, is regelmatig aangetoond bij Nederlandse patiënten met een erfelijke hartziekte. Hoofdstuk 4 beschrijft de grootste serie ACM patiënten met dezelfde founder mutatie in het *PKP2* gen (p.Arg79X). Twaalf indexpatiënten en 41 familieleden zijn geëvalueerd en haplotype analyse toonde een gedeeld haplotype bij alle mutatiedragers, suggestief voor een founder mutatie. In 50% van deze families was plotse hartdood onder de leeftijd van 40 jaar opgetreden, terwijl slechts 60% van de mutatiedragers symptomatisch was op de leeftijd van 60 jaar. Ook deze studie is dus illustratief voor de variabele expressie en de verminderde penetrantie van ACM.

Of een aangetoonde mutatie daadwerkelijk ziekteverwekkend is, is niet altijd duidelijk. In Hoofdstuk 5 is de database met genetische variaties bij ACM (www.arvcdatabase.info) in detail beschreven. In deze vrij toegankelijke, online database zijn alle genetische varianten in met ACM geassocieerde genen opgenomen. Deze database is een digitale opslagplaats voor moleculaire data en alle publicaties met aanvullende klinische en genetische gegevens. In juni 2012 bevatte de database 856 genetische varianten en gegevens van 111 publicaties. De database heeft zijn waarde bewezen: sinds de lancering in oktober 2008 is de database ruim 125.000 keer bezocht door 11.500 terugkerende bezoekers uit meer dan 50 landen.

Hoofdstuk 6 beschrijft een groot cohort van Nederlandse ACM families, verzameld in alle universitaire medische centra in Nederland. Om meer inzicht te krijgen in het natuurlijke beloop van de ziekte en de consequenties van een aangetoonde mutatie, werden alle vijf desmosomale genen geanalyseerd in 149 indexpatiënten. In totaal werden 302 familieleden onderzocht op dragerschap van de in hun familie

aangetoonde mutatie. Ziekteverwekkende mutaties werden aangetoond in 58% van de indexpatiënten. Dit waren met name *PKP2* mutaties, inclusief drie patiënten met grote deleties in *PKP2*. In 90% van de families met meer dan één aangedaan familielid werd een *PKP2* mutatie vastgesteld. Familieleden met een ziekteverwekkende mutatie hebben een zesmaal verhoogd risico op het ontwikkelen van ACM ten opzichte van familieleden uit een familie waar geen mutatie is vastgesteld. Dit rechtvaardigt frequente controles om beginnende symptomen op tijd op te sporen.

Het tweede deel van dit proefschrift betreft de identificatie van een founder mutatie in het phospholamban gen (PLN p.Arg14del) in een substantieel aantal Nederlandse patiënten met ACM of DCM. De klinische kenmerken van indexpatiënten met deze mutatie zijn beschreven in Hoofdstuk 7. Een cohort van 97 ACM indexpatiënten en 257 DCM indexpatiënten werd gescreend op *PLN* mutaties. De p.Arg14del mutatie is aangetoond in 12% van de ACM patiënten en in 15% van de DCM patiënten. In Nederland is dit het grootste aantal patiënten met een hartspierziekte dat door dezelfde mutatie wordt veroorzaakt. Patiënten met de *PLN* p.Arg14del mutatie presenteerden zich in 46% van de gevallen met een laag voltage ECG en toonden een aritmogeen fenotype: een hoge mate van ontladingen van een implanteerbare cardioverter-defibrillator (ICD), harttransplantaties en een positieve familieanamnese voor plotse hartdood. De gemiddelde leeftijd van de 26 familieleden die overleden aan een plotse hartdood was 37,7 jaar. Immunohistochemische analyse van hartbiopten, beschouwd als een diagnostische test voor ACM, toonde afwezigheid of verminderde expressie van plakoglobine in de intercalaire schijven (die hartspiercellen aan elkaar koppelen), in vijf van zeven (71%) ACM samples en in slechts één van negen (11%) DCM samples. Dit hoofdstuk illustreert hoe een mutatie kan leiden tot verschillende klinische diagnoses, in dit geval ACM en DCM, en dat er een overlap is tussen deze twee hartspierziekten.

De geografische spreiding van dragers van de *PLN* p.Arg14del founder mutatie is beschreven in Hoofdstuk 8. Haplotype analyse onthulde een gemeenschappelijke voorouder die 575 tot 825 jaar geleden leefde. Meer dan 450 mutatiedragers zijn inmiddels geïdentificeerd en de meerderheid leeft in het noorden van Nederland, inclusief Noord-Holland. Een analyse van de geboorteplaatsen van de grootouders van de mutatiedragers toonde aan dat de oorsprong van de mutatie waarschijnlijk in het oosten van de provincie Friesland ligt. Screening van een groot bevolkingscohort (PREVEND) identificeerde zes *PLN* p.Arg14del mutatiedragers in een groep van 8.267 personen (0.07%). Deze resultaten toonden aan dat de *PLN* p.Arg14del mutatie frequent voorkomt in de algemene bevolking van de noordelijke delen van Nederland en dat deze mutatie ook in andere delen van Nederland een van de meest voorkomende oorzaken van een erfelijke hartspierziekte is.

In hoofdstuk 9 is een grote familie met ACM onderzocht. Een eerder aangetoonde mutatie in het PKP2 gen (p.Ser140Phe) bleek niet bij alle aangedane personen in deze familie aanwezig te zijn. Nadat de familieleden uitgebreid in kaart waren gebracht, konden we geen bewijs vinden dat de PKP2 variant daadwerkelijk bijdraagt aan de ziekte. De PLN p.Arg14del mutatie was echter wel aanwezig bij alle familieleden met ACM en bij allen was de linker ventrikel ook aangedaan. Van de negen PLN p.Arg14del mutatiedragers hadden vier een laag voltage ECG.

Bij patiënten met een erfelijke hartspierziekte kan de identificatie van een ziekteverwekkende mutatie de diagnose bevestigen en vervolgens kunnen (asymptomatische) familieleden worden opgespoord door familieonderzoek. Klinisch genetici vormen het hart van multidisciplinaire teams, bestaande uit genetisch consulenten, moleculair genetici, cardiologen, pathologen, neurologen en onderzoekers, die gezamenlijk zorg dragen voor patiënten met een hartspierziekte en hun familieleden. In de 'General discussion' wordt ingegaan op de recente ontwikkelingen in het genetisch onderzoek. Deze zullen leiden tot het opsporen van vele nieuwe mutaties en dat maakt het counselen van deze families steeds ingewikkelder. Voor klinisch genetici en hun collega's belooft het een uitdagende toekomst te worden. Patiënten en hun families zullen baat hebben bij de vooruitgang die zal worden geboekt door deze uitdagingen aan te gaan.

REFERENTIES

1. Basso C, Corrado D, Marcus FI, Nava A, Thiene G. Arrhythmogenic right ventricular cardiomyopathy. *Lancet*. 2009;373:1289-300.
2. Marcus FI, Fontaine GH, Guiraudon G, Frank R, Laurenceau JL, Malergue C, Grosgeat Y. Right ventricular dysplasia: a report of 24 adult cases. *Circulation*. 1982;65:384-98.
3. Corrado D, Basso C, Thiene G, McKenna WJ, Davies MJ, Fontaliran F, Nava A, Silvestri F, Blomstrom-Lundqvist C, Wlodarska EK, Fontaine G, Camerini F. Spectrum of clinicopathologic manifestations of arrhythmogenic right ventricular cardiomyopathy/dysplasia: a multicenter study. *J Am Coll Cardiol*. 1997;30:1512-20.
4. Sen-Chowdhry S, Syrris P, Ward D, Asimaki A, Sevdalis E, McKenna WJ. Clinical and genetic characterization of families with arrhythmogenic right ventricular dysplasia/cardiomyopathy provides novel insights into patterns of disease expression. *Circulation*. 2007;115:1710-20.
5. Sen-Chowdhry S, Syrris P, Prasad SK, Hughes SE, Merrifield R, Ward D, Pennell DJ, McKenna WJ. Left-dominant arrhythmogenic cardiomyopathy an under-recognized clinical entity. *J Am Coll Cardiol*. 2008;52:2175-87.
6. Dalal D, Nasir K, Bomma C, Prakasa K, Tandri H, Piccini J, Roguin A, Tichnell C, James C, Russell SD, Judge DP, Abraham T, Spevak PJ, Bluemke DA, Calkins H. Arrhythmogenic right ventricular dysplasia: a United States experience. *Circulation*. 2005;112:3823-32.
7. Bauce B, Rampazzo A, Basso C, Mazzotti E, Rigato I, Steriotis A, Beggagna G, Lorenzon A, De Bortoli M, Pilichou K, Marra MP, Corbetti F, Daliento L, Iliceto S, Corrado D, Thiene G, Nava A. Clinical phenotype and diagnosis of arrhythmogenic right ventricular cardiomyopathy in pediatric patients carrying desmosomal gene mutations. *Heart Rhythm*. 2011;8:1686-95.

CURRICULUM VITAE

Paul Arjen van der Zwaag werd op 28 januari 1983 geboren te Groningen. In 2001 behaalde hij zijn diploma aan het Willem Lodewijk Gymnasium te Groningen en vervolgens studeerde hij een jaar aan het Otterbein College in Westerville, Ohio in de Verenigde Staten. In 2002 begon hij met de studie Geneeskunde aan de Rijksuniversiteit Groningen. Ter afronding van zijn doctoraal verrichte hij zijn wetenschappelijke stage aan de afdeling Genetica van het Universitair Medisch Centrum Groningen onder leiding van dr.ir. G.J. te Meerman. Hij deed zijn coschappen in het Martini Ziekenhuis te Groningen en het Pius Hospital in Oldenburg, Duitsland. Na zijn keuzecoschap bij de afdeling Klinische Genetica van het Universitair Medisch Centrum Groningen behaalde hij in 2008 zijn artsensbul cum laude.

Aansluitend begon hij met zijn promotieonderzoek onder supervisie van prof. R.M.W. Hofstra, prof. M.P. van den Berg, dr. J.D.H. Jongbloed en dr. J.P. van Tintel. Dit promotieonderzoek, gefinancierd door de Nederlandse Hartstichting, werd verricht aan de afdeling Genetica, in nauwe samenwerking met de afdeling Cardiologie, beide in het Universitair Medisch Centrum Groningen, en heeft geleid tot dit proefschrift.

In 2012 startte hij met de opleiding tot klinisch geneticus aan de afdeling Klinische Genetica van het Universitair Medisch Centrum Groningen (opleider prof. I.M. van Langen).

Paul van der Zwaag is getrouwd met Ruth Dekker.

DANKWOORD

De afgelopen vier jaar zijn werkelijk omgevlogen. Met zeer veel plezier heb ik gewerkt aan mijn onderzoek met als resultaat dit proefschrift. Op deze plaats wil ik graag iedereen bedanken die hieraan mede heeft bijgedragen.

In de eerste plaats wil ik alle patiënten en families die hebben deelgenomen aan dit onderzoek heel hartelijk danken. Zonder hen was het schrijven van dit proefschrift absoluut onmogelijk geweest en ik ben er trots op dat de behaalde resultaten zullen bijdragen aan betere zorg voor patiënten met een erfelijke hartspierziekte.

Ik wil mijn promotoren en copromotoren heel hartelijk danken voor hun uitstekende maar bovenal zeer plezierige begeleiding:

Prof.dr. Hofstra, beste Robert. Jouw ontspannen manier van werken en de vrijheid die je mij gaf in dit onderzoek heb ik zeer gewaardeerd. Geleid door jouw enthousiasme heb ik daarnaast van harte deelgenomen aan de maatschappelijke en culturele activiteiten van de afdeling. De omslag van mijn proefschrift is daar een mooi resultaat van. Je vertrek naar Rotterdam betreur ik, maar is je van harte gegund; wie weet kruisen onze wegen in de toekomst opnieuw.

Prof.dr. van den Berg, beste Maarten. Jouw benoeming tot hoogleraar maakte de weg vrij om mijn promotor te worden en dat doet recht aan jouw bijdrage aan dit proefschrift. Ik heb veel van je opgestoken en bewaar goede herinneringen aan de vrijdagen waarop we samen manuscripten of echoverslagen doornamen. Ik kijk uit naar de toekomstige resultaten van ons onderzoek.

Dr. Jongbloed, beste Jan. Dank voor de begeleiding en het wegwijs maken in de wereld van de moleculaire genetica. Jouw nuchtere aanpak en humor maken je een fijne begeleider. Ik kijk met plezier terug op een zeer prettige samenwerking en op onze gezamenlijke congresbezoeken.

Dr. van Tintelen, beste Peter. Een van mijn eerste activiteiten als coassistent bij de Klinische Genetica was het helpen met rondbrengen van jouw proefschrift. Je hebt jouw enthousiasme voor de cardiogenetica op mij weten over te brengen en nu ligt mijn proefschrift hier. Ik kan altijd bij je aankloppen en jouw optimistische aard en kritische blik hebben absoluut bijgedragen aan de succesvolle afronding van dit traject.

De leden van de leescommissie wil ik bedanken voor hun beoordeling van dit proefschrift.

Prof. Knoers. Hartelijk dank voor het beschikbaar stellen van uw tijd en expertise om zitting te nemen in de leescommissie.

Prof. Saffitz. Thank you for participating in the reading committee. Your contribution to this thesis is very valuable and it has been a pleasure to collaborate.

Prof. Wilde. Het niveau van dit proefschrift is absoluut toegenomen door uw commentaren. Hartelijk dank voor het doornemen van de uiteindelijke versie van mijn proefschrift.

Frans Gerbens. Zonder jouw inzet was dit proefschrift er nooit geweest. Ik kijk met genoegen terug op onze samenwerking tijdens mijn doctoraalonderzoek en had graag samen verder onderzoek gedaan. Helaas kwam aan jouw bijdrage aan dit onderzoek veel te vroeg een einde.

Alle betrokkenen van het cardioresearch team wil ik danken voor hun hulp en suggesties. Ludolf, dank voor je geduld en inzet om mij wegwijs te maken op het lab; ik heb veel van je geleerd. Anna, ik bewonder je doorzettingsvermogen. Je verdient een dankbetuiging in het Nederlands, omdat je de taal al zo goed onder de knie hebt. Rowida, your contribution as a cardiogenetics post-doc is valuable to the entire team. Richard, de uiteindelijke overgang van het onderzoek naar de diagnostiek is bij jou en Jan in vertrouwde handen. Karin, dank voor je vele ideeën en de plezierige samenwerking. Het AMC mag zijn handen met jou dichtknijpen. Yvonne, je bent een plezierige en enthousiaste collega. Onze gedeelde interesse voor de cardiogenetica is een mooie basis voor de toekomst in het onderzoek.

Marthine, heel erg bedankt voor al jouw ondersteuning en de dozijnen aan dossiers die je voor me hebt opgevraagd. Jouw vrolijkheid en luidkeelse aankondigingen van mijn komst maakten het werk extra leuk.

Gerard, zes jaar geleden begon ik als vierdejaars student mijn doctoraalonderzoek onder jouw begeleiding. Hoewel je soms onnavolgbaar bent, heb ik erg veel van je opgestoken, ook over zaken die niets met genetica te maken (lijken te) hebben. Dank voor alle hulp en begeleiding.

Dear roommates: Agata, Alex, Asia, Barbara, Esther, Gosia, Isis, Javier, Jihane, and Mats. Thank you for the great international experience in my hometown. Agata, I enjoyed our discussions and I hope you will find your place in medical genetics. Asia, you are able to see things from a different perspective, a valuable quality, also outside science. Barbara, it was a pleasure to help you find your way in the Dutch bureaucracy since you are a joyful and fun colleague. Gosia, you were a pleasant roommate and I enjoyed your sarcasm. I am sure that a great scientific career lies ahead of you. Javier, I still owe you a visit to FC Groningen. Jihane, you are one of the friendliest colleagues I have worked with and I am impressed by your multilingualism. You will bring Lebanese genetics to a higher level. Mats, I really enjoyed our Monday morning conversations about sports, international politics, and sometimes even science.

To all other PhD students in the department: the diversity of background and research topics was very valuable and it has been a pleasure to work together and discuss matters over coffee or over a beer; Ana, Annemieke, Christine, Cleo, Dasha, Duco, Ettje, Gerben, Hans, Harm-Jan, Juha, Justyna, Karin, Maria, Marlies, Mitja, Noortje, Olga, Omid, Rodrigo, Rudolf, Suzanne, Tjakko and Yunia: thank you.

To all other colleagues within the department; Anna, Astrid, Bahram, Bart, Bea, Celine, Cleo, Dineke, Ellen, Elvira, Eva, Helga, Jan, Jantine, Jelkje, Jos, Karin, Klaas, Krista, Lude, Marcel, Mariska, Matthieu, Michiel, Monique, Morris, Paul, Pieter, Robert, Ron, Rutger, Soesma and Sonja: thank you for all your help and pleasant collaboration.

Alle klinisch genetici wil ik bedanken voor hun getoonde belangstelling tijdens mijn onderzoek. Conny, Corien, Erica, Irene, Irma, Joke, Katelijne, Mirjam, Patrick, Roel, Rolf en Ton, dank voor de plezierige wijze waarop ik aan mijn opleiding tot klinisch geneticus heb kunnen beginnen. Jan, de suggestie om gezien de bemoedigende resultaten al tijdens mijn promotie een sabbatical te nemen heb ik toch maar naast me neergelegd. Irene en Maran, hartelijk dank voor het vertrouwen om de start van mijn opleiding te mogen combineren met het afronden van dit proefschrift. Mieke, bedankt dat jij mijn mentor wilt zijn.

Veel van de arts-assistenten heb ik tijdens mijn onderzoek al leren kennen: Anne, Eelco, Ellen, Esther, Heleen, Jenneke, Jolien, Jorieke, Karin, Maaïke, Marleen, Marno, Nicole, Peter, Renée, Tanya en Yvonne. Hartelijk dank voor het warme welkom nu ik een van jullie ben.

Veel van de genetisch consulenten hebben in de spreekkamer een belangrijke bijdrage aan dit proefschrift geleverd: Agnes, Beike, Dorina, Gerdien, Hendrika, Johanna, Karin, Margot, Marijke, Natasja, Rein, Rina, Sandra en Wilma. Dank voor het counselen van de patiënten uit dit onderzoek en de getoonde interesse in mijn promotie.

Jackie, wat een luxe dat jij al mijn manuscripten hebt gereviseerd. Niet alleen heb ik hierdoor veel van je geleerd, maar de kwaliteit van dit proefschrift is ook absoluut toegenomen. Thank you very much.

Mentje, Ria, Joke, Hélène en Bote, hartelijk dank voor alle hulp bij het regelen van afspraken, versturen van faxen en allerlei andere praktische zaken. Jullie zijn de Groningerolie van deze afdeling. Hayo, Edwin, Marina, Wim en John, bedankt voor jullie hulp met de financiën en ICT.

Prof. Wijmenga, beste Cisca. Ik wil jou bedanken voor het scheppen van de voorwaarden waaronder de afdeling zo goed heeft kunnen functioneren en ik dit onderzoek met plezier heb kunnen uitvoeren.

Alle medeauteurs wil ik hartelijk danken voor hun suggesties, correcties en adviezen. Het was een plezier om met zoveel collega's uit verschillende centra en van verschillende afdelingen samen te werken.

Moniek, Ingrid, Judith en Christian, collega cardiogenetica-onderzoekers. Ik heb jullie leren kennen als zeer plezierige en betrouwbare collega's. De samenwerking was vlot en volgens mij goed voor alle partijen. Moniek, jouw proefschrift mocht er absoluut wezen en ik kijk uit naar die van de anderen.

Angeliki, thank you for contributing to this thesis. It was a pleasure to get to know you and I look forward to future collaborations and meetings.

Alle klinisch moleculair genetici wil ik hartelijk danken voor het delen van de vele onderzoeksresultaten voor de manuscripten en natuurlijk de database. In het bijzonder Hennie Bikker, Dennis Dooijes, Roselie Jongbloed, Ronald Lekanne dit Deprez en Arthur van den Wijngaard wil ik hier danken voor hun bijdrage aan dit proefschrift.

De betrokken klinisch genetici wil ik bedanken voor het counsellen van de patiënten en het verzamelen van de data, met name Imke Christiaans, Eline Nannenberg, Laura van Lochem, Arjan Houweling, Jasper van der Smagt en Jan Post. Jasper, hoofdstuk 3 is een beloning voor jouw doorzettingsvermogen.

Alle cardiologen die een rol hebben gespeeld bij het tot stand komen van dit proefschrift wil ik hartelijk danken voor het verwijzen van de patiënten en hun betrokkenheid. In het bijzonder Rudolf de Boer, Isabelle van Gelder, Dirk Jan van Veldhuisen en Ans Wiesfeld wil ik danken voor hun bijdrage. Rudolf, jouw humor en enthousiasme heb ik zeer gewaardeerd. Dirk Jan, ik heb geleerd dat het schrappen van grote stukken tekst makkelijker kan zijn dan het lijkt, waarvoor dank.

Prof. Suurmeijer. Hartelijk dank voor het beschikbaar stellen van de afbeeldingen van de biopten en het geduld om deze samen met mij te beoordelen.

Prof. Hauer. Uw enthousiasme voor dit onderwerp is van grote waarde geweest voor mij en dit proefschrift. U bent zeer hartelijk en staat altijd open voor discussie. Dank voor de zeer plezierige samenwerking.

Peter en Evert, mijn paranimfen. Heel erg bedankt voor jullie hulp met de laatste loodjes. Dankzij jullie kan ik met minder zorgen toewerken naar de grote dag en ik ben blij dat jullie dan naast mij zullen staan.

Dit promotieonderzoek heeft me veel nieuwe contacten en mooie reizen opgeleverd, maar belangrijker is dat mijn familie en vrienden er waren voor de nodige afleiding en relativering.

Arjan, Bart, Benjamin, Bert, Ernst, Evert, Frank, Geert, Gerrit Jan, Jaap B, Jaap U, Jan Willem B, Jan Willem V, Johan, Kai, Lars, Maarten, Mark L, Mark vd W, Martijn van N, Martijn vd P, Merijn, Micha, Pieter, Rieuwerd, Rogier, Sander en Stephan;

sommigen van jullie ken ik al van jongs af aan en anderen pas enkele jaren. Dankzij jullie kan ik schitteren op de trainingen, helaas komt dat er tijdens de wedstrijden maar weinig uit. Ook aan de vrijdagmiddagborrels, de vele fietstochten en de teamuitjes bewaar ik zeer goede herinneringen. Rieuwerd, heel erg bedankt voor het ontwerpen van de omslag van dit proefschrift.

Antonie, Jan-Arnout, Jisva en Frank J. We zien elkaar niet vaak, maar dat is geen belemmering voor een echte vriendschap. Ieder gaat zijn eigen weg, maar het contact blijft en daar ben ik oprecht blij om.

Lieve familie en schoonfamilie, bedankt voor jullie belangstelling en adviezen. Jaap, tijdens het koffie drinken in de Euroborg konden we snel even bijpraten over mijn onderzoek, over Ruth, over voetbal en over andere belangrijke zaken. Gelukkig waren er ook voldoende momenten die langer dan een kwartier duurden. Emmie en Luppo, bedankt voor jullie betrokkenheid. Het is heerlijk om bij jullie langs te gaan en verder niets te hoeven.

Lieve Esther, hoewel je nu je dromen achterna gaat in Amsterdam, twijfel ik er niet aan dat we je nog regelmatig over de vloer zullen krijgen. Dat moet je vooral blijven doen, je bent altijd welkom.

Lieve Nynke, mijn grote kleine zusje, na wat omzwervingen ben je in de journalistiek terecht gekomen en daar ben je helemaal op je plaats. Je culinaire inspanningen zijn aan mij altijd goed besteed. Ik vind het erg leuk om van je te horen hoe je aan je carrière werkt en ik ben trots op je.

Lieve pap en mam, jullie hebben ons altijd aangemoedigd om onze talenten te benutten en mede dankzij jullie steun ben ik zover gekomen. Ik vind het fijn om te zien dat jullie nog zoveel uit het leven halen, ook al kost dat soms meer moeite dan jullie zouden willen. Het optimisme en het doorzettingsvermogen dat daarmee gepaard gaat is een bron van inspiratie. Bedankt voor alles.

Allerliefste Ruth, het leven is met jou veel leuker. Het is heerlijk om samen te zijn; op de leukste plaatsen van de wereld, maar ook gewoon thuis. Jij hebt mij leren genieten van de kleine dingen en je betekent alles voor me. Ik kijk ontzettend uit naar wat de toekomst ons zal brengen.

Paul

