



Aalborg Universitet

AALBORG UNIVERSITY  
DENMARK

## Conservation compatible energy retrofit technologies

*Part III: Documentation and assessment of materials and solutions for wall insulation in historic buildings*

Pfluger, Rainer; Rieser, Alexander; Leonardi, Eleonora; Herrera-Avellanosa, Daniel; de Place Hansen, Ernst Jan; Curtis, Roger; Marincioni, Valentina; Petsou, Athina; Gianpiero, Evola; Polo Lopez, Christina S; Mauri, Sara; Hatt, Tobias; Leijonhufvud, Gustaf; Kuchar, Susanne; Sevela, Pavel; Borderon, Julien

DOI (link to publication from Publisher):  
[10.18777/ieashc-task59-2021-0006](https://doi.org/10.18777/ieashc-task59-2021-0006)

Creative Commons License  
Unspecified

Publication date:  
2021

Document Version  
Publisher's PDF, also known as Version of record

[Link to publication from Aalborg University](#)

*Citation for published version (APA):*

Pfluger, R. (Ed.), Rieser, A. (Ed.), Leonardi, E., Herrera-Avellanosa, D., de Place Hansen, E. J., Curtis, R., Marincioni, V., Petsou, A., Gianpiero, E., Polo Lopez, C. S., Mauri, S., Hatt, T., Leijonhufvud, G., Kuchar, S., Sevela, P., & Borderon, J. (2021). *Conservation compatible energy retrofit technologies: Part III: Documentation and assessment of materials and solutions for wall insulation in historic buildings*. International Energy Agency, IEA. <https://doi.org/10.18777/ieashc-task59-2021-0006>

### General rights

Copyright and moral rights for the publications made accessible in the public portal are retained by the authors and/or other copyright owners and it is a condition of accessing publications that users recognise and abide by the legal requirements associated with these rights.

- Users may download and print one copy of any publication from the public portal for the purpose of private study or research.
- You may not further distribute the material or use it for any profit-making activity or commercial gain
- You may freely distribute the URL identifying the publication in the public portal -

### Take down policy

If you believe that this document breaches copyright please contact us at [vbn@aub.aau.dk](mailto:vbn@aub.aau.dk) providing details, and we will remove access to the work immediately and investigate your claim.

# Conservation compatible energy retrofit technologies

**Part III** - Documentation and  
assessment of materials and  
solutions for **wall insulation**  
in historic buildings





# Conservation compatible energy retrofit technologies

## Part III: Documentation and assessment of materials and solutions for **wall insulation** in historic buildings

**Editors: Rainer Pfluger (UIBK), Alexander Rieser (UIBK)**

Contributing authors: Eleonora Leonardi (EURAC), Daniel Herrera (EURAC), Ernst Jan de Place Hansen (AAU), Roger Curtis (HES), Valentina Marincioni (UCL), Athina Petsou (UCL), Evola Gianpiero (UNICT), Cristina Polo (SUPSI), Sara Mauri (POLIMI), Tobias Hatt (EIV), Gustaf Leijonhufvud (Uppsala University), Susanne Kuchar (e7 energy innovation & engineering), Pavel Sevela (UIBK), Julien Borderon (Cerema)

**October 2021**

**SHC Task 59 | EBC Annex 76 | Report D.C1-III**

**DOI: 10.18777/ieashc-task59-2021-0006**

Cover Photo © Alexander Rieser

*The contents of this report do not necessarily reflect the viewpoints or policies of the International Energy Agency (IEA) or its member countries, the IEA Solar Heating and Cooling Technology Collaboration Programme (SHC TCP) members or the participating researchers.*

## IEA SHC Task 59 | EBC Annex 76: Deep renovation of historic buildings towards lowest possible energy demand and CO<sub>2</sub> emission (NZEB)

### Solar Heating and Cooling Technology Collaboration Programme (IEA SHC)

The Solar Heating and Cooling Technology Collaboration Programme was founded in 1977 as one of the first multilateral technology initiatives (“Implementing Agreements”) of the International Energy Agency.

**Our mission** is “Through multi-disciplinary international collaborative research and knowledge exchange, as well as market and policy recommendations, the IEA SHC will work to increase the deployment rate of solar heating and cooling systems by breaking down the technical and non-technical barriers.”

**IEA SHC** members carry out cooperative research, development, demonstrations, and exchanges of information through Tasks (projects) on solar heating and cooling components and systems and their application to advance the deployment and research and development activities in the field of solar heating and cooling.

**Our focus areas**, with the associated Tasks in parenthesis, include:

- Solar Space Heating and Water Heating (Tasks 14, 19, 26, 44, 54)
- Solar Cooling (Tasks 25, 38, 48, 53, 65)
- Solar Heat for Industrial and Agricultural Processes (Tasks 29, 33, 49, 62, 64)
- Solar District Heating (Tasks 7, 45, 55)
- Solar Buildings/Architecture/Urban Planning (Tasks 8, 11, 12, 13, 20, 22, 23, 28, 37, 40, 41, 47, 51, 52, 56, 59, 63, 66)
- Solar Thermal & PV (Tasks 16, 35, 60)
- Daylighting/Lighting (Tasks 21, 31, 50, 61)
- Materials/Components for Solar Heating and Cooling (Tasks 2, 3, 6, 10, 18, 27, 39)
- Standards, Certification, and Test Methods (Tasks 14, 24, 34, 43, 57)
- Resource Assessment (Tasks 1, 4, 5, 9, 17, 36, 46)
- Storage of Solar Heat (Tasks 7, 32, 42, 58, 67)

In addition to our Task work, other activities of the IEA SHC include our:

- SHC Solar Academy
- *Solar Heat Worldwide*, annual statics report
- SHC International Conference

#### Our members

|                     |                                    |                |
|---------------------|------------------------------------|----------------|
| Australia           | European Copper Institute          | SICREEE        |
| Austria             | France                             | Slovakia       |
| Belgium             | Germany                            | South Africa   |
| Canada              | International Solar Energy Society | Spain          |
| CCREEE              | Italy                              | Sweden         |
| China               | Netherlands                        | Switzerland    |
| Denmark             | Norway                             | Turkey         |
| EACREEE             | Portugal                           | United Kingdom |
| ECREEE              | RCREEE                             |                |
| European Commission | SACREEE                            |                |

For more information on the IEA SHC work, including many free publications, please visit [www.IEA.SHC.org](http://www.IEA.SHC.org).

### Energy in Buildings and Communities Technology Collaboration Programme (IEA EBC)

To reach the objectives of SHC Task 59 the IEA SHC implementing Agreement has collaborated with the IEA EBC Implementing Agreement at a “Medium Level Collaboration”, and with the IEA PVPS Implementing Agreement at a “Minimum Level Collaboration” as outlined in the SHC Implementing Agreement’s Policy on Collaboration.

---

# Contents

---

|  |            |
|--|------------|
| <b>Contents</b> .....  | <b>iii</b> |
| <b>1 Introduction</b> .....  | <b>1</b>   |
| 1.1 Subtask C: Conservation compatible retrofit solutions .....                              | 1          |
| 1.2 Content of the report.....   | 1          |
| <b>2 Wall solutions</b> .....  | <b>2</b>   |
| 2.1 Introduction.....  | 2          |
| 2.1.1 Aims and strategies on conservation of the structure and historic value of walls ..... | 2          |
| 2.1.2 Technical observation of the wall to be upgraded.....                                  | 2          |
| 2.1.3 Enhancement thermal comfort and increase of energy efficiency.....                     | 3          |
| 2.1.4 Building physics of internal insulation .....  | 4          |
| 2.1.5 Internal insulation systems .....  | 4          |
| 2.1.6 Overview of solutions.....   | 7          |
| 2.2 Internal insulation .....  | 9          |
| 2.2.1 Systems with capillary active insulation .....   | 9          |
| 2.2.2 Systems with membranes acting as vapour control layers .....                           | 30         |
| 2.2.3 Internal Insulation in cavities behind internal lining .....                           | 43         |
| 2.2.4 Innovative system solutions.....   | 52         |
| 2.2.5 Specific solutions for driving rain protection and wall drying.....                    | 57         |
| 2.3 External Insulation.....   | 59         |
| 2.3.1 External insulation .....  | 59         |
| 2.3.2 External and internal insulation.....  | 78         |
| 2.3.3 Reversible External Insulation .....   | 89         |
| 2.3.4 Frame infill insulation .....  | 92         |
| 2.4 Assessment of solutions according EN 16883:2017 .....                                    | 107        |
| 2.4.1 Methodology of Assessment.....   | 107        |
| 2.4.2 Detailed Assessment of walls .....   | 108        |



---

# 1 Introduction

---

## 1.1 Subtask C: Conservation compatible retrofit solutions

The main objective of Subtask C is to identify, assess and in some cases further develop retrofit solutions and strategies for historic buildings. The solutions should fulfil the conservation compatibility of historic buildings as well as energy efficiency goals towards lowest possible energy demand and CO<sub>2</sub> emissions (NZEB). Further, the objective is to make the solutions available for comprehensive integrated refurbishing concepts and strategies.

Subtask C aimed at identifying replicable solutions from case studies documented in Subtask A and ongoing R&D-projects on conservation compatible retrofit solutions and strategies. Specific focus was given to the following thematic areas: (i) windows, (ii) insulation of external walls, (iii) Heating (production, distribution) and ventilation systems, (iv) solar thermal and photovoltaic systems. The following report presents the results for the thematic area "insulation of external walls".

## 1.2 Content of the report

This report is basically divided into three chapters. The first chapter (chapter 2.1) describes some basic aspects of the procedure and technical aspects of the energy retrofitting of historic walls. The second part forms the core of this report and contains the documentation of a wide variety of thermal refurbishment solutions for external walls. For the documentation of the solutions, simple open questions were answered by the partners of SHC Task 59 and the ATLAS Interreg Project in order to enable a continuous structure of the solutions. The solutions are basically divided into two groups: Chap. 2.2 Internal insulation and Chap. 2.3 external insulation, with a further subdivision into subgroups.

The third part of this report contains an evaluation method for the renovation solutions for external walls. For this purpose, the assessment categories according to EN 16883 were taken as a basis and adapted in detail for walls. In order to illustrate the detailed assessment, three different solutions were tested using the adapted assessment criteria and are included in the last chapter of this report.

---

## 2 Wall solutions

---

### 2.1 Introduction

#### 2.1.1 Aims and strategies on conservation of the structure and historic value of walls

In addition to the windows and the roof, walls are a main component of the outer shell of a building. Consequently, the designs and also the requirements of an exterior wall are numerous. Depending on its use, a wall has to meet a wide variety of physical requirements. In addition to these technical necessities, the wall is also an expression of design and architecture. High quality materials, workmanship and designs can be created in a wide variety of solutions. With the increasing standards for buildings, however, many existing walls no longer adequately fulfil their physical tasks and need to be renovated. In addition to technical improvements, it is important that the design and architecture of historical walls be fundamentally preserved.

In addition to the technical appraisal, the historical and cultural values of the building must be identified and assessed. In the case of a listed building, this has already been recorded by the heritage office and evaluated with their expertise. If the building is not listed, the stakeholders involved have to determine the history of the building and study old plans, photos and descriptions of the building. Based on this knowledge, the historically relevant elements can be determined. In the case of exterior walls, this can range from historic plaster, stucco and paintings to the type and craftsmanship of the masonry.

#### 2.1.2 Technical observation of the wall to be upgraded

To verify the performance of a wall, it is necessary to be clear about the functions of a wall. An exterior wall usually serves as a static load-bearing component for walls, ceilings and the roof. Furthermore, a wall must provide protection against wind, weather and acoustic noise.

##### **Structural verification**

Cracks and bulges as well as areas of spalling at the wall indicate a problem with the structural condition of a building. If such signs are detected at the wall, it is advisable to consider a structural assessment of the building in order to be able to estimate the exact condition and the effort required to repair the building fabric.

##### **Moisture Protection**

The main problem of any building is moisture. Whether it is rain, rising damp or sources of moisture inside the building, any kind of moisture load poses a major problem for the building over time. On walls, a damp problem can usually be recognised by falling and loose plaster, discolouration or even mould. In the case of wooden walls, the damp can also cause the wood to rot, which in turn can lead to a structural problem. Basically, three types of moisture load must be evaluated in this context:

- **Moisture load from the environment** which can penetrate the wall via rain if there is insufficient protection against *driving rain*. In this context, the condition of the façade must be checked. Are the façade cladding and/or plaster intact? The driving rain protection may have already been solved by sufficiently large canopies and / or balconies. If no constructive protection is available, the external surface of the wall, i.e. the plaster or cladding, must be sufficiently water-repellent. This is a fundamental problem, especially when preserving historic facades, as the facade should not be altered. Appropriate plaster, paint, waterproofing the masonry or ventilated cladding can provide a remedy and are a necessary basis for additional energy improvements. It is important that the façade is water-repellent but at the same time open to diffusion.  
Rising damp from the ground (groundwater / slope water etc.) which is drawn into the wall by capillary suction can also lead to damp spots in the lower area of a wall. Rising damp can be controlled by inserting horizontal barrier layers. Lateral air sealing must be avoided, as this will even further promote capillary moisture transport, as lateral drying is prevented. Attention should be paid to the application of diffusion-open plasters in order to guarantee lateral drying.
- **Moisture load due to moisture transport from the inside to the outside:** In addition to the obvious moisture loads from the environment, moisture transport mechanisms (water vapour convection, water



vapour diffusion) occur due to different temperatures and relative humidity between the interior and exterior.

- **Manufacturing and initial moisture** (e.g. due to additional plaster etc.)

### ***Thermal Protection***

In most historic buildings, there is insufficient thermal protection, namely the absence of modern insulation materials. Due to the high heat losses through the exterior walls, the interior wall surface (of the exterior wall) is significantly colder than the wall surface of the walls that exist only on the interior (such as partitions). Due to this temperature difference of the surfaces, the living room climate can be perceived as uncomfortable. If, in addition, there are high humidity loads in the interior (high relative humidity), the moisture condenses on the wall or reaches a very high relative humidity and can lead to mould growth. The U-value of a wall can be determined by surveying wall constructions. Possible thermal bridges can be determined with the help of a thermal imaging camera.

### ***Airtightness of the building***

Particularly in historical buildings, hardly any importance was attached to an airtight outer shell during construction. Depending on the type of wall, the airtightness varies greatly. Log walls are relatively air-permeable due to the numerous cracks and connections with the interior walls. Plastered masonry (natural stone, brick, etc.) is quite airtight due to the continuous plaster finish, but most penetrations such as windows or timber frame ceilings have major leakages. Increased airtightness is necessary for the preservation of a wall construction because it prevents warm moist air from penetrating into the interior of the construction assembly, condensing there and leading to moisture damage. Some are concerned that an airtight layer does not allow the wall to breathe, but this statement is a myth as no wall should be designed to breathe in an uncontrolled manner. An exchange of air between the interior and exterior air is necessary to ensure the removal of moisture loads and harmful substances, but this should take place in a controlled manner through mechanical ventilation or at least through sufficient ventilation behaviour on the part of the users. Uncontrolled ventilation due to air leakage can lead to damage in the construction and is associated with enormous energy loss. The airtightness of a building can be tested by means of a so-called "Blower door test".

## **2.1.3 Enhancement thermal comfort and increase of energy efficiency**

To improve the energy efficiency of a wall, additional insulation must be added. This can be attached either on the external or internal side of the wall or in any cavities that may exist. Each type of insulation has its pros and cons. From an energy and technical point of view, external insulation is always preferable to internal insulation. Unfortunately, external insulation also entails a visual change to the façade. However, there are also many applications for historical buildings where external insulation can be combined with the values of the building.

### ***External insulation***

External insulation has the great advantage that it is not problematic from a building physics point of view and that integrating walls and ceilings can simply be insulated over, thus reducing thermal bridges. Another important advantage is the maintenance of the façade. Weak points with regard to driving rain can thus be solved. The big disadvantage is the intervention on the appearance of the building. The additionally applied insulation layer covers the original façade. The proportions of the building are also altered and thus change the visual appearance of the building.

### ***Internal insulation***

The major advantage of internal insulation, and thus the explanation why this solution is used in so many historic buildings, is that the external appearance of the building remains more or less unchanged. Interior insulation reduces the effective heat capacity of the interior. This refers to the heat capacity of the interior surfaces that are in exchange with the air in the room. The higher this capacity, the more inertly the indoor air reacts to temperature changes. With interior insulation, a room can be heated up very quickly because the inert outer walls do not have to be heated up as well. However, the lower capacity also makes it more difficult to compensate during peaks of hot or cold temperatures.

The disadvantages of internal insulation are the increased risk of damage and the space required. As a result of the internal insulation, the existing wall is cooled down. Depending on the insulation thickness, the wall is thus

"heated" from the inside to a much smaller extent and moisture due to driving rain and rising damp can dry out at a slower rate. For this reason, these moisture entries must be prevented and solved without fail, especially in the case of thermal refurbishment! Another disadvantage is the transport of moisture from the inside to the outside. If the warm moist air meets the cold existing wall, condensation or very high relative humidity can occur, which can lead to the growth of mould. Therefore, precise planning and an analysis of the existing wall are necessary for the implementation of internal insulation, which must be checked for suitability in consultation with the architect and building physicist.

## 2.1.4 Building physics of internal insulation

### ***Water vapour diffusion / convection***

As already mentioned in the chapter "Moisture protection", moisture can enter the wall not only from the outside (driving rain and rising damp), but also from the inside. In winter, it is significantly warmer and moister inside the building than outside. The occupants of a building as well as plants and animals constantly release moisture into the indoor air. Activities such as cooking, showering and washing are also sources of moisture. Since this difference in humidity between inside and outside seeks to balance itself out, moisture transport takes place through the wall. This moisture transport can take place through diffusion and convection. With ***water vapour diffusion***, the water vapour diffuses through the material. Depending on the diffusion resistance number ( $\mu$ ) of a material, this transport can vary in magnitude. Multiplying this resistance number by the thickness of the material gives the  $S_d$  - value (equivalent air layer thickness  $S_d = \mu \cdot \text{thickness [m]}$ ). The larger the  $S_d$  - value, the greater the diffusion resistance and the slower the transport through the material will be.

The second decisive moisture transport mechanism is ***water vapour convection***. This moisture transport takes place due to an air flow. If there is no sufficient airtight layer (plaster, foils, etc.) on the inside of the exterior wall, the moist warm air can penetrate the construction due to pressure differences (wind, buoyancy forces, etc.). Convection has a much higher transport potential than pure diffusion, about 100 times greater. For this reason, it is particularly important to ensure sufficient air tightness to prevent convection.

### ***Problem with internal insulation***

The main issue with internal insulation is the reduction of the temperature of the existing wall. Since the insulation has a very high thermal resistance compared to the existing wall, the temperature at the surface between the new internal insulation and the existing wall is much lower than with the originally uninsulated wall. The higher the thermal resistance of the existing wall (e.g. wood has a better insulating effect and therefore a higher thermal resistance than stone masonry), the higher and therefore less problematic the temperature between the existing wall and the insulation. The thicker the internal insulation, the higher the thermal resistance of the internal insulation and the lower the temperature on the internal surface of the existing external wall. The temperature thus adjusts itself exactly according to the ratio of the resistances in the building component.

However, the temperature alone is not yet a problem. It becomes critical as soon as moisture comes into the game. With diffusion-open external insulation, the diffused moisture can be immediately transported away to the outdoor air. With internal insulation, however, the moisture can accumulate due to the diffusion resistance of the existing wall and lead to condensation and the associated formation of mould on the cold surface between the insulation and the existing wall. Here, too, transport occurs according to the resistance of the respective materials. Therefore, a construction should always be more open to diffusion towards the outside, i.e. the diffusion resistance should become smaller towards the inside. How high the damage potential is depends significantly on the climate. In warmer climates, the existing wall does not cool down as much and internal insulation is less problematic than in a very cold climate.

## 2.1.5 Internal insulation systems

There are basically two ways to ensure a functioning moisture management wall design:

- tolerating diffusion through suitable insulation materials
- retarding the vapour diffusion flow

### ***Capillary-active internal insulation systems***

Under the condition of a solved driving rain situation and the prevention of rising damp, there are insulation materials that have the property of absorbing a certain amount of moisture, storing it temporarily and releasing the moisture back into the interior against the diffusion flow. These materials are known as capillary-active insulation materials. It is important that these materials are applied as a complete system (e.g. capillary-active insulation board with suitable adhesive). Another important aspect of this system is that unhindered drying to the interior can take place. For this reason, the room-side finish must be designed to be as open to diffusion as possible.

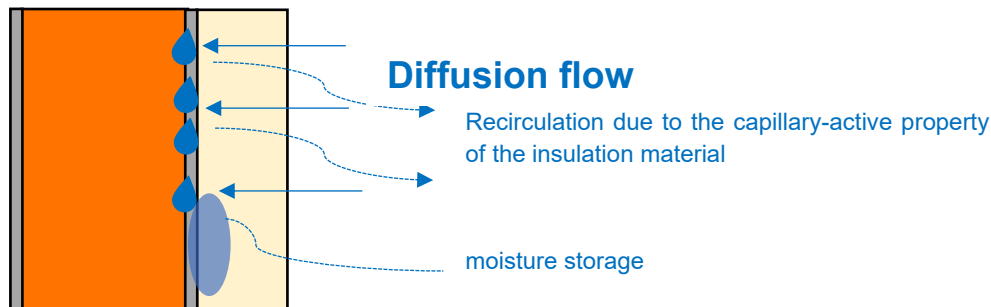

figure 1: Scheme of a diffusion-open interior insulation system

The best-known capillary-active insulation material is calcium silicate and mineral foam. Meanwhile, there are also PUR foam boards with small calcium silicate tunnels that ensure the return of moisture to the interior. When laying the board, care must be taken to ensure that it is installed without cavities. Cellulose and numerous insulating plasters such as lime plasters also have capillary-active properties, although the insulating effect of the plasters is much lower. Softwood fibreboards are also often advertised as capillary-active insulating materials, but the effect is not nearly as high as with the previously mentioned insulating materials. The hygrothermal performance of this insulation highly depends on the adhesive and the interior plaster used in the system, not only on the insulation material itself. In diffusion-open systems, materials with very good moisture storage properties must be distinguished from materials with capillary-active properties. However, there are also materials that combine both properties.

### **Diffusion-retardant internal insulation systems**

Diffusion-retardant internal insulation systems slow down the diffusion flow from the inside by means of so-called vapour retarders or vapour barriers. These diffusion-retardant layers have a very high diffusion resistance despite their low thickness. Due to the lower diffusion flow, less moisture gets into the construction from the indoor environment and structural damage can be avoided. Diffusion-retardant insulation systems can only be installed on walls with low exposure to wind-driven rain, as they are not able to deal with rainwater penetration.

Vapour retarders are available in various designs (polyethylene foils, PVC foils, aluminium foils or wooden boards). To estimate the effect of a vapour barrier, the  $S_d$  - value must be considered. The higher this value, the greater the diffusion resistance created. Moderate vapour retarders can be made of OSB boards, for example, a 15 mm thick OSB board achieves an  $S_d$  - value of 3.0-4.5 m. If higher diffusion resistances are required, there are countless manufacturers of vapour retarders. Usually, foils are used as vapour retarders which also achieve much higher  $S_d$  - values, up to aluminium foils which are considered vapour-tight and achieve a  $S_d$  - value of more than 1500 m.

Unfortunately, the diffusion resistance does not only work from the inside to the outside but also in the opposite direction. In the summer, the diffusion flow is reversed and drying out towards the interior is possible in principle. However, if a vapour retarder or even a vapour barrier is installed, this drying is impeded or prevented. This can be remedied by **moisture-adaptive vapour retarders** which adapt their properties depending on the environment. Thus, the  $S_d$  - value is higher in winter and slows down the penetration of moisture. In summer, the  $S_d$  - value decreases and allows the construction to dry out. The choice of the right vapour retarder is decisive for the function of the construction and must guarantee a balanced moisture management. The retarding effect in winter must be adapted to the drying potential in summer. Location-specific conditions (rising damp, driving rain load, damp masonry and climate) must also be considered in the moisture balance

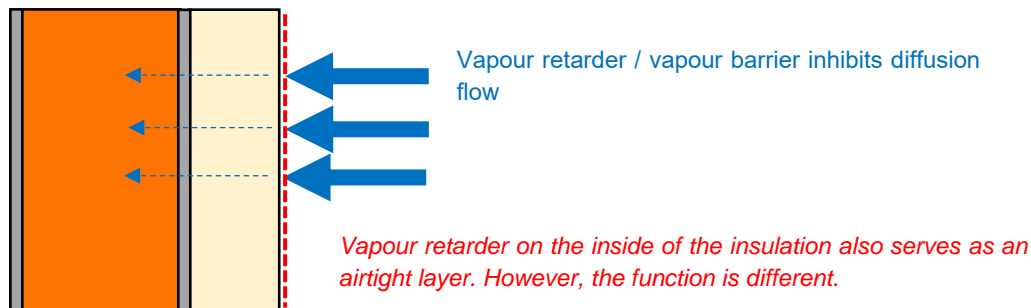

figure 2: Scheme of a diffusion-retardant interior insulation system

The installation of vapour retarders and barriers requires profound expertise. A consistent installation and accurate connections to penetrations are a prerequisite for the successful functioning of the internal insulation system. The vapour retarder usually also fulfils the role of an airtight layer, but the function of a vapour retarder and airtight layer must be strictly separated. For example, a butt-glued OSB board can be considered airtight, but the diffusion resistance is limited and, in some cases, not sufficient. Leakage, in turn, can cause convective moisture entry, which quickly pushes the system to its limits. Therefore, gapless airtight installation is essential.

Especially with old walls or log walls, it is advantageous to install flexible insulation to compensate for the unevenness of the wall. The insulation can be clamped between studs fixed to the wall (e.g. mineral wool, wood wool, etc.) or blown in (e.g. cellulose). However, a vapour barrier made of foil cannot resist the pressure of a blown-in insulation, which is why OSB boards are very suitable as a top layer. If the diffusion resistance of the OSB board is too low, another board material can be used as a support layer and an additional foil can be applied.

On the vapour retarder layer, it is recommended to install a so-called installation layer of approx. 4-5 cm, which can be covered on the room side with the preferred design. Building services or electrical connections can thus be installed in this installation layer and save penetration of the vapour retarder and airtight layer.

In order not to weaken the insulation layer unnecessarily, a two-layer crosswise substructure is used for thicker insulation or alternatively T-beams which have lower thermal bridging capacity.

## 2.1.6 Overview of solutions

| Category  | Measure  | Best practice example  | Author  |
|---|--|--|---|
| <b>Internal Insulation</b>                                    |  |  |   |
| <b>Capillary active insulation</b>                            | Perlite / Aerogel  | <a href="#">Villa Castelli, Italy</a>  | Daniel Herrera (EURAC)                              |
|   | PUR-foam with channels of capillary-active material – solution A     | Thomas Laubs Gade, Denmark   | Ernst Jan de Place Hansen (AAU)                     |
|   | PUR-foam with channels of capillary active material – solution B     | Folehaven, Denmark   | Ernst Jan de Place Hansen (AAU)                     |
|   | Calcium silicate   | Folehaven, Denmark   | Ernst Jan de Place Hansen (AAU)                     |
|   | Aerated concrete   | Folehaven, Denmark   | Ernst Jan de Place Hansen (AAU)                     |
|   | Wet applied cellulose insulation between frames                      | -  | Roger Curtis (HES)                                  |
|   | Insulated lime plaster   | <a href="#">Downies Cottage, United Kingdom</a>                                  | Roger Curtis (HES)                                  |
|   | Wood fibre   | -  | Eleonora Leonardi (EURAC)                           |
|   | Insulated lime plaster with cork                                     | -  | Athina Petsou (UCL)                                 |
|   | Dense wood fibre   | -  | Athina Petsou (UCL)                                 |
|   | Nanoporous Aerogel insulating blanket                                | -  | Evola Gianpiero (Unict)                             |
|   | Wood fibre board between frames, calcium silicate board onto masonry | -  | Roger Curtis (HES)                                  |
| <b>Systems with vapour retarder</b>                           | Mineral wool with vapour barrier – Solution 1                        | <a href="#">Ansitz Kofler, Italy</a>   | Eleonora Leonardi (EURAC)                           |
|   | Mineral wool with vapour barrier – Solution 2                        | <a href="#">Doragno Castle, Switzerland</a>                                      | Cristina Polo (SUPSI)                               |
|   | Cellulose for log wall   | <a href="#">Hof "Neuhäusl", Austria</a>  | Alexander Rieser (UIBK)                             |
|   | Sheep wool with vapour retardant layer                               | <a href="#">Giatlahaus, Austria</a>  | Alexander Rieser (UIBK)                             |
| <b>Internal insulation in cavities behind internal lining</b> | Double – shell masonry wall  | <a href="#">Single family house - Bern, Switzerland</a>                          | Cristina Polo (SUPSI)                               |
|   | Aerogel based material for blown- in insulation                      | -  | Eleonora Leonardi (EURAC)                           |
|   | Blown cellulose insulation for mass walls                            | <a href="#">Holyrood Park Lodge, United Kingdom</a>                              | Roger Curtis (HES)                                  |
|   | Injected foam insulation behind existing plaster                     | <a href="#">Annat Road, United Kingdom</a>                                       | Roger Curtis (HES)                                  |
| <b>Innovative system solutions</b>                            | Aerogel – based textile wallpaper                                    | -  | Sara Mauri (Polimi)                                 |
|   | Innovative reflective coating  | -  | Eleonora Leonardi (EURAC)                           |
|   | Rainwater management strategy  | -  | Athina Petsou (UCL)                                 |
|   | Natural Crystallization Technology (NCT)                             | -  | Tobias Hatt (EIV)                                   |
| <b>External Insulation</b>                                    |  |  |   |
| <b>External Insulation</b>                                    | Mineral Wool – Solution 1  | <a href="#">Apartment building Magnustrasse, Switzerland</a>                     | Cristina Polo (SUPSI)                               |
|   | Mineral Wool – Solution 2  | <a href="#">Residential and commercial building Feldbergstrasse, Switzerland</a> | Cristina Polo (SUPSI)                               |
|   | Façade integrated renewable  | <a href="#">Solar Silo in Grundeldinger Feld, Switzerland</a>                    | Cristian Polo (SUPSI)                               |
|   | Mineral wool under shingle facade                                    | Gasthaus Adler, Austria  | Tobias Hatt (EIV)                                   |
|   | Vacuum insulation panels   | -  | Gustaf Leijonhufvud (Uppsala University)            |
|   | Aerogel high-performance insulating plaster system                   | <a href="#">Mariahilferstraße, Austria</a>                                       | Susanne Kuchar (e7 energy innovation & engineering) |
| <b>External and internal Insulation</b>                       | External insulation combined with internal insulation                | -  | Alexander Rieser (UIBK)                             |
|   | External and internal insulation – reed mat                          | <a href="#">Kohlerhaus, Italy</a>  | Eleonora Leonardi (EURAC)                           |

|                                       |   |  |                          |
|---------------------------------------|---|--|--------------------------|
|                                       | External and internal insulation – Multipor           | <u>Kindergarten and apartments - Chur, Switzerland</u> | Cristina Polo (SUPSI)    |
|                                       | External and internal insulation on solid timber wall | <u>Single family House - Gstaad, Switzerland</u>       | Cristina Polo (SUPSI)    |
| <b>Reversible External Insulation</b> | Reversible external insulation – Sto Ges.m.b.H        | -  | Alexander Rieser (UIBK)  |
|                                       | Reversible external insulation façade with cellulose  | <u>Farm house Trins, Austria</u>                       | Pavel Sevela (UIBK)      |
| <b>Frame infill insulation</b>        | Hemp concrete   | -  | Julien Borderon (Cerema) |
|                                       | Straw insulation in hay loft                          | -  | Pavel Sevela (UIBK)      |
|                                       | Timber wall with wood fibre                           | <u>Glaserhaus, Switzerland</u>                         | Cristina Polo (SUPSI)    |

## 2.2 Internal insulation

### 2.2.1 Systems with capillary active insulation

#### 2.2.1.1 Perlite / Aerogel

Author: Daniel Herrera (EURAC)

What is the solution?

This solution includes a complementary use of perlite and aerogel. The outer wall was insulated internally with 20 cm perlite or 8 cm Aerogel, depending on the geometric requirements. The moisture transport was simulated for both internal insulations. In addition to that, all emerging nodes were designed for "buildability" with particular attention to airtightness, vapor diffusion and convection.

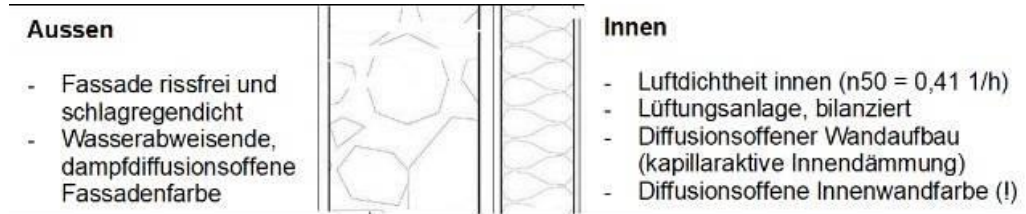

figure 3: cross section: concept of the internal insulation, ©Valentina Cari

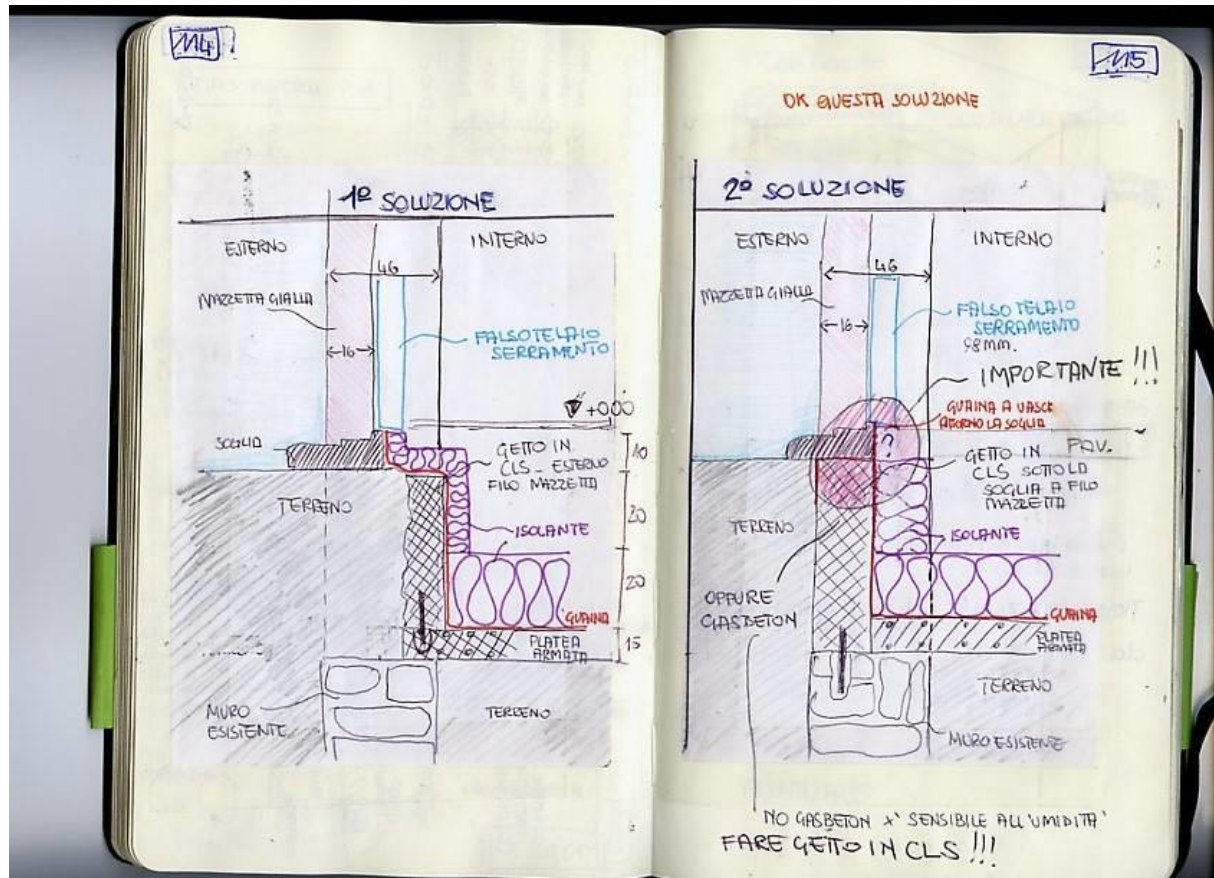

figure 4: Thermal bridge detail, ©Valentina Cari

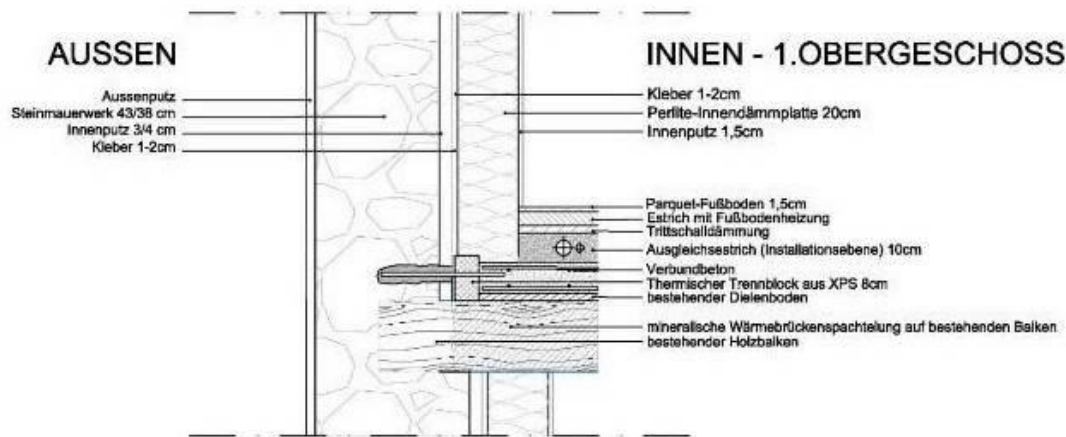

figure 5: Cross section, ©Valentina Cari

### Why does it work?

The decorative frescos and the volume proportions of the historical facade of this building are worth preserving, thus the choice of internal insulation. An airtight building envelope was important in two respects: first, to ensure the long-term performance of the interior insulation, and second, to limit the ventilation losses in a wind-exposed location. A mechanical ventilation system ensures optimum air hygiene (primarily CO<sub>2</sub> concentration, but also indoor air humidity). Hygrothermal simulations were carried out. Overall, the simulation for the location of Villa Castelli on Lake Como (Italy) does not show any condensation in the area between the internal insulation and the existing external wall. Thermal bridges are also simulated, and the moisture does not rise to critical level. In order to investigate the solution's behaviour in other climates, simulations for different climate were carried out. This results that the solution works well for Lago di Como's climate, simulations for colder climates, for example in Essen (Germany) are more critical and require attention, instead.

### Description of the context

The Villa Castelli is a listed building (as part of the lake "vincolo paesaggistico", as well as the building itself "vincolo architettonico") from the 19th century located at the Lake Como. Modifying the external façade of the building was not possible, it was necessary to work together with energy-related and structural issues in order to find solutions that meet all requirements. The client required a high level of energy efficiency for the refurbishment and this could only be reached with internal insulation. In order to maximize the thickness of insulation and avoid hygrothermal risks, detailed dynamical simulations were carried on.

### Pros and Cons

There are two main "pros" in this solution: the easy construction process that allows a full bond between masonry and insulation, and the heat loss reduction across the wall. The heating requirement was reduced from 248 kWh/m<sup>2</sup>a to 18 kWh/m<sup>2</sup>a, which represents a saving of over 90%. The cooling requirement, on the other hand, increased because of the decoupling of the thermal mass of the outer walls (from 8.4 kWh/m<sup>2</sup>a to 11.5 kWh/m<sup>2</sup>). The main disadvantages are the loss of floor space due to the thickness of the insulation layer in the case of perlite, or the high investment costs in the case of aerogel. Additionally, a high number of critical points (mainly connections and thermal bridges) had to be carefully designed during the planning phase (about 30 pcs.).

### Type of Data Available

The building is well documented, as detailed information of the decision-making process and the construction details are available. Hygrothermal simulations were done.





*figure 6: Installation of internal insulation, © Eurac*



*figure 7: Façade of the building, © Valentina Cari*

**Best practice Example:**

Villa Castelli, Italy: <https://www.hiberatlas.com/de/villa-castelli--2-23.html>

### 2.2.1.2 PUR-foam with channels of capillary-active material – solution A (Thomas Laubs Gade)

Author: Ernst Jan de Place Hansen (AAU)

#### What is the solution?

PUR –foam-based internal insulation of external walls. 30 mm PUR-foam based insulation ( $\lambda$  0,031 W/(m K)) applied to 350 mm solid masonry walls, at the interior side. The insulation consists of PUR-foam with thin calcium silicate channels every 40 x 40 mm, making the insulation capillary-active to some extent. Any irregularities in the original inner surface (render) are levelled by means of plaster and glue mortar before applying the insulation blocks.

#### Why does it work?

This solution does not change the expression of the building seen from the outside. In a specific case (multi-storey residential building), measurements at the interface between the existing wall and the internal insulation show a decrease in relative humidity so that after about 6 months there is no risk of mould growth. The calculated U-value of the wall was reduced from 1,49 W/(m<sup>2</sup> K) to 0,59 W/(m<sup>2</sup> K) with 30 mm insulation. There was no measurement of energy consumption before and after the renovation.

#### Description of the context

The building is a multi-storey residential building from 1899 built in traditional Danish style, with solid masonry and embedded wooden beams and lath for floor separations. To keep the original appearance of the façade, internal insulation was chosen to improve the energy performance. Further, as only one single apartment on 4<sup>th</sup> floor was insulated, it made no sense to insulate externally.

#### Pros and Cons

Pros: Reduces the U-value of the wall resulting in lower energy consumption and better indoor climate (higher temperature at the inner surface of the wall). Using an insulation material with a low thermal conductivity (0,031 W/(m K), the thickness could be kept low (in total about 45 mm including glue mortar and reinforcement plaster).  
Cons: As the system is glued directly to the existing wall it is not easily removable and inspection of conditions behind the insulation is only possible by means of sensors installed together with the insulation.

#### Type of Data Available

Hourly based measurements (RH, temperature) during 2015-2017 at the interface between the existing wall and the internal insulation, and at the beam ends. Data also includes simulation results. Data are reported in (Hansen, Bjarløv, Peuhkuri & Harrestrup, 2018);

<https://www.scopus.com/record/display.uri?eid=2-s2.0-85047062402&origin=inward&txGid=f12b8eefd27e14938c7124726313995>



figure 8: Facade towards street. External wall in apartment at upper floor was renovated with internal insulation. © Google street view (left) and AAU (right)

### 2.2.1.3 PUR-foam with channels of capillary-active material – solution B (Folehaven)

Author: Ernst Jan de Place Hansen (AAU)

This example is from a multi-story development, where three different internal insulation systems were tested at gable walls (described in section 2.2.1.3 and 2.2.1.5), staircase walls (described in section 2.2.1.4) and facades (using same solution as described in section 2.2.1.3, however 50 mm of PUR-foam). This was done to decide whether they would be suitable for the whole development, consisting of 932 apartments, cf. subsections 'Description of the context' and 'Additional information'. The three examples presented in section 2.2.1.3-2.2.1.5 share a fair amount of text to make each of them readable.

#### What is the solution?

Internal insulation of 360 mm solid gable walls made of brick and lightweight concrete (110-230 mm outer layer of brick with holes, layer of concrete, and 10 mm interior plaster) using 80 mm PUR-foam ( $\lambda$  0,031 W/(m K)) with thin calcium silicate channels every 40 x 40 mm, making the insulation capillary-active to some extent. Any irregularities in the original inner surface (render) are levelled by means of plaster and glue mortar before applying the insulation blocks. The average U-value of the wall is reduced from 1,05 W/(m<sup>2</sup> K) to 0,65 W/(m<sup>2</sup> K) (calculated values).



figure 9: Drill core of the wall structure. © AAU

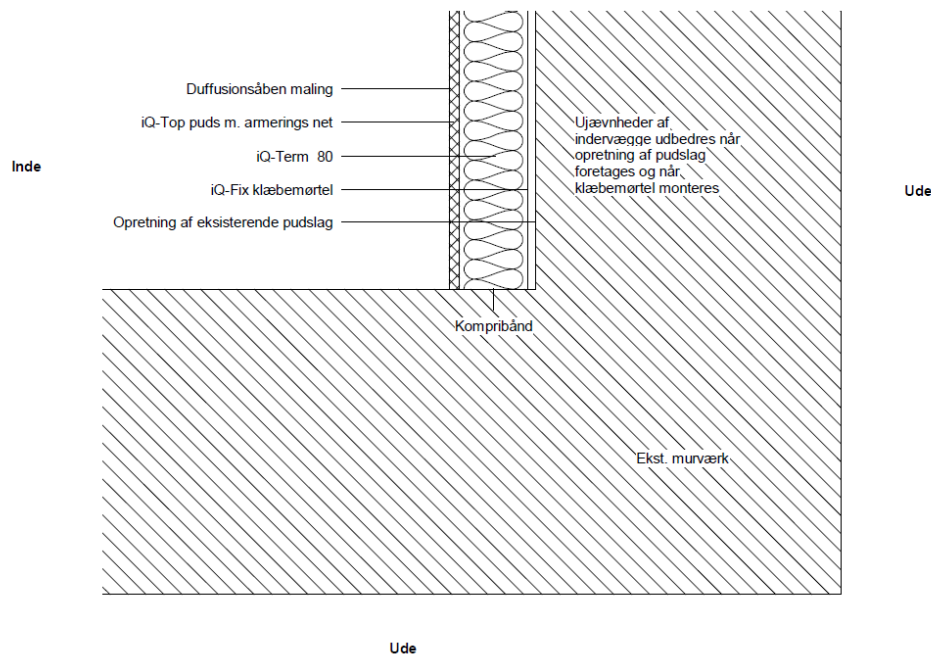

figure 10: Internally insulated gable wall, 80 mm of insulation (PUR-foam with thin calcium-silicate channels). Corner between gable wall (insulated, at right) and facade (not insulated, at bottom), horizontal cross-section. © AAU

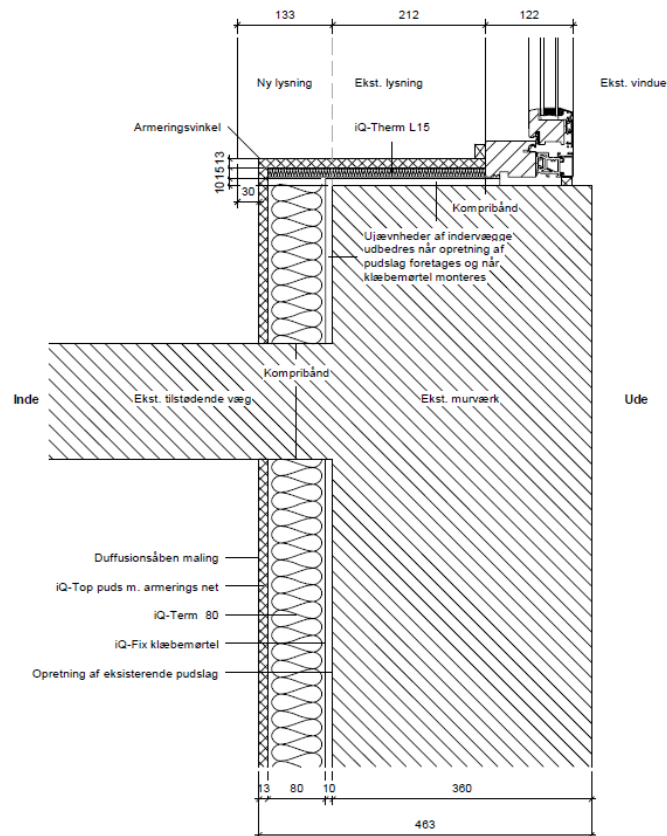

figure 11: Internally insulated gable wall, 80 mm of insulation (PUR-foam with thin calcium-silicate channels). Horizontal cross-section between external wall (insulated) and internal wall, including details at window (window sill insulated). © AAU



figure 12: Installation of internal insulation © AAU

### Why does it work?

There was no sign of moisture-related damage after three winters, though these were mild winters compared to normal Danish winters. Energy saving was around 20 %. Insulation can be removed as it is added as an extra layer to the existing construction. However, the existing wall may have to be repaired afterwards. The solution was chosen based on energy efficiency, not conservation compatibility.

### Description of the context

Internal insulation was used as part of the Copenhagen municipality policy to reduce energy use in buildings by 20 % by 2025, while keeping the appearance of dwellings unchanged and improving the indoor climate and comfort. Existing interior surface (rendering) was cleaned for any organic material before applying the insulation system to remove any remains of organic material before its installation. Wooden laths were applied at the inner surface to give the inhabitants the possibility to hang paintings or other things on the walls without damaging the insulation. In

some of the test apartments, the insulation was removed again after two years to see whether there was any mould growth at the interface between the insulation and the original wall.



*figure 13: View of gable wall after removing the internal insulation, to look for mould growth two years after installation. No mould growth was identified; however, the view shows that the insulation system did not fully bond to the existing wall. © AAU*



*figure 14: Close up of the wall in figure 13 showing the size of the areas with no bonding. According to the producer, opening of max 4x4 cm are accepted © AAU*



figure 15: Close up of the wall in figure 13 indicating the depth of the area without bonding. © AAU

### Pros and Cons

So far, the solutions have worked for three (mild) winters (2015-2018). Long term behaviour remains to be seen. However, based on the experience from the test apartments, the municipality wants to apply internal insulation in the whole development, consisting of 932 apartments (not decided yet). As the system is glued directly to the existing wall it is not easily removable and inspection of conditions behind the insulation is only possible by means of sensors installed together with the insulation.

### Type of Data Available

Hourly based measurements (RH, temperature) from test apartments since autumn 2015.

### Additional Information

The following journal papers contain detailed information (link provided):  
<https://doi.org/10.1080/23744731.2019.1629241> and <https://doi.org/10.14305/ibpc.2018.be-6.06>

### 2.2.1.4 Solid walls (brick and lightweight concrete) with calcium silicate as internal insulation

Author: Ernst Jan de Place Hansen (AAU)

This example is from a multi-story development, where three different internal insulation systems were tested at gable walls (described in section 2.2.1.3 and 2.2.1.5), staircase walls (described in section 2.2.1.4) and facades (using same solution as described in section 2.2.1.3, however 50 mm of PUR-foam). This was done to decide whether they would be suitable for the whole development, consisting of 932 apartments, cf. subsections 'Description of the context' and 'Additional information'. The three examples presented in section 2.2.1.3-2.2.1.5 share a fair amount of text to make each of them readable.

#### What is the solution?

Internal insulation of 360 mm external staircase walls made of brick and lightweight concrete (110-230 mm outer layer of brick with holes, layer of concrete, and 10 mm interior plaster), using 50 mm calcium-silicate,  $\lambda$  0,067 W/(m K). The average U-value of the wall was reduced from 1,05 W/(m<sup>2</sup> K) to 0,65 W/(m<sup>2</sup> K) (calculated values).

#### Why does it work?

There was no sign of moisture-related damage after three winters, however these were mild winters compared to normal Danish winters. Energy saving was around 20 %, more if additional energy saving measures were implemented. Insulation can be removed as it is added as an extra layer to the existing construction. However, the existing wall may have to be repaired afterwards. The solution was chosen based on energy efficiency, not conservation compatibility.

## Description of the context

Internal insulation was used as part of the Copenhagen municipality policy to reduce energy use in buildings by 20 % by 2025, while keeping the appearance of dwellings unchanged and improving the indoor climate and comfort. Existing interior surface (rendering) was cleaned for any organic material before applying the insulation system to remove any remains of organic material before its installation. Wooden laths were applied at the inner surface to give the inhabitants the possibility to hang paintings or other things on the walls, without destroying the insulation.

## Pros and Cons

So far, the solutions have worked for three (mild) winters (2015-2018). Long term behaviour remains to be seen. However, based on the experience from the test apartments, the municipality wants to apply internal insulation in the whole dwelling, consisting of 932 apartments (not decided yet). As the system is glued directly to the existing wall it is not easily removable and inspection of conditions behind the insulation is only possible by means of sensors installed together with the insulation.

## Type of Data Available

Hourly based measurements (RH, temperature) from test apartments since autumn 2015.

## Additional Information

The following journal papers contain detailed information (link provided):  
<https://doi.org/10.1080/23744731.2019.1629241> and <https://doi.org/10.14305/ibpc.2018.be-6.06>

### 2.2.1.5 Solid walls (brick and lightweight concrete) with aerated concrete

Author: Ernst Jan de Place Hansen (AAU)

This example is from a multi-story development, where three different internal insulation systems were tested at gable walls (described in section 2.2.1.3 and 2.2.1.5), staircase walls (described in section 2.2.1.4) and facades (using same solution as described in section 2.2.1.3, however 50 mm of PUR-foam). This was done to decide whether they would be suitable for the whole development, consisting of 932 apartments, cf. subsections 'Description of the context' and 'Additional information'. The three examples presented in section 2.2.1.3-2.2.1.5 share a fair amount of text to make each of them readable.

#### What is the solution?

Internal insulation of 360 mm solid gable walls made of brick and lightweight concrete (110-230 mm outer layer of brick with holes, layer of concrete, and 10 mm interior plaster) using 80 mm aerated concrete,  $\lambda$  0,042 W/(m K). The average U-value of the wall is reduced from 1,15 W/(m<sup>2</sup> K) to 0,45 W/(m<sup>2</sup> K) (calculated values).

#### Why does it work?

There was no sign of moisture related damage after three winters, however mild winters compared to normal Danish winters. Energy saving was around 20 %, more if additional energy saving measures were implemented. Insulation can be removed as it is added as an extra layer to the existing construction. However, the existing wall may have to be repaired afterwards. The solution was chosen based on energy efficiency, not conservation compatibility.

#### Description of the context:

Internal insulation was used as part of the Copenhagen municipality policy to reduce energy use in buildings by 20 % by 2025, while keeping the appearance of dwellings unchanged and improving the indoor climate and comfort. Existing interior surface (rendering) was cleaned for any organic material before applying the insulation system to remove any remains of organic material before its installation. Wooden laths were applied at the inner surface to give the inhabitants the possibility to hang paintings or other things on the walls, without destroying the insulation.

#### Pros and Cons

So far, the solutions have worked for three (mild) winters (2015-2018). Long term behaviour remains to be seen. However, based on the experience from the test apartments, the municipality wants to apply internal insulation in the whole dwelling, consisting of 932 apartments (not decided yet).

#### Type of Data Available

Hourly based measurements (RH, temperature) from test apartments since autumn 2015.

#### Additional Information

The following journal papers contain detailed information (link provided):  
<https://doi.org/10.1080/23744731.2019.1629241> and <https://doi.org/10.14305/ibpc.2018.be-6.06>



### 2.2.1.6 Wet applied cellulose insulation between frames

Author: Roger Curtis (HES)

#### What is the solution?

This measure is suitable when there are no internal linings and the walls are back to the masonry. The insulation material, a wet cellulose fibre mix, is blown onto the wall between vertical timber battens. The material is allowed to dry, and the surface is planed flat. Plasterboard is then fastened to close off.

#### Why does it work?

This measure is only suitable if there are no historic material left on the inside of the walls. The material is vapour permeable and capillary active and allows traditional walls to perform as intended. The insulation is generally in the region of 60 mm thick, and gives a U-value of around 0,6 W/(m<sup>2</sup>K).

#### Description of the context

This measure was tested in a small tenement flat in Glasgow, built around 1910. The building needed major refurbishment due to subsidence, and the owner, a housing association, sought to deliver energy upgrades during this construction project. Other aspects of building upgrade were also addressed such as plumbing, electrical wiring and heating and hot water.

#### Pros and Cons

The solution ensures a good bond or contact with the masonry wall, and certainty of no cold spots or missed areas. However, it is invasive and requires the removal of most services. The measure has worked well following occupancy.

#### Type of Data Available

The material supplier carried out a condensation/moisture risk assessment using the Glaser method. While the installer had done work like this on new build properties, this was a new method of insulation for an older building.

#### Is there any related publication?

[https://www.hiberatlas.com/smaredit/projects/207/Case Study 4 - Sword Street, Glasgow; Internal wall insulation to six tenement flats.pdf](https://www.hiberatlas.com/smaredit/projects/207/Case%20Study%204%20-%20Sword%20Street,%20Glasgow;%20Internal%20wall%20insulation%20to%20six%20tenement%20flats.pdf)

The HES Refurbishment Case Study for the project

[https://www.hiberatlas.com/smaredit/projects/207/TP24 - Review of Energy Efficiency Case Studies \(2018\).pdf](https://www.hiberatlas.com/smaredit/projects/207/TP24%20-%20Review%20of%20Energy%20Efficiency%20Case%20Studies%20(2018).pdf)

This document summarises HES projects, many of which had work to walls.

#### Additional Link

[https://www.historicenvironment.scot/archives-and-research/publications/?publication\\_type=31&curPage=2](https://www.historicenvironment.scot/archives-and-research/publications/?publication_type=31&curPage=2)

Wall Insulation - Wet Applied Cellulose

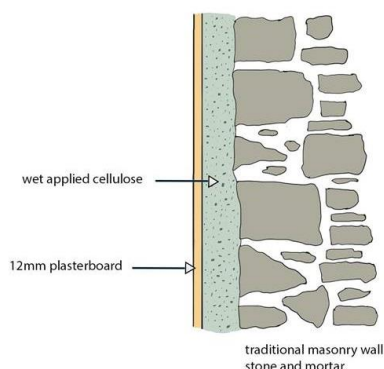

figure 16: Indicative detail showing the cellulose and the plasterboard at Sword Street © HES



figure 17: View of the tenement block at Sword Street, Glasgow © HES



*figure 18: Blowing on the wet cellulose insulation material © HES*



*figure 19: Flattening the cellulose material prior to attaching the plasterboard © HES*

### 2.2.1.7 Insulated lime plaster

Author: Roger Curtis (HES)

#### What is the solution?

Application of 2x30 mm of insulated lime plaster to the internal face of the wall. The plaster used was a pre-mixed lime plaster from Eden Lime, Cumbria which included 'perlite' beads to increase the insulation qualities. The Lambda value of the plaster is 0.113 W/mK. The value for 500 mm stone wall and 50 mm insulation is noted as 1,19 W/m<sup>2</sup>·K.

#### Wall Insulation - Insulated Lime Plaster

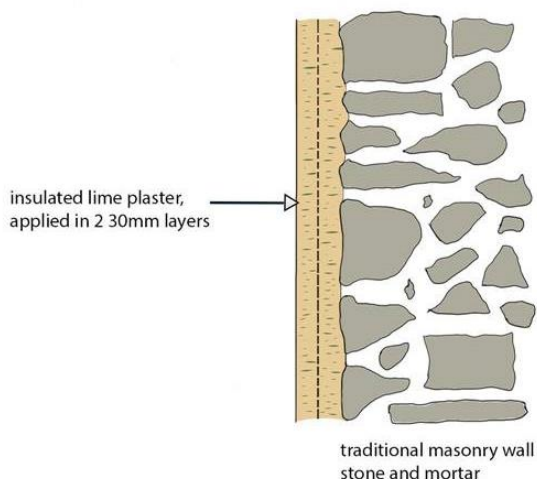

figure 20: Indicative diagram showing the insulated lime plaster on the hard © HES



figure 21: First plaster coat being applied to the wall © HES

#### Why does it work?

Lime is traditionally a common material for plaster of this kind. The material chosen was a lime plaster, which had largely fallen off. It is a vapour open and capillary active insulation option, which would allow dispersal of any liquid water and water vapour. This was finished with clay paint, to maintain the breathability throughout the whole wall thickness.

#### Pros and Cons

The original plaster was extensively damaged and needed replacing. That is why we replaced it with an insulated equivalent that was thicker and more energy efficient.

#### Additional Information

After three years of use as a holiday cottage the walls have remained dry and the building is comfortable to occupy.  
No signs of damp or condensation.

**Is there any related publication?**

<https://www.hiberatlas.com/smarteredit/projects/32/hes-refurb-case-study-22.pdf>

HES Refurbishment Case Study 22 - Downie's Cottage

**Additional Link:**

<https://downiescottage.co.uk/>

**Best practice example**

Downies Cottage - <https://www.hiberatlas.com/en/downies-cottage--2-32.html>

### 2.2.1.8 Wood fibre

Author: Eleonora Leonardi (EURAC)

#### What is the solution?

A historic stone masonry wall is insulated internally with 8 cm of wood fibre boards. The original wall was a masonry wall made of local stones with lime mortar joints (thickness of 44 cm) with historical lime plaster on both sides (inside 1,5 cm and outside 4,0 cm). The insulation boards were glued to the existing plaster with a clay adhesive mortar. A new lime plaster layer was applied on both sides of the wall (inside 1,5 cm and outside 2,0 cm).

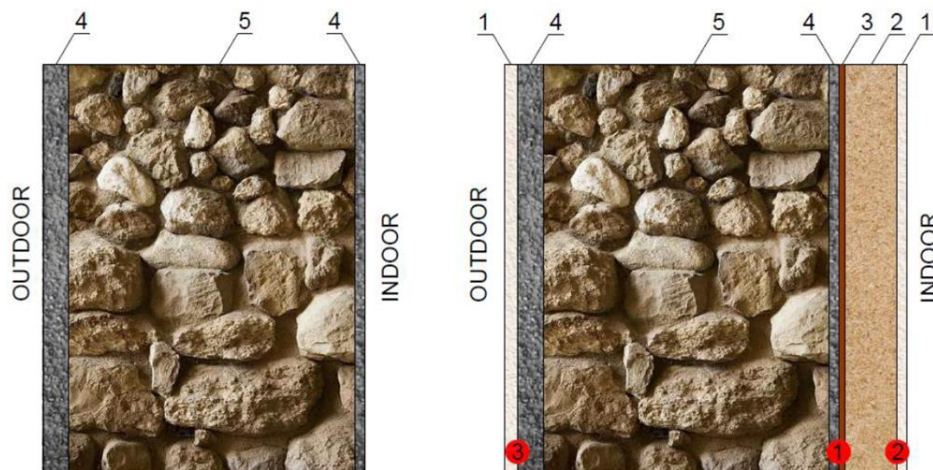

figure 22: Graphical representation of the wall build-up before (left) and after (right) the retrofit intervention. The numbers in the upper part of the figure identify the different materials: 1. New lime-based plaster; 2. Wood fibre insulation; 3. Clay adhesive mortar; 4. Historical lime plaster; 5. Existing stone wall. The red circles indicate the position of the combined temperature and relative humidity sensors installed on site. © Izabela Nicoleta Codreanu

#### Why does it work?

The solution is compatible with the historical wall in terms of visual and material aspects. Both the external and internal aspects of the wall did not change (same plaster colour), as well as the external proportions of the facade. The building is not listed but the owner was convinced about the importance of preservation, that is the reason why they decided to do internal insulation. The use of a new external plaster was necessary anyway for maintenance reason. The solution was hygrothermally assessed by means of simulations. The U-value is improved from 2.4 to 0,4 W/(m<sup>2</sup>K) (the values are calculated assuming a  $\lambda$  value of 2.3 W/(mK) for the masonry stone wall and a  $\lambda$  value of 1,0 W/(mK) for the historical lime plaster).

#### Description of the context

The solution was installed in an historical rural house from the seventeenth century. It is located in Settequerce in South Tyrol, altitude of 247 m above sea level. The climate is humid subtropical with hot summers and very cold winters by Italian standards.

#### Pros and Cons

The wood fibre is based on a natural material; thus, it is more prone to deterioration. This solution is a vapour open system. These systems are a little bit more tolerant to external moisture sources (driving rain or rising damp) but they need experience in installation because the insulation must be totally adherent to the existing wall. Although the system is more tolerant of moisture removal, the basic problems of driving rain, rising damp and airtightness must be solved, otherwise even these systems quickly reach their limits.

#### Type of Data Available

Some simulations are available for this solution. Additionally, the solution was monitored on site (temperature and humidity sensor inside the wall, internal temperature and relative humidity, ambient temperature, outside surface temperature, ambient relative humidity, global radiation and driving rain on the wall surface).

#### Additional Information

The hygrothermal performance of wood fibre insulation highly depends on the bonding coat and the interior plaster used in the system, not only on the insulation material itself. In exposed areas, an in-depth evaluation of the case

considering driving rain, existing wall material and thickness is required. The evaluation of this solution must be done by means of hygrothermal simulations as for any other internal insulation material.

### Is there any related publication?

[https://www.hiberatlas.com/smarteredit/projects/136/Tesi\\_Codreanu\\_small.pdf](https://www.hiberatlas.com/smarteredit/projects/136/Tesi_Codreanu_small.pdf)

Hygrothermal analysis of an historical building: a real case study application based on dynamical simulation and monitoring data, Master Thesis, 2019, Izabela Nicoleta Codreanu



figure 23: Installation of wood fibre  
© Eurac



figure 24: Front of the building pre-  
renovation © Eurac



figure 25: Side of the building pre  
renovation © Eurac



figure 26: Detail of the building pre  
renovation © Eurac



figure 27: Front of the renovated  
building © René Riller



figure 28: Back of the renovated  
building © René Riller



figure 29: Detail of the front of the  
renovated building © René Riller

### 2.2.1.9 Insulated lime plaster with cork

Author: Athina Petsou (UCL)

#### What is the solution?

The solution is capillary active internal wall insulation made of clay, diatomaceous earth, natural hydraulic lime NHL 3.5 and cork. The insulation is supplied in bags, and can be installed to the internal side of the wall as a wet plaster (suitable for the insulation of small areas) or with a spray equipment. For this solution, a finer wet plaster is the interior finish.



Figure 30 Spray application of insulated lime plaster © Ecological Building Systems



Figure 31 Insulated wall (lime plaster and cork) © Ecological Building Systems

#### Why does it work?

The aim of the solution is to improve the thermal resistance of a wall. It allows to retain the external appearance of the wall and preserving the external façade, as it is applied to the internal wall. In some historic buildings, there is a reduced extent of rainwater protection, allowing rainwater penetration and moisture accumulation within the wall. In this solution, the risk of moisture accumulation is reduced because the insulation is vapour open and capillary active, allowing the drying of excess moisture.

#### Description of the context

The solution can be installed in historic buildings that do not have interior surfaces of heritage significance, and in buildings in conservation areas. The original internal surface of the wall should not have decorative elements or elements of historical significance. The solution can be also used for surfaces that are uneven or not flat, or for small sections of wall areas where boards would not fit (for example window reveals).

#### Pros and Cons

The pros are the energy improvements ( $\lambda = 0,045 \text{ W/mK}$ ) with low moisture risks and good compatibility. The reversibility of the solution is medium; no mechanical fixings are required, but any decorative original internal surface of the wall is lost as it is fully bonded to the plaster. The full bonding minimizes the risk of mould growth at interfaces and allows water redistribution from the existing wall. The solution does not require the levelling of the original wall. The cons are the long installation process (more than one coats are necessary) and drying process (the wet plaster requires time to dry out – especially for high thicknesses). Drying of construction moisture must be allowed before the building is occupied, as this process could lead to temporarily high indoor moisture and develop mould growth on furniture.

### 2.2.1.10 Dense wood fibre

Author: Athina Petsou (UCL)

#### What is the solution?

The solution is capillary active internal wall insulation made of dense wood fibre. The insulation is supplied in boards, which are installed to the internal side of the wall with an even bonding coat and additional thermally-broken mechanical fixings. The bonding coat is made of lime plaster, and another layer of lime plaster is applied as interior finish. If plasterboard is preferred to wet plaster, some boards allow plasterboard screws for dry fit installation.

#### Why does it work?

The aim of the solution is to improve the thermal resistance of a wall. The solution allows to retain the external appearance of the wall and preserve the external façade, as it is applied to the internal wall. In some historic buildings, there is a reduced extent of rainwater protection (especially in walls with exposed brick), allowing rainwater penetration and moisture accumulation within the wall. In this solution, the risk of moisture accumulation is reduced because the insulation is vapour open and capillary active, allowing the drying of excess moisture.

#### Description of the context

The solution was installed in historic buildings that did not have interior surfaces of heritage significance, and in buildings in conservation areas. The original internal surface of the wall should not have decorative elements or elements of historical significance.

#### Pros and Cons

The pros are the energy improvements with low moisture risks and good compatibility. The full bonding minimizes the risk of mould growth at interfaces and allows water redistribution from the existing wall. The cons are the low reversibility (mainly due to mechanical fixings) and the long installation process, as it requires a flat wall to have full contact between wall and board.

#### Additional Information

The hygrothermal performance of wood fibre insulation highly depends on the bonding coat and the interior plaster used in the system, not only on the insulation material itself. In exposed areas, an in-depth evaluation of the case considering driving rain, existing wall material and thickness is required. The evaluation of this solution must be done by means of hygrothermal simulations as for any other internal insulation material.

#### Type of Data Available

The solution was monitored on site for two years (temperature and humidity sensor inside the wall, internal temperature and relative humidity), showing drying of construction moisture and safe moisture levels.

#### Is there any related publication?

<https://www.hiberatlas.com/smaredit/projects/266/Marincioni,%20Altamirano-Medina%20-%202014%20-%20Effect%20of%20orientation%20on%20the%20hygrothermal%20behaviour%20of%20a%20capillary%20active%20internal%20wall%20insulatio.pdf>

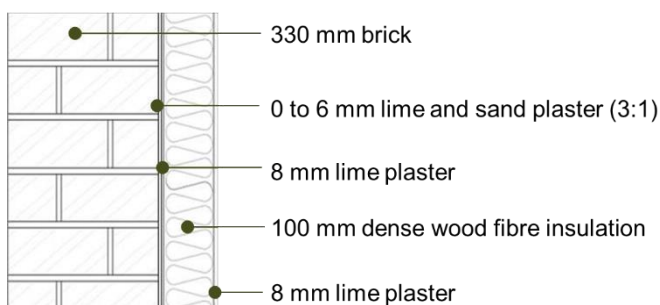

figure 32: Cross-section of insulated wall © UCL



figure 33: Internally insulated wall, front and rear elevation © UCL



### 2.2.1.11 Nanoporous Aerogel insulating blanket

Author: Evola Gianpiero (Unict), Alessandro Lo Faro (Unict)

#### What is the solution?

The solution is a flexible 10 mm nanoporous Aerogel blanket in the "Palazzo San Guiliano". The blanket is applied at the internal side of an existing wall made of blocks of local lava stones mixed with lime mortar, situated in a historic building from the 1700s. The installation is finished by a 12.5 mm plasterboard sheet.

#### Why does it work?

The solution is compatible with conservation issues, since the facades are not altered. Moreover, the small thickness of the boards (22.5 mm overall) does not significantly modify indoor volumes and net surfaces. Moisture safety is slightly worsened. However, according to numerical calculations, in warm climates like in Southern Italy the wall still does not experience moisture accumulation. The U-value is reduced by 33%, while the overall heat losses through the building envelope can be reduced by 21%, also thanks to the correction of the thermal bridges.

#### Description of the context

The building is situated in the historical centre of Catania (Latitude 37°30'4"68 N, Longitude 15°4'27"12 E; 833 Heating Degree Days; Climatic zone B). The historical centre of Catania is characterized by wide roads in the North / South and East / West direction interrupted by squares. The buildings that exist on these axes occupy entire blocks. Moving away from the roads, the size of the urban fabric becomes smaller and reflect the structure already existing in Catania before the earthquake of 1693, which destroyed the city. The construction of the "Palazzo San Giuliano" began in 1695 and finished in 1861. It arose as an aristocratic palace and now is used as an office location.

#### Pros and Cons

Pros: compatibility with the architectural and historical value of the facades, small insulation thickness thanks to the very low thermal conductivity of the nanoporous Aerogel insulating blanket, energy savings, reversible and dry solution, easy application.

Cons: potential indoor summer overheating, high costs of the insulating boards, higher risk of moisture accumulation in the wall.

#### Type of Data available?

The U-value of the existing wall has been measured through a heat-flux meter, based on the Standard EN ISO 6946 ( $U = 0,67 \text{ W}/(\text{m}^2 \text{ K})$ ). Starting from this measured U-value and adding the thermal resistance of both the 10 mm Aerogel blanket ( $\lambda = 0,014 \text{ W}/(\text{m K})$ ) and the plasterboard (12.5 mm,  $\lambda = 0.2 \text{ W}/(\text{m K})$ ), the expected final U-value of the insulated wall is  $U = 0,45 \text{ W}/(\text{m}^2 \text{ K})$ . Then, numerical 2D steady-state simulations, performed with Therm 7.7, allowed quantifying the effect of thermal bridges before and after the proposed solution. According to the numerical simulations, the most significant thermal bridges are those at the intersection between the outer walls and the windows, and those at the intersection with the outer walls and the balconies. Apart from the reduction of the U-value, the proposed solution reduces by 37.5% the heat losses through the thermal bridges.

#### Additional Information

It is not easy to know exactly the composition of a thick wall built over three centuries ago. Based on surveys on other similar buildings from the same period and the knowledge of traditional techniques of the Etna territory, it is possible to guess the following approximate distribution: 67 % basaltic blocks, 16 % small mixed basaltic stones, 17 % lime mortar and basaltic aggregate (so called azolo). However, due to the random arrangement of the different materials, the presence of numerous small air cavities is highly probable, which justifies the relatively low U-value resulting from the experimental measurements. This suggests that the U-value might significantly change for different walls in the same building according to the different constructive technology.

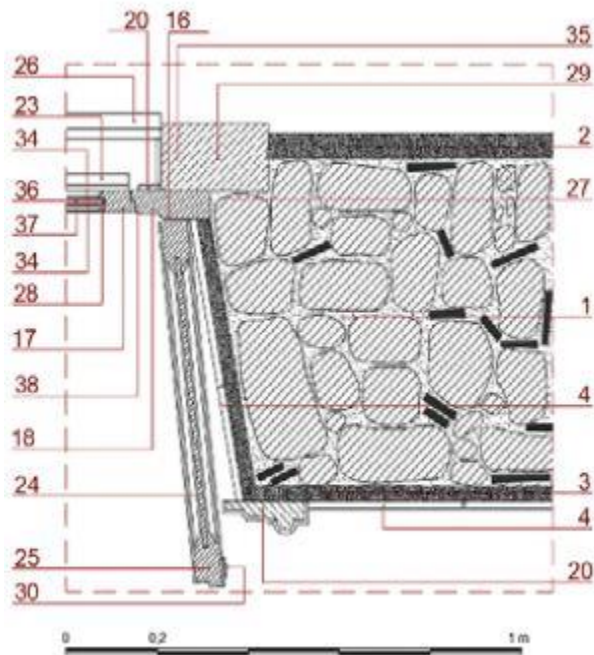

1. Masonry in basaltic block with lime mortar and volcanic aggregate
2. External plaster
3. Internal plaster
4. Marble skirting
16. Door hinge
17. Hanging stile
18. Hanging jamb
20. Internal frame of chestnut wood
23. Drip tray
24. Internal wooden door
25. Internal wooden door
28. Glazing bead in wood
29. Stone frame in limestone
34. Glazing 4 mm
36. Spacer
37. Air gap 6 mm

figure 34: Cross section of the wall, copyright: Unict



figure 35: Palazzo San Giuliano, copyright: Unict

### 2.2.1.12 Wood fibre board between frames, calcium silicate board onto masonry

Author: Roger Curtis (HES)

#### What is the solution?

This is suitable when there are no internal linings and the walls are masonry. There are two different solutions in this project. Three walls were insulated with wood fibre board between vertical timber battens. The wood fibre board was pressed against the masonry, with a small air gap where the wall was not entirely flat. This was finished with plasterboard and clay paint. The calcium silicate board was used on the last wall, which had previously been plastered on the hard. The boards were attached using an adhesive mortar layer and finished with plaster and clay paint.

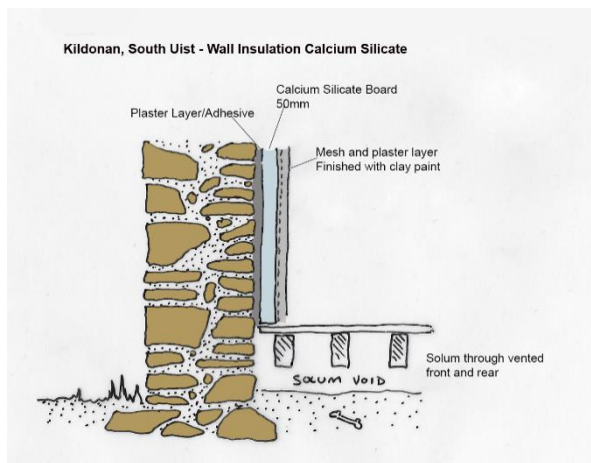

figure 36: Indicative diagram for the calcium silicate board © HES

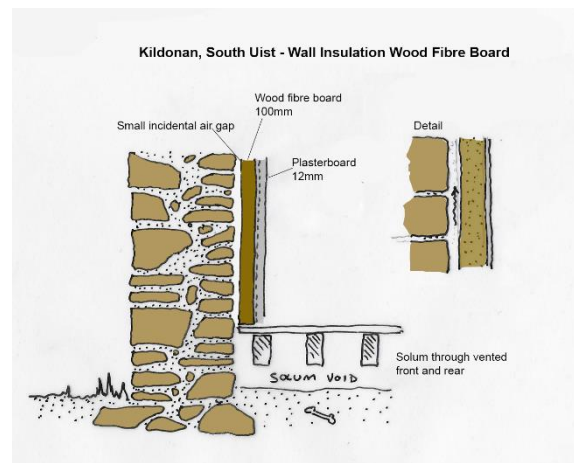

figure 37: Indicative diagram for the build-up of the wood fibre board insulation © HES

### Why does it work?

This solution was only suitable where there are no historically significant interior decorations on the wall. The materials are vapour and capillary active and allow the moisture transfer through the walls, even without an air gap. The wood fibre insulation has a thickness of 100 mm and improved the U-value from 2,1 W/(m<sup>2</sup>K) to 0,4 W/(m<sup>2</sup>K). Since wood fibre board is not completely vapour open, it is important to consider the impact of driving rain and similar high moisture scenarios. The calcium silicate board has a thickness of 50mm, with a lambda value of 0,059 W/mK and reduced the U-value to 1,0 W/(m<sup>2</sup>K).

### Description of the context

This trial was done in a rural cottage at Kildonan on South Uist, built around 1935 out of whinstone rubble and with a cement render. The building had been empty for a while before and during the refurbishment. Due to the impervious building stone and cement render, there was significant moisture build up in the interiors, enabling the insulation materials to be tested in relatively extreme conditions.

### Pros and Cons

This solution provides significant improvements to the walls. The calcium silicate board resulted in a higher u-value, and this insulation material was only half as thick as the wood fibre board resulting in less loss of living space compared to the wood fibre solution. The installation is invasive and does result in some loss of interior space due to the thickness. It also requires the removal of previous wall finishes.

### Type of Data available?

U-value assessment has been done before and after the refurbishment, showing that the walls have been reduced from 2,1 W/(m<sup>2</sup>K) to 0,4 W/(m<sup>2</sup>K) where wood fibre board has been used and to 1,0 W/(m<sup>2</sup>K) where calcium silicate has been used.

### Is there any related publication?

[https://www.hiberatlas.com/smartedit/projects/264/Case Study 6 - Kildonan, South Uist; Upgrades to a 20th C Cottage.pdf](https://www.hiberatlas.com/smartedit/projects/264/Case_Study_6_-_Kildonan,_South_Uist;_Upgrades_to_a_20th_C_Cottage.pdf)

<https://www.historicenvironment.scot/archives-and-research/publications/publication/?publicationId=62dee846-2f4e-4674-8879-a59300ff84fa>



figure 38: A finished wall with the wood fibre board insulation © HES



figure 39: The thickness of the wood fibre insulation against the whinstone wall © HES



figure 40: The thickness of the calcium silicate board © HES



figure 41: The almost completely insulated wall using calcium silicate board © HES

## 2.2.2 Systems with membranes acting as vapour control layers

### 2.2.2.1 Mineral wool with vapour control layer- Solution 1

Author: Eleonora Leonardi (EURAC)

#### What is the solution?

In this example all walls except the western facade were internally insulated. XPS was used in the lower part and placed all around the perimeter in direct contact with the floor insulation. From about half a meter upwards 14 cm thick mineral wool panels (FLUMROC Compact) form the main insulation layer. The following OSB panel serves as support for the vapour barrier ( $s_d > 100$  m), special attention was paid to seal all joints with tape. At the junction with the ceiling, the vapour barrier of the wall and the vapour retarder ( $s_d = 2.0$ ) of the ceiling were overlapped and taped. All wet piping, electrical wiring and ductwork is placed in the 4 cm thick installation layer - resulting in a total of  $14 + 4 = 18$  cm of insulation and no installation breaking through the vapour barrier. The internal surface was finished with 2.5 cm plasterboard. In the bedroom (west façade), instead of mineral wool insulation, wood fibre boards were used.

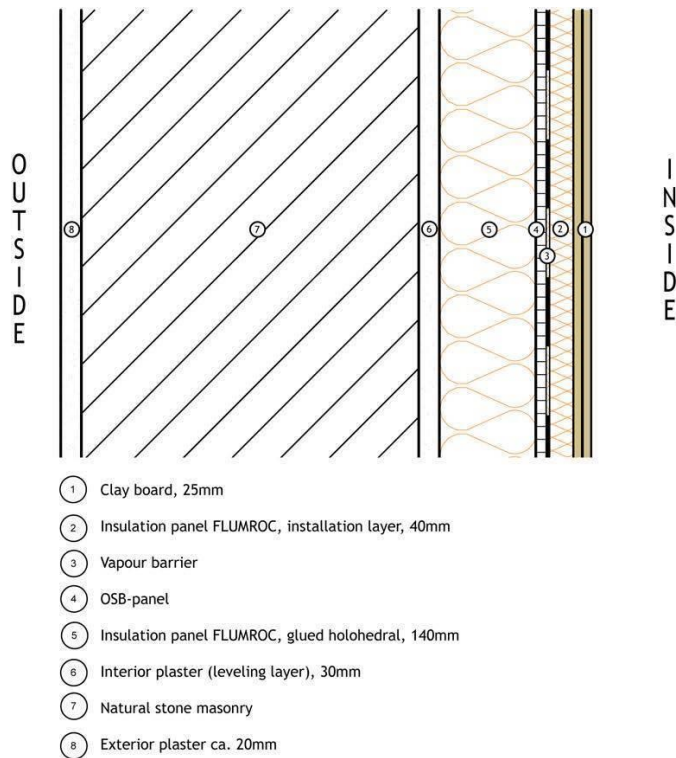

figure 42: cross section of the wall

### Why does it work?

The external proportions of the building had to be kept the same, thus the choice of internal insulation. The thick internal insulation layer brings to consistent energy savings. The system uses mineral wool with a vapour barrier. The vapour barrier reduces the vapour diffusion and the airtight layer make sure that no convective moisture transport can happen. Special attention has been given to preventing thermal bridges. Where partition walls abut outside walls, wherever possible, the internal wall was cut and insulation placed vertically against the wall. Where new partition walls were built up, interspaces to the external wall were left in order to place insulation, OSB-boarding and vapour barrier behind. However, in some situations the wall was a bearing one and thus could not be cut. Therefore, insulation on the border had to be applied. In one corner an old chimney was found – and by insulating that internally the supplementary insulation along the partition wall could be avoided. The elimination of thermal bridges was not always possible: in the bedroom an arch as separating and supporting element could neither be cut nor insulated alongside. Internal insulation and vapour barrier were brought there until the borders of the arch and finished with plaster. A sensor for temperature and humidity is monitoring this potentially critical point.

### Description of the context

The main building of "Ansitz Kofler" was built in 1749. The Orangerie was added a bit later: a 30 m long and 5 m wide structure with spacious and bright rooms, used for breeding tropical fruits - for which the climate in Bozen, even if south of the Alps, would otherwise have been too harsh. In 1925 the Orangerie was converted to a dwelling: the windows were scaled down, and internal partition walls were added, forming a suite of rooms aligned with each other (so called enfilade). As typical for buildings of this age in Bozen, the loadbearing structure is stone masonry, with stones of different size, taken from the rivers in the area.

### Pros and Cons

The main advantages of this solution are: use of materials that are well established in the market; the design foresees a service layer that prevents accidental damages and punctures of the vapour control layer. The main disadvantages, as the most internal insulation with vapour control system, is the need of reliability on execution of the vapour control layer; the thermal bridges are difficult to prevent and require a special attention in the design. Another disadvantage of this solution is the use of non-natural/original materials.

### Type of Data Available

The building is very well documented, plans and pictures are available. The building is monitored within a research project, a vast amount of monitoring data is available, including hygrothermal performance of the construction. The building was monitored for one year.

### Additional Information

Monitoring results: a solution with vapour barrier ( $s_d > 100 \text{ m}$ ) was opted for the owner and architect at Anstiz Kofler aimed at an insulation thickness that was considerably higher than the  $\sim 8 \text{ cm}$  capillary active insulation – usually assumed safe at that time in practice. Accordingly, high effort was put in avoiding any potential failure: any penetration of the vapour barrier was avoided (4 cm installation layer), sealing tapes were applied with care, a blower door test was done after preliminary installation to attest airtightness in a phase where they could still intervene etc. The monitored data indicate safe conditions. The first image on the T profile shows that indoor surface is slightly colder than indoor air, temperatures before and after the vapour barrier are practically identical, the major temperature difference was observed along the main insulation ( $\Delta A1.4\text{-}A1.5$ ), and nearly no temperature difference was observed along the ancient stone wall ( $\Delta A1.5\text{-}A1.6$ ) – interesting to see that main effect of the stone wall is to level out daily variations. A look at the absolute humidity ( $\text{g/m}^3$ ) demonstrates the effective operation of the vapour barrier: while indoors it varies between 7-8  $\text{g/m}^3$  – measured values of the air and inside the construction before the barrier being very similar – outdoors it is generally about 2  $\text{g/m}^3$  lower.

### Best practice example

Anstiz Kofler, <https://www.hiberatlas.com/de/ansitz-kofler--2-25.html>



figure 43: Plaster Boards ©Eurac



figure 44: Internal insulation in the sleeping room: wood fibre ©Eurac



figure 45: Internal vapour barrier ©Eurac



figure 46: Internal insulation (mineral wool) and OSB ©Eurac



figure 47: Vapour Barrier and ceiling ©Eurac



figure 48: Installation layer ©Eurac



figure 49: Building after renovation © Eurac

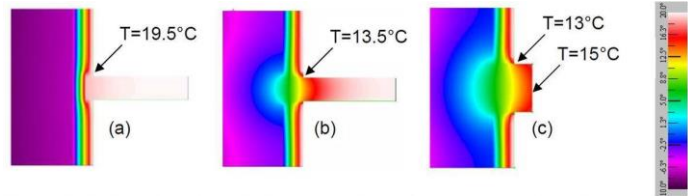

Figure 5. 2-dimensional simulation of partition wall abutting outside wall with Therm 5.2 for (a) thermal division (b) no thermal division and (c) special situation at the arch.

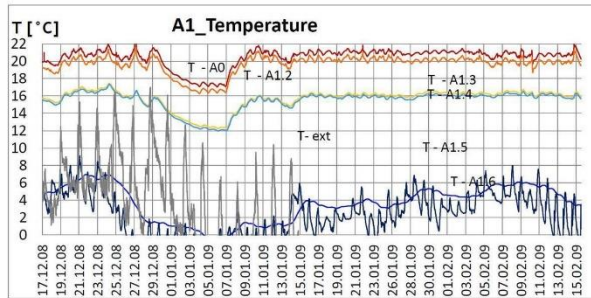

figure 51: Monitoring system: construction's temperature ©Eurac

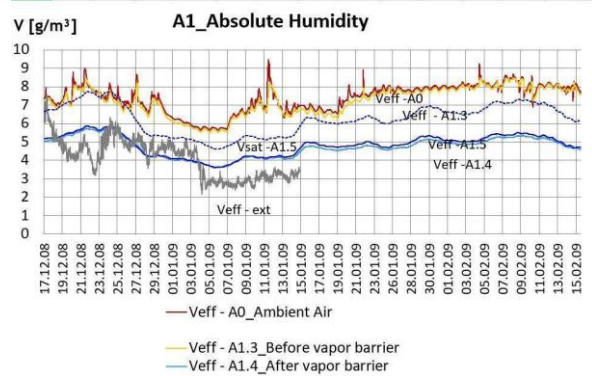

figure 52: Monitoring system: construction's absolute humidity ©Eurac

### 2.2.2.2 Mineral wool with vapour control layer - Solution 2

## Internal Insulation – Mineral wool with vapour barrier solution 2 – Doragno Castle Rovio, Switzerland

Author: Cristina Polo (SUPSI)

### What is the solution?

The restoration project started from the right premise of completing what remained of the walls of the tower of the ancient Castle of Rovio to return the shape so that in the surrounding landscape the building of the past once again became legible. For this reason and to achieve a high energy efficiency standard the stone were insulated from 100 mm of e thee that gives an air gap of 30 mm. A vapour barrier to prevent mould is used together with the mineral wool insulation layer.

### Why does it work?

The intervention safeguards the external appearance of the building by further enhancing its appearance. From the energy point of view, this solution allows to reach a low transmittance and the choice of vapor permeable materials guarantee a passage of humidity without particular problems.

### Description of the context

The project aims to restore the soul of the castle, by demolishing the works made in the 20th century and using new glazed surfaces. Doragno Castle is now a private residence building, a historic not-listed building in Ticino, that after be renovated achieved a high standard energy efficiency by using also solar energy. In this project the architects have re-created the shape of the castle using modern materials considering today's comfort standards and it was chosen to preserve as much as possible the medieval walls of the ancient building and to preserve only

the shell of the original building joining old and modern facilities, with the support of new and innovative technical solutions.

### Pros and Cons

No executive difficulties, no difficulty in selecting materials; the only negative factor with respect to external insulation, as is known, is the impossibility of eliminating thermal bridges at the floors.

### Additional Information

To increase comfort of users and to minimize cost the selection of technical solutions must consider local climate conditions. The climate in this area is classified as Cfb: Temperate oceanic climate (Köppen climate type), characterized by a temperate climate, without dry season, with warm summer. the coldest month averaging above 0 °C (32 °F), all months with average temperatures below 22 °C (71.6 °F), and at least four months averaging above 10 °C (50 °F) with no significant precipitation difference between seasons. This climate characteristics implies that is very important to consider overheating in summer than cold in wintertime. The insulation was placed inside the building to respect the ancient stone walls of the castle even though thermal inertia to stabilize temperatures in summer would have been desirable in this climate. It should also be considered that it is a secondary residence, and the building is not permanently habited.

### Is there any related publication?

Several information is published regarding this project and is available in the in the architect's web page and projects documentation, DeltaZero SA: <https://www.deltazero.net/en/what-2/6-icon-projects/doragno-castle/>

Maria Mazza & Stefano De Angelis Effrem, deltaZERO Architettura, Il Castello di Doragno, Restauro e sostenibilità energetica, Archi magazine, Rivista svizzera di architettura, ingegneria e urbanistica. August 004, 2020. Pages: 26-29. Publisher: espazium. ISSN 1422-5417. [https://www.espazium.ch/it/archi4-20\\_castello](https://www.espazium.ch/it/archi4-20_castello)

Mazza M., Intervenire su edifici storici, TuttoCasa Magazine, | 04-2017, pg.37-41, [Internet]. 2021; Available from: [https://www.hiberatlas.com/smarteredit/projects/28/TuttoCasa\\_17-05\\_Intervenire\\_su\\_edifici\\_storici.pdf](https://www.hiberatlas.com/smarteredit/projects/28/TuttoCasa_17-05_Intervenire_su_edifici_storici.pdf)

### Additional Link

<https://www.deltazero.net/wp-content/uploads/2018/09/20-Intervenire-sugli-edifici-storici.pdf>

### Best practice example:

Doragno Castle, <https://www.hiberatlas.com/en/doragno-castle-rovio-ticino-switzerland--2-28.html>

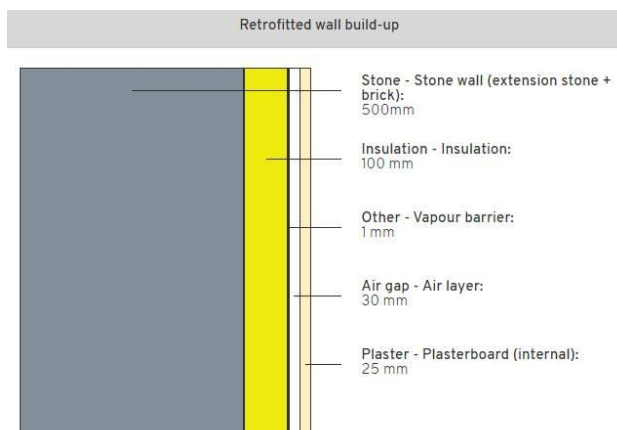

figure 53: Retrofitted wall build-up



figure 54: During works: on the right metal profiles for fixing plasterboard © DeltaZero



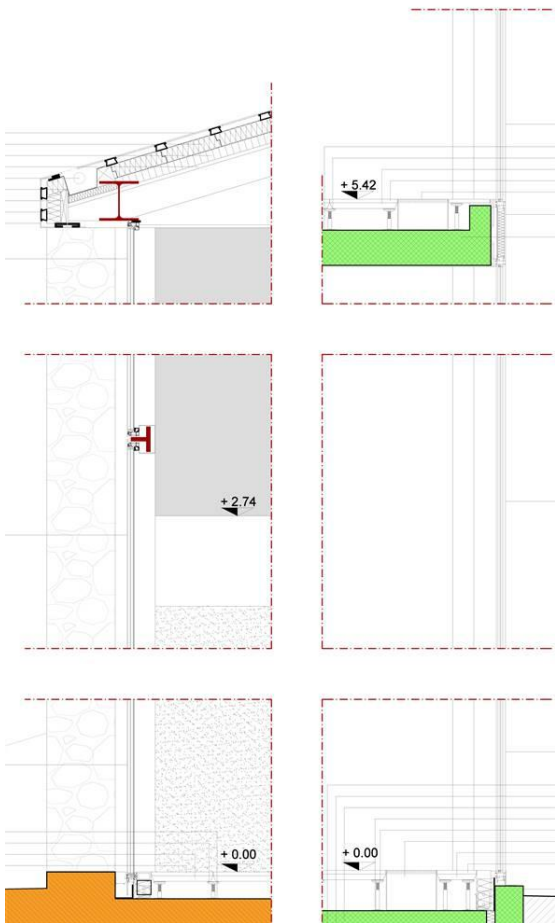

figure 55: Cross section with Glass © Delta zero

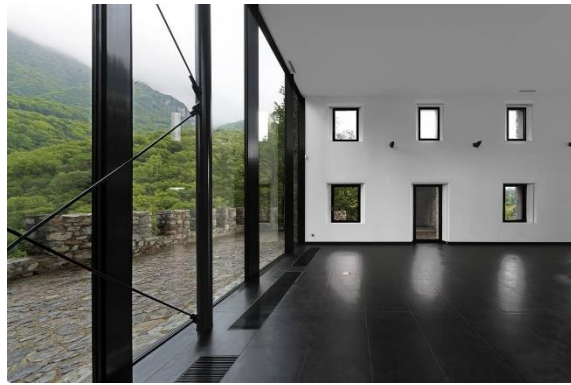

figure 56: External walls © L. Carugo



figure 57: Stone external walls © L. Carugo

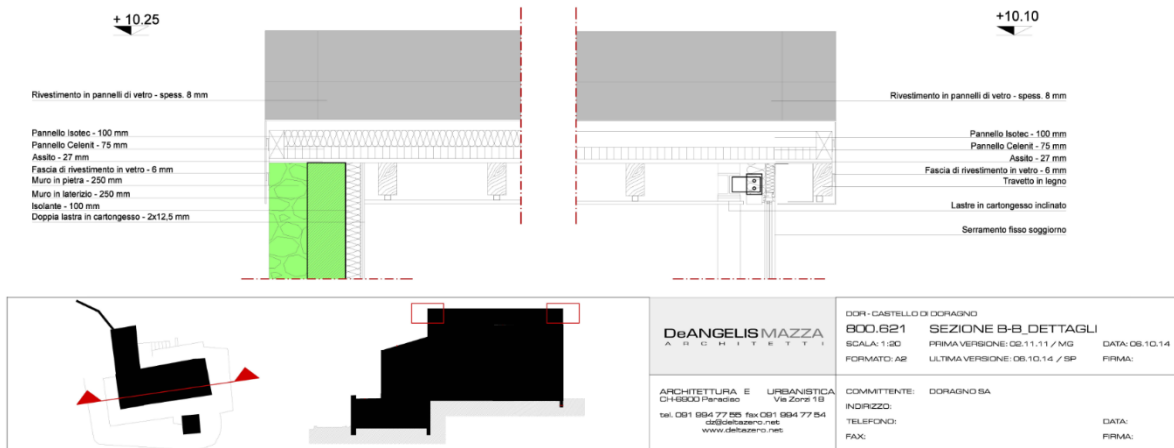

figure 58: Cross section, © Delta zero

### 2.2.2.3 Mineral wool with vapour control layer – Solution 3

## Reinforced concrete plus mineral wool insulation - PalaCinema Locarno - Locarno, Switzerland

Author: Cristina Polo (SUPSI)

### What is the solution?

The original structure has been largely maintained as far as the outer ring of the building is concerned, while the central part has been demolished to make room for the new spaces of the building with that change the use completely. The new building rises reusing the pre-existing structure of the Palazzo Scolastico in Piazza Remo Rossi in Locarno, Switzerland to be reconverted in the new PalaCinema, a multicultural platform for the cinematic arts located in the historical centre of the city. The new core of the building was inserted inside the old building by fortifying the external existing plastered stone walls (60 cm thick) with an additional 30 cm thick of reinforced concrete structure, thermally and internally insulated with 18 cm of mineral wool. In addition to this insulation, a vapour control layer and a drywall (type Knauf, double plate) of 1.25 cm were placed from the inside.

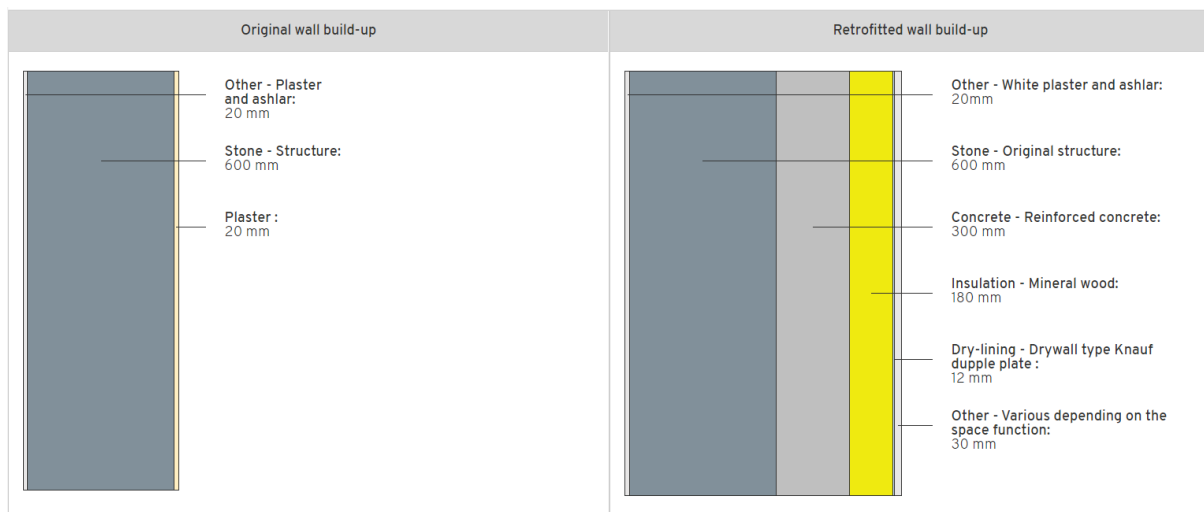

figure 59: Cross section before and after the intervention

### Why does it work?

The building has been kept safe and preserving the original façades of the School building adding a new concrete façade to support the structure of the complex new building that contains very diaphanous spaces with great span cantilevered structure (theatre and cinema rooms). Then it has been internally insulated with 18 cm on the new concrete structure. The minimum thickness necessary to reach the Minergie standard has been inserted, with the purpose to lose as little internal space as possible. Minergie® Certification for low energy consumption buildings is the Swiss brand that certifies the sustainability of new or redeveloped buildings. This way the original façade remains exposed. As regards the renovation of the external surface, measures have been taken to allow images to be projected onto the façade. For this reason, the plaster onto the original external stone walls of the main façade has in fact been carried out entirely in white. Initially the entire surface, including the ashlar, was to be plastered, but for conservation reasons this was not allowed. The intervention is already very invasive and completely covering the original façade would have ruined the intention of keeping part of its original expression alive.

### Description of the context

The PalaCinema new building is a multicultural platform for the cinematic arts located in the historical centre of the city of Locarno in Ticino (Switzerland). The city hosts the Locarno Film Festival, so this centre is of particular importance. The building rises reusing the pre-existing structure of the Palazzo Scolastico in Piazza Remo Rossi. This building is now a landmark in the city, in the shores of Maggiore Lake. The old part and the new part are clearly separated, with the new part leaning on the historical one. The centre houses 3 cinema halls and spaces for outdoor events. The Palazzo del Cinema Locarno project has been guided by principles of economy, trying to capitalise in the existing structure and the public affection for the old building Palazzo Scolastico to host a variety of NGOs and community associations. Three levels of action to reduce the emissions have been considered: demand reduction, improved energy efficiency of systems and improved building management.

## Pros and Cons

The solution allows to show also externally and scenically the function of the building and the importance of the Locarno film festival, projecting images on its surface. On the other hand, the risk of completely covering the original appearance of the building was too high, in fact in the end the surface is not completely white but keeps the original grey ashlar and the various frames on display. Reinforced concrete plus mineral wool insulation is very fire resistant and can act as a fire stop. Mineral wool is hydrophobic, so it will not absorb water or encourage the growth of mould and mildew. However, like many building materials, mineral wool also has its drawbacks because tends to be more expensive than other insulation types (e.g., 25-50% higher in cost with respect for example to fiberglass).

## Type of Data Available

Only cross-section drawings and photos provided by architects AZPML.

## Additional Information

The extension of the building concerns the addition of an upper floor (besides the "filling" of the internal courtyard). The original pitched roof is therefore in no way recovered. The roof is part of the extension of the building, so it is part of the new volume which is completely different and stands in contrast to the restored part. Its appearance and construction system therefore have no connection with the old building. The new facade in the upper part of the building is made outside of a light metal structure, with a kinetic facade structure held by steel cables for fixing the stainless steel movable gold-plated elements (10x10 cm/0.8 mm).

## Is there any related publication?

PALACINEMA, LOCARNO Wie ein Palast aus der Asche, Real estate and energy. Nr. 1/N° 1 2018 (Ed. spazio), p. 35-37. Special issue spazio - Editions for the culture of construction. Attachment to TEC21 n. 46/2018, TRACÉS n. 23-24 / 2018 and Archi n. 6/2018

<https://spazio.s3.eu-central-1.amazonaws.com/files/migration/documents/5bf7a9347396d.pdf>

Luoghi e architetture del cinema, Archi n. 4/2018, ISSN 1422-5417.

<https://spazio.s3.eu-central-1.amazonaws.com/files/migration/documents/5b5eccb2676d1.pdf>

Articles (Italian):

- Le architetture per il Festival del Film di Locarno 1946-2018 Gabriele Neri, p. 29-38
- PalaCinema: ieri, oggi, domani. Interview with Carla Speziali, p. 46-47
- Un commento sul concorso per il Palazzo del Cinema a Locarno, Paolo Fumagalli, p. 48-49
- PalaCinema, Locarno, AZPML Architects, p. 50-57

Palazzo del Cinema a Locarno, in Archi n. 4/2018 (Digital) <https://www.spazio.ch/it/attualita/palacinema-locarno>

<https://spazio.s3.eu-central-1.amazonaws.com/files/migration/documents/5bf7a9347396d.pdf>

## Best practice example:

PalaCinema Locarno - Locarno, Switzerland, <https://www.hiberatlas.com/en/palacinema-locarno-locarno-switzerland--2-254.html>



figure 60: Building façade pre-intervention. © AZPML



figure 61: Side-façades before and after intervention. © AZPML



figure 62: Main façade after renovation and during works © G. Marafioti

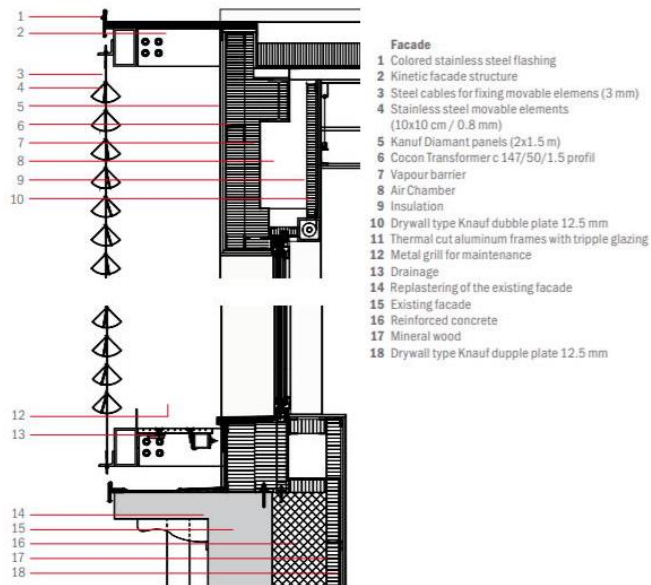

figure 63: Main front façade after renovation. © G. Marafioti

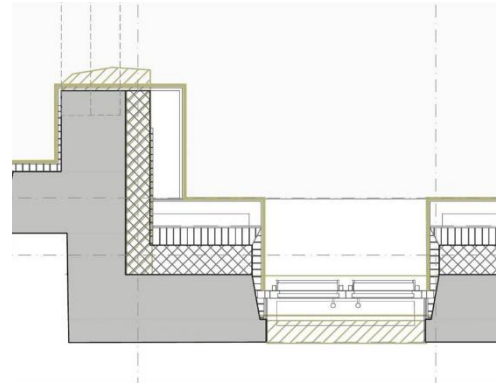

figure 64: longitudinal section of the connection between the core (building main facade) and the adjoining side facades. © AZPML

### 2.2.2.4 Cellulose for log wall

Author: Alexander Rieser (UIBK)

#### What is the solution?

A possible solution to refurbish a wooden block wall to passive house standard is to apply a 22 cm thick cellulose insulation. The insulation is blown into the cavity between the stock log wall and the internal wooden construction. In order not to create any cavities in the insulation layer and to avoid subsidence of the insulation afterwards, it is important to blow the cellulose with sufficient pressure. The inner end of the hollow box is formed by an OSB board (Norbord), which also has the function of an airtight layer and a vapour control layer. The OSB board is screwed onto wooden T-beams (Steico company) and all butt joints are glued with airtight strips. With a board thickness of 15 mm, the OSB board achieves an  $S_d$  value of 3,0 – 4,5 m. It is accordingly a diffusion-limiting interior insulation system. A wooden formwork is assembled on the OSB board, which presents the visible surface in the interior area. In order to prevent the insulation from being flushed through, a wind paper is applied to the inside of the existing block wall.

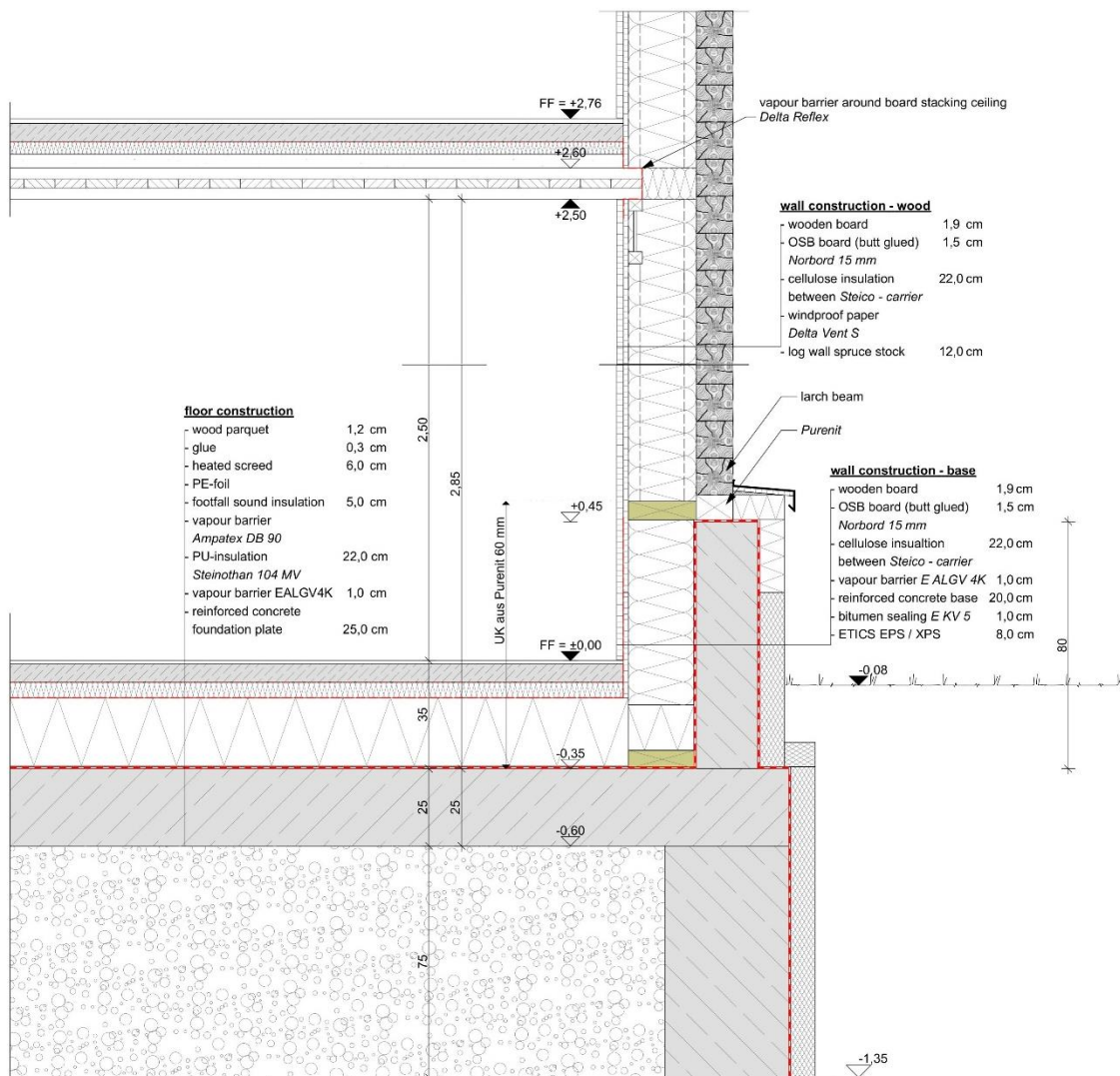

figure 65: cross section of the log wall, © Alexander Rieser

#### Why does it work?

The combination of capillary-active properties of cellulose and the reduction of vapour diffusion through the OSB board contribute to the functionality of this solution. Another essential aspect is the existing wood block wall. Due to the relatively high thermal resistance of the wooden wall, the temperature between the existing wall and the insulation is much higher compared to a solid stock wall. Another important factor is the air circulation through the wooden beams. The air exchange has a positive effect on the drying behaviour of the construction. Despite the lack

of driving rain protection on the surface of the wooden wall, a certain constructive driving rain protection is given by the surrounding balcony and a relatively high base wall, which minimizes the moisture input from outside. In order to prevent the entry of the construction moisture of the reinforced concrete structure into the wooden wall, the sealing of the floor construction was drawn over the contact area of the old wooden block wall. A moisture-resistant beam on a PUR/PIR hard foam basis (Purenit) was used as the first beam layer to exclude possible moisture damage caused by the support on the waterproofing.

### Description of the context

The 300-year-old "Hof Neuhäusl" is a prime example of the combination of old building stock and energy efficiency. While retaining its historical appearance, the building was refurbished completely in 2017. The preservation of the façade required the implementation of consistent internal insulation. Inside, the rooms were restructured in order to meet the highest, modern living standards. The aim of the renovation was to preserve the old building structure and achieve the living comfort of a passive house. To create sufficient room height, the building was undermined and placed on a reinforced concrete foundation. Due to the frame construction the loads of the ceiling can be transferred directly into the foundation and the old block building can be considered as independent and decoupled. This has the great advantage of being independent of the subsidence and the swelling and shrinking of the blockhouse.

### Pros and Cons:

The pros of this construction are the relatively simple installation and the use of a cheap insulation material. In contrast to sprayed-on cellulose, the blow-in insulation is installed completely dry and does not add any moisture to the construction. As a disadvantage, the airtight and vapour retarding layer must be mentioned. All installation in the external wall must be integrated airtight and a clean and professional installation must be meticulously carried out. In order not to penetrate this level with installation, a facing shell can be mounted in front of the OSB board.

### Type of Data Available

The wall construction was hygrothermally simulated and tested by Holzforschung Austria using the WUFI software during the execution planning. The University of Innsbruck also carried out some hygrothermal simulations with the DELPHIN software. In these simulations, different boundary conditions were varied in order to examine a susceptibility to regional differences. Furthermore, since the end of 2019, a wood moisture measurement is carried out at the farm "Neuhäusl" in Scheffau in Tyrol.

### Is there any related publication?

[https://www.hiberatlas.com/smarterdit/projects/130/Masterarbeit\\_Alexander\\_Rieser\\_Thermische\\_Sanierungskonzepte\\_für\\_landwirtschaftliche\\_Holzgebäude.pdf](https://www.hiberatlas.com/smarterdit/projects/130/Masterarbeit_Alexander_Rieser_Thermische_Sanierungskonzepte_für_landwirtschaftliche_Holzgebäude.pdf)



*figure 66: Black wind paper and frame construction for the OSB panels © DI Hans Peter Gruber*



*figure 67: View of the airtight surface (OSB board) © DI Hans Peter Gruber*



*figure 68: old log wall © DI Alexander Rieser*

### Best practice example:

Hof "Neuhäusl" <https://www.hiberatlas.com/de/hof-neuhaeusl--2-130.html>

### 2.2.2.5 Sheep wool with vapour control layer

Author: Alexander Rieser (UIBK)

#### What is the solution?

The old log wall façade was preserved as far as possible. Inside, a new 8 cm thick wall structure was created, which blends into the old walls or wooden walls like a new block. Between the old and the new building, the 6 cm thick insulation was inserted, whereby local sheep wool insulation was used as a natural building material. In order to prevent cold outside air from flushing through the insulation, a diffusion-open wind paper was installed between the insulation and the existing block wall. A vapour control layer (Ampatex DB 90) was installed on top of the insulation to reduce the ingress of moisture by diffusion. The vapour control layer has an Sd-value of 20 m.

#### Why does it work?

This challenging "house within a house" solution retains the original outer wooden log wall, while a self-supporting wooden construction with wood panelling is built from the inside. The gap between the inner and outer structure is filled with a local sheep insulation material. The soft sheep insulation is protected against driving rain by a facade membrane and from the inside by a vapour control layer. Due to the relatively low insulation thickness, there is no moisture problematic between insulation and existing wall. Furthermore, the moisture ingress is minimized by the vapour control layer. However, this layer also makes it difficult for the construction to dry out towards the interior. However, circumferential balconies and canopies reduce the probability of moisture penetration due to driving rain. Furthermore, the air leaky block wall has a positive effect on the drying behaviour of the construction due to possible air flushing, but also reduces the thermal resistance of the wooden block wall.

From an energy point of view, this solution is not outstanding, but it significantly reduces heat losses through the wall and achieves sufficient living comfort.

Due to the internal insulation, the appearance of the facade and the proportions of the building are preserved. However, a completely new image is created in the interior. By using the inner shell of the wooden block, the appearance of the original block wall is also partially restored, whereby the appearance of the patina is lost, at least for the next decades.

#### Description of the context

The Giatlahaus is a 300-year-old typical farmhouse of the region. The farm is situated in the middle of a group of 8 farms. The log construction corresponds to the local building method in the valley. For this reason, special attention was paid during the renovation to preserve the building proportions, the wooden roof with shingles, the original small windows with the old uneven glass, the block walls and balconies.

#### Pros and Cons

This solution is a synergy of protecting the historical value and improving energy efficiency. Due to the additional planning and labour involved, this solution is more cost and space intensive than a new building.

#### Additional Link:

<https://www.madritschpfurtscheller.at/projekte/projekt/giatla-apartmenthaus-in-einem-alten-bauernhaus-als-umnutzung/>

#### Best practice example:

Giatlahaus, <https://www.hiberatlas.com/de/giatla-haus--2-212.html>



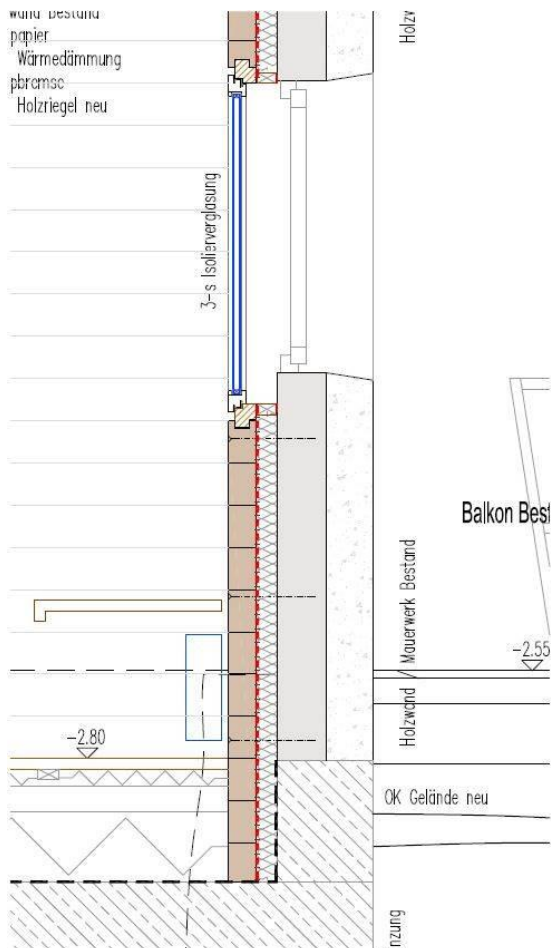

figure 69: Vertical section, © Arch. DI Reinhard Madritsch

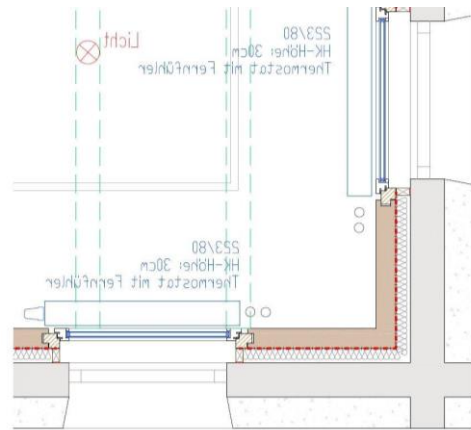

figure 70: Horizontal section, © Arch. DI Reinhard Madritsch



figure 71: Sheep wool with vapour control layer, ©Benjamin Schaller



figure 72: New block wall ©Benjamin Schaller



figure 73: View of the house, ©Benjamin Schaller

## 2.2.3 Internal Insulation in cavities behind internal lining

### 2.2.3.1 Double-shell masonry wall - Single family house, Bern (Switzerland)

Author: Cristina Polo (Supsi)

What is the solution?

The listed neo-baroque style single family house in Bern/BE, dated 1898, has been extensively renovated and thermally refurbished between 2011 and 2015. The intervention concerns the thermal improvement of the envelope,

intervening on walls, roof and windows. Due to the high level of protection as the building is listed in Cantonal inventories, the challenge was to achieve maximum results in both fields energy efficiency and heritage protection, opting for several high efficiency interventions, but at the same time with minimum aesthetic impact. For this reason, the external wall was insulated with a double-shell blowing system with Isofloc H2Wall. This is the best possible insulation for an external wall, as reported in the cantonal buildings inventory. This was a premiere in Bern. In addition, it has been included on the inside a wall heating with 1 cm aerogel insulation (corresponds to 3 cm of conventional insulation).

### Why does it work?

The intervention maintains the original aesthetics of the wall and the increase in wall thickness is minimal. This way, the interior space of the building remains practically unchanged. Many houses built between 1900 and 1970 have cavity walls. The outer shell, usually a brick facade or plastered masonry, provides protection against the weather. Behind this there is a 40-100 mm cavity and the internal shell is usually the load bearing wall. A lot of valuable heat energy is lost via an un-insulated external wall. The retrofit solution used in this project, Isofloc H2WALL (isofloc® pearl,) is made from an EPS-based raw material granulate that has been refined with graphite specially developed for effective, cavity-free filling of double-shell masonry. For retrofitting of the double-shell wall construction, the EPS granulate is blown into the previously free air space through blow-in holes in the front wall shell and the openings are closed again with plaster or mortar of the same colour.

### Description of the context

The building is a detached single-family house, a two-floors neo-baroque construction with a mansard rooftop and is dated 1898. The general situation of degradation and the need to minimize energy demand collide with the important aspect of historic buildings preservation. As usual at road forks and corner houses in the Kirchenfeld district, according to the Kirchenfeld-Brunnadern building inventory, the house was designed with special care: the south-east corner of the house is characterized by a corner risalite, which is covered with the mansard roof. The house is listed in the cantonal building inventory and classified as worthy of protection (highest protection level). For this reason, any changes must obtain the approval of the Department of Historic Monuments.

### Pros and Cons

Pros are that the intervention is aesthetically minimal and at the same time thermal comfort highly increases, thanks to the wall radiators that guarantee a good heat diffusion. New technologies as the double-shell blowing system are an important improvement in renovation projects. This retrofit solution is suitable for exterior walls and is characterized by low thermal conductivity ( $\lambda = 0,033$ ). It is water-repellent and completely recyclable. The vapor-permeable granulate is resistant to aging and rot. Other advantages are: Less expensive because the insulation is blown in the cavity core of existing walls using small injection openings with minimal cross-section intervention with complete cavity filling; Low moisture absorption due to its water-repellent property; Settlement-proof and can be processed without joints.

### Additional Information:

Huge energy savings are possible with this insulation measure. Because the aeration of the air layer is prevented by cavity wall insulation, the surface temperature of the internal wall surfaces increases. That contributes towards a high level of comfort for the inhabitants. The existing living space is not stressed or affected by the retrofitted insulation, which is only on the cavity existing space inner layers of the wall. The thermal transmittance value of the wall was significantly reduced after the intervention (U-value pre-intervention 0.68 W/m<sup>2</sup>K; U-value post-intervention 0.44 W / m<sup>2</sup>K). Furthermore, top roof attic, basement ceiling as well as all the ceilings of the family house were insulated with cellulose. The builders used Isofloc H2Wall granulate, which is now called Pearl, in the two-shell masonry of the building. "This insulation material is considered state of the art for the exterior walls of objects in the cantonal building inventory. It is also very inexpensive because it can be blown in," as stated by the building owner, which is also energy consultant very involved in the conscious conservation of its building to preserve its heritage value. Furthermore, as window panes were replaced by insulating glass (windows were insulated with the krypton gas), while the historical original window frames were retained or reconstructed both strategies together have made possible to achieve a building envelope with high thermal performances.

### Is there any related publication?

Article and video published in Hausinfo, a neutral online information platform on all topics relating to the house, published in German and French (Ed. GVB Services AG and the Home Owners Association Switzerland, HEV): "Architecture report: Energy-producing roof despite monument protection". The article contains information on the products and the technical plans used in the building refurbishment. Available at: <https://www.hausinfo.ch/de/home/gebaeude/architekturreportagen/hutterli-bern.html>

In 2014, the building owners received a Swiss solar award for their commitment to improving the energy balance of their building. Link: [https://www.solaragentur.ch/sites/default/files/q-14-10-03\\_hutterli\\_roethlisberger\\_solpreiskatsan.pdf](https://www.solaragentur.ch/sites/default/files/q-14-10-03_hutterli_roethlisberger_solpreiskatsan.pdf)

### Best practice example:

Single family House - Bern, Switzerland <https://www.hiberatlas.com/en/single-family-house-bern-switzerland--2-174.html>



figure 74: Double-shell blowing system with Isofloc H2Wall © M. Hutterli



figure 75: Internal wall intervention © M. Hutterli



figure 76: Internal intervention © M. Hutterli



figure 77: Internal wall after intervention © M. Hutterli



figure 78: Intervention to improve thermal insulation of external walls. © M. Hutterli



figure 79: External wall after and post intervention. © M. Hutterli

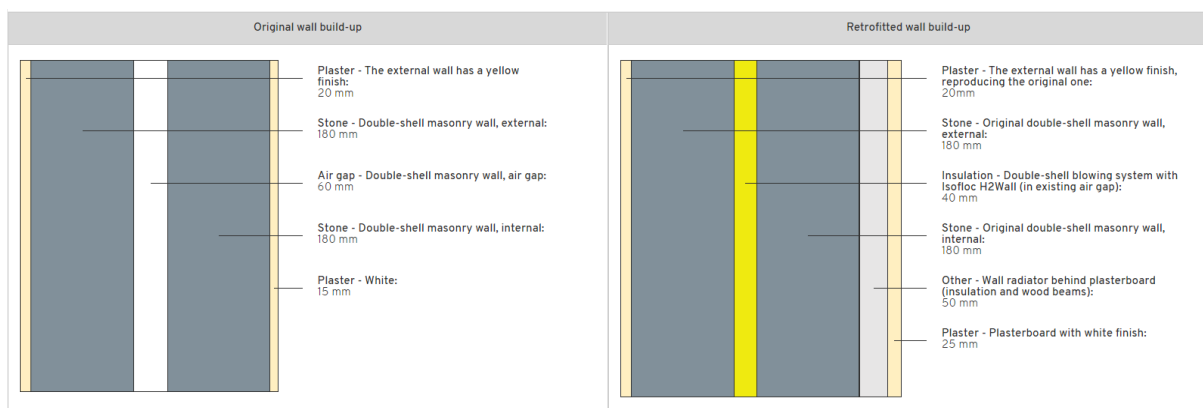

figure 80: External wall details, after and post intervention.

### 2.2.3.2 Aerogel based material for blown-in insulation

Author: Eleonora Leonardi (EURAC)

#### What is the solution?

The solution consists of an innovative material for blown-in insulation. A fibrous polyester material is impregnated with silica aerogel. This blanket is cut in very small pieces and used for the blown-in product. The blown-in insulation can be used in the cavity behind the wall finishes (for example existing panelling or plaster). The product was developed in a research project and it is on the market.

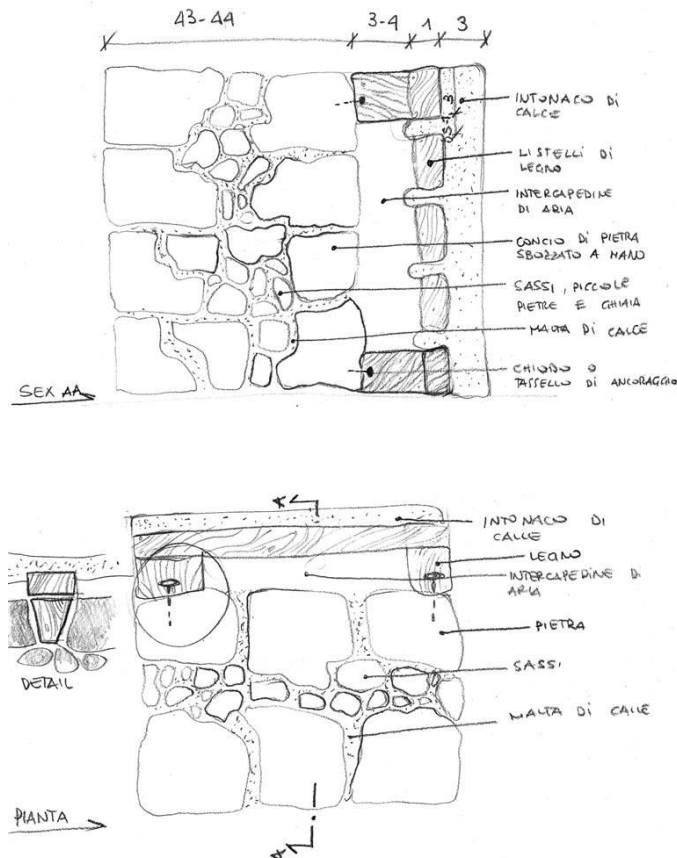

figure 81: Cross section, © Elena Lucchi (Eurac)

#### Why does it work?

The solution works well for historic buildings because it can be used in cavities behind internal lining without reducing room space. The installation is cost effective, a company specialized in blown-in insulation is needed. The material has good hygrothermal features but should be verified case by case with hygrothermal simulations, as each internal insulation solution.

#### Description of the context

The building where the solution was built in is a traditional Scottish tenement building in the district of Glasgow. Only one flat was renovated with this technique. The external walls are traditional stone masonry made with sandstone bedded in mortar.

#### Pros and Cons

The possibility to use the cavity behind wall finishes without reducing room space and the cost-effective installation techniques are the main advantages of the solution. The material produces a lot of dust during installation, the installer has to fully protect themselves because the material cannot be breathed neither touched. This brings to difficulties during installation. Another disadvantage is the high production cost.

#### Type of Data Available

The material is a new material that was developed within a research project. The material was tested in a large scale mock up and in a real building. The monitoring and simulation results are published in research papers.

## Additional Information

The following papers related to this material are published: 1.) Elena Lucchi, Francesca Becherini, Maria Concetta Di Tuccio, Alexandra Troi, Jürgen Frick, Francesca Roberti, Carsten Hermann, Ian Fairington, Giulia Mezzasalma, Luc Pockelè, Adriana Bernardi, "Thermal performance evaluation and comfort assessment of advanced aerogel as blown-in insulation for historic buildings", *Building and Environment*; 2.) Elena Lucchi, Francesca Roberti, Troi Alexandra "Definition of an experimental procedure with the hot box method for the thermal performance evaluation of inhomogeneous walls", *Energy and Buildings*



*figure 82: Installation, © Elena Lucchi (Eurac)*



*figure 83: Loose material, © Elena Lucchi (Eurac)*

### 2.2.3.3 Blown cellulose insulation for mass walls

Author: Roger Curtis (HES)

#### What is the solution?

Internal Wall Insulation (IWI) behind existing linings using blown cellulose fibres. This loose material is blown in through pre-drilled holes in the existing historic plaster lining. The depth of fill is normally about 35-40mm, and in most cases reduces the U-value from 1,2 W/(m<sup>2</sup>K) to 0,7 W/(m<sup>2</sup>K).

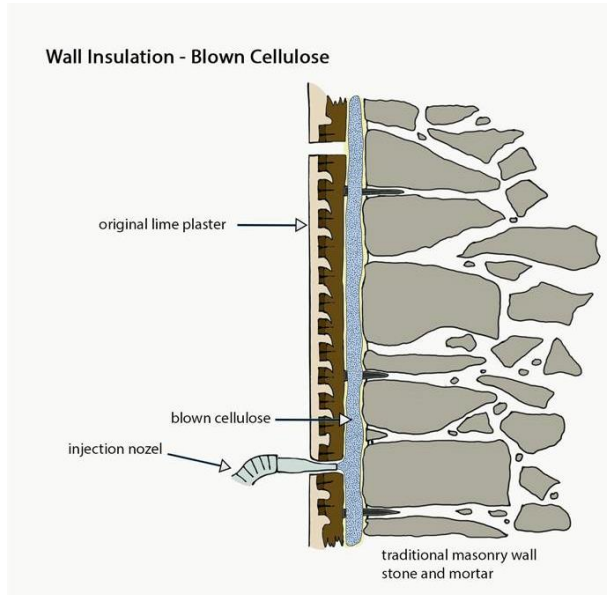

figure 84: Indicative drawing showing the blown cellulose behind the existing lath and plaster lining © HES

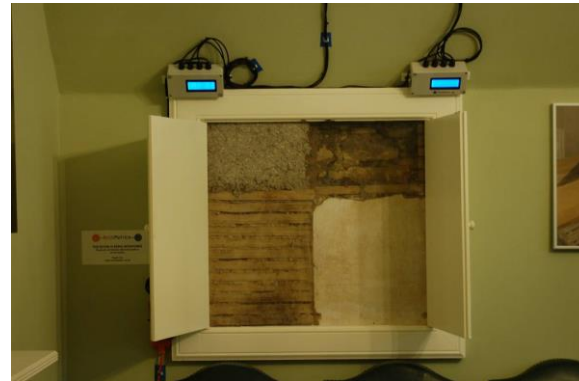

figure 85: Viewing panel showing the blown cellulose top left © HES

#### Why does it work?

The building is a two-storey cottage in Edinburgh built in 1858; it is protected, being Category B Listed. The measure allows minimum disturbance of the traditional fabric. The blown cellulose, the insulating material, allows a trapping of the air behind the plaster linings, reducing heat flow through the walls. The measure is technically compatible with the existing building fabric - the material is vapour open and capillary active. It allows the thermal upgrade of solid masonry walls while retaining traditional lime plaster linings. There is not a condensation risk, and water is wicked and dispersed away. The energy improvement is around 35%.

#### Description of the Context:

Holyrood Park Lodge is a Category B listed Victorian lodge building built in 1857 in a neo-gothic style, located in a prominent position at the entrance to Holyrood Park in Edinburgh. Primarily designed for the constables who policed the Royal Park, it is bounded by the Palace of Holyroodhouse on one side and the Scottish Parliament on the other. Since 2007 the lower floor hosts the visitor information and shop for the Holyroodhouse area.

#### Pros and Cons

The measure requires removal of existing wallpaper down to the plaster layer. Many holes are required to be drilled (one every square metre) and re-decoration is required with lining paper and a vapour open emulsion paint. However, the measure allows retention of historic linings and the benefits they bring.

#### Type of Data Available

The walls where this measure has been trialled have been tested for moisture safety and heat retention for over two years. Performance has been as expected. Modelling of the wall make up and comparison with measured results shows good correlation. These results are presented in the Refurbishment Case Study.

#### Additional Information

This work was part of a bigger whole house approach to the thermal upgrade of traditional buildings. Work was done to the roof, the floors and windows; this is reported in the refurbishment case study.

## Is there any related publication?

[https://www.hiberatlas.com/smarteredit/projects/120/TP24 - Review of Energy Efficiency Case Studies \(2018\).pdf](https://www.hiberatlas.com/smarteredit/projects/120/TP24 - Review of Energy Efficiency Case Studies (2018).pdf)

This HES Technical Paper describes the previous projects where the measures used in the Lodge were tested.

## Best practice example

Holyrood Park Lodge, <https://www.hiberatlas.com/en/holyrood-park-lodge--2-120.html>

### 2.2.3.4 Injected foam insulation behind existing plaster

Author: Roger Curtis (HES)

#### What is the solution?

This measure is a water-based foam injected behind existing lath and lime plaster. The method retains the existing traditional finish in the building and adds an insulation layer between the wall and the plaster finish.

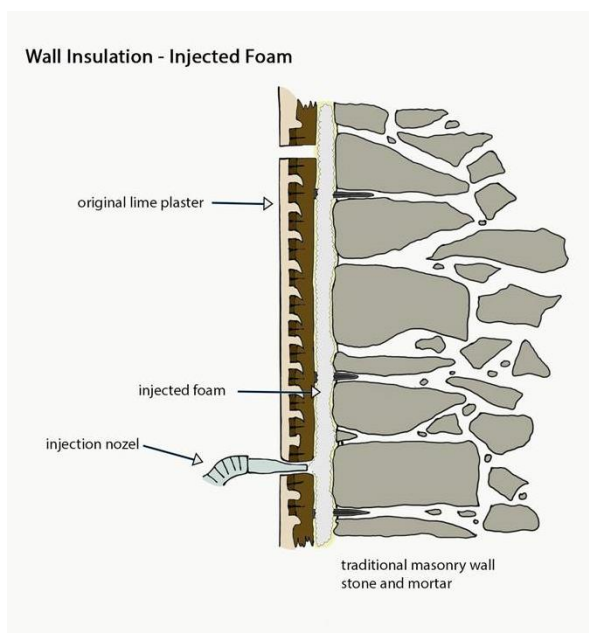

figure 86: Indicative diagram showing the foam being injected behind the lath and plaster lining © HES



figure 87: Photograph showing the injection of the insulation foam © Gannochy Trust

#### Why does it work?

While the width of the gap is modest, around 40 mm, the water-based foam is able to fill the void effectively. The cured foam is vapour open and capillary active, minimising the risk of condensation damage. The post intervention U-value was 0,7 W/(m<sup>2</sup>K) - see the case study for full details.

#### Description of the context

e

#### Pros and Cons

This approach allowed the original wall linings to remain in place. This maintained the historic integrity and feel of the rooms; their dimensions were not reduced; waste and landfill were avoided. Lime plaster is able to buffer humidity, and by keeping this material in place it was assisting in maintaining a healthy internal environment. However, the installation while simple in concept needs careful delivery. Gaps between the floor and the wall need filling, electrical cables need to be put into conduit, and plug sockets needed resetting (see case study for details). There were concerns expressed that this approach would result in condensation risk; however, after modelling and in-situ testing over two years this was not the case. The traditional vapour open construction was able to dissipate



any water vapour. This measure also requires the removal of wallpaper and any other covering on the plaster, and re-decoration with vapour open lining paper and a suitable paint.

### Type of Data Available

A condensation risk assessment was carried out by Glasgow Caledonian University, showing limited risk of condensation for this solution. Evidence from previous HES site trials was also considered, where this material was successful for solid sandstone masonry structures. More information about these trials can be found in HES *Technical Paper 24: Review of Energy Efficiency Projects*.

### Additional Information

Ongoing monitoring of hygrothermal conditions, u-values and the conditions in the roof spaces of the occupied building was carried out for two years after the work. The results of this will be published shortly.

### Is there any related publication?

[https://www.hiberatlas.com/smarteredit/projects/122/Case Study 20 - Annat Road, Perth.pdf](https://www.hiberatlas.com/smarteredit/projects/122/Case%20Study%20-%20Annat%20Road,%20Perth.pdf)

### HES Refurbishment Case Study

[https://www.hiberatlas.com/smarteredit/projects/122/Post-Intervention Monitoring Annat Road.pdf](https://www.hiberatlas.com/smarteredit/projects/122/Post-Intervention%20Monitoring%20Annat%20Road.pdf)

### Post-Intervention Monitoring Report



*figure 88: View of the case study property © HES*

### Best practice example

Annat Road, <https://www.hiberatlas.com/en/annat-road--2-122.html>

## 2.2.4 Innovative system solutions

### 2.2.4.1 Aerogel – based textile wallpaper – La Nave, Italy

Author: Sara Mauri (Polimi)

#### What is the solution?

The solution is a super-insulating aerogel-based textile wallpaper that can be installed on the inner side of the perimeter walls. The innovative wallpaper is based on two completely independent layers with an air gap of about 2 mm in between, combining properties of advanced technical textiles and high-performance insulating materials in few mm of thickness. The system is composed of a layer made of a porous, flexible support impregnated with silica aerogel glued to the existing wall, forming the insulating core, and a finishing textile layer. The latter can be easily installed and replaced thanks to a simple tensioning device, consisting of a system of plastic zips fixed to the wall on one side and connected to the finishing layer on the other side. The top connection, fixed to the wall with nails and/or glue, is based on a PVC strip carrying a plastic zip with a slider on one edge. At the bottom of the wall, the plastic zips are applied on the finishing textile by means of a thermo-adhesive tape that is ironed on the fabric. The wallpaper system was developed by Politecnico di Milano (professors C. Monticelli, A. Zanelli, S. Aliprandi, G. Masera) within the European project EASEE (Envelope Approach to improve Sustainability and Energy efficiency in Existing multi-storey multi-owner residential buildings), Patent n. WO201781568 “Functional upholstery system, method for installation of such upholstery, installation kit of such upholstery Images” Inventors - Monticelli Carol, Zanelli Alessandra, Masera Gabriele, Aliprandi Stefano.

#### Why does it work?

The textile wallpaper is characterized by ease of assembly/disassembly for periodic use, flexibility, reversibility, not destructiveness, lightness, small thickness and meets the intervention requirements of historic buildings. This system represents a technological improvement of a tapestry, a solution coming from the past and traditionally used to mitigate the effects of the lower wall temperatures. The improvement due to the textile is valuable, considering the number of square meters that could reduce the thermal exchange with the colder surface underneath. The thermal performance of the new wallpaper was compared to other two internal thermal insulation systems, traditional in terms of installation process: they are wet assembled, thicker than the new textile wallpaper and not reversible (advanced insulated perlite board; laminated panel composed of silica aerogel impregnated unwoven fibrous blankets fixed to a rigid support). The results of the tests showed that the performance of the textile wallpaper is comparable with the one of the interior traditional insulation. The insulating layer that composed the system presents the following thermal characteristics: average thermal resistance  $R = 0,125 \text{ m}^2\text{K/W}$ ; thermal conductivity  $\lambda = 0,036 \text{ W/(mK)}$ . Moreover, the solution was defined “permeable insulating wallpaper” because it is open to water vapour diffusion, a crucial aspect from the point of view of building physics.

#### Description of the context

This inner retrofitting system was installed on a test wall that is part of an eight-storey building called “La Nave” (building n°14), situated at the Leonardo University Campus of Politecnico di Milano. The building was designed by Gio Ponti, a famous architect active from the 1920s to the 1970s, and hosts classrooms and teachers’ offices. It was built in 1965 and classified as Cultural Heritage in 2007. “La Nave” is characterised by a concrete and steel structure and the façade is an unventilated cavity wall. From outside to inside, the wall is composed of: vitrified grey ceramic tiles (dimensions: 15x7,5x0,7 cm), cement base render (2,5 cm), first layer of hollow bricks (12 cm thick), an unventilated air cavity (34,5 cm thick), second layer of hollow bricks (8 cm thick) and internal cement lime-based plaster with gypsum finishing (1,5 cm). The whole thickness of the wall before retrofit is 59.2 cm. It is a typical massive construction with low level of thermal insulation, as many constructions of that time. The portion of the wall retrofitted is placed at the second floor, South-East and South-West oriented and belongs to a meeting/teaching room. The inner surface covered by the wallpaper system is 3,37 m<sup>2</sup>, with a 7 mm thickness. The insulation layer was glued to the existing wall with a breathable mineral mortar and the finishing layer was then applied in front of the insulation with a bespoke tensioning system.

#### Pros and Cons

Pros: low thermal conductivity ( $\lambda = 0.036 \text{ W/(mK)}$ ); thin and lightweight solution; controlled fire behaviour; water vapour permeability; mitigates the effect of the cold surface of the wall; ease of transportation and storage; ease of installation because all the assembly operations can be performed with common tools (scissors, cutter, hammer and flatiron); insulation layer glued to the existing wall like a standard wallpaper; finishing layer completely dry-assembled and removable for any reason (like washing, substituting a failing element, improving the performances or simply changing the appearance of the wall); geometrical adaptability which allows the application on (not always

planar) existing walls, following their forms also in correspondence of the corners, thanks to the physical flexibility of all the components.

Cons: applicable only as indoor insulation solution; the use in historic buildings may be restricted due to existing important decorations (i.e. wall paintings); high costs of the aerogel material.

### Type of Data Available

The aerogel insulating layer was tested and characterized at laboratory scale to ensure its high thermal performance and its permeability. The whole wallpaper system was then monitored on-site and simulated through a Heat and Moisture Transfer modelling. This study was carried out both before and after the retrofit. The insulating layer was tested in laboratory following the directives of the reference standards in order to have complete data to describe its behaviour. The measured properties are: density by means of volume and weight; thermal conductivity in dry and moist conditions (EN 12667 and EN 12664); water vapour transmission properties (EN ISO 12572); hygroscopic absorption properties (EN ISO 12571); long-term water absorption by total immersion (EN 12087). A continuous monitoring campaign has been carried out from December 2013 until March 2015, including seven months before retrofit and eight months after retrofit (July 2014). The system was monitored by means of temperature, moisture and heat flux probes. Finally, the hygro-thermal behaviour of the base wall and the retrofitted one have been assessed in transient conditions by means of the software WUFI Pro 5.3.

### Is there any related publication?

- Galliano R., Ghazi Wakili K., Binder B., Daniotti B., *Evaluation of three different retrofit solutions applied to the internal surface of a protected cavity wall*, in Energy Procedia, 2015, 78, pp. 848-853.
- Galliano R., Ghazi Wakili K., Stahl Th., Binder B., Daniotti B., *Performance evaluation of aerogel-based and perlite-based prototyped insulations for internal thermal retrofitting: HMT model validation by monitoring at demo scale*, in Energy and Buildings, 2016, 126, pp. 275-286.
- Masera G., Ghazi Wakili K., Stahl T., Brunner S., Galliano R., Monticelli C., Aliprandi S., Zanelli A., Elesawy A., *Development of a super-insulating, aerogel-based textile wallpaper for the indoor energy retrofit of existing residential buildings*, in Procedia Engineering, 2017, 180, pp. 1139-1149.
- Monticelli C., Zanelli A., Aliprandi S., Pracchi V. N., Rosina E., *The energy efficiency improvement of listed buildings through textile-based innovative system*, in Advanced Building Skins, Berna, Switzerland, 10-11 October 2016, pp. 192-202.
- Pracchi V., Rosina E., L'Erario A., Monticelli C., Aliprandi S., Zanelli A., *From arazzo to textile based innovative system for energy efficiency of listed buildings*, in Conference Proceedings of the 3rd International Conference on Preservation, Maintenance and Rehabilitation of Historical Buildings and Structures Heritage 2017, ed by R. Amoeda, S. Lira, C. Pinheiro, Green Lines Institute for Sustainable Development Braga, Portugal, 14-16 June 2017, pp. 1093-1103.
- Pracchi V., Rosina E., Zanelli A., Monticelli C., *Removable textile devices to improve the energy efficiency of historic buildings*, in Conference Proceedings of the 3rd International Conference on Energy Efficiency in Historic Buildings, ed by T. Boström, L. Nilsen, Visby, Sweden, 26-27 September 2018, pp. 127-134.

### Additional Link

<https://patentscope.wipo.int/search/en/detail.jsf?docId=WO2017081568&tab=PCTBIBLIO>



figure 89: Details of the wallpaper system, ©Polimi

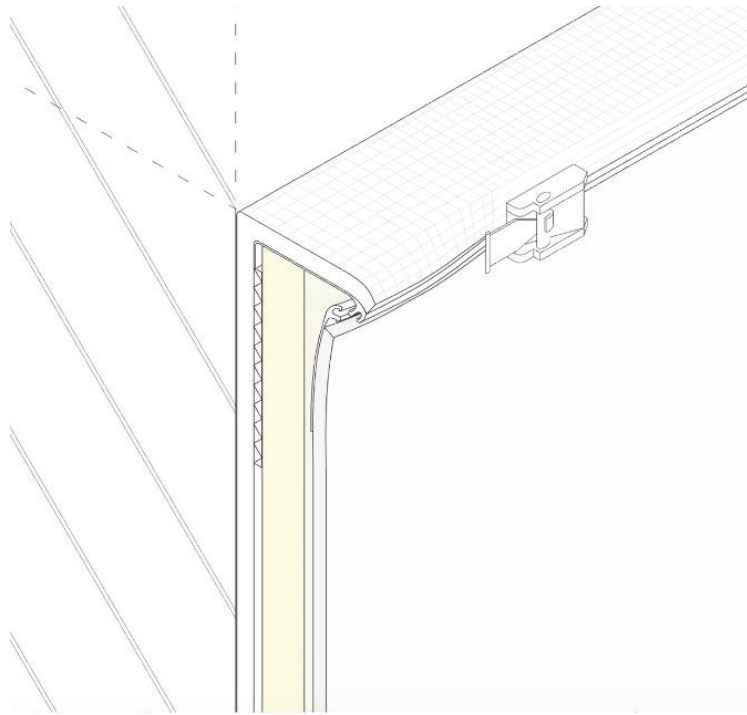

figure 90:: Axonometric projection of the top connection, ©Polimi

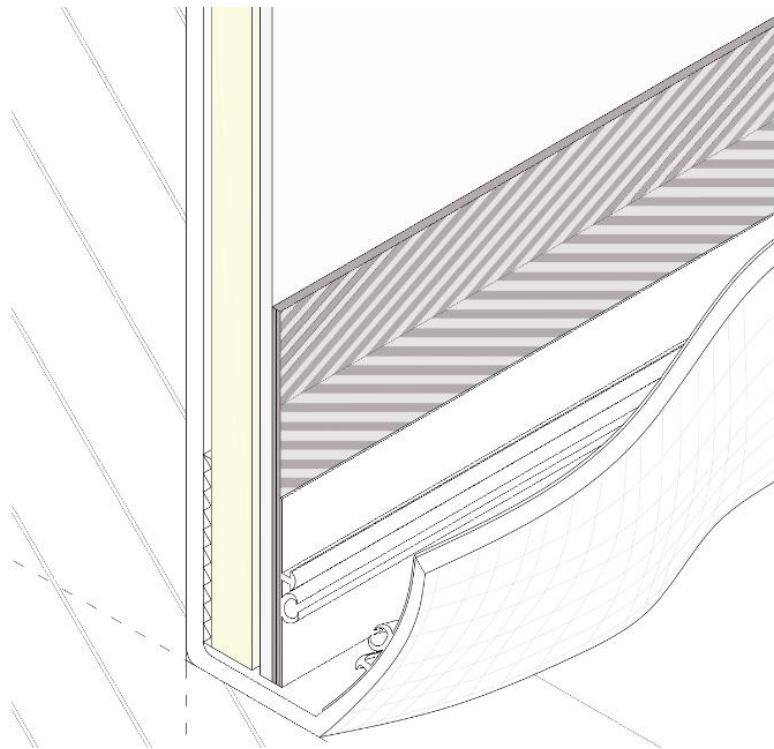

figure 91:: Axonometric projection of the bottom connection, ©Polimi

## 2.2.4.2 Innovative reflective coating

Author: Eleonora Leonardi (EURAC)

### What is the solution?

A reflective coating can be applied on the surface of an historic wall in order to decrease its cooling energy consumption. This coating has a white colour and it is reversible. The coatings here described are two: 1. a silica film. 2. a water-based solution and/or ethanol solution. This solution was developed within a research project and up to now is not on the market.

### Why does it work?

The reflective coating can be applied through a primer (for example Paraloid primer), which ensures its reversibility. The coating protects the existing plaster and prevents it from cracking because of softening temperature changes. The solution brings an energy improvement through a reduction of surface temperature inside the building and consequently a reduction of cooling energy and loads.

### Description of the context

The solution was applied on a building in Istanbul, where the durability was tested.

### Pros and Cons:

The main advantages of the solution are its reversibility and the really simple installation procedure. The main disadvantages are the white colour and the decrease of solar gains in winter (with the consequent increase of heating demand).



figure 92: Reflective Coating on a test wall ©Eurac

### Type of Data Available

The material is a new material that was developed within a research project. The material was tested in a large scale mock up and in a real building. The monitoring results are published in a research paper.

### Additional Information

The solution shows its best opportunities in two cases: a) hot climates where no heating system is needed and b) warm climates where no cooling system has to be installed (saving on investment).

### Is there any related publication?

<https://www.hiberatlas.com/smarteredit/projects/140/paper F. Roberti.pdf>

F. Roberti, E. Lucchi, A. Troi, "Effects of radiation reflective coatings applied to massive walls", 31st International PLEA Conference, 9-11 September, Bologna 2015

<https://www.hiberatlas.com/smarteredit/projects/140/Capture.pdf>

Francesca Becherini, Elena Lucchi, Alessandra Gandini, Maria Casado Barrasa, Alexandra Troi, Francesca Roberti, Maria Sachini, Maria Concetta Di Tuccio, Leire Garmendia Arrieta, Luc Pockelé, Adriana Bernardi

"Characterization and thermal performance evaluation of infrared reflective coatings compatible with historic buildings", Building and Environment

[https://www.hiberatlas.com/smartedit/projects/140/Capture\\_1.pdf](https://www.hiberatlas.com/smartedit/projects/140/Capture_1.pdf)

E. Lucchi, M. Tabak, A. Troi, "The "Cost Optimality" Approach for the Internal Insulation of Historic Buildings", Climamed 2017

## 2.2.5 Specific solutions for driving rain protection and wall drying

### 2.2.5.1 Rainwater management strategy

Author: Athina Petsou (UCL)

#### What is the solution?

The solution is a combination of different systems incorporated in the roof as well as in the base of the building and their connections. The rainwater management system in place consists of: 1. cast aluminium guttering 2. downpipes. 3. surface water drainage (channel drain). The rainwater management strategy is deployed around the whole building. There is a different rainwater management strategy in the south and in the north side of the building. Across the south facade, which is the main entrance, a metal surface water drainage system is placed in the form of channel drain around the periphery of the building. The different solutions have been chosen to minimize the effect of modern systems on the heritage values of the historic building. Across the north part of the building, gutters have been placed at the base of the roof. The guttering system is made of aluminium. Four downpipes have been placed in the north part of the building, leading the water from the gutter system to a safe surface water drainage point. The drainage points are square and built around with stone. Gutters are also located across the east and the west façades.

#### Why does it work?

The rainwater management strategy is working because it is adjusted to fit the goal of maximum protection in parallel with preserving the heritage values of the historic building, incorporating different systems in the north and south facade, which are the longest. Across the south facade, in which there was not guttering been placed, there was a need to control the water. Responding to this necessity, a channel system has been placed to absorb the water and protect the lowest part of the masonry from rainwater splashing. Across the north façade, the gutters gather the rainwater and protect the masonry from the vertical rainfall. Along the north facade there was no need for a channel drain to protect from water splashing, since there is not hard floor but earth. The water transfer is made through four downpipes and drainage points.

#### Description of the context

The incorporation of different approaches in the facade of the main entrance - the one that is seen by the visitors - and the back side of the building has allowed protection from rainwater is achieved while preserving aesthetic and architectural values.

#### Pros and Cons

The pros are the reversibility of the solution. The water management strategy is on the outside of the building, and on the periphery of it. In addition, the solutions chosen are not intrusive to the historic building. The cons are the incomplete protection from vertical rainwater drops in the south facade and the lack of a system for additional protection from extreme water storms.



figure 93: Channel drain © Athina Petsou figure 94: Detail of drainage system © Athina Petsou figure 95: Gutters and downpipe on north façade © Athina Petsou

### 2.2.5.2 Wall drying – Natural Crystallization Technology (NCT)

Author: Tobias Hatt (EIV)

#### What is the solution?

The Natural Crystallization Technology (NCT) prevents rising damp inside existing solid walls and thus protects the wooden beams in the transition area of solid and timber construction from damage resulting from moisture.

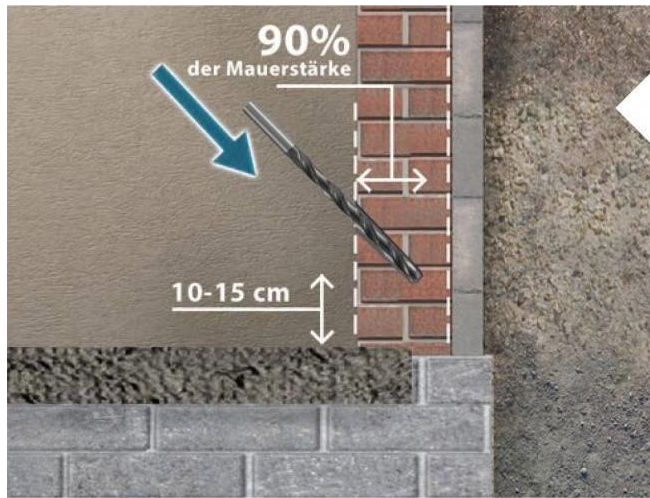

figure 96: NCT injection to create a horizontal barrier for rising damp (Source: NCT group)

#### Why does it work?

The Natural Crystallization Technology (NCT) works by injecting so-called NCT-crystals into a damp wall. If these crystals get in contact with water, they have the property to attach dissolved constituents within the wall to the crystalline structure. In other words, the NCT injection acts as a catalyst for the formation of crystals in the damp wall, which stops with the draining of the capillary pores. The NCT-crystalline structure inside the capillary pores has a structural stability, which is waterproof but still open to vapour diffusion. The existing solid walls of the building are conserved and the wooden beams in the transition area of solid and timber construction are protected from damage resulting from moisture. The process can also be applied on a surface to obtain a wall, which is waterproof but still open to vapour diffusion. In combination with an inside insulation, which is also open to diffusion, a thermal renovation without risk of moisture is possible.

#### Description of the context

Buildings that consist of a solid concrete, stone or brick structure on the ground floor and a timber construction on the upper floors have a high risk of damage by rising moisture and condensate in the transition area of solid and timber construction. Especially if the buildings are thermal renovated with internal insulation and new windows there is a higher risk in the usage afterwards, because less moisture caused by occupancy is removed by uncontrolled air exchange due to the higher airtightness. Correct ventilation behaviour or, in the optimal case, the installation of a mechanical ventilation system with heat recovery helps to remove the moisture in a controlled manner. NCT can be a solution to reduce the entry of moisture through rising damp, although in historic buildings it is generally more common to use a diffusion-open wall structure and to remove the moisture via the surface of the masonry.

#### Pros and Cons

Drying of damp walls and conservation of the existing solid construction. Protection of wooden beams in the transition area of solid walls and timber construction from damage resulting from moisture. In combination with an inside insulation, which can be also open to vapour diffusion, a thermal renovation without risk of moisture is possible.

#### Type of Data Available

Application example: <https://www.energieinstitut.at/unternehmen/partnerbetriebe-traumhaus-althaus/veranstaltungsueckblick/ein-fall-fuer-eine-mauertrockenlegung/>

#### Additional Link

<https://mauertrockenlegungvoninnen-wien.at/technologie/cristallization-im-detail>



## 2.3 External Insulation

### 2.3.1 External insulation

#### 2.3.1.1 Mineral wool - Solution 1 - Magnusstrasse - Zürich, Switzerland

Author: Cristina Polo (SUPSI)

##### What is the solution?

Conventional thermal insulation materials, such as mineral wool was placed overlapping on the existing stone wall. This insulating layer is covered with a 5 mm layer of plaster as finishing layer. The insulating panels can be fixed to the support by means of adhesives or by mechanical fixing. The bonding must be done with adhesive mortars and then laid on the surface to be insulated, as regular and stable as possible, taking care to perfectly match them and staggering the joints. After that, the panels must be smoothed with high vapor permeability adhesive mortars with the application of an internal reinforcement mesh to prevent the formation of cracks in the plaster and an external finish to resist bad weather and sudden changes in temperature. The façades on the courtyard side are provided with 28 cm external thermal insulation (plastered rock wool panels). The base was made with insulated fiberglass concrete elements (height approx. 20 cm).

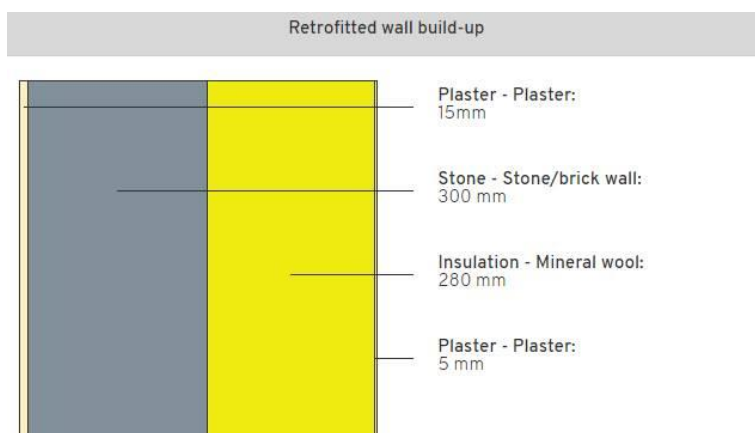

figure 97: Retrofitted wall build-up

##### Why does it work?

The street façades are fully preserved in their existing condition. For reasons of monument conservation, it was not possible to install external thermal insulation. The paint and loose plaster spots in the base and the facade surface have been removed. There was a net embedding and plaster that was painted over the entire area. The transition from the facade to the underside of the roof had to be made again with decorative strips (monument conservation requirement). The partially damaged window walls have been repaired and repainted.

##### Description of the context

During the refurbishment of the residential building on Magnusstrasse in Zürich and despite preservation requirements, the building could be well insulated today reaches the Minergie new construction standard. Minergie® Certification for low energy consumption buildings is the Swiss brand that certifies the sustainability of new or redeveloped buildings. The street front has not been thermally insulated, while the facade on the court has been very well insulated.

##### Pros and Cons

Mineral wool is naturally moisture-resistant. It retains its insulating qualities even when wet. On the contrary, to meet high energy efficiency requirements corresponding to current standards a relatively thick insulation layer is required. In this case, based on the orientation, the comfort of the north-facing rooms is not optimal. At the level of the energetic balance the new elements (windows, façade on the court and roof plans) compensate numerically for the major losses. This cladding insulation delivers excellent fire protection and soundproofing performance.

##### Additional Information



### 2.3.1.2 Mineral wool Solution 2 - Residential and commercial building Feldbergstrasse – Basel, Switzerland

Author: Cristina Polo (SUPSI)

#### What is the solution?

During the refurbishment of the building on Feldbergstrasse 4 + 6 in the old part of Basel, several requirements of the cityscape commission for façade and roof design had to be met. The existing massive plastered outer wall in quarry stone and z.T. Brick is insulated on the outside with a plastered compact insulation with a thickness of 40 cm (FLUMROC thermal-acoustic insulation board). As the facade on the street has been formally changed ( new thermal insulation and new garments), the solution with the slat blind box on windows should be eliminated from the point of view of the Commission. The windows have been substituted without modifying the original dimension to maintain alignment to the neighbour houses. A solution was sought in which louvered blinds could be inserted into the new thermal liner and thus the original image from the window jambs could be restored. The choice of colours has been made on site.

#### Why does it work?

After analysis of the front on the Feldbergstrasse and due to the need to put a new coat of insulation, the project provides a formal layout of the façade divided in three levels: the base, shaft and the roof. As store windows are used along the street, a new store window has been realized in one building. In the shaft the windows are inserted with simple new jambs to align to the street front, avoiding to different formal decoration. The intervention has been discussed with the "City Picture Commission".

#### Description of the context

Two more than 100-year-old apartment buildings on Feldbergstrasse are being renovated to produce more energy than they use for heating/hot water, ventilation and auxiliary energy. The 12 apartments did not meet today's comfort requirements. Accordingly, the apartments were poorly rented or stood empty. The need for maintenance was high.

#### Pros and Cons

It could be reached a very high energetic improvement of the outer wall. On the contrary, to meet the requirements of high energy efficiency reached a very high thickness insulation layer was necessary. The surface remains plastered. Costs of outer plastered insulation are lower than other systems. Mineral wool is also very fire resistant and can act as a fire stop. It is hydrophobic, so it won't absorb water or encourage the growth of mould. Protective gear must be worn when installing mineral wool.

#### Additional Information

This cladding insulation delivers excellent fire protection and soundproofing performance.

The thermal transmittance value of the wall was significantly reduced after the intervention (U-value pre-intervention 1,40 W/(m<sup>2</sup>K); U-value post-intervention 0,60 (W/(m<sup>2</sup>K). Climatic zone Cfb (Warm temperature, fully humid, warm summer). The climate in this area is classified as Cfb: Temperate oceanic climate (Köppen climate type), characterized by a temperate climate, without dry season, with warm summer. the coldest month averaging above 0 °C (32 °F), all months with average temperatures below 22 °C (71.6 °F), and at least four months averaging above 10 °C (50 °F) with no significant precipitation difference between seasons. This climate characteristics implies that external optimal energy efficiency can be achieved with a good insulation system.

#### Is there any related publication?

[https://www.hiberatlas.com/smartedit/projects/67/energeia\\_d\\_wattdor\\_2.pdf](https://www.hiberatlas.com/smartedit/projects/67/energeia_d_wattdor_2.pdf)

Energeia Watt d'or

[https://www.hiberatlas.com/smartedit/projects/67/G-09-08-20 Viriden\\_2.pdf](https://www.hiberatlas.com/smartedit/projects/67/G-09-08-20 Viriden_2.pdf)

The refurbishment project was awarded with the Swiss Solar Prize Award 2009. Link at: <https://www.solaragentur.ch/dokumente//G-09-08-20%20Viriden.pdf>

#### Additional Link

<http://www.viriden-partner.ch/plus-nullenergiehaeuser?lightbox=datatem-is05dqmd>

Best practice example:

The project was documented in HiBER ATLAS platform: Residential and commercial building Feldbergstrasse – Basel, Switzerland: <https://www.hiberatlas.com/en/residential-and-commercial-building-feldbergstrasse-basel--2-67.html>

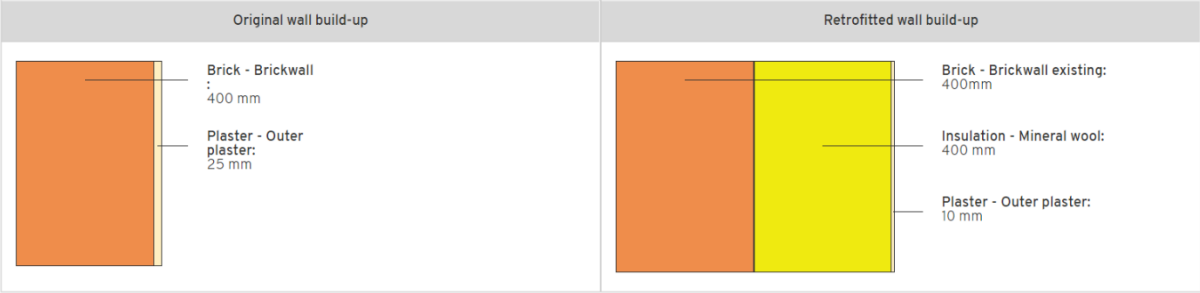

figure 100: Retrofitted wall build-up

|                          |  |  |
|--------------------------|--|--|
| <b>202</b>               | Sanierung MFH Feldbergstrasse 4, 4057 Basel<br>EcoBer ziv AG, Zweierstrasse 25, 8031 Zürich  | Plan-Nr. 31.91<br>Merkblatt<br>Plan-Grosse A3<br>gezeichnet am 30.05.2008<br>Datum<br>revidiert<br>revidiert |
|                          | <b>Referenzbilder<br/>Strassenfassade</b>  |  |
| <b>Viridén + Partner</b> | Viridén + Partner AG<br>Zweierstrasse 25 8031 Zürich Telefon 043 456 80 80 Fax 043 456 80 00 |  |



|                          |  |  |
|--------------------------|--|--|
| <b>202</b>               | Sanierung MFH Feldbergstrasse 4, 4057 Basel<br>EcoBer ziv AG, Zweierstrasse 25, 8031 Zürich  | Plan-Nr. 31.91<br>Merkblatt<br>Plan-Grosse A3<br>gezeichnet am 30.05.2008<br>Datum<br>revidiert<br>revidiert |
|                          | <b>Referenzbilder<br/>Strassenfassade</b>  |  |
| <b>Viridén + Partner</b> | Viridén + Partner AG<br>Zweierstrasse 25 8031 Zürich Telefon 043 456 80 80 Fax 043 456 80 00 |  |



figure 101: Analysis of the front on the Feldbergstrasse © Viridén + Partner AG

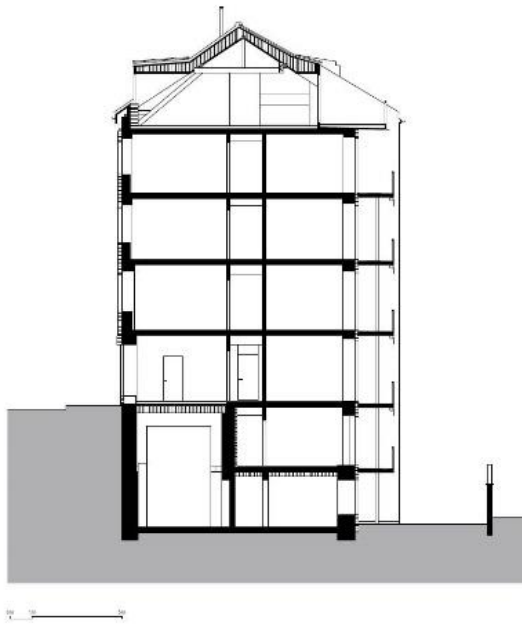

figure 102: Cross section, © Viridén + Partner AG



figure 104: Court view, © Viridén + Partner AG

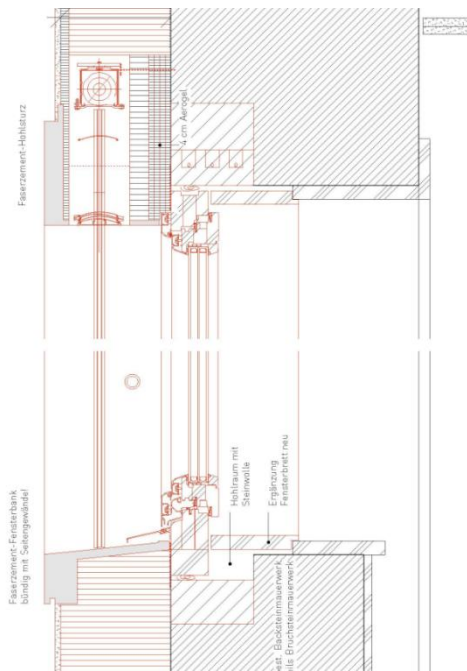

figure 103: Cross section detail © Viridén + Partner AG



figure 105: Street elevation after renovation. © Nina Mann

### 2.3.1.3 Façade integrated renewable

Author: Cristina Polo (SUPSI)

#### What is the solution?

The new façade consists of a layer of PV, a ventilating air space, and a layer of insulation, held by a wooden aluminium substructure. As thermal insulation, 200 mm mineral wool with a thermal conductivity of 0,035 W/(mK) is used, whereby a U-value of 0,16 W/(m<sup>2</sup>K) has been reached. The cladding consists of coloured frameless photovoltaic modules and fibre cement panels. The width of the air space behind the facade-integrated PV is 80 mm. This allows for the heat that is generated behind the modules to dissipate, which has a positive effect on their efficiency and output. The power optimizers of the modules and the wiring can also be arranged in the air space.

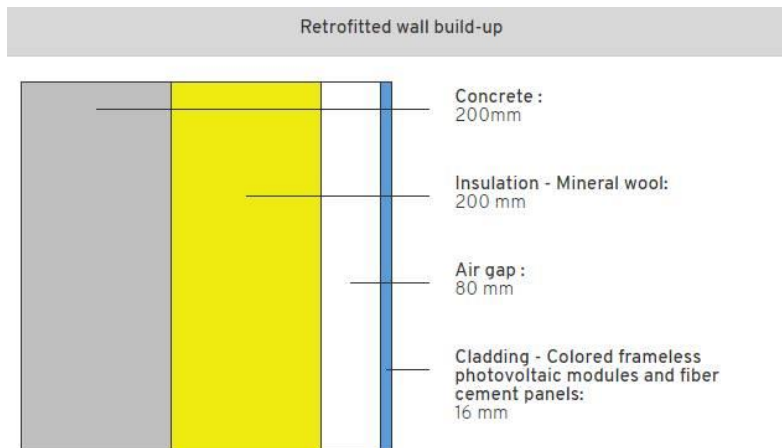

figure 106: Retrofitted wall build up

#### Why does it work?

The mostly windowless massive concrete walls do not allow for traditional uses without major structural changes. Openings were cut into the chambers and the façades. The U-value allows to meet good insulation standards. The aesthetical appearance of the BIPV façades and the BIPV roof arises from the use of innovative coloured PV modules that have been combined with attention to the geometrical aspects and existing constrains of the roof and the façades. The modules technology is characterised by a colour coating on the outer surface of the module's glass that makes the modules a matte panel and the PV cells are hardly recognisable. Innovative coloured customized photovoltaic modules are used creating a particular visual design. Colours are black, green, blue, grey and gold. A special glass-cover to make invisible the solar cells that combines effects of diffuse surface and interference filters were specially developed to integrate solar energy smoothly into the built environment with a minimal loss of efficiency. A visual change in the exterior finish has occur with respect to original status. However, as "Gundeldinger Feld" ensemble is under heritage protection, the remodelled building was required to match the style and colour scheme of the site and all the old industrial area.

#### Description of the context

The former building of the heating centre and the coal silo of Maschinenfabrik Sulzer and Burckhardt in Basel. Over the past 15 years it has been completely converted into a multipurpose building making space for a cultural district. The Solar Silo is the result of the refurbishment of an old coal silo tower, where coal was stored to produce heat for an ex-industrial field "Gundeldinger Field", established in 1844. In the last 15 years, the foundation Kantensprung AG has bought the industrial area to return this site to the local population. The main criteria for site transformation are: neighbourhood, ecology and integration. Therefore, this transformation has been carried out adopting a holistic sustainable approach: re-use of existing materials, rainwater collection, green roofs, photovoltaic systems and space reconversion for social/work/commercial activities. Regarding the photovoltaics, it has been integrated into the building envelope to provide a visible sign of the shift from the use of fossil fuels for an old manufacturing site to the use of renewable energies for a new cultural and commercial site. The project is part of the "2000 watt society - pilot region Basel".

#### Pros and Cons

The BIPV system is reversible as is integrated in a ventilated façade, this allows for the heat that is generated behind the modules to dissipate, which has a positive effect on their efficiency. The solar system is easily removable like other ventilated roof or façades. The BIPV modules are ventilated and serve as the water-bearing stratum.

Moisture accumulation on the back-side of the Photovoltaic module in this case is not probable as the solution is a ventilated façade. The multi-functionality of the BIPV is a prerequisite for the integrity of the building's functionality and must be able to satisfy the same technological requirements of other similar construction cladding material (e.g. water-tightness, mechanical resistance, etc.).

In this building, solar modules are perfectly integrated into the façade and the roof, so that they are completely in line with the other construction elements, avoiding possible shadows and hotspots, which cause system malfunctions and decrease efficiency over time.

### Type of Data Available

In Basel, the climate is warm and temperate. There is a great deal of rainfall in Basel, even in the driest month. The climate here is classified as Cfb according to the Köppen-Geiger climate classification (Warm temperature, fully humid, warm summer). This climate characteristic implies that external optimal energy efficiency can be achieved with a good insulation system. The thermal transmittance value of the wall was significantly reduced after the intervention because previously since the building was an industrial building not used by people, it was not thermally insulated (U-value pre-intervention 2,00 W/(m<sup>2</sup>K); U-value post-intervention 0,16 W/(m<sup>2</sup>K)).

The project has allowed a socio-cultural revitalization of an entire urban area, an ex-industrial zone of the city, by adopting renewable energies and a sustainable approach. This project is part of a research project to monitor energy performances and to demonstrate an innovative BIPV concept.

### Is there any related publication?

Swiss Solar Prize Award 2015, Link: [https://www.hiberatlas.com/smarteredit/projects/51/g-15-09-02\\_mehrzweckgebaude\\_kohlesilo\\_basel.pdf](https://www.hiberatlas.com/smarteredit/projects/51/g-15-09-02_mehrzweckgebaude_kohlesilo_basel.pdf) [https://www.hiberatlas.com/smarteredit/projects/51/draft\\_publication.pdf](https://www.hiberatlas.com/smarteredit/projects/51/draft_publication.pdf)

SUPSI, Swiss BIPV Competence Centre: BIPV fact sheet "KOHLESILO, BASEL", Link: [https://www.hiberatlas.com/smarteredit/projects/51/kohlesilo\\_energy\\_forum\\_kerstin\\_muller\\_small.pdf](https://www.hiberatlas.com/smarteredit/projects/51/kohlesilo_energy_forum_kerstin_muller_small.pdf)

### Additional Link

Publications Kantensprung AG | Gundeldinger Field, Link: <https://www.gundeldingerfeld.ch/bücher/>

### Best practice example:

Solar silo in Gundeldinger Feld - Basel, <https://www.hiberatlas.com/en/solar-silo-in-gundeldinger-feld-basel--2-51.html>

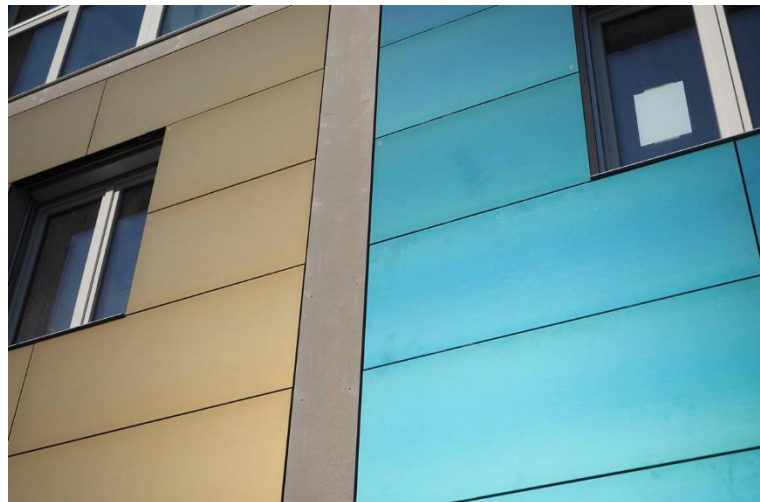
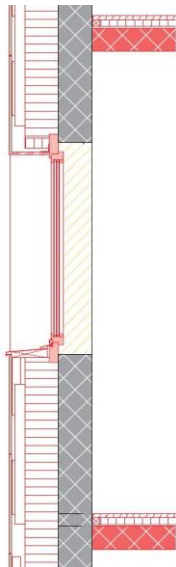

figure 107: Detail of the facade, figure 108: Picture of the panels, © Martin Zeller  
©baubüro in situ



### 2.3.1.4 Mineral wool under shingle facade

Author: Tobias Hatt (EIV)

#### What is the solution?

The renovated wall consists of the following layers (from inside to outside) like shown in the graphic below. 20 mm panelling made of silver fir; Installation level: 50/30 mm vertical wooden columns with mineral wool in between (A vapor control layer of low-medium resistance can be added); 150 to 180 mm log wall (original layer); External insulation 60/30 mm vertical wooden columns with mineral wool in between; diffusion open wind paper; 20 mm timber formwork and 20 mm double layered shingles made of spruce.

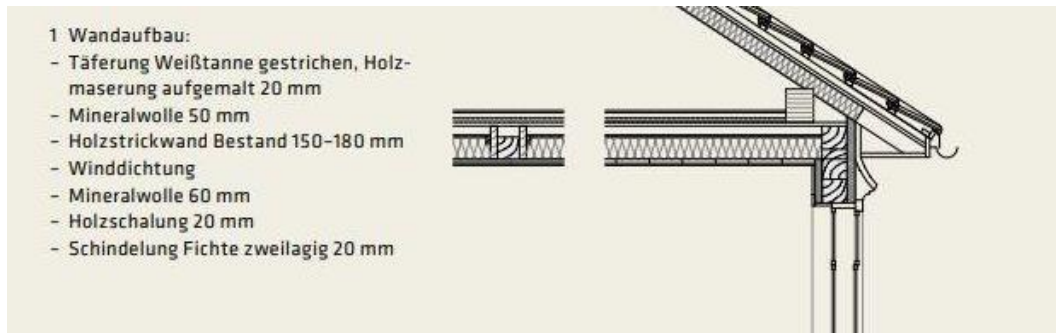

figure 109: Photo of the building before the renovation, ©EIV

The vapour control layer of low-medium resistance can be placed after the 50 mm vertical wooden columns with mineral wool in between because this layer is used for electrical installation. This placement enables a vapour control layer of low-medium resistance over the whole surface without any openings caused by the installation. A strong vapour barrier can lead to damage in this case. A vapour control layer of low-medium resistance should be enough, as the external insulation is increasing the temperature of the internal insulation-wall surface. Also, a vapour barrier would inhibit any inward drying of the original timber. This measure resulted in an improvement of the U-value from 0,56 to 0,28 W/(m<sup>2</sup>K).

#### Why does it work?

The appearance of the historic building is preserved by placing the external insulation layer behind the shingle façade. By using the vapour control layer on the inside and the wind paper on the outside, the construction is prevented from moisture damage. A building physicist should calculate each case to ensure moisture safety and specify the properties of the vapour control layer.

#### Description of the context

The approximately 250-year-old Gasthaus Adler in Langenegg was listed as a historical monument in 2002. The building was vacant for many years before it was purchased by a committed and technically talented Neighbour. The new owner of the house renovated it mainly on his own. The brother of the owner, a well-known architect from Bregenz, developed an architectural concept based on which four residential units could be accommodated in the building. Due to the careful handling of the historically valuable elements, both on the inside and on the outside, the historical flair and the generosity of the traditional guesthouse could be retained.

#### Pros and Cons

The appearance of the historic building is preserved by placing the outside insulation layer behind the shingle façade. This measure resulted in an improvement of the U-value from 0,56 to 0,28 W/(m<sup>2</sup>K). A point against this solution could be the completely replacement of the old façade, but in many cases, this is necessary to guarantee the driving rain protection of the building. The renovation of the external walls leads to a reduced energy demand of the building but also an increased risk of moisture due to the higher airtightness of the building. Therefore, a vapor control layer of low-medium resistance should be installed. Also, a strong vapour barrier would inhibit any inward drying of the original timber. This solution with the external insulation in general is a robust solution to prevent condensation in the wall.

#### Type of Data Available

Detailed drawings of the building Photo comparison of the building before and after the renovation. Calculation of the moisture protection.

## Is there any related publication?

[https://www.hiberatlas.com/smartedit/projects/144/BDA\\_wiederhergestellt\\_35\\_WEB\\_201115.pdf](https://www.hiberatlas.com/smartedit/projects/144/BDA_wiederhergestellt_35_WEB_201115.pdf)

Description of the renovation by the "Bundesdenkmalamt"

[https://www.hiberatlas.com/smartedit/projects/144/Sanierung\\_Historische\\_Aussenwand.pdf](https://www.hiberatlas.com/smartedit/projects/144/Sanierung_Historische_Aussenwand.pdf)

Calculation of the moisture protection

Best practice example:

Gasthaus Adler - Langenegg, [link will be added](#)



figure 110: Photo of the building before the renovation, ©EIV



figure 111: Photo of the building after the renovation, ©EIV

### 2.3.1.5 Vacuum insulation panels (VIP)

Author: Gustaf Leijonhufvud (Uppsala University)

#### What is the solution?

Vacuum insulation panels (VIP) can be installed as external insulation. Since the panels are prefabricated in given sizes and cannot be modified, they will be mounted with strips of mineral wool in between.

#### Why does it work?

VIP can be used to reduce the thickness of the insulation layer and thereby limit the aesthetic impact of external insulation. From a moisture safety point of view, the original fabric becomes drier with properly installed external insulation. This intervention is thoroughly evaluated from a moisture safety point of view (please see the papers in the publications section).

#### Description of the context

Vacuum insulation panels (VIP) were installed externally on a building that originally had wooden cover boarding over brick (first floor) and wood (upper floors). The wooden cover boarding was removed, and (from inside out) a vapor barrier was installed over the entire façade. Vacuum insulation panels of 20 mm thickness were glued to the vapor barrier with 50 mm wide horizontal mineral wool strips between the panels. The wall was covered by an additional layer of 30 mm mineral wool. A 28 mm air gap was created before the new wooden cover boarding was installed on the exterior. The total thickness of the new materials was 78 mm. This solution required that the windows were moved outwards by 80 mm to be in line with the new façade.

#### Pros and Cons

Pros: opportunity to externally insulate buildings without too much negative aesthetic impact

Cons: novel method, more expensive than conventional insulation

## Is there any related publication?

1. Johansson P., Donarelli A., Strandberg, P. (2018). Performance of new materials for historic buildings: case-studies comparing super insulation materials and hemp-lime mortar. Proceedings of the 3rd

Conference on Energy Efficiency in Historic Buildings, EEHB 2018, September 26-27, 2018, Visby, Sweden.

2. Johansson, P., Adl-Zarrabi, B., Sasic Kalagasidis, A. (2016). Evaluation of 5 years' performance of VIPs in a retrofitted building façade. *Energy and Buildings*, 130 p. 488-494; <https://doi.org/10.1016/j.enbuild.2016.08.073> [Titel anhand dieser DOI in Citavi-Projekt übernehmen].
3. Johansson, P., Sasic Kalagasidis, A., Hagentoft, C.-E. (2014). Retrofitting of a listed brick and wood building using vacuum insulation panels on the exterior of the façade: measurements and simulations. *Energy and Buildings*, 73(April 2014), p. 92-104; <https://doi.org/10.1016/j.enbuild.2014.01.019> [Titel anhand dieser DOI in Citavi-Projekt übernehmen].
4. Johansson, P. (2014). Building Retrofit using Vacuum Insulation Panels: Hygrothermal Performance and Durability. PhD Dissertation Ny serie: 3657, Chalmers University of Technology, Department of Civil and Environmental Engineering, Gothenburg, Sweden.
5. Johansson, P. (2011). In situ Measurements of Façade Retrofitted with Vacuum Insulation Panels. *Proceedings of the 10th International Vacuum Insulation Symposium*. September 15-16, 2011, Ottawa, Canada, pp. 107-111. 6. Johansson, P. (2011). Assessment of the Risk for Mould Growth in a Wall Retrofitted with Vacuum Insulation Panels. *Proceedings of the 9th Nordic Symposium on Building Physics*. May 29-June 2, 2011, Tampere, Finland, pp. 349-356.

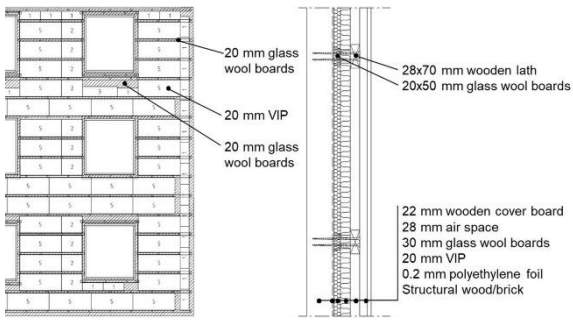

figure 112: Cross section, © Pär Johansson



figure 113: Mounting of vacuum insulation panels, © Pär Johansson



figure 114: Facade after intervention, © Pär Johansson

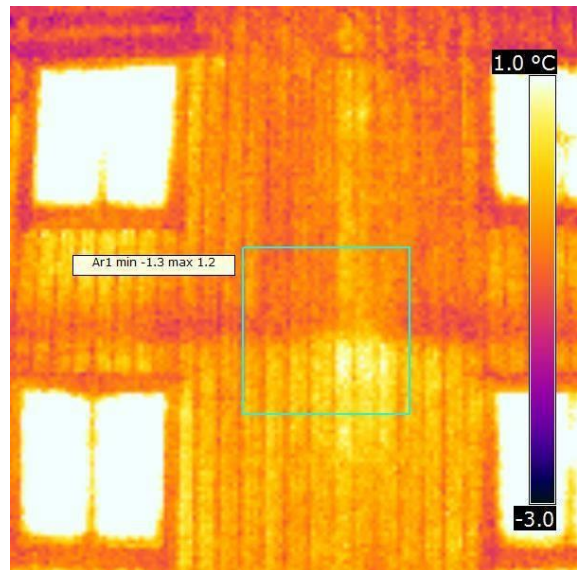

figure 115: Thermal image of the facade before intervention, © Pär Johansson

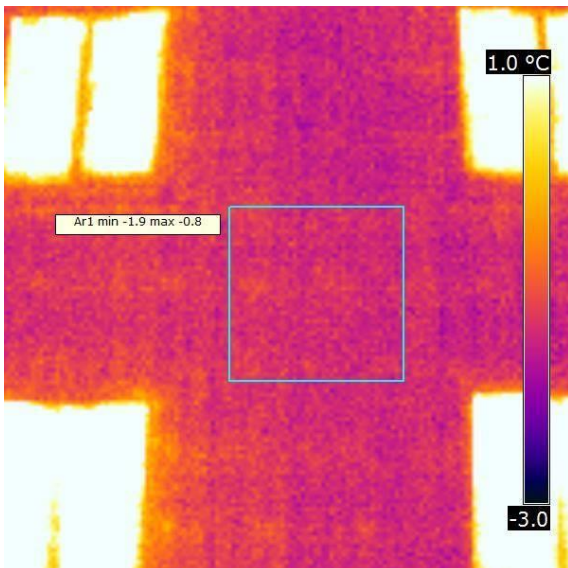

figure 116: Thermal image of the facade before intervention, © Pär Johansson

### 2.3.1.6 External insulation – Multipor

Author: Cristina Polo (SUPSI)

#### What is the solution?

The façade insulation material is Multipor (mineral, cellular panel) with average thickness of 30 cm. The continuous insulation of the building envelope reduces heat loss and consequently reduces energy consumption. The greatest difficulty when converting is to determine the insulation level in the construction. With some construction transitions, thermal bridges can be expected. In this building complex with a double kindergarten and two penthouses built in 1914, Chur (Switzerland), although there were no heritage protection needs, the ensemble of buildings and especially the courtyard with the arch facade made of natural stone were worthy of preservation. During the renovation, external thermal insulation (Multipor solution) was installed on the north, east and partly the south facade. The arches on the south and west façades have been preserved. This area has been insulated from the inside. Multipor mineral insulating panels are made of low density autoclaved aerated concrete. Multipor is a complete mineral insulation based on sand, lime, cement and water. Due to the special structure of the material is similar to other solid building materials and it could be used as mineral insulation systems for interior and exterior use.

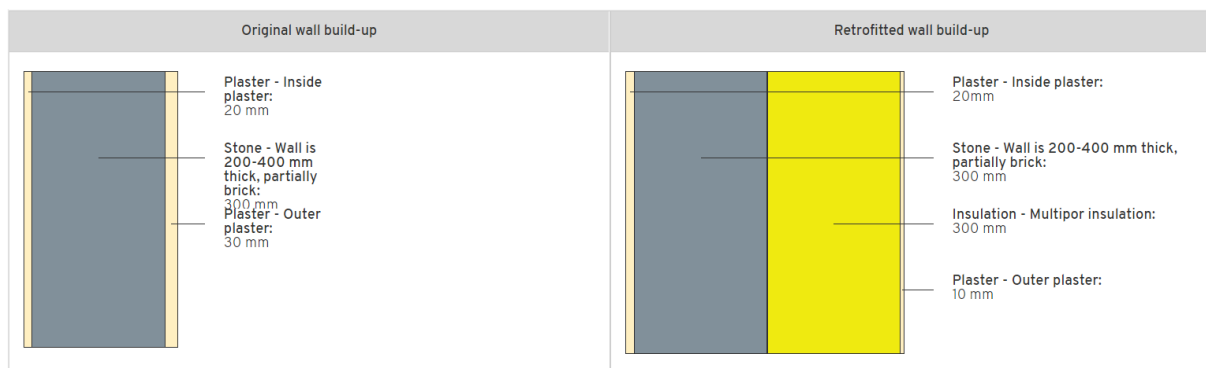

figure 117: Retrofitted wall build up

#### Why does it work?

The appearance of the external facades at the masonry level remained the same. The openings have changed, but not the texture of the masonry. The choice of the materials was made following the principles of the building biology, for example open to diffusion (for better conservation). For the hydro-thermal part it is a high standard execution that brings clear energy advantages.

#### Description of the context

The complex is divided into two structures. The residential building is characterized by the building height and the facade design as the main volume of the ensemble. The previous commercial building is deeper and forms an inner courtyard due to its L-shaped geometry. The courtyard has a high spatial quality thanks to its round arches and the widely projecting roof. The specifications of the city of Chur as client were clear. The artistically valuable ensemble was to be preserved in its original expression. The earlier interventions should be dismantled, the change of use of the annex should be visible from the outside as a renewal but should relate to the original design. In addition: "Since Chur has been an energy town since 2011, it was necessary to incorporate the latest findings in energy and building physics into the renovation.

#### Pros and Cons

Plastered external insulation is one of the most economical executions and did not change the appearance of the external facades. It is a light material and easy to handle with an ideal combination of important properties: dimensionally stable, vapor permeable and non-flammable. This mineral insulation panel is an ecological alternative to conventional insulation materials. Thanks to its mineral raw materials and enclosed air pores, it insulates completely natural. It is capillary active and when utilized as an interior insulation, no steam barrier is required.

#### Type of Data Available

The project manager of the architectural office did his master thesis (sustainable building) on the property.

## Additional Information

This mineral insulation board that uses raw materials that are open to vapor diffusion is an environmentally friendly insulation according to building biology. This measure resulted in a huge improvement of the U-value of the stone walls previously without insulation from 2,50 to 0,14 W/(m<sup>2</sup>K). Climate conditions are mild according Köppen-Geiger climate classification (Climatic zone Cfb, with warm temperature, fully humid, warm summer) and this implies that good thermal envelope performances could be easily achieved with the proper insulation materials.

## Is there any related publication?

The project was awarded with the Swiss solar prize Award in 2016, because after energy renovation of the building that uses also an innovative concept of heating network with the adjacent condominium (MFH) using a combined photovoltaic and thermal system located on the roof, the building covers its energy needs with 28.300vkWh / year at 95%.

Link: [https://www.solaragentur.ch/sites/default/files/g-16-09-22\\_dwhg\\_und\\_doppelkindergarten\\_chur\\_def.pdf](https://www.solaragentur.ch/sites/default/files/g-16-09-22_dwhg_und_doppelkindergarten_chur_def.pdf)  
[https://www.hiberatlas.com/smaredit/projects/148/g-16-0922\\_dwhg\\_und\\_doppelkindergarten\\_chur\\_def%5b1%5d.pdf](https://www.hiberatlas.com/smaredit/projects/148/g-16-0922_dwhg_und_doppelkindergarten_chur_def%5b1%5d.pdf)

## Best practice example

Kindergarten and apartments - Chur, Switzerland, <https://www.hiberatlas.com/en/kindergarten-and-apartments-chur-switzerland--2-148.html>

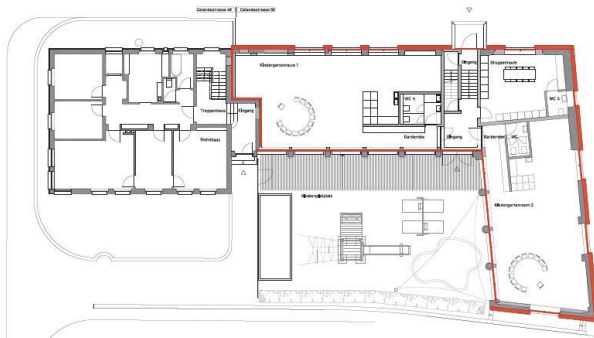

figure 118: Scheme insulation, ground floor



figure 119: Scheme insulation, cross section



figure 120: Arches in the porch, © Ralf Feiner, Malans



figure 121: Execution insulation, © City Chur



figure 122: South front courtyard, © Ralf Feiner, Malans

### 2.3.1.7 External Insulation – aerogel high-performance insulating plaster system

Author: Manuel Krempf, Susanne Kuchar (e7 energy innovation & engineering)

#### What is the solution?

In listed buildings, insulation on the inside is often not possible or desired for technical or organizational reasons and also entails system-related disadvantages compared to insulation installed on the outside. In this project, the application of the aerogel high-performance insulating plaster system on the existing masonry was carried out for the first time on a structured facade and in close cooperation between architects, plaster manufacturer and executing company.

A layer thickness of around 5.5 cm was applied to approx. 205 m<sup>2</sup> of facade area. For this purpose, the old plaster first had to be chipped off and the pre-spray work carried out before the aerogel plaster was applied by machine and in a single operation. After completion of the draught parts, cornices etc. (also with aerogel plaster), the coating was applied.

#### Why does it work?

The aerogel high-performance insulating plaster is mineral and open to diffusion, making it suitable for exterior use. Aerogels are solids of amorphous silica, highly porous with an air content of over 90 percent by volume. The air-filled pores are only a few nanometers in size, which means that the resistance to the transfer of heat (energy) is very high.

The high standards of an energy-efficient building were met, even though the measured heat transfer coefficient does not fully correspond to the calculated values. A supplementary evaluation by means of long-term monitoring will be carried out during the first years of operation.

From a heritage point of view, the visible result is the successful renovation of a historic building in which it was possible to create the external appearance in such a way that there is no difference between the old building and the reconstruction.

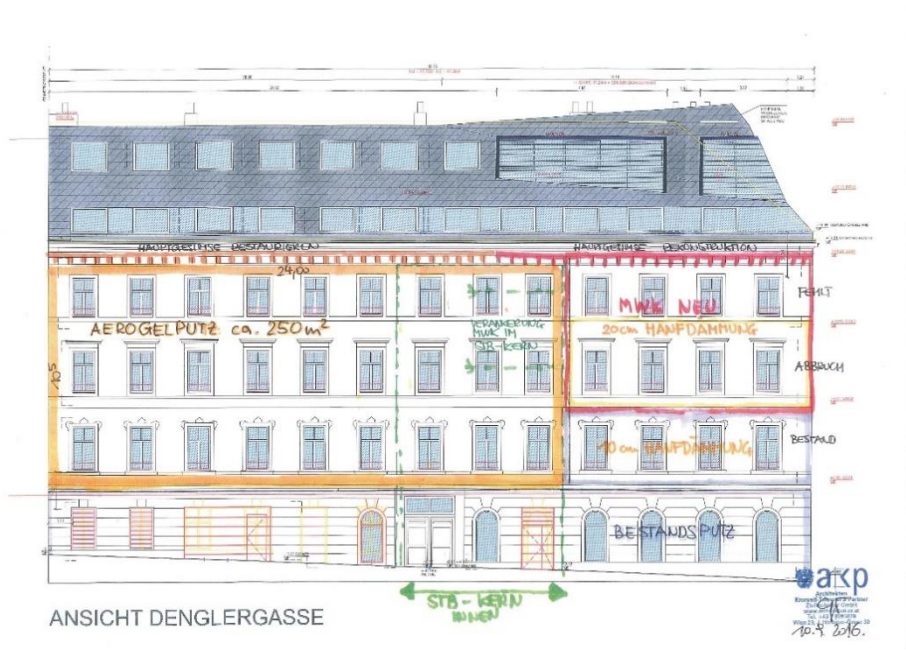
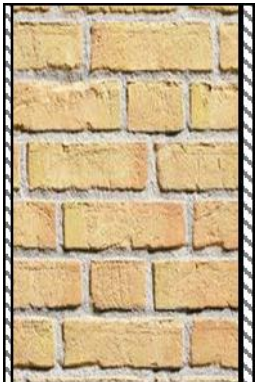
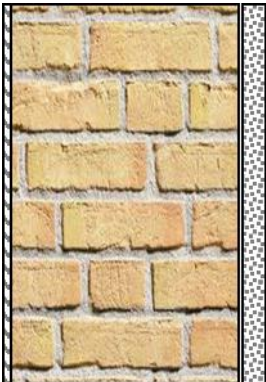

figure 123: Plan with view from Denglergasse showing the part of the façade, which was insulated with the aerogel high-performance insulating plaster “AEROGELPUTZ” (Trimmel Wall Architekten ZTGmbH)



|                  |               |
|------------------|---------------|
| Interior plaster | 1,5 cm        |
| Masonry          | 45 cm / 62 cm |
| Exterior plaster | 2 cm          |



|                  |               |
|------------------|---------------|
| Interior plaster | 1,5 cm        |
| Masonry          | 45 cm / 62 cm |
| Aerogel          | 5,5 cm        |

**Description of the context**

Vienna has a total of almost 35,000 buildings constructed before 1919. About half of this building stock is characterized by articulated facades worthy of preservation. In order to protect urban ensembles from demolition or deformation, there are various protection mechanisms to preserve them in the sense of the local townscape. In this project the demonstration of the aerogel high-performance insulating plaster system took place in the course of the reconstruction and revitalization of a building built before 1872, which was severely damaged as a result of a gas explosion in 2014. It was shown in an exemplary manner how the adaptation of grown urban structures to the requirements of a modern energy-efficient building stock can succeed. The primary objective was to test the new technology in refurbishment. On the one hand, the technical feasibility and practicality of such a renovation solution was to be demonstrated, and on the other hand, a high visibility and multiplication effect was to be conveyed.



## Pros and Cons:

The renovation of buildings with historic structures requires innovative concepts in order to meet both design requirements and technical and economic considerations. The Aerogel high-performance insulating plaster system provides a new alternative for the application area of renovation of old buildings with facades worthy of preservation. Aerogel plaster is an option that is available on the market and has been tested in projects to achieve the balancing act between preserving the external appearance and simultaneously meeting energy efficiency standards and is therefore particularly suitable for the renovation of historic buildings. As a comparatively new technology, it is all the more crucial to transport the practicality demonstrated in the project to the market.

In this project, on the one hand the high structural and design requirements were fully met because all the original proportions of the façade could be retained. On the other hand, heat flow measurements showed that the expected thermal performance was not achieved. The heat transfer coefficients determined from the measurement are significantly higher than the values expected from the building physics calculation. The most probable cause lies in the assumptions underlying the calculation for the thickness of the plaster or the thermal conductivity of the plaster. The following hypotheses can be made for the cause of the deviations:

- The plaster thickness of the aerogel plaster has a significant influence on the thermal resistance of the entire wall structure due to its low thermal conductivity. Even small deviations in the layer thickness have a significant effect on the results of the U-value calculation.
- Similarly, the thermal conductivity of the aerogel plaster has a major influence on the resulting U-value.

The prize factor for Aerogel high-performance insulating plaster also needs to be taken into account, though this was not a focus of the project.

## Type of Data Available:

The building is well documented, also regarding heat flow measurements of the facade and an energy consumption and comfort monitoring.

## Is there any related publication?

Folder on aerogel high-performance insulating plaster system:

[www.architekten.or.at/fh\\_download.php?files\\_id=1748](http://www.architekten.or.at/fh_download.php?files_id=1748) .

## Best practice Example:

Mariahilferstrasse – Vienna, Austria - <https://www.hiberatlas.com/en/mariahilferstrasse--2-62.html>



figure 124: Damaged façade, © Trimmel Wall Architekten ZTGmbH



figure 125: Application of the aerogel plaster, © Trimmel Wall Architekten ZTGmbH



figure 126: Wooden frame as an indicator for the plaster thickness, © Trimmel Wall Architekten ZTGmbH



figure 127: Impressions from the work on the aerosol insulated façade, © Trimmel Wall Architekten ZTGmbH



figure 128: Impressions from the work on the aerosol insulated façade, © Trimmel Wall Architekten ZTGmbH



figure 129: Impressions from the work on the aerosol insulated façade, © Trimmel Wall Architekten ZTGmbH



figure 130: Impressions from the work on the aerosol insulated façade, © Trimmel Wall Architekten ZTGmbH



figure 131: Impressions from the work on the aerosol insulated façade, © Trimmel Wall Architekten ZTGmbH



*figure 132: Impressions from the work on the aerosol insulated façade, © Trimmel Wall Architekten ZTGmbH*



*figure 133: Impressions from the work on the aerosol insulated façade, © Trimmel Wall Architekten ZTGmbH*



*figure 134: Impressions from completed aerosol insulated façade, © Trimmel Wall Architekten ZTGmbH*



*figure 135: Impressions from completed aerosol insulated façade, © Trimmel Wall Architekten ZTGmbH*

## 2.3.2 External and internal insulation

### 2.3.2.1 External insulation combined with internal insulation

Author: Alexander Rieser (UIBK)

#### What is the solution?

In some cases of facade refurbishment, the proportions and the building volume may only be changed minimally. In these situations, only very thin external insulation can be applied. In order to achieve a sufficient thermal resistance of the entire wall construction. The external insulation can be combined with internal insulation.

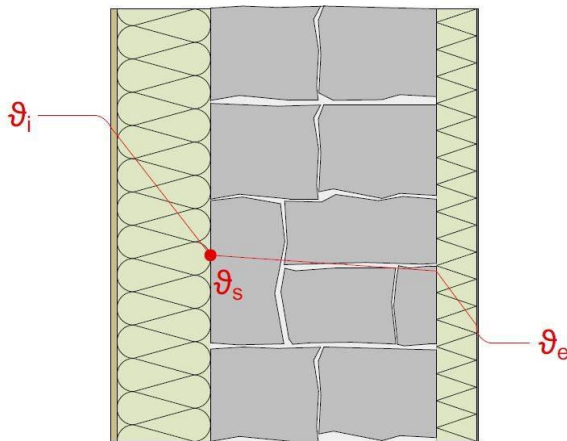

figure 136: Fictitious temperature curve in a wall, © UIBK

#### Why does it work?

The big advantage of a combination of external and internal insulation is the creation of a driving rain resistant facade. By applying insulation on the outside, the problem of driving rain can be significantly improved by appropriate plasters and paints. In this context it is important to use suitable materials. These materials must be highly water-resistant ( $w$ -value  $\leq 0,5 \text{ kg}/(\text{m}^2 \cdot \text{h}^{0,5})$ ) and at the same time as diffusion-open as possible ( $S_d \leq 2.0 \text{ m}$ ) in order not to block the flow of vapour diffusion to the outside. As a result, the ingress of moisture from outside as a reaction to driving rain is as low as possible. This is particularly important if internal insulation is installed. A further advantage is that a higher temperature is achieved at the transition layer, between the existing wall and the internal insulation. Raising the temperature reduces the relative humidity in the critical layer and therefore also the risk of mould growth.

#### Pros and Cons

The pros are the increased protection against driving rain which can be achieved by external insulation in combination with suitable plasters and paints. On the one hand, this is due to the water-repellent properties of the plaster and paint, on the other hand, the additional insulation contributes to driving rain protection. The insulation layer provides a soft buffer material between the existing wall and the surface plaster. This minimizes surface tensions and results in significantly reduced crack initiation. Increased surface temperatures in the boundary layer between the interior insulation and the existing wall reduce mould growth potential. Another advantage is a less effective area required due to smaller interior insulation thicknesses.

The cons are the double working effort (inside and outside) and higher costs due to the renovation of the existing wall on both sides.

#### Type of Data Available

This solution represents a general approach for wall renovation. In principle, it can be implemented with almost every insulation material. The general rules and approaches of the special solutions apply in turn and must always be assessed in connection with the existing wall.

### 2.3.2.2 External and internal insulation – reed mat

Author: Eleonora Leonardi (EURAC)

## What is the solution?

A massive stone wall was renovated with a combination of external and internal insulation using reed mats and insulating plaster. Additionally, the heating system was replaced by a radiating wall system. On the outside, 12 cm of reed mats and 3 cm of insulating plaster were used and internally 2 cm of reed mat and clay plaster were applied.

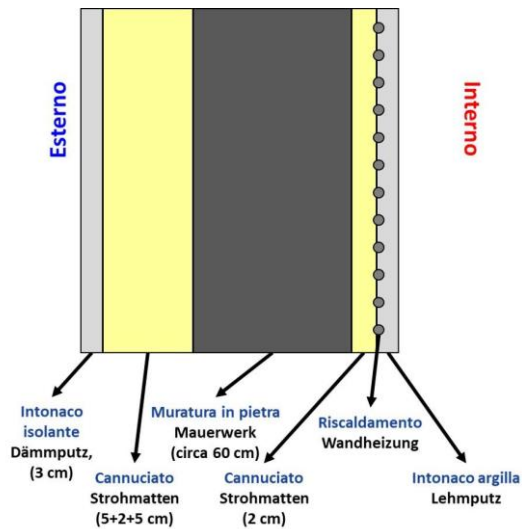

figure 137: Wall stratigraphy, © Eurac



figure 138: Construction phase - external insulation thickness, © Hansjörg Plattner

## Why does it work?

A natural material for the insulation of the wall was chosen to respect the existing stone wall. Moreover, the architect tried to reconstruct the external aspect of the wall as it was in 1784: the window framing and the type of plaster are part of this choice. The coupled use of external and internal insulation makes the solution moisture safe. The wall heating system in the ground floor intends to stop the rising damp.

## Description of the context

The building where this solution is applied is a big residential house, part of the building is dated 14th century. The use of the building changed a lot of times. With the last renovation ten flats were designed: one is permanently occupied; the others are holiday apartments.

## Pros and Cons

The main advantages of this solution are the use of natural material and the low risk of interstitial condensation because the wall is warmer thanks to the external insulation. The solution cannot be used if the external wall is decorated and changes the volume of the building, the depth of the opening's changes. Another disadvantage is that the material is prone to decay in case of water infiltration.

## Type of Data Available

The architect did a deep research about the history of the building. The building is monitored within a research project. The temperature, relative humidity and the CO<sub>2</sub> level are monitored in the bedroom and in the living room in two flats; outside temperature and relative humidity are also monitored. Interstitial temperature and relative humidity are monitored between the external insulation and the stone wall, within the stone wall, between the internal insulation and the stone wall, and the internal and external surface temperature. In-situ U-value testing was undertaken. For the monitored information see attached file.

## Is there any related publication?

[https://www.hiberatlas.com/smardedit/projects/97/Low-tech case studies.pdf](https://www.hiberatlas.com/smardedit/projects/97/Low-tech%20case%20studies.pdf)

Monitoring system Project Low Tech

Best practice example:

Interreg Italia-Osterreich Low Tech eurac research CASE STUDY 1

**Il sistema di monitoraggio**  
Sensori combinati di temperatura e umidità relativa

**Das Überwachungssystem**  
Kombinierte Sensoren für Temperatur und relative Luftfeuchtigkeit

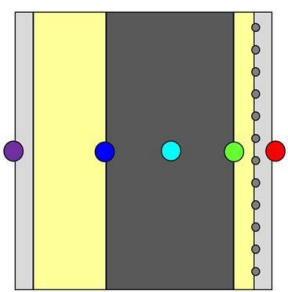
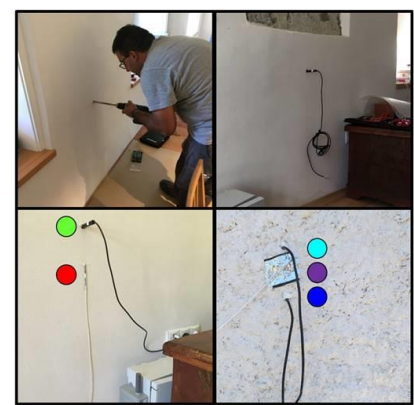



figure 139: Monitoring system of the construction, © Eurac

Interreg Italia-Osterreich Low Tech eurac research CASE STUDY 1 Wall stratigraphy – Apt A

**Risultati preliminari** **Vorläufige Ergebnisse**

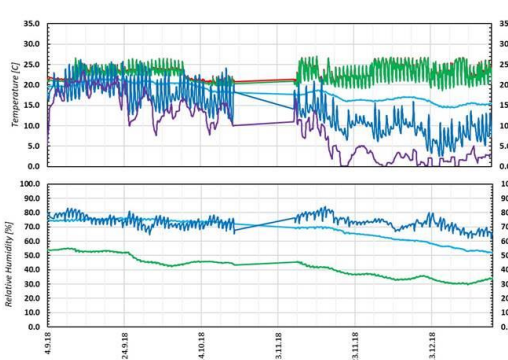
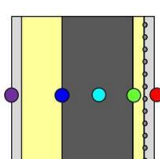
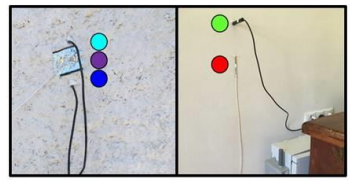
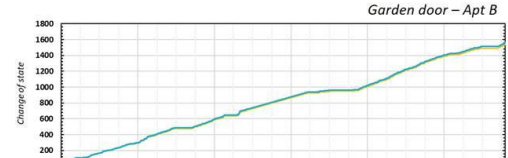



figure 140: Temperature and RH of the construction monitoring system, © Eurac

Interreg Italia-Osterreich Low Tech eurac research CASE STUDY 1 Window operation

**Risultati preliminari** **Vorläufige Ergebnisse**

*Garden door – Apt B*



*All other doors and windows*

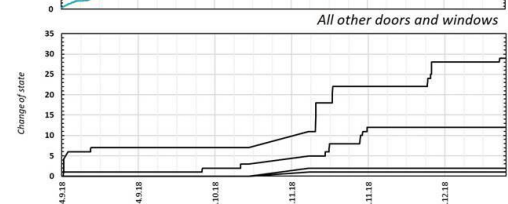
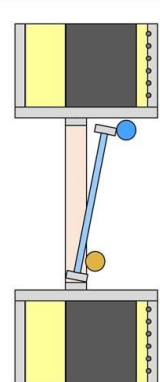





figure 141: Some results of the user behaviour monitoring system, © Eurac

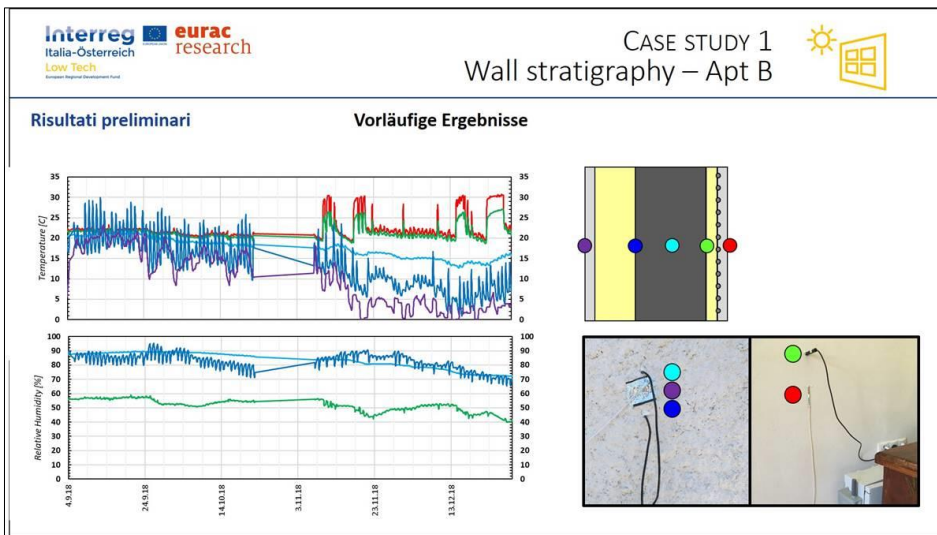

figure 142: Some results of the construction monitoring system © Eurac

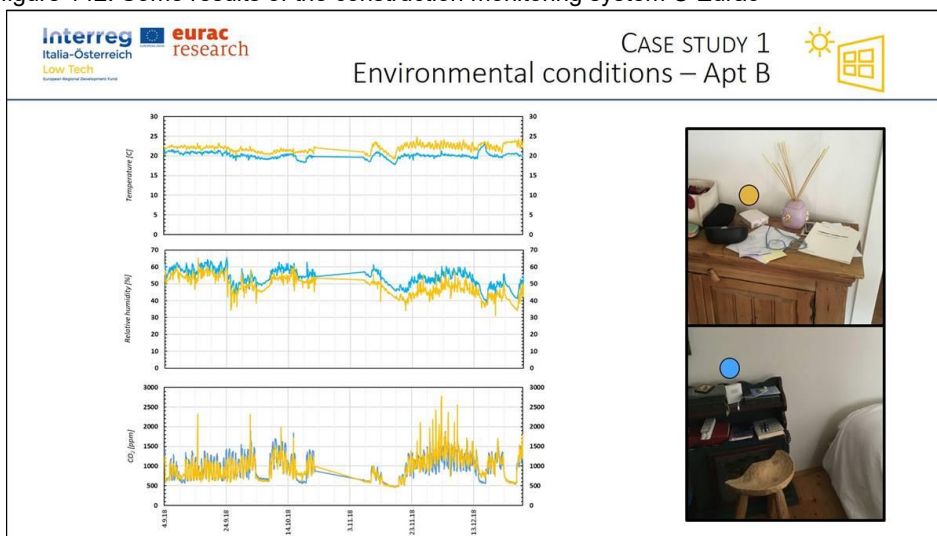

figure 143: Some results of the environmental conditions © Eurac

### 2.3.2.3 External and internal insulation on solid timber wall - Single Family House - Gstaad, Switzerland

Author: Cristina Polo (SUPSI)

#### What is the solution?

Many facades have been cladded with external thermal insulation, using additional solid timber layer while others have been cladded with a thinner inner solid layer to preserve their original external appearance. The construction is divided in two kinds of walls: solid timber for the biggest part and stone walls touching the ground. The U-value post intervention of the solid timber wall is 0,2 W/m<sup>2</sup>K. There was no evaluation of the U-value before the intervention, due to the previous function of the building (rural building not used as living space). The original wall consists of a single layer timber wall, which has been partially maintained with the addition of other layers. All thermal bridges have been resolved to avoid thermal losses.

Description of outer wall (ventilated): Building layer wall cut 1: 15 cm solid timber wood (15% moisture, lambda value 0,13 [W/(mK)]); 0,01 cm of vapor control layer; 15 cm of Flumroc insulation board, made with stone wool with natural binding agent (lambda value 0,035 [W/(mK)]) and 0,02 cm of diffusion-open, wind and weatherproof facade membrane

Building layer wall cut 2: 15 cm of solid timber wood (15% moisture, lambda value 0,13 [W/(mK)]); 0,01 cm of vapour barrier; 16 cm of solid wood timber (15% moisture, lambda coefficient 0,13 [W/(mK)]) and 0,02 cm of diffusion-open, wind and weatherproof facade membrane.

#### Why does it work?

At 84 kWh/m<sup>2</sup>a, the energy index is relatively high, indicating suboptimal insulation values. However, it was a balancing of interests that led to the original walls not being covered with external thermal insulation. For this reason, the layer of 16 cm of solid timber wall was maintained in the main front of the building adding the new wood panelling from the inside (15 cm in total). On the side facades, by the contrary, the 15 cm thick layer of solid wood, which acts also as insulation material, remain visible by the internal face, positioned the external new wood cladding by outside the building, since in these facades the proportion of stone wall is greater than that the timber wall and benefits from a lower loss area given the slope of the land. This made it possible to maintain the original character of the building.

#### Description of the context

Every year in Switzerland more than 2,000 agricultural holdings are abandoned. The buildings often remain unused (CVP-Mo 11.3285). A redevelopment or conversion of older buildings into a residential building, due to the Swiss federal legal restrictions on the preservation of cultural landscapes, is not always possible. However, it is questionable issue that these buildings remain protected but not used any more or uninhabitable. The owner of this building demonstrated that traditional buildings can be well-integrated with the latest technology, with the conversion of the unused Mayensäss in Gstaad in a residential building with the latest standard in energy efficiency and comfort. A comprehensive renovation transformed the unused and unheated wooden house into a modern PlusEnergyBuilding (PEB), that hasn't lost its "old charm."

#### Pros and Cons

This type of approach meets the preservation of the historical aspect of the building. Intervening in two different ways on the wall leads to possible complications (e.g., dampness). The necessary assessments were made, and the solution was possible. At the same time, it has been possible to change the use of the building (from a rural building without any type of thermal insulation) to a residential building and to recover an unused and uninhabited building, reaching high standards of efficiency and comfort for the new inhabitants. The main character of the building has been preserved and the wood solid timber wall maintained in the main façade in the original aspect. Furthermore, a wood cladding in the living spaces allows for faster thermal conditioning and already ensures good thermal-acoustic insulation. In addition, the use is a recyclable and sustainable natural material that helps improve breathability with a positive effect on the indoor climate and on human well-being.

#### Type of Data Available

The renovation process done follows the MuKE-Standard adopted by the intercantonal conference of energy directors (EnDK). The EnDK is the common energy competence centre of the cantons. The "Model Regulations of the Cantons in the Energy Sector" (MuKE) is the "overall package" of energy law model regulations in the building sector that the cantons have jointly developed. The energy calculation is according SIA 380/1 and U-value calculation were made according to SN EN ISO 6946.



### Additional Information

The PlusEnergie-EFH Matti shows in an exemplary way how traditional but unused agricultural buildings can be put to sensible use in order to comply with the Paris Climate Convention without disfiguring the townscape. Climatic zone Cfb (Warm temperature, fully humid, warm summer)

### Is there any related publication?

Solaragentur Swiss Solar Prize Award 2019, Schweizer Solarpreis 2019 (German):

Link: [https://www.solaragentur.ch/sites/default/files/g-19-10-02\\_solarpreispub19\\_fueradag\\_v2.p081.pdf](https://www.solaragentur.ch/sites/default/files/g-19-10-02_solarpreispub19_fueradag_v2.p081.pdf)

### Best practice example:

Single family house – Gstaad, Switzerland – <https://www.hiberatlas.com/en/single-family-house-gstaad-switzerland--2-220.html>



*figure 144: New wood wall (side façade) © Daniel Baggenstos*



*figure 145: Old wall before intervention © Gehret Design*



figure 146: Before renovation © Gehret Design

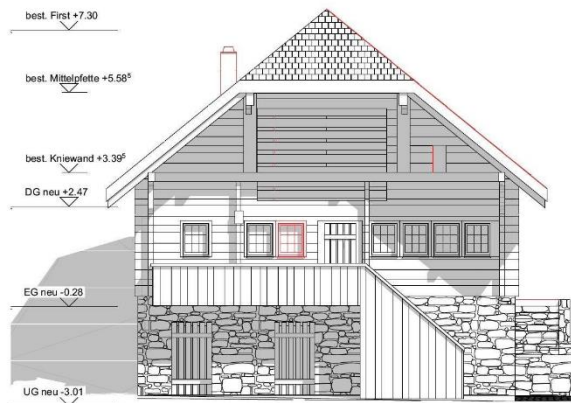
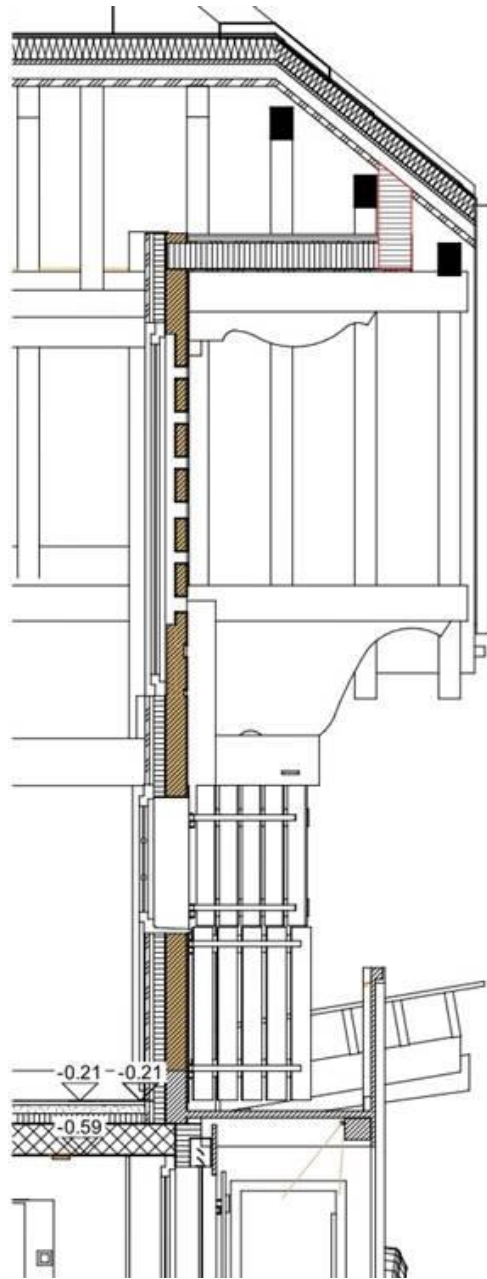

figure 147: Main facade of the building (facade elevation) © Gehret Design GmbH



figure 148: New solid wood cladding inside the building spaces © Gehret Design GmbH



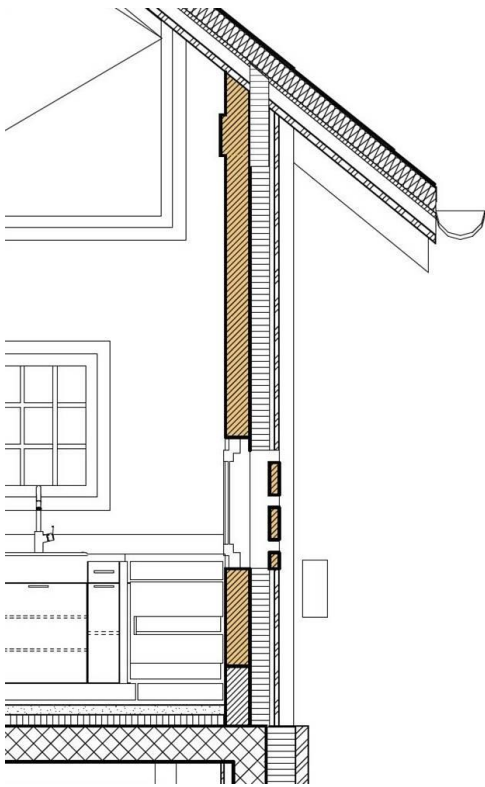

figure 149: Solid timber wall in section, side facade (new cladding wood system from outside). © Gehret Design GmbH

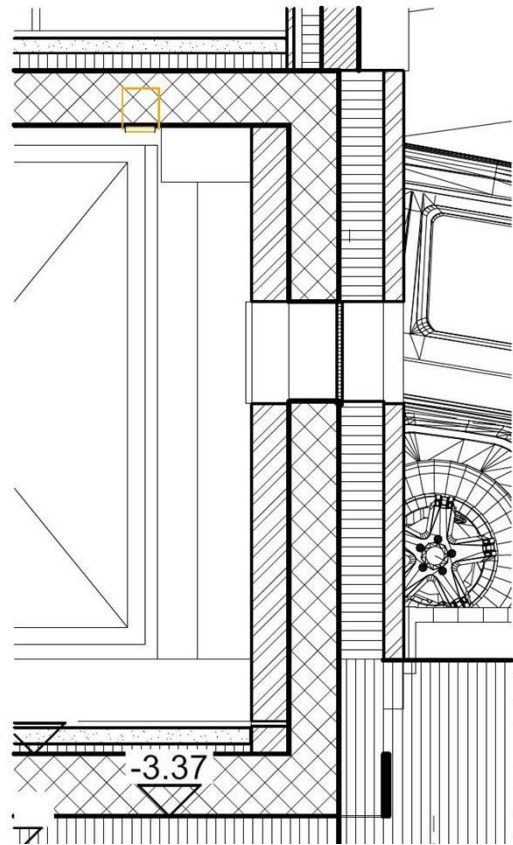

figure 150: Solid timber wall in section, main front façade (new cladding panelling from inside the building). © Gehret Design GmbH

### 2.3.2.4 Stone wall with extruded (XPS) polystyrene insulation - Single Family House - Gstaad, Switzerland

Author: Cristina Polo (SUPSI)

#### What is the solution?

The original construction of the building is divided in two kinds of walls: solid timber for the biggest part and stone walls touching the ground. External stone walls are externally insulated as well as the solid timber ones. The transition between timber wall and stone wall is protected from water infiltration thanks to a moisture barrier. The new wall solution consists in: quarry stone with lime mortar 37 cm (original stone wall, lambda coefficient 1.30 [W / mK]); extruded polystyrene (XPS) insulation board of 16 cm (lambda coefficient 0.035 [W / mK]); artificial stone of 4 cm (lambda coefficient 0.30 [W / mK]). New U-value achieved (U-value calculation according to SN EN ISO 6946): 0.200 W / m<sup>2</sup>K.

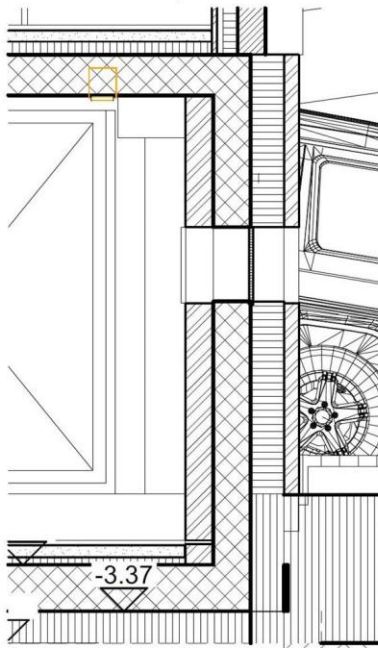

Stone wall in section © Gehret Design GmbH

#### Why does it work?

On the front of the main facade, the basement of the building and the ground floor were built in stone without any insulation. Likewise, in the lower part of the side facades that follow the slope of the land, stone is used as an element in contact with the ground to protect the main wooden facade of the building against humidity and capillarity problems. During the renovation project, the original structure is maintained. The original wall was prepared prior to the addition of the insulation by levelling and reinforcing through the application of a layer of concrete. A moisture barrier has been applied. The wall on the back side of the house, where the basement is fully below ground, is part of the extension and is a simple concrete structure with XPS insulation and a waterproof barrier.

#### Description of the context

The PlusEnergie-EFH Matti shows how traditional but unused agricultural buildings can be put to sensible use in order to comply with the Paris Climate Convention without disfiguring the townscape. A complete renovation has transformed the unused and unheated wooden house into a modern PlusEnergyBuilding, integrating various technical solutions.

#### Pros and Cons

Extruded Polystyrene foam panels, referred to as XPS, is a closed cell insulation product commonly used in renovation and new construction. It allows to prevent water penetration to the structure of the insulation board and provides long term strength and durability giving good performance from the thermal point of view in existing walls. Rigid foam insulation is usually a qualified vapor barrier. However, an installation between the stone wall and the timber wall can pose a challenge. To complete the vapor barrier it would be necessary to foam-seal or tape all the

sides where the solid rigid wall meets timber, because these gaps will facilitate vapor flow. In this case moisture barrier has been applied.

### Type of Data Available:

The renovation process done follows the MuKEn-Standard adopted by the intercantonal conference of energy directors (EnDK). The EnDK is the common energy competence centre of the cantons. The “Model Regulations of the Cantons in the Energy Sector” (MuKEn) is the “overall package” of energy law model regulations in the building sector that the cantons have jointly developed. The energy calculation is according SIA 380/1 and U-value calculation were made according to SN EN ISO 6946.

### Additional Information

Thanks to the energy renovation it has been possible to change the use of the building (from a rural building without any type of thermal insulation) to a residential building and to recover an unused and uninhabited building, reaching high standards of efficiency and comfort for the new inhabitants. Climatic zone Cfb (Warm temperature, fully humid, warm summer)

### Is there any related publication?

Solaragentur Swiss Solar Prize Award 2019 (German):

Link: [https://www.solaragentur.ch/sites/default/files/g-19-10-02\\_solarpreispub19\\_fueradag\\_v2.p081.pdf](https://www.solaragentur.ch/sites/default/files/g-19-10-02_solarpreispub19_fueradag_v2.p081.pdf)



New wall © Daniel Baggenstos



Old wall before renovation © Gehret Design

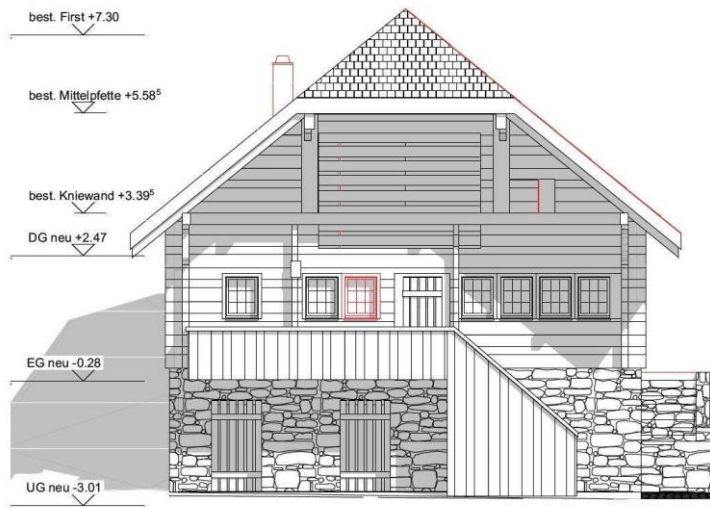

Detail stone wall © Gehret Design GmbH

## 2.3.3 Reversible External Insulation

### 2.3.3.1 Reversible external insulation – Sto Ges.m.b.H

Author: Alexander Rieser (UIBK)

#### What is the solution?

If you want to install a reversible external insulation, there is the possibility to connect the insulation boards to the existing facade with a Velcro connection instead of the conventional fastening with glue. In order to achieve this, the first step is to apply mushroom heads to the façade, which have a Velcro head. The second element of the Velcro fleece is located on the insulation board and is hooked in. By avoiding the use of adhesive mortar, faster construction times and weather-independent installation are achieved.

#### Why does it work?

The problem with the system is the void-free installation of the insulation boards on the existing wall. Those walls are usually not flat. With conventional thermal insulation composite systems, the unevenness is evened out with the adhesive mortar. With the Velcro system, this is achieved with adjustable dowels. However, the adjustment is not made on the existing wall, rather at the front level. If the adjustment of the panel would take place between the wall and the insulation, convective backwashing of the insulation level would be possible and the energetic benefit of the additional insulation would shrink considerably.

#### Description of the context

If the aim is to refurbish facades worthy of preservation with external insulation, this is usually not possible with common solutions, as the original facade is destroyed by the adhesive. With the help of the Velcro system, such facades could still be renovated and a subsequent uncovering of historical facade parts would be possible at any time with almost no damage.

#### Pros and Cons

The great advantage of the system is its ecology. The system can be dismantled very easily, separated according to type of waste and recycled to a large extent. There is less waste because no adhesive mortar is used. Further advantages are the fast installation and the elimination of waiting times due to the drying of the adhesive mortar. As a disadvantage, the flat surface of the insulation must be mentioned. Especially with regard to the renovation of historical buildings. While a flat surface is desired in a new building, the uneven surface of the plaster is often a special feature in a historical building. The system is still in development and unfortunately not yet available on the market.

#### Type of Data Available

The company STO is currently engaged in the development and brand launch of this system. Further information about the system can be found under the following link.

#### Is there any related publication?

[https://www.hiberatlas.com/smartedit/projects/158/sto\\_systain\\_klettfassade.pdf](https://www.hiberatlas.com/smartedit/projects/158/sto_systain_klettfassade.pdf)

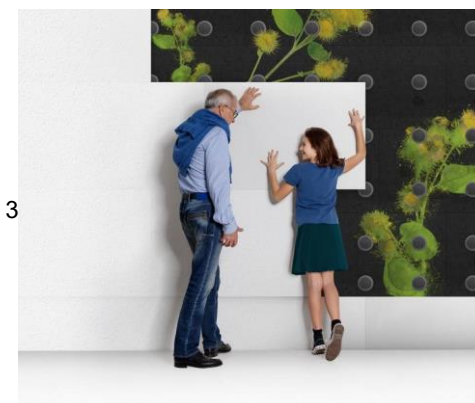

figure 151: © Sto Ges.m.b.H

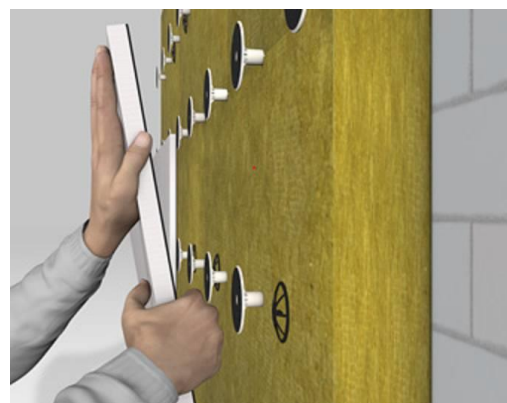

figure 152: Velcro system, © Sto Ges.m.b.H

### 2.3.3.2 Reversible external insulation – façade with cellulose

Author: Pavel Sevela (UIBK)

#### What is the solution?

The solution is a removable external insulated façade including windows. The insulation is made of blown cellulose. The façade is prefabricated, where the windows are also assembled in the factory. The connection is ensured by a steel console mounted on the existing wall and a steel counter piece on the new façade. In order that the distances between the flat new façade and the uneven existing façade can be adjusted, the existing façade is measured with a laser and any unevenness during installation is compensated. Some details can be finished in the building site, such as the adjustment layer in the window reveal and the plaster layer.

#### Why does it work?

This solution gives the possibility to refurbish (with energy improvement) the existing façade of buildings with small building site's effort and high quality. The solution fits to historical building because it is reversible. The thermal bridges (window-wall) are also optimized, thanks to the prefabrication. The moisture safety is ensured by the plates of the façade.

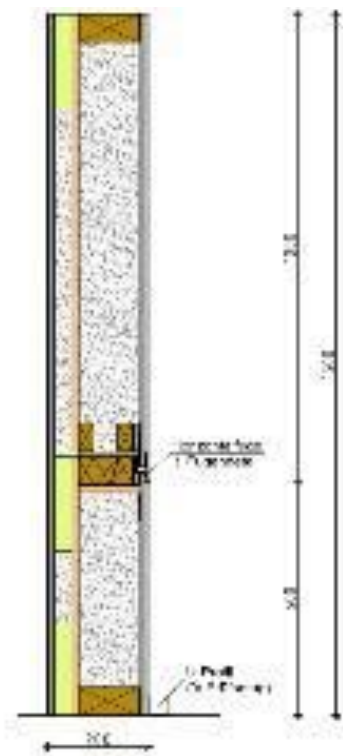

figure 153: Cross section, © Michael Flach



figure 154: Detail of the facade, © Michael Flach

#### Description of the context

The building where the solution was built, is an old not listed farmer building. The wish of the building owner was to refurbish the building energetically. The old façade has no particular historical value apart from one painting. This was covered with the façade and in future will be available again.

#### Pros and Cons

The biggest pros are the small building site effort and the high quality reached thanks to the prefabrication. One con is the covering of the existing façade, especially in case of historical value of it. The change of the outside volume of the building can also be considered as a con for the conservation compatibility.

#### Type of Data Available

The solution is well documented. A master thesis with hygrothermal simulations was done.



Best practice example:

Farm house – Trins, Austria <https://www.hiberatlas.com/de/bauernhof-trins--2-40.html>



figure 155: Farmhouse before and after the refurbishment, © Michael Flach



figure 156: Facade works, © Michael Flach



figure 157: Facade prepared with the supports for the facade, © Michael Flach

## 2.3.4 Frame infill insulation

### 2.3.4.1 Hemp concrete

Author: Julien Borderon (Cerema)

#### What is the solution?

The solution is to replace the original filler material (bricks or cob) in the void of the half-timbered walls. After this first step a lime plaster could be applied on both faces of the wall. The wood structure can optionally remain visible. Depending of the region and the type of building, tradition have been to recover the wood structure or to leave it visible. The façade highly subject to driving rain must be protected with a full plaster and or roof overhang.

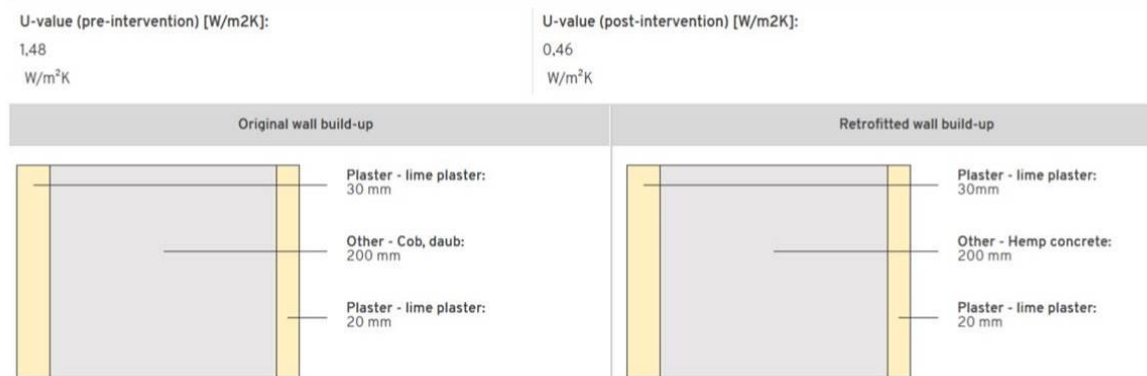

figure 158: Cross section before and after the intervention

#### Why does it work?

This solution works in terms of conserving the historical values due to the unchanged appearance of the façade and preserving the proportions of the building as no additional insulation layers are applied. Considering moisture safety, the hemp concrete is vapour open and "capillary active". A correct plaster is needed on the outside part to manage the rain penetration. This plaster needs to be vapour open and lime is advised with no cement addition. For the air permeability, special care is needed at the interface between wood and hemp concrete. For the energy improvement, the U-value with cob is 3 times higher than the U-value with hemp concrete (original U-value 1,48 W/(m<sup>2</sup>K), retrofitted U-value 0,46 W/(m<sup>2</sup>K)). The thermal result of the refurbishment is not as high as "classic insulation materials" as hemp concrete has a thermal conductivity around 0,1 W/(mK).

#### Description of the context

This solution could be used alone to improve the U-value of the wall but it could also be used in combination with another insulation solution for a better thermal resistance of the wall if necessary. Half-timbered houses usually present strong heritage interest and exterior insulation or exterior changes are not welcome. This sort of construction represents 6% of all the French building built before 1945 that is around 500 000 buildings. The cob or bricks infill materials are sometimes in bad shape and their withdrawal is the opportunity to improve the thermal performance. This solution has also been applied in new construction in historical area (Tourism offices in Troyes, East of France for instance)

#### Pros and Cons

Hemp concrete has several advantages. The required internal finish plaster ensures good air tightness. A further advantage is the diffusion-open, moisture-storing and capillary-active properties of hemp concrete. Hemp concrete is a bio-based material with a very good life cycle analysis (35 kg of stored CO<sub>2</sub> per square meter of wall, to compare with an average of 8 kg of CO<sub>2</sub> release per square meter of wall insulated with R = 2,5 (m<sup>2</sup>K)/W of mineral wool). The main disadvantages are the lower thermal resistance (its thermal conductivity is about 0,1 W/(mK)) compared to other insulation materials. The drying duration is also rather high: in good temperature conditions, 30 days are reasonable to insure the dryness of the whole thickness.



figure 159: Half-timbered house with hemp concrete infill, retrofitting (left part) and new construction (right part) in Troyes, tourism offices © Cerema



figure 160: Hemp concrete in place from inside, © Philippe Glé



figure 161: Application of the hemp concrete from outside © Philippe Glé



figure 162: Before application of the lime plaster © Philippe Glé

### 2.3.4.2 Internal Insulation – Hemp wool

Author: Elodie Héberlé (Cerema)

#### What is the solution?

This solution consists in insulating a timber-framed wall with 20 cm of hemp wool on wood frame. It was then rendered with earth on chestnut laths. No airtightness membrane was installed because the render is naturally airtight when well dosed and executed. A vapour control layer can be installed if the render is not sufficiently airtight. Other bio-based insulation could have been possible (cellulose wadding, wood fibre insulation, sheep wool, etc.)

The exterior façades were rendered with a lime and clay plaster. Between the wooden frame and the render, the plaster is being processed at 45° to the outside. This allows the wind-driven rain to be evacuated away from the wooden frame.

All renders were executed in Spring, in order to let them dry long enough.

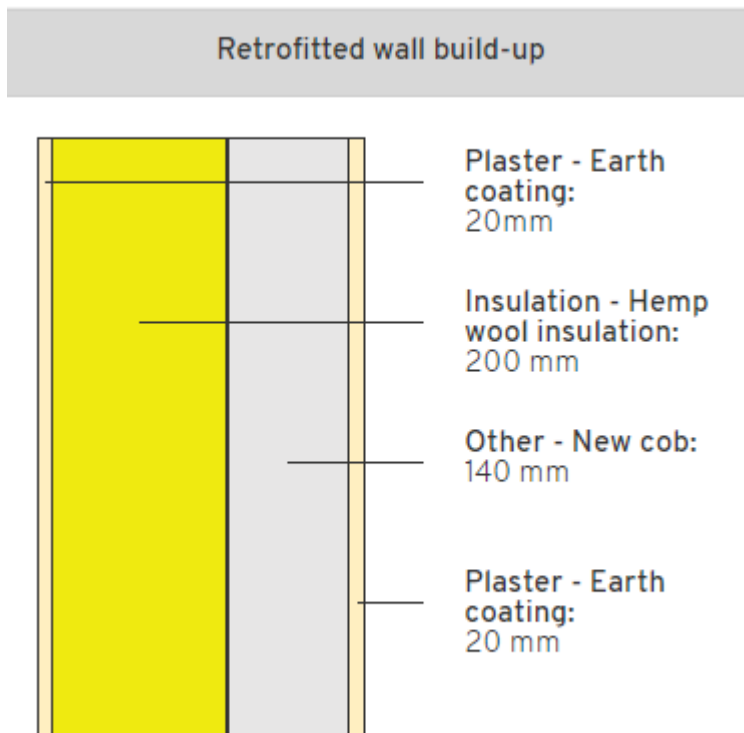

figure 163: Cross section for a retrofitted wall insulated with hemp wool



figure 164: Chestnut laths as a support for the earth render



figure 165: Rendered inner walls

## Why does it work?

Hemp wool is a bio-based insulation that is well adapted to the hygrothermal behaviour of heritage buildings, especially those with cob. Like cob, this insulation system (hemp wool and interior earth render) is indeed vapour-permeable, so moisture can migrate from the inside of the building to the outside through it. However, moisture has to be managed with a vapour control layer when the insulation system is too vapour-permeable, because internal condensation could occur if it is the case.

As it is crucial when retrofitting for several reasons to have an airtight building envelope, this kind of internal insulation technique has to come with an airtightness barrier. This is here the role of the interior earth render.

It is also crucial to limit at minimum thermal losses. That is why a large thickness of insulation is required. Besides, the frame between which the insulation is placed has to be in wood and not in metal in order to avoid thermal bridges.

The internal insulation technique is well adapted to timber-framed buildings with no interior decoration, as an exterior insulation technique could hide the frames that have often a strong heritage value.

## Description of the context

This timber-framed building is located in Saint-Samson-la-Poterie in the Oise region (northern France), over Paris, and especially in the natural region called "Pays de Bray". It was the barn of a landlord housing of the 17th century and it has recently been retrofitted and restored by the owner himself. A careful work on the materials and on the execution was made.

## Pros and Cons:

The pros for this solution are a hygrothermal behaviour adapted to heritage buildings. A good airtightness when installed with an airtight barrier. A good thermal performance when installed in a sufficient thickness and with wood frame instead of metal one. A technique adapted when the exterior has a strong heritage value.

The cons for this solution are the need to be sure that the insulating system is not too vapor-permeable, because internal condensation could occur if it is the case. A hygrothermal simulation can be necessary. The need to be sure that the insulating system is enough airtight. And when there is a vapour control layer and/or an airtightness barrier, that it is well installed, as moisture and air could pass from the interior to the wall without control.

## Type of Data Available:

This solution is well-known and documented for new buildings.



Figure 4: The internal insulated timber-framed barn (Cerema)

## Best practice Example:

"Timber-framed barn in the north of France - <https://www.hiberatlas.com/fr/timber-framed-barn-in-the-north-of-france--2-182.html#section3>

### 2.3.4.3 Straw insulation in hay loft

Author: Pavel Sevela (UIBK)

#### What is the solution?

Straw insulation with timber frame construction and clay plaster was used to refurbish the façade of an old hayloft. The old hayloft wooden boarding was dismantled. The timber frame construction was built. On the outside, wooden fibre plates were installed to facilitate the introduction of the straw in the construction. A driving rain protection and wind protection film and a new wooden panelling (aged with a gas flames) were installed. The internal plaster is made of clay, in order to enhance the internal comfort. The straw came in bales, which were unrolled in the construction. The stands' distance was planned to be the same of the bales' high. The building is an example of self-construction: the owners have been working in the building site.

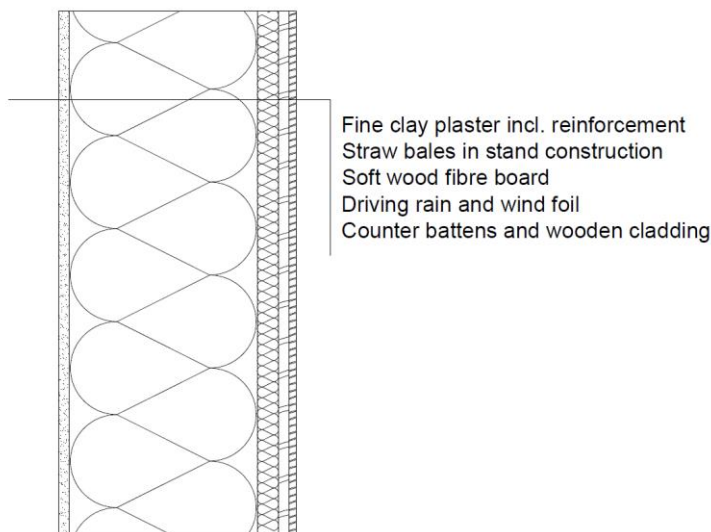

figure 166: Cross section, © UIBK

#### Why does it work?

The solution is interesting in the case of old hayloft to be converted into liveable places. In order to enhance the energy efficiency and the internal comfort, an insulation layer should be installed. Straw insulation is a good solution from the ecological point of view and it is a common material in the alpine space. The moisture safety is ensured through diffusion-open properties of the entire construction. The lambda value of the straw bales on edge is 0,05 W/(mK). The thickness of the straw is 36 cm. <http://baubiologie.at/strohballenbau/strohballenbau/zertifikate-tests/>

#### Description of the context

Four siblings wanted to transform their farmhouse (1949) into an apartment house with four living spaces. They wanted to use ecological materials and they succeeded it using mainly wood, straw and clay. They wanted to refurbish the house mostly in self-construction, some of them took a break from work and worked full- or part-time in the building site. The farmhouse is very close to the city centre and has a big garden. An historical element of the building is the wooden façade of the hayloft and the balconies.

#### Pros and Cons

PROS: Straw is an ecological material which is very common in the alpine spaces (potentially it can be built "km 0"). The solution is suitable to the refurbishment of an old hayloft and also suitable to self-construction projects.

CONS: In order to use the straw bales, the wooden frame construction should be planned in detail. Another disadvantage is the higher lambda value compared to other insulation materials, for this reason it should be thicker than other insulation materials to achieve comparable performance.

## Type of Data Available

Plans and pictures of the building and the construction phases are available on the website:  
<https://www.lendwirtschaft.at/>



figure 167: Construction phase, ©  
Familie Schmölz



figure 168: Straw in stand construction, ©  
Familie Schmölz



figure 169: xxx ©  
Familie Schmölz



### 2.3.4.4 Timber wall with wood wool panels - Glaserhaus - Affoltern im Emmental, Switzerland

Author: Cristina Polo (SUPSI)

#### What is the solution?

The solutions consist in timber wall with wood wool panels that are an environment-friendly, recyclable material made from wood wool, cement and water. The façades have been restored to its original condition, in particular the south front by removing the shingle cladding which was installed later, thus making the stud construction visible again and keeping it in its original grey tone. Only the southern front was not thermally insulated due to protection constraints of historic buildings. The other facades were made with thermal insulation inserted between the wooden rafters to achieve the Minergie-P standard. Minergie-P standard, is a voluntary energy Swiss certificate based on the concept of building oriented to the minimum energy requirement, which also presupposes a better use of passive heat sources such as solar radiation to cover the heat demand.



figure 170: Cross section before and after the intervention

#### Why does it work?

The chosen solution is very traditional and particularly allows to respect the historical protection constraints, as well as the requirements for energy saving. It creates thicker walls, but with external and internal surfaces that over time will become grey like the previous wooden cladding. The protection against vapour (to prevent water vapour condensation) transmission is carried out by the OSB panel. After renovation a huge improvement of the U-value of the walls were achieved from 3,00 to 0,16 W/(m<sup>2</sup>K), and this result in an overall higher energy efficiency of the building envelope and increased comfort for users.

#### Description of the context

Former farmhouse known as "glazier or doctor house", was built in 1765/66 and renovated in 1888. Impressive stand/beam construction under a quarter hipped roof, rising from the vaulted cellar from 1766. The shingle-covered building, whose present appearance is mainly due to the 1888 alteration, has a high, 3-storey, well-windowed front crowned by a roundabout. The eaves-sided upper floor arcades are closed. Contoured woods (braided bows); distinguished grey frame. Gabled building with an extraordinary volumetry. The aim of the project and the associated construction measures are to repair the existing and restore the original condition. The floor plans will be spatially and functionally separated, with the aim of consistently uncovering the core building from 1765 on all floors. This restoration aims of preserving the overall appearance of the building, repairing the roof, facades and surroundings and carefully restoring the prestigious south facade. From a technical point of view, the building is solidly stabilised and energetically brought up to the latest standards.

#### Pros and Cons

The appearance of this wooden masonry is very traditional, and you do not notice the thermal performance except at the openings where you can perceive the depth of the wall greater in comparison to historical wooden buildings. The choice of materials is 100% natural, all in wood, even with the use of wood wool as thermal insulation. The work is simple to carry out and therefore does not cause any increase in costs. Wood wool panels are moisture-resistant material evens out air humidity by absorbing or emitting moisture from or to the ambient air. This

contributes to a pleasant indoor climate, both for increase comfort and health. The high pH value also discourages mould and the material is not affected by rot. The material dampens noise and contributes to good acoustics.

### Type of Data Available

The solution is well documented. After the retrofit, which implies several energy-efficiency measures and the use of renewables, the energy demand of the building decreased by 87% after the intervention to 26,200 kWh / a. A new 89 kWp photovoltaic BIPV system integrated in the roof of the building generates 90,500 kWh / a. with covering of total energy requirements of about 345% as Plus Energy Building (PlusEnergieBau, PEB) for the energy transition. For this reason, the project PlusEnergieBau renovation Anliker, Affoltern iE was awarded with the Swiss Solar and the European Solar Prize in 2016.

Monitoring data: <https://www.energie-cluster.ch/de/deklariert-ch/plusenergiegebaeude/efh-anliker-sanierung-eggerdingen-7-3416-affoltern-im-emmental-9-3495.html>

### Is there any related publication?

Nachhaltig Bauen, 2-2016 (German):

[https://www.hiberatlas.com/smarteredit/projects/234/clevergie\\_Affoltern\\_MegaSlate\\_1.pdf](https://www.hiberatlas.com/smarteredit/projects/234/clevergie_Affoltern_MegaSlate_1.pdf)

Solaragentur Swiss Solar Prize Award 2016 (German): [https://www.solaragentur.ch/sites/default/files/g-16-09-21\\_peb\\_sanierung\\_anliker\\_affoltern\\_def.pdf](https://www.solaragentur.ch/sites/default/files/g-16-09-21_peb_sanierung_anliker_affoltern_def.pdf).

[https://www.hiberatlas.com/smarteredit/projects/234/g-16-09-21\\_peb\\_sanierung\\_anliker\\_affoltern\\_def\[1\]\\_1.pdf](https://www.hiberatlas.com/smarteredit/projects/234/g-16-09-21_peb_sanierung_anliker_affoltern_def[1]_1.pdf)

### Best practice Example:

Glaserhaus - Affoltern im Emmental, Switzerland - <https://www.hiberatlas.com/en/glaserhaus-affoltern-im-emmental-switzerland--2-234.html>



### 2.3.4.5 Wood fibre boards and internal mineral wool insulation

Author: Nathalie Vernimme (Flanders Heritage Agency)

#### What is the solution?

The solution consists in insulating a timber-framed wall (wooden truss, loam and wickerwork) with a combination of wood wool fiber boards and a clay plaster finish in the framework and a retention wall with mineral wool insulation at the interior side. A pipe -service -pillar was provided on the inside. The visual perception of the wall seen from the exterior has not altered. The truss structure is not visible on the inside of the wall. The modifications made to the wall in function of energy-efficiency were approved by the conservation authority.



figure 177: Details of the original wall composition with wooden fence, visible wickerwork and loam (copyright Erfgoed en Visie bvba)

#### Why does it work?

The natural structure of the fiberboard insulation and the clay plaster, with its humidity regulation properties, ensures a stable moisture balance and vapor tension regulation of the wall. Water vapour can get in and it can just as easily get out. This makes it well adapted to the hygrothermal behavior of heritage buildings. The wood fiber boards are used to create a weather tight shell that keeps the building warm in winter but, as importantly, cool in summer. The moisture can be managed with a vapour (internal sheet of OSB) control layer to avoid internal condensation. As it is crucial when retrofitting to have an airtight building envelope, this kind of insulation technique has to come with an airtightness barrier. The main purpose of the retention wall, filled with rock wool insulation at the interior side of the wall was extra acoustic insulation.

#### Description of the context

This half-timber-framed, rendered vernacular detached building with late 17th century core is situated in the village centre of Alken. Alken is a small village with 11.500 inhabitants situated in the fruit region Haspengouw in the province of Limburg in Flanders, Belgium. The village was first mentioned in documents in 1066. It developed in the valley of the river Herk. The type of architecture is a double house with an increased ground floor. It consists of 8 bays and one building layer. The half-timbered construction was once typical and characteristic for the entire building territory of Alken. The building is one of the only 3 remaining half timber-framed houses in Alken. The building was out of use and in a very bad state at the moment of renovation. It was almost completely stripped down to the bearing structure. The purpose of the total building renovation (including improvement of energy performance and comfort) was residential reuse. From a heritage point of view the renovation of the walls had to be performed with artisanal techniques and materials of the same kind and dimensions, the restoration of the structure - where needed - and the preservation (as much as possible) of the wooden style and framework of the outer walls.

|   |           |               |           |   |
|---|-----------|---------------|-----------|---|
| Original wall build-up<br>(outside to inside) | Outermost | Rendered      | 2-4 cm    | finishing: loam                                     |
|   | Layer 2   | Other         | 10-14 cm  | filling of framework structure: loam + wooden fence |
|   | Layer 3   | material      | thickness |   |
|   | Layer 4   | material      | thickness |   |
|   | Layer 5   | material      | thickness |   |
|   | Layer 6   | material      | thickness |   |
|   | Innermost | Plastered (or | 2-4 cm    | finishing   |

figure 178: Original wall build-up

Different scenarios where possible for the filling of the wooden truss:

- 1.) re-installation of the traditional wickerwork and loam, with or without extra insulation from the inside
- 2.) filling the compartments with wood fibre insulation boards or wood wool
- 3.) a filling with lime hemp blocks

The first scenario was not chosen because the fear of high maintenance, concerns about insulation values and the labour-intense and therefore expensive installation. The third scenario was a plausible solution, but the architect chose the second scenario (wood fibre board is less expensive and easier to handle than hemp blocks). The steps described in the restoration file where the following: tensioning and bracing of the truss structure, after which the half timbering could be repaired, cleaned, restored and treated. For the replacements of deteriorated or damaged parts, the same type of wood (oak) in the same dimensions would be provided. After this the insulation of the truss structure could be executed by filling in the boxes with wood fibre insulation boards, and an extra wood fibre board, to be finished with a render.

During execution the restoration plans where changed. The wood fibre insulation board that was provided on the inside was replaced by a retention wall, filled with rock wool insulation. The main purpose of the change of the intervention was extra acoustic insulation. As a result, the thickness of the façade package has increased considerably and the truss structure is no longer visible on the inside. This is acceptable from a heritage point of view, since the insides of vernacular half-timbered buildings used to be often thickly draped, limed or papered. A better option would have been though to provide a clay plaster as interior finishing layer. Such a finish would have reflected more with the 17th-century look.

The build-up of the retrofitted wall was the following: 20 mm clay plaster, 60 mm wood fibre insulation board, 40 mm wood fibre insulation board, battens + 63 mm+ 60 mm rock wool insulation, 18 mm OSB board vapor control layer, framework, 43 mm pipe (service) cavity and 2X12,5 mm plasterboard

The facade insulation resulted in limited energy savings on primary energy consumption of approximately 5% or 8,077 kWh / year or approximately 485 EUR / year, which yielded an E-level gain of 16 E points.

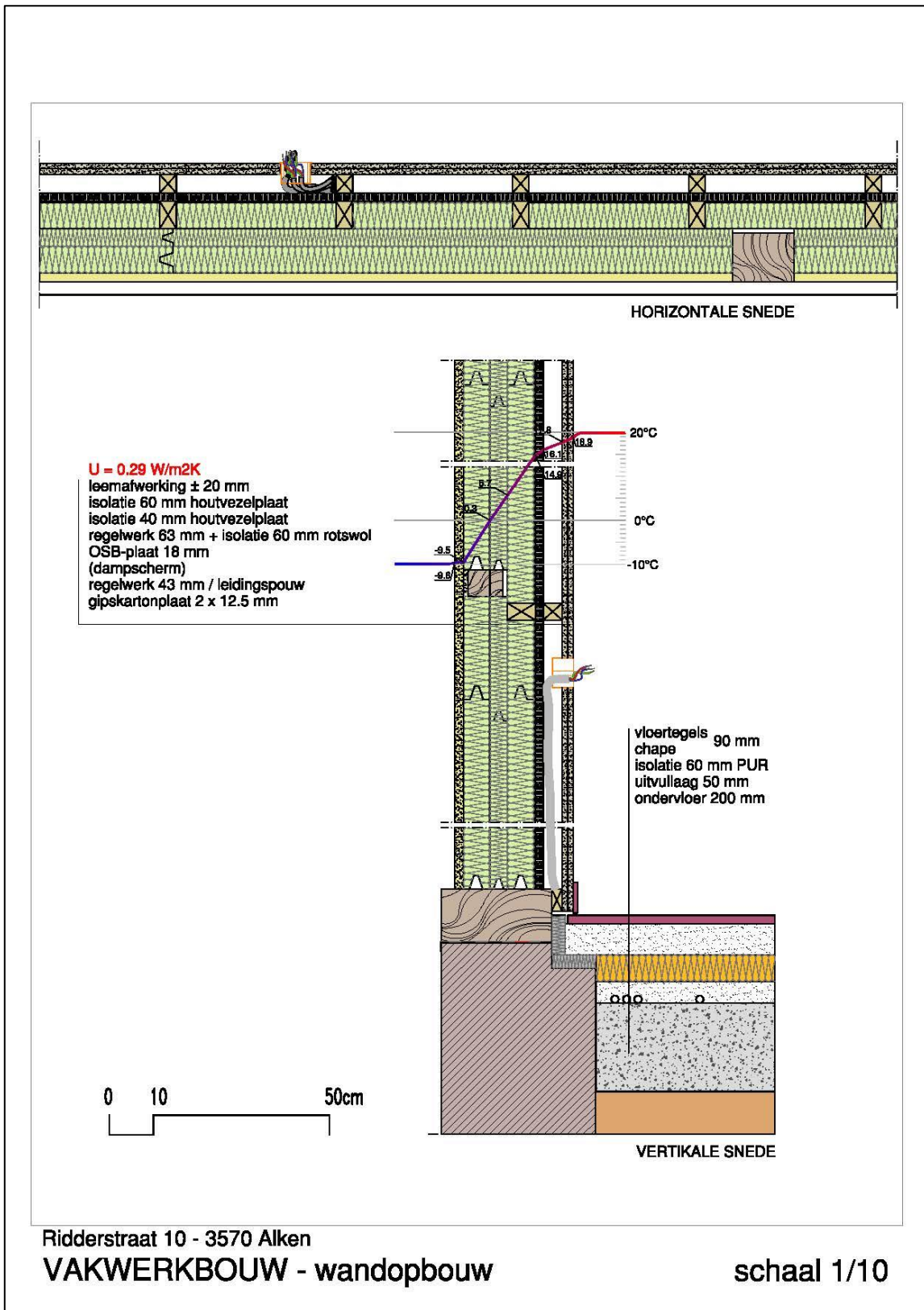

figure 179: Cross-section for the retrofitted wall insulated with wood wool fiberboards and mineral wool



*figure 180: Rear wall of the half timber-framed house in Alken during intervention*

#### Pros and Cons:

The pros for this solution are: the wood fiber insulation boards are a natural product, and have a good Life Cycle Assessment over the whole life time, have a good fire resistance and excellent hygroscopic properties, so the risk of damage to the building envelope is reduced. The wood fiber insulation boards have a high thermal performance and offer acoustic insulation. The boards ensure an easy and safe installation. They can be cut to shape without producing irritating fibers and don't need extra support, the boards won't fall or sag. The rock wool is made for 70-90% out of recycled material, acts as a sound insulator, has a good fire-resistance, is mildew resistant, is moisture resistant and vapor permeable and is easy to install. The characteristic timber framework remains visible in the exterior of the walls. The original 17th-century appearance has not been changed and it is not even visible that there is any isolation between the style and framework. The hygrothermal behavior is adapted to heritage buildings and a good airtightness can be achieved when the solution is installed with an airtight barrier.

The cons for this solution are: The wood fibre insulation boards are not the cheapest insulation material on the market and the rock wool is non-biodegradable. By installing the retention wall with rockwool at the inside of the wall the truss is not visible from the interior. Another point is the need to be sure that the insulating system is enough airtight.

#### Type of Data Available:

This solution is well-known and documented. Wood fibre boards are used across Europe as cavity insulation in timber frame applications. Additional Information: Best practice example "Half-timber-framed house in Alken, Belgium": [Half-timber framed house in Alken, Belgium \(hiberatlas.com\)](http://hiberatlas.com)



*figure 181: Half timber-framed house in Alken before (left ) and after (right) restoration in 2016.*

**Best practice Example:**

“Half-timber framed house in Alken, Belgium”, <https://www.hiberatlas.com/en/half-timberframed-house-in-alken-belgium--2-58.html>



## 2.4 Assessment of solutions according EN 16883:2017

### 2.4.1 Methodology of Assessment

The European standard EN 16883:2017 acts as a guideline for building owners, authorities and professionals to apply the existing standards in the field of energy efficiency to the specific requirements of historic buildings. It proposes and describes a systematic procedure for improving energy performance of historic buildings and, in particular, the assessment and selection of the appropriate measures that match the requirements of the building in question.

The standard provides a number of assessment criteria in the following categories:

- Technical compatibility
- Heritage significance of the building and its settings
- Economic viability
- Energy
- Indoor environmental quality
- Impact on the outdoor environment
- Aspect of use

In the course of IEA SHC Task 59, the criteria of the standard have been specified in detail in order to conduct a detailed assessment of the individual topics. The aim is to show how the assessment criteria should be applied and to convey the scope of such a detailed assessment. The following chapter contains the adapted and detailed assessment catalogue for the renovation of historical external walls. Further on, the criteria catalogue is presented and exemplified in chapter 2.4.2.2 with the help of some practical examples.

## 2.4.2 Detailed Assessment of walls

### 2.4.2.1 Detailed Assessment criteria catalogue for walls

#### Technical compatibility

##### *Hygrothermal risks*

The likelihood of moisture accumulation within the insulated wall will be evaluated, considering indoor and outdoor moisture sources. If excess moisture accumulation occurs at areas that can lead to other risks, see below. **(MGI < 1,0)**

##### *Structural risks*

Structural risks will be considered if insulation is applied on walls with structural elements that are vulnerable to moisture (e.g. timber, iron). See corrosion risks and biological risks.

##### *Corrosion risks*

If insulation is intended for solid walls with metalwork (e.g., structural ironwork), the influence of insulation on corrosion risk will be considered. **(Corrosion protection existing?)**

##### *Salt reaction risks*

The likelihood of salt efflorescence will be evaluated. The influence of insulation on exacerbating/mitigating the effects of liquid water penetration in the masonry (associated with rainwater, groundwater, or leaks). **(protection against rising damp / driving rain available?)**

##### *Biological risks*

Mould growth (health risk) on internal surfaces (see thermal bridges) or interstitial surfaces (i.e. surfaces of building materials composing the wall) that may be in contact with the indoor environment will be evaluated. **(Thermal bridges - temperature factor frsi (EN ISO 10211))**

If insulation is intended for solid walls with timber elements (e.g. lintels) or connected to timber elements (e.g. floor joists), the influence of insulation on wood rot (structural risk) will be considered. **(wood damage according VVT-model)**

##### *Robustness/Buildability/design/Application*

The ability of a system to deal with uncertainty and variability of moisture sources will be evaluated. The complexity of application will be evaluated (see "thermal bridges/connection").

##### *Thermal bridges/Connection*

Ease of insulation at junctions, to ensure thermal coherence of the fabric, will be evaluated; the evaluation must consider the risks of surface mould growth and condensation.

Ease of connections (e.g. sealing of VCL), and need for maintenance of connection over time is also evaluated. **(Experience in implementation?)**

##### *Reversibility*

If the insulation system is intended to provide reversibility, ease of reversibility will be evaluated, considering the use of hard materials for bonding and the use of mechanical fixings. Also, visual damage to the existing interior finish due to mould growth or condensation will be evaluated.

## Heritage significance of the building and its settings

### *Material, constructional, structural impact*

Any refurbishment should aim at achieving the optimal protection of the existing building structure. In the field of preservation of historic monuments, however, there is a need for preservation beyond the purely structural demands, including the preservation of certain building attributes and the values they convey. This can be a specific construction technique, definable construction phases expressed by the use of different materials, wooden parts allowing the dating of a construction, etc.

When applying internal insulation, a distinction must be made in particular between wet and dry systems. The excess water from contact layers (adhesive mortar) or internal insulation plasters can, for example, destroy existing layers of paint or even original plaster layers. Reversibility is by no means 100% possible in this case.

Furthermore, the chemical alteration of materials (for example with the hydrophobisation) can bear risk to the historical material structure and lead to damage.

**(Do the used materials attack the existing structure / surface in any way?)**

### *Architectural, aesthetic, visual impact*

A visual impact caused by interventions on the external walls, e.g. insulation, concerns two main aspects: A) the visual change of the historic surface and B) the change of geometrical relationships. The former is particularly relevant when historic wall finishes, plaster layers or even historic colours and paintings are still present and are covered by the application of new layers. This might apply to both the external and internal sides of the wall. The geometric relationships of a facade might be changed when applying new layers, e.g. the ratio of window opening to wall surface changes will be impacted by insulation of reveals, or the symmetry of existing ceiling stucco is shifted by interior insulation.

In conclusion, the evaluation is therefore always carried out as an impact assessment of the renovation measures on existing attributes. Which wall surfaces are changed and to what extent? Where does the geometry changes by applying additional layers? What influence does this have on adjacent components (eaves, windows, cornices, interior stucco)?

### *Spatial impact*

For the installation of the internal insulation, the spatial impact partly affects the same points already mentioned above regarding the change of geometrical relationships. If rooms are designed as complete works, or if components are specially adapted to existing construction geometries (interior shading elements), the application of internal insulation poses a risk.

## Economic viability

### *Capital costs*

The direct cost of installing the solution and the economic savings will be evaluated (prior to installation). If the installation is done in combination with other measures, not referring to energy renovation, then only the additional costs caused by renovating the wall is to be included, to evaluate whether the installation is economic viable, based on estimates of installation cost and energy savings, and expected service life (example: if scaffolding is needed for repairing the roof to avoid moisture damage and it can also be used when installing external insulation, the cost of the scaffolding is not to be included).

[this is based on the Danish building regulations, that states that you only must comply to specific U-values if it is economic feasible. If not, you must do as much as possible. Further it must be moisture safe]

[There is a French Decree on “embedded thermal improvement when renovating” that say the same.]

The capital cost could also be expressed using a monthly credit payment considering the cost of the credit at the moment as most of the building’s owners will need such arrangement. This will also permit to compare the monthly economic saving with the credit payment.

### *Operating costs, including maintenance costs*

Economic viability can also be evaluated including the operation/maintenance costs (life cycle economy). This may influence which specific solution to choose, in the case more than one solution is considered.

### *Economic savings*

To assess the economic savings, one must perform thermal simulations of the buildings before and after the retrofitting. The result in energy consumption difference must be converted in money considering a scenario of increase in the energy purchase price year after year. It is also possible to consider the increase of the value of the retrofitted building in some cases.

### *Economical return*

The calculation of the economical return should be based on the overall levelized cost. It begins with the capital cost as defined in the capital cost section plus the cost of the credit if needed. Then the discounted cost of the expected operating and maintenance cost on a fixed period (usually 30 years) are added. The economy on the energy bill have to be calculate considering a scenario of an increase in the purchase price. This scenario has to be stated. The economical return has to be compared with the expected service life. Two kinds of calculation could be performed: with or without public subsidies.  
Reference (standard ISO 15686-5)

## **Energy**

### *Energy performance and operational energy demand in terms of primary energy rating (total), primary energy rating (non-renewable), primary energy rating (renewable)*

Regarding the solutions for the walls, the improvement of the U value will be evaluated. How the solution resolves the thermal bridges (such as window wall connection, wall roof connection and wall basement connection) will also have a role in the evaluation. This criterion is compulsory, that means that every solution proposed for the walls should give an energy improvement for the existing building.

### *Life cycle energy demand in terms of use of renewable primary energy and non-renewable primary energy*

The LCA analysis' result (if available) is evaluated. In the LCA calculation are considered all the stages of the life of the product: from the raw material extraction, through the material manufacture, to the disposal or recycling.

## **Indoor environmental quality**

*Maintaining the desired level of indoor environmental quality and user comfort is the prime objective of most buildings. The indoor environment shall be suited for the intended future use of the building. A poor indoor environment may be a reason to improve the energy performance of a building.*

*Indoor environmental conditions suitable for building content preservation*

Indoor environmental targets should be determined by general standards for the conservation of the building content, including movable cultural heritage objects. The indoor environmental requirements to achieve building conservation have been specified in EN 15757.

*Indoor environmental conditions suitable for building fabric preservation*

Indoor environmental targets should be determined by general standards for the conservation of the building fabric, including fixtures and decorative surfaces of the interiors. The indoor environmental requirements to achieve building conservation have been specified in EN 15757.

*Indoor environmental conditions suitable for achieving good occupant comfort levels*

Indoor environmental targets should be determined by general standards for occupants' comfort. The indoor environmental requirements to achieve user comfort have been specified in EN 15251, EN ISO 7730, and ASHRAE 62-2001.

*Emission of other harmful substances*

In addition to the evaluation of the renovation solution on the durability of the building and its content, and the comfort of its occupants, it is necessary to prevent any harmful emission that might have a negative effect on users' health. Additional information on protection of public health from risks due to a number of chemicals commonly present in indoor air can be found in the WHO Guidelines for Indoor Air Quality: Selected Pollutants.

## **Impact on the outdoor environment**

*Life cycle energy demand in terms of greenhouse gas emissions and emission of harmful substances*

The LCA analysis' result (if available) is evaluated. In the LCA calculation are considered all the stages of the life of the product: from the raw material extraction, through the material manufacture, to the disposal or recycling. The LCA should focus on the ecological impact of the material's life, with the focus on greenhouse emissions and emission of harmful substances.

## **Aspects of use**

*Influence on the use and the users of the building*

If the implementation of a new insulation system requires a certain interaction of the user with the building, this should be assessed beforehand. The assessment should look at the existing patterns and the behavioural changes needed to accommodate the new system (for instance, if the installation of a system with a vapour control layer limits the use of nails and screws to hold furniture, a change in the user behaviour must be considered and suitable alternatives foreseen).

## 2.4.2.2 Detailed Assessment examples of Walls

### 2.4.2.2.1 Farm Trins - Reversible external façade with cellulose

#### Technical compatibility

##### Hygrothermal risks

Due to a plaster system with very low water uptake coefficient the risk of moisture accumulation as a result of driving rain is negligible. The vapor-permeable plasterboard panelling can drain excessive condensation thus relative humidity remains below the critical 80 percent mark<sup>1</sup>.

##### Structural risks

As indicated by the hygrothermal simulation the wood damage limit is constantly being undercut and the average wood moisture content of 14% is far beyond the limit value of 20%<sup>1</sup>.

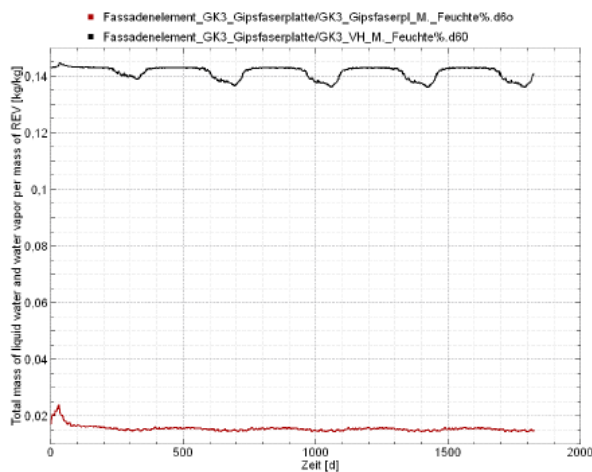

Source: (Prugger, 2019)

##### Corrosion risks

The Sherpa EFcon Connector is completely made by aluminium so that there is no danger of corrosion. The connector is located inside the insulation layer.

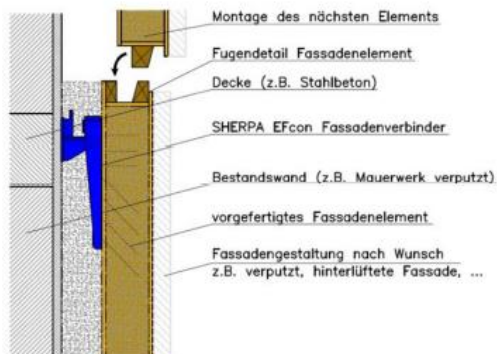

Source: (Prugger, 2019)

##### Salt reaction risks

The interaction of a very low water uptake coefficient and several vapor barriers as plasterboard and limestone wall result in a minimum water penetration and therefore no salt efflorescence.

### Biological risks

The VTT-Model<sup>iii</sup> provides evidence that there is no significant mould growth in the masonry after a transient response of 500 days<sup>1</sup>.

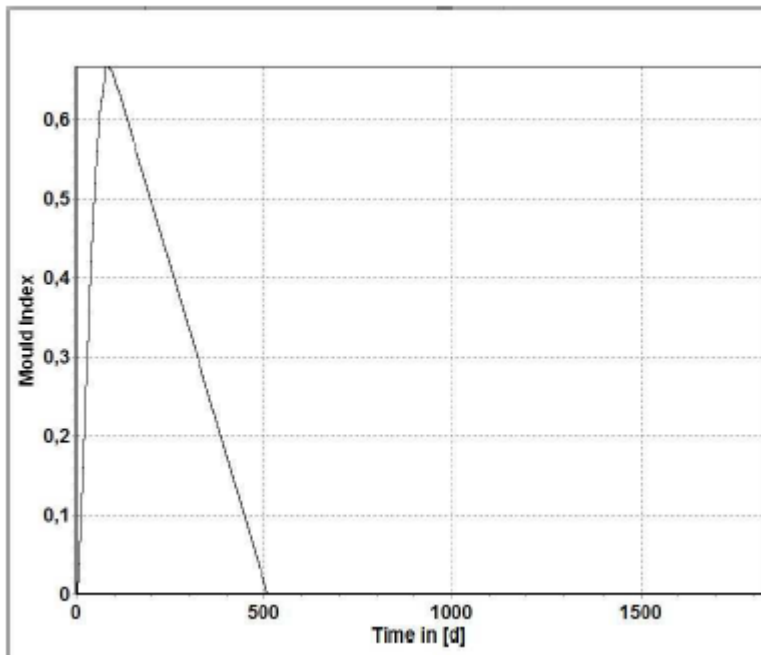

Source: (Prugger, 2019)

### Robustness/Buildability/design/Application

During hygrothermal simulation the façade undergoes 5 annual cycles of weather data provided by the software<sup>iii</sup>. Once the transient response ceased, a declining tendency in wood moisture becomes apparent and robustness is provided<sup>1</sup>.

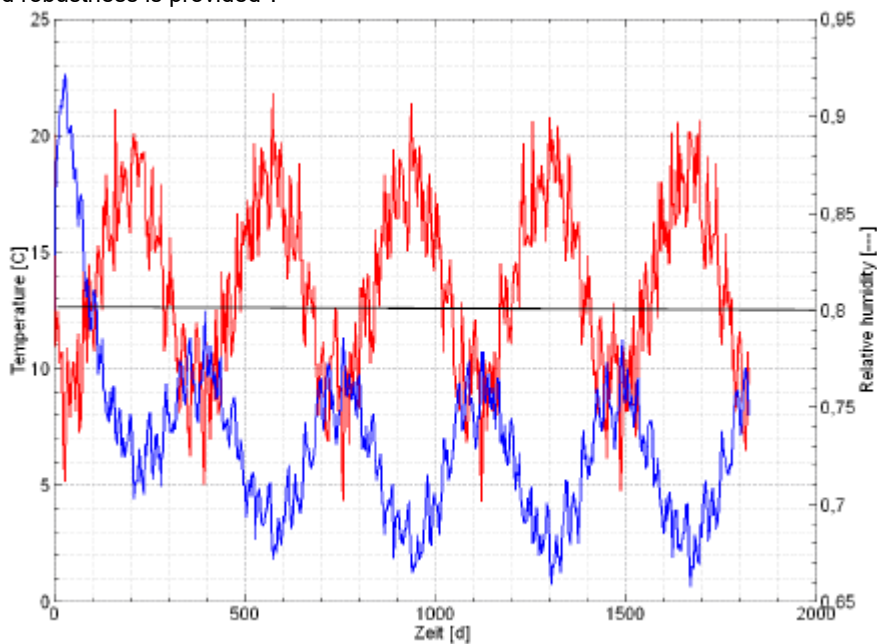

Source: (Prugger, 2019)

### *Thermal bridges/Connection*

Within the construction process special attention has been paid to avoid thermal bridges in the modular design. In conclusion there is no heat loss at any joint detail as seen on thermal images.

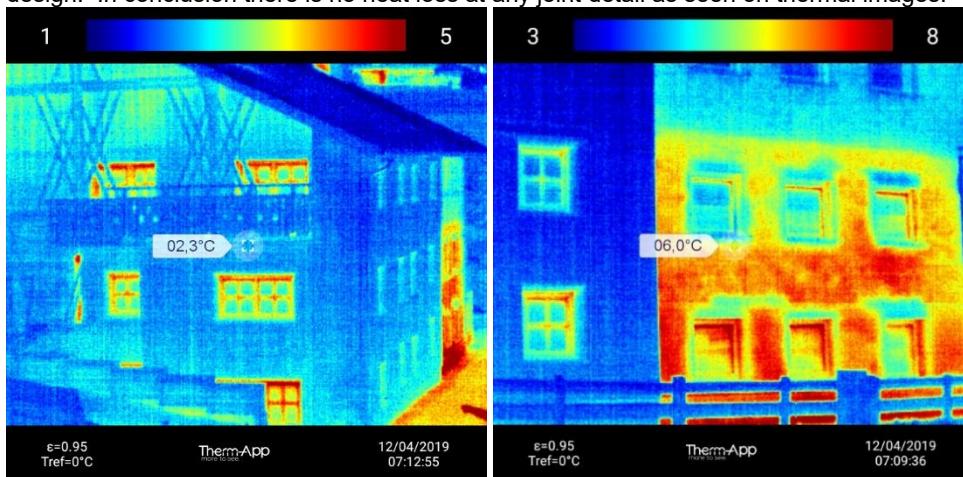

### *Reversibility*

One of the most important advantage of the façade system is its complete reversibility. After the removal structural holes can be covered in compliance with monument conservation guidelines if no other historic wall paintings are affected.

## **Heritage significance of the building and its settings**

### *Material, constructional, structural impact*

The historic limestone wall is protected against external influences by the façade element that furthermore operates as additional vapour barrier. In order to preserve the load-bearing behaviour of the existing limestone wall, the separate modules are self-supporting or at most anchored on the wall. The historic lime plaster allows the wall system to buffer excessive water and slowly release it in order to cause no chemical alteration leading to damage.

### *Architectural, aesthetic, visual impact*

During development, preserving the outer appearance was the most important boundary condition. Nevertheless, extending the buildings volume and covering a wall painting were compromises made to achieve the best possible thermal envelope, as well as straightening the historic facade. Because internal insulation was renounced, the existing wood paneling could be reinstalled after restoration. The size and position of the windows was not altered thus preserving the historic frontage. Nonetheless in order to amplify incoming light admission the inner window soffit was chamfered.



## Economic viability

### *Capital costs*

The direct cost of installing the solution and the economic savings will be evaluated (prior to installation). If the installation is done in combination with other measures, not referring to energy renovation, then only the additional costs caused by renovating the wall is to be included, to evaluate whether the installation is economic viable, based on estimates of installation cost and energy savings, and expected service life (example: if scaffolding is needed for repairing the roof to avoid moisture damage and it can also be used when installing external insulation, the cost of the scaffolding is not to be included).

*[this is based on the Danish building regulations, that states that you only must comply to specific U-values if it is economic feasible. If not, you must do as much as possible. Further it must be moisture safe]*

*[There is a French Decree on “embedded thermal improvement when renovating” that say the same.]*

The capital cost could also be expressed using a monthly credit payment considering the cost of the credit at the moment as most of the building's owners will need such arrangement. This will also permit to compare the monthly economic saving with the credit payment.

### *Operating costs, including maintenance costs*

Economic viability can also be evaluated including the operation/maintenance costs (life cycle economy). This may influence which specific solution to choose, in the case more than one solution is considered.

### *Economic savings*

To assess the economic savings, one must perform thermal simulations of the buildings before and after the retrofitting. The result in energy consumption difference must be converted in money considering a scenario of increase in the energy purchase price year after year. It is also possible to consider the increase of the value of the retrofitted building in some cases.

### *Economical return*

The calculation of the economical return should be based on the overall levelized cost. It begins with the capital cost as defined in the capital cost section plus the cost of the credit if needed. Then the discounted cost of the expected operating and maintenance cost on a fixed period (usually 30 years) are added. The economy on the energy bill have to be calculate considering a scenario of an increase in the purchase price. This scenario has to be stated. The economical return has to be compared with the expected service life. Two kinds of calculation could be performed: with or without public subsidies.

Reference (standard ISO 15686-5)

## Energy

*Energy performance and operational energy demand in terms of primary energy rating (total), primary energy rating (non-renewable), primary energy rating (renewable)*

Regarding the solutions for the walls, the improvement of the U value will be evaluated. How the solution resolves the thermal bridges (such as window wall connection, wall roof connection and wall basement connection) will also have a role in the evaluation. This criterion is compulsory, that means that every solution proposed for the walls should give an energy improvement for the existing building.

*Energy performance and operational energy demand in terms of primary energy rating (total), primary energy rating (non-renewable), primary energy rating (renewable)*

The most important prerequisite of the retrofit solution was an improvement of the U value. Resulting from the added insulation layers a wall heat transition coefficient of  $0,119 \text{ W/m}^2\text{K}$  was achieved. Compared to the previous value of  $2,128 \text{ W/m}^2\text{K}$  the energy-saving potential becomes apparent. By integrating the new windows ( $U= 0,9 \text{ W/m}^2\text{K}$ ) during prefabrication thermal bridges nearly do not have an impact on the window wall connection. After the general assembly cellulose insulation is blown into the wall soffits improving the thermal bridge even more. The effect is visible on thermal images.

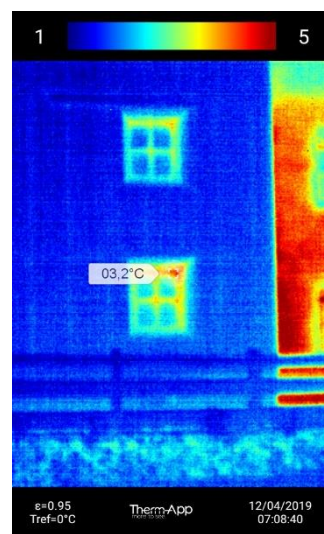
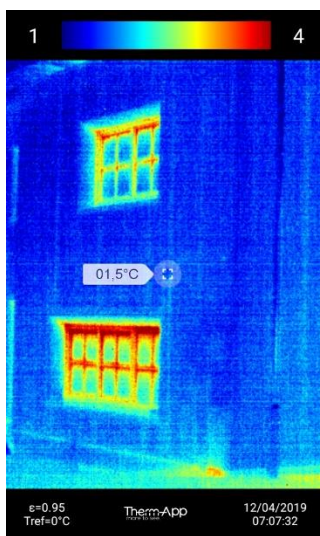

Due to precise planning constructive thermal bridges are also avoided in joint details and wall roof connections. Another characteristic point of possible heat loss was the basement wall junction for which adapted solutions could be found such as a basement panel heating, ventilation and vapor permeable insulation<sup>IV</sup>.

In summary a total energy demand of  $34 \text{ kWh/m}^2\text{a}$  arises according to PHPP calculation. The heating system of the house is a heat pump.

## Indoor environmental quality

Maintaining the desired level of indoor environmental quality and user comfort is the prime objective of most buildings. The indoor environment shall be suited for the intended future use of the building. A poor indoor environment may be a reason to improve the energy performance of a building.

### *Indoor environmental conditions suitable for building content preservation*

As mentioned earlier, the conservation of wood is mostly depending on the temperature and moisture content in the environment. Therefore, the ventilation system creates optimal conditions for the historic wood panelling on the ground floor.

### *Indoor environmental conditions suitable for building fabric preservation*

In this example there are no fabrics or decorative surfaces to be preserved.

### *Indoor environmental conditions suitable for achieving good occupant comfort levels*

The most important influence on the occupant's comfort level is achieved by the added insulation layers on the façade. As a result of the high-quality thermal envelope not only the room temperature but also the surface temperature rises affecting the comfort level in a positive way. Besides the ventilation system provides suitable temperatures as well as fresh air at every outside temperature.

### *Emission of other harmful substances*

During planning special attention was paid on the used materials which should neither have negative effects on the occupants nor the environment. Wood or loam being used on surfaces, insulation, windows, parquet and more there are no emissions of harmful substances.

## Aspects of use

### *Influence on the use and the users of the building*

There is no alteration in the user behaviour.

<sup>I</sup> Prugger, Maximilian: *Masterarbeit Bauphysikalische Bewertung vorgefertigter Fassadensysteme in Holzbauweise in Neubau und Sanierung*

<sup>II</sup> Hukka, A./ Viitanen, H.A.: *A mathematical model of mould growth on wooden material, Finland 1999*

<sup>III</sup> Institut für Bauklimatik, TU Dresden: *Delphin 6.0, 2019*

<sup>IV</sup> Flach, S./ Hutter, A./ Sengl, S.: *Dimensionierung energieeffizienter Gebäude, Universität Innsbruck 2016/17*