

Performance of a liquid scintillator containing a zirconium -keto ester complex developed for the ZICOS experiment

著者	FUKUDA Yoshiyuki, Narengerile, OBATA Akira, MORIYAMA Shigetaka, OGAWA Izumi, GUNJI Takahiro, TSUKADA Satoru, HAYAMI Ryohei
journal or publication title	Bulletin of Miyagi University of Education
volume	49
page range	109-117
year	2015-01-28
URL	http://id.nii.ac.jp/1138/00000410/

Performance of a liquid scintillator containing a zirconium β -keto ester complex developed for the ZICOS experiment

FUKUDA Yoshiyuki *, Narengerile *, OBATA Akira *,
MORIYAMA Shigetaka **, OGAWA Izumi ***,
GUNJI Takahiro ****, TSUKADA Satoru **** and HAYAMI Ryohei ****

Abstract

A liquid scintillator containing a zirconium β -keto ester complex has been developed for the Zirconium Complex in Organic Scintillator (ZICOS) neutrinoless double beta decay experiment. We are aiming to develop a detector which has a good energy resolution (4% at 2.5 MeV), a large light yield (60% that of BC505) and a low background rate (0.1 counts/tonne·year) with several tonnes of ^{96}Zr isotope, so we have investigated the zirconium β -keto ester complexes tetrakis (isopropyl acetoacetato) zirconium and tetrakis (ethyl acetoacetato) zirconium, which have high solubility (over 10 wt.%) in anisole. We measured the performance of liquid scintillators containing these zirconium β -keto ester complexes and obtained 40% of the light yield of BC505 and energy resolution of 4.1% at 2.5 MeV assuming 40% photo coverage of the photomultiplier in the ZICOS detector. Thus we almost achieved our initial goal. Preliminary investigations indicate that tetrakis (diethyl malonato) zirconium will give us no quenching of the light yield and an energy resolution of 2.9% at 2.5 MeV. This will be a suitable complex for the ZICOS experiment, if it has a large solubility.

Key words : Neutrino (ニュートリノ)

Neutrinoless Double Beta Decay (ニュートリノを放出しない2重ベータ崩壊)

Majorana Mass (マヨラナ質量)

Zirconium (ジルコニウム)

Liquid Scintillator (液体シンチレータ)

1. Introduction

Recent results from long baseline neutrino experiments [1] and reactor neutrino experiments [2] have confirmed a non-zero θ_{13} , and reliable neutrino mass matrix elements, except for the mass hierarchy and CP phase in the lepton sector, can now be obtained by combining results from all observations of atmospheric [3], solar [4], and reactor neutrinos [5]. However, neither the Standard Model nor SUSY

extensions of it explain why neutrinos should have a mass. On the other hand, recent leptogenesis models postulate the existence of heavy right-handed neutrinos with masses as large as the Planck scale [6], which are also generally present in the See-Saw model [7], and strongly favor the existence of Majorana neutrinos. The observation of neutrinoless double beta decay would confirm the Majorana nature of the neutrino and would also provide more information about the neutrino mass scale and the mass hierarchy.

* Department of Physics, Miyagi University of Education, Sendai, Miyagi 980-0845, Japan

** Kamioka Observatory, Institute for Cosmic Ray Research, The University of Tokyo, Hida, Gifu 506-1205, Japan

*** Faculty of Engineering, Fukui University, Fukui, Fukui 910-8507, Japan

**** Faculty of Science and Technology, Tokyo University of Science, Noda, Chiba 278-8510, Japan

Neutrinoless double beta decay ($0\nu\beta\beta$) is expected to occur in special nuclei, such as those listed in Table 1. These nuclei cannot undergo single beta decay into the nucleus with an atomic number one higher because of its larger mass. However, if the nucleus with an atomic number two higher has a lower mass than the original nucleus, then double beta decay could occur. In ordinary double beta decay ($2\nu\beta\beta$) two electrons and two neutrinos are emitted at the same time. In this case, the total energy of the two electrons should be spread out between 0 and the Q-value, because the two neutrinos would take out some energy. On the other hand, $0\nu\beta\beta$ does not emit neutrinos (emits only two electrons), because the neutrino emitted from one nucleon should be absorbed by another nucleon in same nucleus due to the Majorana nature of the neutrino. Therefore, the total energy of the two electrons should be unique and be the same as the Q-value of the initial and nal nuclei.

To determine the Majorana neutrino mass from $0\nu\beta\beta$, we must measure the half-life. The half-life of $0\nu\beta\beta$ is given by

$$[T_{12}^{0\nu}(0^+ \rightarrow 0^+)]^{-1} = G_{0\nu} M_{0\nu}^2 \frac{m_v^2}{m_e^2} \quad (1)$$

where $G_{0\nu}$ is the kinematic phase space factor, $M_{0\nu}$ is the matrix element of the target nuclei including Fermi, Gamow-Teller and tensor contributions, m_e is the electron mass, and m_v is the effective Majorana neutrino mass. According to Eq. (1), we must be able to measure a half-life of the order of 10^{25} years assuming the neutrino mass is less than 100 meV. On the other hand, the half-life can also be expressed experimentally as

$$T_{12}^{0\nu} \sim a \frac{Mt}{\Delta E B} \quad (2)$$

where a is the abundance of the target isotope, M is the target mass, t is the measurement time, ΔE is the energy resolution, and B is the background rate. According to Eq. (2), next-generation $0\nu\beta\beta$ experiments should have tonnes of target isotope, a background rate of 0.1-1 counts/(t·year), and an energy resolution of 4% at 2.5

MeV. (Alternatively we could combine a relatively low target mass with very high energy resolution.)

2. ZICOS experiment

We are going to search for $0\nu\beta\beta$ signal using ^{96}Zr in the liquid scintillator. This experiment is named Zirconium Complex in Organic liquid Scintillator (ZICOS) neutrinoless double beta decay experiment. The liquid scintillator will be contained inside a balloon. If the radius of this balloon is 3 m, then total volume is 113 m^3 , which corresponds to 113 tonnes. This balloon is located in a cylindrical tank which has a 5 m radius and is 10 m in height. This cylinder is filled with pure water in order to exclude external γ rays, neutrons and cosmic ray muons. The attenuation length of the scintillation light ($\sim 450 \text{ nm}$ emitted from POPOP) measured for anisole, which is used for the liquid scintillator solvent, is about 10 m. Therefore, the balloon is small enough to transmit the light to the photomultipliers, which will be mounted on the wall of the pure water tank. The photo coverage will be 40% in order to collect scintillation light. To eliminate background signals, the detector should be located in an underground laboratory, such as the Kamioka Observatory.

Isotope (decay process)	Q-value (keV)	Abundance (%)
$^{48}\text{Ca} \rightarrow ^{48}\text{Ti}$	4271	0.2
$^{150}\text{Nd} \rightarrow ^{150}\text{Sm}$	3667	6
$^{96}\text{Zr} \rightarrow ^{96}\text{Mo}$	3350	3
$^{100}\text{Mo} \rightarrow ^{100}\text{Ru}$	3034	10
$^{82}\text{Se} \rightarrow ^{82}\text{Kr}$	2995	9
$^{116}\text{Cd} \rightarrow ^{116}\text{Sn}$	2802	7
$^{130}\text{Te} \rightarrow ^{130}\text{Xe}$	2533	34
$^{136}\text{Xe} \rightarrow ^{136}\text{Ba}$	2479	9
$^{124}\text{Sn} \rightarrow ^{124}\text{Te}$	2288	6
$^{76}\text{Ge} \rightarrow ^{76}\text{Se}$	2040	8
$^{110}\text{Pd} \rightarrow ^{110}\text{Cd}$	2013	12

Table 1. Possible nuclei isotopes for $0\nu\beta\beta$.

In order to suppress background signals from the surface of the balloon which used in ZICOS, we have to minimize the size of the balloon as much as possible. Therefore, it is important that the complex has high solubility. Assuming 10% solubility in a liquid scintillator solvent, the amount of zirconium should be of the order of 3 tonnes. However, the natural

abundance of ^{96}Zr is 3%, so we have to enrich ^{96}Zr up to 10% if we are to achieve a target mass of 300 kg.

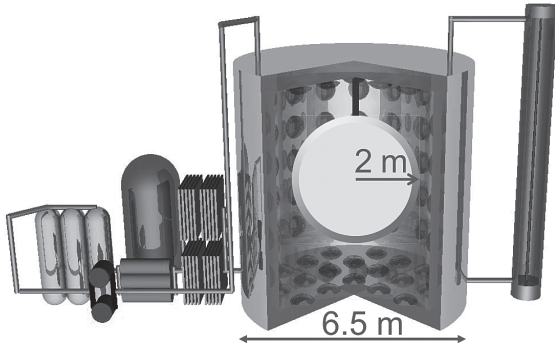

Figure 1. The conceptual design of the ZICOS detector in an EGADS tank. The liquid scintillator is contained inside a balloon, which is surrounded by pure water to reduce external background signals.

We are planning to use an EGADS (Evaluating Gadolinium Action on Detector Systems) tank, which is currently used for demonstration of GADZOOKS! (Gadolinium Antineutrino Detector Zealously Outperforming Old Kamiokande, Super!), located in the Kamioka mine, for the first physics program (see Fig. 1). EGAD tanks are 6.5 m in radius and 6.6 m in height. If we estimate the radius of balloon as 2 m, then inner volume is 33.5 tonnes and, therefore, the amount of complex should be 3.4 tonnes, which contains almost 50 kg of ^{96}Zr .

A nucleus of ^{96}Zr has a Q-value of 3.35 MeV, which is the third largest value in possible double beta decay nuclei, and 3% natural abundance, as shown in Table.1. Generally speaking, it is difficult to use metals, such as Mo, Nd, and Zr, in a double beta decay experiment. Some metal nuclei such as Ge, Cd, and Te could be used for solid-state detectors and scintillation crystals. These detectors should have very good energy resolution, however, the target mass is limited by the size of the detector. Usually the metals are used as a thin foil target and the emitted electrons are tagged by the magnetic field in the track chamber. The curvature of the trajectory corresponds to the electron energy. In that case, the energy loss in the foil might not be negligible and anyway in such detectors it is generally difficult to have a tonne of target.

We know that a liquid scintillator should have the scalability to realize tonnes of the target, and will be easy shield from external background signals by being located in a pure water tank. Although novel techniques, such as using quantum dots to dissolve metals in the liquid scintillator, have been developed in recent years, the solubility is only of the order of 0.1 wt.% [8]. We have, therefore, chosen to dissolve a metal in the liquid scintillator using a β -diketone complex. A classical liquid scintillator consists of an organic solvent such as benzene, toluene or 1,2,4-trimethylbenzene. We choose an anisole (methoxybenzene) as a solvent, because it can dissolve a metal complex of acetylacetone at about 10 wt.%. Our standard cocktail is produced by dissolving 100 mg PPO and 10 mg POPOP in 20 mL anisole. This standard cocktail has almost same light yield as BC505, as shown in Fig. 2, and a fast decay time (~ 20 ns).

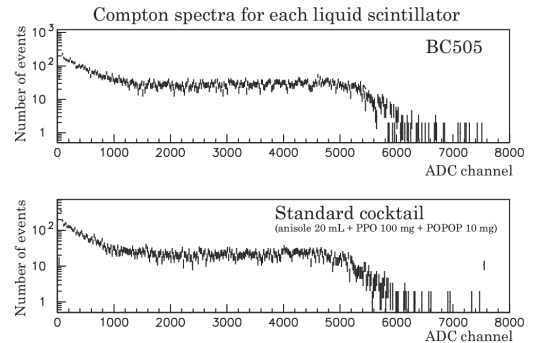

Figure 2. The Compton spectra from a ^{60}Co source for (a) BC505 and (b) the standard cocktail (100 mg PPO and 10 mg POPOP in 20 mL anisole).

As described above, there are several nuclei which will possibly undergo neutrinoless double beta decay. A β -diketone ligand could be formed as complex with one of these metal nuclei at the coordinate bond. Therefore, the number of ligands bonding with metal nuclei is basically determined by the number of valence electrons which are not used for the covalent bond. For instance, zirconium has three valence electrons, cadmium has two and neodymium has three. Molybdenum has some compounds with 2, 3, 4, 5, or 6 valence electrons. Because of the structure of ligands and the molecular size, it is not easy to understand

which is the best metal for formation of the complex. However, we have found that zirconium acetylacetonone has the same solubility (over 10 wt.%) as indium acetylacetonone, as reported in Ref. [9]. Unfortunately, this β -diketon ligand has an absorption peak around 270 nm, which partially overlaps the emission spectrum of anisole, as shown in Fig. 3. Therefore, it causes color quenching as the amount of dissolved complex is increased [10]. To avoid this quenching, we synthesized a β -keto ester complex instead of a β -diketon complex in order to shorten the absorption wavelength.

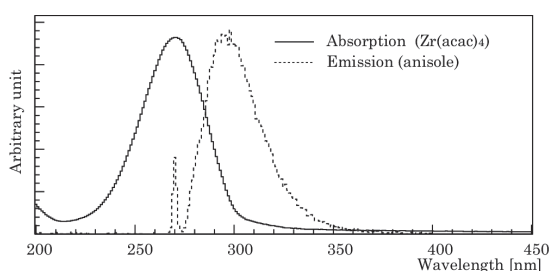

Figure 3. The absorbance spectrum of zirconium acetylacetonone and the emission spectrum for anisole measured in hexane.

3. Synthesis of zirconium β -keto ester complex and its properties

We synthesized tetrakis(isopropyl acetoacetato) zirconium ($Zr(ipcac)_4$) and tetrakis(ethyl acetoacetato) zirconium ($Zr(etac)_4$) β -keto ester complexes [10]. The chemical structures of those complexes are shown in Fig. 4 and their chemical formulas are $Zr(CH_3CCOCHCOOCH(CH_3)_2)_4$ (MW=711.92) and $Zr(CH_3CCOCHCOOCH_2CH_3)_4$ (MW=665.81), respectively.

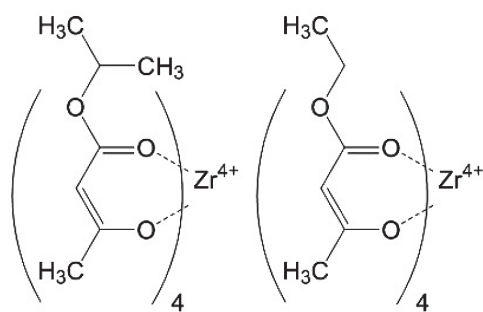

Figure 4. A tetrakis(isopropyl acetoacetato)zirconium complex (left) and a tetrakis(ethyl acetoacetato) zirconium complex (right).

We measured the solubility of these complexes in anisole and they were over 10 wt.%. We also measured the absorbance spectra which are shown in Fig. 5. The absorption peaks of $Zr(iprac)_4$ and $Zr(etac)_4$ were shifted to a shorter wavelength (~ 240 nm) than the emission wavelength of anisole. In other words, there is almost no overlap between the absorption spectrum of the β -keto ester complex and the emission spectrum of anisole in hexane. Optical properties of a complex, such as absorbance, are generally determined by the ligand and are not affected by the nucleus. The absorption peak was almost determined by the energy band of the peripheral electrons of the ligand, and the electron was provided by the nucleus.

As we reported in Ref. [10], we have observed small bump appearing around 290 nm in the absorbance spectra. We expected that this bump was caused by some impurities in the complex, which could be separated by precipitation in a solvent, such as hexane or diethyl ether, because the absorbance spectra showed no bump just a few weeks after the bump was observed. However, the impurities could not be precipitated in anisole, because the light yield did not recover even after a few weeks. Although we could not directly see the absorbance spectra below 300 nm in anisole due to the huge absorption, we considered those impurities to be dissolved in anisole.

Recently, we have started to keep the complex under nitrogen, with the storage vial lled with nitrogen instead of air. We found that the newly delivered complex did not exhibit such a bump in the absorbance spectra as shown in right hand side of Fig. 5. On one occasion air was accidentally introduced into the storage vial. Then, the newly delivered complex showed the bump again. This indicates that the impurities might be produced by air, particularly oxygen.

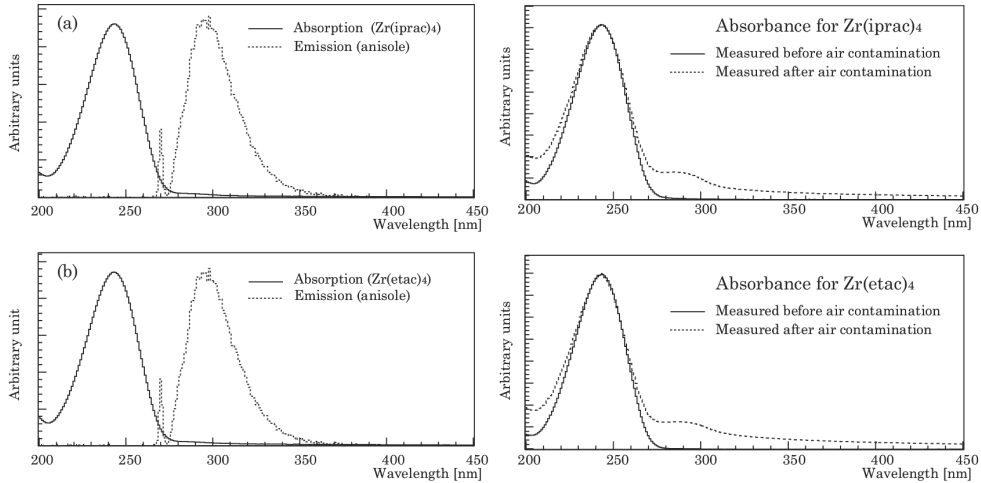

Figure 5. Left hand panel shows the absorbance spectra for (a) tetrakis(isopropyl acetoacetato)zirconium, and (b) tetrakis(ethyl acetoacetato) zirconium. The absorption peaks are around 240 nm. Right hand panel shows the same absorbance spectra before and after air contamination. This shows that the small bump appearing around 290 nm was produced by air, particularly oxygen.

4. Performance of liquid scintillators containing zirconium β -keto ester complexes

The performance of a liquid scintillator from the point of view of neutrinoless double beta decay should be evaluated by its energy resolution. To distinguish between $2\nu\beta\beta$ and $0\nu\beta\beta$, and avoid γ rays from ^{208}Tl in U/Th (total energy ~ 2.7 MeV), our initial goal was that (a) the light yield should be larger than 60% that of BC505, and (b) the energy resolution should be 4% at 2.5 MeV for a 10 wt.% concentration of zirconium β -keto ester complex.

To measure the light yield and energy resolution,

we must use not only the Compton edge but also the single energy peak obtained by using the backscattering method. The left figure of Fig. 6 shows the configuration of the ^{60}Co radioactive source, the liquid scintillator containing zirconium β -keto ester complex, and a NaI scintillator. To select the scattering angle of 150 degrees, we collimated the γ rays using lead blocks, as shown in the left panel of Fig. 6. The right panel of Fig. 6 shows typical energy distributions of the liquid scintillator and the NaI scintillator. We could see the single peak in both detectors. The calculated energy of NaI obtained from the scattering angle was 224 keV and the fitted value was 221 keV; therefore the experimental

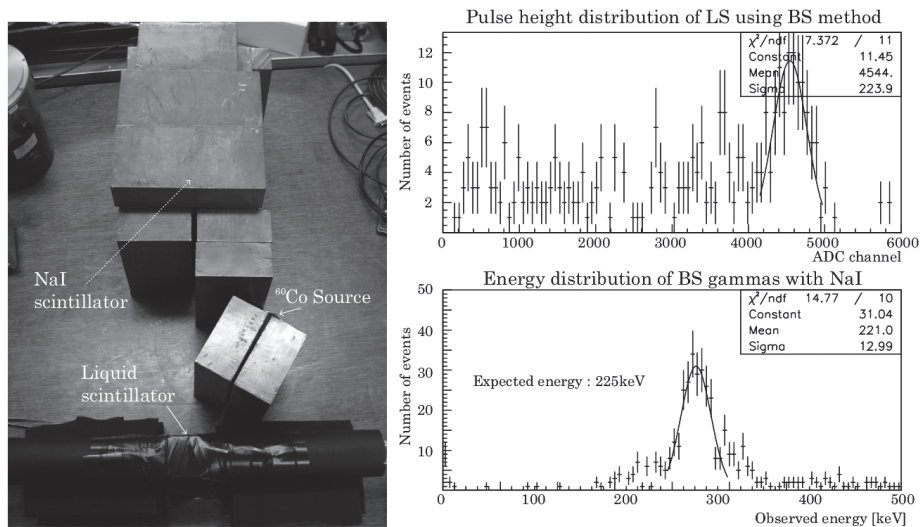

Figure 6. Setup for measurement of the single peak for the liquid scintillator using the backscattering method.

measurements should be correct.

To perform measurements at 10 wt.% concentration, it was necessary to have about 2 g of $Zr(iprac)_4$ and $Zr(etc)_4$; however, we had only about 1 g of each complex. Therefore, we could not measure the light yield and energy resolution for 10 wt.% concentration. However, the absorbance spectra of the complex and the ligand should be basically the same because the optical properties of the complex should be determined by the energy band of the orbital electrons in the ligand. Fig. 7 shows that the absorbance spectra of $Zr(iprac)_4$ and isopropyl acetoacetate are actually quite similar. Therefore, at this time, we measured the performance using isopropyl acetoacetate instead of $Zr(iprac)_4$ for large concentrations.

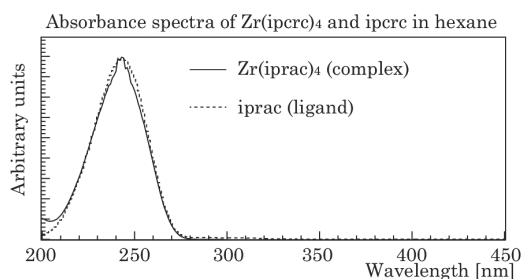

Figure 7. Absorbance spectra for tetrakis(isopropyl acetoacetato)zirconium, and isopropyl acetoacetate. The shapes of these spectra are quite similar.

The left panel of Fig. 8 shows the measured light yield fraction for the standard cocktail as a

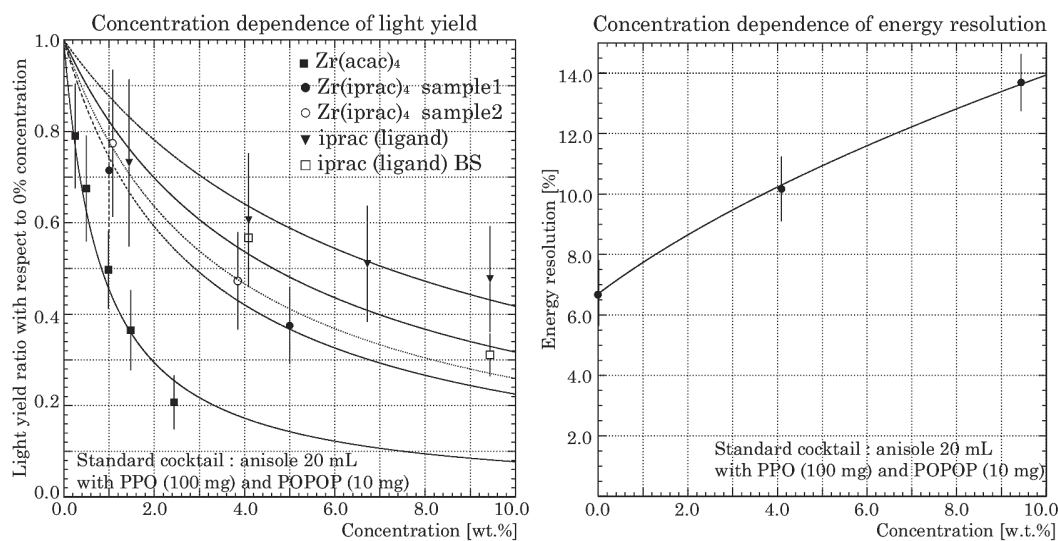

Figure 8. Light yield fraction as a function of the concentration of $Zr(iprac)_4$ and isopropyl acetoacetate (left panel). Measured energy resolution as a function of the concentration of $Zr(iprac)_4$ and isopropyl acetoacetate (right panel).

function of the concentration of $Zr(iprac)_4$, isopropyl acetoacetate, and $Zr(acac)_4$. At high concentrations we used isopropyl acetoacetate to measure the light yield, because of a lack of $Zr(iprac)_4$ complex, as described above. To evaluate at same concentration of ligand, we used a fourfold larger molar number for isopropyl acetoacetate. For comparison, the light yield fraction for $Zr(acac)_4$ is also shown in same gure. The light yield of $Zr(iprac)_4$ obtained by tting the data is almost 30% to 40% of that of the standard cocktail at a 10 wt.% concentration. It appears that there is a difference between isopropyl acetoacetate and $Zr(iprac)_4$; namely, the light yield of the complex may be about half that of the ligand. We thought that this might be due to the difference in absorbance shape, as the complex has a small bump appearing around 290 nm. If we can use the controlled complex that should have the same absorbance shape as the ligand, then we will get the same light yield of about 30% that of BC505. This number is quite a bit smaller than our initial goal which was 60% of the light yield of BC505. However, this does not restrict the performance of the liquid scintillator, because the most important property is the energy resolution.

The right panel of Fig. 8 shows the measured energy resolution as a function of the concentration of $Zr(iprac)_4$ equivalent. Again these data were

obtained using isopropyl acetoacetate, not Zr(iprac)_4 . It appears that the energy repulsion obeys the usual expectation $\sigma = \frac{\sigma_0}{\sqrt{E/E_0}}$, where E , E_0 , and σ_0 correspond to the electron energy, the reference energy, and the energy resolution for the reference energy, respectively. The energy should be proportional to the light yield. The obtained energy resolution around 10 wt.% concentration was 14% at 1 MeV, which was estimated by measuring the energy of NaI. In this case, the observed energy in the liquid scintillator was 1 MeV, because we used ^{60}Co as the γ source (1.33 MeV and 1.17 MeV) and the expected energy deposited in the liquid scintillator would be calculated as 1.025 MeV (the 0.225 MeV value observed in the NaI scintillator should be subtracted). In this setup, the scintillation photons were collected by two photomultipliers, as shown in the right panel of Fig. 6. The photo coverage of this setup was estimated to be about 8.5% using Monte Carlo simulation. On the other hand, the ZICOS detector will have 40% coverage of photomultipliers, so that the energy resolution for the ZICOS detector should be 6.5% at 1.0 MeV. Therefore, the actual energy resolution at 2.5 MeV was estimated to be 4.1%. This value is quite similar to our initial goal. In conclusion, our liquid scintillator system with 10 wt.% concentration of Zr(iprac)_4 in anisole has almost achieved our initial goals.

5. Tetrakis (diethyl malonato) zirconium

As described in previous section, it is possible, using Zr(iprac)_4 , to obtain a liquid scintillator system for the ZICOS detector, which should have the necessary energy resolution for the neutrinoless double beta decay search. However, the light yield is still lower than our goal, so the energy resolution of 4.1% at 2.5 MeV may not be enough, because this is almost the same performance as achieved by the present KamLAND experiment. KamLAND needs better energy resolution to distinguish the background and ^{136}Xe signals. In our case, in order to achieve a better energy resolution, we need to have a much better complex than Zr(iprac)_4 .

The β -keto ester complex shortened the absorption wavelength by introducing an ester group in the place of a methyl group. Therefore, if we exchange another methyl group with an ester group, the absorption peak should be moved to an even shorter wavelength than 240 nm. Tetrakis (diethyl malonato) zirconium (Zr(deml)_4) which is shown in the left panel of Fig. 9 is one possible complex which has double ester ligand instead of a β -keto ester ligand.

The absorbance spectrum of diethyl malonate was measured and the result is shown in the right panel of Fig. 9.

The absorption peak has shifted to around 210 nm, a much shorter wavelength than that of ethyl acetylacetonate. This indicates that the light yield

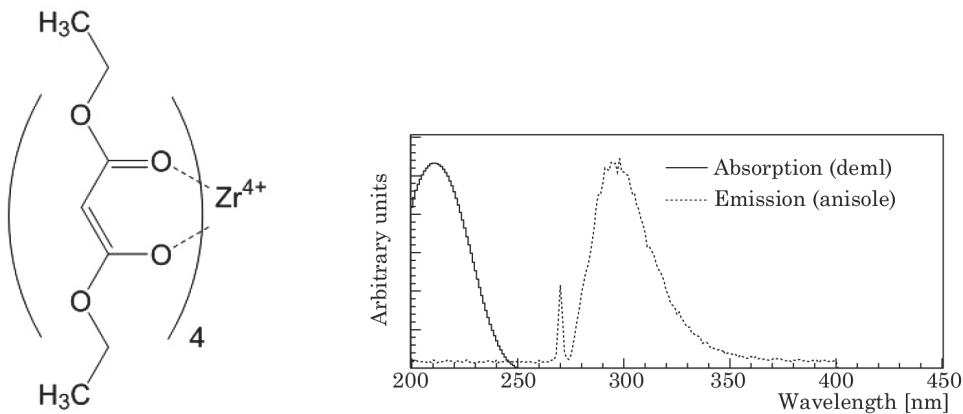

Figure 9. Chemical structure of Zr(deml)_4 and absorbance spectrum of diethyl malonate.

and energy resolution of tetrakis (diethyl malonato) zirconium could be improved by the non-overlapping of the absorption spectrum of the complex and the emission spectrum of anisole. The Compton edge distributions of γ rays from the ^{60}Co radioactive source for each ligand (isopropyl acetoacetate, methyl acetoacetate, and diethyl malonate) at almost same concentration (6 -7 wt.%) are shown in Fig. 10, which shows that the Compton edge of a liquid scintillator containing diethyl malonate is same as that of the standard cocktail. This means that there is no quenching for a liquid scintillator containing diethyl malonate. According to these results, we expect that tetrakis (diethyl malonato) zirconium ($\text{Zr}(\text{deml})_4$) will give us the same light yield as BC505, and the energy resolution will be about 2.9% at 2.5 MeV for the ZICOS detector. This value is better than our initial goal, and might be enough to distinguish background and signals. In other words, it is crucial for discrimination in a non-tracking detector such as a liquid scintillator.

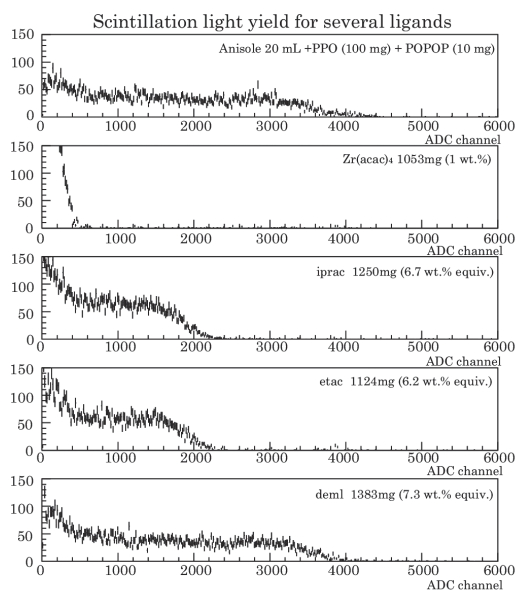

Figure 10. Scintillation yield using the Compton edge for (a) the standard cocktail, (b) $\text{Zr}(\text{acac})_4$, (c) isopropyl acetoacetate, (d) ethyl acetoacetate, and (e) diethyl malonate.

6. Conclusion

Tetrakis(isopropyl acetoacetato)zirconium and tetrakis (ethyl acetoacetato) zirconium have a absorption peak around 240 nm, which enables us to obtain a liquid scintillator containing those β -keto ester complexes having a light yield of 30% to 40% relative to that of BC505 and an expected energy resolution of 4.1% at 2.5 MeV for the ZICOS experiment. Also, the attenuation length for 450 nm light, which is emission peak of POPOP, in anisole is almost 6 m. Therefore, we are almost ready to realize this experiment. We are now developing another complex, tetrakis (diethyl malonato) zirconium, to shorten the absorption wavelength to around 210 nm. We expect that a liquid scintillator containing tetrakis (diethyl malonato) zirconium will have the same light yield as BC505 and an energy resolution of 2.9% at 2.5 MeV. This will be the nal complex for the ZICOS experiment, if it has a sufficiently large solubility.

Synthesis

Tetrakis (isopropyl acetoacetato) zirconium

ZrCl_4 (3.10 g, 13.3 mmol) in benzene (40 mL) was added to tetrahydrofuran (2 mL), and stirred overnight. The slight cloudy solution was added to isopropyl acetoacetate (8.63 g, 59.9 mmol), and stirred for 1 h at ambient temperature. The pale yellow suspension was added dropwise to triethylamine (5.96 g, 58.9 mmol) over 30 min and then refluxed for 2 h. After cooling, the mixture was ltered to remove amine salt and volatile compounds were removed using a rotary evaporator. The orange residue was recrystallized from isopropyl alcohol. The crystal was collected by filtration and dried under reduced pressure at room temperature to provide $\text{Zr}(\text{iprac})_4$ as white crystals (4.63 g, 52.4%).

tetrakis (ethyl acetoacetato) zirconium

ZrCl_4 (3.94 g, 16.9 mmol) in benzene (50 mL)

was added to tetrahydrofuran (4 mL), and stirred overnight. The slight cloudy solution was added to ethyl acetoacetate (8.86 g, 68.1 mmol), and stirred for 1 h at ambient temperature. The pale yellow suspension was added dropwise to triethylamine (7.03 g, 69.4 mmol) over 30 min and then refluxed for 2 h. After cooling, the mixture was filtered to remove amine salt and volatile compounds were removed using a vacuum pump. A yellow viscous liquid was obtained, which gave pale yellow solid after sitting for several weeks at room temperature. The solid was collected by filtration, dissolved in a small amount of EtOH, and then cooled to -30°C . After 1 month, $\text{Zr}(\text{etac})_4$ was obtained as a white solid (8.10 g, 79%).

Acknowledgments

This work was supported by Grants-in-Aid for Scientific Research on Innovative Areas (No. 24104501 and No. 26105502) from the Ministry of Education, Culture, Sports, Science and Technology (MEXT), and a Grant-in-Aid for Scientific Research (C) (No.24540295) from the Japanese Society for the Promotion of Science (JSPS). We would like to thank Professor Takashi Muramatsu for help in the measurement of the absorbance of the complex.

References

- (2002) 115012.
- [7] J. Hisano, T. Moroi, K. Tobe, M. Yamaguchi and T. Yanagida Phys. Lett. B **357** (1995) 579.
- [8] L. Winslow and R. Simpson, J. INST **7** (2012) P07010.
- [9] C. Back, F.X. Hartmann, D. Motta, and S. Schoenert, Chem. Phys. Lett. **435** (2007), 252.
- [10] Y. Fukuda, S. Moriyama and I. Ogawa, Nucl. Instr. and Meth. A **732** (2013) 397.
- (平成26年9月30日受理)
- [1] K. Abe *et al.* (T2K Collaboration) Phys. Rev. D **88** (2013) 032002.
- [2] F.P. An *et al.* Phys. Rev. Lett. **108** (2012) 171803, J.K. Ahn *et al.* (RENO Collaboration) Phys. Rev. Lett. **108** (2102) 191802, Y. Abe *et al.* (Double Chooz Collaboration) Phys. Rev. Lett. **108** (20122) 131801.
- [3] Y. Fukuda *et al.* (Super-Kamiokande Collaboration) Phys. Rev. Lett. **81** (1998) 1562.
- [4] S. Fukuda *et al.* (Super-Kamiokande Collaboration) Phys. Lett. B **539** (2002) 3, Q.R. Ahmed *et al.* (SNO Collaboration) Phys. Rev. Lett. **89** (2002) 011302, G. Bellini *et al.* (Borexino Collaboration) Phys. Rev. Lett. **107** (2011) 141302.
- [5] T.Araki *et al.* (KamLAND Collaboration) Phys.Rev.Lett. **94** (2005) 081801.
- [6] M. Fujii, K. Hamaguchi and T. Yanagida Phys. Rev. D **65**