

## Field Seismic Observations by Portable Broadband Seismometers in the Lützow-Holm Bay Region, East Antarctica

Hiroaki NEGISHI<sup>1</sup> and Masaki KANAO<sup>2</sup>

東南極リュツォ・ホルム湾地域における可搬型広帯域地震計を用いた野外地震観測

根岸弘明<sup>1</sup>・金尾政紀<sup>2</sup>

**要旨:** 第37次および第38次日本南極地域観測隊(1996-1997年)により, 東南極リュツォ・ホルム湾地域の5カ所において野外地震観測が行われた。地震観測システムは可搬型広帯域地震計, 光磁気ディスクによる記録計および太陽電池による電源供給装置からなる。電源供給装置のトラブルがあった他は観測は順調に行われ, いくつかの遠地地震が観測された。周波数解析から, これら野外地震観測のデータは0.5 Hzより高周波側で振幅が非常に大きい事が確認された。一方, 5 mHzから0.5 Hzの範囲では昭和基地での記録とほぼ同じレベルであり, 適切なフィルター処理をすることにより, これら野外地震観測のデータが様々な波形解析に活用でき得る事がわかった。

**Abstract:** Field seismological observations were carried out at five points around the Lützow-Holm Bay region in East Antarctica to clarify the heterogeneous structure of the crust and the upper mantle during the 37th Japanese Antarctic Research Expedition (JARE-37) and JARE-38 in 1996-97. The seismological recording system is composed of a portable broadband seismometer, a recording unit with MO disk drive and a solar power battery supply. Except for power supply trouble, the observations went well and waveforms of some teleseismic events were recorded. Based on spectral analysis, the spectrum amplitude of the field observation data is very large at frequency higher than about 0.5 Hz. On the other hand, the amplitude is almost the same as that at Syowa Station at frequencies from about 5 mHz to 0.5 Hz. These data are of good enough quality to be used for various waveform analyses by applying suitable band pass filters.

### 1. Introduction

Broadband and wide dynamic-range seismological observations were started at Syowa Station (69°00'S, 39°35'E) in 1989. The S-wave velocity structure and the shear-wave splitting in the crust and the uppermost-mantle in the Lützow-Holm Bay

<sup>1</sup> 京都大学防災研究所地震予知研究センター, Research Center for Earthquake Prediction, Disaster Prevention Research Institute, Kyoto University, Gokasho, Uji 611-0011.

<sup>2</sup> 国立極地研究所, National Institute of Polar Research, Kaga 1-chome, Itabashi-ku, Tokyo 173-8515.

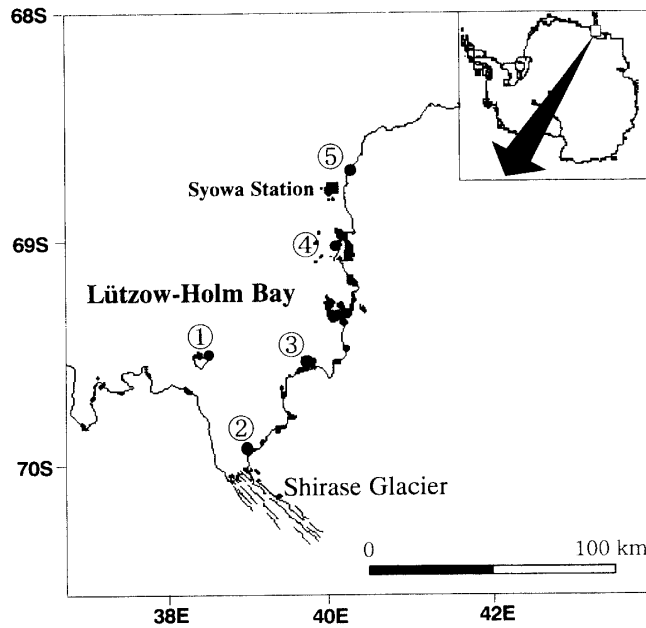

Fig. 1. Location of the observation points. Numbers indicate the following observation points: 1) Padda Island, 2) Strandnebba, 3) Skallen, 4) Langhovde, 5) Tottuki Point. Details of each station are referred to Table 1.

region were analyzed using digital seismogram waveform data (e.g., KANAO, 1997; KUBO *et al.*, 1995). These methods, however, can only obtain information on the crustal structure just beneath the station site. On the other hand, the existence of crustal heterogeneities beneath the Lützow-Holm Bay region has been suggested, based on various geoscientific surveys (KAMINUMA *et al.*, 1991). Recently, KANAO (1997) investigated azimuthal variations of the *S*-wave velocity structure beneath Syowa Station using receiver functions. The receiver function analysis, however, could not clarify the detailed heterogeneous structure around the area. Therefore, field observations with the broadband seismometer are needed to clarify the crustal heterogeneity and to investigate the crustal evolution of the Antarctic continent.

The seismological observations were carried out at five points (Padda Island, Strandnebba, Skallen, Langhovde and Tottuki Point) in the Lützow-Holm Bay region during the summer operations of the 37th Japanese Antarctic Research Expedition (JARE-37) and JARE-38 to achieve the above purpose in 1996–1997. During the observation period, clear waveforms from some teleseismic events were recorded by the system. Figure 1 shows the research area and the distribution of the observation points. This paper outlines the operations at two outcrops, Padda Island and Strandnebba, in 1996.

## 2. Field Observations

### 2.1. System

As shown in Fig. 2, the observation system consists of a seismometer, a digital recording unit and a solar-panel battery power supply unit. Two types of broadband

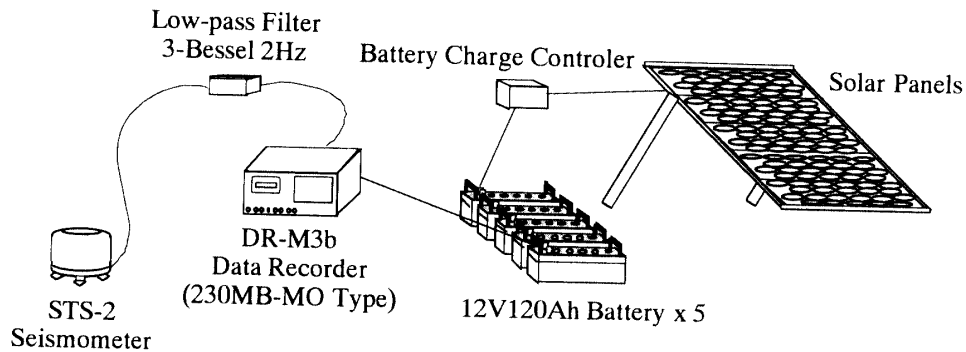

Fig. 2. A schema of the recording system using in the observations at Padda Island and Strandnebbba. CMG-40T seismometers were used in the observations at Skallen, Langhovde and Tottuki Point.

seismometers as STS-2 (G. Streckeisen AG) and CMG-40T (Güralp System LTD.) were used. The STS-2 seismometer is composed of a three-component feed-back sensor with wide-dynamic range of about 140 dB and high sensitivity of  $2 \times 750$  V s/m. The seismometer has broadband velocity outputs (flat frequency response for velocity from 0.1 s to 120 s). Installation and setup of this system are very easy because it is small in size, in a single-sealed package and has a built-in circuit for automatic recentering. The CMG-40T portable seismometer is also a three-component velocity-response (flat frequency response for velocity from 0.1 s to 20 s) seismometer of small-packaged design. The CMG-40T was operated with low-gain mode and  $2 \times 400$  V s/m.

The signal is digitized at the sampling frequency rate of 10 Hz with a dynamic range of about 90 dB (16 bits) after being passed through an anti-aliasing analog filter (3rd order Bessel type low-pass filter with a cutoff frequency of 2 Hz), and then stored on a magneto-optical (MO) diskette of capacity 230 MBytes. This process was carried out using a digital data recorder (DRM-3b, TEAC Corporation). The created file size is about 5 MBytes per day and this recorder can store over 40 days data on one MO diskette. The POS signal that indicates the position of the seismometer pendulum was not so important as the BRB signal. The POS was not recorded in these observations because of the limited number of recorder input channels.

The power supply to four or five batteries at each station was provided by five solar panels using an over-charge prevention device. The total power of the solar panels was about 200 W at 12 V DC and the total capacity of the lead batteries was  $100 \times 5$  Ah. This system could operate continuously until capacity of the MO was filled by recorded data when the sunshine duration was over 6 hours per day.

## 2.2. Seismological observations

The first field observation started on September 1996 at Padda Island after the system was tested at Syowa Station. The system was installed at the northern outcrop of Padda Island and observation was begun on September 8 (Fig. 3). The solar panel unit was attached to the surface rock using anchor bolts. The other instruments were installed in the boxes and bounded with the solar panel base. Foam polystyrene panels with 10 cm thickness were put inside the boxes (Fig. 4). The temperature inside the

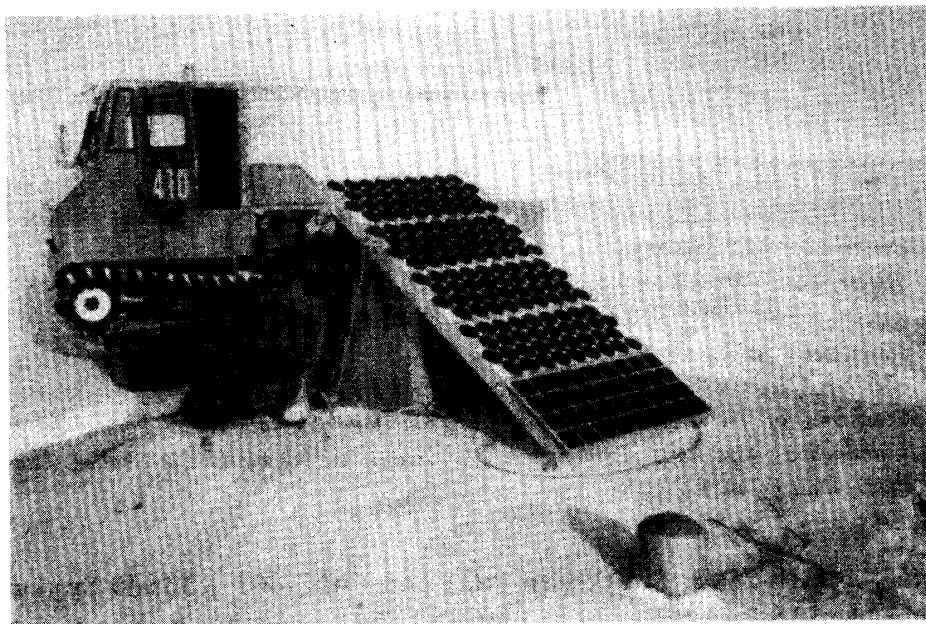

*Fig. 3. The recording system installed on the outcrop on Padda Island. An STS-2 seismometer is seen in front of the solar battery panels.*

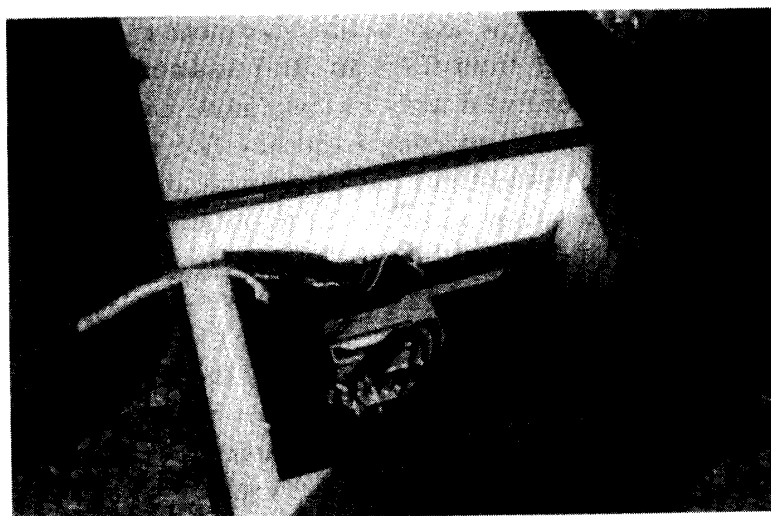

*Fig. 4. Data recorder (DR-M3b) inside the box with foam polystyrene panels (10 cm in thickness).*

boxes was maintained by the heat of the recorder itself. The seismometer was put in a detached place and covered with a wooden box and a vinyl sheet.

Due to severe weather, the seismological observations lasted until December 1996 and then all equipment was transferred to Strandnebbba. We found that the over-charging prevention device had broken down and the observation had stopped on the ninth day at Padda Island, so we repaired the device at Strandnebbba immediately. At Strandnebbba, the observations were continued for about one month from December 29.

Another new observation system was placed by JARE-38 at Skallen on late December 1996, and the observations continued until late January 1997. This system

Table 1. Location and details of the field observation points.

	① Padda Island	② Strandnebbba	③ Skallen	④ Langhovde	⑤ Tottuki Point
Location	69.92°S 38.39°E	69.97°S 38.82°E	69.67°S 39.41°E	69.19°S 39.64°E	68.91°S 38.83°E
Obs. period	1996/9/8 -1996/9/16	1996/12/29 -1997/1/28	1996/12/30 -1997/1/28	1996/12/30 -1997/1/28	1996/12/30 -1997/1/28
Seismometer	STS-2	STS-2	CMG-40T	CMG-40T	CMG-40T
Filter	Anti-aliasing low-pass, fc = 2 Hz Bessel 3rd	Anti-aliasing low-pass, fc = 2 Hz Bessel 3rd	No	Anti-aliasing low-pass, fc = 2 Hz Bessel 3rd	No
Recording system	TEAC DR-M3b (media: 230 MB MO-diskette) 16 bits 10 Hz sampling 3-comp. velocity (U/D, N/S, E/W) continuous recording over 40 days				
Power supply	Solar panel (12 V, 40 W) × 5 + lead batteries (12 V, 100 Ah) × 5				
Time adjustment	No correction	No correction	GPS clock	No correction	GPS clock

was almost the same as that of the JARE-37 system except for the seismometer (CMG-40T) and the recorder. The new recorder had a GPS reference clock inside. After the end of the JARE-38 summer season in 1997, observations were continued at Mizukuguri Cove of Langhovde and Tottuki Point. Details of the operation and other information concerning each observation point are given in Table 1.

### 3. Post-observation Processing

As the occurrence of local earthquakes near Syowa Station has been reported (*e.g.*, AKAMATSU *et al.*, 1989, 1990), one of the objectives of the field observations was to detect local earthquakes. No local event was, however, detected during the field observation period. Therefore only teleseismic events were analysed from the recorded data.

After ejection of the MO diskette, the continuous data were downloaded to a workstation in the Earth Science Laboratory, Syowa Station. The teleseismic events were selected from the raw data file and stored on a hard disk. Teleseismic events were selected from the Preliminary Determinations of Epicenter (PDE) and calculated a first P- or PKP-phase travel time to the station by using the IASPEI 1991 travel time table (KENNETT, 1991) to obtain the expected arrival time. Earthquakes with magnitude larger than 5 were selected by this procedure. Event data prepared in this way came to 11 files and 15 files for Padda Island and Strandnebbba, respectively. Finally, the events were confirmed on a graphical console and we eventually found a seismic waveform with a magnitude larger than 6. The locations of the confirmed events are shown in Fig. 5 and listed in Table 2.

### 4. Event Data Comparison Between the Field Data and the Syowa Station STS-1 Data

Figure 6 shows an example of velocity waveforms of the earthquake with magni-

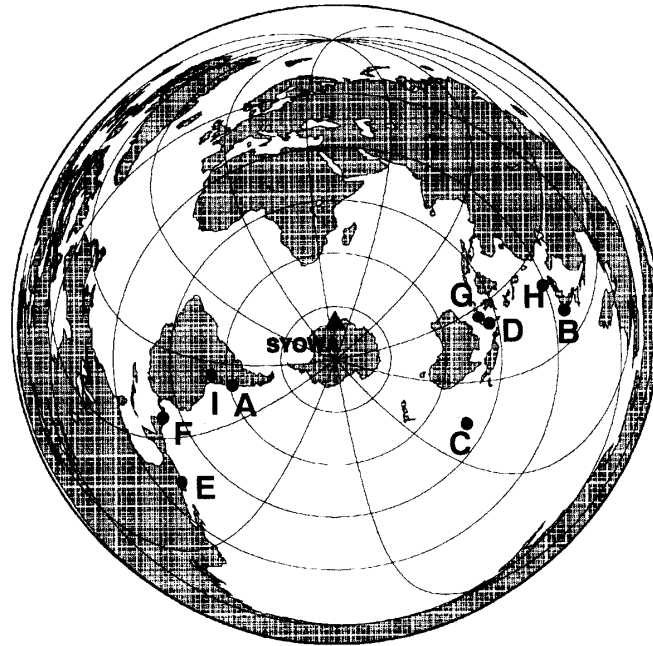

Fig. 5. Epicentral distributions of earthquakes recorded at Padda Island and Strandnebbba.

Table 2. Parameters of the earthquakes shown in Fig. 5 (after the Preliminary Determination of Epicenters, USGS). Bold characters (from A to I) correspond to the epicenters shown in Fig. 5.

	Date	Time (UT)	Lat.	Long.	Dep.	Mb	Dis. (°)	
Observed at Padda Island								
<b>A</b>	1996/ 9/ 9	0:20:38.60	-32.016	-71.488	39.0	6.0	67.13	Near coast of central Chile
<b>B</b>	1996/ 9/11	2:37:15.50	35.548	140.939	60.0	6.0	127.09	Near east coast of Honshu, Japan
<b>C</b>	1996/ 9/14	13:10:53.90	-10.874	165.979	73.0	6.0	92.03	Santa Cruz Islands
Observed at Strandnebbba								
<b>D</b>	1996/12/30	19:41:51.90	-3.985	128.089	33.0	6.0	85.95	Seram Indonesia
<b>E</b>	1997/ 1/11	20:28:26.00	18.193	-102.800	33.0	6.5	123.98	Michoacan, Mexico
<b>F</b>	1997/ 1/12	12: 1:30.40	8.913	-83.126	40.0	6.2	109.44	Costa Rica
<b>G</b>	1997/ 1/17	11:20:22.70	-8.891	123.513	120.0	6.2	79.74	Flores region, Indonesia
<b>H</b>	1997/ 1/17	15:53:13.50	28.826	129.977	33.0	6.0	117.09	Ryukyu Islands
<b>I</b>	1997/ 1/23	2:15:23.30	-21.945	-65.579	275.0	6.3	74.61	Southern Bolivia

tude 6 recorded at Padda Island and Syowa Station. The data at Syowa Station were recorded by a 3-component STS-1 seismometer with sampling frequency of 20 Hz. This earthquake occurred in the Santa Cruz Island region on September 14, 1996 (shown with C in Fig. 5). *P*-phase, *S*-phase and surface waves can be recognized clearly at both Padda Island and Syowa Station with almost the same amplitude. However, the high-frequency background noise at Padda Island is much larger than that

**C 1996/ 9/14 13:10:53.90 SANTA CRUZ ISLANDS**  
**dist.= 92.03°, Dep.=73.0 km, Mb=6.0**

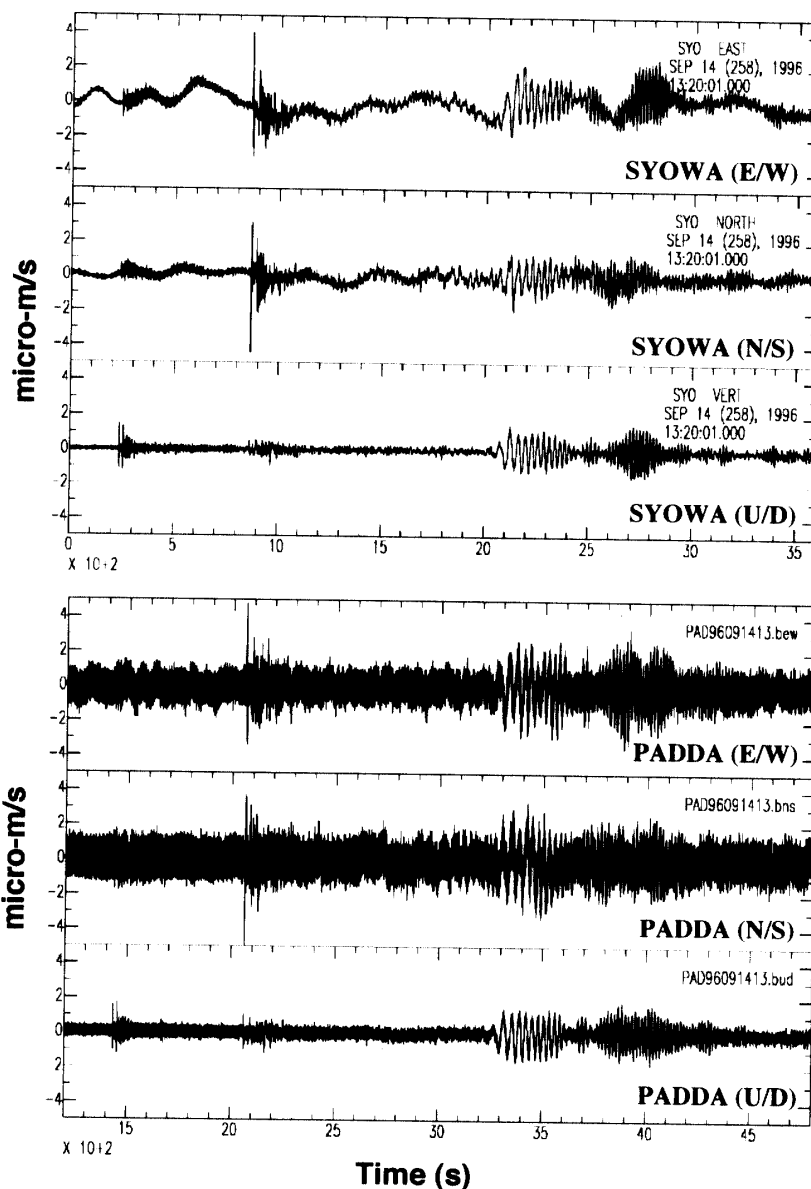
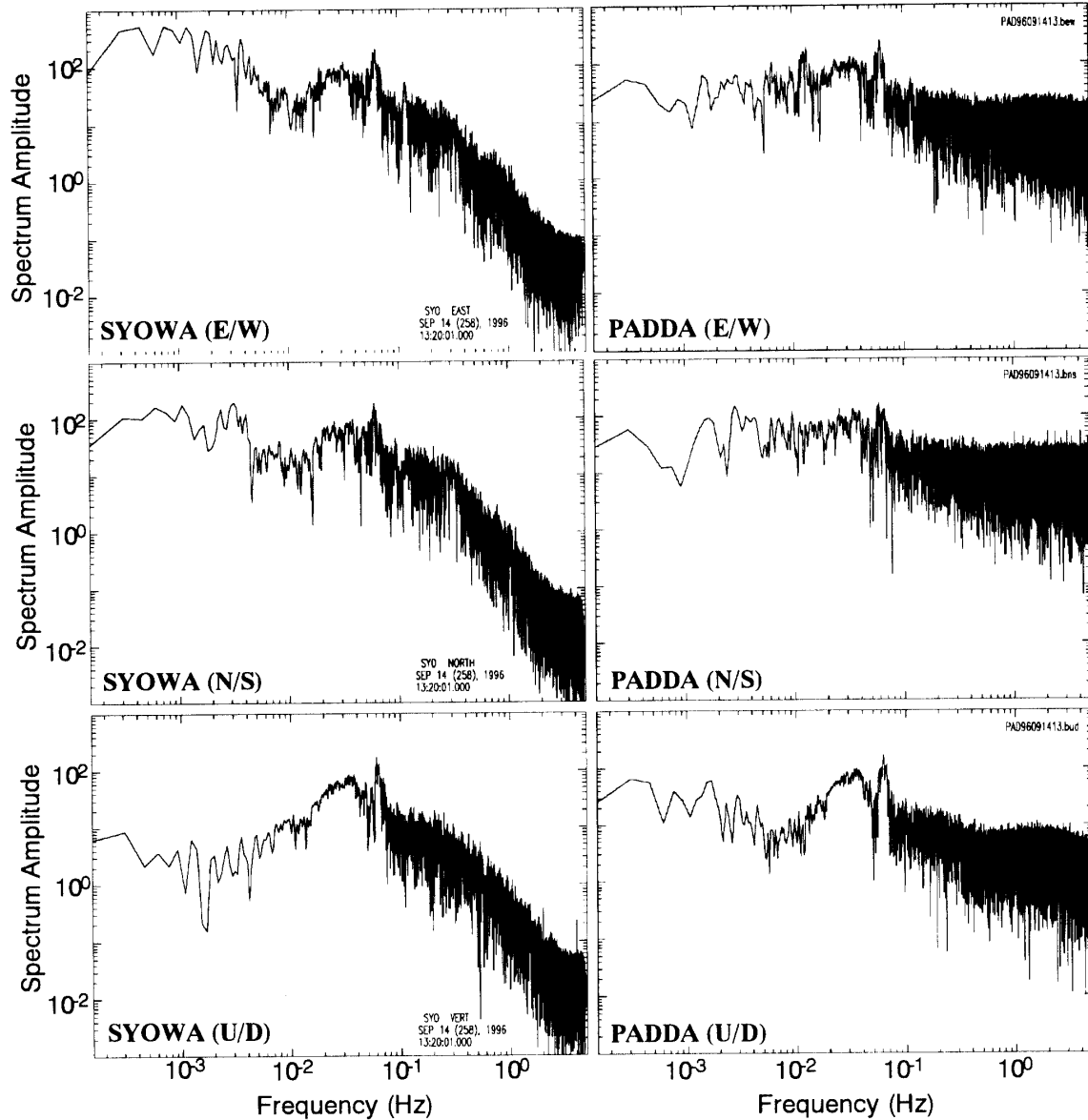

Fig. 6. Observed waveforms of the earthquake which occurred in the Santa Cruz Island region recorded at Syowa Station (upper plot) and at Padda Island (lower plot).

at Syowa Station. The noise level at Padda Island is about three times larger for the vertical component and about ten times larger for horizontal components than those at Syowa Station. Long period oscillation with about 200 s period is found only in the Syowa Station data because of the difference on frequency response to the ground velocity, that is, the STS-1 can detect signals of period to 360 s while the STS-2 can only detect signals to 120 s.

Figure 7 shows the Fourier spectrum amplitude of the traces in Fig. 6. The amplitude level at Padda Island is almost the same as that at Syowa Station in the

**C 1996/ 9/14 13:10:53.90 SANTA CRUZ ISLANDS**  
**dist.= 92.03°, Dep.=73.0 km, Mb=6.0**

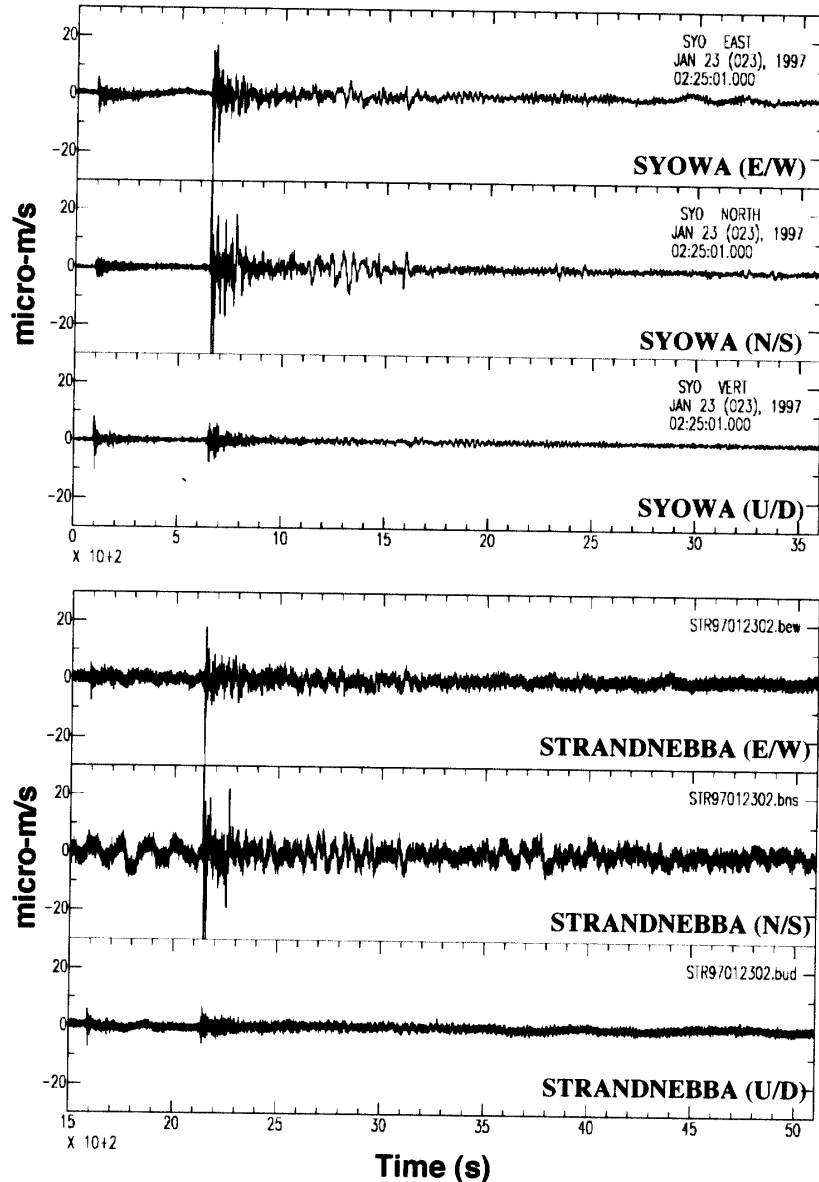

*Fig. 7. Amplitude spectra of traces in Fig. 6 (left: Syowa Station, right: Padda Island). Upper, middle and lower figures show E/W, N/S and U/D components, respectively.*

frequency range lower than about 0.5 Hz for the horizontal component. But for the vertical component, the amplitude spectrum at Padda Island is about ten times larger than that at Syowa Station in the frequency band from 0.3 to 3 mHz (about 300 to 3000 s period). This is probably due to the different frequency ranges of the seismometers. For higher frequency ( $>0.5$  Hz), the amplitude at Padda Island is larger than that at Syowa Station and the amplitude is almost independent of frequency in spite of the anti-aliasing low-pass filter. On the other hand, the spectrum at Padda Island is the same as that at Syowa Station for frequencies from 5 mHz to 0.5 Hz (about 200 to 2 s



**I 1997/ 1/23 2:15:23.30 SOUTHERN BOLIVIA**  
**dist.= 74.61°, Dep.=275.0 km, Mb=6.3**



*Fig. 8. Observed velocity waveforms of the earthquakes which occurred in southern Bolivia, recorded at Syowa Station (upper plot) and at Strandnebbba (lower plot).*

period).

Figures 8 and 9 show the velocity waveforms of the deep teleseismic event and their amplitude spectra recorded at Strandnebbba and Syowa Station, respectively. This earthquake with magnitude 6.3 occurred in southern Bolivia on January 23, 1997 (I in Fig. 5). The noise characteristics are the same as at Padda Island. The noise level is, however, about three or four times as large as that at Syowa Station. The seismometers at Padda Island and Strandnebbba were placed on outcrops and covered with boxes, while the seismometer was installed in a semi-underground seismic vault at Syowa

I 1997/ 1/23 2:15:23.30 SOUTHERN BOLIVIA  
 dist.= 74.61°, Dep.=275.0 km, Mb=6.3

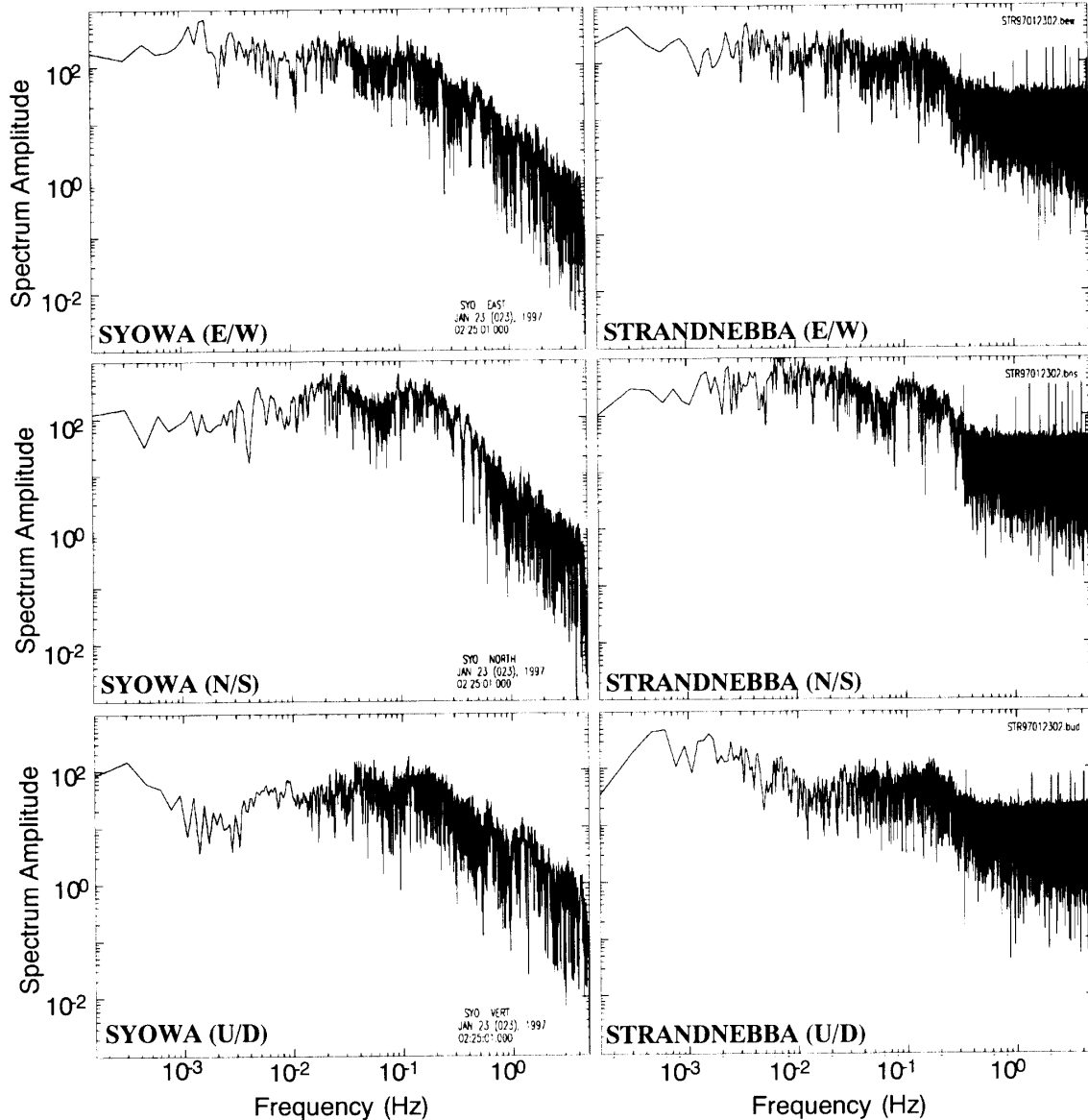

Fig. 9. Amplitude spectra of each trace shown in Fig. 8 (left: Syowa Station, right: Strandnebbja). Other details are the same as in Fig. 7.

Station. Therefore, the large background noise in the field observation data might be caused mainly by wind. There is a difference in the background noise level in high frequency range between the Padda Island and Strandnebbja stations. Padda Island always had wind, while Strandnebbja was not so windy during the observation period. Thus, the noise level appears to indicate the local wind condition.

As mentioned above, the field observation data have the same characteristics for the amplitude spectrum in the frequency range from 5 mHz to 0.5 Hz on both Padda Island and Strandnebbja. This frequency range contains low-frequency body waves and

short-period surface waves. Such kinds of signal can be used for many seismological investigations by using broadband waveforms. These field-recorded data have good enough quality to be used for waveform analysis by applying a suitable band-pass filter. These observations will continue after JARE-39 and the obtained data will hopefully provide better understanding with regard to the crust and upper mantle structure beneath the Lützow-Holm Bay region.

### Acknowledgments

The authors express their thanks to the JARE-37 and -38 wintering members for their generous support and encouragement during the field operations. The authors' thanks extend to Prof. K. KAMINUMA of the National Institute of Polar Research (NIPR) for his valuable advice and discussion through this study and critical readings of the manuscripts. The authors express their sincere thanks to Prof. K. SHIBUYA of NIPR for his beneficial support and advice in the preparation of the recording system. Thanks also go to Drs. Y. NOGI and A. KUBO for their valuable advice and discussions. The authors likewise thank J.E. TULL of Lawrence Livermore National Laboratory for allowing them to use the SAC (Seismic Analysis Code).

### References

- AKAMATSU, J., ICHIKAWA, N. and KAMINUMA, K. (1989): Seismic observation with local telemetry network around Syowa Station, East Antarctica. *Proc. NIPR Symp. Antarct. Geosci.*, **3**, 1–12.
- AKAMATSU, J., ICHIKAWA, N. and KAMINUMA, K. (1990): Seismic observation with local telemetry network around Syowa Station, East Antarctica. *Proc. NIPR Symp. Antarct. Geosci.*, **4**, 90–99.
- KAMINUMA, K., SEGAWA, J., FUKUDA, Y., ITO, K., NAGAO, T., IKAMI, A., FUNAKI, M., SHIRAISHI, K., HIROI, Y., MORIWAKI, K. and YOSHIDA, Y. (1991): Antarctic geoscience transect QML-1A and QML-1B. Special Map Series of National Institute of Polar Research, No. 5.
- KANAO, M. (1997): Variations in the crust structure of the Lützow-Holm Bay region, East Antarctica using shear wave velocity. *Tectonophysics*, **270**, 43–72.
- KENNETT, B.L.N. ed. (1991): IASPEI 1991 Seismological Tables. Canberra, Publ. Australian Nat. Univ., 167 p.
- KUBO, A., HIRAMATSU, Y., KANAO, M., ANDO, M. and TERASHIMA, T. (1995): An analysis of the SKS splitting in Antarctica. *Proc. NIPR Symp. Antarct. Geosci.*, **8**, 25–34.

*(Received May 6, 1998; Revised manuscript accepted June 5, 1998)*