

Adv. Polar Upper Atmos. Res., 19, 89–105, 2005
© 2005 National Institute of Polar Research

Research note

VHF data transmission experiments using MBC equipment conducted during the period from JARE-43 to JARE-45

Kaiji Mukumoto^{1*}, Akira Fukuda¹, Masashi Nagasawa², Yasuaki Yoshihiro¹, Kei Nakano¹, Satoshi Ohichi¹, Hisao Yamagishi³, Natsuo Sato³, Akira Kadokura³, Huigen Yang⁴, Ming Wu Yao⁵, Sen Zhang⁵, Guojing He⁵ and Li-Jun Jin⁵

¹Shizuoka University, 3-5-1, Johoku, Hamamatsu 432-8561

²Numazu College of Technology, 3600, Ooka, Numazu 410-8501

³National Institute of Polar Research, Kaga 1-chome, Itabashi-ku, Tokyo 173-851

⁴Polar Research Institute of China, 451 Jinqiao Road, Pudong, Shanghai 200129, China

⁵Xidian University, 2 Taibai Road, Xi'an, 710071, China

*Corresponding author. E-mail: tekmuku@ipc.shizuoka.ac.jp

(Received December 17, 2004; Accepted March 30, 2005)

Abstract: In order to study the ability of meteor burst communications (MBC) as a new medium of data collection networks in Antarctica, we have performed a series of VHF data transmission experiments. In the experiment during the period of JARE-43 (the 43rd Japanese Antarctic Research Expedition), a remote station at Zhongshan Station sent data packets to a master station at Syowa Station using a commercial MBC system. Together with meteor burst propagations, non-meteoritic propagations were frequently observed during local nighttime. We found that they worked effectively for packet transmissions and greatly increased the data throughput. Overall data throughput obtained by this experiment was 0.63 bps. In JARE-44, we added another remote station at Dome Fuji Station. Since the transmitted power from the master unit was split into two directions, data throughput from Zhongshan Station was reduced to 0.36 bps. That from Dome Fuji Station was only 0.13 bps. For the experiment in JARE-45, we replaced the commercial MBC system with a RANDOM (RADio Network for Data Over Meteor) system developed by the authors. The experiment is being conducted between Syowa and Zhongshan Stations. The estimated data throughput during the period from April 1st, 2004 to August 31st, 2004 was 2.9 bps.

key words: meteor burst communications, Antarctica, VHF, software modem, aurora

1. Introduction

MBC (Meteor Burst Communication) is known to have superiority over other BLOS (Beyond Line of Sight) communications (e.g. those using HF and satellite channels) in many respects such as simplicity of implementation and operation, lower initial and running costs, and reliability (Fukuda, 1997; Schanker, 1990). At high latitudes, in particular, MBC has a strong advantage over HF communications (Weitzen

et al., 1993). Since MBC uses higher frequencies (low VHF band) than HF communications, it is less subject to anomalous absorption events (such as polar cap and aurora absorption). Moreover, it is also known that MBC is very suitable for non-real time, slow rate data acquisition networks consisting of one (or few) master station(s) and many remote stations. This is because the primary drawback of MBC, that is, the low duty cycle of the intermittent channel between two stations is largely mitigated in such a star network. Thus, the authors have proposed to use MBC network for the Antarctic survey and conducted some basic experiments in Antarctica since December 2001 to study the ability of MBC for such a data collection network.

Some experiments were conducted in Arctic region such as Greenland and Alaska to study the properties of MB (Meteor Burst) channels at high latitudes. However, in the Antarctic region, there have been few experiments on MBC, even to study the properties of MB channels in that region except for the ones with backscatter meteor radars (Ogawa *et al.*, 1985; Tsutsumi *et al.*, 2001).

At high latitudes, MB propagation is not the only BLOS propagation mode in the VHF band. Others may include some kinds of sporadic E (E_s), auroral scatter and F layer propagation modes. Auroral E_s over Syowa Station is known to occur mainly at local nighttime (Ose, 1962) and its formation is related to electrojet which appears with aurora phenomenon (Fukunishi *et al.*, 1983). Cannon *et al.* (1994, 1996) reported that “wind shear E_s ”, known as mid-latitude E_s , is also frequently observed at high latitudes. E_s propagation modes are generally characterized by low multipath spread, slow fading, and high signal levels (Weitzen *et al.*, 1987; Weitzen and Ralston, 1988). In the high latitude E layer, VHF signals are also scattered by magnetic-field-aligned plasma irregularities. This mode of propagation is known as auroral scatter and is widely investigated in the fields of aurora and ionosphere observations (Koustov *et al.*, 2001; Makarevitch *et al.*, 2002). Signals scattered by this mode are generally subject to severe multipath, rapid fading, relatively large Doppler shift, and broader Doppler spread, so that auroral scatter is thought to have properties not compatible with usual coherent signaling techniques commonly used in MBC (Ostergaard *et al.*, 1985; Weitzen *et al.*, 1987). Some mechanisms related to the F layer can also propagate VHF signals. While such F layer propagations can increase system duty cycle, they may cause multi-path signals that result in high bit error rates due to inter-symbol interference (Maynard, 1968). Another important phenomenon related to MBC at high latitudes is anomalous ionospheric absorption, both polar cap and auroral. It may significantly reduce system duty cycle and cause long lasting blackout (McDonough *et al.*, 1993).

In this paper, all BLOS propagation modes other than MB are lumped and referred to as NMB (Non-Meteor Burst) propagation modes from a communication viewpoint. In our experiment, NMB propagation phenomena are frequently observed mainly at local nighttime.

Our experiments started in December 2001. In the first year, during the period of JARE-43 (the 43rd Japanese Antarctic Research Expedition, December 2001–March 2003), two kinds of experiments, ‘tone experiment’ and ‘data experiment’, were conducted between Syowa and Zhongshan Stations. In the former experiment, a continuous tone signal was sent from Zhongshan Station (69.4°S, 76.4°E geographic; 74.6°S, 96.5°E corrected geomagnetic) and the signal level observed at Syowa Station (69.0°S,

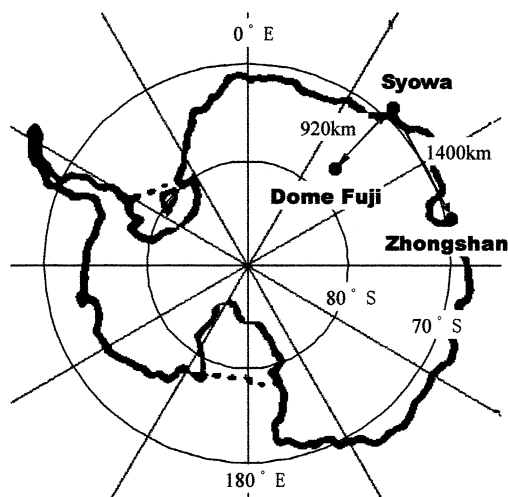

Fig. 1. Location of the stations.

39.6°E geographic; 66.2°S , 72.0°E corrected geomagnetic) was recorded to study the basic properties of the MB channel. In the latter one, a remote station located at Zhongshan Station sent data packets to a master station at Syowa Station to evaluate the performance of a commercial MBC system in this region. The radio units used in the experiment were manufactured by MCC (Meteor Communications Co., Wash., USA). In JARE-44 (December 2002–March 2004), we added another MCC remote station at Dome Fuji Station (77.3°S , 39.7°E geographic; 70.8°S , 56.7°E corrected geomagnetic) and tried to collect data from two remote stations simultaneously. Figure 1 illustrates the path geometry. While Syowa and Zhongshan Stations are located at almost the same latitude, Dome Fuji Station is located at almost the same longitude as Syowa Station. By this configuration, we can examine the effect of path direction and length on the system performance. In JARE-45 (December 2003–March 2005), we have replaced the MCC system by a RANDOM (Radio Network for Data Over Meteor) system designed and developed by the authors. This experiment is now being conducted between Syowa and Zhongshan Stations. Dome Fuji Station was not used for this experiment since no wintering party was sent there in JARE-45. The tone experiment has been continuously conducted between Syowa and Zhongshan Stations during the periods of JARE-44 and JARE-45.

In this paper, we show the results of the data experiments conducted during the periods from JARE-43 to JARE-45 from the viewpoint of communications. Detailed geophysical considerations are left to future papers, which will discuss the issue with the result of the tone experiment. Overall descriptions of our MBC experiments in Antarctica are found in Fukuda *et al.* (2003, 2004). Some results of the tone experiment are described in Nagasawa *et al.* (2004).

2. Data experiment in JARE-43

2.1. Description of the experiment

In the data experiment during the period of JARE-43, we used a commercial MBC system, in which the radio units were manufactured by MCC. The radio units are designed for general use, so that system designers are required to properly set the parameters of the units for their networks. Moreover, the MCC system can transmit various types of data such as messages, positional data, and data logger data. Its transmission procedure changes with the type of data. In our experiment, we set the parameters assuming a star network consisting of one master station and many remote stations, although there was only one remote station in the real experimental system. Also, we assumed that the network would collect scientific data, so that the remote station was set to send data stored in a data logger.

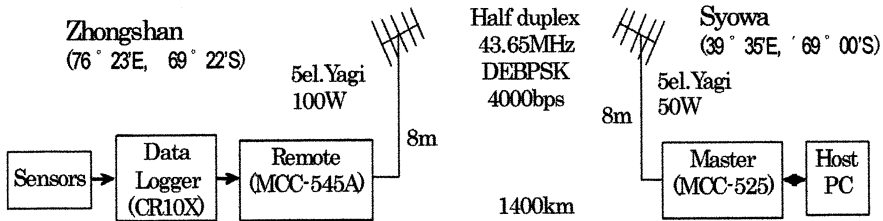

Fig. 2. Equipment for the data experiment during the period of JARE-43.

Figure 2 shows the equipment for the data experiment conducted during the period of JARE-43. The remote and master units are designated MCC-545A and MCC-525, respectively. The remote unit equipped at Zhongshan Station was set to acquire data of 20 bytes from a data logger designated CR10X (manufactured by Campbell Scientific Ut. USA) with an interval of 5 min. The acquired data is sent as a DP (Data Packet) when the remote station receives a PP (Probe Packet) sent by the master unit installed at Syowa Station. When the master unit successfully receives the DP, it sends an AP (Acknowledge Packet) to the remote station. If the remote station receives the AP, then it removes the transmitted data set from the transmission buffer and proceeds to the next data set. We set the lifetime of DPs to 2 hours in the experiment. *i.e.*, if the remote station cannot receive an AP for a DP within 2 hours, then it discards the DP. Figure 3 shows the length and transmission timing of packets used in the experiment.

In the experiment, the master station was set to operate only 5 min in each 10 min interval to avoid interference with the tone experiment. At Syowa Station, we had to use a long coaxial cable (10D2E of length 150 m) for connecting the master unit with the antenna since there was no suitable antenna site near the equipment house. Nominal attenuation of the cable is about 31 dB/km at 50 MHz. Thus, the estimated power radiated from the antenna was about 50 W though the power output from the master unit was 150 W. Also, at Zhongshan Station, we used the same cable (10D2E) of length 60 m to connect between the remote unit and the antenna. The power output

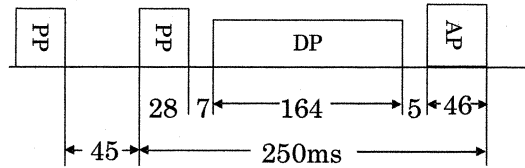

Fig. 3. The length and transmission timing of packets used in the data experiment during the period of JARE-43.

from the remote unit was around 150 W. Thus, the estimated radiation power from the antenna was about 100 W. More detailed descriptions of the experiment can be found in Fukuda *et al.* (2003, 2004) and Mukumoto *et al.* (2004).

2.2. Results and discussion

The data experiment in JARE-43 started April 1st, 2002 and lasted until December 31st, 2002. Figure 4 shows hourly data and PP reception ratios averaged over this period together with the 10 dB duty cycle obtained by the tone experiment. Here, data reception ratio is defined by the number of received data sets during a specified period divided by the number of data sets generated during that period. In the experiment, we have set the remote station to generate 12 data sets per hour. Similarly, PP reception ratio is defined by the number of received PPs in a specified period divided by the number of transmitted PPs in that period. In the calculation of the hourly PP reception ratio in Fig. 4, we have used a fixed value (24658) as the denominator although it is not precisely constant. This value is obtained by assuming that PPs are constantly transmitted with the interval shown in Fig. 3. This is apparently an overestimate but may be a good estimate since the cause of decreasing the number of PP transmissions is DP arrivals and, in this experiment, the number of DP generations per hour is limited to 12. On the other hand, 10 dB duty cycle is obtained from the tone experiment according to the process described in Fukuda *et al.* (2004) and Yoshihiro

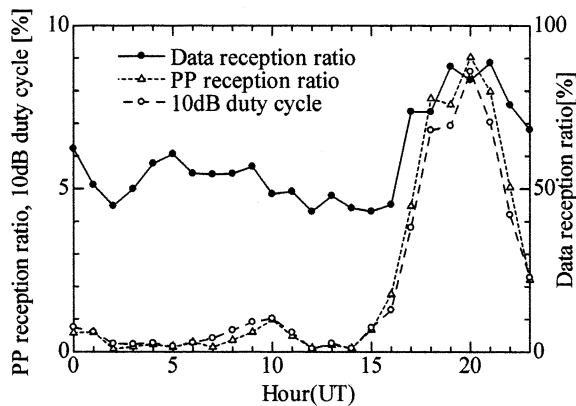

Fig. 4. Hourly variations of data reception ratio, PP reception ratio and 10 dB duty cycle (April 1st–December 31st, 2002).

Table 1. List of days excluded from the analysis.

| Statistics | Days excluded from the analysis |
|----------------------|--|
| Data reception ratio | April 18, April 21–22, June 15–16, Aug. 29–Sep. 17, Oct. 16–29, Dec. 6–10, Dec. 30–31 |
| PP reception ratio | April 21–22, May 15–17, May 28–29, June 15–16, Aug. 29–Sep. 17, Oct. 16–29, Dec. 23–26, Dec. 30–31 |
| 10 dB duty cycle | April 4, April 21–23, Dec. 24–25 |

et al. (2001). We have used two antennas with different tower length for the reception of tone signals. The hourly 10 dB duty cycle shown in Fig. 4 is obtained by analyzing tone signal received by the lower antenna and averaging over the same period with the data experiment, *i.e.*, from April 1st, 2002 to December 31st, 2002.

In the analyses of these hourly statistics, we have excluded days listed in Table 1 from the averaging because the system stopped operation or operated under some different parameter settings in those days.

In Fig. 4, all curves exhibit an increase during the period around 15–24 UT. Local time at the midpoint of the path between Syowa and Zhongshan Stations proceeds about 4 hours from UT. Thus, the period of 15–24 UT corresponds to local nighttime. As mentioned in Nagasawa *et al.* (2004), the increment observed during local nighttime is thought to be caused by NMB propagation phenomena. It should be noted that the NMB propagations have very different properties from those mentioned in Weitzen *et al.* (1993) and Cannon *et al.* (1994, 1996). They are also different from NMB propagations observed at mid-latitude, which are known to occur mainly during daytime in summer.

Curves of 10 dB duty cycle and PP reception ratio are very similar not only in their shapes but also in their values. If Syowa and Zhongshan Stations had the same noise environment, received PP power with SNR of 4.2 dB corresponds to received signal level of 10 dB above the noise power in the tone experiment. This is deduced from the fact that 1) the radiation power of PP transmission was 50 W while that of tone signal was 115 W and 2) packet transmission speed of the MCC system is 4000 bps while the assumed noise bandwidth to determine the threshold levels in the tone experiment is 2400 Hz. Considering that packets in the MCC system are BPSK (Binary Phase Shift Keying) modulated and coherently demodulated, it seems plausible in case of ideal AWGN (Additional White Gaussian Noise) channel to require SNR of more than 4.2 dB for receiving PPs. Thus, it implies that the channel has good characteristics *i.e.*, it can be modeled as an intermitted fading AWGN channel without multipath or frequency shift. Moreover, we can see the coincidence of the curves of PP reception ratio and 10 dB duty cycle even in local nighttime. Thus, we can conclude that the NMB propagations also work effectively for coherent packet transmissions.

On the other hand, the curve of data reception ratio changes not proportionally to that of 10 dB duty cycle although their shapes show some resemblance. This is because the transmission buffer at the remote station is frequently being empty during the period with large duty cycle since DPs are generated with the interval of 5 min and their lifetime is set to 2 hours. It should be noted that there may exist some other minor reasons such as 1) a DP reception requires 250 ms of continuous channel open, 2) the master station

Table 2. Averages over April 1st–December 31st, 2002.

| | 10 dB duty cycle (%) | PP reception ratio (%) | Data reception ratio (%) |
|-----------------------|----------------------|------------------------|--------------------------|
| Total average | 2.15 | 2.01 | 59.1 |
| Average over 00–16 UT | 0.36 | 0.46 | 51.4 |
| Average over 16–24 UT | 5.73 | 5.12 | 74.4 |

stops PP transmissions for a few hundred milliseconds after a DP reception.

In the figure, we also find that there is small increment in PP reception ratio and 10 dB duty cycle around 10 o'clock. This increment stems from a propagation phenomenon occurred in the period from December 10th to 18th. We have not yet identified the propagation phenomenon (Geminids meteor shower is suspected).

Table 2 is a list of the results averaged over the period from April 1st, 2002 to December 31st, 2002 excluding days listed in Table 1. Total data reception ratio averaged over all hours is about 59.1% while those averaged over the periods of 00–16 UT and 16–24 UT are 51.4% and 74.4%, respectively. The difference is caused by NMB propagations that have been frequently observed after 16 UT. Since the system has operated only 5 min in each 10 min interval and a DP has contained 20 bytes of information, the data throughputs is 0.63 bps for the whole hours, 0.55 bps for the hours before 16 UT and 0.79 bps for the hours after 16 UT, respectively. On the other hand, from PP reception ratios, we can estimate the ratio of the time during which the channel can transmit data at the speed of 4000 bps to the operating period. The estimated values are 2% for the whole hours, 0.46% for the hours before 16 UT and 5.12% for the hours after 16 UT. Channel capacities or possible maximum data throughputs calculated from these results are 80 bps, 18.4 bps and 204.8 bps, respectively. Of course, no system can attain these data throughputs since DPs generally need some overheads and their transmissions are controlled by some transmission procedure. In case of the MCC system, to transmit 20 bytes of data, it requires at least 250 ms of continuous channel opening as previously shown in Fig. 3. Thus, data throughput of the MCC system is greatly reduced from the channel capacities obtained above even if the remote station always has DPs in its transmission buffer.

It should be noted that the proportion of PP reception ratio to 10 dB duty cycle for the hours before 16 UT is 1.28 whereas that for the hours after 16 UT is 0.89. This may imply that NMB channels have characteristics somewhat worse than the MB channel.

Figure 5 shows daily averaged data reception ratio, PP reception ratio, and 10 dB duty cycle for July 2002. In this figure, we also find good coincidence between the daily variations of PP reception ratio and 10 dB duty cycle. On the other hand, correlations between the daily variation of data reception ratio and those of PP reception ratio and 10 dB duty cycle are very little. This is because the transmission buffer at the remote station is frequently being empty during the period with large duty cycle, so that the increase of duty cycle does not directly bring about the increase of data reception ratio as mentioned before. It should be noted that the daily variations of PP reception ratio and 10 dB duty cycle are dominated by the occurrence of NMB phenomena and their durations.

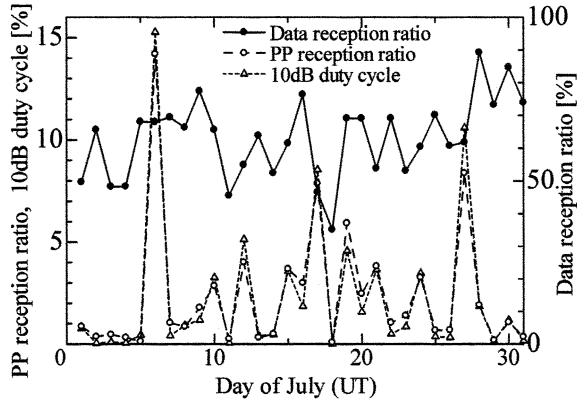

Fig. 5. Daily variations of data reception ratio, PP reception ratio and 10dB duty cycle (April 1st–December 31st, 2002).

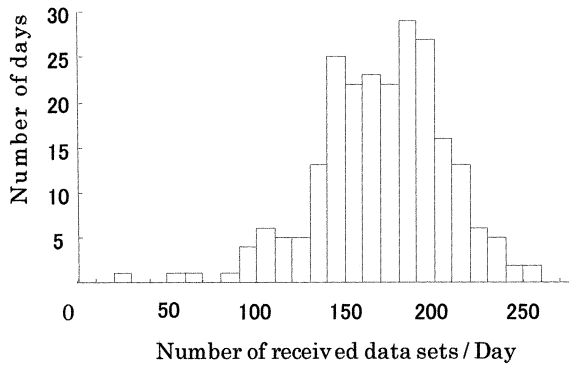

Fig. 6. Histogram of the number of received data sets per day (April 1st–December 31st, 2002).

Figure 6 shows a histogram of the number of days classified by the number of received data sets per day with the resolution of 10 packets. We find that the graph exhibits the shape of a mountain with somewhat flat top since there exist two kinds of days *i.e.*, days with and without NMB phenomena. This implies that, during the experimental period, there were no serious blackout events that retarded MBC data transmission for a long time. Specifically, days with the number of received data sets less than 100 were 8 days divided into three periods. They were 22 Aug. (67), 24 Aug. (58), 25 Aug. (93), 30 Oct. (90), 31 Oct. (82), 10 Nov. (22), 11 Nov. (94). Here, numbers in parentheses represent the number of data sets received in each day.

3. Data experiment in JARE-44

3.1. Description of the experiment

Figure 7 shows the system of the data experiment conducted during the period of

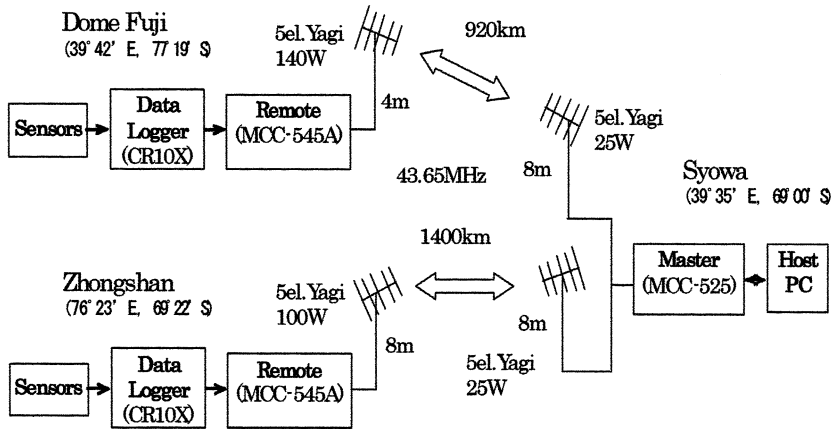

Fig. 7. Equipment for the data experiment during the period of JARE-44.

JARE-44. In this experiment, we added another MCC remote station at Dome Fuji Station, which had the same configuration as the remote station at Zhongshan Station except for the antenna tower length and the radiation power. At Dome Fuji Station, the antenna tower with the length of 4 m was installed near the equipment house. The measured output power from the remote unit at Dome Fuji Station was around 140 W. The antenna cable used in Dome Fuji Station was short, so that the loss was negligible. At Syowa Station, two antennas, each directed to Zhongshan and Dome Fuji Stations respectively, were connected to the master unit using a split cable. Because of this configuration, the transmission power from the master unit was divided into two coaxial cables connected to each antenna. Thus, the radiation power of each antenna was estimated to be only about 25 W. On the other hand, when receiving a DP, input to the master unit was the sum of power from the antenna directed to the signal source and that from the antenna without signal arrival. Thus, SNR of DP was lowered about 3 dB.

Prior to the experiment shown in Fig. 7, we also carried out another short term experiment where only the Dome Fuji remote station was operated as a remote station and the master unit at Syowa Station was connected solely to the antenna directed to Dome Fuji Station.

In both the experiments, the operation of the system was the same with that in the data experiment in JARE-43, *i.e.*, the master station transmitted PPs only 5 min in each 10 min, the remote stations acquired 20 byte data with the interval of 5 min and lifetime of data was set to be 2 hours. The three kinds of data experiments and their durations are:

- ① From Zhongshan to Syowa, April 1st, 2002–December 31st, 2002,
- ② From Dome Fuji to Syowa, February 27th, 2003–March 23rd, 2003,
- ③ From Zhongshan and Dome Fuji to Syowa, March 25th, 2003–December 31st, 2003.

As mentioned before, we exclude days listed in Table 1 in the analysis of the experiment during the period of JARE-43. As for the analysis of the experiment in JARE-44, we exclude days from July 30th, 2003 to August 8th, 2003 since the system was not operated during that period due to a hardware problem at the master station.

3.2. Results and discussion

Figure 8 shows averaged hourly data reception ratios for the experiments listed above. We see that all the curves shows larger values during the period of 16–24 UT, which is thought to be due to NMB propagations. Comparing the results of ① and ②, we see that the data reception ratio from Dome Fuji remote station is smaller than that from Zhongshan remote station. The possible causes of this result are the difference in 1) location of the remote stations, 2) direction of the paths and 3) length of the paths. However, we cannot exclude other possibilities, which are somewhat artificial reasons, such as difference of the radio units, antenna height and noise conditions. Thus, to get a conclusion for this issue, we need additional carefully designed experiments.

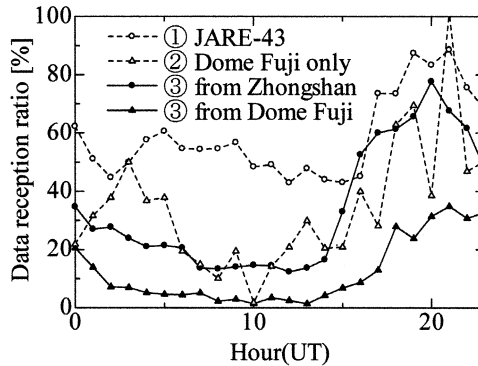

Fig. 8. Hourly variations of data reception ratios (①: April 1st–December 31st, 2002, ②: February 27th–March 23rd, 2003, ③: March 25th–December 31st, 2003).

Next, we compare data reception ratios from Zhongshan Station in the experiments of ① and ③. During 00–15 UT, the latter is less than one half of the former. This is because effective radiation power of PPs in the experiment of ③ is a half of that in the experiment of ① since the transmission power is separated into two antennas. On the other hand, during the period of 16–24 UT, the effect of reduced radiation power in PP transmission on the data reception ratio is not large since NMB propagations effectively reflect radio signals.

Comparing data reception ratios from Dome Fuji and Zhongshan Stations in the experiment of ③, we find that, as in the case of comparison between ① and ②, the former is fairly lower than the latter. We also find that the peak of the former is slightly delayed from that of the latter. This may be due to the fact that midpoint of the path between Syowa and Dome Fuji Stations is located to the west of that between Syowa and Zhongshan Stations.

The data reception ratios and the data throughputs for the experiments are summarized in Table 3. Here, data throughput is defined by the number of data bits successfully transferred divided by the operational period in second.

In Fig. 9, we show the seasonal variations of data reception ratios by averaging over month-by-month. It is seen that the variations of all the curves are not large but exhibit

Table 3. Data reception ratios and data throughputs.

| Experiment | Data reception ratio (%) | | | Data throughput (bps) | | |
|------------------|--------------------------|----------|----------|-----------------------|----------|----------|
| | Total | 00–16 UT | 16–24 UT | Total | 00–16 UT | 16–24 UT |
| ① | 59.1 | 51.4 | 74.4 | 0.63 | 0.55 | 0.79 |
| ② | 34.4 | 24.2 | 54.7 | 0.37 | 0.26 | 0.58 |
| ③ from Zhongshan | 34.0 | 20.3 | 61.8 | 0.36 | 0.21 | 0.66 |
| ③ from Dome Fuji | 12.3 | 5.8 | 25.4 | 0.13 | 0.06 | 0.27 |

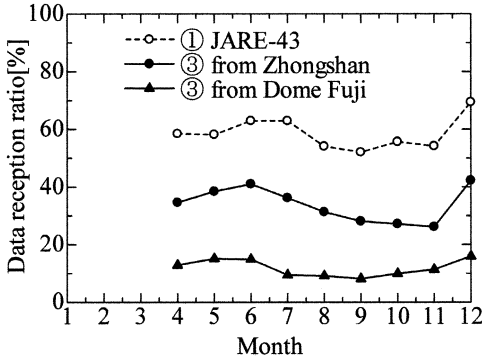

Fig. 9. Seasonal variation of data reception ratios.

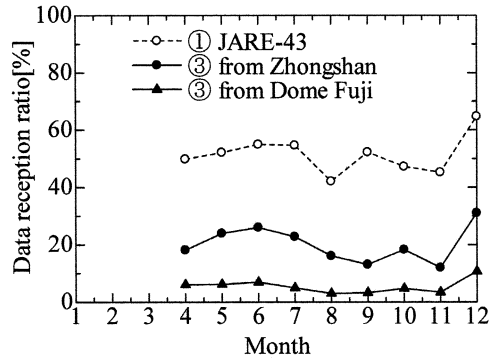

Fig. 10. Seasonal variation of data reception ratios (averaged over 00–16 UT).

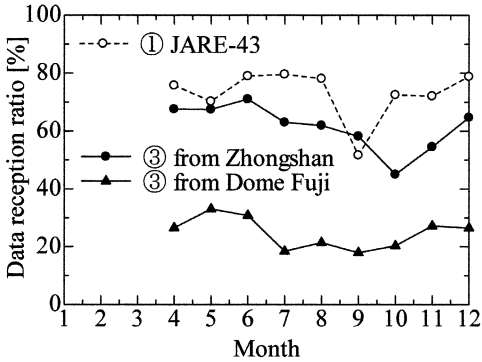

Fig. 11. Seasonal variation of data reception ratios (averaged over 16–24 UT).

a similar shape. To examine the cause of the seasonal variation, we show the monthly data reception ratios for MB hours (00–16 UT) and NMB hours (16–24 UT) in Figs. 10 and 11, respectively. In Fig. 10, the data reception ratios of the JARE-44 experiment exhibit a similar shape to that of the JARE-43 experiment. On the other hand, as shown in Fig. 11, we can see no apparent correlation between the seasonal variations in the case of NMB hours. Thus, we can conclude that the seasonal variation in the occurrence of MBs is the cause of the variations of the data reception ratios appeared in Fig. 9.

Figure 12 shows histograms of the number of days classified by the number of

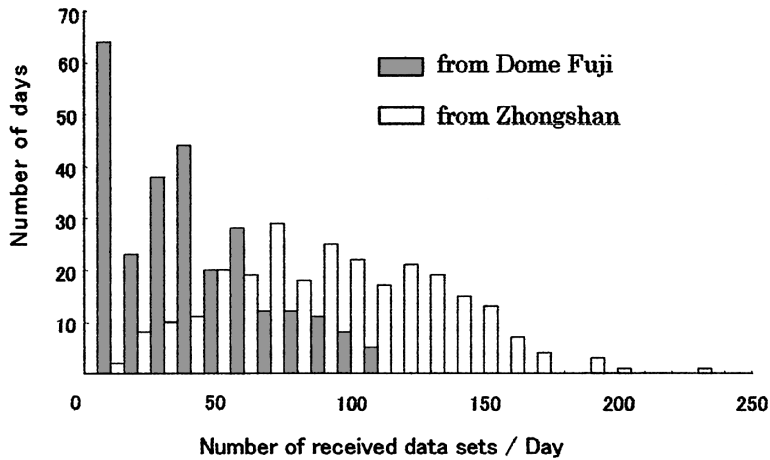

Fig. 12. Histogram of the number of received data sets per day (March 25th–December 31st, 2003).

received data sets from each remote station per day with the resolution of 10 packets for the experiment of ③. As in Figs. 8 and 9, we also recognize from this figure that the number of data receptions from Dome Fuji Station is much smaller than that from Zhongshan Station. The shape of distribution of the number of data receptions per day from Zhongshan Station is a symmetric flat top mountain whereas that from Dome Fuji Station is asymmetric having its maximum of 64 days at less than 10 packets per day. Moreover, among the 64 days, no data receptions were observed in 27 days. This number is almost 10 percent of the total number of days observed (265 days). Possible cause for no data receptions is some sort of absorption phenomenon. However, the number of data receptions from Dome Fuji Station is not enough to have a conclusion.

4. Data experiment in JARE-45

4.1. Description of the experiment

Figure 13 is the system for the data experiment conducted during the period of JARE-45. In this experiment, we have replaced the MCC system by a RANDOM system designed and developed by the authors. The experiment is now being conducted between Syowa and Zhongshan Stations. Radio equipment used in the experiment is named IT-5000. The transmission power output from IT-5000 is rather accurately adjusted to 100 W. At Syowa Station, we have replaced the long antenna cable (10D 2E) with a thicker one (12DSFA) before the experiment. Nominal attenuation of the new cable is about 15.5 dB/km. Thus, estimated radiation power from the antenna of the master station is about 60 W. At Zhongshan Station, we have not changed the cable, so that estimated radiation power from the remote station is about 65 W.

The hardware of IT-5000 consists of radio, control, and DSP (Digital Signal Processor) units as shown in Fig. 14. The radio unit is responsible for 1) frequency conversion between low VHF and low IF (0.3–9.0 kHz) bands, 2) RF filtering and amplification, and 3) high speed switching between receiving and transmitting RF

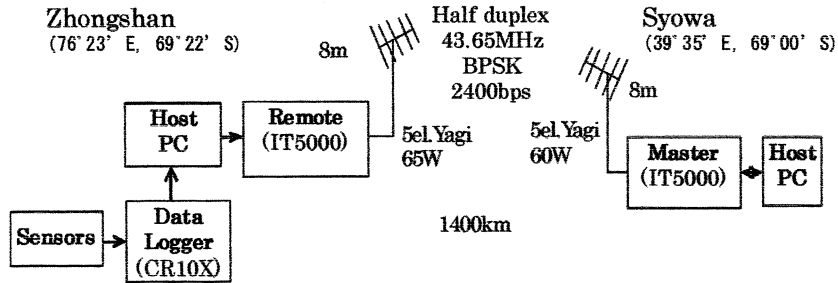

Fig. 13. Equipment for the data experiment during the period of JARE-45.

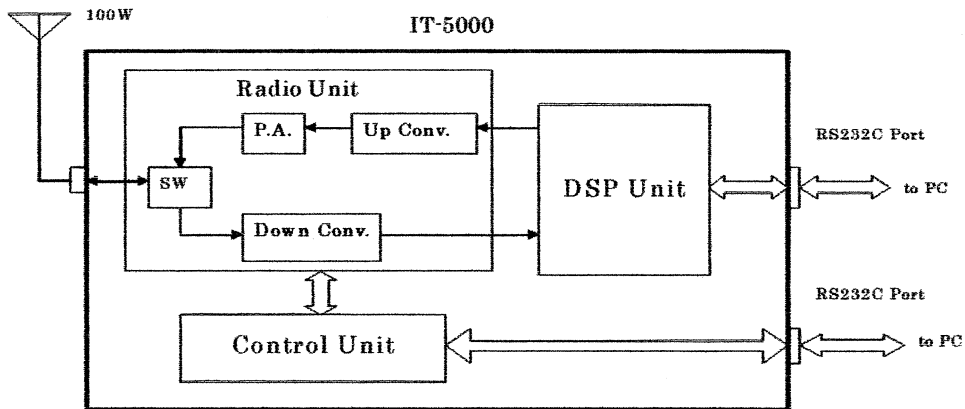

Fig. 14. Block diagram of IT-5000.

signal. The control unit monitors the radio unit. In case of detecting anomalous operation, it stops the radio unit and announces the cause to the operator. The software loaded in the DSP provides all other functions needed as an MBC equipment, which include 1) packet detection, 2) carrier and bit synchronization, 3) modulation and demodulation in low IF band, 4) coding and decoding, 5) protocol handling, 6) interfacing between the radio and the host computer, and so on.

Since almost all communication functions are accomplished by software, IT-5000 can be applied to various communication systems by changing the software on the DSP (Mahmud *et al.*, 2001). The software developed for the experiment in JARE-45 is named SMR2003. It can treat BPSK and QPSK (Quadrature Phase Shift Keying) packets with symbol speed of less than 4800 baud. Taking into account of relatively small transmission power, we have selected BPSK modulation with transmission speed of 2400 bps for the experiment. In SMR2003, packets are accurately detected and coherently demodulated by means of newly developed methods suitable for software modem (Mukumoto *et al.*, 2002). The transmission protocol installed is essentially the same as the MCC protocol described in Section 2.1. Figure 15 shows length of the packets and the transmission timing. Note that required duration of channel opening for sending a 20-byte data is 140 ms. This is shorter than that of MCC system in spite

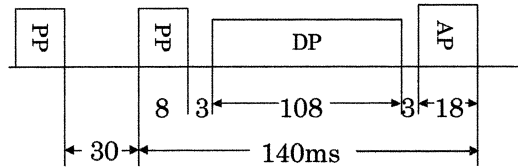

Fig. 15. Length of the packets and the transmission timing in RANDOM system.

of the lower transmission speed. This is because packets in the RANDOM system are greatly shortened using new techniques realized by the software modem.

Further, in this experiment, the lifetime of a DP is not limited. Instead, the size of the transmission buffer in the remote station is limited. In the RANDOM system, data collected by a data logger are first stored in memory in a host PC (Personal Computer) connected to IT-5000. Then, the host PC sends the data set to a buffer in DSP if there is room. The buffer can accommodate 4 data sets. The memory size in the host PC is set to 100 data sets. Another difference from the MCC protocol is dummy packet transmission, *i.e.*, in this experiment, the remote station is set to send a dummy packet with the same length as a DP when it has no data to transmit in spite of PP reception.

Again, as in the previous experiments, the master station sends PPs 5 min in each 10 min interval and the remote station acquires 20 byte data with the interval of 5 min.

4.2. Results and discussion

We show here only one figure as the first report of the experiment. Figure 16 shows hourly data throughput averaged over the period from April 1st, 2004 to August 31st, 2004. Here, the hourly data throughput is calculated as follows: 1) count the number of DPs including duplicated ones and dummy packets received at the master station during an hour, 2) multiply by 160, the number of information bits in a packet, and 3) divide by 1800, the length of the period in operation.

In the figure, we also show the hourly data throughput for the MCC system obtained from the experiment during the period of JARE-43, from April 1st, 2002 to

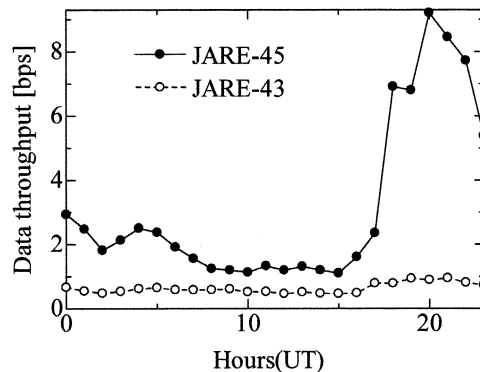

Fig. 16. Hourly data throughputs (April 1st–August 31st, 2004 for the experiment in JARE-45, April 1st–December 31st, 2002 for the experiment in JARE-43).

December 31st, 2002, for the purpose of comparison. This data throughput is calculated from the data reception ratio shown in Fig. 4, so that duplicated data is not included in this case.

Overall data throughput for the RANDOM system obtained by averaging over the whole hours is 3.2 bps while that for the MCC system is 0.63 bps. However, it should be noted that the result for the RANDOM system is somewhat overestimated since it includes duplicated receptions. By examining the received data, we find that duplicated DPs are about 10 percent of the received DPs. Thus, the data throughput without duplicated receptions is estimated to 2.9 bps.

In order to estimate data throughput precisely, we need information of AP receptions at Zhongshan Station that is to be brought from Antarctica after the experiment is completed. More precise performance evaluations using such information and other interesting results will be presented in the near future.

5. Conclusions

This paper showed the results of data experiments conducted during the period from JARE-43 to JARE-45. In JARE-43, we performed the data transmission experiment between Syowa and Zhongshan Stations using a commercial MBC system manufactured by MCC. Comparing with 10 dB duty cycle obtained by the tone experiment, hourly and daily averaged data and PP reception ratios were examined. We found that NMB propagation phenomena frequently observed at local nighttime work effectively for packet transmissions and greatly increase the data throughput. Overall data throughput obtained by this experiment was 0.63 bps. During the experiment, we did not observe serious blackout events that retarded MBC data transmission for a long time. In JARE-44, we added another MCC remote station at Dome Fuji Station. Since the power from the master unit was split into two antennas each directed to the remote stations, data throughput from Zhongshan Station was reduced to 0.36 bps and that from Dome Fuji Station was only 0.13 bps. There were some days without data receptions from the Dome Fuji remote station. For the experiment conducted during the period of JARE-45, we replaced the MCC system with a RANDOM system developed by the authors. The experiment is being conducted between Syowa and Zhongshan Stations. It is expected that the software modem and newly developed techniques greatly improve the performance. In fact, the estimated data throughput during the period from April 1st, 2004 to August 31st, 2004 was 2.9 bps, corresponding to 31.32 kbyte per day. This is enough ability for some kinds of scientific data transmission such as meteorological monitoring, telemetering magnetic activity data and so on.

Acknowledgments

This research is supported by the Grant-in-Aid for Scientific Research (C2 14550353) from Japan Society for the Promotion of Science. The installation and operation of the meteor burst communication system at Zhongshan and Syowa Stations were supported by the 18th, 19th, and 20th Chinese Antarctic Research Expeditions and

the 43rd, 44th, and 45th Japanese Antarctic Research Expeditions, respectively.

The editor thanks Drs. T. Ogawa and P.S. Cannon for their help in evaluating this paper.

References

- Cannon, P.S., Weitzen, J.A., Ostergaard J. and Rasmussen, J.E. (1994): Meteor burst and other long distance high latitude propagation modes in the low VHF band. *Proc. IEE HF Radio Systems and Techniques*, 353–357.
- Cannon, P.S., Weitzen, J.A., Ostergaard, J. and Rasmussen, J.E. (1996): Relative impact of meteor scatter and other long-distance high-latitude propagation modes on VHF communication systems. *Radio Sci.*, **31**, 1129–1140.
- Fukuda, A. (1997): Meteor Burst Communications. Tokyo, Corona Publ. (in Japanese).
- Fukuda, A., Mukumoto, K., Yoshihiro, Y., Nagasawa, M., Yamagishi, H., Sato, N., Yang, H., Yao, M. and Jin, L. (2003): Experiments on Meteor Burst Communications in the Antarctic. *Adv. Polar Upper Atmos. Res.*, **17**, 120–136.
- Fukuda, A., Mukumoto, K., Yoshihiro, Y., Nakano, K., Ohichi, S., Nagasawa, M., Yamagishi, H., Sato, N., Kadokura, A., Yang, H., Yao, M., Zhang, S., He, G. and Jin, L. (2004): Meteor burst communications in the Antarctica: Description of experiments and first results. *IEICE Trans. Commun.*, **E87-B**, 2767–2776.
- Fukunishi, H., Kokubun, S. and Matuura, N. (1983): Nankyoku no Kagaku, 2. Ôrora to Chôkôsô Taiki (Science in Antarctica 2). Tokyo, Kokon Shoin, 255–256 (in Japanese).
- Koustov, A.V., Igarashi, K., Andre, D., Ohta, K., Sato, N., Yamagishi, H. and Yukimatu, A. (2001): Observations of 50- and 12-MHz auroral coherent echoes at the Antarctic Syowa Station. *J. Geophys. Res.*, **106** (A7), 12875–12887.
- Mahmud, K., Mukumoto, K. and Fukuda, A. (2001): A bandwidth efficient variable rate transmission scheme for meteor burst communications. *IEICE Trans. Commun.*, **E84-B**, 2956–2966.
- Makarevitch, R.A., Koustov, A.V., Igarashi, K., Ohtaka, K., Ogawa, T., Nishitani, N., Sato, N., Yamagishi, H. and Yukimatu, A.S. (2002): Comparison of flow angle variations of E-region echo characteristics at VHF and HF. *Adv. Polar Upper Atmos. Res.*, **16**, 59–83.
- Maynard, L.A. (1968): Meteor burst communication in the Arctic. *Ionospheric Radio Communications: Proc. NATO Institute on Ionospheric Radio Communications in the Arctic, Finse, Apr. 13–19, 1967*. New York, Plenum, 165–173.
- McDonough, A.K., Desourdis, R.I., Jr. and Katan, J.R. (1993): “Blackout” of simultaneous HF skywave and VHF meteor burst communication links. *Proc. IEEE MILCOM’93*, Boston, U.S., 402–406.
- Mukumoto K., Ohichi S. and Fukuda, A. (2002): A new packet detection and CPSK demodulation method for the MBC software modem. *IEICE National Convention Record B-2-20* (in Japanese).
- Mukumoto, K., Fukuda, A., Yoshihiro, Y., Nakano, K., Ohichi, S., Nagasawa, M., Yamagishi, H., Sato, N., Kadokura, A., Yang, H., Yao, M., Zhang, S., He, G. and Jin, L. (2004): On the MBC data transmission experiment in Antarctica. Technical Report in *IEICE SANE2003–95*, 13–17 (in Japanese).
- Nagasawa, M., Mukumoto, K., Fukuda, A., Yoshihiro, Y., Nakano, K., Ohichi, S., Yamagishi, H., Sato, N., Kadokura, A., Yang, H., Yao, M., Zhang, S., He, G. and Jin, L. (2004): Observation of Antarctic meteor burst communication channel using tone signal. Technical Report in *IEICE SANE2003–96*, 19–24 (in Japanese).
- Ogawa, T., Igarashi, K., Kuratani, Y., Fujii, R. and Hirasawa, T. (1985): Some initial results of 50 MHz meteor radar observation at Syowa Station. *Mem. Natl Ins. Polar Res., Spec. Issue*, **36**, 254–263.
- Ose, M. (1962): Auroral E_s and blackout under the ionospheric observation. *Nankyoku Shiryô (Antarct. Rec.)*, **15**, 25–31.
- Ostergaard, J.C., Rasmussen, J.E., Sowa, M.J., Quinn, J.M. and Kossey, P.A. (1985): Characteristics of high latitude meteor scatter propagation parameters over the 45–104 MHz band. Paper presented at AGARD Conf. Publ., CP-382.

- Schaner J.Z. (1990): *Meteor Burst Communications*. Boston, Artech House Inc.
- Tsutsumi, M., Aso, T. and Ejiri, M. (2001): Initial results of Syowa MF radar observations in Antarctica. *Adv. Polar Upper Atmos. Res.*, **15**, 103–116.
- Weitzen, J.A. and Ralston, W.T. (1988): Meteor Scatter: An Overview. *IEEE Trans. Antennas Propag.*, **36** (12), 1813–1819.
- Weitzen, J.A., Sowa, M.J., Scofidio, R.A. and Quinn, J. (1987): Characterizing the multipath and Doppler spreads of the high-latitude meteor burst communication channel. *IEEE Trans. Commun.*, **35**, 1050–1057.
- Weitzen, J.A., Cannon, P.S., Ostergaard, J.C. and Rasmussen, J.E. (1993): High-latitude seasonal variation of meteoric and nonmeteoric oblique propagation at a frequency of 45 MHz. *Radio Sci.*, **28**, 213–222.
- Yoshihiro, Y., Nagasawa, M., Mukumoto, K. and Fukuda, A. (2001): Measurements of the Antarctic meteor burst communication channel. *IEICE National Convention Record B-2-24* (in Japanese).