

Experiments on meteor burst communications in the Antarctic

Akira Fukuda¹, Kaiji Mukumoto¹, Yasuaki Yoshihiro¹, Masauji Nagasawa²,
Hisao Yamagishi³, Natsuo Sato³, Huigen Yang⁴, Ming Wu Yao⁵ and Li Jun Jin⁵

¹Shizuoka University, 3-5-1, Johoku, Hamamatsu 432-8561

²Numazu College of Technology, 3600, Ooka, Numazu 410-8501

³National Institute of Polar Research, Kaga 1-chome, Itabashi-ku, Tokyo 173-8515

⁴Polar Research Institute of China, 451 Jinqiao Road, Pudong, Shanghai 200129, China

⁵Xidian University, 2 Taibai Road, Xi'an, 710071, China

(Received December 20, 2002; Accepted March 25, 2003)

Abstract: Two kinds of experiments on the meteor burst communication (MBC) are now being conducted in the Antarctic to study the ability of MBC as a communication medium for data collection systems in that region. In the first one, continuous tone signal is transmitted from Zhongshan Station. The received signal at Syowa Station about 1400 km apart is recorded and analyzed. This experiment is to study basic properties of the meteor burst channel in that high latitude region. From the data available thus far, we can see that 1) the sinusoidal daily variation in the meteor activity typical in mid and low latitude regions can not be clearly seen, 2) non-meteoritic propagations frequently dominate the channel, etc. On the other hand, the second experiment is to estimate data throughput of a commercial MBC system in that region. A remote station at Zhongshan Station tries to transfer data packets each consists of 10 data words to the master station at Syowa Station. Data packets are generated with five min interval. We are now operating the system only five min in each ten min interval. About 60% of the generated data packets are constantly transferred to the master station within two hours delay.

key words: meteor burst communication, Antarctic, data collection, channel duty cycle, non-meteoritic propagation

1. Introduction

As the earth orbits the sun, a great number of tiny dust particles in the space are swept up each day. As the particles enter the earth's atmosphere, they collide with air molecules thereby ionizing in the form of long, thin paraboloids with the meteor particles at the head. These trails of free electrons and ionized particles reflect radio waves in low VHF band. A digital communication system that uses these trails (or, so called meteor bursts) is called Meteor Burst Communication (MBC) system or meteor scatter communication system. The trails occur at the altitude of 100–80 km and enable establishing communication links between two points within 2000 km apart. Communication systems using meteor bursts are highly reliable and have gained considerable attention with the advent of high-speed processors and cheap memories. MBC has proven to be an inexpensive alternative to satellite communication and HF

radio for low rate traffic applications. Interested readers should refer to (Fukuda, 1997; Schanker, 1990; Schilling, 1993) for the details of MBC.

Although billions of meteors enter the earth's atmosphere each day, only a small fraction has efficient mass and proper entry geometry to be useful for a point-to-point communication. Thus, the channel between two stations opens randomly with the average interval in the order of ten seconds. Furthermore, the few trails that are useful for communication diffuse rapidly and the channels typically last less than one second (the typical average is 0.3s). Thus the channel is characterized by long message waiting time and low throughput. However, it has superiority over other BLOS (Beyond Line Of Sight) channels (*e.g.* HF and satellite channels) in many aspects such as simplicity of implementation and operation, lower initial and running costs, and reliability.

MBC is very suitable for systems with many non-real time low average data rate remote terminals such as data acquisition and remote monitoring systems. This is because the primary drawback of MBC, that is, the low duty cycle (the ratio of the time the channel is open) of the intermittent channel between two stations is largely mitigated in such a configuration with one master station communicating with many remote stations. The oldest and still the most successful application of MBC under this category is the SNOTEL system spanning 11 western states of the U.S. It periodically gathers snowpack and other meteorological data from over 600 terminals spread in the valleys of Rocky Mountains. Refer to (Johnson, 1987) for the history and outline of SNOTEL.

Today, there exist some very successful MBC data collection systems operating every day in some regions in the world. However, most of them are deployed in medium latitude regions. It seems very strange for the authors that there has been no attempt to apply MBC to the Antarctic survey, thus far. Some experiments to study properties of high latitude MBC channels were conducted in Greenland and Alaska (Weitzen *et al.*, 1987, 1993; Weitzen, 1989; Cannon *et al.*, 1994, 1996). Some interesting results on the influence of aurora and sporadic *E* propagations on the MBC channel at these Arctic regions are reported in the papers. However, there are no observations of MBC channels in the Antarctic region thus far. Moreover, no attempt to practically construct and operate MBC data acquisition systems in such high latitude regions has been made.

The authors have been conducting many experiments on MBC in Japan and China. We have obtained enough data on the statistical properties of the channel at that region and used them for the development of data collection systems such as the Japanese RANDOM (RADio Network for Data Over Meteor) system.

In December 2001, we started a project to study the ability of MBC as a communication medium for data collection systems in the Antarctic. Two kinds of experiments are now being conducted there. They are called "the tone experiment" and "the data experiment". In the former one, a tone signal is continuously transmitted three min in each ten min period from Zhongshan Station. The received signal at Syowa Station about 1400km apart is recorded and analyzed. This experiment is to study the basic properties of meteor burst channels as a data communication medium in that high latitude region. The latter one is to estimate the data throughput of a

commercial MBC system in that region. A remote station at Zhongshan Station tries to transfer data packets to the master station at Syowa Station. Data packets are periodically generated with five min interval.

By jointly studying results from these two experiments, we hope we can evaluate ability of general MBC systems operating in the Antarctic region. Outline of the experiments, some preliminary results, and future plans for the project are shown in this paper.

2. Stations and equipment

Our equipment is deployed in Syowa Station (Japan) and Zhongshan Station (China). The locations are

Syowa: $69^{\circ}00'22''\text{S}$ $39^{\circ}35'24''\text{E}$

Zhongshan: $69^{\circ}22'24''\text{S}$ $76^{\circ}22'40''\text{E}$

Figure 1 shows photos of the antennas at Syowa Station (a) and Zhongshan Station (b). All the antennas are horizontally polarized Yagi's with five elements. In Syowa Station, we have three antennas: one for the master station of the data experiment (on a tower 8 m in length) and two for the two receivers of the tone experiment (on towers 8 m and 4 m in length). On the other hand, there are two antennas in Zhongshan Station: one for the remote station of the data experiment (tower length is 8 m) and another one for the tone transmitter (tower length is 5.5 m).

In Fig. 2, the tone transmitter (a) and the remote station (b) both at Zhongshan



(a) Syowa Station

(b) Zhongshan Station

Fig. 1. Antennas for the MBC experiments.

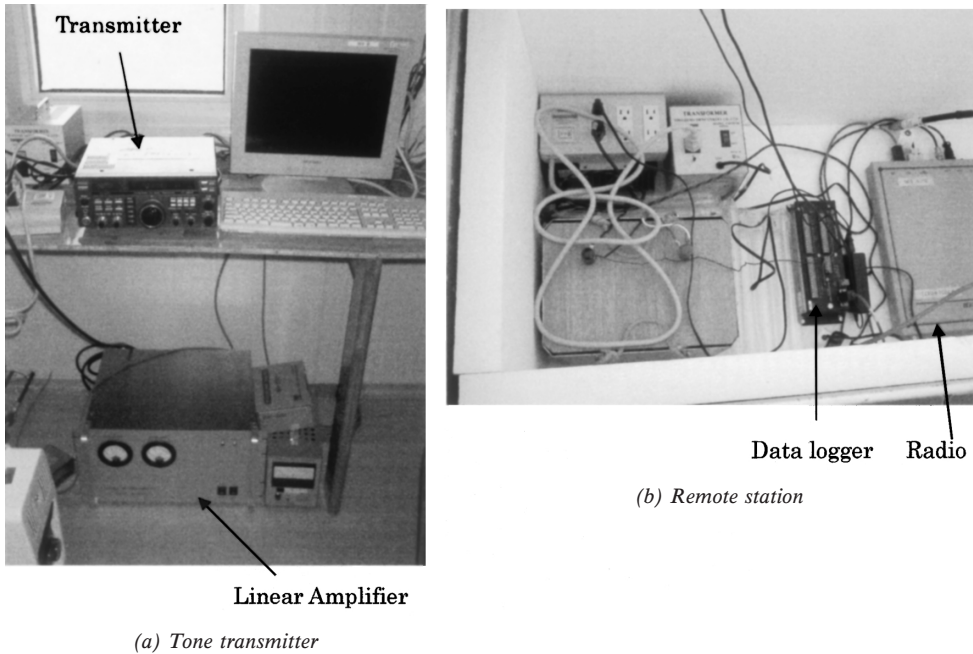

Fig. 2. Tone transmitter and remote station at Zhongshan Station.

Station are shown.

3. Tone experiment

3.1. The experiment

The configuration of the tone experiment is shown in Fig. 3. The transmitter at

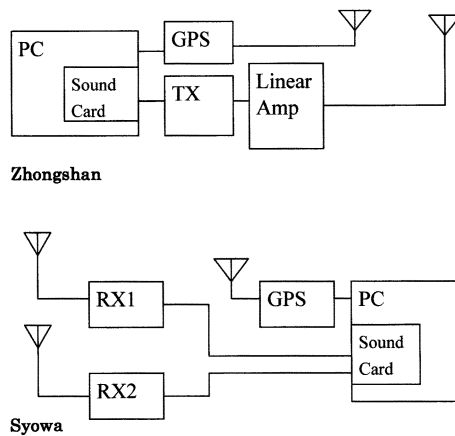

Fig. 3. Equipment for the tone experiment at Zhongshan transmitting site and Syowa receiving site.

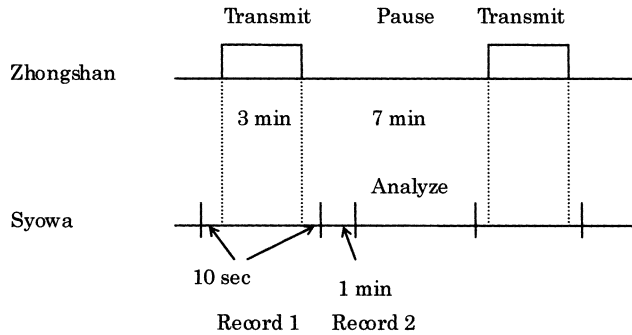

Fig. 4. Timing diagram for transmitting, receiving, and recording of the tone signal.

Zhongshan Station modulates a 46 MHz carrier wave with an 1250 Hz tone signal using upper single sideband modulation. It then transmits the signal with 115 W transmitter power. Though the maximum output power of the transmitter is 300 W, we restricted the power to the lower level to minimize the interference with other experiments being conducted in the station. The GPS receivers at the stations are used to synchronize the transmitter and receiver. It always keeps the time difference at the two stations within 10 s.

As is shown in Fig. 4, the transmitter transmits the tone signal 3 min and then rests the following 7 min and so on. This 7 min pause is used to measure the noise level at the receiver entrance as well as to process the received signal during the preceding 3 min. Moreover, because of this period we can avoid the interference with the data experiment and also we can prevent the transmitter temperature rising too high. A personal computer at Syowa Station records the received wave shapes from the two receivers following the time schedule shown in the same figure. The recording period #1 with length 3 min and 20 s is for the possible reflected signals from the transmitter via meteor bursts. The 10 s before and after the 3 min in the period are to guard against the possible time mismatch between the transmitter and receivers. The signal is analyzed during the following analysis period with length 5 min and 40 s. The recording period #2 with 1 min length is to measure the noise level at that time. We have two antenna-receiver pairs for the sake of reliability of the experiment and also to study the influence of the height of the antennas.

3.2. The signal processing

The received wave is digitized with 8 kHz sampling and 16 bits quantization. The digitized wave shape is band pass filtered with pass band from 1150 Hz to 1350 Hz. Then the mean squared value for each interval with length 8 ms is obtained. The average noise power calculated using the 1 min noise record is subtracted from the value. We call the value thus obtained “signal power”. The 25000 signal power values for the 3 min and 20 s period is stored in the computer.

Figure 5 shows an example of a 40 s period of the stored signal power of the two receivers. One reflection from an over dense burst and five reflections from under dense bursts can be recognized in the figure. We can see that the difference between the

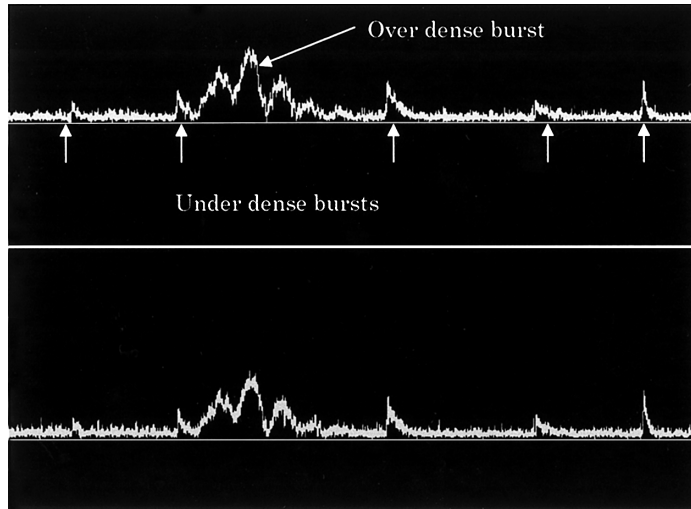

Fig. 5. Received signal power from the two receivers (40s).
Above: Tower=8 m, Below: Tower=4 m.

two waveforms for the signal power from the two antenna-receiver systems is not large. Thus, in the following of this preliminary paper, we will refer only to the statistics of the signal power from the taller antenna.

Each signal power level is compared with the threshold values corresponding to 3 to 10 dB above a predefined level. This level is fixed throughout the experiment at the average noise level with bandwidth 2.4 kHz measured over a long period at Syowa station beforehand. Thus the presence or absence of reflected signal power above each threshold is determined for each 8 millisecond section. A section with signal power is treated as a section without signal power if both the neighboring sections are judged to be without signal power (throw away). After that a section without signal power is considered to have signal power if both neighbors have signal power (fill in). We memorize the time of occurrence of a burst and its duration when more than 4 successive sections are judged to contain signal power. The received wave shape itself is also memorized if a burst is recognized for the lowest 3 dB threshold.

The computer program to perform the above procedure was verified using a meteor burst channel simulator developed by the authors. It was also tested over some real meteor burst communication links in Japan (Yoshihiro *et al.*, 2001).

3.3. Some preliminary results

We have already obtained considerable amount of data but most of them are still in the computer and compact disks in Syowa Station. The data will be analyzed in detail after they are sent back to Japan next March. Here we only briefly discuss the data already sent back to Japan by e-mail.

Figure 6 shows the hourly variation of the number of bursts within 18 min averaged over the 30 days in April. We can not see the daily sinusoidal variation of the burst rate

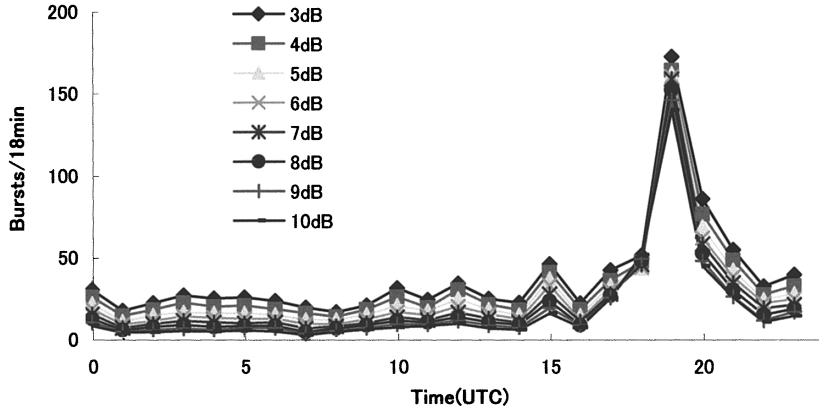

Fig. 6. Average number of bursts vs. time of day (Averaged over April 1st–30th, 2002).

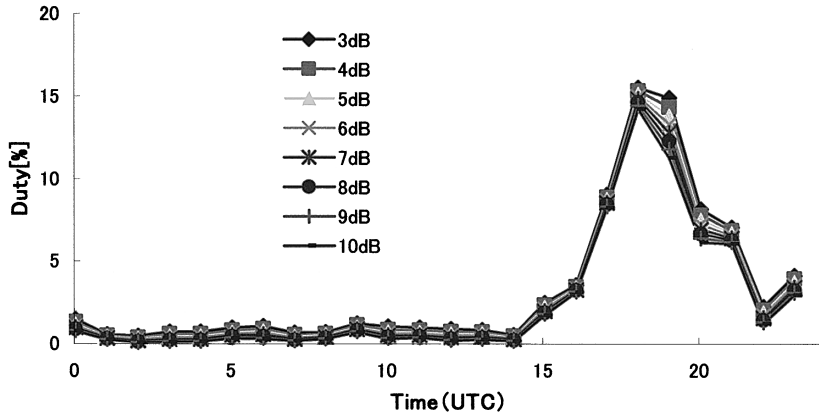

Fig. 7. Average duty cycle vs. time of day (Averaged over April 1st–30th, 2002).

typical in medium latitude regions. This fact may be explained from the inclination of the axis. However, we have to postpone discussing on the point in detail until we get data also for other seasons.

Also we have to study why there is a peak near 19 h UTC in the figure. Figure 7 is the corresponding variation of the duty cycle of the channel, that is, the ratio of the time the channel is open to the total observed time. Usually duty cycle of meteor burst communication channels with transmitter power around 100 W is as small as 1%. Thus, again the reason for the large duty cycle after 15 h UTC should be explained.

It is well known that duration statistics (average and distribution) of meteor burst channels do not change with the transmitter power and/or detection threshold (Fukuda and Mukumoto, 1995). Here, duration of a channel is defined as the time interval between the received power becomes larger than a pre-defined level and it becomes smaller than the level again. We also know that the duration statistics do not exhibit a recognizable hourly variation. Thus, from Fig. 8, which shows the variation in the

average duration of the channel, we can conclude that the large number of bursts and the corresponding large duty cycle after about 15 h UTC is the effect of some non-meteoric propagation mechanism. This point is also confirmed from Fig. 9 which compares the distribution of duration of bursts during 9 h to 10 h UTC when non-meteoric propagation was rare and during 21 h to 22 h UTC when non-meteoric propagation appeared frequently during the period of April 1st and September 30th. It is also well known that duration of meteor burst channels is exponentially distributed. We can see that the data during 9 h to 10 h shows clear exponential distribution but the data during 21 h to 22 h does not (note that the ordinate is in logarithmic scale).

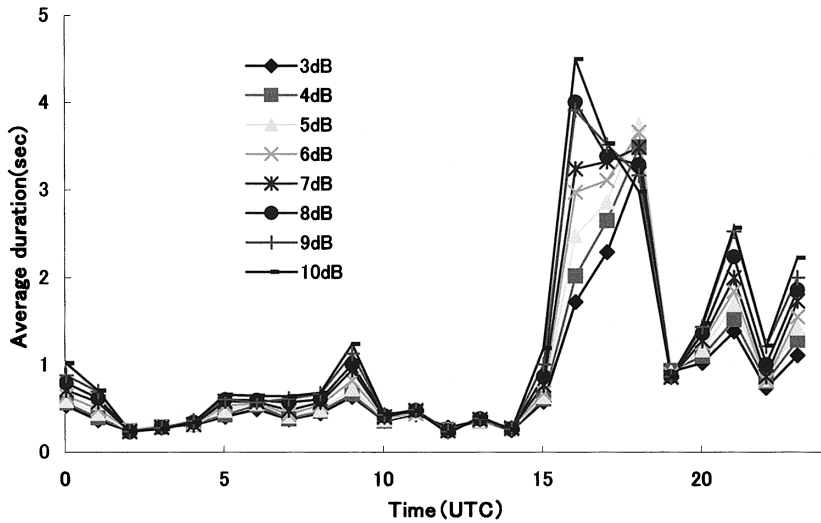

Fig. 8. Average duration of bursts vs. time of day (Averaged over April 1st–30th, 2002).

Distribution of duration (5dB)

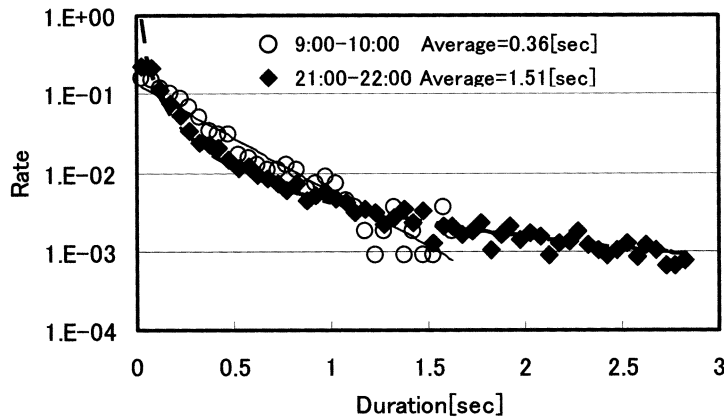

Fig. 9. Comparison of the distribution (relative frequency) of duration of the channel between meteoric (9 h to 10 h) and non-meteoric (21 h to 22 h) hours (April 1st–September 30th, 2002).

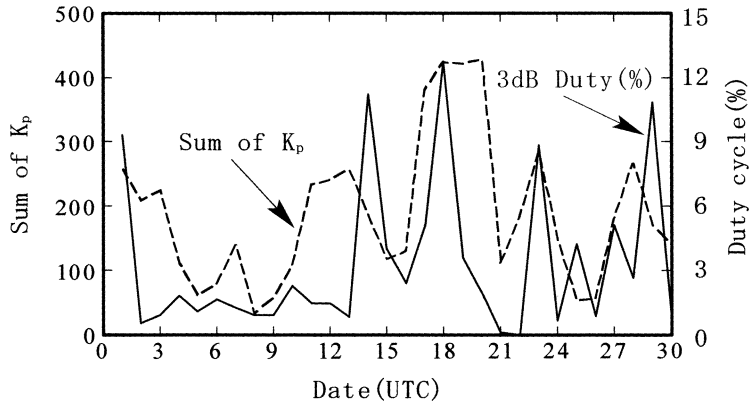

Fig. 10. Daily sum of K_p values and daily average of duty cycle (April 1st–30th, 2002).

We suppose that this non-meteoritic propagation was related with auroral activities, *i.e.*, formation of auroral sporadic E -layer along the propagation path as suggested by (Cannon *et al.*, 1996) for the data obtained at Greenland. Figure 10 shows a comparison between the variations of daily averaged duty cycle and daily sum of K_p indices for April 2002. The most part of the former was contributed from the non-meteoritic propagations. A clear correlation between the two strongly supports our speculation that the non-meteoritic propagation could be caused by auroral activities. However, daily variations of duty cycle and K_p index show poor correlation in many cases. This discrepancy can be explained in the following. K_p index is determined by geomagnetic variations of sub-auroral zone stations in the geomagnetic latitudes less than 62 degree. On the other hand, non-meteoritic propagation between Syowa and Zhongshan Stations became possible in the local time when the auroral oval was located in between the two stations, which corresponds to geomagnetic latitudes above 70 degree. Therefore, auroral activities represented by K_p indices well correlated with duty cycles in general, but not correlated in daily variation, reflecting the difference of geomagnetic latitudes of the two.

In Fig. 10 we can see that the duty cycle suddenly increased dramatically after April 14th. As we can see later in Fig. 16, the number of data packets correctly received is not increased in those days. Thus we also suspect from this fact that most contribution for the large duty cycle of this period is from some propagation mechanism which is not of much help for the data transmission because of some harmful features such as large Doppler shift. Weitzen and others said that aurora propagation is featured by large Doppler shift and severe multi-path phenomena (Weitzen *et al.*, 1987; Weitzen, 1989). By the way, the extremely low duty cycle of 21st and 22nd is because of power supply problems at Zhongshan Station.

Figures 11 and 12 show hourly average duty cycle for April 11th (on that day, daily average duty cycle is normal) and 29th (daily average duty cycle is large). Pay attention to the difference of ordinate scales in the two figures. We confirmed that the large duty cycle from around 17h to around 22h UTC seen in Fig. 12 is more or less common to those days with large daily duty cycle in Fig. 10.

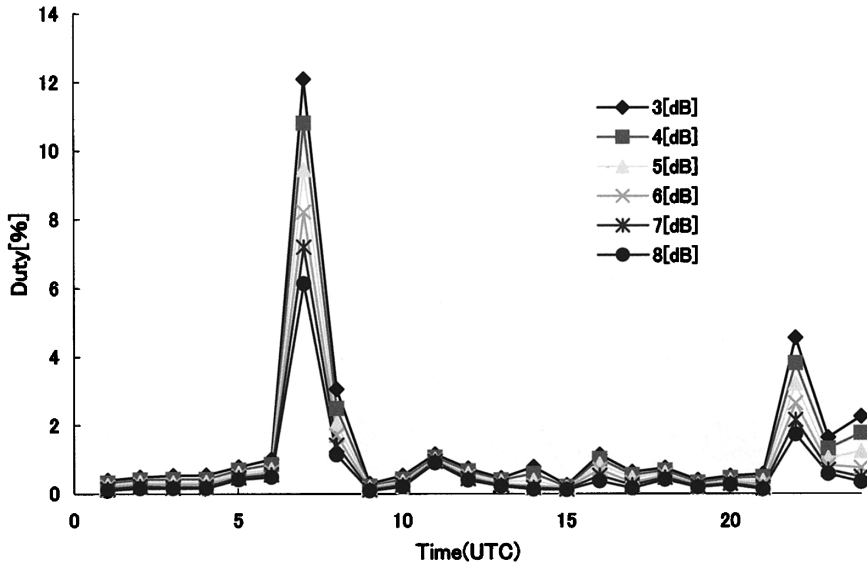

Fig. 11. Duty cycle vs. time of day for a day with normal average daily duty cycle (April 11th, 2002).

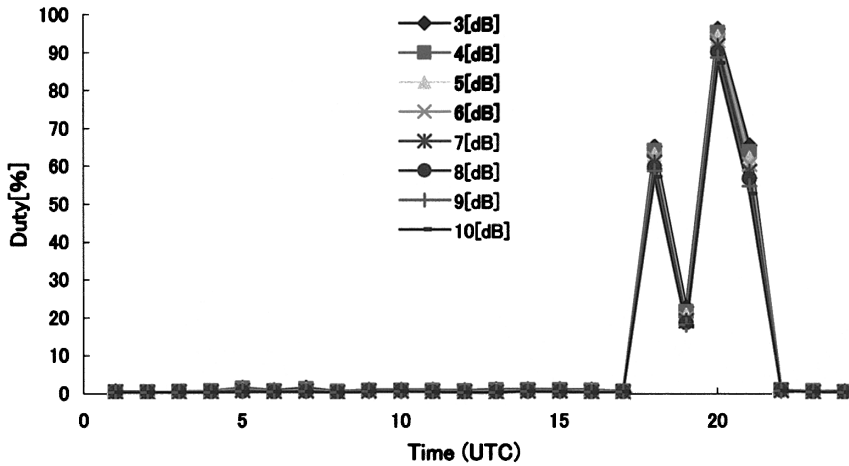

Fig. 12. Duty cycle vs. time of day for a day with large average daily duty cycle (April 29th, 2002).

The statistics of meteor rate and duty cycle during the period from May to September were similar to that of April which we mainly discussed here.

4. Data experiment

4.1. The experiment

In Fig. 13, the system for the data experiment is shown. The remote station at Zhongshan Station generates data packets with the interval of 5 min. Thus, 288 data

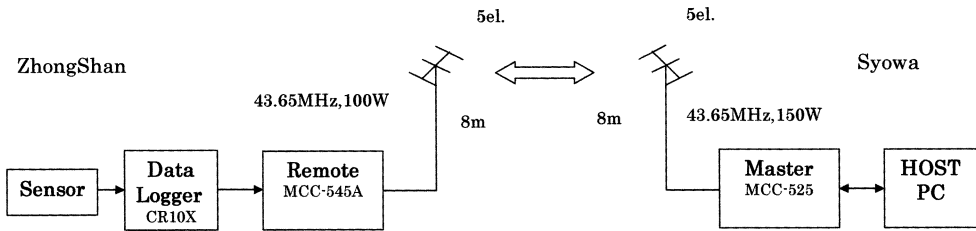

Fig. 13. Equipment for the data experiment.

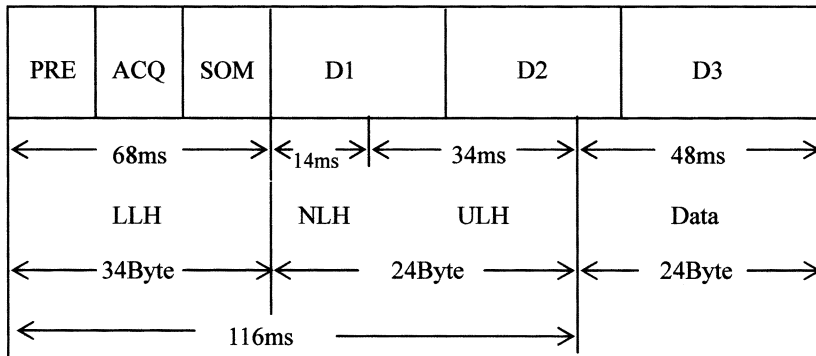

Fig. 14. Structure of the data packets used at the experiment.

packets are generated each day. The system tries to transfer the data packets to the master station at Syowa Station. However, the master station transmits probe packets only 5 min in each 10 min interval. This is to avoid the interference with the tone experiment. A data packet is deleted if it can not be transferred to the master station within 2 hours. The equipment is manufactured by the Meteor Communications Co. (MCC) of Washington, USA. It uses BPSK modulation with 4000 bps signaling speed. The transmitter power of the remote and master stations is 100 W and 150 W, respectively. The frequency used for this experiment is 43.65 MHz.

The structure of the data packet is shown in Fig. 14. The header part with the length of 116 ms occupies 71% of the packet length (164 ms). This large overhead may be because the communication protocol of the MCC system is designed for rather general use. Each data packet has a data part of length 40 ms which consists of 10 data words each 2 bytes length. The content is as follows.

- #1: Year
- #2: Julian Day
- #3: Time(UTC)—Hour, Minute
- #4: Second
- #5: Calculated dummy data
- #6: Inner temperature (Data logger CR10X)
- #7: Outer temperature

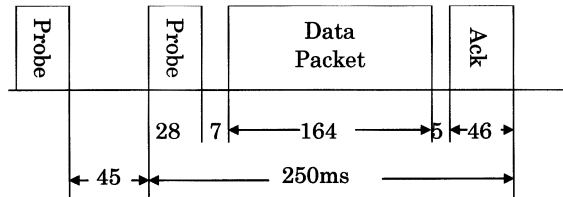

Fig. 15. The communication procedure and timing for a data packet transmission.

- #8: Air pressure
- #9: Wind speed
- #10: Wind direction

Here, we don't describe the details of the transmission protocol. We only show the process of data packet transmission, length of the packets, and the intervals between signal transmissions in Fig. 15.

4.2. Some preliminary results

We show in Fig. 16 the number of received data packets in each day during April '02. The average duty cycle from Fig. 10 is also shown in the figure to see the relation between the duty cycle and the number of data packets transferred successfully. We can conclude from this figure that the large duty cycle after April 14th does not contribute to the number of data packet transmitted each day. All in all, about 55% of the packets generated are transferred successfully during this period. We can expect that nearly 100% of the data will be transferred if we operate the system without 5 min's pause in the probe transmission and with longer life time of the data packets.

Figure 17 is the variation of the total number of received packets per hour averaged over a month from April to July. According to the month, 360 or 372 packets were generated each hour. Thus, all in all, about 59% of the data were transferred successfully through this period. The throughput of data (total data bits transferred

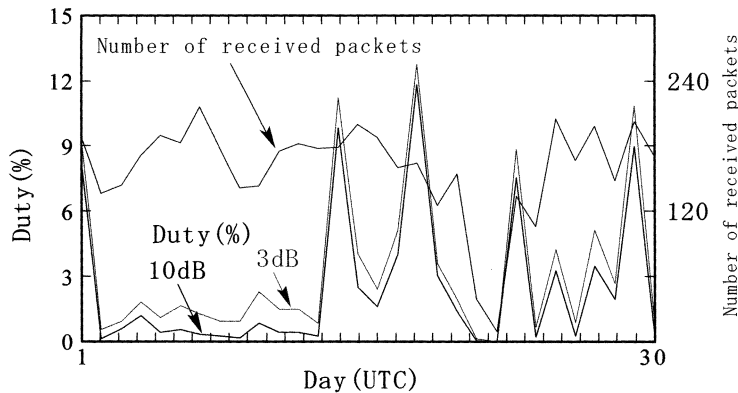

Fig. 16. Duty cycle and the number of data packets received per day (April 1st–30th, 2002).

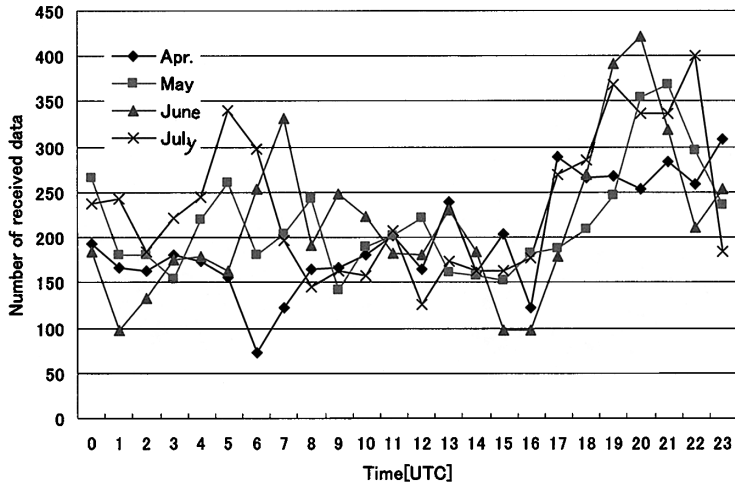

Fig. 17. Variation in the number of received data packets per month vs. time of day (April–July, 2002).

divided by the total operated seconds) in this period is 0.63 bits/s. We can see that more packets were transferred during the period between 17 h and 23 h compared to other periods. This corresponds to the larger duty cycle during that time interval. We can conclude from this figure that some non-meteoric propagation can be utilized for data transmission. It looks like the conclusions which we derived from Figs. 16 and 17 contradict each other. We need to study in detail properties of the received tone wave shapes which sustain the large duty cycle to find the reason of the contradiction. It should be taken into account that the number of received packets is not necessary in proportion to the duty cycle even if the quality of the signals in that period is good because the queue of the packets waiting for the transmission will be frequently empty during the period with very large duty cycle. Curves for August and September are missing in Fig. 17 since the system was run in another mode on some days in that period.

In Fig. 18, using the received data packets, we drew graphs showing the variation of the temperature and pressure during the period between April 1st and September 30th. Even though the ratio of the received data packets through this period is about 56%, it produces meaningful curves. This is because the 5 min sampling interval is short enough for the variation of these variables.

4.3. Exploitation of the non-meteoric propagation for data transmission

From the results of our experiment, we can expect that we can send much more data packets during the period between about 17 h and 22 h UTC using the non-meteoric propagation if we have enough packets in the transmitting queue. In that case, it will be better to install a hybrid meteor mode and non-meteor mode protocol. We may even send some small still pictures. Based on the data at Arctic region, Weitzen, Cannon, and others also proposed to design systems with a hybrid protocol (Weitzen *et al.*, 1993; Cannon *et al.*, 1996).

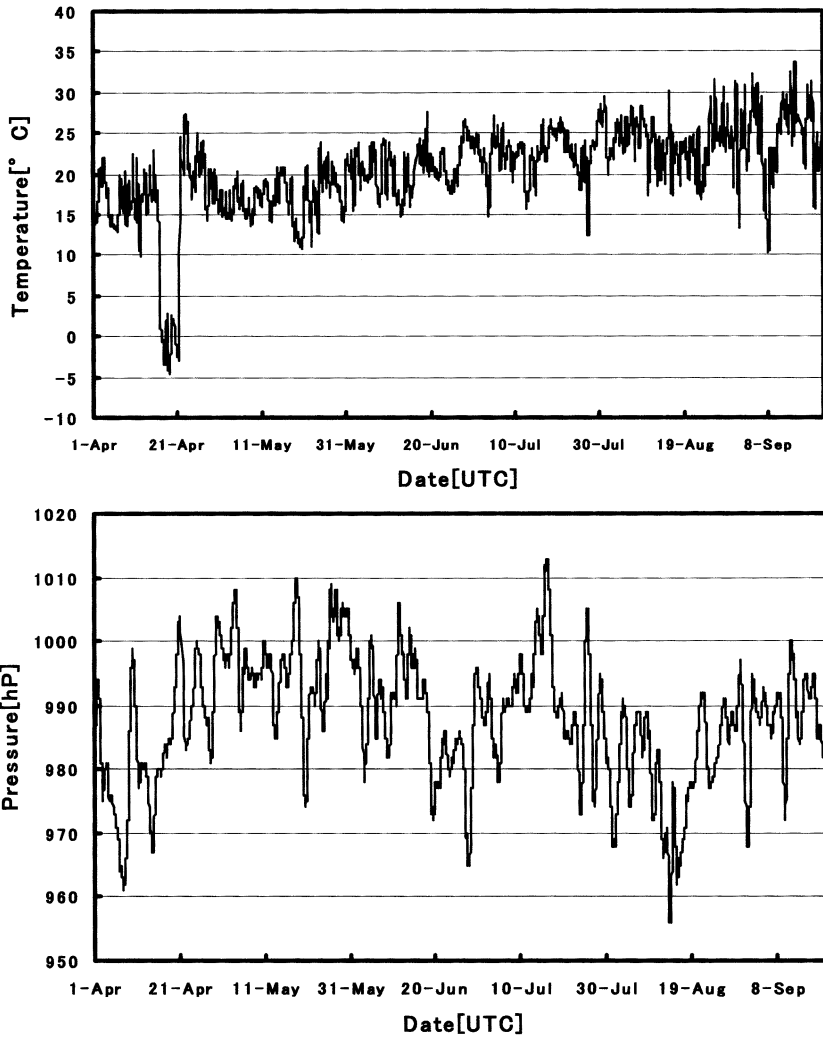

Fig. 18. Examples of the received data (above: temperature, below: pressure).

When the system is one-to-one, the only problem is how to avoid the transmitter at the sending station to become too hot as a result of nearly continuous transmission. The small size and simplicity of usual MBC equipment, especially those of remote stations, come from the small duty cycle of the transmitter. When the system is of the configuration with one master station and many remote stations, however, we also have to take into account the problem of collisions of data packets from some remote stations.

Other problems in such systems which utilize non-meteoritic propagations are the reductions in the security and the frequency re-use ability inherent in MBC. These are because the ground illumination footprint from meteor burst is very small whereas it is much larger in other non-meteoritic propagation modes.

5. Japanese 44th and 45th expeditions experiments

5.1. Experiment during the Japanese 44th expedition

A wintering party was sent to Dome Fuji Station for the 44th expedition which begins December 2002. This is a good opportunity for us to study the ability of the MBC system to collect data from many remote stations. We will add another remote station at Dome Fuji Station and try to collect data packets from the two remote stations simultaneously. Figure 19 is the intended configuration of the experimental system. The remote station at Dome Fuji Station is quite similar to the one at Zhongshan Station except for the antenna height. We are expecting to get some experimental data on the probability of packet collisions from the two remote stations. This is helpful to estimate the data collection ability of the future MBC system with many remote stations spread all over that region of the Antarctic.

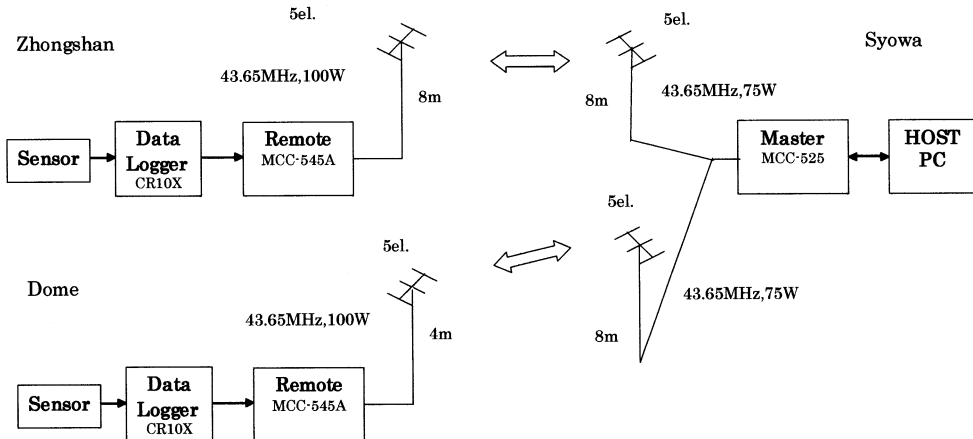

Fig. 19. Experiment during the Japanese 44th expedition.

5.2. Experiment during Japanese 45th expedition

In the experiment during the 45th expedition which begins December 2003, we are planning to replace the MCC system for the data experiment with the RANDOM system designed and developed by us. As is explained in detail in Fukuda and Mukumoto (1993), Mahmud *et al.* (2000, 2001), it is based on software modems. The new system has been proven through many experiments in Japan to have high efficiency and flexibility. The protocol is specifically designed for the purpose of the system and the packets have much shorter headers than those of the MCC system. Moreover, the software modem needs only very short bit synchronization symbols. All in all, the overhead of a packet with 20 bytes data is only about 20%. Thus, we have good reasons to expect a throughput more than 3.4 bits/s in that system because we can expect more than twice shorter interval between successful packet receptions in RANDOM system compared to that of MCC system from our preliminary tests in Japan.

Using software modem, we can easily modify type of modulation, transmission

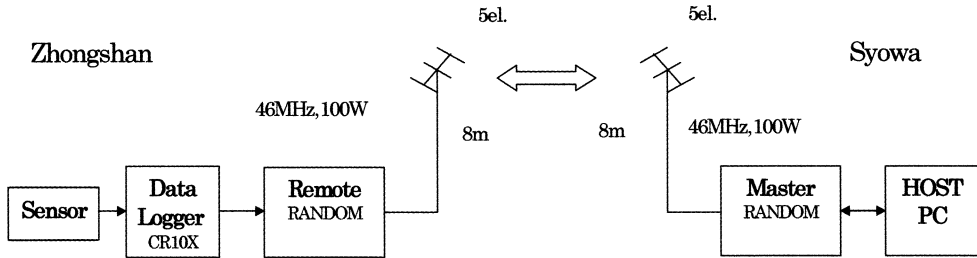

Fig. 20. Experiment during the Japanese 45th expedition.

speed, coding, etc according to the results of experiments. The experiment will be done between Syowa master station and Zhongshan remote station as is shown in Fig. 20. We can not test a system with two remote stations because no wintering party is expected to be sent to Dome Fuji Station that year.

6. Conclusions

The configuration, present situation, preliminary results, and the future plan of our MBC experiments in the Antarctic were briefly surveyed. Both of the two kinds of experiments now being conducted in the region are going well and many interesting data on the properties of the channel and on the performance of the data collection system are accumulated everyday.

Some interesting propagation phenomena not common in the medium latitude links were found. These are 1) the sinusoidal daily variation in the meteor activity typical in mid and low latitude regions is not recognized in that region, 2) non-meteoric propagations which will be related to aurora activity and the resulting sporadic *E* layers frequently dominate the channel. We will start analyzing the data in detail next April after we get all the data of this year's experiment.

The data collection system is collecting data packets rather constantly. About 60% of the generated data packets (one packet per 5 min) each having 10 data wards are transferred to the master station within two hours delay even though we are operating the master station only 5 min in each 10 min interval.

The analysis and study we are planning to conduct next year are on 1) separation of meteoric and non-meteoric propagations, 2) stochastic properties of the two categories of propagations, 3) detailed study of the non-meteorically propagated wave forms, 4) the contribution of each kind of propagation mechanism to the data throughput, 5) final design of the RANDOM system including the decision of the values of protocol related and transmitter and receiver related parameters for the experiment in the Antarctic.

Acknowledgments

This research is supported by the Grant-in-Aid for Scientific Research (C2 14550353) from Japan Society for the Promotion of Science. The installation and

operation of the meteor burst communication system at Zhongshan and Syowa Stations were supported by the 18th Chinese Antarctic Research Expedition and the 43rd Japanese Antarctic Research Expedition, respectively. The authors are indebted to the referees for their valuable suggestions.

The editor thanks Drs. A.P. Wanberg and R.R. Clark for their help in evaluating this paper.

References

- Cannon, P.S., Weitzen, J.A., Ostergaard, J. and Rasmussen, J.E. (1994): Meteor burst and other long distance high latitude propagation modes in the low VHF band. *Proc. IEE HF Radio Systems and Techniques*, 353–357.
- Cannon, P.S., Weitzen, J.A., Ostergaard, J. and Rasmussen, J.E. (1996): Relative impact of meteor scatter and other long-distance high-latitude propagation modes on VHF communication systems. *Radio Sci.*, **31**, 1129–1140.
- Fukuda, A. (1997): *Meteor Burst Communications*. Tokyo, Corona Publ. (in Japanese).
- Fukuda, A. and Mukumoto, K. (1993): Performance evaluation of RANDOM—A simplex meteor burst communication system. *Proc. MICC*, B4.1.1–4.1.8.
- Fukuda, A. and Mukumoto, K. (1995): Studies on the properties of meteor burst communication channels. Technical Report of IEICE, SANE95–93.
- Johnson, D.E. (1987): Ten years experience with the SNOTEL meteor burst data acquisition system. *Proc. Meteor Burst Commun. Symp.*, The Hague, SII-5–SII-20.
- Mahmud, K., Mukumoto, K. and Fukuda, A. (2000): Development of MBC system using software modem. *IEICE Trans. Commun.*, **E83-B**, 1269–1281.
- Mahmud, K., Mukumoto, K. and Fukuda, A. (2001): A bandwidth efficient variable rate transmission scheme for meteor burst communications. *IEICE Trans. Commun.*, **E84-B**, 2956–2966.
- Schanker, J.Z. (1990): *Meteor Burst Communications*. Boston, Artech House Inc.
- Schilling, D.L. (1993): *Meteor Burst Communications—Theory and Practice*. New York, John Wiley.
- Weitzen, J.A. (1989): Communicating via meteor scatter at high latitudes. Final report. Rome Air Development Center, RADC-TR-89-172.
- Weitzen, J.A., Sowa, M.J., Scofidio, R.A. and Quinn, J. (1987): Characterizing the multipath and Doppler spreads of the high-latitude meteor burst communication channel. *IEEE Trans. Commun.*, **35**, 1050–1057.
- Weitzen, J.A., Cannon, P.S., Ostergaard, J.C. and Rasmussen, J.E. (1993): High-latitude seasonal variation of meteoric and nonmeteoric oblique propagation at a frequency of 45 MHz. *Radio Sci.*, **28**, 213–222.
- Yoshihiro, Y., Nagasawa, M., Mukumoto, K. and Fukuda, A. (2001): Measurements of the Antarctic meteor burst communication channel. *IEICE National Convention Record B-2-24* (in Japanese).