

IV. Stratigraphic Observation of the Surface Snow Cover in Mizuho Plateau, East Antarctica, 1969 - 1970

Renji NARUSE*

Stratigraphic observations were made on the snow cover in Mizuho Plateau during the oversnow traverse of JARE 10 in 1969 - 1970.

Observed were 1 m deep snow cores at 64 stations, 2 m deep snow cores at 4 stations, a 5 m deep snow core at 1 station, 10 m deep snow cores at 3 stations, and 1 m deep pits at 6 stations. At these 78 stations the stratigraphic observation was made of the snow cover (positions of wind crust layers, grain shapes and grain sizes). Moreover, vertical distribution of the snow density (g/cm^3) and Kinosita's hardness of snow (kg/cm^2) were measured also at some of these stations. The snow cores were obtained by means of a hand auger. The station numbers, dates of observation, depths of snow cores or pits, items observed, and names of observers are shown in Table IV-1. Renji Naruse and Yutaka Ageta (Nagoya University) were engaged in the observations.

The results of observations are illustrated in Fig. IV-2 to Fig. IV-15. The legends for these figures are given in Fig. IV-1. The depth of a snow core or a pit is measured from the surface downward. The position of a wind crust layer is indicated by a solid line; such a wind crust layer that is indefinable because of the lack of noticeable features in structure or a distinct boundary on the both side of which differences are found in grain shape and grain size is indicated by a broken line. The following graphic symbols of grain shapes are adopted:

- (++) New snow preserving the original shapes of snow crystals.
- (○○) Fine-grained compact snow metamorphosed from new snow without melting.
- (□□) Medium-grained depth hoar, not well-developed.
- (^^) Coarse-grained, well-developed depth hoar.

Grain sizes, a, b, c, d and e are defined as follows:

$a < 0.5 \text{ mm}$, $0.5 \leq b < 1.0 \text{ mm}$, $1.0 \leq c < 2.0 \text{ mm}$, $2.0 \leq d < 4.0 \text{ mm}$, and $e \geq 4.0 \text{ mm}$. The letter G in figures denotes the density (g/cm^3) and R denotes the hardness (kg/cm^2) measured by Kinosita's hardness gauge.

* The Institute of Low Temperature Science, Hokkaido University, Sapporo.

Table IV-1. Stratigraphical observations of the firn cores or pits.

Station	Date of observation	Depth of firn core or pit	Item observed			Observer*
			Stratigraphy	Density	Hardness	
S 20	Nov. 1, 1969	2 m		0		N
30	" 2 "	1	0	0		N
35	" 2 "	1	0	0		N
40	" 3 "	10		0		N, A
45	" 6 "	1	0	0		N
50	" 6 "	1 , pit	0			N, A
55	" 7 "	1	0	0		N
60	" 7 "	1	0	0		N
65	" 7 "	1	0	0		N
70	" 7 "	2	0	0		N
75	" 8 "	1	0	0	0	N
80	" 8 "	1 , pit	0	0	0	N, A
85	" 9 "	1	0	0		N
90	" 9 "	1	0	0		N
95	" 9 "	1	0	0		N
105	" 11 "	1	0			N
110	" 11 "	1	0	0		N
115	" 11 "	1	0			N
120	" 11 "	1	0	0		N
125	" 12 "	1	0			N
130	" 12 "	1	0	0		N
135	" 12 "	1	0			N
140	" 12 "	1	0	0		N
145	" 13 "	1	0			N
150	" 13 "	1	0			N
155	" 14 "	1	0			N
160	" 14 "	5		0		N, A
160	" 14 "	1 , pit	0			N, A
165	" 15 "	1	0			N
175	" 16 "	1	0			N
183	" 16 "	1	0			N
185	" 16 "	1	0			N
186	" 16 "	1 , pit	0	0	0	N, A
190	" 17 "	1	0			N
196	" 17 "	1	0			N

Station	Date of observation	Depth of firn core or pit	Item observed			Observer*
			Stratigraphy	Density	Hardness	
S205	Nov.19, 1969	1 m	0			N
210	" 19 "	1	0			N
215	" 19 "	1	0			N
220	" 20 "	1	0			N
225	" 20 "	1	0			N
230	" 20 "	1	0			N
233	" 20 "	1	0	0		N
235	" 21 "	1	0			N
240	" 23 "	1 , pit	0	0		N,A
A155	" 25 "	1	0			A
144	" 28 "	1	0			A
130	" 30 "	1	0			A
118	Dec. 1 "	1	0			A
104	" 3 "	1	0			A
092	" 6 "	1	0			A
080	" 10 "	1	0			A
075	" 11 "	1	0			N
075	" 12 "	10	0	0	0	N,A
068	" 13 "	1	0			A
057	" 15 "	1	0			N
056	" 15 "	1	0			A
044	" 16 "	1	0			A
028	" 18 "	1	0			A
015	" 21 "	1	0			A
C 45	Jan. 17, 1970	1	0		0	N
50	" 17 "	1	0		0	N
55	" 17 "	1	0		0	N
60	" 17 "	1	0	0	0	N
65	" 18 "	1	0		0	N
70	" 18 "	2	0			N
75	" 18 "	1	0		0	N
80	" 19 "	10	0	0		N,A
80	" 19 "	1 , pit	0	0	0	N,A
85	" 20 "	1	0		0	N
90	" 20 "	1	0			N
100	" 21 "	2	0			N
105	" 21 "	1	0			N

Station	Date of observation	Depth of firn core or pit	Item observed			Observer*
			Stratigraphy	Density	Hardness	
C110	Jan. 21, 1970	1 m	0		0	N
115	" 21 "	1	0			N
120	" 21 "	1	0			N
125	" 22 "	1	0			N
130	" 22 "	1	0			N
135	" 22 "	1	0			N

* Observer : N ---- Naruse; A ---- Ageta.

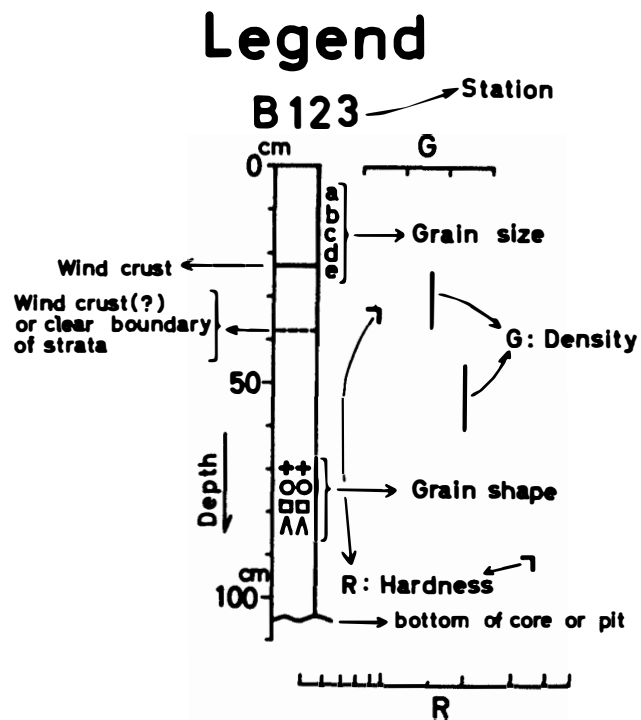

Fig. IV-1. Legend for Figs. IV-2 ~ IV-14.

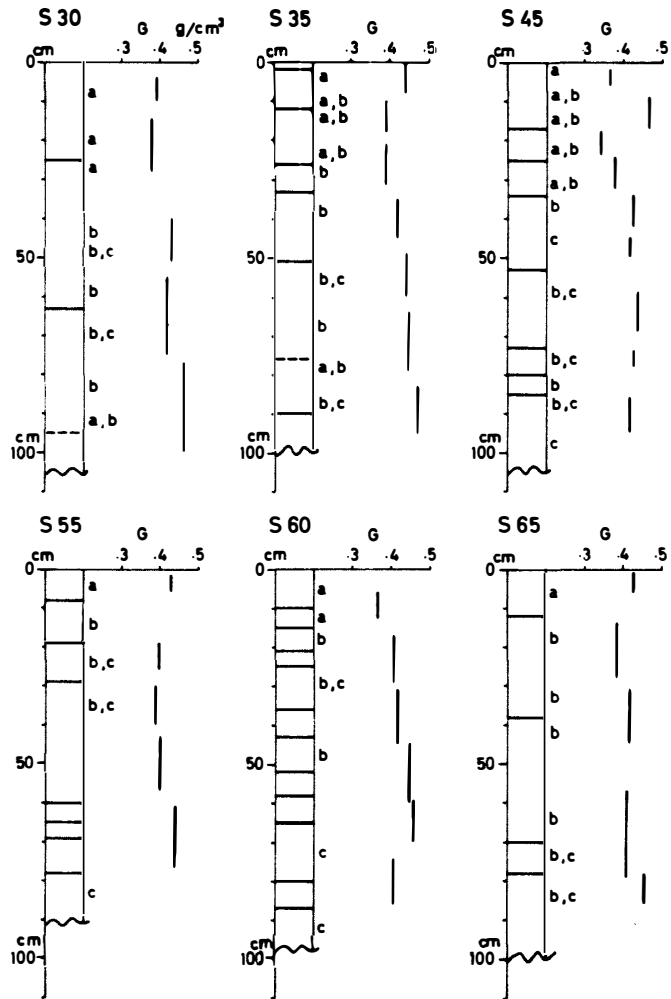

Fig. IV-2. Stratigraphy and density distribution of snow cover at stations S30, S35, S45, S55, S60 and S65.

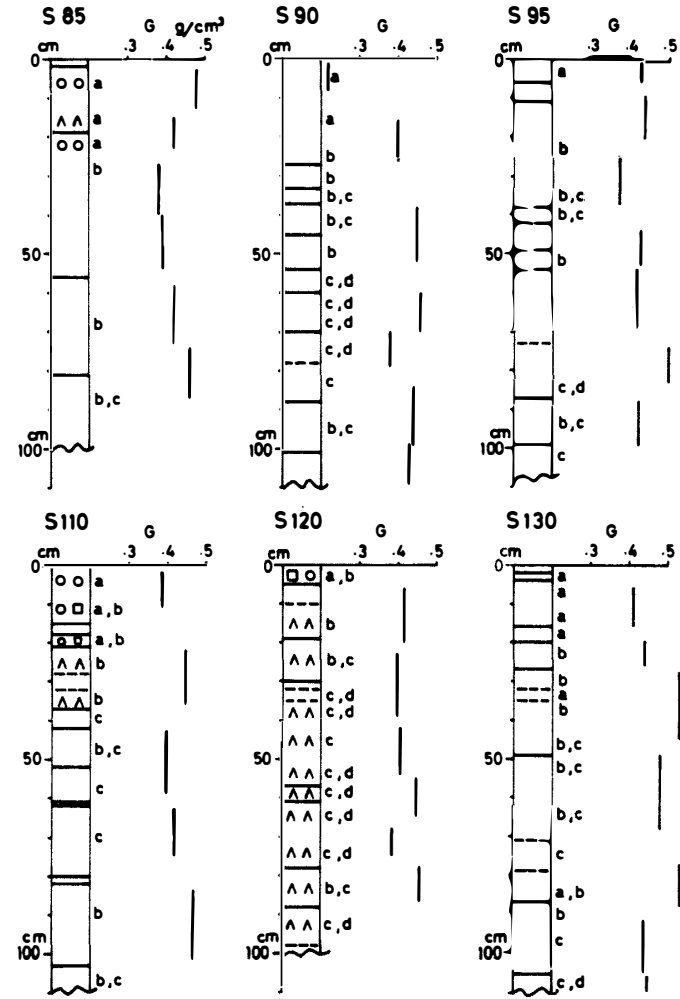

Fig. IV-3. Stratigraphy and density distribution of snow cover at stations S85, S90, S95, S110, S120 and S130.

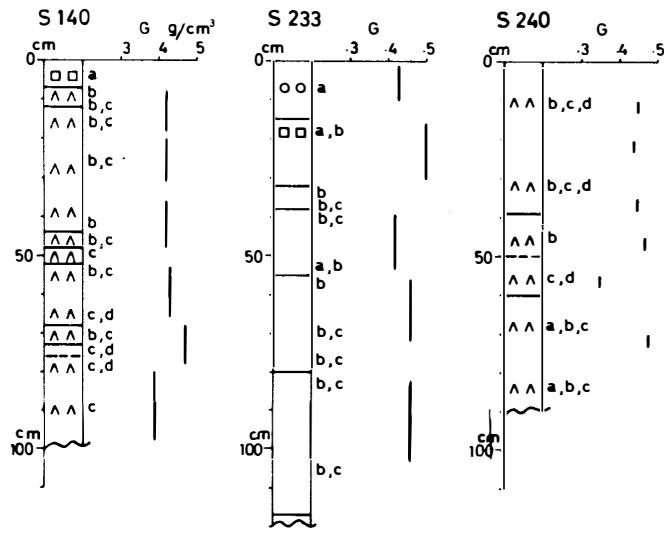

Fig. IV-4. Stratigraphy and density distribution of snow cover at stations S140, S233 and S240 (pit).

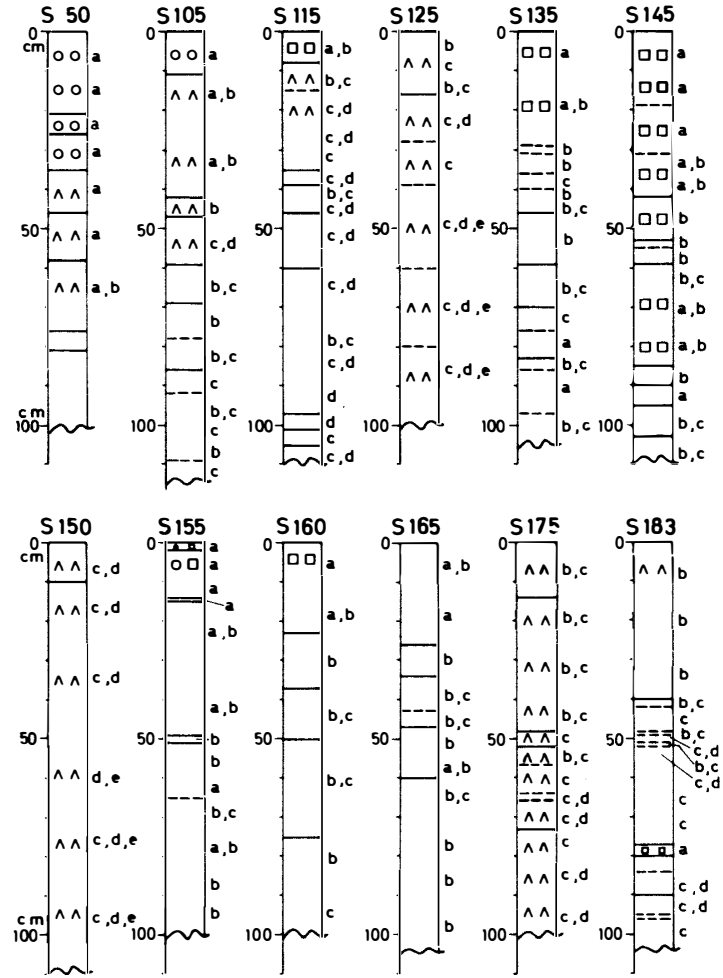

Fig. IV-5. Stratigraphy of snow cover at stations S50(pit), S105, S115, S125, S135, S145, S150, S155, S160(pit), S165, S175 and S183.

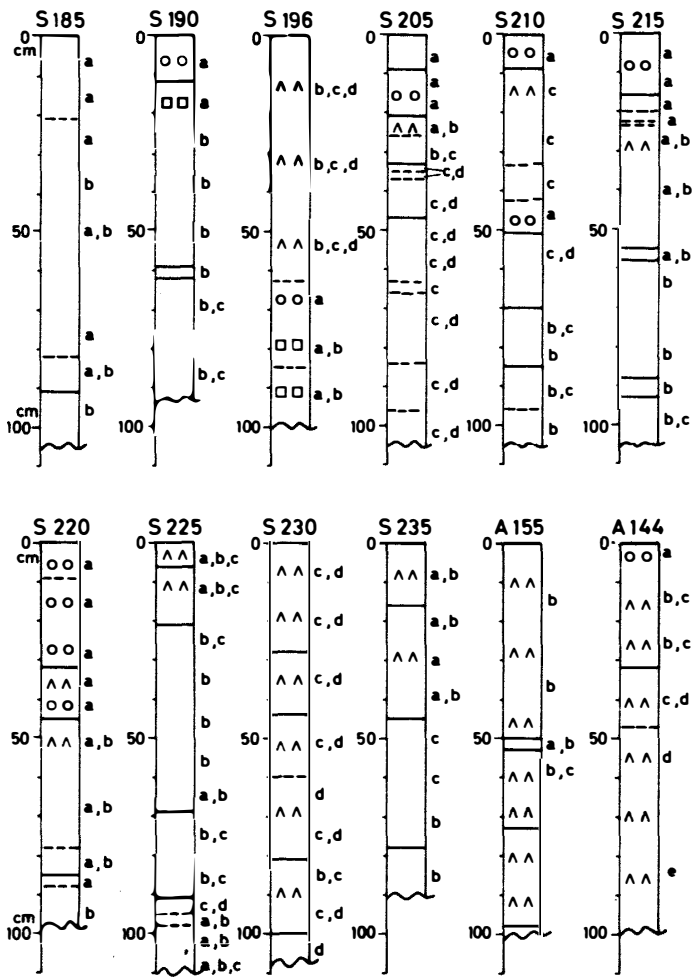

Fig. IV-6. Stratigraphy of snow cover at stations S 185, S 190, S 196, S 205, S 210, S 215, S 220, S 225, S 230, S 235, A 155 and A 144.

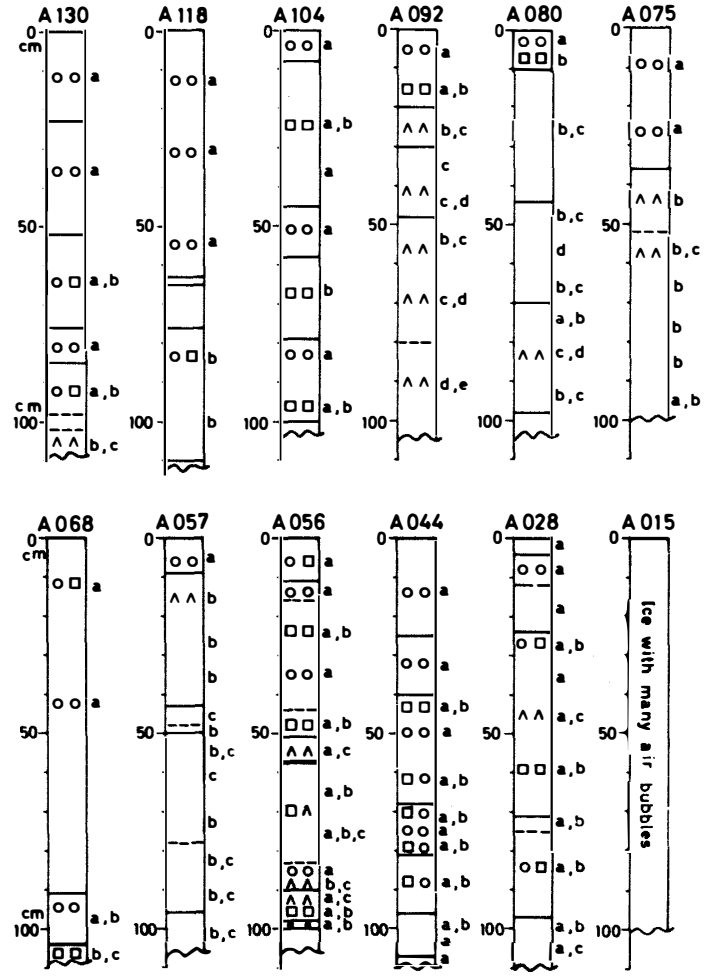

Fig. IV-7. Stratigraphy of snow cover at stations A 130, A 118, A 104, A 092, A 080, A 075, A 068, A 057, A 056, A 044, A 028 and A 015.

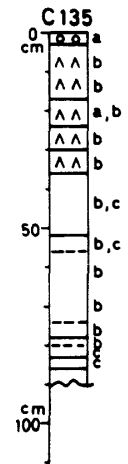
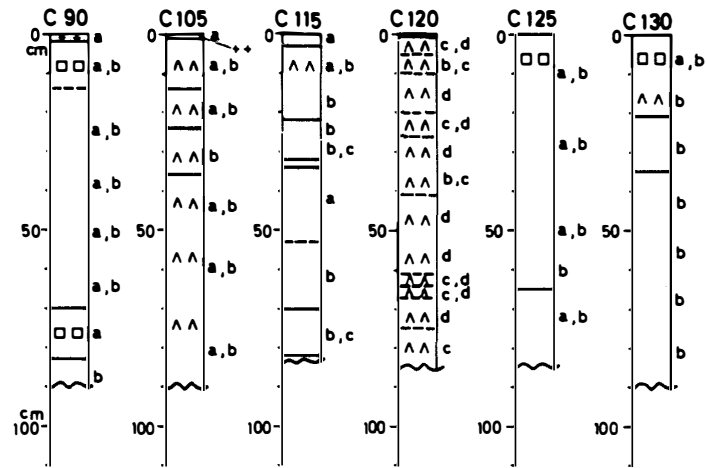

Fig. IV-8. Stratigraphy of snow cover at stations C90, C105, C115, C120, C125, C130 and C135.

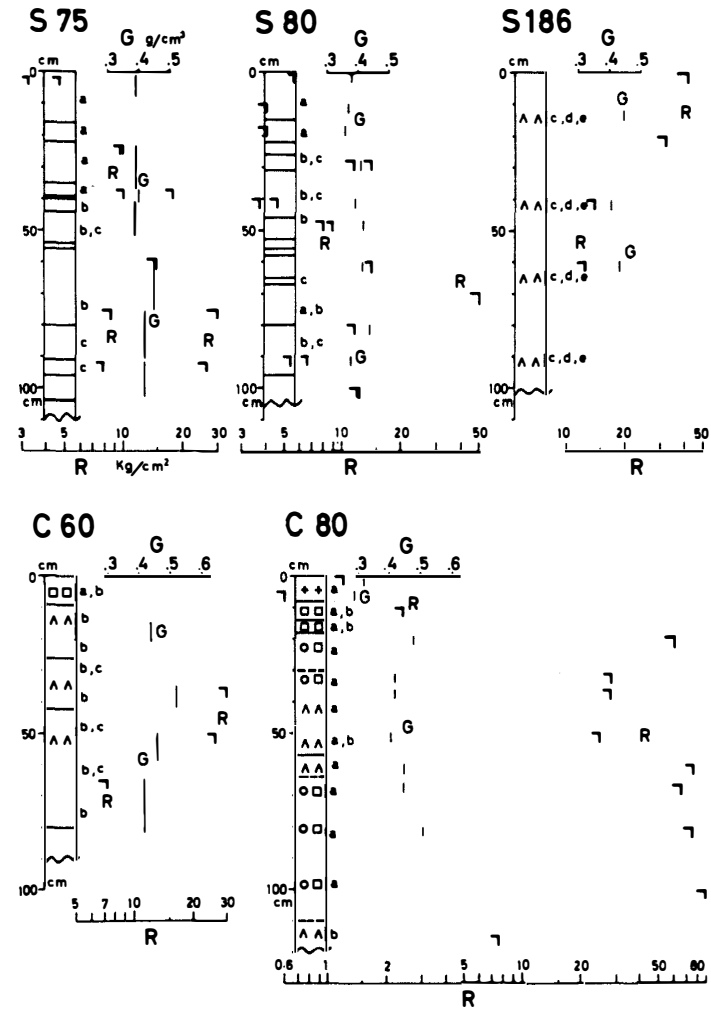

Fig. IV-9. Stratigraphy, density distribution and hardness distribution of snow cover at stations S75, S80(pit), S186(pit), C60 and C80(pit).

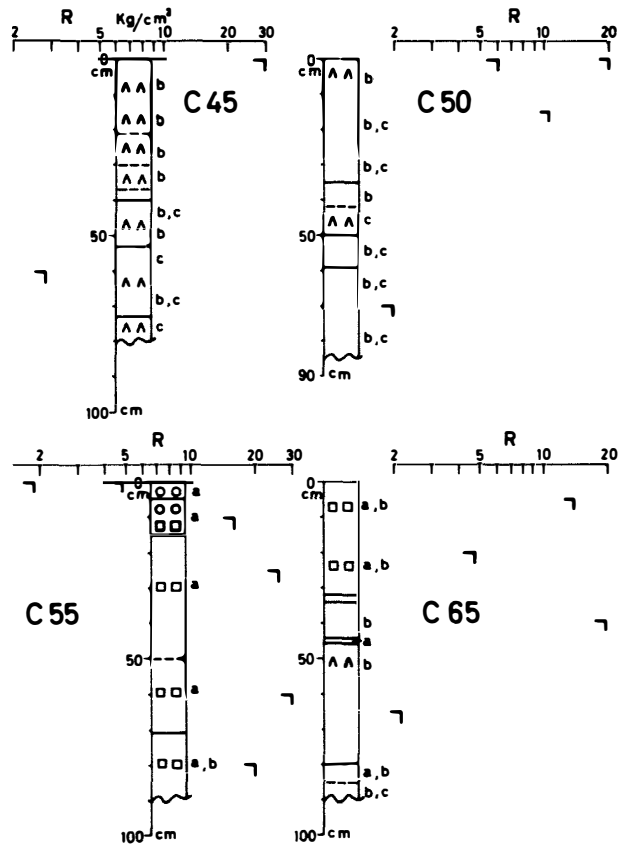

Fig. IV-10. Stratigraphy and hardness distribution of snow cover at stations C45, C50, C55 and C65.

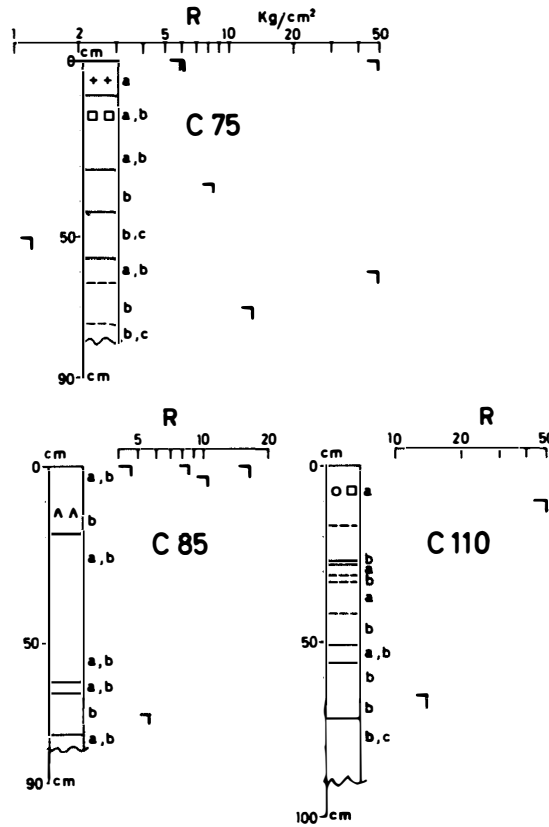

Fig. IV-11. Stratigraphy and hardness distribution of snow cover at stations C75, C85 and C110.

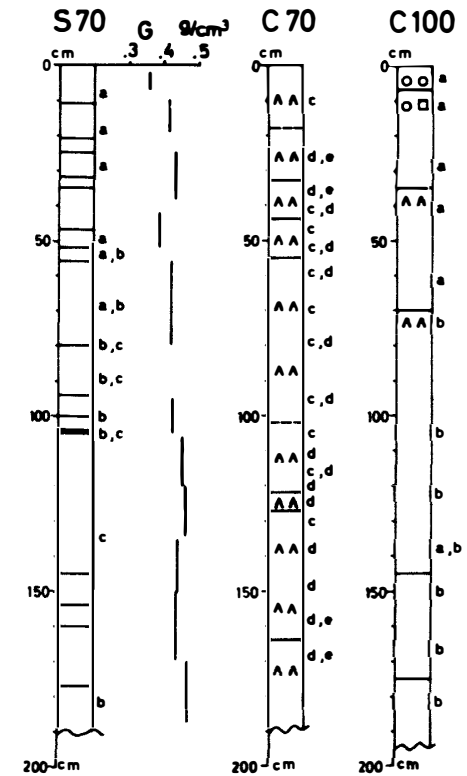

Fig. IV-12. Stratigraphy and density distribution of snow cover at station S70. Stratigraphy of snow cover at stations C70 and C100.

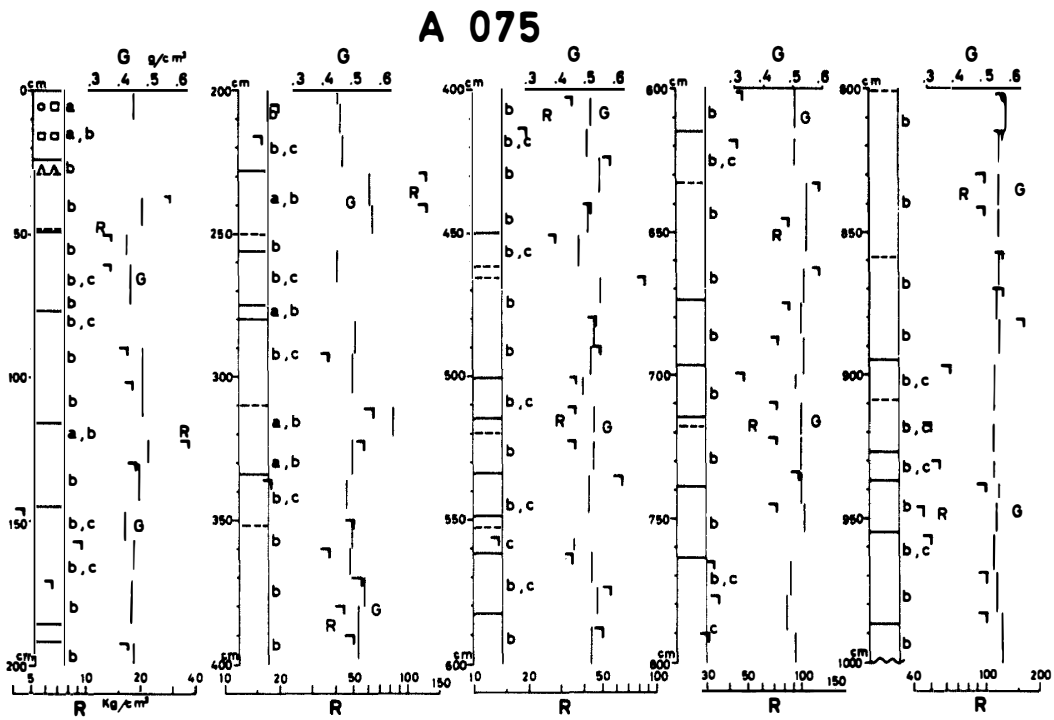

Fig. IV-13. Stratigraphy, density distribution and hardness distribution of snow cover (10 m in depth) at station A075.

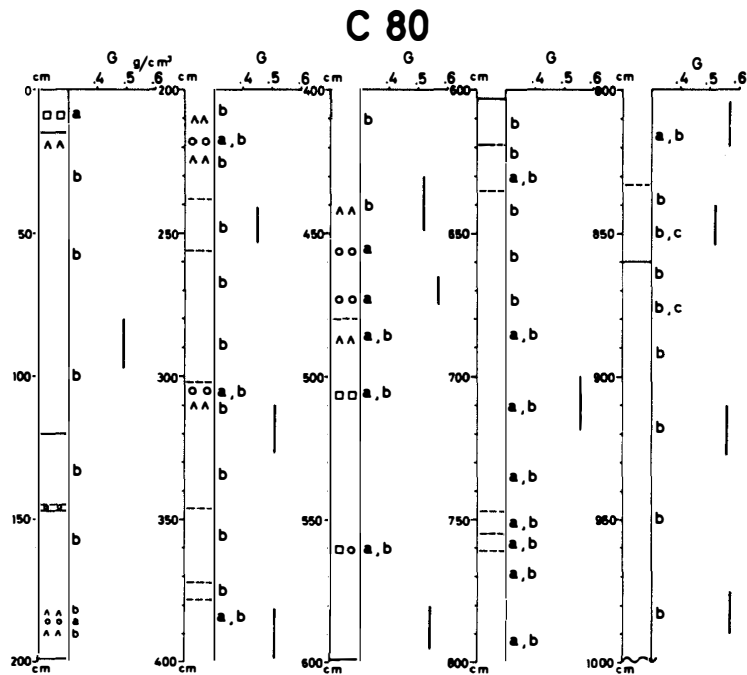

Fig. IV-14. Stratigraphy and density distribution of snow cover (10 m in depth) at station C80.

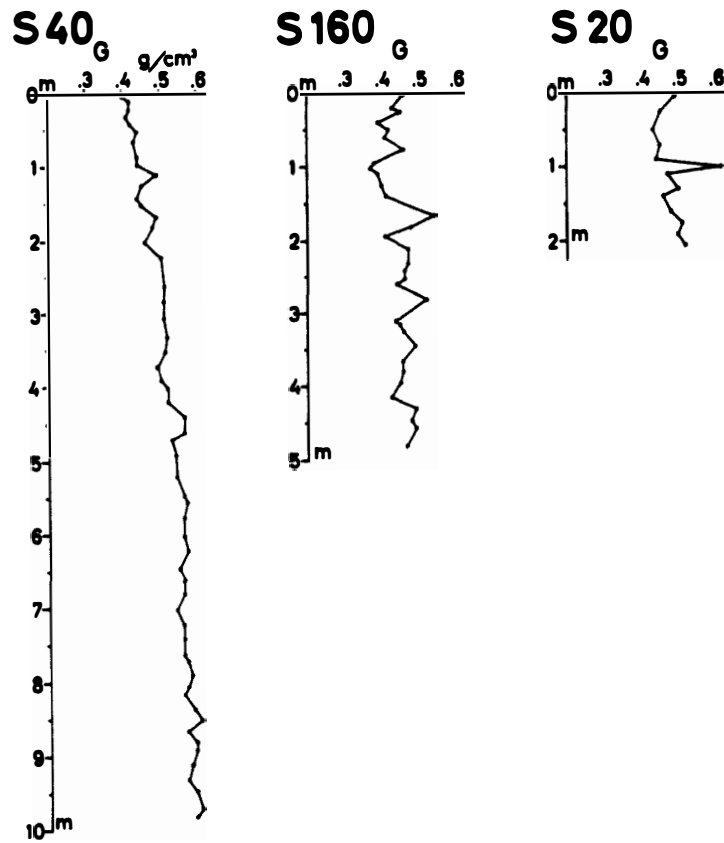

Fig. IV-15. Density profile of snow cover (10 m, 5 m, 2 m in depth) at stations S40, S160 and S20.