

SURFACE PHYTOPLANKTON CHLOROPHYLL DISTRIBUTION  
CONTINUOUSLY OBSERVED IN THE JARE-26 CRUISE  
(1984/85) TO SYOWA STATION, ANTARCTICA  
(SIBEX II)

Mitsuo FUKUCHI<sup>1</sup>, Yasushi FUKUDA<sup>2</sup>, Masao OHNO<sup>3</sup>  
and Hiroshi HATTORI<sup>4</sup>

<sup>1</sup>National Institute of Polar Research, 9-10, Kaga 1-chome, Itabashi-ku, Tokyo 173

<sup>2</sup>Biological Laboratory, Faculty of Education, Kumamoto University, Kumamoto 860

<sup>3</sup>Usa Marine Biological Institute, Kochi University, Usa-Inoshiri, Tosa 781-04

<sup>4</sup>Faculty of Agriculture, Tohoku University, 1-1, Tsutsumidori-Amamiyamachi, Sendai 980

**Abstract:** A continuous measuring-recording system of surface chlorophyll *a*, which is equipped with a personal computer, was used in the 26th Japanese Antarctic Research Expedition (JARE-26) cruise of icebreaker SHIRASE to Syowa Station, Antarctica, in 1984-1985 as part of the Second International BIOMASS program. Geographical distribution of chlorophyll *a* observed on the southward leg through the eastern part of the Indian Antarctic Ocean in early-middle December and that on the northward leg through the western part of the Ocean in late February-early March coincided with the previous JARE observations. Comparing the data obtained on both legs, seasonal difference was also indicated; level of chlorophyll was high in December but low in February-March. Maximum concentration reached 1.55  $\mu\text{g}/\text{l}$  in the north of the Antarctic Convergence in December. Variable, positive or negative relationships between temperature and chlorophyll *a* were observed in the zones of the Subtropical Convergence, Subantarctic Front and Antarctic Convergence.

## 1. Introduction

A prototype of continuous measuring-recording system of surface chlorophyll *a* was firstly built for the 25th Japanese Antarctic Research Expedition (JARE-25) cruise (1983/84) of icebreaker SHIRASE to and from Syowa Station, Antarctica, as part of the international BIOMASS SIBEX I program (HAMADA *et al.*, 1985). Using this system, TANIGUCHI *et al.* (1986, in this volume) found new facts on the spatial and temporal distribution of phytoplankton chlorophyll in the Indian Antarctic Ocean; variable relationships of chlorophyll to temperature, diel variation and so on. This system was improved and the new computerized system was designed for the cruise of the JARE-26 (1984/85) as part of the Second International BIOMASS program-phase II (SIBEX II).

In this paper, we report the horizontal distribution on a finer scale of the chlorophyll *a* observed with this system in relation to temperature variables in the sea area south of 32°S latitude of the Indian Antarctic Ocean.

## 2. Methods and Materials

The computerized system employed for the JARE-26 cruise is schematically represented in Fig. 1. Piping from the intake on the hull (8 m depth) and the self priming

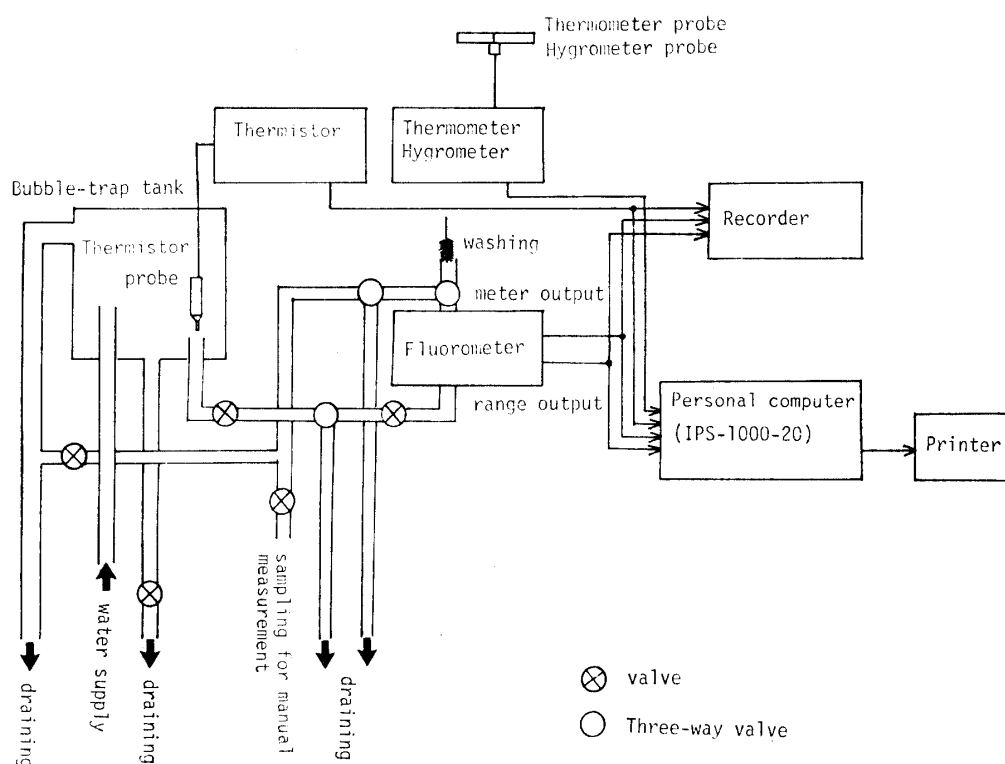

Fig. 1. Schematic representation of the continuous measuring-recording system of the surface chlorophyll *a* employed for the JARE-26 (1984/85).

cascade pump were the same as those used by the JARE-25 (HAMADA *et al.*, 1985). Readings of the *in vivo* fluorometer (Turner Designs 10-000) and the thermistor were recorded not only on an analogue chart paper but also in a floppy disk of a computer (Japan Radio Company, model IPS-1000/20). The computer was used for a real time data processing as well as a post data processing (for details see FUKUDA *et al.*, 1986a). Compared with the prototype designed for the preceding cruise, which was disconnected from a computer (HAMADA *et al.*, 1985), the time necessary for data processing was extraordinarily shortened. Data on water temperature and fluorescence intensity were sampled at 5 min intervals during the present cruise. Two to three liters of overflowed water of the fluorometer was provided for manual determination of the chlorophyll *a* concentration (YENTSCH and MENZEL, 1963) three times a day on board. The results of this manual determination were reported separately from the continuous records (FUKUDA *et al.*, 1986b) and used to calibrate the *in vivo* fluorescence intensities.

### 3. Results and Discussion

All data obtained in the sea area south of 32°S latitude in the Indian sector of the Antarctic Ocean have been published elsewhere (FUKUDA *et al.*, 1986a).

The southward leg started for Syowa Station (69°00'S, 39°35'E), Antarctica from Fremantle, Western Australia, on 3 December 1984 and reached the northern edge of the coastal pack ice (65°06.7'S, 44°09.3'E) at 2025 LT (local time) on 14 December.

The northward leg was from the ice-associated water on 25 February 1985 (around 68°S, 34°E) toward Mauritius.

During the present cruise, apart from the continuous sampling, FUKUDA *et al.* (1986b) carried out bucket samplings of the surface water three times a day (0700, 1200 and 1700 LT). They deduced the locations of the oceanic fronts such as the Subtropical Convergence (STC), Subantarctic Front (SAF) and Antarctic Convergence (AC) from the surface data on physical and chemical properties concurrently measured by IWANAMI and TOJU (in preparation) on board. They positioned approximate locations between two successive surface observations (the maximum interval between two observations was 14h). In addition to their positionings, we analyzed the continuous surface temperature recorded between those two observations and we arbitrarily defined the frontal zones of four hours extent which included the sharpest gradient of temperature (see Table 1 and Figs. 3–5 and 8).

### 3.1. Southward leg

The horizontal distribution of chlorophyll *a* observed on the southward leg is shown in Fig. 2 together with the approximate locations of the STC, SAF and AC.

Chlorophyll *a* concentration was low (0.15–0.16  $\mu\text{g/l}$ ) in the north of the STC. Across the STC at night of December 4, it increased rapidly to 0.5  $\mu\text{g/l}$  (Fig. 3). A rapid decrease of temperature from 17.5° to 16.0°C was recorded in the short time interval between 2125 and 2200 LT December 4, while the SHIRASE seemed to sail across the STC zone between 2000 and 2355 LT December 4.

Between the STC and SAF zones, chlorophyll *a* remained high in a range of 0.4–1.0  $\mu\text{g/l}$ . Around the SAF zone (1800–2155 LT December 6), an inverse relation between chlorophyll and temperature was evident (Fig. 4). In farther south to the AC zone, chlorophyll *a* was exceeding 0.4  $\mu\text{g/l}$  with a peak of 1.55  $\mu\text{g/l}$  at 0500 LT December 8

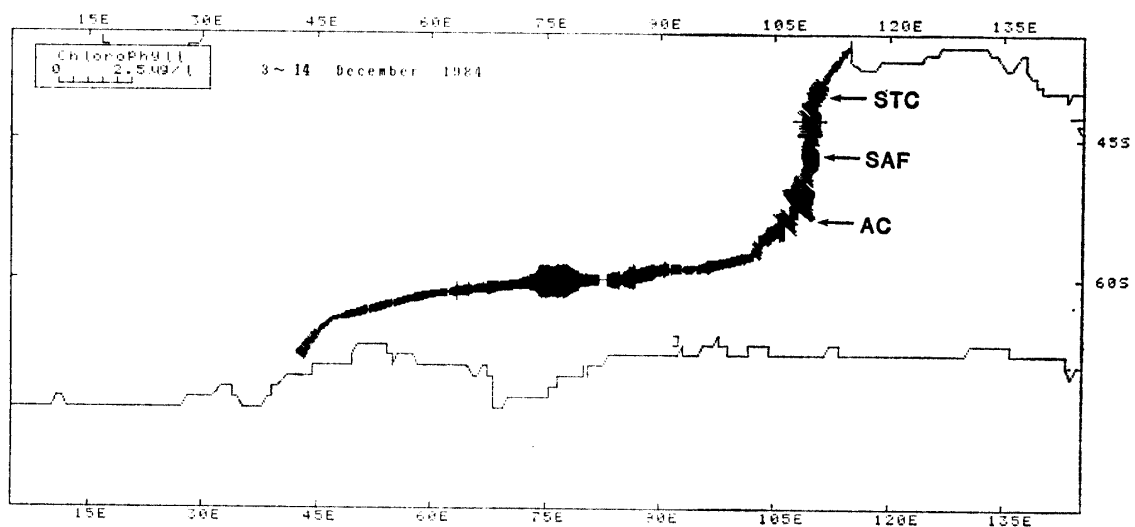

Fig. 2. Horizontal distribution of chlorophyll *a* in the surface water (8 m depth) along the course of the southward leg of icebreaker SHIRASE between 3 and 14 December 1984. AC, SAF and STC indicate approximate locations of the Antarctic Convergence, Subantarctic Front and Subtropical Convergence.

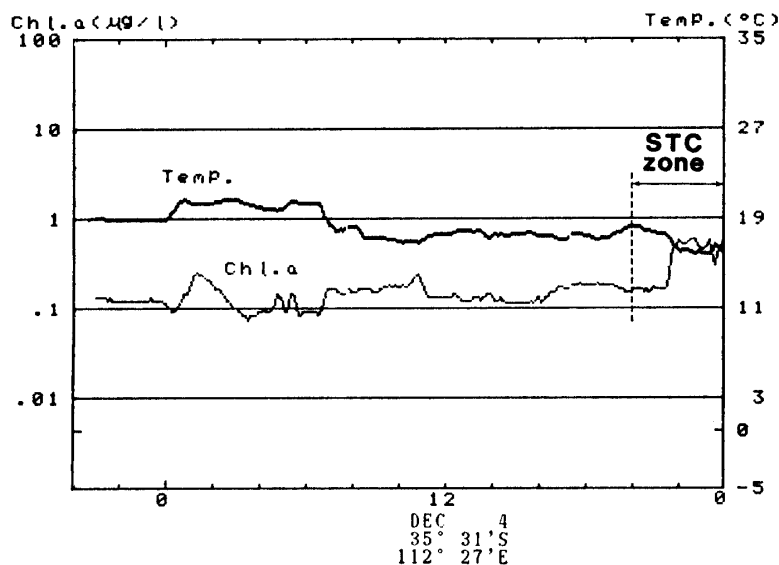

Fig. 3. Time serial records of surface chlorophyll *a* and temperature between 2000 LT December 3 and 0000 LT December 5, 1984 on the southward leg across the Subtropical Convergence (STC) zone.

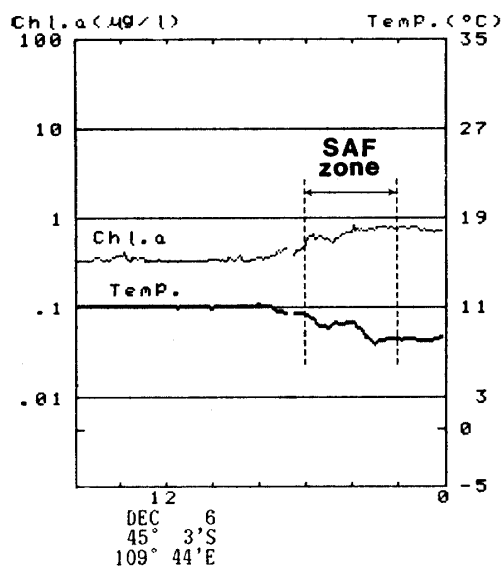

Fig. 4. Time serial records of surface chlorophyll *a* and temperature between 0800 LT December 6 and 0000 LT December 7, 1984 on the southward leg across the Subantarctic Front (SAF) zone.

(Fig. 5), which was the maximum value in the present observation. Although higher values than  $1.0 \mu\text{g/l}$  were common there, the value decreased after crossing the AC zone (Fig. 5). In the south of the AC, where temperature rapidly decreased from  $3.1^\circ$  to  $1.9^\circ\text{C}$  between 1940 and 2020 LT December 8, chlorophyll *a* was in a range of  $0.3\text{--}0.7 \mu\text{g/l}$ .

On the westward course along about  $60^\circ\text{S}$  latitude, high values more than  $1.0 \mu\text{g/l}$  were again seen from 2200 LT December 11 ( $60^\circ 06'\text{S}$ ,  $77^\circ 59'\text{E}$ ) to 0600 LT December 12 ( $60^\circ 11'\text{S}$ ,  $74^\circ 23'\text{E}$ ) with a peak of  $1.35 \mu\text{g/l}$  at 0420 LT December 12 ( $60^\circ 10'\text{S}$ ,  $75^\circ 08'\text{E}$ ) as seen in Fig. 6. Other than these, high values ( $0.4\text{--}1.1 \mu\text{g/l}$ ) had been also seen between 0200 LT ( $59^\circ 39'\text{S}$ ,  $86^\circ 59'\text{E}$ ) and 0600 LT December 11 ( $59^\circ 56'\text{S}$ ,  $85^\circ 14'\text{E}$ ). Beyond

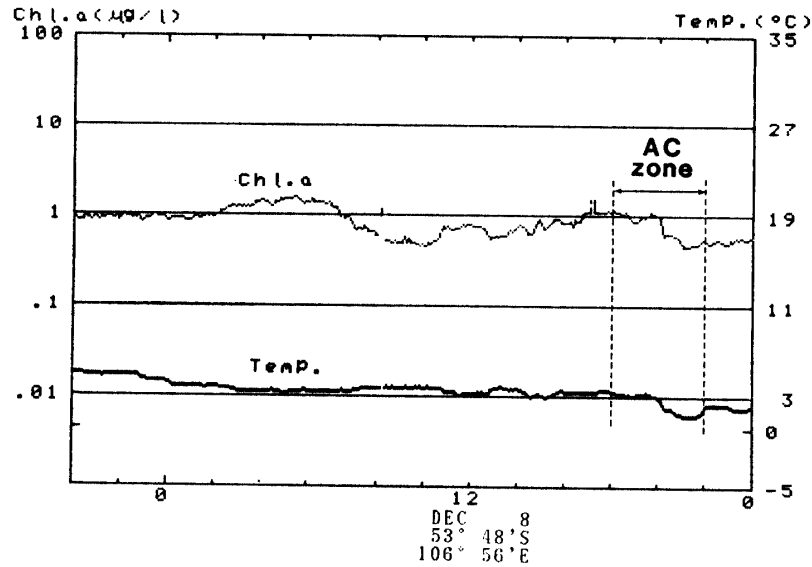

Fig. 5. Time serial records of the surface chlorophyll *a* and temperature between 2000 LT December 7 and 0000 LT December 9, 1984 on the southward leg across the Antarctic Convergence (AC) zone.

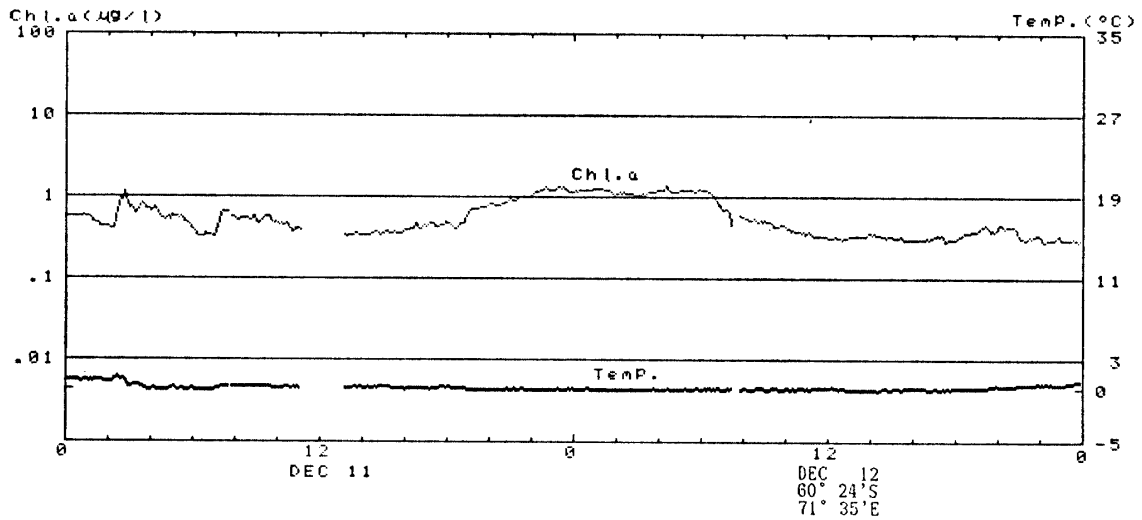

Fig. 6. Time serial records of the surface chlorophyll *a* and temperature between 0000 LT December 11 and 0000 LT December 13, 1984 in the westward course on the southward leg.

the peak onward to the ice edge, chlorophyll *a* was relatively low ranging from 0.2 to 0.5  $\mu\text{g/l}$ .

Geographical variation of chlorophyll *a* over the subtropical water to the Antarctic water mentioned above was similar to that discussed by FUKUCHI (1980), who analyzed the data gathered by the previous 9 JARE cruises. The present high values observed around 85° and 75°E on the westward leg also coincide with two of three areas of high chlorophyll concentrations found on the previous 12 JARE cruises (FUKUCHI and TAMURA, 1982). The last authors mentioned that these areas are associated with the upwellings at the Antarctic Divergence zone. However, in the present observation, the other area of high chlorophyll around 65°E was not seen.

The present high values around  $85^{\circ}$  and  $75^{\circ}$ E were observed in the nighttime. YAMAGUCHI and SHIBATA (1982) found the diurnal periodicity of *in vivo* fluorescence, being high in the nighttime and low in the daytime. TANIGUCHI *et al.* (1986) also recorded the same phenomena on the preceding JARE cruise. Temporal and spatial influences of upwellings on the chlorophyll *a* abundance must be studied in detail.

### 3.2. Northward leg

Chlorophyll *a* distribution on the northward leg from 25 February to 11 March 1985 is shown in Fig. 7, which includes the approximate locations of the AC and STC, which were determined by FUKUDA *et al.* (1986b), and SAF which was deduced in this work. However, the continuous measurement was accidentally interrupted two times between 1955 and 2225LT March 6 and between 1805LT March 8 and 0850LT March 9. These interruptions, unfortunately, happened when the SHIRASE was crossing the AC and STC zones which were recorded by FUKUDA *et al.* (1986b). Therefore, either the positionings of the STC and AC zones or comparisons between temperature and chlorophyll changes around the convergences could not be done on the northward leg.

In the Antarctic water south of the AC zone, among generally low values of  $0.2\text{--}0.3\ \mu\text{g/l}$ , high values more than  $0.5\ \mu\text{g/l}$  were observed between 0200LT March 2 ( $63^{\circ}37'S$ ,  $39^{\circ}58'E$ ) and 0900LT March 3 ( $61^{\circ}43'S$ ,  $40^{\circ}24'E$ ) with the maximum of  $0.77\ \mu\text{g/l}$  at 0350LT March 3 ( $62^{\circ}34'S$ ,  $39^{\circ}57'E$ ). The last was the highest value on the northward leg. In the subantarctic water between the STC and AC zones, chlorophyll *a* was as low as  $0.1\text{--}0.2\ \mu\text{g/l}$ . In Fig. 8, the continuous records of temperature and chlorophyll *a*

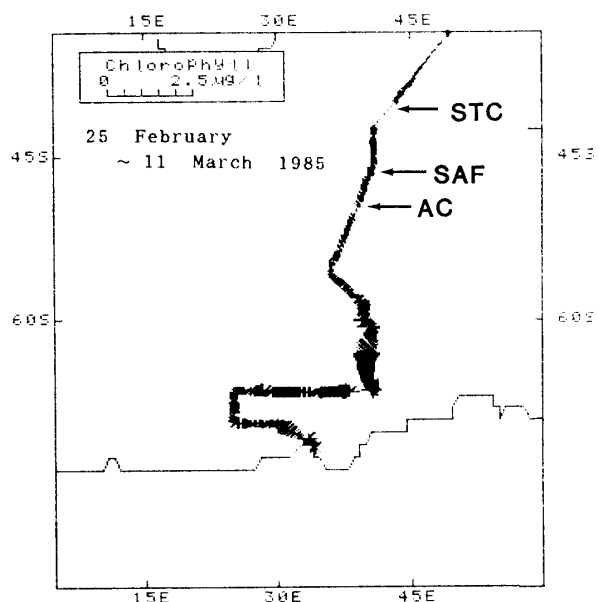

Fig. 7. Horizontal distribution of chlorophyll *a* in the surface water (8 m depth) on the northward leg along the course of icebreaker SHIRASE between 25 February and 11 March 1985. AC, SAF and STC as in Fig. 2.

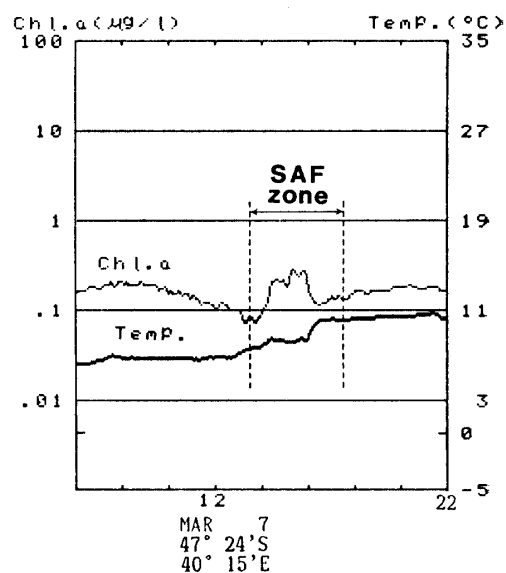

Fig. 8. Time serial records of the surface chlorophyll *a* and temperature between 0600 LT March 7 and 0000 LT March 8, 1985 on the northward leg across the Subantarctic Front (SAF) zone.

between 0600LT (47°58'S, 39°54'E) and 2200LT March 7 (44°58'S, 40°58'E) are shown. Rapid increases of temperature occurred at 1405–1425LT (7.8°–8.3°C) and 1555–1635LT (8.2°–10.0°C). Chlorophyll *a* fluctuated largely for these periods, while the absolute concentration itself was as low as 0.07–0.28  $\mu\text{g/l}$ . These indicate that the SHIRASE sailed over an oceanic frontal zone during these periods. The front is considered to be the Subantarctic Front, because the temperature regime encountered coincides with the Subantarctic frontal regime stated by EDWARDS and EMERY (1982). FUKUDA *et al.* (1986b), however, could not detect any indication of this front. Manual observations employed three time a day by FUKUDA *et al.* (1986b) seem to be insufficient to detect such a narrow front. In the subtropical water north of the STC, the chlorophyll *a* concentration was less than 0.2  $\mu\text{g/l}$ .

Levels of chlorophyll *a* concentration observed on the northward leg (late February–early March) from the Antarctic water to subtropical water were lower than those on the southward leg (early–middle December). This seems to be a reflection of the seasonal variation, rather than geographical one, of phytoplankton as reported by FUKUCHI (1980, 1982). He also mentioned that relatively high values are seen around the STC zone due to an autumnal growth of phytoplankton. However, the present observation missed the high values around the STC zone because of the trouble of the measuring system.

### 3.3. Chlorophyll-temperature changes on a fine scale around the frontal zones

As seen in Figs. 3–5 and 8, temperature and chlorophyll *a* fluctuated widely around the STC, SAF and AC zones, while their trends were also variable in parallel or inverse manners (Table 1 and Fig. 9).

On the southward leg chlorophyll *a* concentration changed inversely to temperature across the STC and SAF zones, *i.e.*, chlorophyll *a* increased as temperature

Table 1. Range of the variations of temperature and chlorophyll *a* concentration around various oceanic frontal zones. STC, SAF and AC denote the Subtropical Convergence, Subantarctic Front and Antarctic Convergence, respectively.

Front	Local time	Position	Temperature (°C)	Chlorophyll <i>a</i> ( $\mu\text{g/l}$ )
Southward leg:				
STC zone	2000 Dec. 4	37°13.2'S, 111°23.4'E	18.10	0.16
	2355 Dec. 4	38°02.6'S, 110°53.3'E	15.96	0.55
SAF zone	1800 Dec. 6	45°44.5'S, 109°50.0'E	10.16	0.53
	2155 Dec. 6	46°26.4'S, 109°42.9'E	8.01	0.73
AC zone	1800 Dec. 8	54°45.5'S, 106°07.5'E	3.32	1.09
	2155 Dec. 8	55°15.4'S, 105°14.3'E	1.64	0.53
Northward leg:				
SAF zone	1330 Mar. 7	47°03.3'S, 40°23.9'E	7.47	0.08
	(south)			
	1525 Mar. 7	46°37.3'S, 40°35.8'E	8.12	0.26
	(north)			
	1530 Mar. 7	46°36.1'S, 40°36.3'E	8.18	0.24
	1725 Mar. 7	46°11.2'S, 40°47.0'E	10.00	0.13

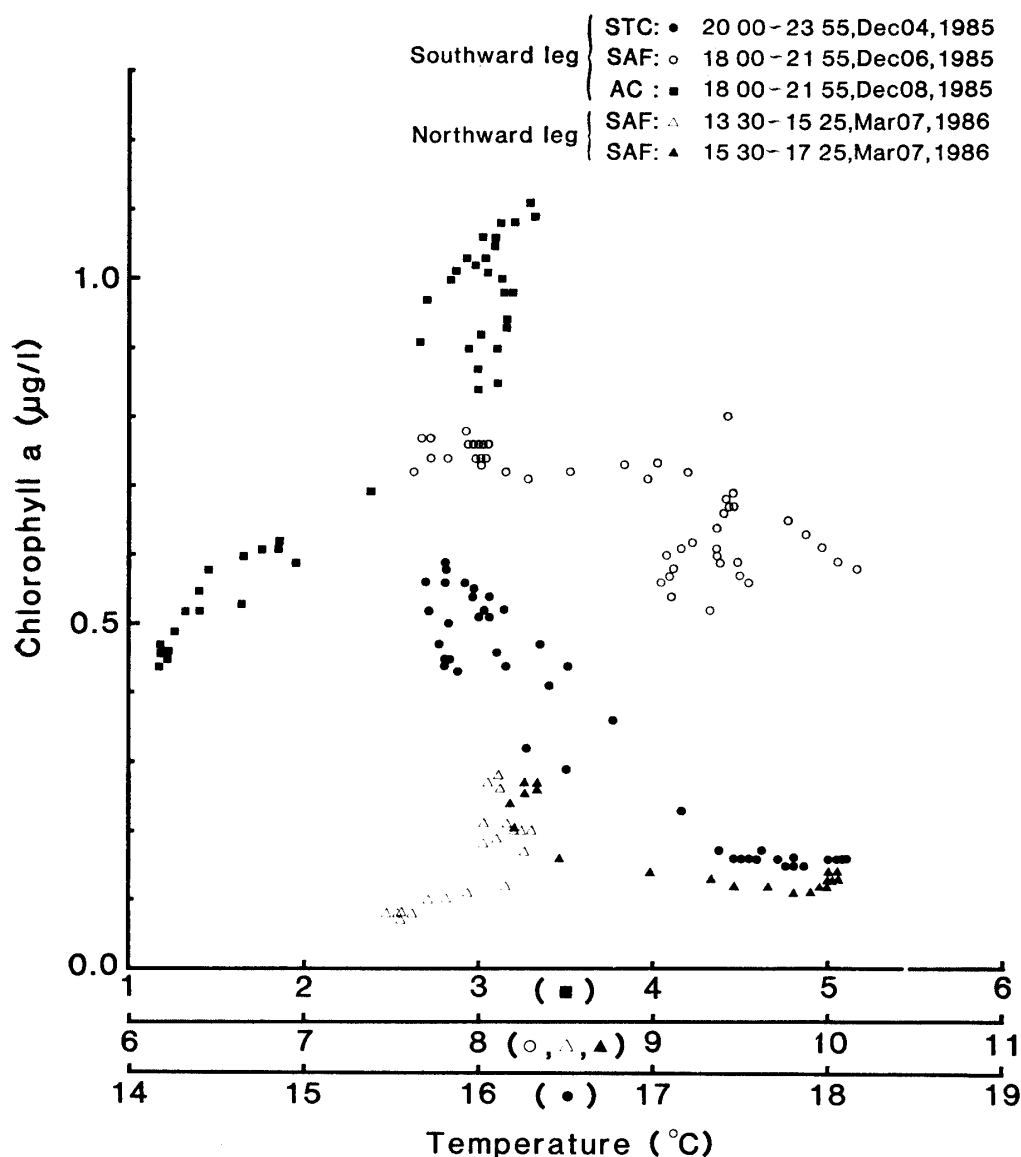

Fig. 9. Relationships between chlorophyll *a* concentration and temperature observed across the Subtropical Convergence (STC), Subantarctic Front (SAF) and Antarctic Convergence (AC) zones. Data on the southward leg in the southern half of the SAF zone are expressed by open triangles and that of northern half are by closed triangles.

decreased. On the other hand, chlorophyll *a* decreased as temperature decreased across the AC zone. On the northward leg, the data are available only for the SAF zone. Opposite relations between temperature and chlorophyll can be seen within the SAF zone; a positive correlation was observed in the southern half and a negative one in the northern half. The negative relationships are also reported for areas around the STC and SAF zones on the southward leg in the preceding year by TANIGUCHI *et al.* (1986). However, they reported a positive relation in the southern half and a negative relation in the northern half within the AC zone on the southward leg.

At present, any definite conclusions on temperature-chlorophyll relation can not be made, but the dependence of phytoplankton concentration and activity on temper-



ature seems to be variable in the different hydrographic and bathymetric features as discussed by HAYES *et al.* (1984) and TANIGUCHI *et al.* (1986).

In future cruise, the system will be improved to incorporate the relevant data which are not only navigation information such as position, time, cruising speed, sea depth, etc., but also oceanographic parameters such as temperature, salinity, dissolved oxygen and nutrient salts for the clarification of the fine scale temporal and spatial distributions of phytoplankton in the Antarctic Ocean including the oceanic frontal zones.

### Acknowledgments

We thank Prof. S. KAWAGUCHI (National Institute of Polar Research), leader of JARE-26, and Captain T. SATOU of icebreaker SHIRASE for their kind supports given to us on board.

### References

- EDWARDS, R. J. and EMERY, W. J. (1982): Australasian Southern Ocean frontal structure during summer 1976-77. *Aust. J. Mar. Freshwater Res.*, **33**, 3-22.
- FUKUCHI, M. (1980): Phytoplankton chlorophyll stocks in the Antarctic Ocean. *J. Oceanogr. Soc. Jpn.*, **36**, 73-84.
- FUKUCHI, M. (1982): Ichiji seisan (Primary production). *Nankyoku no Kagaku*, 7. Seibutsu (Science in Antarctica, 7. Biology), ed. by Natl Inst. Polar Res. Tokyo, Kokon Shoin, 11-32.
- FUKUCHI, M. and TAMURA, S. (1982): Chlorophyll *a* distribution in the Indian sector of the Antarctic Ocean in 1978-1979. *Nankyoku Shiryô (Antarct. Rec.)*, **74**, 143-162.
- FUKUDA, Y., OHNO, M., HATTORI, H. and FUKUCHI, M. (1986a): Chlorophyll *a* concentration measured in the Southern Ocean during the 1984/85 cruise of the SHIRASE to and from Syowa Station, Antarctica. *JARE Data Rep.*, **111** (Mar. Biol. 8), 73 p.
- FUKUDA, Y., OHNO, M., IWANAMI, K. and TOJU, J. (1986b): Chlorophyll *a* content in the surface and subsurface waters along the course of the SHIRASE to Antarctica in 1984-1985. *Nankyoku Shiryô (Antarct. Rec.)*, **30**, 103-112.
- HAMADA, E., TANIGUCHI, A., OKAZAKI, M. and NAITO, Y. (1985): Report on the phytoplankton pigments measured during the JARE-25 cruise to Syowa Station, Antarctica, November 1983 to April 1984. *JARE Data Rep.*, **103** (Mar. Biol. 7), 89 p.
- HAYES, P. K., WHITAKER, T. M. and FOGG, G. E. (1984): The distribution and nutrient status of phytoplankton in the Southern Ocean between 20° and 70°W. *Polar Biol.*, **3**, 153-165.
- TANIGUCHI, A., HAMADA, E., OKAZAKI, M. and NAITO, Y. (1986): Distribution of phytoplankton chlorophyll continuously recorded in the JARE-25 cruise to Syowa Station, Antarctica (SIBEX I). *Mem. Natl Inst. Polar Res., Spec. Issue*, **44**, 3-14.
- YAMAGUCHI, Y. and SHIBATA, Y. (1982): Standing stock and distribution of phytoplankton chlorophyll in the Southern Ocean south of the Australia. *Trans. Tokyo Univ. Fish.*, **5**, 111-128.
- YENTSCH, C. S. and MENZEL, D. W. (1963): A method for the determination of phytoplankton chlorophyll and phaeophytin by fluorescence. *Deep-Sea Res.*, **10**, 221-231.

(Received July 11, 1986; Revised manuscript received September 8, 1986)