

An adaptive and rule based driving system for energy-efficient and safe driving behaviour



UNIVERSIDAD DE SEVILLA

DEPARTAMENTO DE LENGUAJES Y SISTEMAS INFORMATICOS

International doctoral dissertation presented by

Emre Yay

advised by

Dr. Juan Antonio Ortega Ramírez and

Dr. Natividad Martínez Madrid

July 2015

Abstract

Saving energy and protecting the environment became fundamental for society and politics, why several laws were enacted to increase the energy-efficiency. Furthermore, the growing number of vehicles and drivers led to more accidents and fatalities on the roads, why road safety became an important factor as well. Due to the increasing importance of energy-efficiency and safety, car manufacturers started to optimise the vehicle in terms of energy-efficiency and safety. However, energy-efficiency and road safety can be also increased by adapting the driving behaviour to the given driving situation. This thesis presents a concept of an adaptive and rule based driving system that tries to educate the driver in energy-efficient and safe driving by showing recommendations on time. Unlike existing driving systems, the presented driving system considers energy-efficiency and safety relevant driving rules, the individual driving behaviour and the driver condition. This allows to avoid the distraction of the driver and to increase the acceptance of the driving system, while improving the driving behaviour in terms of energy-efficiency and safety. A prototype of the driving system was developed and evaluated. The evaluation was done on a driving simulator using 42 test drivers, who tested the effect of the driving system on the driving behaviour and the effect of the adaptiveness of the driving system on the user acceptance. It has been proven during the evaluation that the energy-efficiency and safety can be increased, when the driving system was used. Furthermore, it has been proven that the user acceptance of the driving system increases when the adaptive feature was turned on. A high user acceptance of the driving system allows a steady usage of the driving system and, thus, a steady improvement of the driving behaviour in terms of energy-efficiency and safety.

Contents

1	Introduction	1
1.1	Methodology	4
1.2	Hypothesis	4
1.3	Goal of this work	5
1.4	Definition of energy-efficiency	6
1.4.1	Energy-efficiency in general	6
1.4.2	Energy-efficiency in road transportation	7
1.5	Definition of safety	8
1.5.1	Safety in general	8
1.5.2	Safety on the road	8
1.6	Thesis Outline	9
2	Driving rules and driving systems	13
2.1	Driving rules for energy-efficiency	13
2.2	Driving rules for safety	15
2.3	Driving systems	18
2.4	Discussion	27
3	Driving system	31
3.1	Goal of the driving system	31
3.2	Cycle of the driving system	32
3.3	Driving rules	34

3.4	Driving profile	39
3.5	Architecture of the driving system	42
3.6	Interface module	44
3.6.1	Monitoring the car	45
3.6.2	Monitoring the environment	46
3.6.3	Monitoring the driver	48
3.7	Data aggregation module	50
3.8	Profile update module	56
4	Prediction engine module	59
4.1	Discrete Kalman filter	60
4.2	Autoregressive Moving-Average	63
4.3	Evaluation	65
4.4	Results	66
4.5	Discussion	71
5	Rule selector module	73
5.1	Rete	74
5.2	Treat	77
5.3	Leaps	79
5.4	Improved rule matching algorithm	81
5.5	Evaluation	87
5.6	Results	89
5.7	Discussion	90
6	Recommendations inference engine module	93
6.1	Definition when a recommendation should be shown	95
6.2	Detecting the driver reaction to a given recommendation	99
6.3	Decision tree	102

6.4	Evaluation and results	106
6.5	Discussion	108
7	Prototype	111
7.1	Architecture	112
7.2	Data layer	114
7.3	Processing layer	119
7.4	Graphical layer	122
8	Evaluation	125
8.1	Driving simulator	125
8.2	Experimental set-up	130
8.2.1	Evaluating the first hypothesis	132
8.2.2	Evaluating the second hypothesis	136
9	Results	143
10	Discussion	153
11	Conclusions	159
12	Future work	161
A	Publications	163
	Bibliography	165

CONTENTS

List of Figures

1.1	Energy consumption on the road from 1990 to 2012 in 1000 tonnes of oil equivalent	2
1.2	Causes of accidents with personal injury	3
2.1	Kia's driving system is using a coloured lamp to indicate the energy-efficiency of the driving behaviour	20
2.2	System configuration and the behaviour of the Nissan brake pedal . .	21
2.3	Eco:Index report of Fiat's driving system	22
2.4	An example of a monthly report, which shows the journey safety . . .	26
3.1	Cycle of the driving system	33
3.2	The driving profile with the stored information about the driver . . .	40
3.3	The architecture of the driving system including the modules and their corresponding	42
3.4	The driving rule parameters and the driver condition with the corresponding information sources: driver, car and environment	45
3.5	An example car network using the serial-bus systems	46
3.6	An example of the membership functions triangle, trapezium and Gaussian	53
3.7	The fuzzy set of the manner of driving on the basis of the engine speed, using the triangular membership functions	54
3.8	Two fuzzy rules with antecedents and consequences and the composition of the rules	55

LIST OF FIGURES

3.9	The calculation of the typical manner of driving during the first and the second journey using the simple exponential smoothing technique	58
4.1	The data flow of the processing layer with the focus on the prediction module	59
4.2	The cycle of the Kalman filter with the steps prediction and correction	61
4.3	Captured driving speed of the journey using a driving simulator . . .	65
4.4	2.5 seconds prediction of the driving speed using the Kalman filter and the deviation from the original speed	68
4.5	2.5 seconds prediction of the driving speed using the ARMA and the deviation from the original speed	68
4.6	5 seconds prediction of the driving speed using the Kalman filter and the deviation from the original speed	69
4.7	5 seconds prediction of the driving speed using ARMA and the deviation from the original speed	69
4.8	10 seconds prediction of the driving speed using the Kalman filter and the deviation from the original speed	70
4.9	10 seconds prediction of the driving speed using ARMA and the deviation from the original speed	70
4.10	The results of the evaluation showing the average deviation from the original driving speed for every run	71
5.1	The data flow of the processing layer with the focus on the rule selector module and its local working memory and improved rule matching algorithm	73
5.2	Illustration of the Rete algorithm with the operations add and delete	76
5.3	Illustration of the Treat algorithm with the operations add and delete	78
5.4	Illustration of the Treat algorithm with the operations add and delete	80
5.5	The improved rule matching algorithm is using pointers to the facts and triggers the improved Rete network to check the conditions against the facts on every update of the working memory	84
5.6	The average results of the evaluation	91

6.1	The data flow of the processing layer with the focus on the recommendations inference engine module	93
6.2	Illustration of the decision process with the detection of broken rules $g(b)$, the broken rules set B , the decision function $f(b)$ and the recommendations set U	96
6.3	The process how the driver reaction to the previous shown recommendation is checked	100
6.4	The decision tree that is used in the recommendations inference engine to check the adherence of the last shown recommendation and to decide whether to show a recommendation	104
6.5	The result of the evaluation of the decision tree	107
7.1	The architecture of the driving system that is used as the basis for the prototype	111
7.2	The architecture of the prototype driving system	113
7.3	The fuzzy sets of the acceleration and the manner of driving used in the prototype for fuzzification	115
7.4	The structure of the database that is used to store the driving profile and the consequences of the driving rules	118
7.5	The graphical user interface of the prototype	123
8.1	The driving simulator that is used in the evaluation	126
8.2	The architecture of the driving simulator, in which the red colour indicates the input devices and the green colour the output devices . . .	127
8.3	The driving routes of the evaluation on the highway and the city . . .	131
8.4	The questionnaire that was used to get information about the driver in the evaluation of hypothesis (1)	134
8.5	The questionnaire that was used in the evaluation of hypothesis (2) to get information about the driver and to measure the user acceptance of the adaptive and non-adaptive driving systems	140
9.1	The fuel consumption of the test drivers on the 4 km city route . . .	146

LIST OF FIGURES

9.2 The speed limit adherence of the test drivers on the 4 km city route 146

9.3 The fuel consumption of the test drivers on the 10 km highway 148

9.4 The speed limit adherence of the test drivers on the 10 km highway 148

10.1 Comparison of fuel consumption of all drivers with and without the usage of the driving system on the city and the highway route 154

10.2 Comparison of speed limit adherence of all drivers with and without the usage of the driving system on the city and the highway route 155

10.3 Comparison of usefulness, ease of use and satisfaction of the driving system with and without the adaptive feature 156

Chapter 1

Introduction

Several oil crises in the last decades and the achievement of the peak oil¹ increased society's awareness of the finiteness of the oil. In conjunction with the increasing energy demand in the European Union and the human-made climate change, saving energy and protecting the environment became fundamental for politics and society. Thus, several laws were enacted to reduce the greenhouse gas emissions, which is the consequence of the usage of fossil fuels, like the CO² limitations for passenger cars in the European Union. Furthermore, the European Union is aiming to save 20 % energy, and thus to reduce the CO² emissions, until the year 2020 by increasing the energy-efficiency at all stages on the energy chain, for example by increasing the energy-efficiency of the vehicles on the road [2]. Figure 1.1 shows that the energy consumption on the road increased by 21 % from 1990 to 2012. The European Union expects that the energy demand and, thus, the CO² output of the vehicles will further increase, due to an increasing motorisation in the European Union, the trend for living in suburban areas or the expansion of tourism [3].

The growing number of vehicles and drivers in the past led also to more accidents and fatalities on the road, why road safety became an important factor as well. Due to the increasing importance of energy-efficiency and road safety, car manufacturers are trying to optimise the car respectively parts of the car, like the engine or the car body, to save energy and to increase the road safety. Furthermore, new methods were invented to increase the energy-efficiency and the road safety of the

¹Peak oil is the point in time, when the maximum global petroleum extraction is reached

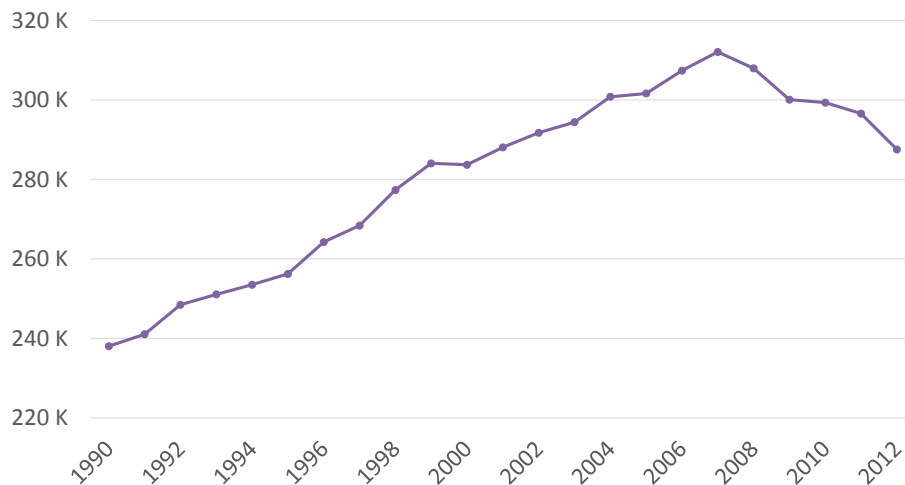

Figure 1.1: Energy consumption on the road from 1990 to 2012 in 1000 tonnes of oil equivalent [1]

car like the regenerative brake [4], which converts kinematic energy during the brake application to electric energy or the anti-lock brake system [5], which increases the safety by preventing the wheels from locking up.

Besides the optimisation of the car, there is the potential to increase the energy-efficiency and road safety by adapting the driving behaviour to the given driving situation. The studies [7] and [8] showed that the driving behaviour has an effect on the road safety. This has been also verified by the accidents report of the German Statistical Office [6] that showed that about 86 % of the accidents with personal injury in Germany in 2013 happened because of driver mistakes, such as speeding or less distance to the preceding car. Figure 1.2 lists the causes of the accidents with personal injury that happened in 2013. Furthermore it shows that the main cause of road accidents with personal injury in the year 2013 were turning off mistakes (13.6 %), failures to yield the right of way (12.5 %), inappropriate speed (12.0 %) and insufficient distance to car in front (11.2 %). Furthermore, an adapted driving behaviour can save energy up to 30 % as several studies showed [9, 10, 11]. However, according to Bongard [12] energy savings about 30 % can only be reached by experienced drivers. In short-term driving practices, like energy-efficiency trainings or contests, energy savings about 24 % are possible as the tests of the car manufacturer Ford showed [13]. In contrast, Barkenbus [14] calculates the energy savings in long-term driving practices at 5 % when the drivers have no continuous feedback after

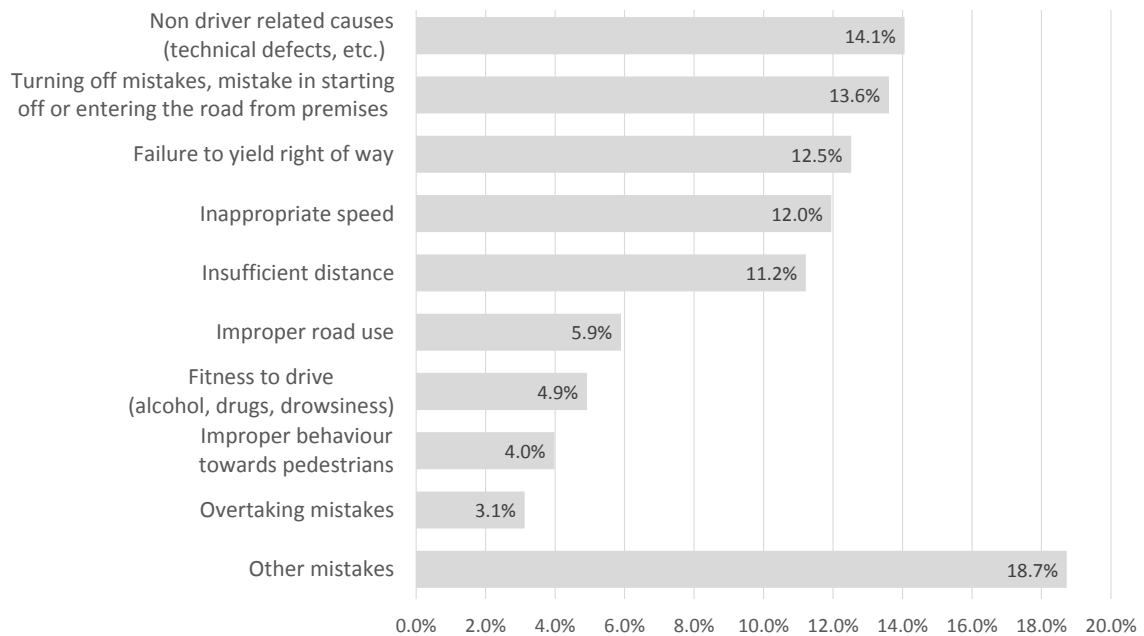

Figure 1.2: Causes of accidents with personal injury [6]

the initial training. However, with a continuous feedback Barkenbus calculates the energy savings at 10 %. A continuous feedback is defined by Barkenbus as showing energy-efficient relevant recommendations every day.

There are already driving systems, such as the driving systems of Fiat [15], Kia [16] or Lotan and Toledo [17], trying to improve the driving behaviour in terms of energy-efficiency or safety. However, these driving systems cover either the area of energy-efficiency or safety and provide insufficient feedback to the driver, for example by showing a green lamp when the driver is driving energy-efficient. Furthermore, the driving systems do not adapt itself to the individual driving behaviour and do not consider the driver condition. This can lead to a decrease of the acceptance of the driving systems as they may confuse the driver with recommendations in dangerous driving situations by giving for example an energy-efficient relevant recommendation while driving too close to the car in front. Furthermore, the driving systems show the driver recommendations even when the driver is in stress. This may lead to an increase of the mental load of the driver especially in stressful driving situations and, thus, to accidents, as a high mental load can lead to accidents [18]. Another point is that the driving systems may bother the driver with recommendations, which are not relevant in the sense of the driver. Thus, the driver may switch off the driving system and may not use it further.

Due to the elaborated facts, the goal of this work is to create a driving system that educates the driver in energy-efficient and safe driving behaviour. Therefore, the driving system gives driving recommendations on time, while considering the individual driving behaviour and the driver condition. This allows the driving system to show customised recommendations. Thus, the driving system does not bother the driver with recommendations, which are not relevant in the sense of the driver, and suppresses recommendations when the driver is for example in stress. This may lead to an increase of the acceptance of the driving system.

1.1 Methodology

The methodology used in this work includes four steps:

1. Analysis: During the analysis phase the research question was worked out on the basis of the research in literature, tools and methodologies. Furthermore, the current available driving systems were analysed and studied in this phase.
2. Conception: On the basis of the analysis, the concept of the new driving system was worked out and innovative algorithms were developed. Furthermore, other algorithms were developed in order to compare the performance of the innovative algorithms.
3. Development: In this phase of the methodology, the prototype of the driving system was developed according to the results of the conception phase.
4. Evaluation: The developed prototype was evaluated and tested in this phase.

1.2 Hypothesis

The following research question was identified during the analysis phase of the used methodology and is the basis of this dissertation:

- Is it possible to improve the driving behaviour in terms of energy-efficiency and safety by giving driving recommendations on time while considering the driver condition and the individual driving behaviour?

Recommendations are shown to the driver when an energy-inefficient or unsafe driving behaviour is detected. The recommendations allow to point the driver to his wrongdoings that caused the energy-inefficient or unsafe driving. Thus, the driver has the opportunity to eliminate the wrongdoings and, thus, to improve the driving behaviour in terms of energy-efficiency and safety.

- Does the adaptiveness of the driving system increase the user acceptance of the driving system?

The adaptiveness of the driving system allows to consider the driver condition and the individual driving behaviour when showing a recommendation to the driver. Thus, the shown recommendations are adapted to the driver needs. The adaptive feature of the driving system should help to increase the user acceptance of the driving system and, thus, to lead to a steady usage of the driving system.

1.3 Goal of this work

The goal of this work is to solve the research question and, thus, to reduce the energy-consumption of the vehicle and to increase the road safety. Another goal is the increase of the user acceptance using the adaptive feature of the driving system. Therefore, the prototype and the supporting algorithms have to be checked that they educate the driver in energy-efficient and safe driving as well as adapt itself to the individual driving behaviour using experiments with test persons on the driving simulator. The evaluation of the driving simulator will demonstrate an increase of the energy-efficiency and safety when using the driving system. Furthermore, the evaluation demonstrates that the user acceptance is higher when using the adaptive feature of the driving system.

In terms of the research question that is related to energy-efficiency and safety, the test drivers will drive in a vehicle with and without using the driving system. During the journeys, the fuel consumption as well as the mileage of the vehicle and the time of the violation against the traffic rules will be measured. Based on the obtained measurements, the energy-efficiency and safety of the driving behaviour will

be calculated and compared between the journeys, in which the driver drove with and without the driving system. This will allow the demonstration of an increase of the energy-efficiency and safety and, thus, to solve the related research question.

The user acceptance of the driving system will be measured with a questionnaire after the test drivers have driven with the adaptive feature of the driving system and without the adaptive feature. The results of the questionnaire will be compared to each other, in order to demonstrate an increase of the user acceptance when using the driving system with the adaptive feature.

1.4 Definition of energy-efficiency

Energy efficiency is nowadays omnipresent in politics, media and research as it is linked with benefits for example for the environment by reducing the CO² emissions and the economics by reducing the costs of the energy use [19]. But, what is energy-efficiency exactly? In the following the term energy-efficiency is explained. Furthermore, as the focus of this work is to increase the energy-efficiency of the car by improving the driving behaviour, the role of energy-efficiency in road transportation is also regarded.

1.4.1 Energy-efficiency in general

Energy-efficiency can be defined in general as using less energy in a process to produce the same amount of useful output such as a product or a service. Thus, energy-efficiency is not energy conservation that saves energy by reducing or abandoning a service or a product. For example, switching off a light is energy conservation, whereas replacing the bulb of the light with an LED bulb, which uses less energy for the same brightness, would be energy-efficiency. According to [19] energy-efficiency is broadly defined by the ratio:

$$\text{Energy-efficiency} = \frac{\text{Useful output of a process}}{\text{Energy input into a process}} \quad (1.1)$$

Where the output of a process can be an energy output, a physically defined output (i.e. a tonne of a product) or an enumerated output such as market prices. The energy input into a process is declared as the unit Joule. Joule is the unit for energy, work or amount of heat in the International Systems of Units (SI).

1.4.2 Energy-efficiency in road transportation

The needed energy in road transportation is the kinetic energy. It is produced by converting the energy of an energy source into kinetic energy for example by combustion of fossil fuels within an engine. The dominating energy source in traffic is fossil fuel. Due to the emitted greenhouse gas by using fossil fuels, the achievement of the peak oil and correlating high costs of fossil fuels, the energy has to be used efficiently as possible [10]. In general, energy-efficiency in road transportation can be defined as the transportation of people or products as far as possible by using less energy. On the basis of the equation in 1.1 the energy-efficiency in road transportation can be defined as the following ratio:

$$\text{energy-efficiency in road transportation} = \frac{\text{Distance travelled}}{\text{Burned fossil fuel}} \quad (1.2)$$

According to Helms et al. [10] and the International Energy Agency [20], there are two opportunities to increase the energy-efficiency: on vehicle level and on system level. On vehicle level, the efficiency can be increased for example by increasing the efficiency of the engine or by improving the driving behaviour in terms of energy-efficient driving, which is the focus of this work. On system level, reducing the distances travelled per vehicle for example by doing business at home instead of travelling to the working place would increase the energy-efficiency. Furthermore, an increase in efficiency would also be reached on system level by shifting the travel to the most sustainable transportation means or by utilising the transportation means better.

1.5 Definition of safety

Safety on the road became an important factor in the last decades to politics and car manufacturers, due to increasing fatalities and accidents on the road. But, what is the meaning of the term safety in the context of the road? In the following the term safety is generally explained. Furthermore, as the focus of this work is to increase the safety on the road by improving the driving behaviour, the role of safety on the road is also regarded.

1.5.1 Safety in general

Safety is defined as the state when there are no unacceptable risks or no danger [21]. However, absolute safety can not be guaranteed in general. Thus, a relative safety or a tolerable risk are also sufficient to describe something as safe. Relative safety is the absence of danger for a certain time, under certain conditions and in a certain environment. In addition, safety is also reached when the benefit of a thing is higher rated than the probability of the existence of danger. Relative safety can be described as the following ratio:

$$\text{Relative safety} = \frac{\text{Condition or environment}}{\text{Absence of danger}} \quad (1.3)$$

Where the condition or environment can be a certain process or task that is performed. The absence of danger is declared as the time, in which no danger is occurred during the performance of the process or task.

1.5.2 Safety on the road

According to the general definition of safety, safety on the road can be defined as the usage of the road by road users during the absence of casualties. Road users are for example pedestrians, drivers or passengers of cars, buses or trams. On the basis of the definition of relative safety in 1.3, road safety can be defined as the ratio:

$$\text{Road safety} = \frac{\text{Travelled distance}}{\text{Usage of the road without casualties}} \quad (1.4)$$

Where the travelled distance represents the distance that a road user is travelled either in kilometres or miles. The usage of the road without casualties is declared in the time unit. The term road safety considers methods and measures trying to reduce the number of road casualties [22]. As the focus of this work is to increase the safety by improving the driving behaviour, road safety is regarded in the following with the focus on the car as a road user.

Road safety can be separated in two aspects of safety: technical safety and safety training. Technical safety is used to increase the safety on the road by improving the road itself, the traffic routeing or the vehicle for example by improving the car body, adding driving assistants or safety systems to the car like the lane change assistant or the anti-lock braking system (ABS). In contrast to the technical safety, safety training tries to increase the road safety by educating the driver in safe driving for example during the driving school or in driver trainings after getting the driving license. During the driving school, computer applications or a driving simulator are used to teach safe driving besides the teaching of the theoretical part of the driving. Furthermore, the driving instructor gives feedback during the driving to the learner. After getting the driving license, there are driver trainings that try to educate the driver in defensive driving in order to make the driving behaviour safer. Other safety relevant driver trainings are focusing on a feedback by an instructor during driving and by discussing the driving behaviour in groups [23]. The education of the driver by giving a feedback to the driver in terms of safety is also the focus of this work.

1.6 Thesis Outline

In the next chapter the related work of existing driving systems and developed driving rules for energy-efficient and safe driving will be presented. Chapter 3 explains the goals and the architecture of the driving systems. Furthermore, the driving rules, used in the driving system to detect an energy-inefficient or unsafe driving behaviour, as well as the driving profile, which is used to adapt the driving system to the individual driving behaviour, are also explained in this chapter. Finally, Chapter 3 presents the interface that is used to gather information from the car and algorithms that are used to aggregate the gathered information and to update the driving profile. Different prediction algorithms for predicting the car state are evaluated and the results

presented in Chapter 4. The detection of broken driving rules or deviations from the typical driving behaviour using an improved rule matching algorithm is explained in Chapter 5. Additionally, different rule matching algorithms are explained and their performance are evaluated. The results of the rule matching algorithm evaluation are also presented in Chapter 5. The decision process to show a recommendation while considering the driver condition and the individual driving behaviour is explained and evaluated in Chapter 6. Furthermore, the detection of the driver reaction to a shown recommendation is also described in Chapter 6 in detail. Based on the algorithms presented in the previous chapters, a prototype is developed, whose architecture is explained in Chapter 7. The evaluation set-up for evaluating the driving system as well as the architecture of the used driving simulator is described in Chapter 8. Chapter 9 presents the results of the driving system evaluation, which are discussed in Chapter 10. Finally, Chapter 11 and 12 concludes the findings of this thesis and explains the future work.

On the basis of the findings in the Chapters 4 - 9, several papers were published and are planned to be published. The following listing shows an excerpt of the published papers, a full list of papers can be found in Appendix A:

- E. Yay, N. Martnez Madrid, J. A. Ortega Ramrez. Influence of stress in driving behaviour, MEDICON 2016, Paphos, Cyprus, 2016.
- E. Yay, N. Martnez Madrid, J. A. Ortega Ramrez. Detecting the adherence of driving rules in an energy-efficient, safe and adaptive driving system, Expert Systems with Applications, Volume 47, Pages 58-70, ISSN 0957-4174, 2016.
- E. Yay, N. Martnez Madrid, J. A. Ortega Ramrez. Using an improved rule match algorithm in an expert system to detect broken driving rules for an energy-efficiency and safety relevant driving system, Procedia Computer Science, Volume 35, Pages 127-136, ISSN 1877-0509, 2014.
- E. Yay, N. Martnez Madrid. An adaptive driving system regarding energy-efficiency and safety, AITA - Workshop on Ambient Intelligence for Telemedicine and Automotive domains, ISBN 978-84-697-0147-8, Seville, Spain, 2014.
- E. Yay and N. Martnez Madrid. SEEDrive - An Adaptive and Rule Based Driving System, The 9th International Conference on Intelligent Environments - IE'13, ISBN 978-0-7695-5038-1, Athens, Greece, 2013.

- E. Yay and N. Martnez Madrid. A new driving system towards energy-efficient and safe driving behaviour, Proceedings of the Tenth Workshop on Intelligent Solutions in Embedded Systems (WISES), ISBN 978-1-4673-2464-9, Klagenfurt, Austria, 2012.

Chapter 2

Driving rules and driving systems

In the first two parts of this chapter, an overview over the driving rules are given that are used to increase the driving behaviour in terms of energy-efficiency and safety. Next, existing driving systems are presented, whose goal is to increase the energy-efficiency or safety of the vehicle or to optimise the driving behaviour in terms of energy-efficiency or safety. Finally, an overview over the existing driving systems is given as well as possible improvements of the driving systems are discussed that would allow to increase the energy-efficiency or safety of the driving behaviour and the acceptance of the driving systems.

2.1 Driving rules for energy-efficiency

The goal of an energy-efficient and safe driving behaviour is to reduce the demand of energy of the car and to increase the safety on the road by changing the habits of the driver. In order to achieve this goal, the cooperation of the driver is needed, as the driver has to adhere the driving rules for energy-efficient or safe driving. An energy-efficient and safe driving behaviour is described by a set of rules. According to Barkenbus [14] an energy-efficient driving behaviour involves such things as smooth acceleration, anticipating to the traffic flow and signals, avoiding sudden starts and stops, driving below the speed limit, maintaining an even pace and eliminating excessive idling. Another definition of an energy-efficient driving behaviour has been done by the European Union (EU) in their ECODRIVEN campaign [24], which had the goal to distribute an energy-efficient driving behaviour in Europe in order to reduce the CO² emissions. The ECODRIVEN campaign was conducted between the years

2006 and 2008. Besides driver trainings for energy-efficient driving, the ECODRIVEN campaign presented eco driving activities to drivers in their social environment, so that the drivers were engaged to reflect on and to optimise their driving behaviour in energy-efficiency and safety. The ECODRIVEN project avoided 1 Mton CO² emission between 2006 and 2010 [24]. The following driving rules define an energy-efficient driving behaviour in the ECODRIVEN campaign and, thus, were presented to the drivers:

- Shift into a higher gear as soon as possible at the latest at 2500 revolutions per minute (rpm), for diesel cars before 2000 rpm
- Maintain a steady speed using the highest possible gear
- Look ahead and anticipate to the traffic flow
- Decelerate smoothly by releasing the accelerator while the car is in gear
- Avoid high speeds above 80 or 90 km/h
- Switch the engine off when it is planned to idle longer than one minute

The presented energy-efficient driving rules were also part of the dutch eco driving programme [25] started in 1999. It had the goal to reduce the CO² emissions by educating drivers in terms of energy-efficient driving. The teaching of the energy-efficient driving behaviour took place for example in driving schools for new drivers and in driving trainings for existing drivers. Van den Hoed et al. [26] analysed the success of the dutch eco driving programme during the years 2000 and 2004. For example, they assessed through annual telephone surveys, which eco driving recommendation was applied by existing drivers. The result of the telephone surveys was that 90 % of the drivers were familiar with the eco driving programme and applied some (74 % - 83 %) or a lot (10 % - 22 %) of the driving recommendations. Furthermore, van den Hoed et al. observed an increase of the percentage of drivers that apply the eco driving recommendations a lot. The net impact of the dutch eco driving programme resulted in the increase of the avoidance of CO² emissions from 9 kton - 41 kton in the year 2000 to 97 kton - 222 kton in 2004. Furthermore, van den Hoed et al. showed that the dutch eco driving programme increased also the cost efficiency for society, government and end-users as a result of the avoided CO² emissions and the saved fuel.

Van Mierlo et al. [11] evaluated three driving rules, which are also part of the dutch eco driving programme, to measure the energy savings during their application. Therefore, they monitored the driving data of 24 test drivers during the practice of the following driving rules:

1. Shift as soon as possible to keep the engine speed low
2. Press the throttle quickly and vigorously to keep up with the traffic
3. Shift down as late as possible to a lower gear to keep the car rolling without engaging the clutch.

The results of the evaluation showed a reduction in energy consumption from 5 % to 25 % and, thus, a reduction of the vehicle emissions, when the driver adhered the driving rules and interpreted them correctly. However, some drivers had problems to apply the rules 2 and 3 as they were to contradictory to them. Thus, they ignored driving rule 2. The study did not reflect a direct relation between the application of driving rule 2 and the reaction of the energy consumption. However, the misinterpretation of the driving rules led to an increase of the energy consumption. Thus, as the drivers had problems by the interpretation of the second driving rule and a misinterpretation leads to an increase of the fuel consumption, Van Mierlo et al. recommend to withdraw driving rule 2 from the eco driving recommendations. Another positive effect of the adherence of the driving rules was a reduced driving speed. According to the International Transportation Forum [27] and Haworth and Symmons [9], a reduced driving speed leads to an increase of safety on the road, as driving at low speeds increases the time for drivers to react appropriate in a dangerous situation, lowers the braking distance and increases the probability to avoid collisions. In general, a reduction of 1 km/h of the average speed can lead to a reduction of 2 % - 3 % in accidents with personal damage.

2.2 Driving rules for safety

Besides the driving rules for energy-efficiency, there are also driving rules that prevent an aggressive driving behaviour and, thus, increase the road safety. According to the United Nations Economic Commission for Europe (UNECE) [28] an aggressive driving

behaviour includes speeding or driving too close to the car in front. Speeding and driving too close to the preceding car are also indirect or direct linked as the most causes of accidents with personal injury [29]. Thus, the main focus of the Organisation for Economic Co-Operation and Development (OECD) is the decreasing of the driving speed by for example encouraging the public to drive safe using driver trainings or setting incentives for a good, respectively a safe, driving behaviour.

Kloeden et al. [30] quantified the relationship between free travelling speed and the risk of involvement in an accident in 80 km/h or greater speed limit zones. They investigated 83 passenger vehicles involved in an accident at the scene and reconstructed the accidents. In the second step, they matched the reconstructed information from the accidents, like location, direction of travel, time of day and day of week and speed, against 830 control passenger vehicles, which they observed. Kloeden et al. showed that the risk of involvement in an accident increases more than exponentially when the travelling speed is above the mean traffic speed. In contrast, travelling speeds below the mean traffic speed were associated with a lower accident risk. According to their findings, Kloeden et al. recommend to reduce the speed limits to increase the road safety.

The reduction of speed limits are also appreciated by Taylor et al. [31], who showed in their study that higher speeds mean more accidents. They provided a clear evidence of that fact using two studies: a road-based study and a driver-based study. During the road-based study Taylor et al. studied sections of roads between major junctions. During that study, the speeds of about 2 billion vehicles were measured together with the traffic and pedestrian flows and the details of the road layout. The number of accidents with personal injury were obtained from national records. On the basis of the gathered information, relationships were developed to predict the number of accidents with personal injury. During the driver-based study Taylor et al. collected information about the driving speed and the personal characteristics of the driver. This information was then related to the accident history of the driver to quantify the association between the choice of speed and the personal characteristics and between the accident involvement, the personal characteristics and the choice of speed. Finally, the collected data from the road-based and driver-based study was explored in their relationship to each other. Taylor et al. figured out, besides the correlation of higher speeds with a higher accidents frequency, that a reduction of 1 mile per hour in the average speed reduces the accident frequency about 2 % - 7 %.

The European Commission tried in their 3rd Road Safety Action Programme [32] to improve the road safety, besides the driver training programmes, additionally by altering the infrastructure, for example by building roads that influence the drivers in their choice of speed. With the help of the 3rd Road Safety Action Programme of the European Commission, which was released in 2003, the member countries of the EU decreased the road fatalities until the year 2009 by about 36 % [32].

Besides driving speed and driving too close to the car in front, there are also other safety issues like distraction and fatigue that can lead to accidents. McEnvoy et al. [33] showed in their study that the usage of mobile phones distracts the driver and, thus, leads to accidents.

This has been also verified by Wilson and Stimpson [34], who analysed the recorded data of all road accidents with personal injury in the USA in 2008. The study showed that 39 % of the accidents happened because of distraction caused by mobile phone usage. Furthermore, they showed that the accidents related to mobile phone usage increasingly involved male drivers driving alone in urban areas. According to their findings Wilson and Stimpson recommend to ban the mobile phone usage while driving.

McEnvoy et al.[33] compared in their study the mobile phone usage of 456 drivers at the estimated time of a crash with the same drivers during another trip, which was at the same time of day in the week before the crash. They gathered the information about the mobile phone usage by interviewing the drivers at the hospital and by collecting the information from the phone company's records of phone use. On the basis of the comparison McEnvoy et al. associated the usage of the mobile phone up to 10 minutes before the crash with an fourfold increase of the risk to have an accident. Furthermore, they showed that the risk to have an accident was independent of using a hands-free device or of hand-held mobile phones during the driving. According to the study of the European Commission [35] other devices, besides the mobile phone, like music players or TV/DVD players are also distracting the driver so that they for example do not notice signs.

Fatigue or sleep is according to Sagberg [36] a factor in 3.9 % of the accidents. The study of Sagberg based on a questionnaire of 9200 accident-involved drivers, in which they reported whether or not they have fallen asleep whilst driving and the resulting consequences. The analysis of the questionnaire also showed that the most accidents

relating to sleep or fatigue happened in the night-time. The most accidents because of falling asleep or fatigue was to run off the road, whereby the drivers often run off the right edge-line. According to the results, the proportion of falling asleep is about 2.5 times higher for male drivers than for female drivers. To avoid accidents related to sleep or fatigue, Sagberg recommends to use information systems, which produce low mental workload, or rumble strips on the road to keep the driver attentive.

The OECD [29] and the UNECE [28] derived rules for a safe driving behaviour from the causes of accidents with personal injury. The New Zealand Transportation Agency [37] considers additionally the avoidance of distraction and fatigue in their safety relevant driving rules.

In the following the driving rules are listed, which are used by the OECD, UNECE and the New Zealand Transport Agency to define a safe driving behaviour:

- Keep enough distance to the preceding car (minimum distance to the car in front is equivalent to distance travelled by a vehicle in two seconds or half the speed in meters)
- Look ahead and anticipate to surrounding traffic
- Adapt your speed to the given situation and don not exceed the speed limit
- Avoid any distractions (i.e. do not use the mobile phone during driving)
- Fitness to drive must be given (i.e. no alcohol, no fatigue, and so on)

Several countries, like Germany, included some of the driving rules into their road traffic regulations, such as the guideline for the minimum distance to the preceding car [38], which is in Germany defined as the drivers must be able to stop in time if a car in front brakes, or the ban of hand-held mobile phones during driving [39], as they highly distract the driver [34].

2.3 Driving systems

There are already driving systems trying to improve the driving behaviour of the driver in terms of energy-efficiency or safety. The driving system called ANESA [40] has the goal to reduce the energy consumption of the vehicle through free-wheeling.

Therefore, ANESA gives precisely timed driving hints to reach a velocity sign without the need of using the brakes. Thus, the energy loss of braking is avoided. In order to give a driving hint, ANESA analyses the driving characteristics of the car, the height profile of the road and their velocity restrictions. The characteristics of the car contained information about the wheel drag, aerodynamic drag and gradient drag. A navigation map is used to get the information about the height profile and the velocity restrictions of the road. On the basis of these information ANESA calculates the point when a free-wheeling hint should be given in order to reach a velocity sign with the correct speed. For the evaluation of the driving system a driving simulator was used, which contained a 10 minute track. 72 test runs were made on the driving simulator with 18 randomly chosen drivers. The drivers had to drive the track as usual, as energy-efficient as possible using their own skills and using ANESA. The results of the test runs showed that the drivers can save energy of about 13 % using ANESA in comparison to no assistance. If the drivers already attempted to save energy, ANESA additionally saves energy of about 8 %. However, some drivers had problems to apply the given instructions, as ANESA has given the free-wheeling hints too late for them. Furthermore, free-wheeling is only one aspect of energy-efficient driving, thus the energy savings could be increased more when considering also other aspects that describe an energy-efficient driving behaviour defined by Barkenbus [14] or the EU in their ECODRIVEN campaign [24].

Another driving system [41], called Artemisa, is developed by Corcoba and Muñoz. It is based on the interaction between the mobile phone and the car. The focus of the driving system is the education of the driver in eco driving by giving recommendations to eliminate bad driving habits. The recommendations of the driving system consider also the environmental influences on the car, like the weather or road condition. As the driving system runs on a mobile device the needed information from the car is gathered using its diagnostics port, whereas environmental information is collected using the internet connection of the mobile phone. On the basis of the collected information the preprocessing module calculates every ten minutes the arithmetic mean for the collected values of a specific information, in case the value of the information is numeric. Otherwise, the preprocessing module chooses the most frequent value of an information. In the next step the expert system classifies the result of the preprocessing module obtaining the eco driving recommendations. Each recommendation has a probability that is assigned by the classifier. A high recommendation probability



Figure 2.1: Kia's driving system is using a coloured lamp to indicate the energy-efficiency of the driving behaviour [16]

indicates a higher probability that the driver does not apply the driving recommendation, why a recommendation to the driver is given again. However, the driving system does not adapt itself to the individual driving behaviour and, thus, shows the recommendations even when the driver is not interested in that recommendation. Furthermore, it does not monitor the vital signals of the driver, for example to detect the driver stress level, which can be used to suppress recommendations in order not to stress the driver in stressful driving situations. Additionally, the driving system of Corcoba and Muñoz uses a internet connection for gathering additional information like the weather information. However, the internet connection may not be stable enough during the journey to gather the needed information from the internet.

There are also commercial driving systems trying to improve the driving behaviour in terms of energy-efficiency. The driving system of Kia [16] indicates an energy-efficient driving behaviour using a lamp, which can be coloured green, red or white. Figure 2.1 shows the driving system with a white coloured lamp. The driving system analyses the driving behaviour according to five energy-efficient relevant driving rules, which are listed in the following:

- Avoid speeding and drive at constant speed
- Shift as soon as possible
- Avoid sharp acceleration and sudden braking
- Check tire pressure
- Move with the traffic flow

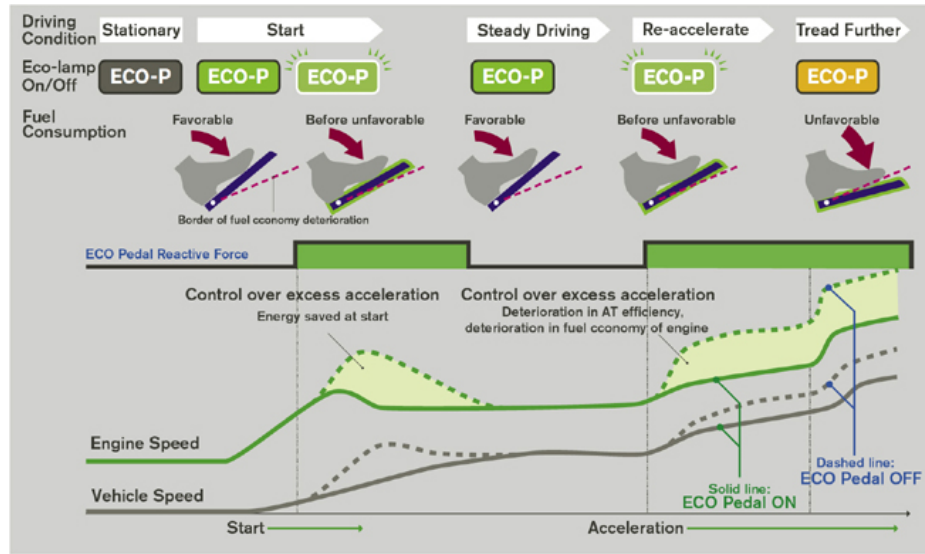

Figure 2.2: System configuration and the behaviour of the Nissan brake pedal [42]

The driving system of Kia activates a green lamp if the driver is driving energy-efficient and, thus, according to the listed driving rules. The red lamp indicates that the driver has broken a driving rule and is therefore driving energy-inefficient. A white lamp represents the stand-by of the driving system or a normal fuel consumption of the car. Kia evaluated the driving system in a eco-driving event with 100 test drivers on a 7 km route. During the evaluation the drivers had to drive first using their usual driving behaviour. After getting instructions from a trainer how to drive energy-efficient the drivers had to drive the 7 km route again while using the driving system of Kia. The result of the evaluation showed that during the journey, in which the driving system of Kia was used, the efficiency increased between 10 % - 20 %. However, the driving system of Kia does not show recommendations to the driver. Thus, if the driver has no previous knowledge of how to drive energy-efficient, the driver is not able to know why the driving system shows a red lamp and is not able to eliminate the bad driving habits that caused an inefficient driving behaviour.

The car manufacturer Nissan developed a driving system [42] to support eco-friendly driving habits by using a pedal that monitors the pressure on the accelerator. The driving system shows a warning on the dashboard and activates a push-back mechanism of the pedal, if the driver is pressing too hard the accelerator, which means that more fuel is burned than needed. Furthermore, it calculates the optimal accelerator pressure on the basis of the fuel consumption of the car and the transmission efficiency during acceleration and cruising. In Figure 2.2 the behaviour of the driving



Figure 2.3: Eco:Index report of Fiat’s driving system [15]

system and the saved energy in different phases are shown. The Eco-Lamp of the driving system reacts dependent on the pedal position. The Eco-Lamp indicates by blinking when the driver is shortly before the optimal pedal position or by showing an orange lamp when the driver pushed the pedal too hard. During the blinking of the Eco-Lamp or when it is orange, the push-back mechanism of the pedal is activated in order to make the driver to release the accelerator. Figure 2.2 shows the engine and vehicle speeds avoided by the activation of the push-back mechanism during the start and acceleration phases. According to Nissan it is possible to improve the energy-efficiency between 5 % - 10 % when using the driving system with the push-back mechanism and the Eco-Lamp. However, the driving system considers, like the driving system ANESA, only one aspect of an energy-efficient driving behaviour.

In contrast to the driving systems of Kia and Nissan, the driving system eco:Drive of the car manufacturer Fiat [15] has a different approach to improve the energy-efficient driving behaviour. Instead of improving the driving behaviour using a lamp or a push-back accelerator pedal, eco:Drive collects telemetric information during the journey, like speed or rpm, about the current driving behaviour from the car network and saves the information on a flash pen. The insertion of the flash pen into a computer allows the servers of Fiat to analyse the driving behaviour in terms of energy-efficiency, which is defined in the case of the driving system as steady acceler-

ation, steady deceleration, early gear changes and constant speed. Figure 2.3 shows the eco:Index that is generated on the basis of the driving behaviour analysis. It indicates the energy-efficiency of the journey and is based on a star rating of the energy-efficiency indicators like steady acceleration or constant speed. Additionally, the driver has the opportunity to see the past eco:Index and to get hints how to improve their performance on each energy-efficiency indicator. Furthermore, the driving system shows the driver how much CO² emissions and fuel costs was saved using an energy-efficient driving behaviour and the number users who uses eco:Drive in their online community eco:Ville. Fiat analysed the eco:Index of the drivers over a 30-day period to measure the improvements of the drivers. The result of the analysis showed that drivers improved their eco:Index, respectively their driving behaviour, by an average of 2.25 % and, thus, decreased the fuel consumption by an average of 5.84 %, which saved fuel costs and CO² emissions. However, the driving system does not show recommendations during the journey. This would allow the improvement of the driving behaviour in terms of energy-efficiency by alerting human errors and, thus, would give the driver the opportunity to eliminate immediately bad driving habits that caused the inefficient driving.

Besides the driving systems whose goal is to improve the driving behaviour in terms of energy-efficiency, there are also driving systems with the focus on improving the road safety. The driving system DAISY [43] tries to increase the road safety by warning the driver in longitudinal and lateral control, especially when the driver is in driving situations, which are susceptible for distractions. Therefore, DAISY monitors the current driving situation including the driving behaviour and the condition of the driver. On the basis of this information warning messages are generated, which are adapted to the individual driving behaviour and are displayed on a haptic display, which has the advantages that the driver gets less mental load, has possibly a shorter reaction time and other passengers will not get aware of the warning message. The haptic warning messages primarily consists of a continuous torque signal on the driving wheel. To distinguish the torque signal from other torque stimuli, which can be caused for example from road impacts, a vibration signal is superimposed. Onken evaluated the driving system using twelve test persons who had to do nine test runs, in which the car was accelerated until a constant speed of 60 km/h was reached. The test runs were separated in three test blocks. The first block consisted of four test runs in order to test the adaptation of DAISY to the individual driving behaviour. Therefore, the drivers had to do three test runs without DAISY to collect data for

the adaptation algorithm and one test run with DAISY. The second block consisted of two test runs in order to evaluate the recognisability of the warning torque signal. During the last test block two runs were conducted in order to test the effect of the warning mechanism with respect to safety. The test persons were driving once with DAISY and once without, while they were distracted. The result of the evaluation showed that 92.8 % of the test persons interpreted the warning torque signal correctly. Thus, DAISY enhances safety in driving situations, which are susceptible for distractions. However, DAISY has the focus on warning the driver when a dangerous driving situation is detected without regarding the possible bad driving habits that caused the dangerous situation, like a mobile phone usage during the journey. Thus, the driver is not able to eliminate these bad driving habits and, thus, the driver is not able to improve the driving behaviour in terms of safety.

The driving system of Risack et al. [44] has the focus on increasing the safety by warning the driver with an acoustic signal in case of an unintended lane departure. The driving system is based on an video-based lane detection algorithm and considers the driving behaviour during the generation of the warnings to be able to distinguish between unintended and intended lane departures. An intended lane departure is detected by the driving system when the driver announces a lane departure by using the blinker, when an emergency manoeuvres is detected by high steering and brake activities and when the car leaves the lane partly for a short time for example when cutting a curve. Furthermore, the driving system suppresses lane departure warnings in order not to disturb the driver when an high steering activity is detected or when the driver brakes, as the driver is already aware of some driving situation. Risack et al. evaluated the driving system on several journeys of about 500km using motorways and ordinary roads. The result showed that the drivers accepted the warnings when leaving the lane, as no false warnings were generated by the driving system. However, wrong warnings were showed by the driving system when cutting a curve. The driving system of Risack et al. shows only warnings to the driver instead of regarding why the driver has departed the lane unintentionally. Furthermore, the driving system considers only the usage of the blinker, the brake and the steering activity to detect an emergency manoeuvre. The detection of such an manoeuvre could be improved for example by using additionally vital signals of the driver like the driver stress level, as the stress level may rise in a dangerous situation, in which the driver is forced to do an emergency manoeuvre.

Another driving system was presented by Milanés et al. [45]. It warns the driver when an impending rear-end collision is detected in order to prevent the crash. Furthermore, the driving system is able to generate control signals for the steering wheel in order to avoid the collision automatically. Therefore, the driving system uses the radar of the adaptive cruise control (ACC) system to monitor the time to collision, which is the time, in which the cars would collide at their current speed, and the time gap, which is the time it would take to trail the car to cover the current distance to the leading car. The driving system contains two control systems. One for the detection of a possible collisions on the basis of the time to collision and time gap parameters and the second for avoiding the collision. If the first control system detects a possible collision, it shows a collision warning to the driver and activates the second control system, which then starts to calculate the aid manoeuvre without leaving the road based on the position of the surrounding cars. The positions of the surrounding cars are gathered using the Global Positioning System (GPS) and is transmitted to the driving system by using car to infrastructure or car to car communication. The evaluation of the driving system was done in a driving circuit using a street with a length of about 200 meters. Two cars were used for the trials, while one car is equipped with the driving system. During the evaluation it was assumed, that the adjacent lanes were free, so that the driving system is able to avoid the crash using the adjacent lanes. In the first trial, the cars drove at the same lane while the speed of the leading car was first greater than the trailing car. Then the trailing car increased the speed in order to force a crash. In the second trial the leading car suddenly braked so that a crash was forced. In both trials the driving system of the trailing car avoided the crashes by warning the driver and steering the car to the side lane. However, the driving system of Milanés et al. does not consider the possible bad driving habits of the driver that caused the driving system to avoid the crash. This would allow the driver to eliminate the bad driving habits and, thus, to drive safer even in a car that has no a driving system for crash avoidance.

In contrast to the already presented safety relevant driving systems whose goal is to warn the driver in dangerous situations, there are also driving systems trying to educate the driver in safe driving like DriveDiagnostics [17]. The driving system shows recommendations to the driver to prevent an aggressive driving behaviour or when the current driving behaviour does not match the typical driving behaviour of the driver in order to improve the driving behaviour in terms of safety. DriveDiagnostics monitors and analyses therefore the driving behaviour of the driver during the journey

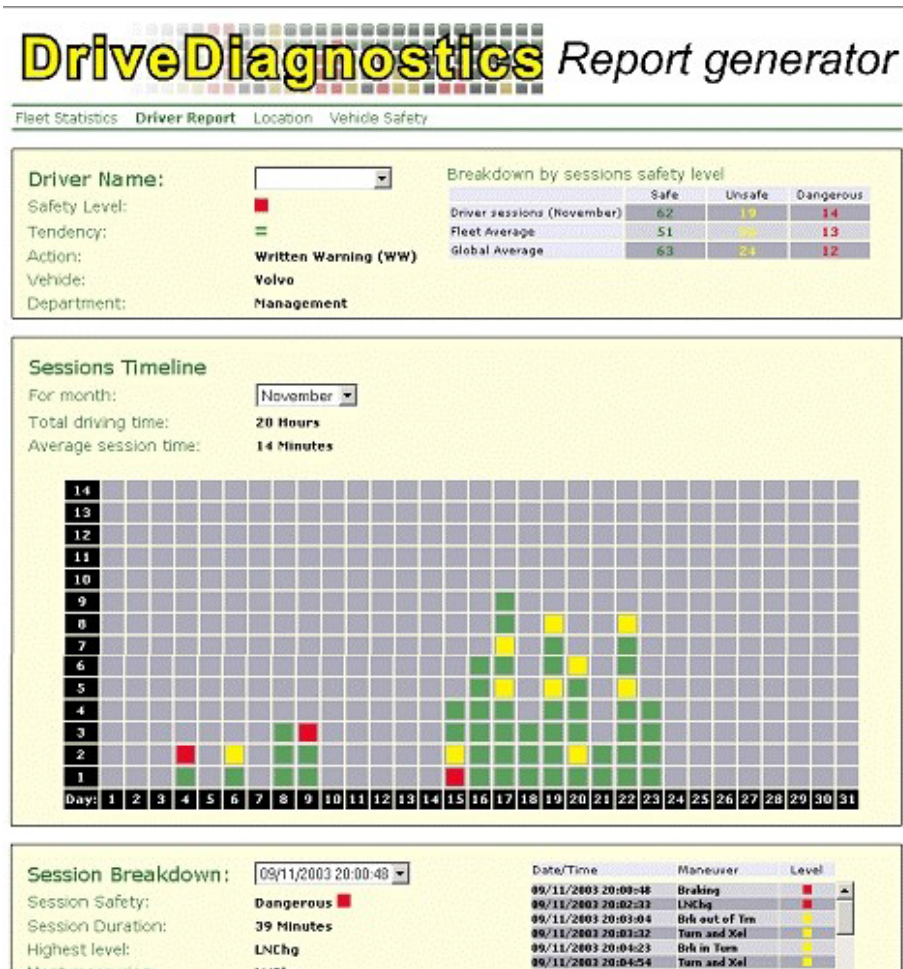

Figure 2.4: An example of a monthly report, which shows the journey safety [17]

by collecting information about the acceleration and speed of the vehicle as well as the position of the car using the GPS module of the navigation system. On the basis of the collected information the driving system identifies different manoeuvre types such as lane changes, sudden breaks, strong accelerations, excessive speed and so on. The identified manoeuvre types are used to create an overall driving risk index for the specific trip and for the overall vehicle performance. Furthermore, a driving profile is generated based on the rate and severity of the detected manoeuvres and the speed profile of the driver. DriveDiagnostics classifies the driving behaviour on the basis of the generated driving profile in three categories, which are cautious, moderate and aggressive. The driving system creates reports over the trip safety, as shown in Figure 2.4, using the driving profile as well as the detected manoeuvres. The recorded trips are classified using the colours green, yellow and red, which stand for a cautious, moderate and aggressive driving behaviour during the journey. Besides the generated

reports DriveDiagnostics also provides a real-time feedback that includes warnings on aggressive driving behaviour or significant deviations from the typical driving behaviour. The warnings are presented to the drivers as a text message or using the in-vehicle display unit. The evaluation of the driving system was done during 5 months using 33 test drivers in two stages: the blind-profiling stage and the feedback stage. During the blind-profiling stage the drivers were monitored by the driving system without the notice of the drivers. In the second stage the drivers received access to the reports of the driving system, which were generated on the basis of the collected information during the blind-profiling stage. Furthermore, more reports were generated as the drivers used the driving system further. The real-time feedback was not used in the evaluation. The result of the evaluation showed that the driving system has an impact on the driving behaviour as the driving risk indices dropped in the first month, in which the feedback using the reports was provided. This effect continued constant for three months. However, in the 5th month the driving risk indices were back to the initial values. According to Lotan and Toledo, this suggests that the initial impact of the system is significant, however it decreases over time without routine follow-up or maintenance efforts. The driving system of Lotan and Toledo could be improved by observing additionally the driver condition in order to increase the road safety further. The observation of the driver condition would allow the driving system to recognise for example drowsiness by using tracking systems [46] or vital sensors [47]. Thus, the driving system could give adequate recommendations to avoid dangerous situations caused by the driver condition.

2.4 Discussion

There are already attempts to decrease the energy consumption and, thus, the CO² emissions of the vehicles by providing for example driver training programmes for energy-efficient driving like the ECODRIVEN campaign of the EU or the dutch eco driving programme, which had both success in saving energy and CO² emissions. Therefore, the EU and the Dutch Ministry of Transport defined driving rules that describe an energy-efficient driving, which were used as the basis for the education of the drivers in terms of energy-efficiency. Van Mierlo et al. [11] evaluated three driving rules, which are part of the ECODRIVEN campaign and the dutch eco driving pro-

gramme. As a consequence of the findings van Mierlo et al. recommend to withdraw the driving rule "accelerate rigorously to keep up with the traffic" as its application confuses the drivers and, thus, hinders the driver to drive energy-efficient.

Another positive effect of an energy-efficient driving behaviour is the increasing of the road safety as it prevents an aggressive driving behaviour [27, 9]. The UNECE considers excessive speeding and an inappropriate distance to the car in front, which also describe an aggressive driving behaviour, as the main problem for road safety. Also the OECD [29] sees speeding and less distance to the car in front as the main problem in road safety. According to Kloeden [30] and Taylor [31] the risk of getting involved in an accident and the frequency of accidents rises when the speed of the car increases. Therefore, the European Commission tries to increase the road safety, additionally to driver safety trainings, by modifying the course of the roads so that the drivers are forced to drive slow. Besides the car speed, the distraction, for example by using hand-held mobile phones during driving, or fatigue are also factors that can lead to accidents. Thus, Germany, amongst others, prohibited to use hand-held mobile phones during driving. In order to avoid accidents caused by fatigue Sagberg [36] recommends to use driving systems that warn the driver when a dangerous situation occurs. On the basis of the findings and the accident causes the EU, OECD and the New Zealand Transport Agency defined driving rules for a safe driving behaviour, which are also used as the basis for driver safety trainings.

However, driver trainings and road modifications are limited as road modifications are not always possible as they are for example expensive or the needed space for the modification is not available. Driver trainings to improve the driving behaviour in terms of energy-efficiency or safety are efficient in the beginning. However, after a certain time has passed since the driver training, the drivers revert back to their old driving behaviour and, thus, do not drive energy-efficient or safe. Lotan and Toledo showed this in their evaluation, in which the test drivers reverted back to their old driving behaviour after stopping to use their driving system [17]. Furthermore, driver trainings are often expensive, not always available in all areas, the available places are limited or some driver trainings are limited to professional drivers only. However, there is the opportunity to improve the driving behaviour in terms of energy-efficiency or safety by using for example driving systems.

Driving system	Safety	Energy-efficiency	Realtime feedback	Offline feedback	Adaptation to driving behaviour	Considering driver condition
Kia	x	o	o	x	x	x
Fiat	x	o	x	+	x	x
Nissan	x	o	o	x	x	x
DriveDiagnostics	+	x	+	+	x	x
DAISY	o	x	o	x	x	x
ANESA	x	o	o	x	x	x
Artemisa	x	+	+	x	x	x
Risack et al.	o	x	o	x	x	x
Milanés et al.	o	x	o	x	x	x

+ good o medium x n/a

Table 2.1: The available energy-efficiency or safety related driving systems rated regarding their different features

As shown in Table 2.1, there are already driving systems available that give recommendations or warnings during the journey to improve the driving behaviour in terms of energy-efficiency or safety. However, the current available driving systems cover either the area of energy-efficiency or safety. Furthermore, some presented driving systems cover only one aspect of the energy-efficient or safe driving, like ANESA [40] or the driving systems of Nissan [42], Risack et al. [44] and Milanés et al. [45]. The energy-efficiency or road safety could be increased more by considering all aspects of energy-efficient or safe driving. Furthermore, there are also driving systems that do not show recommendations to the driver, like the driving systems of Kia [16], Nissan [42] or Onken [43], also called DAISY. Instead, they are using lamps to indicate an inefficient driving behaviour or show warnings in a dangerous driving situation. However, showing a recommendation to the driver would allow the driver to eliminate bad driving habits that caused an inefficient or unsafe driving behaviour. The driving systems that show a recommendation to the driver, like the driving systems of Lotan and Toledo (DriveDiagnostics) [17] or Corcoba and Muñoz (Artemisa) [41], do not adapt itself to the individual driving behaviour or consider the driver condition. The adaptation to the individual driving behaviour would allow the driving systems for example to show only recommendations that do not bother to the driver by suppressing recommendations that are not necessary in the sense of the driver and, thus, are not followed by the driver. Whereas the consideration of the driver condition would allow the driving systems to avoid showing recommendations for example in stressful driving situations or when a dangerous driver condition is recognised. This

would increase the acceptance of the driving system as well as the energy-efficiency and road safety, as the driving systems would consider the influence of the individual driving behaviour and the driver condition while decreasing the energy consumption and increasing the road safety.

Chapter 3

Driving system

This chapter starts with the description of the goal of the driving system and continues to explain the cycle of the driving system. The cycle needs to be passed to show an energy-efficient or safety related recommendation to the driver. The driving rules are also introduced in this chapter. They are used in the driving system for the detection of an inefficient or unsafe driving behaviour and, thus, for the creation of a recommendation. Furthermore, the driving profile is described in detail. It represents the typical driving behaviour and stores recommendations that consist of information for example about the driver reaction to already given recommendations. Finally, the architecture of the driving system is presented and the interface, data aggregation and the profile update module are explained.

3.1 Goal of the driving system

The goal of the adaptive and rule-based driving system is to educate the driver in energy-efficient and safe driving. Therefore, the driving system is giving individual recommendations during the journey to the driver, as there is a lack of driving systems that cover the areas of energy-efficiency and safety. Furthermore, existing driving system, like the driving system of Kia [16], Fiat [15] or Lotan and Toledo [17], do not adapt itself to the individual driving behaviour and do not consider the driver condition. Instead, they show recommendations to the driver even when the driver is not interested or for example in stress. This can lead to a decrease of driving system acceptance, due to showing recommendations that are not relevant in the

sense of the driver. Furthermore, the road safety can be decreased for example in stressful driving situations, as the driving system additionally distracts the driver with recommendations in such situations.

The proposed driving system compares the driving behaviour against driving rules that describe an energy-efficient or safe driving behaviour in order to check whether the driver is driving energy-efficient or safe. On detection of an inefficient or unsafe driving behaviour the driving system shows a recommendation to the driver that tries to improve the driving behaviour in terms of energy-efficiency and safety. Furthermore, the driving system adapts itself to the individual driving behaviour by customising the recommendations on the basis of the driver reaction to already given reactions and considers the driver condition. For example, the driving system creates no recommendations when the driver is in stress and decreases the generation frequency of a recommendation when the driver ignores a recommendation repeatedly. This allows decreasing the driver mental load for example by giving no recommendations to the driver in stressful driving situations, as a high mental load can lead to accidents [18]. Furthermore, the reduction of generation frequency allows the driving system to increase its acceptance, as only recommendations are shown that are important in the mind of the driver. Another recommendation is shown to the driver when the current driving behaviour of the driver alters significantly in a negative way from the typical driving behaviour. Thus, the driving system is able to warn the driver in order to avoid a worsen of the driving behaviour regarding the energy-efficiency and safety. Furthermore, the driving system predicts the driving behaviour of the driver. This allows to show a recommendation to the driver before a breaking of a driving rule or deviation from the typical driving behaviour occur.

3.2 Cycle of the driving system

According to the described idea of the driving system, four main tasks of the driving system are determined: monitoring of the current driving situation, profiling of the driver, checking the driving system, deciding and showing a recommendation. Figure 3.1 shows the correlation between the tasks.

First, the current driving situation is monitored by gathering information from the car, the driver and the environment (1) by using the in-vehicle serial-bus systems, vital sensors and other sensors for gathering information about the environment, like

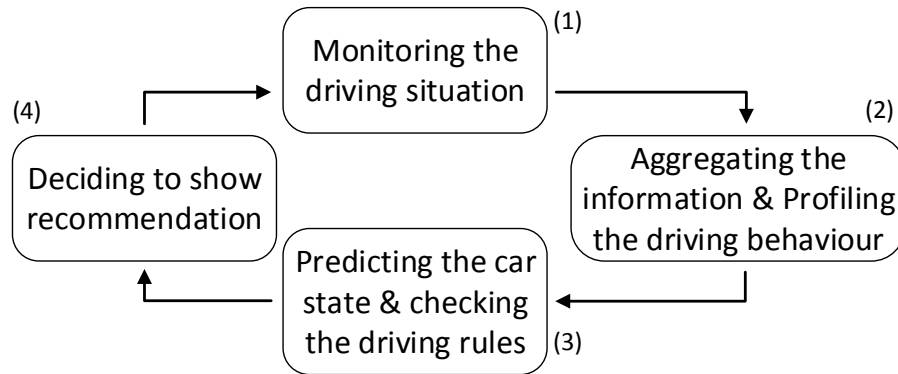

Figure 3.1: Cycle of the driving system

the weather. The collected information is then aggregated (2) in order to get more information out of it. Furthermore, the collected and aggregated information is used to generate or update a driving profile that describes the typical driving behaviour of the driver. After the aggregation of the collected information and the update of the driving profile, the collected and aggregated information is used to find any breaking of the energy-efficient and safety relevant driving rules (3). The collected information is also used to predict the vehicle state in order to allow an early detection of a driving rule breaking. Furthermore, the driving profile is compared against the current driving behaviour to indicate if the current driving behaviour deviates significantly from the typical driving behaviour. On recognition of any breaking of the driving rules or deviations from the typical driving behaviour, the driving system decides whether to show a recommendation or not (4). The decision is based on the individual driving behaviour of the driver and the driver condition. Thus, if the driver is for example in stress or ignores a recommendation repeatedly, no recommendation will be shown to the driver. This allows to prevent the driver from mentally over stimulation, as this can cause distraction and can lead to accidents [18]. Furthermore, by suppressing repeatedly ignored recommendations, the driving system is more likely to be accepted by the driver. However, in case the driving system decides to show a recommendation, the recommendation is rendered on the in-vehicle display unit and is additionally given to the driver by using a speech output.

3.3 Driving rules

As described in the idea of the driving system in Section 3.1, the current driving behaviour has to be compared against an energy-efficient and safe driving behaviour to be able to show a recommendation. As shown in Section 2, an energy-efficient and safe driving behaviour is described by a set of rules. These rules are compared against the current driving behaviour to detect an energy-inefficient and unsafe driving behaviour and, thus, to show a recommendation. However, not every driving rule is suited to be used in the driving system, as van Mierlo et al. [11] showed in their evaluation. For example the energy-efficient related driving rule "Press the throttle quickly and vigorously to keep up with the traffic" was too contradictory to the drivers why they applied the driving rules during the evaluation wrong. Thus, this rule will not be used in the driving system. The driving rules, including the parameters that are used in the driving system to detect an inefficient and unsafe driving behaviour, as well as the corresponding recommendations are listed in Table 3.1.

No.	Driving Rule	Parameter	Recommendation
1	Shift into a higher gear as soon as possible at the latest at 2500 revolutions per minute (rpm), for diesel cars before 2000 rpm	Rpm	Shift the gear
2	Maintain a steady speed using the highest possible gear	Car speed, gear	Drive steady
3	Look ahead and anticipate to the traffic flow	Distance to the car in front, car speed, future distance to the car in front, future speed	Increase the distance Increase the speed
4	Decelerate smoothly by releasing the accelerator while the car is in gear	brake pedal, deceleration force	Do not use the brake pedal to slow down
5	Avoid high speeds above 80 or 90 km/h	Car speed	Avoid driving faster than 90 km/h
6	Switch the engine off when it is planned to idle longer than one minute	Engine status	Turn off the engine
7	Keep enough distance to the preceding car	Distance to the car in front, car speed, road condition	Increase the distance
8	Look ahead and anticipate to surrounding traffic	Distance to the car in front, car speed, future distance to the car in front, future speed	Increase the distance Increase the speed
9	Adapt your speed to the given situation and do not exceed the speed limit	Car speed, speed limit, road condition, weather condition	Slow down your speed
10	Avoid any distractions (i.e. do not use the mobile phone during driving)	Distraction level	Keep your attention on the road
11	Fitness to drive must be given (i.e. no alcohol, no fatigue, and so on)	fatigue level, alcohol level	Have a rest, you are not able to drive

Table 3.1: The driving rules with parameters and corresponding recommendations

The energy-efficiency and safety relevant driving rules are fuzzy defined why the parameters of the driving rules have to be identified to be able to compare the driving rules against the driving behaviour. However, there are driving rules, like (1) or (2), that are exact defined. For these rules, the parameters, needed for the comparison, are derived from their definition. The driving rules without an exact definition of their parameters, like (3) or (7), were examined in order to detect the parameters.

A breaking of the driving rule (1) can be detected using the rpm of the car and the information if the car has a diesel or a gasoline engine. Using this information, the driving system should show the recommendation "shift the gear" when the driver is accelerating and the rpm is higher than 2500 rpm (for diesel cars 2000 rpm). Furthermore, a recommendation has to be shown when the driver keeps the rpm constantly higher than 2500 rpm. However, no recommendation should be shown to the driver when the rpm is higher than 2500 rpm and the current rpm rate is decreasing. This allows the driver to slow down using the engine braking without getting bothered by the driving system to shift the gear.

The parameters speed and gear are used to detect a steady speed using the highest gear (2). The recommendation to drive at steady speed should be given to the driver when the driver is driving in the highest gear without a steady speed, which means the speed of the car is varying as the driver accelerates and decelerates constantly.

The energy-efficiency relevant driving rule (3) and the safety relevant driving rule (8) have the same focus: to drive with foresight and to anticipate with the traffic flow. Thus, both were examined together in order to get the parameters for the detection of their adherence. First, the term "look ahead" while driving, which means to drive with foresight, used in the driving rules has to be defined. According to Stahl et al. [48] driving with foresight is defined as the identification of stereotypical traffic situations on a tactical level in order to solve a conflict before it occurs. In the case of the driving rules (3) and (8) the driver has to anticipate to the traffic flow/surrounding traffic, which means to accelerate to the cruising speed and to keep enough distance to the car in front. To keep enough distance to the car in front is also defined in driving rule (7), why adhering the driving rule (3) or (8) also leads to the adherence of the driving rule (7). To be able to drive with foresight, the driver has to perceive the distance to the car in front and the speed of the preceding car. This allows an early anticipation to the traffic flow/surrounding traffic. Thus, the parameters for the detection of the adherence of the driving rules (3) and (8) are the distance to

the car in front and the car speed, in order to detect the anticipation to the traffic flow/surrounding traffic. A recommendation to anticipate to the traffic should be shown to the driver when the speed of the car in front is much faster, however the car must be within the speed limit. Furthermore, another recommendation should be related to driving with foresight. Therefore, additional parameters like future speed and future distance to the car in front should be considered. They allow showing the driver recommendations that help him to adapt his driving behaviour early to the traffic flow/surrounding traffic. For example, when the driving system detects that the car in front will brake and, thus, the distance to the preceding car will decrease, a recommendation should be shown to the driver in order to keep the distance to the car in front.

The usage of the engine braking, instead of the brake pedal, is the purpose of driving rule (4). This driving rule allows to save fuel by using free-wheeling. In contrast to the driving system ANESA [40], the idea of the driving system is to show a recommendation to use the engine braking, instead of giving a hint when to release the accelerator, like ANESA does. The parameters that should be used by the driving system to detect the adherence of this rule are the brake pedal and the deceleration force. A recommendation not to use the brake pedal for slowing down should be given when the brake pedal is used and the deceleration force is low or medium. However, no recommendation should be shown when the driver is using the brake pedal and deceleration force is high, as it can be assumed that the driver has done an emergency braking to avoid an accident.

To keep the engine speed at lower rpm and, thus, to save fuel, driving speeds higher than 80 or 90 km/h should be avoided. Therefore, the car speed should be monitored and a recommendation to the driver should be given when the speed is higher than 90 km/h. This allows the adherence of the driving rule (5).

The last energy-efficient related driving rule tries to minimise the fuel usage by avoiding idling. According to the driving rule (6) idling longer than a minute should be avoided. Thus, the driving system should recommend after 30 seconds for the first time to shut off the engine in order to avoid idling longer than a minute.

The adherence of the energy-efficiency related driving rules has, according to Haworth and Symmons [9], also a positive effect on safety as it prevents aggressive and fast driving, which are the main causes of accidents. This has been also verified by

van Mierlo et al. [11] who observed an decrease of the driving speed during the application of energy-efficient driving rules. However, there is still the need of the safety relevant driving rules to prevent other dangerous driving situations.

The safety relevant driving rule (7) is related to keep enough distance to the preceding car in order to avoid an accident during sudden brakes of the car in front. According to the thumb rule, which is used in most countries like Germany, drivers should keep distance half of speed in metres to the car in front in rural roads or highways and a quarter of speed to the car in front in metres in urban areas [38]. This thumb rule was also confirmed by the German court, why it is used in the driving system to calculate the minimum distance to the car in front. However, the thumb rule is only valid on a dry road. The braking distance on wet, icy or snowy roads are longer than on a dry road, as the friction of the tyres on the road decreases when the road is wet, snowy or icy [49, 50]. Thus, the parameters used for detecting the adherence of the thumb rule are the car speed, the distance to the car in front and the road condition. A recommendation to increase the distance to the preceding car should be shown to the driver when the current distance to the car in front is not enough according to the thumb rule and the road condition. However, no recommendation should be shown to the driver when the current distance to the car in front is not enough, but the distance to the preceding car is increasing. This allows the driver to increase the distance to the car in front by for example releasing the accelerator without getting bothered by the driving system.

The driving rule (9) tries to increase the safety by limiting the driving speed for example according to the road conditions or speed limits. According to Elvik [50] a bad road condition increases the risk of being involved in an accident as the friction of the road decreases on bad conditions. Thus, the driver should drive slowly in order to decrease the needed braking distance. Furthermore, as the road condition is also related to the weather condition like rain, fog or snow it must also be taken into account. For example by driving slower when the sight is affected by rain, fog or snow. Thus, the parameters that are used for the driving rule (9) should be the road condition, the weather condition and the speed limit. When the car speed is above the speed limit a recommendation should be generated that tells the driver to slow down. Another recommendation to slow down should be shown when the driver is driving fast, which means that the driving speed is near the speed limit, and the weather or road condition is bad, for example when the road is icy or damaged or when the weather is foggy.

The driver should set his focus on driving and should avoid any distractions (driving rule (10)) through the usage of for example the mobile phone or the entertainment system. However, there are four kind of distraction types [51]: visual, cognitive, auditory and manual distraction. Zhang and Smith [51] define visual distraction as the eyes that glances away from the road. Whereas, cognitive distraction is defined as the thinking about something different that is irrelevant to driving. Auditory distraction is when listening for example to messages that are irrelevant to driving. Finally, manual distraction is defined as taking the hands off the steering wheel and shifting the body out of the normal driving position. According to Zhang and Smith [51], auditory and manual distraction tend to overlap with visual and cognitive distraction. For example when manipulating buttons, the driver first has to look at the buttons and think about the appropriate action. This relation between both distractions can also be found between the auditory and the cognitive distraction. For example when listening to the radio, the driver typically need to think about the content of the radio broadcast. Thus, in the driving rule (10) only the cognitive and visual distraction is regarded. On recognition of visual or cognition distraction, the recommendation that the driver should set his/her focus on driving should be shown when the driver looks away from the road several times or when the driver is not focusing on the driving task, for example when using the mobile phone or when the driver is daydreaming.

Finally, driving rule (11) demands from the driver that the fitness to drive must be given, which means that the driver should not drive when the driver is for example fatigue or under influence of alcohol or other drugs [52]. The parameters that the driving system should use for showing a recommendation are level of fatigue and if the driver is under influence of drugs. In case of fatigue, which can be detected using an eye tracker [46], the driving system should recommend the driver to have a rest. In case of the detection of drugs, the driving system should recommend the driver not to drive, as some countries like Germany prohibited by law to drive a car under the influence of drugs, see § 315c of the German Criminal Code [53]. Drugs can be detected using for example the blood parameters, the urine or hair of the driver. As this is not applicable, the driving system will not consider this aspect. However, the influence of alcohol on the driver can be detected using for example breath, sweat or skin sensors and alcohol sniffers [54].

Based on the defined driving rule parameters, the adherence of the driving rules can be monitored. However, during the application of the energy-efficient and safety relevant driving rules a conflict can arise between the driving rules. For example,

when the driver breaks an energy-efficiency and safety relevant driving rule at the same time. According to the results of the ECODRIVEN project [24], safe driving should take precedence over energy-efficient driving when a conflict arise between the two. Thus, the driving system should process the safety relevant driving rule first. For example, the driving rule "keep enough distance to the car in front" should be processed by the driving system before the driving rule "anticipate to the traffic flow", since the driving system should not endanger the driver by showing for example a recommendation to increase the speed in order to anticipate with the traffic flow while the distance to the car in front is too less. However, when two driving rules are broken by the driver that are in the same area, like energy-efficiency or safety, the driving system processes the broken driving rules using the first come, first served principle.

3.4 Driving profile

The driving system is using a driving profile to describe the driving behaviour of the driver. The driving profile contains the typical driving behaviour of the driver in order to compare the typical driving behaviour against the current driving behaviour. This allows the driving system to show a recommendation to the driver to avoid a worsen of the driving behaviour when the current driving behaviour deviates significantly from the typical driving behaviour. However, to compare the driving behaviour, the driving system has to determine the typical driving behaviour of the driver. The typical driving behaviour is based on the calculation of the parameters that are relevant for detecting an energy inefficient or unsafe driving behaviour, see Table 3.1. Besides the typical driving behaviour, the driving profile consists also of information of about recommendations and the target driving behaviour. The stored recommendations contain information about the driver reaction to already shown recommendations and the information when the recommendation was shown last. Based on the driver reaction to already given recommendations, the driving system is able to show the recommendations individually to the driver. This allows an adaptation of the recommendations and, thus, an adaptation of the driving system to the individual driving behaviour of the driver. This allows not to bother the driver with recommendations that are not relevant in the sense of the driver. The information about the last given recommendations are used to avoid showing a recommendation repeatedly in order not to bother the driver by showing the same recommendation.

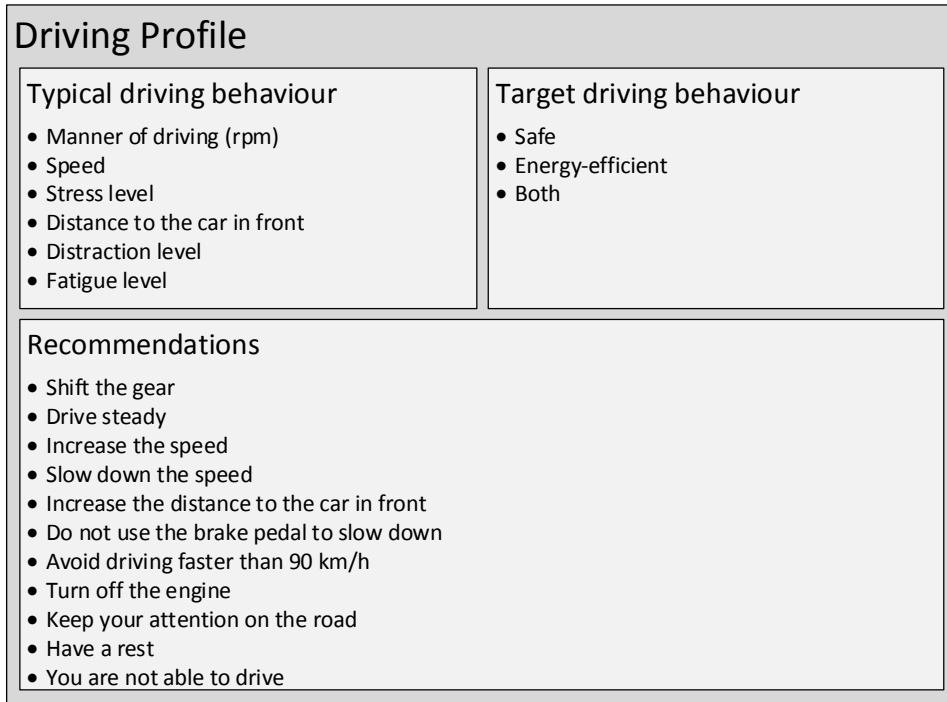

Figure 3.2: The driving profile with the stored information about the driver

Figure 3.2 shows the information that is stored in the driving profile. The target driving behaviour, which is also stored in the driver profile, describes the decision of the driver whether to drive energy-efficient, safe or both. Thus, the driving system will show only recommendations to the driver on the basis of the chosen target driving behaviour.

The typical driving behaviour consists of information about the manner of driving that is used to determine if the driver drives usually at low, mid or high revolutions. Thus, the raw value, i.e. 3000 rpm, gathered from the engine speed sensor need to be aggregated into the values for example high, mid or low revolutions. Furthermore, the speed is also used to describe the typical driving behaviour. However, the driving speed of the driver, stored in the in the typical driving behaviour, is divided into the driving speed in different speed limit zones like 30, 50 or 120. This allows to correlate the driving speed behaviour of the driver to each speed limit zone and, thus, to determine that the driving speed behaviour deviates significantly. The stress level of the driver is also considered in the typical driving behaviour. The typical driver stress level can be used to indicate for example whether the current driver stress level is usual and, thus, show the driver a recommendation to have a break or to calm down. The distance to the car in front is also used to describe the typical

driving behaviour of the driver. Therefore, the typical distance to the car in front is stored in relation to the driving speed. For example, the typical distance to the car in front is 30 metre when driving 60 km/h. The distraction and fatigue level of the driver is also monitored in order to get the typical distraction and fatigue level. The values are stored in the typical driving behaviour in order to detect for example a worsen of the distraction or fatigue level. This allows to show a recommendation to the driver to have a break when detecting that the driver is getting more distracted or fatigue during the journey. The calculation of the stored information about the typical driving behaviour is described in Section 3.8 in detail.

The target driving behaviour is also stored in the driving profile. Figure 3.2 shows the values that can be stored as the target driving behaviour. The target driving behaviour is used to decide, which recommendation should be shown to the driver. The driver is able to modify the target driving behaviour using the graphical user interface of the driving system. The driver can choose either safe, energy-efficient or both, whereby both indicates that the driver wants to improve the driving behaviour in terms of safety and energy-efficiency. On the basis of the chosen target driving behaviour, the driving system will generate either safety or energy-efficiency relevant recommendations or it will show recommendation of both domains to the driver.

The recommendations, stored the driving profile (see Figure 3.2), consist of information about the lag of the recommendations and the time when the recommendation was shown last. The lag represents the time between the last and the new recommendation. Thus, a recommendation cannot be shown to the driver when the time defined in the lag is not passed since the same recommendation was given before. This allows to avoid bothering the driver with recommendations that are not relevant in the sense of the driver, as the lag of a recommendation is adapted to the reaction of the driver to a given recommendation. Besides the lag, the recommendations consist also of information about the last given recommendation to the driver. The last given recommendation is used by the driving system to check if the driver has adhered the last given recommendation. Chapter 6 explains the adaptation of the recommendations and the usage of the stored last given recommendation in detail.

3.5 Architecture of the driving system

The architecture of the proposed driving system is based on the multi-tier architecture. Thus, the driving systems functionality is separated into three layers: data layer, processing layer and graphical layer. Figure 3.3 shows the layers and the different modules of the driving system. Furthermore, the modules of the driving system are graphically mapped to the driving system cycle in order to show the steps of the driving system cycle in the architecture of the driving system.

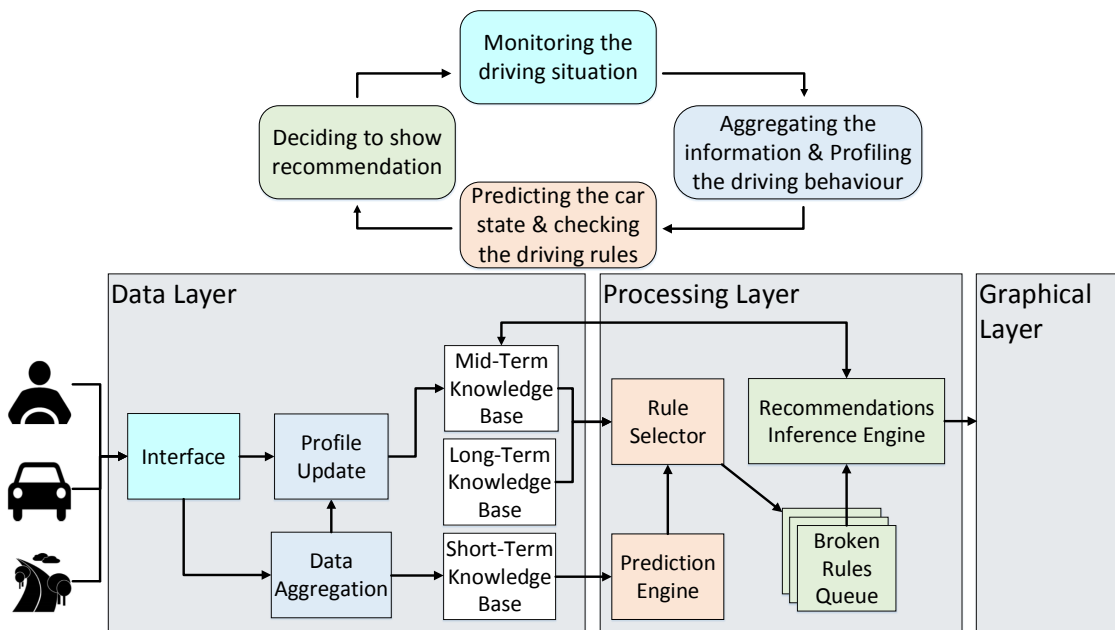

Figure 3.3: The architecture of the driving system including the modules and their corresponding

The data layer consists of modules that are responsible for gathering and processing the information as well as creating the driving profile. In the first step of the driving system cycle "monitoring the driving situation" the interface module is used to monitor the driving situation. Therefore, the interface module gathers the data, needed for further processing, from different sources like the car, the driver and the environment. The interface module is connected to the serial-bus systems of the car and additionally to sensors that provide further information for example about the driver and the environment. The next step of the driving system cycle "aggregating the information and profiling the driving behaviour" comprises the modules aggregation and profile update that get the gathered information simultaneously from the

interface module. The data aggregation module starts to aggregate the information to get more information out of the monitored driving situation. The aggregation of the collected information is described in Section 3.7. The aggregated information is passed along with the collected information from the driving situation to the short-term knowledge base that stores the information and provides it for further processing. Additionally, the aggregated data is passed to the profile update module that updates the driving profile, respectively the typical driving behaviour stored in the driving profile, using the information from the interface module and the data aggregation module. The updated driving profile is then stored in the mid-term knowledge base. The long-term knowledge base consists of the driving rules that are used to check whether the driver has broken a driving rule and the car facts. The car facts store information for example about the fuel consumption. The stored information is used for example to show the current fuel consumption of the car to the driver.

The processing layer is responsible for predicting the state of the car as well as the checking the driving rules against the driving behaviour and the finding of deviations of the current driving behaviour from the typical driving behaviour. Furthermore, it decides whether a recommendation should be shown to the driver. The prediction engine module and the rule selector module represent the driving system cycle step "prediction of the car state and checking of the driving behaviour". First, the prediction engine module gets the prepared information from the short-term knowledge base and starts to predict the car state. As the driving system shows the recommendations in real-time the performance of the prediction is an important point. Thus, the car state is defined by the driving system using the energy-efficiency and safety relevant driving rule parameters driving speed, engine speed and distance to the car in front. After predicting the car state, the information from the short-term knowledge base is passed to the rule selector module together with the predicted car state. The rule selector module matches the information, which was passed by the prediction engine module, with the typical driving behaviour within driving profile, stored in the mid-term knowledge base, and the driving rules, stored in the long-term knowledge base. The matching of the incoming information against the typical driving behaviour and the driving rules allows to recognise broken driving rules and deviations of the current driving behaviour from the typical driving behaviour. The detected broken driving rules or deviations from the typical driving behaviour are put into the broken rules queue with the information that caused the breaking or the deviation and the driver stress level at that time. The broken rules queue collects all broken driving rules or

deviations from the typical driving behaviour and provides it for further processing to the recommendations inference engine. The recommendations inference engine module represents the last step of the driving system cycle "deciding to show a recommendation". It gets a broken driving rule or deviation from the typical driving behaviour that is stored in the broken rules queue using the first in, first out principle. On the basis of the detected broken driving rules or the deviations from the typical driving behaviour gathered from the broken rules queue, the recommendations inference engine decides whether to show a recommendation to the driver taking into the corresponding information about the driver stress level and the driver reaction to already given recommendations into account. Additionally, it checks if the driver has adhered the last given recommendations. When the driver did not adhere the last given recommendation repeatedly, the frequency of the corresponding recommendation is decreased. This allows not to bother the driver with recommendations that are not necessary in the sense of the driver. Furthermore, when the driver was not stressed at the moment when a driving rule was broken or when the driver did not drive according the typical driving behaviour, the recommendations inference engine will decide to show a recommendation to the driver. Thus, the recommendation is passed to the graphical layer.

The graphical layer is the interface between the driving system and the user. Its main task is the presentation of the recommendations to the driver. The recommendations, which are received from the recommendations inference engine module, are shown for example on the in-vehicle display unit and are presented simultaneously to the driver using an audio voice. Furthermore, the graphical layer provides a graphical user interface to the driver. Thus, the driver is able to interact with the driving system for example to choose an existing or creating a new driving profile. Furthermore, the driver has the opportunity to choose the target driving behaviour like safety, energy-efficiency or both areas. The target driving behaviour indicates the area that should be improved by the driving system.

3.6 Interface module

The driving system needs information about the current driving situation and the driver to be able to detect an inefficient or unsafe driving behaviour, to adapt the driving system to the individual driving behaviour and to consider the driver con-

dition. The needed information is defined by the parameters of the driving rules, described in Section 3.3, and the driver condition like the stress level or fatigue. On the basis of the needed information three information sources can be specified: the car, the environment and the driver. Figure 3.4 shows the information that can be gathered from three information sources. Thus, the interface module collects the needed information from the car, the driver and the environment using the in-vehicle serial-bus systems and additionally attached sensors. Furthermore, the in-vehicle internet connection can be used to gather additionally information. The gathered information is then passed to the profile update and data aggregation module for further processing. In the following the sensors and driving systems are explained that can be used to get the needed information from the three information sources.

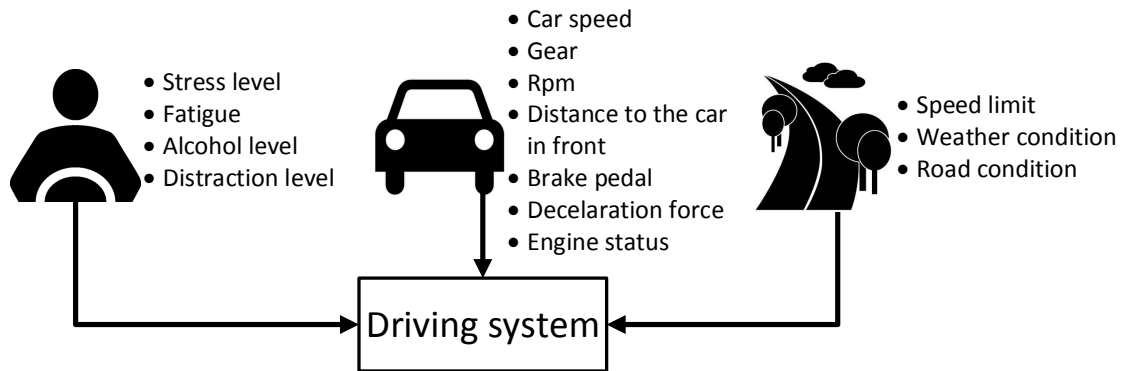

Figure 3.4: The driving rule parameters and the driver condition with the corresponding information sources: driver, car and environment

3.6.1 Monitoring the car

To obtain the driving rule parameters like car speed, rpm, gear and so on, the in-vehicle serial-bus systems can be used. According to Mayer [55], the well-established serial-bus systems in the automotive area are: Controller Area Network (CAN), Media Oriented System Transport (MOST), Local Interconnect Network (LIN) and FlexRay. As shown in Figure 3.5, the serial-bus system CAN is separated in low and high-speed. The high-speed CAN is used in the area of powertrain and chassis for a fast processing of the information between the electronic control units (ECU) of the powertrain and chassis. In contrast, the low-speed CAN is used in the convenience area, as the data of the convenience ECUs need not be processed fast. The MOST serial-bus system is implemented in the infotainment system area, in which it is used to transmit audio

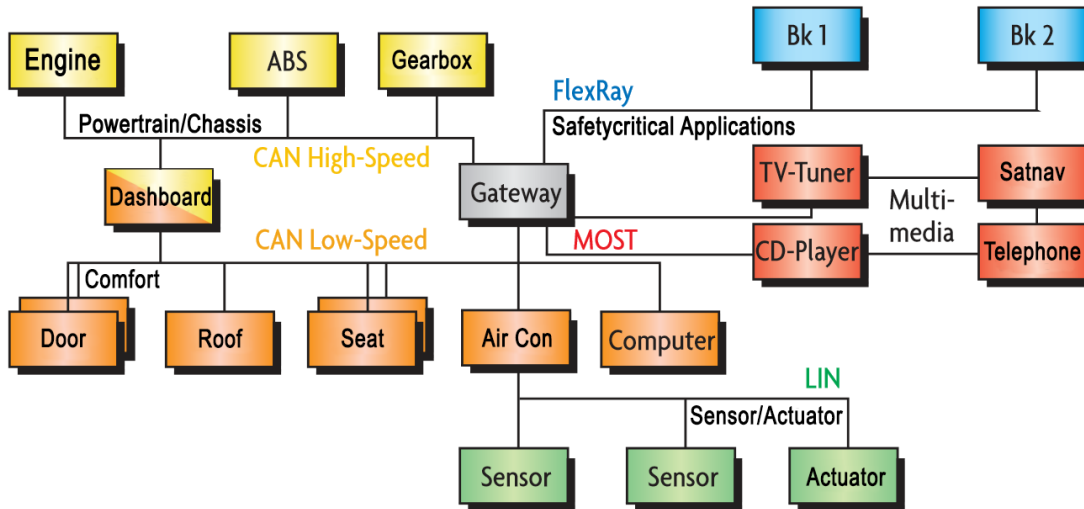

Figure 3.5: An example car network using the serial-bus systems (translated into English, original picture in [59])

and video signals. LIN is used to transmit data simple and cost-effective in the area of sensors and actuators. Finally, FlexRay is used for the communication in safety-critical distributed applications. However, FlexRay "must first become established in the automobile" [55]. It was used for the first time in a car in 2007 by the car manufacturer BMW [56]. The needed driving rule parameters from the car are placed in the ECUs of the powertrain and chassis why the high-speed CAN can be used for gathering the necessary information. According to Reif [57], the driving rule parameters car speed, deceleration force, rpm, brake pedal position and engine status can be read from the engine ECU as the sensors that monitor the needed values are attached to the engine ECU. The information about the gear can be found on the gearbox ECU, whereas the distance to the car in front can be gathered from the autonomous cruise control ECU that uses for example a radar [58] to calculate the distance to the car in front.

3.6.2 Monitoring the environment

For gathering the environmental information like the weather condition, road condition or the speed limit, the interface module provides access to different sensors, driving systems or the internet connection of the vehicle.

For detecting the weather condition, the in-vehicle sensors like the temperature or precipitation sensor can be used and accessed using the low-speed CAN, as the ECU of the precipitation and temperature sensor is placed in the area of comfort [57]. Also different weather sensors can be attached to the driving system for collecting meteorological information from mobile vehicles, as shown in [60]. The attached sensors can be connected directly to the interface module or to an ECU that can be accessed using the serial-bus system of the vehicle. Another possibility to get weather information is to request the weather data from the in-vehicle internet connection, for example by using the weather API of OpenWeatherMap¹. To get a reliable information about the current weather condition, the different weather information sources can be combined.

The condition of the road can be measured by using the weather information. For example, it can be assumed that the road may be icy when it is raining and the temperature is below the freeze point. However, the internet connection of vehicle can be used to get the information about the road condition, as well. For example websites like WeatherOnline² provide information about the current road condition. Another approach to detect the road condition is by using a road surface sensor [61] or driving systems that detect the road condition [62]. These sensors and driving systems are able to detect a dry, wet, frozen or a snow-covered road.

There are already commercial driving systems like Speed Limit Info from BMW [63] that recognise the speed limit of the road for example using a camera and image analysis algorithms. The driving system of BMW [63] is able to recognise speed limit and no overtaking signs. Recognised signs are shown on the dashboard of the car in order to keep the driver constantly informed. Another approach is to use the satnav to gather the speed limit information from the road. However, according to Barnes et al. [64] difficulties can arise with frequent updates to speed limit signs as for example temporary road work signs or automatically changing speed limit signs cannot be detected using a satnav.

¹OpenWeatherMap offers free weather information through an API. More information can be found on <http://www.openweathermap.org>

²WeatherOnline provides information about the weather and road conditions in Europe. More information can be found on <http://www.weatheronline.co.uk>

3.6.3 Monitoring the driver

The needed information from the driver is the driver condition like the stress level, the fatigue level, the alcohol level and the distraction of the driver. The stress level can be measured using an ear sensor that provides information about the heart rate. The heart rate can be used to derive the heart rate variability (HRV). The HRV is the variation of the interval between two heart beats, also called inter-beat interval (IBI) and allows to detect the stress level of the driver [65, 66, 67], as high stress leads to a high HRV. However, a low HRV indicates a low stress level. The stress level of the driver can be gathered by the driving system either by using a software that calculates the stress level and passes the information to the interface module or by attaching a sensor to the interface module and calculating the driver stress level on the basis of the HRV.

According to Jung et al. [68] the analysis of the HRV also gives a valuable information about the fatigue and drowsiness status of the driver. They calculated the HRV of the driver on the basis of the ECG signal and analysed the power spectral density distribution of the HRV across its very low- (0.003-0.04 Hz), low- (0.04-0.15 Hz) and high-frequency. Jung et al. showed that the ratio from the low- to high-frequency can be used to decide if the driver is in normal, drowsy or fatigue condition, as the ratio from the low- to high-frequency decreases when the condition of the driver progresses from awake to drowsy [69]. Another way to detect drowsiness and fatigue is by tracking the eyes of the driver. Singh et al. [46] proposed a driver fatigue monitoring system that monitors the driver eyes using a camera and warns the driver when the driver shows symptoms of fatigue. The driving system of Daimler [70], Attention Assist, observes the driving behaviour of the driver. On detection of the typical indicators of drowsiness in the steering behaviour, a warning is given to the driver. Based on the presented fatigue or drowsiness detection systems, the fatigue or drowsiness information can be gathered by using the in-vehicle serial-bus system when the fatigue or drowsiness detection systems are connected to the car or by attaching such a fatigue or drowsiness detection system directly to the interface module.

There are four kind of sensors for measuring the blood alcohol level [71, 72, 73, 54]: skin sensors, sweat sensors, alcohol sniffers and breath sensors. There are already skin sensors developed [74, 75], also called tissue spectrometry systems, that need skin contact to determine the blood alcohol level. According to the American Beverage Institute [71] and USA Today [76], Toyota started to develop a steering wheel in 2007

that embedded such a skin sensor to detect the blood alcohol level. Sweat sensors, also called transdermal sensors, need also skin contact to detect the blood alcohol level of the driver. Nissan [77] presented in 2007 a concept car that integrated a sweat sensor in the gear shift knob to prevent drink driving by blocking the transmission of the car. Breath sensors are widely used for estimating the blood alcohol [72]. The sensor measures the concentration of alcohol in the breath, as ethanol is able to partition itself from the capillary blood into the inspired air. Volvo [78] presented in 2007 a driving system that is using a breath sensor to prevent drink driving by prohibiting to start the engine on detection of alcohol. Alcohol sniffers, also called distant spectrometry systems, are trying to detect the presence of alcohol in the air. According to Ferguson et al. [73], alcohol sniffers are trying to detect the alcohol concentration of the breath for example within the driver cabin without the need to provide a deep-lung breath like in breath sensors. Such sensors can detect alcohol also when the window of the car is opened and the air conditioner of the car is set to recycle [54]. Nissan [77] integrated, additionally to the sweat sensor, an alcohol sniffer in the seat of their concept car in 2007 to detect the blood alcohol of the driver. On the basis of the presented sensors and alcohol detection systems, the alcohol level of the driver can be gathered either by connecting the sensors directly to the interface module or to the in-vehicle serial-bus system for example by embedding the sensors in to the driving wheel or driving seat, as shown in the concept car of Nissan [77].

The visual distraction and the cognitive distraction are combined in order to get the distraction level of the driver. The visual distraction can be measured for example using an eye tracking system. Volvo [79] developed a head and gaze tracker, called Volvo/ANU system, that is able to robustly track head pose, gaze and eye closure in real-time in the environment of a car. Cognitive distraction can be measured by using the physiological signals of the driver [80] or the driving performance. However, according to Lee et al. [80], the relationship between the physiological measures and the driving performance might be a particularly powerful predictor of distraction such as the eye movement and steering behaviour. Thus, a combination of sensors and driving performance measures can be used for detecting the cognitive distraction of the driver, whereas a stereo camera can be used for detecting the visual distraction. The sensors and cameras for detecting the distraction level can be connected to an ECU of the in-car serial-bus system that calculates and provides the distraction level to the interface module or by connecting the sensors and cameras directly to the interface module and calculating the distraction level within the driving system.

3.7 Data aggregation module

The interface module is getting information from the car, the driver and the environment in order to monitor the driving situation. However, some attached sensors that monitor the driving situation, like the rain, temperature or engine speed sensor, provide only raw data. For example, the rain sensor provides information about the rain intensity, whereas the engine speed sensor provides the information about the engine speed in revolutions per minute. However, aggregated sensor information is needed to process the driving rules, as some driving rules depend on the aggregated value, like the weather condition in the driving rule "adapt your speed to the given situation". Furthermore, some driving rule parameters are described in a human understandable way or are not worded exactly, like the weather condition or the acceleration force, which are described as bad or very high. Thus, the data aggregation module gets the information that are relevant for the aggregation and transformation from the interface module and starts to aggregate and transform the information to the needed values. After the aggregation and transformation, the processed information is stored along with the information from the interface module in the short-term knowledge base for further processing. Furthermore, the data aggregation module passes aggregated information to the profile update module. Table 3.2 shows the driving rule parameters that are aggregated in the data aggregation module with their corresponding information source.

Driving rule parameter	Information source	Gathered Information	Aggregated Information
Weather condition	Rain sensor, internet connection	Rain intensity, Snow intensity, Fog intensity	Good driving weather, bad driving weather
Road condition	Road condition detection system, internet connection	Ice, snow or water on the road, damaged road	Good road condition, bad road condition
Deceleration force	Accelerometer sensor	Positive or negative acceleration force in Newton	Very high, high, medium, low, very low deceleration force
Manner of driving	Engine speed sensor	Revolutions per minute	driving at very high, high, medium, low, very low revolutions
Alcohol level	Skin sensors, sweat sensors, alcohol sniffers, breath sensors	Alcohol per mille	above drink-drive limit, within drink-drive limit, no alcohol detected

Table 3.2: The driving rule parameters with the corresponding data source, the gathered information and the aggregated information

A bad weather condition for driving is described in [29], in which the OECD summarises the speed limitations during different weather conditions in different countries. The OECD determines three measures for the limitation of the speed: rain, snow and visibility due to fog or snow. In countries like France the speed limits on broad roads and motorways are 10 km/h or 20 km/h lower when it is raining or snowing. Furthermore, the speed limit is reduced to 50 km/h when the visibility is less than 50 metres, for example due to fog or snow. Thus, to detect a bad weather, the gathered weather information from for example the rain sensor or the internet connection must be combined and aggregated. This allows to determine a bad or good weather condition that can be used to show a recommendation by the driving system for example to reduce the speed according to the defined driving speeds during bad weather conditions listed in the report of the OECD.

The road condition sensors or driving systems that detect the road condition are able to distinguish between a dry, wet, snowy or an icy road as shown in Section 3.6.2. Furthermore, the internet connection provides the information if the road is dry, wet, snowy or icy. However, this information must be aggregated to determine if the road condition is good or bad for driving. Based on this information, the driving system is able to show the driver a recommendation for example to slow down the speed as the road condition is bad. This allows the driver to reduce the probability of being involved in an accident as the braking distance of the car will decrease when reducing the driving speed [50].

Besides the aggregation of the incoming information, the raw values collected from the sensors, like the accelerometer sensor, have to be aggregated in to a human understandable way. This allows to process the driving rules, as these are described in a human understandable way and, thus, are not worded exactly. For example, the deceleration force must be aggregated to a human understandable value. This allows the processing of the driving rule "Decelrate smoothly by releasing the acceleration while the car is in gear". The accelerometer sensor can be used to determine the deceleration force. A positive sensor value represents an acceleration of the vehicle and a negative value a deceleration. However, the sensor provides the acceleration or deceleration of the vehicle in the unit Newton. Thus, the raw value of the sensor must be aggregated into for example a high, high, medium or low acceleration and deceleration in order to determine whether the driver is decelerating smoothly using the engine braking or by using the brake pedal.

The manner of driving is describing if the driver is driving at low or high revolutions. This is relevant for describing the typical driving behaviour of the driver in the driving profile. The manner of driving can be defined by using the engine speed. However, the manner of driving is described as driving at very high, high, mid, low or very low revolutions. Thus, the engine speed, which is measured by the accelerometer in rpm, must be aggregated in order to specify the manner of driving. The aggregated manner of driving allows the driving system to determine whether the driver improves the driving behaviour in terms of energy-efficiency and is able to show a recommendation when it detects a worsen of the manner of driving.

Also the alcohol level must be aggregated into a human understandable way, as the sensors that are used for detecting the alcohol level provide the alcohol level in per mille. Furthermore, the driving rule is described in a human understandable way and defines that the driver should not be under the influence of drugs when driving. However, as some laws allow drink-driving within a certain alcohol level, the alcohol level gathered from the sensors must be aggregated for example to alcohol limit is above the drink-drive limit, within the drink-drive limit or no alcohol detected. On the basis of the transformation the driving system is able to determine whether the driver is able to drive at all or the driver should not drive due to the detected alcohol level that is for example within the drink-drive limit. Thus, the driving system is able to show a recommendation to the driver, in which the driving is either not recommended or allowed at the drivers own risk.

In order to get the aggregated information out of the collected sensor data, fuzzy logic [81, 82, 83], neural networks [84, 83] or a combination of both, the neuro-fuzzy networks [85], can be used. According to Siler and Buckles [83], fuzzy logic is likely to be better than neural networks and, thus, also better than neuro-fuzzy networks when input and output relations are known, no sufficient data is available for a training set due to the combination of inputs and outputs or the collecting of a training set would be too expensive and when there is an interest in the way, in which the outputs can be derived form the inputs. In the case of the driving system, the input and output combination for the aggregation of the driving rule parameters are known. However, no training data set is available for the aggregation of the needed information. Furthermore, the driving rules and the driving rule parameters are not worded exactly, like the driving rule decelerate smoothly by releasing the accelerator or the driving rule parameter deceleration force, which is described as high. However, in crisp logic the driving rules and driving rule parameters have to be exactly defined.

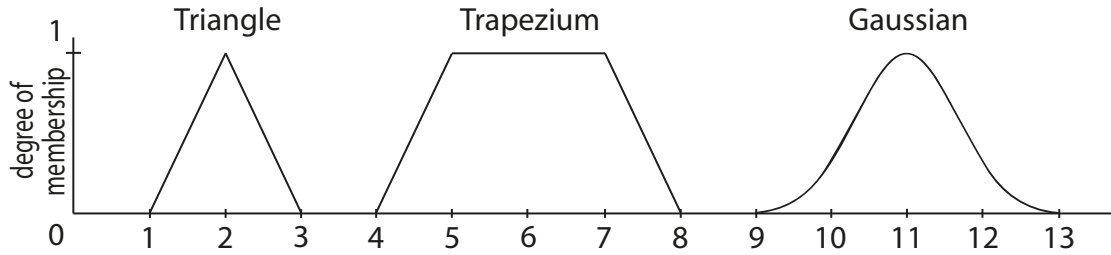

Figure 3.6: An example of the membership functions triangle, trapezium and Gaussian [85]

For example, the deceleration force in crisp logic is an exact value like 1000 Newton. An imprecise definition can not be processed in crisp logic, as the problem is for example when the deceleration force should be interpreted as high in crisp logic.

Fuzzy logic allows the interpretation of imprecise definitions of driving rules and driving rule parameters, as it allows to express the imprecise definitions by using linguistic variables. According to Zadeh [81], linguistic variables are variables whose values are words or sentences in natural or synthetic language. For example the deceleration force is a linguistic variable as its values are high, medium and low. The linguistic variables are represented in fuzzy logic by using the fuzzy set theory. Furthermore, the linguistic variables can be used in fuzzy logic to define rules. The rules are used to do reasoning in fuzzy logic. The result of the reasoning is then transformed by fuzzy logic to crisp values to allow further processing of the values. The three steps that fuzzy logic is using to process the information are called: fuzzyfication, reasoning and defuzzification.

In the fuzzy set theory [86], a fuzzy set consists of objects that have a certain degree of membership, instead of objects that are true or false like in crisp logic. The degree of membership is ranging between zero, which stands for no membership, and one, which means full membership. It is assigned to each object using a membership function, like a triangular, trapezium or Gaussian function. The transformation of crisp values to a certain degree of membership using a membership function is also called fuzzification. Figure 3.6 shows the degree of membership using the triangular, trapezium and Gaussian function. The triangular function is used to express the linguistic term approximately equal to 2, whereby the trapezium function represents the term approximately between 5 and 7 and the Gaussian function the term approximately 11 [85, 82]. For example, the fuzzy set of the manner of driving is done

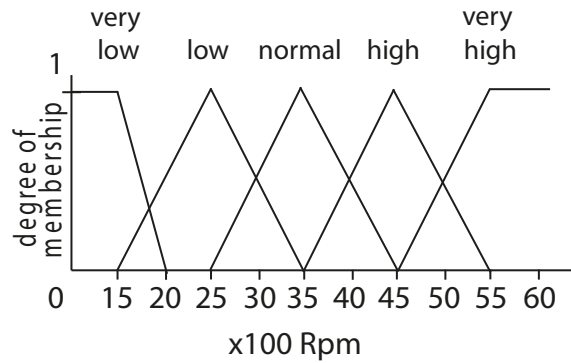

Figure 3.7: The fuzzy set of the manner of driving on the basis of the engine speed, using the triangular membership functions

using the triangular membership function that is applied to the sensor values of the engine speed sensor, as shown in Figure 3.7. The engine speed is represented by the linguistic variables very low, low, normal high and very high.

The linguistic variables can be used to create rules that are the basis for doing reasoning in fuzzy logic. The reasoning allows to aggregate the collected information from the sensors. For example, the weather condition can be aggregated by defining rules that use the fuzzified sensor information from for example the rain or weather sensor. The rules in fuzzy logic consist of antecedents and consequences. The following equation illustrates the syntax of a fuzzy rule:

$$IF \textit{weather is rainy} \textit{ THEN driving weather is bad} \tag{3.1}$$

The antecedent in equation 3.1 is represented by *weather is rainy* and the consequence of the rule is *driving weather is bad*. The antecedents and consequences in fuzzy logic can be defined using linguistic or crisp variables. The linguistic variables can also be chained together using logical operators. Figure 3.8 shows the degree of memberships when using the AND and OR operator. When linking two linguistic variables using the AND operator, the degree of membership of the consequence is modelled as the minimum of the linguistic variables used in the antecedent. In contrast, when using the OR operator the degree of membership of the consequence is defined as the maximum of the used linguistic variables in the antecedent [82]. The degree of membership of the consequence is ranging between zero and one. The process of finding the degree of membership of the consequence is called inference. The

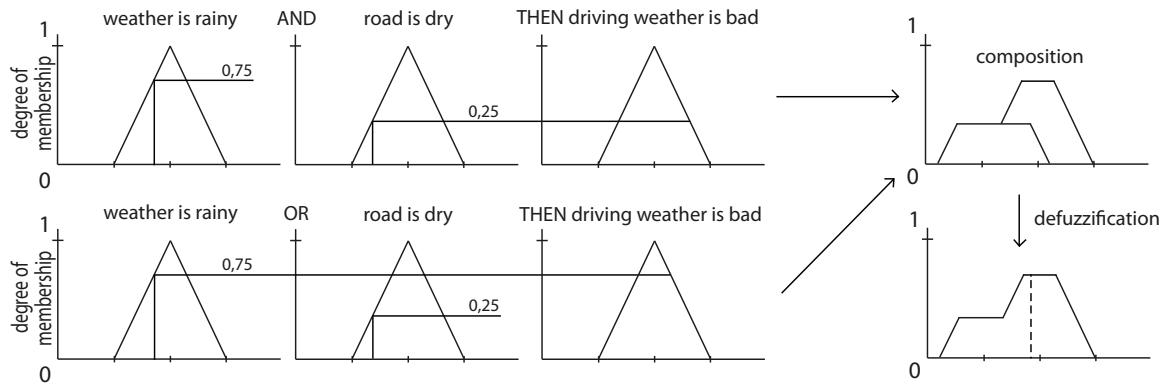

Figure 3.8: Two fuzzy rules with antecedents and consequences, the composition of the rules and the defuzzification of the composition using the centre of area method (illustration is based on [85])

linguistic variables used in the consequence are also called output variable. In fuzzy logic the same output variable can be used in different rules as shown in Figure 3.8. Therefore, the total degree of membership of an output variable has to be defined. According to Nauck [85] the maximum method is usually used to get the total degree of membership of an output variable by creating the maximum over every degree of memberships of the output variables. This step in fuzzy logic is called composition. Figure 3.8 illustrates the total degree of membership of an output variable that is created using the maximum method.

The fuzzy output variable that is calculated using the composition has to be transformed to a crisp value. This allows the further processing of the fuzzy output variable in the non-fuzzy part of the driving system. The transformation of a fuzzy value to a crisp value is called defuzzification. According to [83] the usual method to defuzzify a fuzzy value is the centre of area method. The centre of area method calculates the centre of an area under a curve, as shown in Figure 3.8, and gets the value that is represented by the centre of the area. In the example illustrated in Figure 3.8 the linguistic variable *driving weather is bad* is defuzzified approximately to the crisp value 1.8. After the defuzzification of the values, the data aggregation module stores them along with the gathered information from the interface module in the short-term knowledge base for further processing. Furthermore, the defuzzified values are passed to the profile update module that uses the aggregated values to update the typical driving behaviour of the driver.

3.8 Profile update module

The typical driving behaviour of the driver is stored in the driving profile and is used in the driving system for checking the progress of the driving behaviour in terms of energy efficiency and safety. A recommendation to the driver is shown when the current driving behaviour differs significantly from the typical driving behaviour in a negative way. As described in Section 3.4, several driving rule parameters, like the manner of driving or the driving speed, are used to represent the typical driving behaviour of the driver. The information about the driving rule parameters is gathered from the interface and data aggregation module. The typical driving behaviour is based on the quantity of the gathered information. Thus, the representation of the typical driving behaviour is more accurate when the driving system gathered more information about the current driving behaviour of the driver. During the initialisation phase of the driving system a driving profile must be generated. At this time, the driving profile is not able to represent the typical driving behaviour of the driver as the driving system gathered not enough information about the driving behaviour. Until the driving profile is able to represent the typical driving behaviour, the driving system avoids to show recommendations based on the driving profile. During the journey, the driving profile is updated using the information collected from the data aggregation and interface module. The calculated typical driving behaviour is stored in the driving profile for every journey separately. This allows to indicate positive or negative trends in the typical driving behaviour and, thus, to show recommendations when a negative trend is detected.

For updating the typical driving behaviour with the collected information, the simple exponential smoothing technique [87, 88] is used. The simple exponential smoothing technique can be used either for smoothing or to make forecasts of data that has no seasonal influence or systematic trends like the driving behaviour. Furthermore, it allows to consider the past typical driving behaviour during the calculation of the typical driving behaviour, as the current driving behaviour is influenced by the past. However, the simple exponential smoothing limits the influence of the past typical driving behaviour on the current by decreasing the influence of the past typical driving behaviour when it is further back in time. The profile update module uses the smoothing capability of the simple exponential smoothing technique to calculate the information that define the typical driving behaviour of the driver using the following equation:

$$m_i^* = \frac{1}{(1+i)} * m_i + \left(1 - \frac{1}{(1+i)}\right) * m_{i-1}^* \quad m, m^*, i \in R \quad (3.2)$$

where m_i^* is the smoothed value that represents the information that is part of the typical driving behaviour at the time slot i , like the driving speed or stress level of the driver. The measured value from the sensor m_i at the time slot i is gathered from the interface and the data aggregation module. m_{i-1}^* represents the smoothed value of the information from the typical driving behaviour at the previous time slot $i - 1$. However, during creation of the driving profile the previous smoothed value m_{i-1}^* is not available, why no previous smoothed value is used during the first calculation of the smoothed value. The smoothing factor of the exponential smoothing technique is represented at the time slot i by $\frac{1}{(1+i)}$. The smoothing factor is limited to the range of zero and one, whereas one means no smoothing of the value. The smoothing factor is used to decrease the influence of the previous smoothed value m_{i-1}^* on the current calculation of the smoothed value m_i^* . This allows to give more weight to the current measured value from the sensor gathered from the data aggregation or interface module. After the calculation of the smoothed value m_i^* , the previous smoothed value, which was stored in the driving profile to represent the previous typical driving behaviour, is replaced by the newly calculated value m_i^* . Furthermore, the time slot i is also stored in the driving profile in order to continue the calculation in the next journey with the values of the previous journey. As the driving profile is stored for every journey separately, this allows to begin a new journey on the basis of the previous journey, which leads to the avoidance of the initialisation of the typical driving behaviour in the beginning of every new journey. Thus, the new journey is able to represent the typical driving behaviour from the beginning. Furthermore, the usage of the time slot and the smoothed value from the previous journeys allow to see a constant progress in the typical driving behaviour of the driver over all journeys.

Figure 3.9 shows an example of the manner of driving that is part of the typical driving behaviour. For the calculation of the typical manner of driving, the aggregated sensor information was gathered from the data aggregation module that calculated the current manner of driving on the basis of the engine speed sensor. The profile update module calculated the typical manner of driving during the first two journeys of the driver, using the simple exponential smoothing equation 3.2. However, the typical manner of driving started at very low and increased rapidly after the initialisation of the driving profile, as the calculation of the typical manner of driving started for the

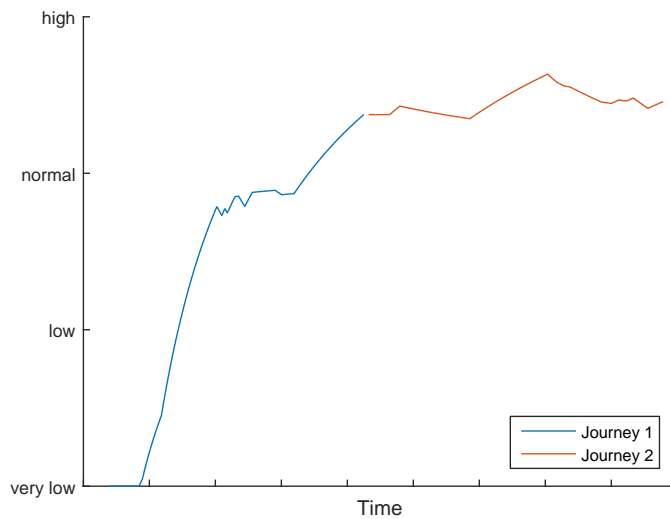

Figure 3.9: The calculation of the typical manner of driving during the first and the second journey using the simple exponential smoothing technique

first time in the first journey. At the end of the journey the driver has driven at high to very high revolutions, why the typical manner of driving increased a second time. During the first journey the typical manner of driving was initialised and needed time until it was able to represent the typical manner of driving of the driver. The last calculated typical manner of driving and the last time slot of the calculated typical manner of driving is used as the basis for the second journey. This allows to represent a constant progress of the typical manner of driving, as seen in Figure 3.9, and to avoid the reinitialisation of the typical manner of driving in the second journey. Thus, the second journey was able to represent the typical manner of driving from the beginning of the journey.

Chapter 4

Prediction engine module

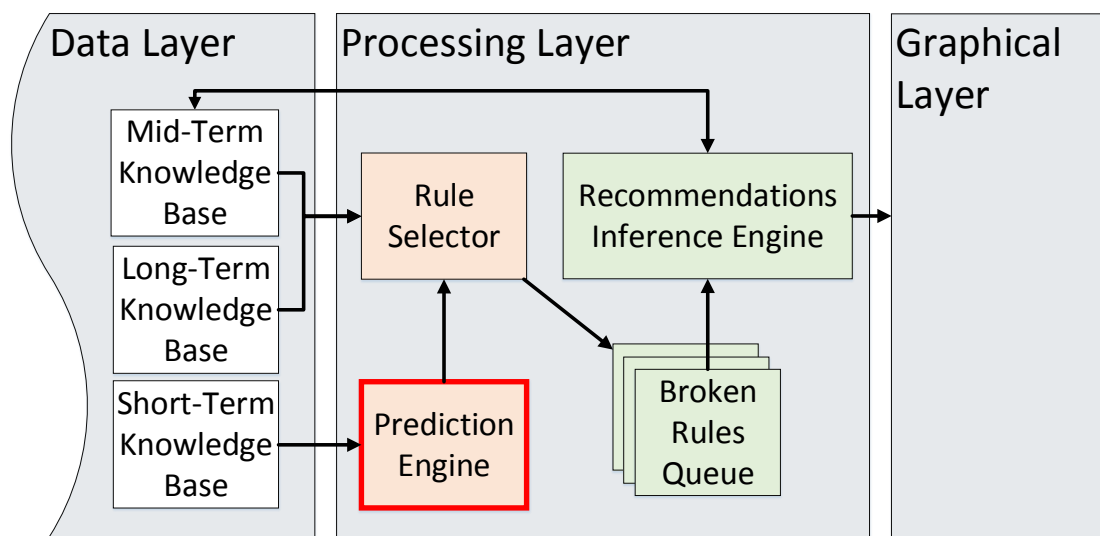

Figure 4.1: The data flow of the processing layer with the focus on the prediction module

The driving system tries to show a recommendation to the driver before the driver breaks a driving rule. Therefore, it is necessary that the driving system knows the future state of the car. The prediction engine module of the driving system, shown in Figure 4.1, is responsible for the prediction of the car state. Therefore, it gathers the needed data from the short-term knowledge base module and predicts the state of the car. The predicted state of the car is then passed along with the data from the short-term knowledge base to the rule detector module for further processing. However, as the performance of the driving system is an important point, the prediction must be

done in near-time. Thus, not every measure of the car is used to define the state of the car. Instead, the safety and energy-efficiency relevant measures like driving speed, distance to preceding car and revolutions per minute are used. The future state of the car allows the driving system to recognise an early breaking of the driving rules. Thus, the driving system is able to generate recommendations to prevent the breaking of the driving rules. There are prediction algorithms like the Kalman filter or the Auto-Regressive Moving-Average (ARMA) that are able to predict the car state. In the following sections the Kalman filter and the ARMA are explained. Furthermore, the algorithms are evaluated by predicting the driving speed that is part of the car state. Finally, the results of the evaluation are presented and discussed.

4.1 Discrete Kalman filter

The Kalman filter [89] is an algorithm that allows prediction by estimating a process and getting feedback of that process in the form of a measurement. The two steps of the Kalman filter are also called prediction and correction. The prediction is responsible for the forward projection of the current state and the estimation of the error covariance in order to obtain the a priori estimation for the next time step. The correction step is responsible for the feedback that allows to get a measurement into the a priori estimation and, thus, to obtain an improved a posteriori estimation of the state. According to Welch and Bishop [89], the estimation algorithm of the Kalman filter can be seen as a predictor-corrector algorithm that solves numerical problems by predicting the current state ahead in time and correcting the prediction by an actual measurement at that time.

The cycle of the Kalman filter consists of the prediction and correction steps, as shown in Figure 4.2. During the initialisation of the Kalman filter, the previous state x_{k-1} and the previous error covariance P_{k-1} are initialised (1a). The initialised previous state and error covariance are the basis for the first step of the Kalman filter (1b), in which first the state is estimated for the next time step using the equation

$$\hat{x}_k^- = A\hat{x}_{k-1} + Bu_k \quad (4.1)$$

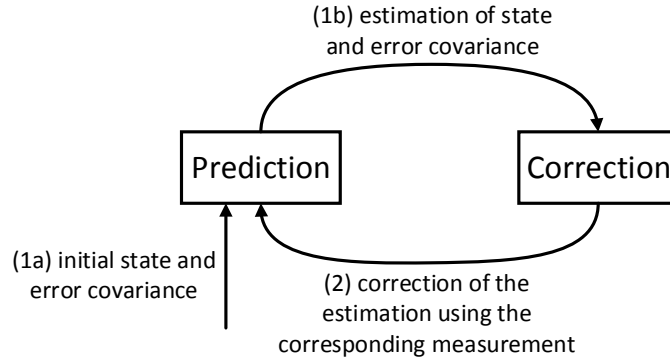

Figure 4.2: The cycle of the Kalman filter with the steps prediction and correction (illustration is based on [89])

where \hat{x} is the predicted state, A the state transition model that is applied to the previous state \hat{x}_{k-1} and B is the control-input model that is applied to the control vector u_k . Next, the error covariance is estimated for the next time step using equation

$$P_k^- = AP_{k-1}A^T + Q \quad (4.2)$$

where P_k^- is the predicted error covariance, A is the state transition model that is applied to the previous error covariance P_{k-1} and to the transposed error covariance matrix A^T . Q represents the noise covariance matrix. After the estimation, the Kalman filter updates the estimated state of the prediction step using the measurement at the time step of the estimation (2). First, the Kalman gain is computed using the equation

$$K_k = P_k^- H^T (HP_k^- H^T + R)^{-1} \quad (4.3)$$

where K_k represents the Kalman gain. H is the measurement matrix, whereas H^T is the transposed measurement matrix. R represents the error covariance of the measurement. The second task of the correction step is to update the estimated state with the measurement z_k using the equation

$$\hat{x}_k = \hat{x}_k^- + K_k(z_k - H\hat{x}_k^-) \quad (4.4)$$

where the updated estimate with the measurement is represented by \hat{x}_k . According to Welch and Bishop [89], the difference of $z_k - H\hat{x}_k^-$ is called the measurement innovation or the residual that reflects the discrepancy between the predicted measurement $H\hat{x}_k^-$ and the current measurement z_k . Finally, the error covariance is updated in the correction step, as well, using the equation

$$P_k = (I - K_k H)P_k^- \quad (4.5)$$

where P_k is the updated error covariance, I the identity matrix and P_k^- represents the predicted error covariance. The update of the estimated state and error covariance allows to generate the a posteriori state estimation for the updated state and the error covariance. The a posteriori state and error covariance are used as the basis of the prediction step for estimating the state and the error covariance for the next time step.

Pentland and Liu [90] used the Kalman filter for modelling and recognition of simulated driving behaviour. As the human behaviour is not directly observable Pentland and Liu determined the internal state of the driver using an indirect estimation process. According to Pentland and Liu the Kalman filter is only useful in short time prediction like a quick hand motion, up to one-tenth of a second. Therefore, they used the Kalman filter for small-scale structure of the driving behaviour and coupled these together into a Markov chain¹ that represents the large-scale structure of the driving behaviour. Pentland and Liu showed in an experiment that this approach is able to achieve 95 % accuracy at predicting the subsequent actions of the driver from the preparatory movements of the driver.

However, Bossanyi [91] used the Kalman filter for the short-term wind speed prediction. The forecast of the short-term wind speed was done with a time step of one minute over a data set of 1000 hours. Thereby, Bossanyi compared the performance of the forecast with persistence. During the experiment, a forecast horizon up to ten time

¹A Markov chain consists of states and transitions. It also describes the transition probability from one state to another. The probability of the next state depends only on the current state. Markov chains are mainly used for statistical models of real world processes

steps were investigated. Bossanyi generated also new series with time steps of 2, 5, 10 and 15 minutes. This allowed to study the evolution of the one-step ahead prediction error. The results of the investigation showed that the Kalman filter generated the smallest prediction error for a time step of 5 minutes. Furthermore, the greatest improvement over persistence occurred about a time step of one minute, whereas the persistence performed better for hourly data.

4.2 Autoregressive Moving-Average

Another statistical prediction model is the ARMA [92, 93]. It combines the autoregressive (AR) and the moving-average (MA) model. The autoregressive model assumes that the current value depends on the past values of the same time series. The order of the autoregressive model describes the amount of the past values that are considered in the autoregressive model. The past values are also called lag. The order of the autoregressive model is denoted by $AR(p)$, where p defines the lag. The following equation defines the autoregressive model

$$z_t = C + a_t + \sum_{i=1}^p \phi_i z_{(t-i)} \quad (4.6)$$

where z_t stands for the value at time t . c is a constant level, whereas a_t is a random variable with mean zero and constant variance that is independent and represents random error or shocks. ϕ is the coefficient to that is to be estimated and $z_{(t-i)}$ is the past value.

The moving-average model describes the time series as a weighted average of random errors or shocks. The order of the moving-average model describes the lags that are included in the model. The moving-average model is denoted by $MA(q)$, where q is the lag. The moving-average model can be described with the equation

$$z_t = a_t + \sum_{i=1}^q \Theta_i a_{(t-i)} \quad (4.7)$$

where z_t is a weighted average of the current shock or random error a_t and the past shocks or random errors $a_{(t-i)}$. Θ is the coefficient that is to be estimated.

Modelling a time series using the autoregressive or moving average model would need to consider too many values of the past series to make estimation possible. Thus, ARMA combines both models defined in the equations 4.6 and 4.7 to reduce the amount of past values needed for modelling a time series. The ARMA is denoted by $ARMA(p, q)$ whereby p and q are lags for the autoregressive and moving-average model. Equation 4.8 shows the combination of the autoregressive and moving-average model in the ARMA.

$$z_t = C + a_t + \sum_{i=1}^p \phi_i z_{(t-i)} + \sum_{i=1}^q \Theta_i a_{(t-i)} \quad (4.8)$$

However, to use an ARMA model for prediction, the ARMA model has to be fitted to the data by choosing the right order p and q of the autoregressive and moving-average model. This can be done for example by using the autocorrelation and partial autocorrelation function [92]. On the basis of the fitted ARMA model, ARMA is able to predict the behaviour of a time series on the basis of past values. The ARMA is used for example in the area of econometrics, statistics and for wind speed prediction.

Lujano-Rojas et al. [94] compared the ARMA model and the artificial neural network by predicting hourly the average wind speed. Therefore, they created ARMA models to the wind speed time series of three months of the years 2007 and 2008 for three weather stations. Furthermore, they trained an artificial neural network for hourly average wind speed forecasting. In order to evaluate the forecasting errors of the ARMA models and the artificial neural network, Lujano-Rojas et al. used the data gathered from the three weather stations in 2009. The results of the evaluation showed that the prediction accuracy of the time between one and ten hours ahead could be improved in some cases by the ARMA about 17 %. However, in other cases the forecasting errors of the artificial neural network were about 1 % smaller than the ARMA model.

Xu and Zeng [95] used the ARMA to predict the network traffic in order to detect intrusions or attacks. Therefore, they combined the prediction with an intrusion detection system. For the initialisation of the ARMA model they collected 500 data samples. In order to validate the ARMA model, Xu and Zeng used 40 field devices and five routers in their experiment, in which the field devices transmitted the data to a gateway using the routers. The result showed, that the prediction performance

is better than other models for one and k-step-ahead prediction. Furthermore, more than 90 % of the intrusions were detected using the combination of an ARMA predicted network traffic and an intrusion detection system.

4.3 Evaluation

To determine the ability of the Kalman filter and the ARMA for predicting the car state in the driving system, their accuracy were measured. Therefore, both algorithms were implemented in the prediction engine module of the driving system. The algorithms were prepared to do a 2.5, 5 and 10 seconds prediction of the driving speed, which is part of the car state. The prediction was done in near-time, as the driving system is using the predicted data to create recommendations. To have the same data basis for the evaluation of the algorithms, the driving speed of a vehicle was recorded during a 15 minutes journey on a rural road. The journey was done using a driving simulator. Figure 4.3 shows the recorded driving speed that was the basis for the evaluation of the algorithms.

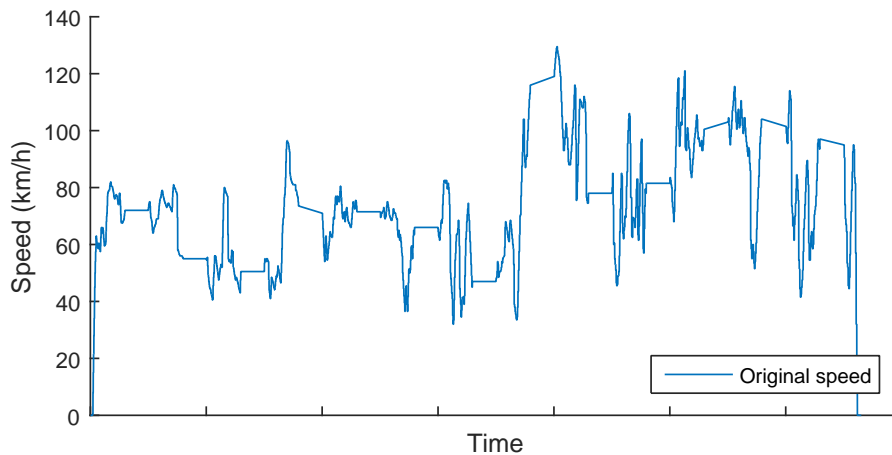

Figure 4.3: Captured driving speed of the journey using a driving simulator

As the driving system is a real-time application, the recorded driving speed was played back using a CAN bus simulation software to which the driving system was connected. For evaluating the accuracy of the algorithms for a 2.5, 5 and 10 seconds prediction, six runs were used, in which the average deviation of the predicted driving speed from the captured driving speed was calculated. In the first run, the ARMA and Kalman filter had to do a forecast of 2.5 seconds of the captured driving speed,

whereas the second run consisted of a 5 second prediction of the captured driving speed. Finally, the ARMA and Kalman filter were used to do a 10 seconds prediction of the recorded driving speed in the third run.

In each run, the Kalman filter was initialised with the value 0 for the previous driving speed and previous error covariance. After the initialisation of the Kalman filter, it started to predict the driving speed for the given period of time (i.e. 2.5, 5 and 10 seconds) and to correct the prediction using the driving speed measurement, according to the Kalman filter cycle and the equations presented in Section 4.1. In contrast to the Kalman filter, the ARMA needed a certain amount of data until it was able to do a prediction. Thus, a hundred driving speed measurements were collected from the car, until ARMA started to predict the future driving speed. After the enough data was gathered, the first step was to create a time series on the basis of the collected data. Based on the time series an ARMA model was generated, according to the equations presented in Section 4.2. After the generation of the ARMA model, it was able to predict the future driving speed for the given period of time (i.e. 2.5, 5 and 10 seconds). However, on receiving of a new driving speed measurement, the collected data was updated with the received measurement. The updated data collection was then used to create a new time series containing the updated data. On the basis of the newly created time series, a new ARMA model was generated. Thus, the updated ARMA model was able to do the prediction considering the current driving speed measurement. This cycle of the ARMA was done for every new driving speed measurement of the car.

4.4 Results

The presented algorithms have different approaches for the prediction of values, why the algorithms needed to be evaluated in order to find a suitable algorithm for the driving system to predict the car state. The evaluation of the prediction algorithms was based on the data collected from a driving simulator. Therefore, the driving speed information of a car was collected during a 15 minutes journey on a driving simulator. To compare the algorithms, their accuracy was measured during the prediction of the driving speed. The algorithms had to do a 2.5, 5 and 10 seconds prediction.

	Average deviation from original driving speed		
	2.5 seconds forecast	5 seconds forecast	10 seconds forecast
ARMA	3.96	5.62	8.80
Kalman filter	9.90	19.90	39.21

Table 4.1: The accuracy of the prediction algorithms showing the average deviation from the original driving speed in each run

The results presented in Table 4.1 show that the prediction of the ARMA was more accurate than the predicted driving speed of the Kalman filter, as the ARMA considers also the history of the values.

In the first run of the evaluation, the algorithms had to predict the driving speed of the car 2.5 seconds to the future. The figures 4.4 and 4.5 show the result of the Kalman filter and ARMA when predicting the driving speed 2.5 seconds to the future. The figures show besides the predicted driving speed also the original driving speed that was captured and used as the basis for the prediction. As shown in Figure 4.4 (1), the prediction of the Kalman filter had a bad accuracy when the driver accelerated or decelerated strongly. However, the accuracy of the prediction was better for situations when the driver accelerated or decelerated slightly or when the driver was driving with a constant speed. Figure 4.4 (2) shows the deviation of the predicted driving speed from the original driving speed when using the Kalman filter. The average deviation of the predicted driving speed was 9.90 km/h. In contrast, the 2.5 seconds prediction of the ARMA was more accurate than the Kalman filter as shown in Figure 4.5, especially in situations when the driver accelerated or decelerated the car. However, the ARMA had trouble with predicting the driving speed when the driver changed from strong deceleration to strong acceleration or vice versa. In such situations ARMA assumed that the driver will still decelerate strongly. The deviation of the predicted driving speed from the captured driving speed using ARMA is shown in Figure 4.5 (2). The average deviation of the predicted driving speed was 3.96 km/h when using ARMA.

In the second run, the algorithms were prepared to do a 5 seconds forecast of the driving speed. The results of the second run are presented in Figure 4.6 and 4.7. The results show that the ARMA was more accurate than the Kalman filter in predicting the driving speed 5 seconds to the future. In comparison with the first run, the prediction accuracy of the Kalman filter decreased, as the average deviation of

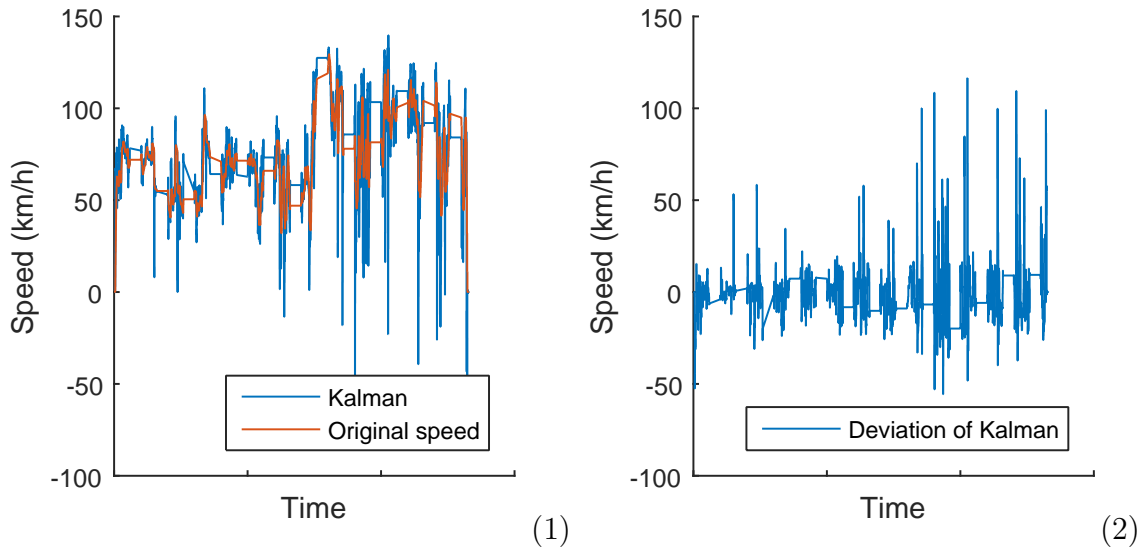

Figure 4.4: 2.5 seconds prediction of the driving speed using the Kalman filter (1) and the deviation from the original speed (2)

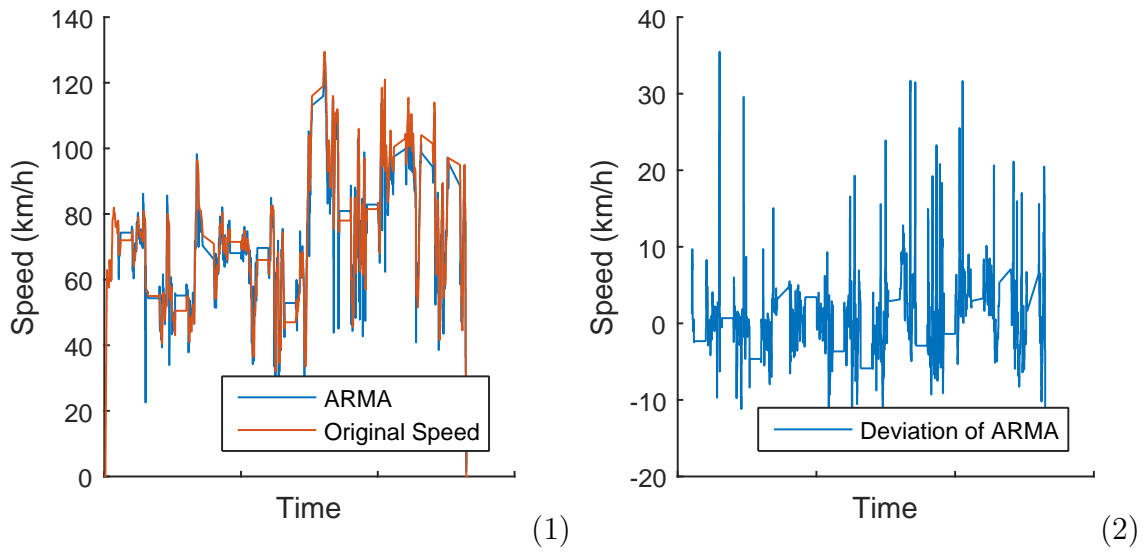

Figure 4.5: 2.5 seconds prediction of the driving speed using ARMA (1) and the deviation from the original speed (2)

predicted driving speed from the original driving speed was 19.79 km/h. Especially in situations, in which the driver accelerated or decelerated strongly, the peaks of the predicted driving speed were higher than in the first run of the Kalman filter and, thus, deviate significantly from the original driving speed, as illustrated in Figure 4.6 (2). Figure 4.7 (1) shows that the accuracy of the ARMA decreased in the second run, as well. However, ARMA predicted still more accurate than the Kalman filter, as the average deviation of the predicted driving speed was 5,62 km/h. In com-

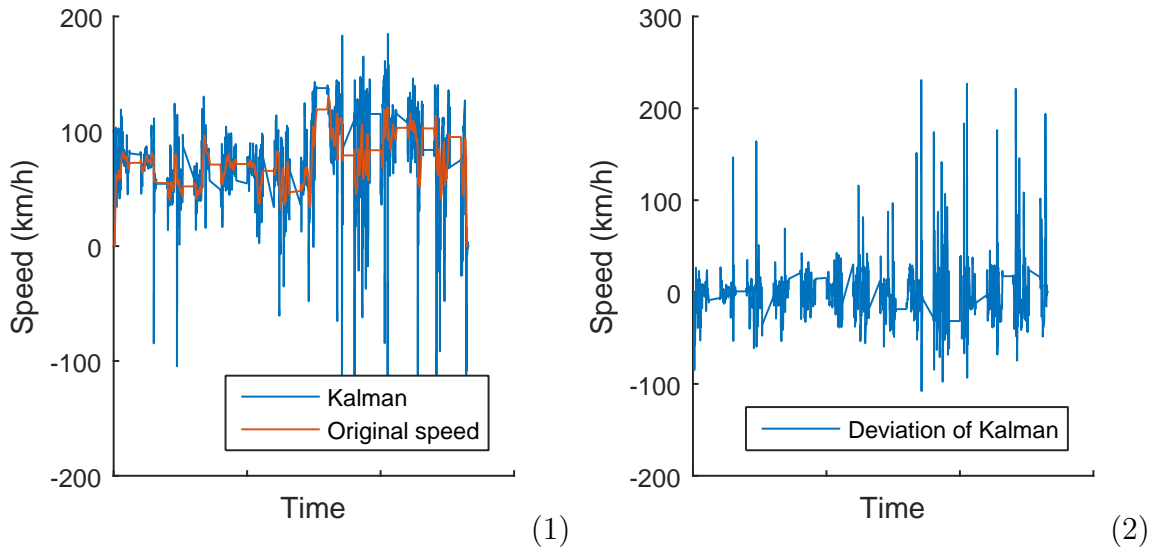

Figure 4.6: 5 seconds prediction of the driving speed using the Kalman filter (1) and the deviation from the original speed (2)

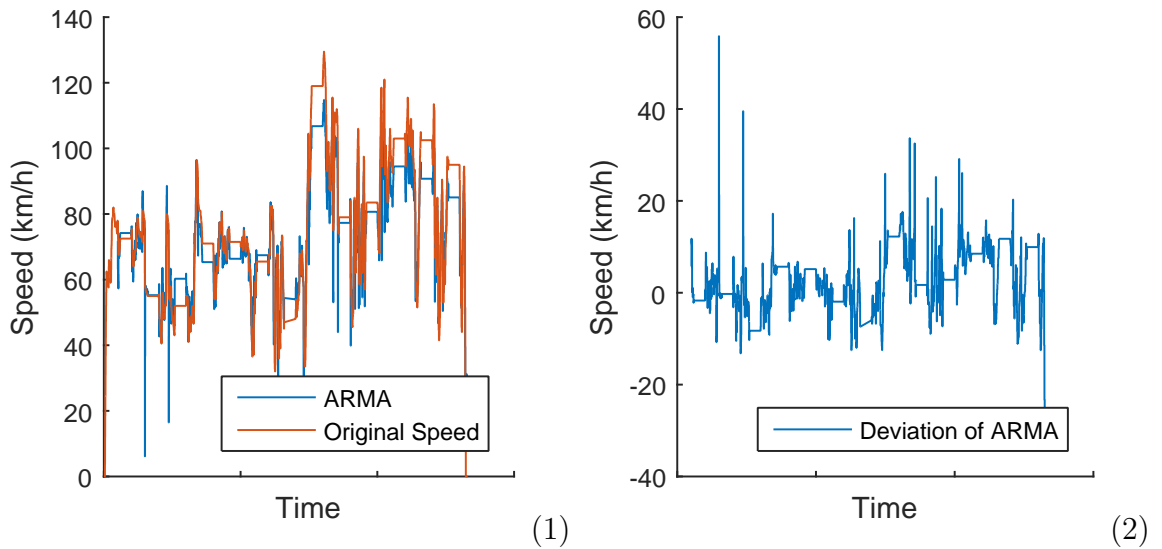

Figure 4.7: 5 seconds prediction of the driving speed using ARMA (1) and the deviation from the original speed (2)

parison with the previous run, the predicted driving speed in ARMA had lower peaks in situations when the driver changed from strong deceleration to strong acceleration or vice versa (see Figure 4.7 (2)). However, this did not lead to an increase of the accuracy, instead, the lower peaks decreased the accuracy of the prediction.

During the last run, the algorithms had to do a 10 seconds prediction of the driving speed. Figure 4.8 and 4.9 illustrate the results of the last run. According to the results, the ARMA was more accurate than the Kalman filter. In comparison with

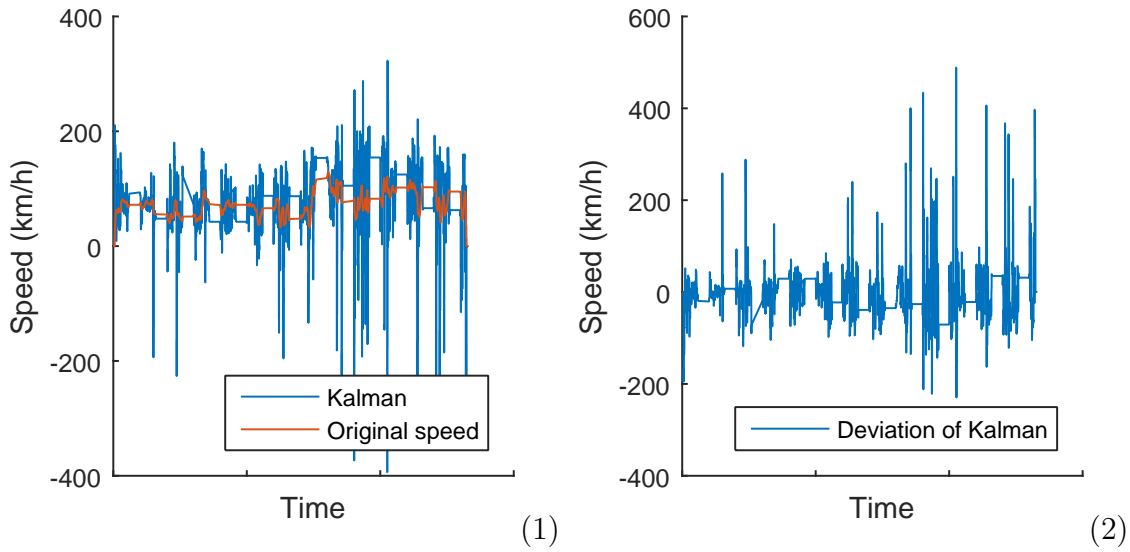

Figure 4.8: 10 seconds prediction of the driving speed using the Kalman filter (1) and the deviation from the original speed (2)

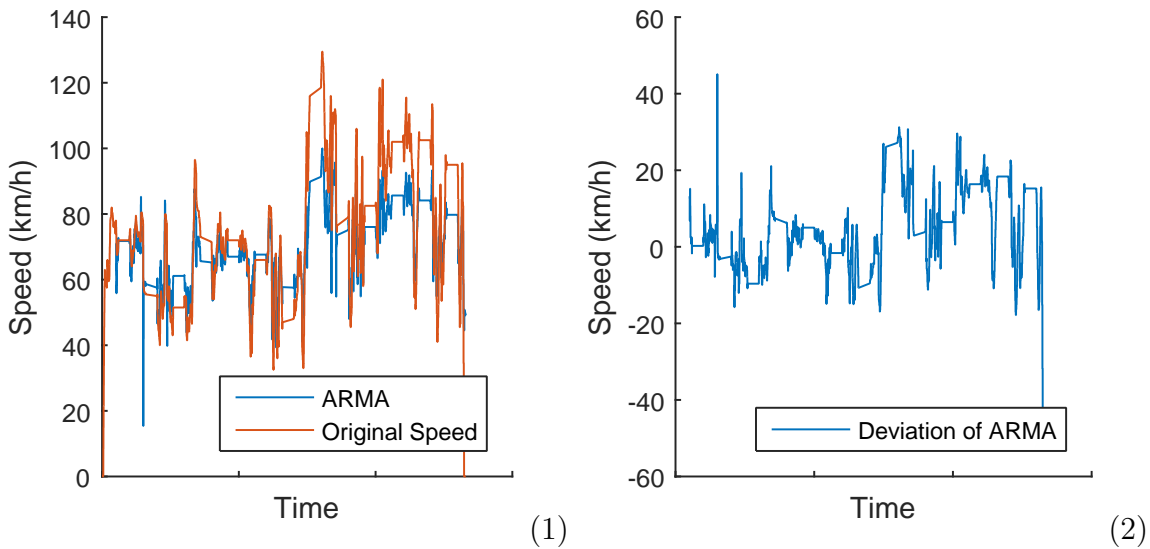

Figure 4.9: 10 seconds prediction of the driving speed using ARMA (1) and the deviation from the original speed (2)

the first and second run, the prediction accuracy of the Kalman filter decreased again, as the average deviation of the 10 seconds predicted speed from the original speed was 39.21 km/h. In this run, the Kalman filter had the same behaviour as in the previous runs, which led to an increase of the predicted driving speed peaks, as shown in Figure 4.8 (2). Thus, this led to an increase of the deviation from the original driving speed in this run, why the accuracy of the prediction decreased. However, in this run the accuracy of the ARMA was also higher than the accuracy of the Kalman

filter. The average deviation of ARMA in the third run was 8,80 km/h. Compared to the first and second run, the peaks of the predicted driving speed decreased again when using ARMA in situations when the driver changed from strong acceleration to deceleration or from strong deceleration to acceleration, as shown in Figure 4.9 (2). However, just like in the second run the lower predicted peaks did not lead to a higher accuracy. In contrast, they led to a lower accuracy of the prediction.

4.5 Discussion

The goal of the evaluation was to measure the accuracy of the prediction algorithms. Therefore, the algorithms had to predict the driving speed of the car 2.5, 5 and 10 seconds to the future. In order to have the same data basis, the driving speed of a car was captured during a 15 minutes journey on rural road using a driving simulator. During the evaluation the recorded driving speed was used in the Kalman filter and ARMA for the 2.5, 5 and 10 seconds prediction of the driving speed. In order to measure the accuracy of the algorithms, the deviation of the predicted driving speed and the original driving speed was calculated for each run.

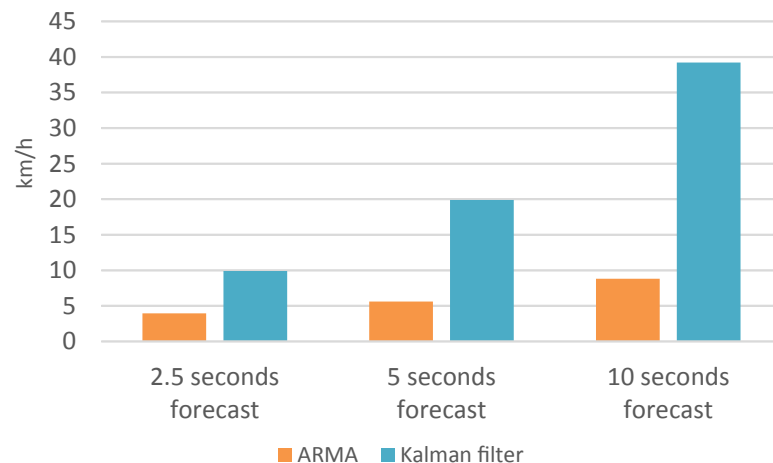

Figure 4.10: The results of the evaluation showing the average deviation from the original driving speed for every run

The evaluation showed that the prediction of the driving speed using ARMA is more accurate than using the Kalman filter. In contrast to ARMA, which considers all past measurements of the driving speed, the Kalman filter considers only the last measurement of the driving speed. This led to an imprecise prediction of the

driving speed with the Kalman filter. The imprecision of predicted driving speed increased when the Kalman filter was used to predict the driving speed further in time, especially in the second and third run when predicted 5 and 10 seconds to the future, as shown in Figure 4.10. This correlates with the findings of Pentland and Liu [90], who revealed that the Kalman filter is only useful in short time prediction like a fast hand motion. Furthermore, Figure 4.10 shows that the prediction accuracy decreased also for ARMA when predicting further in time. However, according to the results in Table 4.1, the imprecision of the ARMA increased from the 2.5 second forecast to the 10 second forecast by an average deviation of the predicted driving speed of about 4.5 km/h, whereas the Kalman filter increased its imprecision by an average deviation of the driving speed of about 29 km/h. Furthermore, during the 10 seconds prediction, the accuracy of the ARMA was still better than the prediction accuracy of the Kalman filter when predicting 2.5 seconds to the future. Thus, it can be seen that the Kalman filter is not suitable for predicting the car state in the prediction engine module.

According to the results of the evaluation, ARMA will be used in the prediction engine module to predict the state of the car, which is represented by the car speed, engine speed and the distance to the car in front. As ARMA had the best accuracy when predicting 2.5 seconds to the future, the prediction engine module will predict the car state 2.5 seconds to the future. The prediction of the car state 2.5 seconds to the future allows the driving system to show a recommendation to the driver before a breaking of the driving rule or a deviation from the typical driving behaviour occurs. Thus, the driver has the opportunity to avoid a breaking of the driving rule or to correct the driving behaviour according to the typical driving behaviour.

Chapter 5

Rule selector module

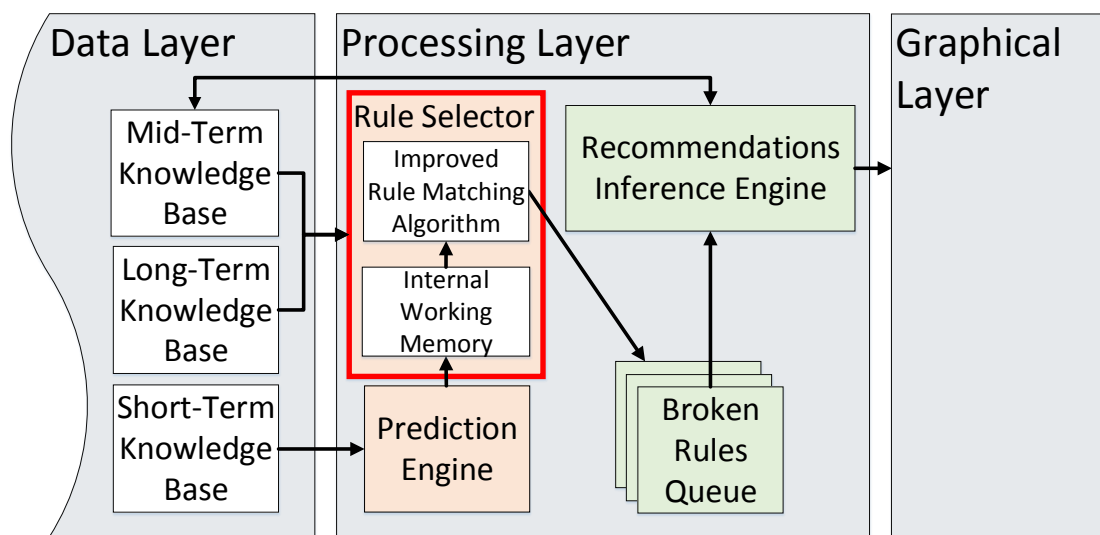

Figure 5.1: The data flow of the processing layer with the focus on the rule selector module and its local working memory and improved rule matching algorithm

The detection of broken driving rules or deviations from the typical driving behaviour is done in the rule selector module of the processing layer, see Figure 5.1. The detection allows to determine whether the driver is driving energy-inefficient, unsafe or does not drive as usual. On the basis of the detection, a recommendation to the driver can be shown to increase the energy-efficiency or safety. Furthermore, the recommendation can be used to point the driver to the current driving behaviour that deviates significantly from the typical driving behaviour, why the driver should improve the current driving behaviour. For the detection of the broken driving rules

and deviations from the typical driving behaviour rule matching algorithms can be used. Rule matching algorithms are pattern matching algorithms that match rules to a data set. They are often used in production systems to determine, which rules of the production system have to be fired on the basis of the data stored in the working memory of the production system. Therefore, the rule matching algorithms receive information about the changes made to the working memory of the production system and determine the changes that have to be done in the conflict set. The conflict set consists of all rules that have to be fired. The order, in which the rules are fired are defined in the conflict set resolution strategy, such as first come, first serve or the prioritisation of the rules. Regarding the driving system, the conflict set is represented by the broken rules queue module of the processing layer (Figure 5.1). It is solved by the recommendations inference engine using the first come, first serve principle. The rule matching algorithms compare production, also called rules, against data tuples, also called facts. In the driving system, the rules are represented by the driving rules defined in Section 3.3. Furthermore, the rules are used to define when a deviation from the typical driving behaviour is detected. The facts are represented by the information that are stored in the short-term knowledge base and the information about the predicted car state. The facts are passed from the prediction engine module to the internal working memory of the rule selector module. The rules are described by conditions and consequences. For example, regarding the rule "shift as soon as possible", a condition of that rule would be $Rpm > 2500$ and a consequence would be to show the recommendation to shift the gear. The rule is passed to the conflict set when the facts match the conditions of that rule. According to the conflict set resolution strategy of the recommendations inference engine, the consequence of the rule is fired when the conflict set is solved. There are several rule matching algorithms such as Rete, Treat or Leaps. In the following sections the rule matching algorithms are briefly explained. After the explanation of the algorithms, the improved rule match algorithm is introduced and evaluated. Finally, the result of the evaluation are presented and discussed.

5.1 Rete

The Rete algorithm [96] uses a tree structured network to represent the rules, whereas every rule has its own network. The network is also called Rete network. Figure 5.2 shows a Rete network that represents a rule. A Rete network contains alpha and beta

nodes. Every alpha node of a network represents one condition of a rule and stores the fact that matched the condition of the node in its node memory. The beta nodes are used to store partial matches when different facts are joined from the parent nodes. Parent nodes can be either an alpha node or another beta node. On every update of a fact in the working memory, the old fact stored in the alpha and beta node memories are deleted. The updated fact is then pushed into the Rete network that passes the fact to the corresponding alpha nodes. The alpha node starts then to check whether the new fact satisfies its condition. In case the fact satisfies the node condition, the node stores the fact in the alpha memory and passes it to the beta node. The beta node represents the joining of parent nodes and checks whether the joining between two parent nodes (i.e. two alpha nodes or one beta and one alpha node) is satisfied on the basis of the newly received fact. When the beta node is satisfied and has no child node, the rule is put into the conflict set. However, if the beta node has a child node, the fact is passed to the child beta node that checks again if the joining of its parent nodes are satisfied. To solve the conflict set in Rete, a conflict set resolution strategy has to be defined like first come, first serve.

Figure 5.2 illustrates the data flow of the Rete algorithm on the basis of the Rete network of the driving rule $Rule_1$ "shift as soon as possible" with the conditions $Rpm > 2500$ and $Gear < 6$. The initial working memory, the memories of the nodes within the Rete network and the conflict set are empty. In the next cycle of the driving system, the facts $Rpm : 3000$ and $Gear : 3$ are added to the working memory. The working memory passes the newly arrived facts to the Rete network using an add operation. The root node of the Rete network passes the incoming facts to the corresponding alpha nodes that checks if the facts satisfy their conditions and stores them in their so called alpha memory. The facts are then passed to the beta node, that proofs if the incoming facts satisfy the joining of the parent nodes. In case the fact satisfies the joining of the two parent nodes, the facts are stored in the so called beta memory and $Rule_1$ is put to the conflict set. In the next cycle of the driving system, the fact $Rpm : 3000$ is updated to $Rpm : 2400$. This update causes a delete operation within the Rete network, in which the old fact $Rpm : 3000$ is removed from the alpha and beta node memories and $Rule_1$ is removed from the conflict set. The delete operation is followed by an add operation that passes the new fact $Rpm : 2400$ to the Rete network. As the fact $Rpm : 2400$ does not satisfy the condition $Rpm > 2500$ of the alpha node, it is not stored in the alpha node memory and is not passed to the beta node. Thus, $Rule_1$ is not put into the conflict set again.

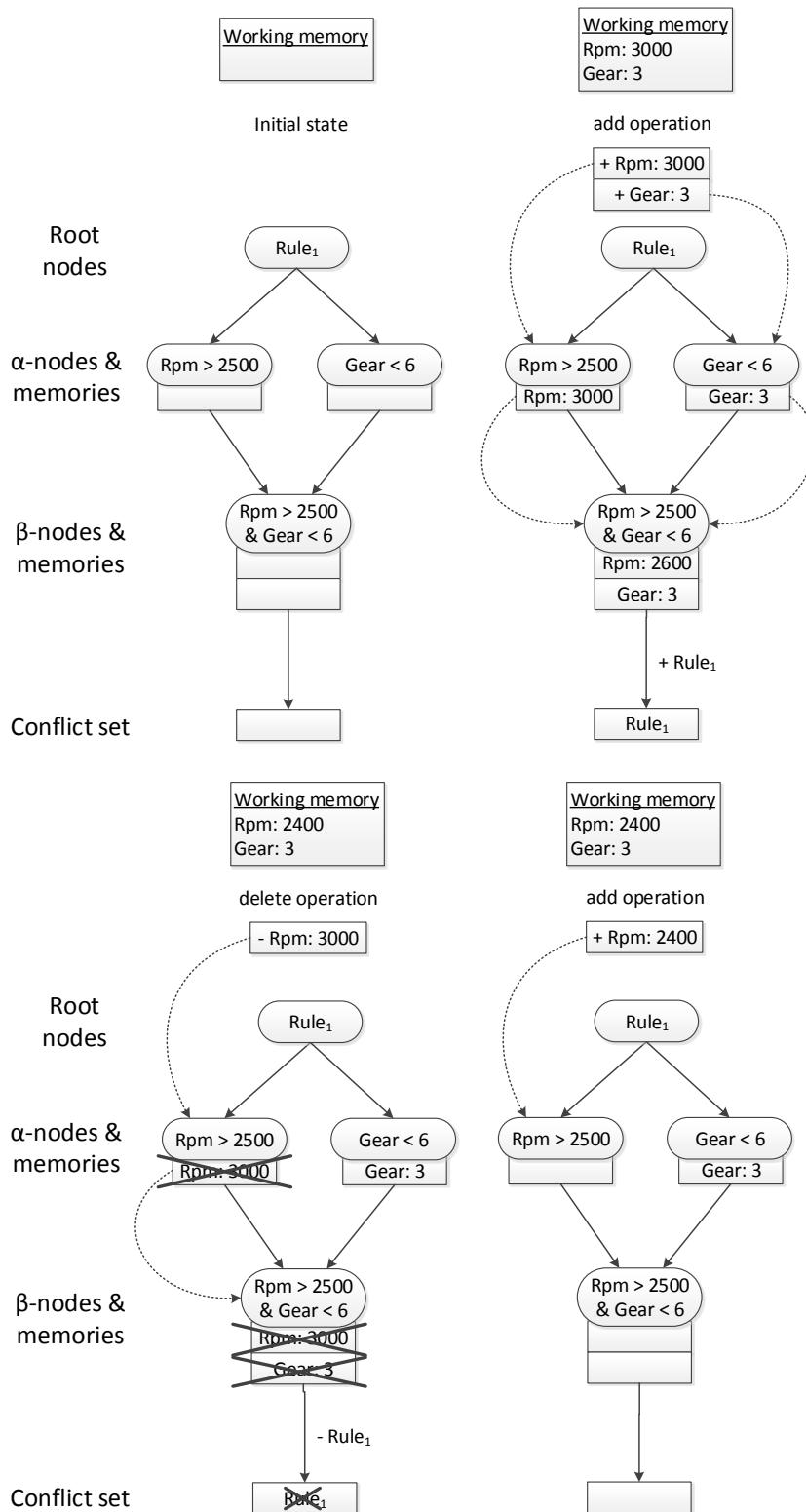

Figure 5.2: Illustration of the Rete algorithm with the operations add and delete

5.2 Treat

The Treat algorithm [97] is the evolution of the Rete algorithm. It tries to improve the Rete algorithm in the memory usage by omitting the beta nodes. Thus, the Treat algorithm does not use beta nodes to join the parent nodes and, thus, it does not use a beta memory to store the facts that satisfied the joining of the parent nodes. Instead, the Treat algorithm checks the satisfaction of the joining when required. For example, when an incoming fact satisfies an alpha node, the fact is stored in the alpha memory of that node and the joining of that alpha node is recomputed. If the result of the computation is positive the rule is added into the conflict set. The conflict set resolution strategy of the Treat algorithm must be defined similarly to the conflict set resolution strategy of the Rete algorithm.

Figure 5.3 illustrates the process on the basis of the driving rule *Rule₁* "shift as soon as possible" with the conditions $Rpm > 2500$ and $Gear < 6$. Treat represents the driving rule by using also a Rete like network, however, without the beta nodes. The initial working memory consists the facts $Rpm : 3000$ and $Gear : 3$, whereas the fact Rpm is updated in the next cycle to $Rpm : 2400$. An update of a fact causes the Treat algorithm first to delete the old fact from the alpha node memories and to remove the rule *Rule₁* from the conflict set. In the second step, the Treat algorithm is using an add operation, in which the new fact is passed to the corresponding alpha node that checks if the fact satisfies its condition. On satisfaction of the condition, the intermediate relations of the alpha nodes are recomputed. This causes in our example an insertion of *Rule₁* into the conflict set.

According to the results of Miranker [97], the Treat algorithm is more effective than the Rete algorithms, as it needed fewer comparisons until the facts were bound to the corresponding nodes and less memory was needed, due to the missing beta nodes and beta memories. Furthermore, during a deletion of a fact, the Treat algorithms manipulates the alpha nodes and the conflict set directly, instead of recomputing the joining of the alpha nodes. In contrast, Rete has to recompute the joining of the alpha nodes when a fact of the working memory is deleted, to keep the beta nodes up to date. However, Nayak et al. [98] showed that the Rete algorithm outperforms the Treat algorithm. Especially, when it is used in static structures, as the Rete algorithms joins the alpha nodes in static structures once, instead of recomputing the joinings every time. According to Nayak et al., a structure is static when a single fact

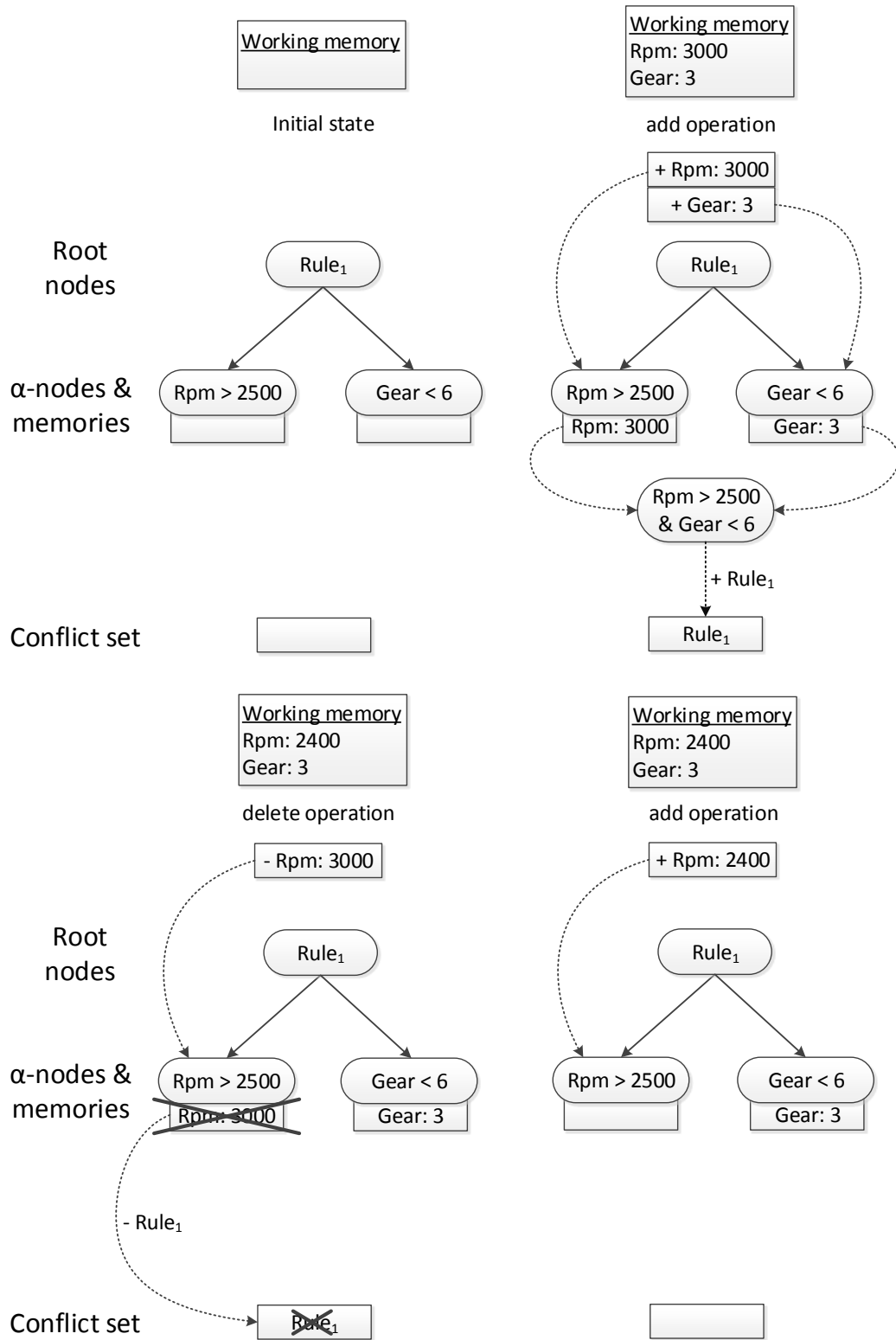

Figure 5.3: Illustration of the Treat algorithm with the operations add and delete

is not removed from the working memory. Thus, the Rete algorithm has to compute every join only when the whole structure is removed or added. Furthermore, the results of Nayak et al. differ from Miranker's results in [97], as Miranker counted only the number of comparisons, which may not reflect the intrinsic differences between the match algorithms [98].

5.3 Leaps

The Leaps (Lazy Evaluation Algorithm for Production Systems) algorithm [99] is based on the Treat algorithm. Thus, it uses alpha nodes to store the facts that satisfy the alpha node conditions and calculates the intermediate joins of the alpha nodes when they are needed. In contrast to the Rete and Treat algorithm, Leaps provides also a conflict set resolution strategy by combining the conflict set resolution strategy with the search for rules whose conditions are satisfied. This allows Leaps to omit the conflict set. Instead of putting the rule whose conditions are satisfied into the conflict set, the consequence of the rule is fired immediately. Leaps is using lazy evaluation to find rules whose conditions are satisfied by inspecting the facts of a rule one by one. If a rule is found, whose conditions are satisfied, it pauses the current search and fires the corresponding rule consequence.

Figure 5.4 shows once cycle of the Leaps algorithm with two rules: *Rule₁* "shift as soon as possible" and the rudimentary rule *Rule₂*, where *Rule₁* has the conditions $Rpm > 2500$ and $Gear < 6$. *Rule₂* is illustrated only for demonstrating the process of Leaps. The rules are represented like in Treat by using a Rete like network without the beta nodes, as beta nodes are not needed in Leaps. During the initialisation phase the working memory is empty, why the alpha nodes of *Rule₁* are empty, as well. The working memory is then updated with the facts $Rpm : 3000$ and $Gear : 3$. After the update of the working memory, Leaps starts searching for the rule whose conditions are satisfied by the updated facts. In the first step it checks the conditions of *Rule₁*. In case of *Rule₁*, the facts satisfy the conditions as well as the intermediate relations of the rule. Thus, Leaps fires the consequence of *Rule₁* immediately. After the firing of the consequence Leaps would continue the search, however, the fact $Rpm : 3000$ is updated to $Rpm : 2400$. This causes Leaps to suspend the current search and to start a new search with the updated fact $Rpm : 2400$. In case, the old search did not fire a rule it would not be suspended. Instead, the updated fact would be

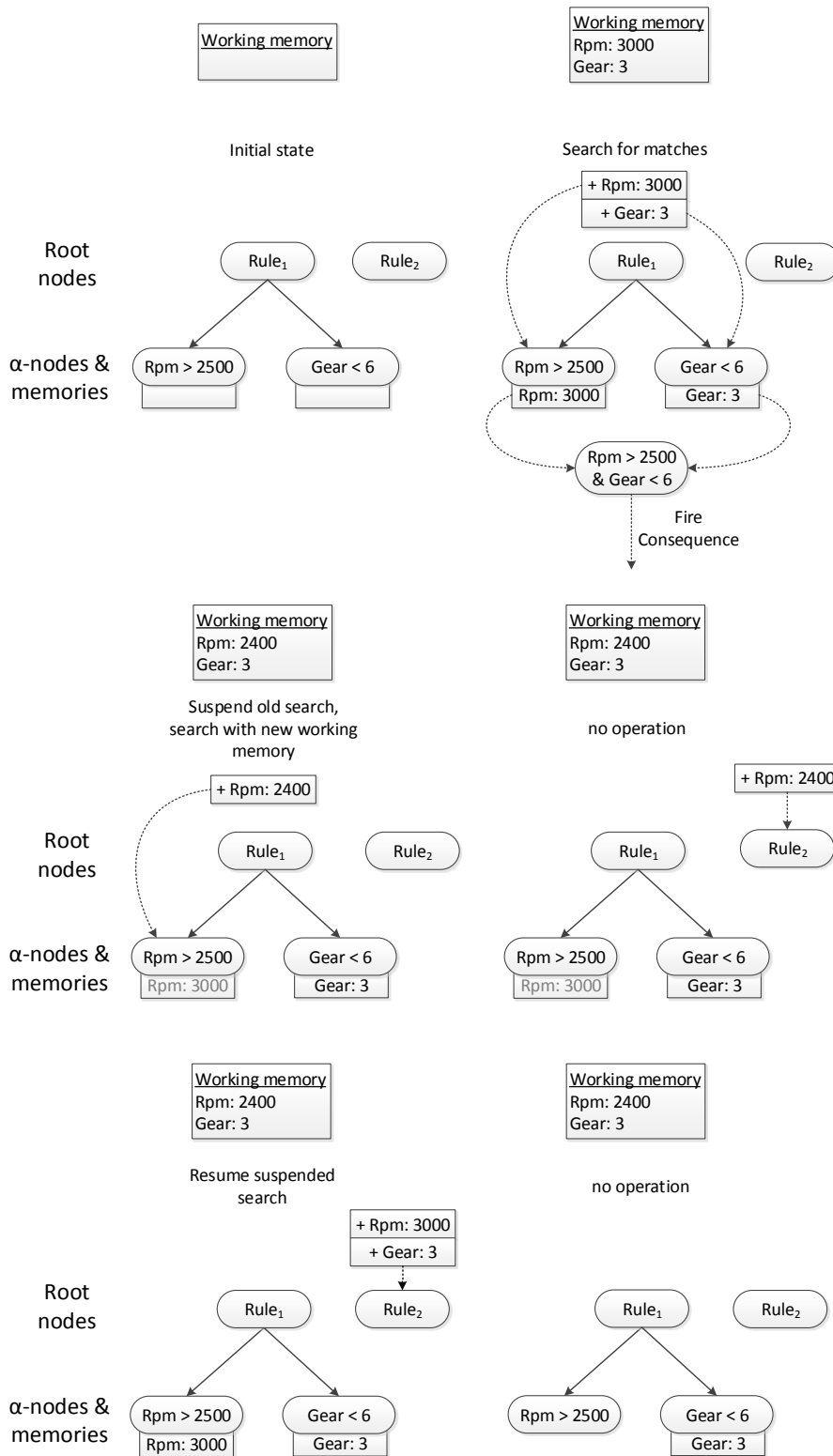

Figure 5.4: Illustration of the Treat algorithm with the operations add and delete

pushed onto a stack until the old search is finished. After that, the updated fact would be popped from the stack and Leaps would start the search with the popped fact. During the time when the old search is suspended, the corresponding facts that are stored in the alpha node memories are not deleted. Instead, they are ignored during the newly started search. When the newly started search is finished, Leaps resumes the suspended search with the old facts until all rules are checked. Finally, when the suspended search is finished, the old facts will be removed from the alpha node memories of all rules. According to the evaluation of Miranker [99], the lazy evaluation of the rules allows Leaps to increase the rule firing rates and to decrease the execution time of the algorithm. This can be achieved by Leaps, as it avoids the computation of all rules in each cycle like Rete or Treat. Instead, Leaps suspends the current search and carries on to search the rules with the updated fact. However, the current search is only suspended when a fact that is stored in the working memory is updated and a consequence of a rule was fired.

5.4 Improved rule matching algorithm

According to Nayak [98], the Rete algorithm outperforms Treat, especially in static structures [98]. Static structures are defined as facts that are not removed from the working memory [98]. As the facts within the driving system are not removed, the driving system has a static structure. Furthermore, the facts stored in the driving system are updated with a frequency of 100Hz. However, an update of the facts is neither considered in the Treat nor in the Rete algorithm. Thus, the usage of the Treat or Rete algorithm in the driving system would cause massive delete and add operations within the driving system, as the algorithms had to keep the network up to date by deleting the old and adding the new facts. Due to this fact, the Treat and Rete algorithm are not ideal for the usage within the driving system. The Leaps algorithm, which is the evolution of Treat, combines the lazy rule matching with solving the conflict set. This allows Leaps a faster firing of the rule consequences. However, this makes the Leaps algorithm also inflexible, as the conflict set resolution strategy cannot be changed. The conflict set of the introduced driving system is solved by the recommendations inference engine that processes the broken rules according to the first in, first out principle. Each rule is checked if the firing of the consequence

has to be suppressed, as the driver may be under stress. Due to this fact, the Leaps algorithm is also not an ideal solution for matching the rules against the facts in the driving system.

Based on the elaborated findings, a rule match algorithm for the usage within the driving system was created on the basis of the Rete algorithm, as the Rete algorithm is developed for environment with static structures. To avoid the delete and add operations upon every update of the facts and, thus, to improve the performance, a rule matching algorithm has been created that stores pointers to the corresponding facts within the node memories, instead of the fact itself. Thus, upon every update of the facts, the improved Rete network does not have to be updated. Instead, the network is only triggered to check whether the updated fact satisfy the node conditions. Listing 5.1 shows the abstract description of the improved rule matching algorithm. Upon every update of the facts, every improved Rete network is triggered to check its alpha nodes with the updated facts. In case the result of the checking differs from the previous result, stored within the corresponding node memory, the old result is deleted and the new result is put into the alpha node memory. If the alpha node has a child beta node, the child beta node is triggered to check whether the new result satisfies the intermediate relation of the parent nodes. Therefore, the beta nodes point to the node memory of the parents. First, the beta nodes check if both parents are updated with the updated facts. Then, the beta node checks the intermediate relation between the parent nodes using the pointers to the node memories of the parents. If the result of the checking differs from the stored value in the beta node memory, the stored value is replaced by the result of the checking. In case the beta node has a child beta node, the child beta node is triggered to do a checking. However, if there are no child beta node, the conflict set is updated according to the result of the checking. Thus, if the result of the checking was positive, which means that the rule is broken, the rule is put into the conflict set. In contrast, if the rule is not broken and the conflict set contains the rule, the rule is remove from the conflict set. The explained approach allows a faster processing of the rule matching algorithm, as it does not have to update the memory of every alpha or beta node using the updated fact. Furthermore, the improved matching algorithm avoids to store redundant information within the alpha and beta nodes, as the facts that are stored in the working memory are not stored additionally within the node memories.

```
1 For each rule do;  
2   For each alpha node in Rete Network do;  
3     Check condition of alpha node using the pointer to the  
4     fact stored in the working memory;  
5     If result of the checking differs from the stored logical  
6     value then;  
7       Store result in alpha node memory;  
8       If alpha node has a beta node then;  
9         Trigger child beta node to check the intermediate  
10        relation of the alpha nodes;  
11        If beta node has been triggered from both parents then;  
12        Check the updated values of both parents using the  
13        stored pointers;  
14        If result is true and the result differ from  
15        the stored logical values then;  
16          Store result in beta node memory;  
17          If beta node has children then;  
18            Trigger child beta node to check intermediate  
19            relation in the same way as current beta node;  
20          Else;  
21            Put rule into the conflict set;  
22          End if;  
23        Else if result of both values are false and result  
24        differs from the stored logical values then;  
25          Store result in beta node memory;  
26          If beta node has children then;  
27            Trigger child beta node to check intermediate  
28            relation in the same way as current beta node;  
29          Else;  
30            Remove rule from conflict set;  
31          End if;  
32        End if;  
33      Else if alpha node condition is satisfied and rule is not  
34      in conflict set then;  
35        Put rule into the conflict set;  
36      Else if alpha node condition is not satisfied and rule is  
37      in conflict set then;  
38        Remove rule from conflict set;  
39      End if;  
40    End for;  
41  End for;
```

Listing 5.1: Abstract improved rule matching algorithm, which shows the matching of the rule using the facts stored in the working memory

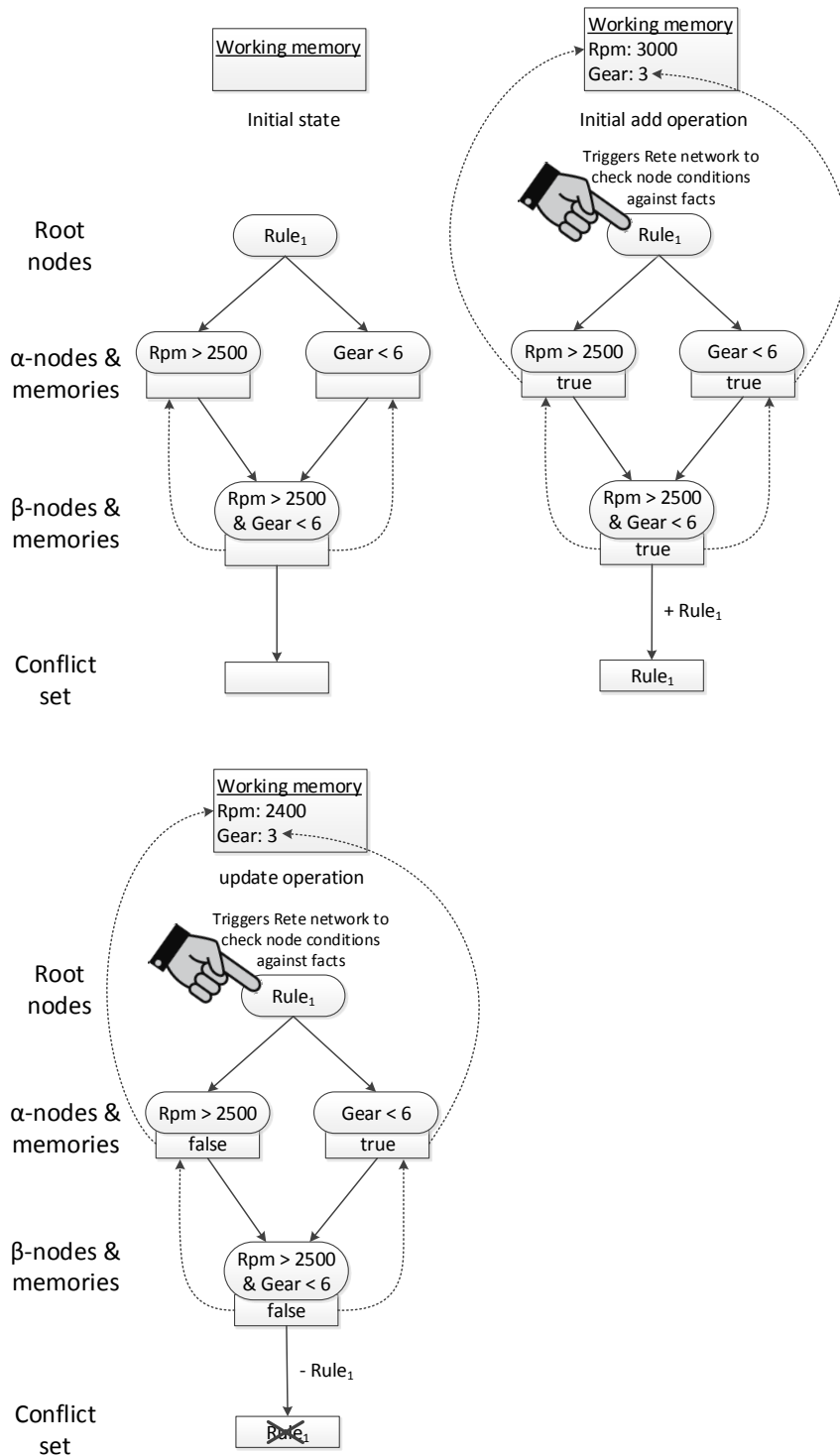

Figure 5.5: The improved rule matching algorithm is using pointers to the facts and triggers the improved Rete network to check the conditions against the facts on every update of the working memory

Figure 5.5 shows the improved Rete network and the update process of the improved rule matching algorithm using $Rule_1$ "shift as soon as possible" with the conditions $Rpm > 2500$ and $Gear < 6$. The initial working memory is empty as well as the memory of the alpha and beta nodes. The beta node points to the memory of the alpha nodes, which is needed to check whether the intermediate relation between the parent nodes is satisfied. During the initial add operation, pointers to the facts, stored in the working memory, are passed to the corresponding alpha nodes. After the initialisation, the improved Rete network is triggered to check the conditions against the facts in the working memory, according to the abstract algorithm in Listing 5.1. First, the alpha nodes check their condition against the facts. The result of the checking is stored in the corresponding alpha node memory using a logical value. In the example, the facts stored in the working memory satisfy the condition of the alpha nodes, which then trigger the beta node to check the intermediate relation of the parent nodes. The beta node start then to check the logical values of the parent nodes, which are both true, and manipulates the conflict set by adding $Rule_1$ into the conflict set. After updating the fact $Rpm : 3000$ to $Rpm : 2400$, the improved Rete network is triggered again to check the conditions within the network against the facts. In contrast, the Treat and Rete algorithm would delete the old and add the new fact. The alpha node with the condition $Rpm > 2500$ checks its condition against the corresponding fact in the working memory and stores the result, which is in this case false, in its node memory. As the node memory was updated, the alpha node triggers its child beta node to check if the intermediate relation of its parent nodes are still satisfied, using the values stored in the node memories of the parent nodes. In the example in Figure 5.5, the beta node memory consists of the value false after the update of the fact, as the intermediate relation of its parent nodes are not satisfied. Thus, $Rule_1$ is not broken any more, why the beta nodes removes $Rule_1$ from conflict set, as it was in the conflict set before.

The basis of the rule matching algorithm is the driving rule file (DRR), which contains the rules for matching the facts within the improved rule matching algorithm against the driving rules and deviations of the current driving behaviour from the typical driving behaviour. The antecedent and consequence of the rules are based on the driving rules introduced in Section 3.3 and the typical driving behaviour described in Section 3.4. The typical driving behaviour allows to detect deviations of the current driving behaviour using the rule matching algorithm. On the basis of the rules defined in the DRR files, the improved Rete network is generated. The driving rule "shift as

```
1 #rule
2   "ecoRPM"
3 #when
4   rpm > 2500 & gear < 6
5 #then
6   shiftGear
7 #end
```

Listing 5.2: The definition of the rule "shift as soon as possible" with the corresponding consequence in the DRR file

soon as possible" describes that the driver should shift the gear before the revolutions per minute are higher than 2500 and when the gear is not the maximum gear, which is 6 in the example. The driving rule is defined in the DRR file using the schema shown in Listing 5.2.

The begin of a rule in the DRR file is indicated by the tag *#rule*, which is followed by the name of the rule that is surrounded by quotation marks, "ecoRPM" in the example. The conditions of the rule are defined after the keyword *#when*. Multiple conditions are joined by the character *&*. The condition can be defined using terms that contain the facts of the working memory. In the example the terms *Rpm>2500* and *Gear<6* are defined as the conditions of the rule, in which the facts rpm and gear were used. The consequence of the rule is indicated by the keyword *#then*. The consequences of the rules are defined in the long-term knowledge base and consist of the recommendation that should be shown to the driver. It is possible to define multiple consequences in a rule in order to show the driver multiple recommendations.

Based on the rule defined in the DRR file, the improved rule matching algorithm creates the corresponding improved Rete network. The abstract algorithm for generating the improved Rete network is shown in Listing 5.3. First, a root node is created for a rule that is defined in the DRR file. Then, the algorithm starts to parse the DRR file to find defined conditions. For any found condition, the improved rule matching algorithm creates an alpha node and adds it as a child to the root node. In case that the rule contains another condition, the improved rule matching algorithm creates another alpha node and adds it also as a child of the root node. Additionally, it creates a beta node that represents the intermediate relation between the created alpha nodes and adds the newly created beta node as a child node of the created alpha nodes. Furthermore, pointers to both alpha node memories are stored in the

```
1 For each rule in DRR file do;  
2   Create a root node;  
3   If there is a condition in driving rule then  
4     Create an alpha node using the condition and set it as a  
       child of the root node;  
5     While there are further conditions in the driving rule do;  
6       Create an alpha node using the condition and set it as a  
         child of the root node;  
7       Create a beta node;  
8       Set beta node as a child of the new created alpha node;  
9       Pass beta node a pointer to the memory of the new alpha  
         node;  
10      If there is a former created beta node;  
11        Set new beta node as a child of the former created beta  
          node;  
12        Pass beta node a pointer to the memory of the former  
          created beta node;  
13      Else  
14        Set new beta node as a child of the former crated alpha  
          node;  
15        Pass beta node a pointer to the memory of the former  
          created alpha node;  
16      End if;  
17    End while;  
18  End if;  
19 End for;
```

Listing 5.3: Abstract network generation algorithm that illustrates the generation of the improved Rete network based on the rules defined in the DRR file

beta node. After the generation of the improved Rete network, the improved rule matching algorithm starts to monitor the working memory for an initial add of a fact in order to pass the pointer to the corresponding alpha nodes and, thus, to match the facts against the rules.

5.5 Evaluation

To determine the performance differences between Rete, Treat and the improved rule matching algorithm, the algorithms were implemented in the Rule Selector module of the driving system. For measuring the performance of the rule matching algorithms, Miranker [97] and Nayak [98] used different metrics in their experiments. Therefore, a

combination of the metrics was used in the evaluation of the improved rule matching algorithm. The following metrics were used by Miranker and Nayak to evaluate the Rete and Treat algorithms and was also used in the evaluation of the improved rule matching algorithm:

- Counting the comparisons of the facts against the node conditions
- Counting the accesses to the node memories
- Measuring the average execution time of the algorithms

To match the facts against the driving rules, the improved rule matching algorithm as well as the Rete and Treat algorithm were evaluated using the three driving rules with their corresponding rule conditions. The initialisation of the three driving rules resulted in different Rete networks in order to measure the performance of the algorithms when using different rules with different conditions. The following rules were used to initialise the rule matching algorithms during the evaluation.

1. Shift as soon as possible;
Conditions: $Rpm > 2500$ and $Gear < 6$
2. Do not exceed the speed limit;
Conditions: $Carspeed < Speedlimit$
3. Keep enough distance to the car in front;
Conditions: $DistanceToCarInFront < Carspeed/2$

The driving rule (1) caused a generation of a Rete like network within the rule matching algorithms with one root node, two alpha nodes that consists the conditions $Rpm > 2500$ and $Gear < 6$ and one beta node that is responsible for the checking of the intermediate relation between the alpha nodes. The second driving rule caused the rule matching algorithms to generate a Rete like network with only one root node and one alpha node with the condition $Carspeed < Speedlimit$. The rule matching algorithms generated a Rete like network for the driving rule (3) with one root node and one alpha node that consisted of the condition $DistanceToCarInFront < Carspeed/2$. In contrast to the condition of the driving rule (2), in which the rule matching algorithms has to compare the facts with each other, the rule matching algorithms have to do additionally a calculation in right part of the condition of the driving rule (3) which is $Carspeed/2$.

The evaluation of the algorithms were done using three drivers. Each driver has driven five journeys with a duration about 12 minutes on a driving simulator that simulated a rural road. In order to have the same data basis for each rule matching algorithm, car data like the engine speed, car speed, current gear, etc. was captured during the journey. The recorded journeys were played back on every run, which allowed the evaluation of the algorithms using the same conditions for the different rule matching algorithms. For the evaluation, 15 runs per rule matching algorithm were used. Thus, in total, 45 runs were made during the evaluation, in which the comparisons of the facts against the node conditions and the accesses to the node memories of the algorithms were counted. Furthermore, during the runs, the average execution time of the algorithms were measured, as well. In the first 15 runs, the Rete algorithm was evaluated. In the second 15 runs, the defined metrics were measured for the Treat algorithm. Finally, during the last 15 runs the metrics of the improved rule matching algorithm were measured. During all runs, the rule matching algorithms were initialised using the driving rules (1)-(3) in order to obtain the performance of the algorithms.

5.6 Results

The evaluation of the rule matching algorithm were done using 15 journeys, in which the comparisons of the facts against the node conditions as well as the accesses to the node memories were counted and the execution time was measured. The results of the evaluation, presented in Table 5.1, showed that the improved rule matching algorithm outperforms the Rete and Treat algorithm in the environment of the driving system. The improved rule matching algorithm needed fewer comparisons of the facts to the node conditions until it bound the facts to the nodes, fewer accesses to the node memories to save the facts in the memories and took less average execution time.

Table 5.1 shows that the improved rule match algorithm needed about 210 accesses to node memories as an average of all journeys. Thus, the improved rule matching algorithm needed fewer accesses to the node memories than Rete or Treat. In contrast, Treat needed in the area of the driving system about 6311 accesses to the node memories and, thus, less accesses to the node memories than Rete. Furthermore, the improved rule matching algorithm needed in average 3544 comparisons during all journeys, why it needed fewer comparisons than the Rete algorithm that needed

Journey	Accesses to node memories			Fact comparisons against node conditions			Average execution time (in ms)		
	Improved	Rete	Treat	Improved	Rete	Treat	Improved	Rete	Treat
1	219	4331	3437	2860	4423	3462	4	11	10
2	203	8091	6945	3865	5949	4620	5	12	11
3	215	4821	3997	2960	4512	3516	5	11	11
4	317	5437	4583	3645	5357	4254	5	11	10
5	175	6873	5991	3640	5482	4314	5	12	11
6	159	11173	8515	3730	5794	4362	5	12	11
7	247	7549	7325	3695	5841	4464	4	12	10
8	207	7913	7591	3695	5813	4404	4	11	10
9	131	7981	7603	3595	5649	4248	4	12	10
10	291	6711	5467	3725	5796	4422	4	11	10
11	283	6437	5531	3835	5463	4146	4	11	10
12	191	9887	7055	3380	5362	4050	4	11	10
13	182	7148	6890	3450	5344	4110	4	12	10
14	171	7547	7059	3550	5556	4200	4	12	10
15	166	6510	6688	3540	5308	4182	4	11	9
Avg.	210.47	7227.27	6311.80	3544.33	5443.27	4183.60	4.33	11.47	10.20

Table 5.1: The result of the algorithms in 15 journeys

about 5443 comparisons. Thus, Treat outperformed Rete in the comparisons of the facts against the node condition, as well. Furthermore, the results showed that the improved rule matching algorithm outperformed Treat and Rete also in the area of the average execution time. The improved rule matching algorithm processed the facts in average in 4 ms, which is faster than Rete and faster than Treat. Furthermore, Rete was slower in processing the facts within its Rete network than the Treat algorithm, as it needed about one second longer for processing the facts than Treat, which needed about 10 seconds.

5.7 Discussion

An improved rule match algorithm was developed on the basis of the Rete algorithm. Furthermore, it was optimised for the usage in the driving system, respectively in environments whose data is changing frequently. This was achieved by adapting the alpha and beta nodes. Instead of storing all facts that satisfied the node conditions within the node memories, the alpha nodes point to the facts that are stored in the working memory and the beta nodes are pointing to the stored logical value in the alpha node memory. The nodes store only the logical value that indicates if the condition of the node is satisfied. Furthermore, the improved Rete algorithm allows

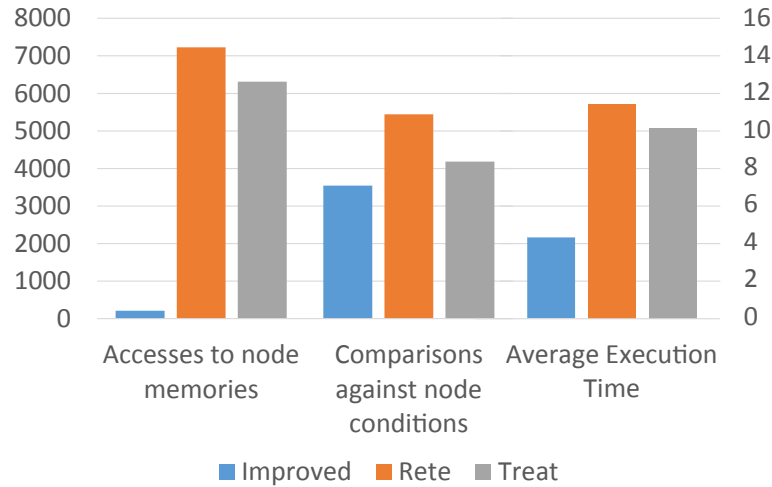

Figure 5.6: The average results of the evaluation

the definition of the rules within the DRR files, in which the terms represent the conditions of the rule. During the generation of the improved Rete network, the terms are used to pass the pointers to the corresponding nodes.

The aim of the evaluation was to compare the performance of the rule matching algorithms. Therefore, the metrics used by Miranker [97] and Nayak [98] in their evaluation were considered during the evaluation. The results of the evaluation showed that the improved rule matching algorithm outperforms Rete and Treat in the area of the driving system. Thus, it can be assumed that pointing to the facts within the nodes and storing a logical value is more efficient than passing the facts to the network and storing the fact, which satisfied the node condition within the node memories.

The average results of all journeys, illustrated in Figure 5.6, show that the improved rule matching algorithm needed about 97 % fewer accesses to the node memories than Rete or Treat during all 15 journeys. This is related to the logical value, stored in the node memories, that is touched only when the result of fact comparison differs from the stored logical value. Furthermore, the pointers to the facts allow to update the facts without the need of deleting and adding facts within the node memories, like Rete or Treat does. The Treat algorithm needed less comparisons against the node conditions and less accesses to the node memories as Rete, due to the missing beta nodes in Treat.

Furthermore, the improved rule matching algorithm needed 35 % fewer comparisons against the node conditions than Rete and 15 % fewer comparisons than Treat. This results from triggering the Rete like network in the improved rule matching algorithm to compare the facts against the node conditions after all facts are updated within the working memory. This allows to check the node conditions against the facts once. In contrast, the Treat and Rete algorithms pass every updated fact from the working memory to their networks for comparing the fact against the node conditions. For example, when the fact *Speed* and *Speedlimit* are updated within the working memory, the corresponding node in the improved rule matching algorithm has to compare the condition $Speed < Speedlimit$ once. In contrast, using Treat or Rete, an update consists of deleting the old fact within the node memory and adding the new fact. Thus, the facts *Speed* and *Speedlimit* are first removed from the node memory. Then, the new facts are passed in succession to network, which first has to check the fact *Speed* against the condition and then the fact *Speedlimit*. Thus, an update of two facts in one condition causes in Rete and Treat two comparisons instead of one comparison in the improved matching algorithm. As the Treat algorithm has no beta nodes, whose node memories have to be updated on a deletion of a fact, it needed fewer comparisons than the Rete algorithm.

The average results, shown in Figure 5.6, illustrate also that the improved rule matching algorithm processes the facts faster than Rete and Treat. The average execution time of the improved rule matching algorithm was 62 % faster than Rete and 57 % faster than the Treat algorithm. Thus, passing a pointer to the facts stored in the working memory and triggering the network to check the facts against the node conditions need less execution time than passing the facts to the network and store them in the alpha and beta node memories like in Rete, or storing the facts in the alpha node memories and recomputing the intermediate relations between the alpha nodes when needed like in Treat. According to the results, the computation of the intermediate relations between the alpha nodes is more efficient than the recalculation of the beta nodes, why the Treat algorithm processes the facts faster than Rete in the area of the driving system. As the improved rule matching algorithms is adapted to the usage in the driving system and, thus, outperforms the Rete and Treat algorithms, it will be used in the rule selector module to find an inefficient or unsafe driving behaviour as well as to detect a deviation from the typical driving behaviour.

Chapter 6

Recommendations inference engine module

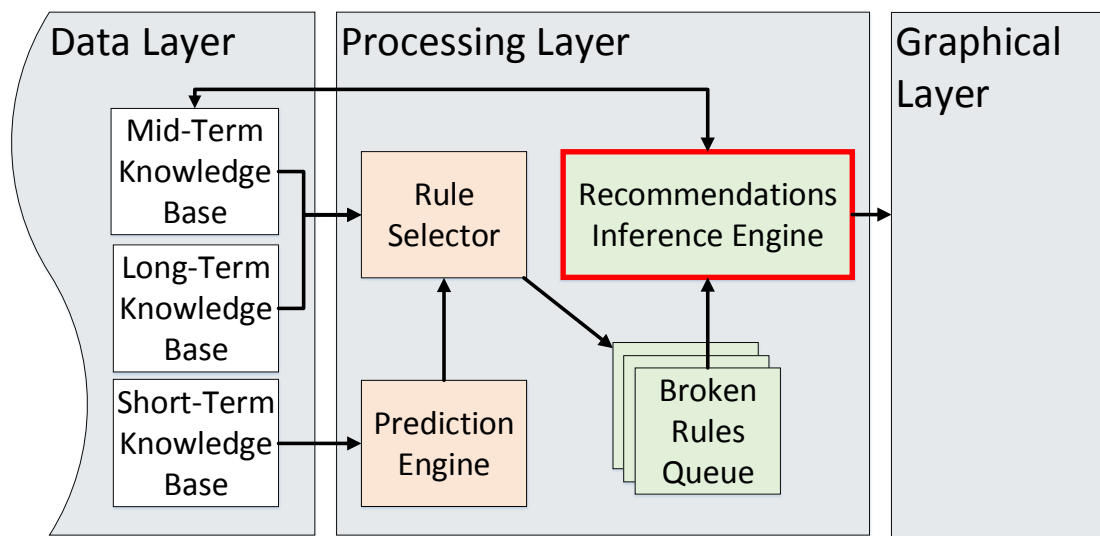

Figure 6.1: The data flow of the processing layer with the focus on the recommendations inference engine module

The driving system shows recommendations to the driver to optimise the driving behaviour regarding the energy-efficiency and safety. However, instead of showing the recommendation to the driver on detection of an inefficient or unsafe driving behaviour or when a deviation from the typical driving behaviour is detected, the driving system decides on the basis of the driver stress level and the driver reaction to already shown recommendations whether to show a recommendation or not. This allows not to distract the driver in stressful driving situations by showing recommendations and

not to bother the driver with recommendations, which are not necessary in the sense of the driver. Thus, the driving system tries to increase its acceptance by considering the individual driving behaviour of the driver.

The decision to show a recommendation is done in the recommendations inference engine module that is placed in the processing layer of the driving system, see Figure 6.1. First, the recommendations inference engine module gets a broken driving rule or deviation from the broken rules queue with the corresponding driver stress level. Furthermore, it gets the information about the driver reaction to already given recommendations, which is placed in the driving profile. Every recommendation that is stored in the driving profile contains information about its lag and the last shown recommendation. The lag of a recommendation determines the interval between two recommendations of the same type. On the basis of the gathered information from the broken rules queue, the driver stress level, the recommendation lag and the driver profile, the recommendations inference engine module creates a recommendation for the broken driving rule or deviation from the typical driving behaviour and decides on the basis of the created recommendation whether to show the recommendation. When the recommendations inference engine module decides to show the recommendation, it is passed to the graphical layer that shows the recommendation to the driver. Furthermore, it updates the last given recommendation, stored in the driving profile, with the newly given recommendation. To check if a recommendation should be shown to the driver a decision tree [100] is used.

In this chapter, first, the conditions when a recommendations should be shown to the driver are defined. Furthermore, the measurement of the driver reaction to a shown recommendations and its influences on the defined conditions are explained in section 6.1. This section is followed by the explanation of the decision tree on the basis of the definition when a recommendation should be shown to the driver and the process of the driver reaction detection. Section 6.4 explains the evaluation of the decision tree and presents the according results. Finally, the results of the evaluation as well as an alternative approach for the recommendations inference engine are discussed.

6.1 Definition when a recommendation should be shown

The goal of the driving system is to improve the driving behaviour of the driver in terms of energy-efficiency and safety by giving recommendations to the driver. Instead of showing a recommendation directly to the driver like already existing driving systems, the driving system creates recommendations when the driving rules, explained in section 3.3, are broken or when a deviation from the typical driving behaviour is detected. Based on the broken rule or deviation, the recommendations inference engine module decides whether to show a recommendation, while considering the driver needs as well as the condition of the driver that has effects on the driving behaviour. The driver needs are defined as the current driving behaviour of the driver that can be altering from the typical driving behaviour depending on the situation of the driver. For example, the driver could drive faster than usual when the driver is in hurry. Thus, the driving system has to react to the temporarily changed driving behaviour of the driver by for example avoiding to show a recommendation that could bother the driver in that situation. This can be achieved by checking if the driver adhered a previous shown recommendation. In case the driver did not adhere the recommendation given shortly before, the lag of the recommendation is increased. However, only the lag of the recommendation is increased, which was not adhered by the driver. This allows to avoid showing recommendations to the driver, which are not interesting to the driver. The lag of a recommendation is also decreased by the driving system in order to show recommendations again to the driver that were not adhered in the past. The decreasing of the lag is done on the beginning of every journey by decreasing the lag by the value that is half of the current recommendation lag. The alteration of the recommendation lag allows the driving system not only to consider the driver needs but also to adapt itself to the individual driving behaviour of the driver, by considering the different characteristics in the driving behaviour of different drivers.

Besides the driver needs and the individual driving behaviour, the driving system considers also the driver condition, like the driver stress. The consideration of the driver condition allows the driving system to avoid the distraction of the driver by showing recommendations when the driver is in stress caused for example by a stressful or complicated driving situation. Thus, the driver is able to focus on driving the

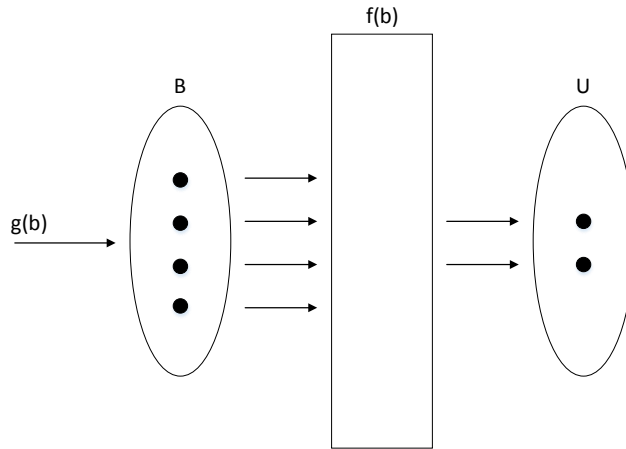

Figure 6.2: Illustration of the decision process with the detection of broken rules $g(b)$, the broken rules set B , the decision function $f(b)$ and the recommendations set U

vehicle without getting distracted by the driving system for example during a stressful or complicated driving situation. Furthermore, the risk of being involved in an accident in the consequence of the distraction caused by the driving system is reduced in such situations. The consideration of the driver condition and the adaptation of the driving system to the individual driving behaviour allows the driving system to adapt itself to the driver, as described in the idea of the driving system in Section 3.1.

Figure 6.2 illustrates the whole decision process whether a recommendation should be created and shown to the driver. Let the function $g(b)$ be the detection of the broken driving rules or deviations from the typical driving behaviour that are stored in the broken rules queue module and let B be the broken rules set that represents the broken rules queue. Furthermore, let the function $f(b)$ be the function that checks every element in the broken rules set B if it meets the conditions to show a recommendation and let U be the recommendations set that consists of recommendations that should be shown to the driver. In case function $f(b)$ detects an element in B that meets the conditions, which define when a recommendation should be shown, a recommendation is created and put into the recommendations set U . The recommendations set U is processed by the graphical layer in order to show the recommendations to the driver. The recommendations that are stored in the recommendations set U can be defined by the equation

$$\forall u \in U : \exists b \in B \mid f(b) = 1 \quad (6.1)$$

where for each recommendation u in the recommendations set U exists exactly one broken rule or deviation from the typical driving behaviour b in the broken rules set B , whose result of the function $f(b)$ is 1. The function $f(b)$ checks if a recommendation for the elements b placed the broken driving rules set B , should be given to the driver. Equation 6.2 describes the conditions, in which the result of function $f(b)$ is 1 and, thus, a recommendation u is created and put it into the recommendations set U with the purpose to show the recommendation to the driver.

$$\begin{aligned}
 f(b) = 1 \Leftrightarrow s_t < \gamma \wedge |u_t| - |u_{t-1}| > \alpha \wedge |last(u_t^\theta)| > \beta^\theta \wedge \\
 improved(u_{t-1}^\theta, u_t^\theta) = 0 \wedge predict(u_t) = 0
 \end{aligned}
 \tag{6.2}$$

Let s_t be the stress level of the driver at given time t and γ represents the stress level limit. Thus, when the driver stress level reaches the stress level limit, no recommendation is shown to the driver as the result of the function $f(b)$ is 0. In the recommendations inference engine module the stress level limit is set to a driver stress level that represents a high stress level. This allows to show recommendations only when the driver is not highly stressed and is therefore able to recognise and handle the shown recommendation. To give the driver enough time to react to a given recommendation, the time since the last recommendation was shown is calculated by subtracting the time of the current recommendation $|u_t|$ with the time of the previous shown recommendation $|u_{t-1}|$. The result is compared against α that defines the waiting time between two recommendations and is used to determine if enough time is passed since the last given recommendation in order to show a new recommendation. If the waiting time α has passed since the last recommendation was given, a new recommendation can be shown.

The function $last(u_t^\theta)$ gathers the time since the same recommendation of the current recommendation type was given before. The gathered time is compared against β^θ that is the lag of the recommendation u^θ . The lag of the recommendation represents the waiting time between two recommendations of the same type. It is altered by the recommendations inference engine module based on the adherence of the recommendation by the driver and is initialised using the waiting time α . This allows the driving system to avoid showing a recommendation when the driver is not interested in adhering the recommendation.

The function $improved(u_{t-1}^\theta, u_t^\theta)$ is 0 when the driver did not improve his driving behaviour or when the last shown recommendation and the current processed recommendation is not of the same type. The function checks first, if the last shown recommendation and the current processed recommendation are of the same type. Furthermore, when the recommendations are of the same type, it checks if the driver has improved his driving behaviour since the last shown recommendation. This allows showing recommendations to the driver when the recommendation is still broken and the driver did not improve his driving behaviour regarding the recommendation. In case the driver improved the driving behaviour, the driving system gives the driver more time in order to improve the driving behaviour further without showing the same recommendation to the driver again. This allows to avoid the repetition of a recommendation and, thus, to avoid bothering the driver with that recommendation.

The function $predict(u_t)$ is 0 when the driver will not improve his driving behaviour in future or when no predicted parameter is available for the checking the recommendation. The function validates first, if a parameter that is predicted by the prediction engine module is available for the recommendation, like the parameter *engine speed*, *driving speed* or *distance to the car in front*. When a predicted parameter is available, it checks on the basis of the predicted parameter if the driving behaviour will be improving. In case the driving behaviour is improving, no recommendation is shown to the driver. Thus, the driver gets more time to improve the driving behaviour in order to adhere the driving rule or the typical driving behaviour without getting bothered by showing a recommendation to the driver.

The waiting time α in the equation 6.2 is defined on the basis of the time until the driver is able to read or to hear the shown recommendation and on the basis of the time until the driver is able to react to a shown recommendation. The average reaction time to brake on an unexpectedly occurred traffic situation is 0.55-0.66 seconds [101, 102]. However, the brake reaction time is only valid for simple driving reactions [101]. Johansson [101] believes that the reaction time of a driver increases for complex reactions. A complex reaction is for example steering, as the drivers have to decide how to steer in order to avoid for example an accident. Summala [103] recommends to reserve 3 seconds for the steering time of a driver in order to operate safely to an unexpectedly stimulus change on the road side.

Since the drivers have to read and react to a recommendation that occurs unexpectedly on the centre console of the car and, thus, have to shift their attention to the driving system to be able to decide if the recommendation should be adhered, the recommended steering time of Summala is used as the driver reaction time to a given recommendation. Furthermore, the recommendation has to be processed by the graphical user interface of the driving system. Thus, the driving system has to show the recommendation until the driver has read the recommendation or has heard the audio voice that reads the recommendation. As the average reader needs 164 milliseconds to process a single word during reading [104], it can be assumed that the reading speed can be neglected by the driving system due to the short sentences used in the recommendations, such as "Please shift to a higher the gear". However, the reading speed of the audio voice has to be considered in the waiting time. The reading speed is dependent on the language used for the recommendations as the sentences of the recommendation are getting longer or shorter based on the used language. The reading speed of the audio voice for the recommendation with the longest sentence in the German language is 7 seconds. In contrast, the audio voice needs 4 seconds for the same recommendation in the English language. Thus, the waiting time α can be seen as 10 seconds when using the German language. Within the 10 seconds the reaction time of the driver (3 seconds) and the reading speed of the audio voice in German language (7 seconds) are considered.

Summarised, the function $f(b)$ with the parameter b is 1 and, thus, the recommendation u is put into the recommendations set U , when the driver is not highly stressed, enough time has passed between the last shown recommendation and the current recommendation as well as enough time has passed between the recommendations of the same type and when the driver has not improved the driving behaviour since the last recommendation was shown or will not improve the driving behaviour in future.

6.2 Detecting the driver reaction to a given recommendation

The lag of a certain recommendation, which is defined by the variable β^θ in equation 6.2, represents the waiting time between two recommendations of the same type, i.e. 20 seconds. The lag of a recommendation is initialised using the value of the waiting

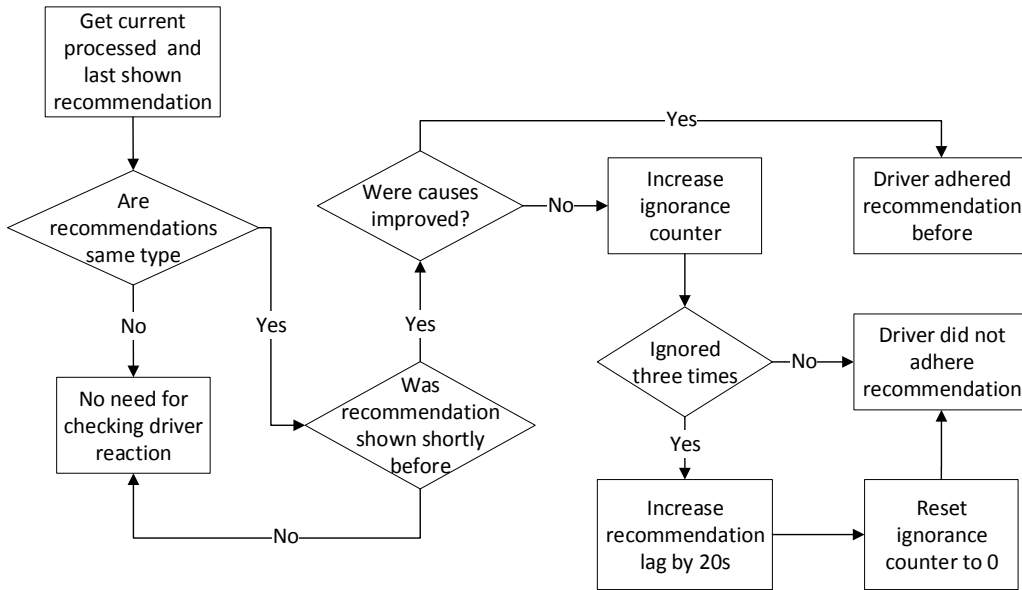

Figure 6.3: The process how the driver reaction to the previous shown recommendation is checked

time α and is altered by the recommendations inference engine module on the basis of the driver reaction to a given recommendation. The altered lag is stored along with the recommendation in the driver reaction to a given recommendation that is placed in the driving profile of the driver. Thus, every recommendation is adapted to the individual driving behaviour of the driver and to temporarily changes in the driving behaviour, caused for example when the driver is in hurry. This allows not to bother the driver with recommendations that are not interesting in the sense of the driver or in situations when the driver is not able to adhere the recommendations.

The detection of the driver reaction is done in the function $improved(u_{t-1}^\theta, u_t^\theta)$ in equation 6.2 on the basis of the previous shown and the current processed recommendation. Figure 6.3 shows the process how the driver reaction to the previous shown recommendation is checked. After receiving the current processed and the previous shown recommendation, the recommendations inference engine module checks if the previous shown and the current processed recommendation have the same recommendation type. If the recommendations are not of the same type, the detection of the driver reaction is cancelled, as the recommendations inference engine assumes that the previous shown recommendation was adhered.

6.2. DETECTING THE DRIVER REACTION TO A GIVEN RECOMMENDATION

In case of a same recommendation type, the last shown recommendation is checked if it was given shortly before. Thus, the last shown recommendation is validated if it is in the period of the minimum and maximum waiting. The period between the minimum and maximum waiting time is the time gap, in which a last shown recommendation is considered for the detection of the driver reaction. The minimum waiting time is set to 15 seconds after the last shown recommendation, which is the waiting time α in equation 6.2 and additionally 5 seconds that give the driver additionally time to change the driving behaviour regarding the last shown recommendation. In contrast, the maximum waiting time is set to 20 seconds after showing a recommendation, which is the double of the waiting time α . The minimum and maximum waiting time allows to give the driver enough time to show a reaction to the given recommendation while ignoring old recommendations that are not valid at the current driving situation. Thus, the detection of the driver reaction starts when the minimum waiting time is passed and ends when the maximum waiting time is reached. After the successful checking of the minimum and maximum waiting times, the parameters that caused the past and the current breaking of the driving rule or the deviation from the typical driving behaviour are gathered from the last and the current recommendation. The gathered parameters are compared to check if the driver has improved the driving behaviour after showing the last recommendation. When the driver has improved his driving behaviour, the driving system assumes that the driver adhered the recommendation before. If the driver did not adhere the recommendation the ignorance counter is increased. When the driver ignored a recommendation three times, the recommendation lag is increased by 20 seconds, which is the double of the waiting time α , and the ignorance counter is reset. In contrast, when the driver did not ignore a recommendation three times the ignorance counter is not increased and the recommendation lag is not increased. However, when driving system assumes that the driver did not improve the driving behaviour since the last shown recommendation, the driving system assumes that the driver ignored the shown recommendation.

The following example will illustrate the detection process of the driver reaction. For example, the driver has broken the driving rule "shift the gear" before with the parameters *engine speed* = 3000 and *gear* = 3 and, thus, the recommendation "Please shift to a higher the gear" was shown to the driver (remember, to break the driving rule "shift the gear", the current engine speed must be greater than 2500 and current gear must be less than the maximum gear, see Section 3.3 for a detailed

explanation). If the driving rule is still broken, the driver reaction is detected by getting the parameters *engine speed* and *gear* of the last shown recommendation, which are compared against the parameters *engine speed* = 2800 and *gear* = 4 that caused the current breaking of the driving rule "shift the gear". In this case the parameters changed in an positive way, as the engine speed decreased and the gear was shifted up by the driver. Thus, an improvement is detected, which means that the driver has adhered the recommendation. However, when the parameters did not improve as the parameters did not change or were getting worse, for example with the parameters *engine speed* = 3200 and *gear* = 3, it is assumed that the driver did not adhere the recommendations why the ignorance counter for the recommendation is increased. The driver is allowed to ignore a recommendation three times. On the third ignorance of the recommendation, the lag of the recommendation, β^θ in equation 6.2, is increased by 20 seconds, which is the double of the waiting time α . The increase of the lag β^θ allows to adapt the presentation of a recommendation to the individual driving behaviour of the driver and to the driver needs, as the driver may be in hurry and, thus, temporarily not interested to get a specific recommendation from the driving system, like the recommendation "slow down in order not to exceed the speed limit". After altering the lag of the repeatedly ignored recommendation, the ignorance counter of the recommendation is reset to the initial value of zero. Thus, the driver has again the opportunity to ignore the recommendation three times until the lag of the recommendation is increased again. The ignorance counter allows the driving system to consider driving situations in which the driver is not able to adhere the shown recommendation. Thus, instead of increasing the lag of the recommendation, the ignorance counter is increased to allow the driver the adherence of the recommendation after the driving situation that hindered the driver to adhere the recommendation.

6.3 Decision tree

To consider the conditions when a recommendation should be shown to the driver (see Section 6.1) and the conditions used to detect the driver reaction to already shown recommendations (see Section 6.2), a decision tree [100] is used in the recommendations inference engine module to decide whether to show a recommendation to the driver. The decision tree allows to do the decision whether to show a recommendation. Furthermore, it allows to combine the conditions of recommendation

decision and the detection of the driver reaction, while considering the order of the different conditions. However, the decision tree is not automatically generated using for example the C4.5 or the ID3 algorithms [100], as the conditions as well as their order are already defined and there is no training data available to train the decision tree. Instead, the conditions that define when a recommendations should be shown and the conditions of the driver reaction detection are used to create a static decision tree that decides whether a recommendation should be shown to the driver.

Figure 6.4 illustrates the created decision tree. The root and the leafs of the decision tree were arranged in the order that allows a short decision making process and avoids an unnecessary checking of the leafs. For example, it is not necessary to detect the driver reaction or to check the driver stress level when the waiting time α is not passed. The root of the decision tree is the condition "is enough time passed between the last shown and current recommendation", as the decision tree needs not to check any condition further when the waiting time α is not passed and, thus, the driver was not able to read and to show a reaction to the recommendation, why the current recommendation is suppressed by the recommendations inference engine module. On the other side, when the recommendation passed the waiting time α , the decision tree checks the driver reaction to the last shown recommendation next.

To check the driver reaction, the decision tree first validates if the current recommendation is from the same type as the last shown recommendation. The recommendations inference engine assumes that the driver adhered the previous shown recommendation when the last shown recommendation is not of the same type of the current processed recommendation. In this case the decision tree goes on to check if there is a predicted parameter for the recommendation available. However, if the last shown recommendation is of the same type as the current recommendation, it is checked if the driver had enough time to show a reaction to the last shown recommendation. Therefore, the time when the current recommendation was generated is compared with the time of the last shown recommendation. According to the detection process of the driver reaction in Section 6.2, it is validated that the recommendation is between the minimum and maximum waiting time that define the time slot when the recommendations inference engine detects a driver reaction. In case, the maximum time has been exceeded or the minimum waiting time is not reached by the current recommendation, the detection of the driver reaction will be skipped as the driving situation for which the last recommendation was shown is not valid for the current processed recommendation or the driver had not enough time to show a

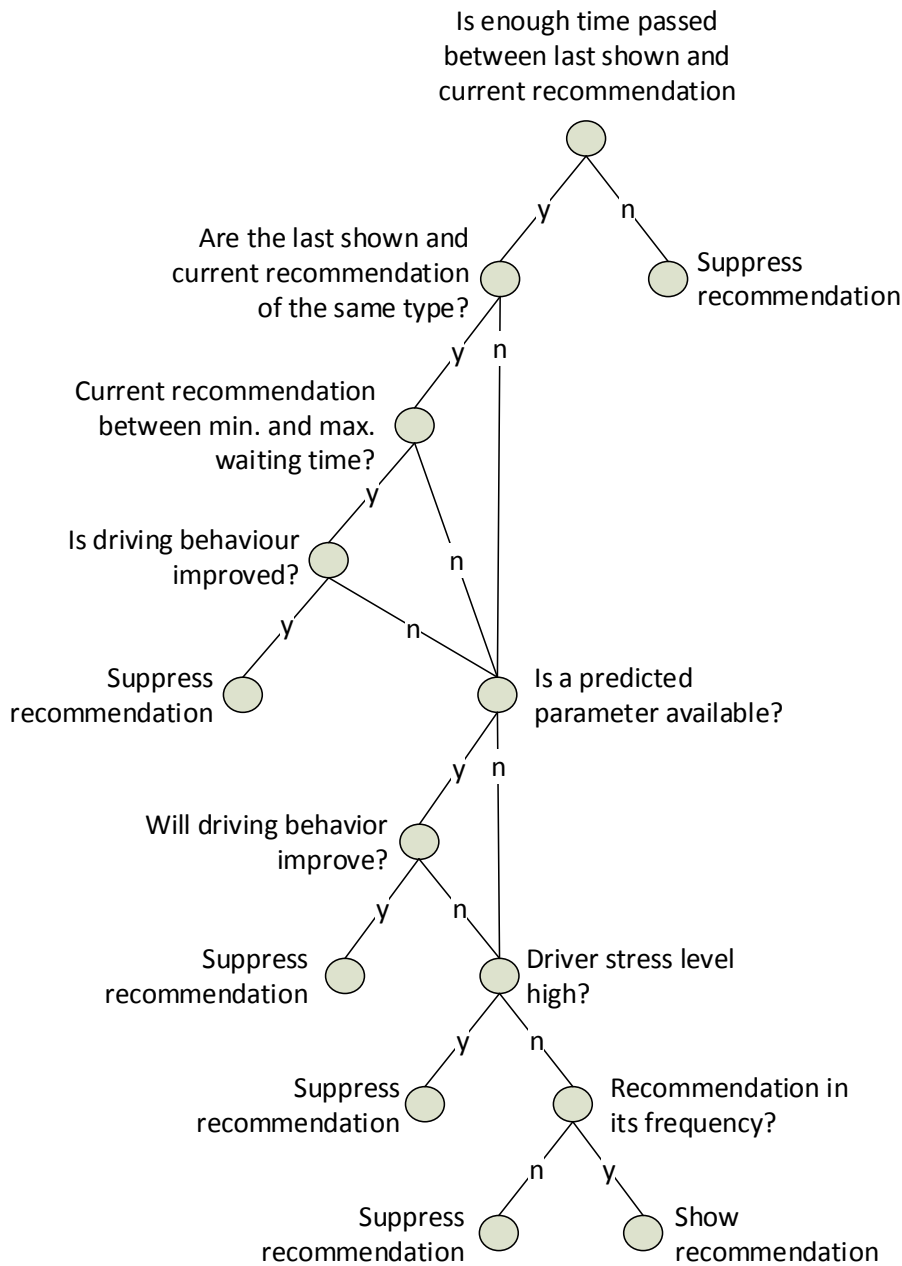

Figure 6.4: The decision tree that is used in the recommendations inference engine to check the adherence of the last shown recommendation and to decide whether to show a recommendation

reaction to the last shown recommendation. However, when the maximum time was not exceeded and the minimum time was reached, then the driving behaviour of the driver is inspected to find improvements since the last shown recommendation was given. Thereby, the parameter of the last shown recommendation, which caused the breaking of the driving rule or deviation from the typical driving behaviour, is checked for improvements. When an improvement is detected, the decision tree decides to sup-

press the current processed recommendation in order to check if the broken driving rule or deviation from the typical driving behaviour still exists in the next cycle of the driving system. Furthermore, this avoids bothering the driver with recommendations when the driving behaviour is already improving.

When no improvement is detected, the decision tree carries on to check if the driver will improve the driving behaviour in future. To be able to check the future improvement of the driving behaviour, the decision tree validates if a predicted parameter, like the predicted engine speed, is available for the recommendation. In case, a predicted parameter is available, it is compared against the parameter that caused the current processed recommendation. When a positive trend is detected, which means that the predicted value improves the driving behaviour regarding the cause of the current recommendation, the current recommendation is suppressed in order not to bother the driver by showing recommendations when the driver will improve the driving behaviour anyway. In contrast, if no predicted parameter is available or no improvement is detected for the future, the decision tree continues to check if the driver has an high stress level. When a high stress level is detected no recommendation is shown to the driver. This allows not to distract or to bother the driver by showing recommendation in stressful driving situations, as the driver should set his focus on driving and, thus, on solving the stressful driving situation. However, when the driver is not stressed the decision tree finally validates if the recommendation passed its lag. The lag of a recommendations defines when a recommendation of the same time should be shown again to the driver. To check whether the recommendation has passed its lag, the period since the current processed recommendation is calculated on the basis of the time when the recommendation was shown the last time and the time when the current recommendation was created. When the calculated period is greater than the lag of that recommendation type, the recommendation is shown to the driver. In contrast, the recommendation is suppressed when the lag is not reached from the current processed recommendation. This allows the adaptation of the driving system to the individual driving behaviour by adjusting lag of a recommendation based on the driver reaction to already given recommendations.

6.4 Evaluation and results

An evaluation of the decision tree was done in order to check if the decision tree is working according to the definition when a recommendation should be shown to the driver (see Section 6.1) and if the decision tree is able to recognise the driver reaction to already given recommendations (see Section 6.2). Therefore, the decision tree was implemented in the recommendations inference engine module of the driving system. To check if the decision tree is working according to the definitions in the sections 6.1 and 6.2, the following events were measured during the evaluation:

- Change of the recommendation lag
- Checking of the driver reaction
- Shown recommendation
- Suppressed recommendation due to high driver stress level
- Suppressed recommendation due to predicted improvement

The evaluation of the driving system was done using a driving simulator. The evaluation consisted of one journey of about 5 minutes on a rural road that had a speed limit of 50 km/h. During the journey, the events of the driving system were measured that allows to evaluate the decision tree. Furthermore, the driving rule "do not exceed the speed limit" with the condition $carspeed < speedlimit$ was used during the journey. The test driver that attended in the evaluation was briefed to exceed the speed limit significantly during the first half of the journey. This allowed to test the driver reaction detection and, thus, the variation of the recommendation lag as well as the suppressing of the recommendations due to a high driver stress level or a predicted improvement of the driving behaviour. In the second half of the journey, the driver was instructed to drive at the speed limit of about 50 km/h in order to test the reaction of the decision tree when the driver is driving at the speed limit and, thus, is not breaking the driving rule all the time.

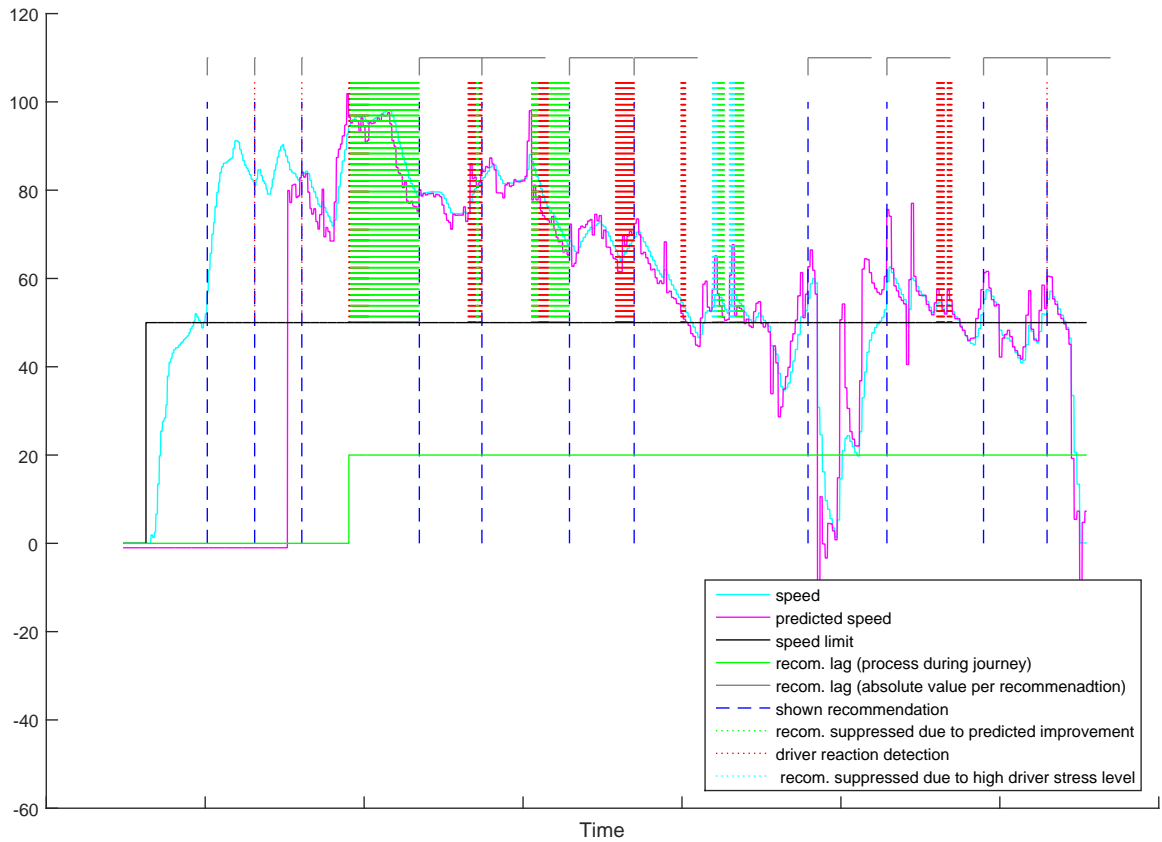

Figure 6.5: The result of the evaluation of the decision tree

Figure 6.5 shows the result of the journey, in which the detected events of the driving system as well as the driving speed and the predicted driving speed are shown. In the first part of the journey, in which the driver was instructed to drive significantly faster than the speed limit, the lag of the recommendation was at its initial value. The green line in Figure 6.5 shows the progress of the lag, whereas the grey line on the top shows the local lag for each recommendation. Figure 6.5 shows only the increased value of a lag, why the initial value of the lag is at zero. When the driving speed (cyan line) exceeded the speed limit (black line), the driving system showed a recommendation (blue dashed line) for the first time. As the speed limit was still exceeded, the second recommendation was shown after the waiting time α . Furthermore, the driver reaction to the already shown recommendation was measured (red dotted line) and the ignorance counter was increased the first time, as there was no improvement of the driving behaviour detected. After the third recommendation was shown, the lag of the recommendation was increased by 20 seconds, as the driver did not adhere the recommendation a third time. However, no recommendation was shown when the lag was increased, as the driving system predicted an improvement of

the driving behaviour (green dotted line). At the moment, when the no improvement was predicted, the driving system showed again a recommendation to the driver. After the increase of the lag, the driving system waited to show a recommendation until the lag of the recommendation was past since the last shown recommendation, see grey line at the top of a recommendation. After showing the fourth recommendation, the driver reaction detection increased the ignorance counter as the driver did not adhere the recommendation.

During the second part of the journey, in which the driver was briefed to drive at the speed limit of 50 km/h, the ignorance counter was not increased during the detections of the driver reaction, as the driver reduced the driving speed since the time when the driving rule was broken. Thus, the driving system assumed that the driver adhered the recommendation, why the lag was not increased for the rest of the journey. After the seventh shown recommendation, the stress level of the driver increased to a high stress level, why the driving system did not show a recommendation to the driver during this phase. Furthermore, the driving system predicted an improvement of the driving behaviour that leded also to a suppressing of the recommendation. After showing the eight recommendation, the driver reaction was not detected, as the driver did not exceed the speed limit. Thus, the driving system assumed that the driver adhered the shown recommendation, as the driving rule was not broken by the driver.

6.5 Discussion

A definition when a recommendation should be shown to the driver was created. Furthermore, it was defined how the detection of the driver reaction to a already shown recommendation should be done. On the basis of the definitions a decision tree was developed that decides whether to show a recommendation to the driver and detects the driver reaction to an already shown recommendation. The decision tree shows a recommendation to the driver when the driver is not in stress, enough time is passed between two recommendations as well as enough time is passed between two recommendations of the same type and when no improvement of the driving behaviour is detected or predicted.

The aim of the decision tree evaluation was to check if the developed decision tree shows or suppresses recommendations and if the recommendation lag is altered according to the definition when a recommendation should be shown and the definition of the driver reaction detection to an already shown recommendation. Therefore, the events of the driving system like recommendation shown or suppressed and the alteration of the recommendation lag are captured. The results of the evaluation showed that the decision tree showed and suppressed recommendations as well as altered the recommendation lag according to the created definitions.

According to the captured events, the driving system showed three recommendations at the beginning of the journey without suppressing a recommendation. As the driver exceeded the speed limit in the whole first part of the journey, each recommendation was shown after the initial waiting time, as the lag of the recommendation was at its initial state. When the driver ignored the recommendation the third time, the decision tree increased the lag of the recommendation. Thus, the recommendations were shown less frequently to the driver. Furthermore, the decision tree suppressed recommendations when an improvement of the driving behaviour was predicted and when the driver stress level was high.

However, besides a decision tree a state machine [105] can also be used to do the decision whether to show a recommendation and the alteration of the recommendation lag on the basis of the driver reaction to already shown recommendations. For example, when using state machines, every recommendation represents a state. The lag of a recommendation can be altered by using the transition between the recommendations. When a recommendation is ignored by the driver and, thus, the state is transited to itself, the lag of that recommendation is decreased. When transiting to another state, the lag of a recommendation stays the same. Furthermore, the driver stress level can also be considered for example by checking the stress level of the driver within the recommendation state or by using another state machine, in which every state represents different stress levels. The transition between the states of the stress level can be used to alter the lag of the recommendation on the basis of the stress level. Thus, a recommendation can be suppressed by a state machine on the basis of the stress level, when the state machine of the stress level is used in combination with the recommendation state machine.

However, as the driving system is functional, a state machine does not fit in the process of the driving system, why a decision tree was chosen to do the decision whether to show a recommendation to the driver. Furthermore, the state machine requires to define a state for every recommendation used in the driving system. Moreover, when adding a new parameter, for example the distraction level of the driver, to the decision process whether to show a recommendation, a new state machine has to be created and considered. Thus, the costs of adding new parameters are high when using a state machine. In contrast, when using a decision tree a new parameter is put to the decision process by adding another leaf to the tree.

Chapter 7

Prototype

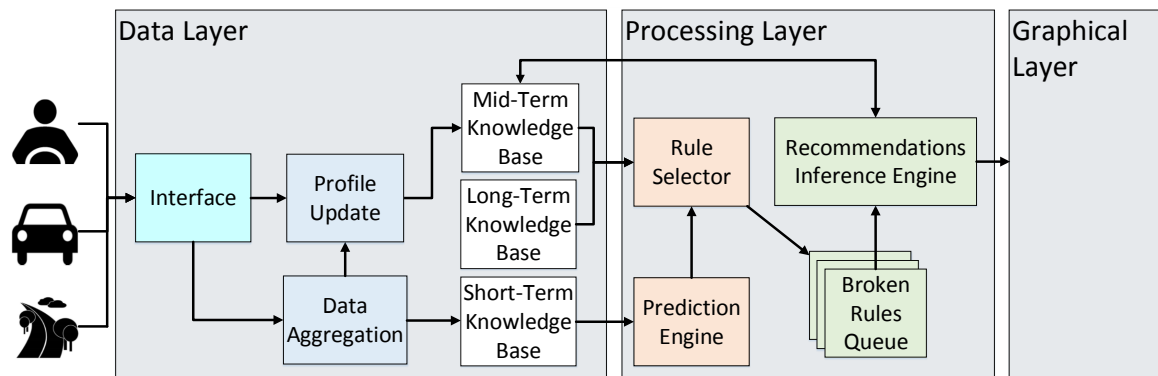

Figure 7.1: The architecture of the driving system that is used as the basis for the prototype

On the basis of the findings in the previous chapters, a prototype of the adaptive and rule based driving system was implemented. The developed prototype was the basis for the evaluation of the driving system, explained in Chapter 8. The architecture of the prototype is based on the general architecture of the driving system that is shown in Figure 7.1. The architecture of the developed prototype is briefly explained in the following section, as the general architecture was already described in Section 3.5. In Section 7.2, the implementation of the modules and the process of the data layer are described. Furthermore, the processing layer as well as the implementation of its modules in the prototype are explained in Section 7.3. Finally, the implementation of the graphical layer that represents the interface to the driver is shown in Section 7.4. Additionally, the representation of the recommendations to the driver is explained, as the output of the recommendations is also done in the graphical layer.

7.1 Architecture

For the development of the driving system prototype, the general architecture of the driving system, shown in Figure 7.1, was used. Thus, the prototype consists of the data, processing and the graphical layer, which are used in the general driving system architecture to gather and to prepare the data, to decide whether to show a recommendation and to interact with the driver. Figure 7.2 shows the implementation of the architecture and its modules in detail.

The data layer, whose implementation details are described in the following section, consists of the modules interface, profile update, data aggregation and the information module that consists of the short, mid- and long-term knowledge base. The interface module of the data layer gathers needed information from the car, the environment and the driver and provides that information to the data aggregation and profile update module. The data aggregation module aggregates the incoming data and stores the aggregated data in the working memory that is placed in the short-term knowledge base. The working memory stores also information that is gathered from the interface module. The profile update module updates the driver profile, which is placed in the mid-term knowledge base, on the basis of the information provided by the interface and the data aggregation module.

The processing layer consists of the prediction engine, rule selector and the recommendations inference engine module. Furthermore, the logic behind the graphical user interface is also placed in the processing layer. The GUI logic module allows the interaction between the driving system and the driver by allowing to choose the driving profile and the area of improvement, for example safety, energy-efficiency or both. The processing layer starts to predict the car state in the prediction engine module on the basis of the information stored in the working memory that is placed in the short-term knowledge base of the data layer. The predicted information is passed along with the information stored in the working memory to the rule selector module. On the basis of the information provided by the prediction engine module and the driving profile of the driver, the driving behaviour is checked to find broken driving rules or deviations from the typical driving behaviour. On detection of broken driving rules or deviations, the recommendations inference engine decides whether to show a recommendation. Therefore, it considers the individual driving behaviour of

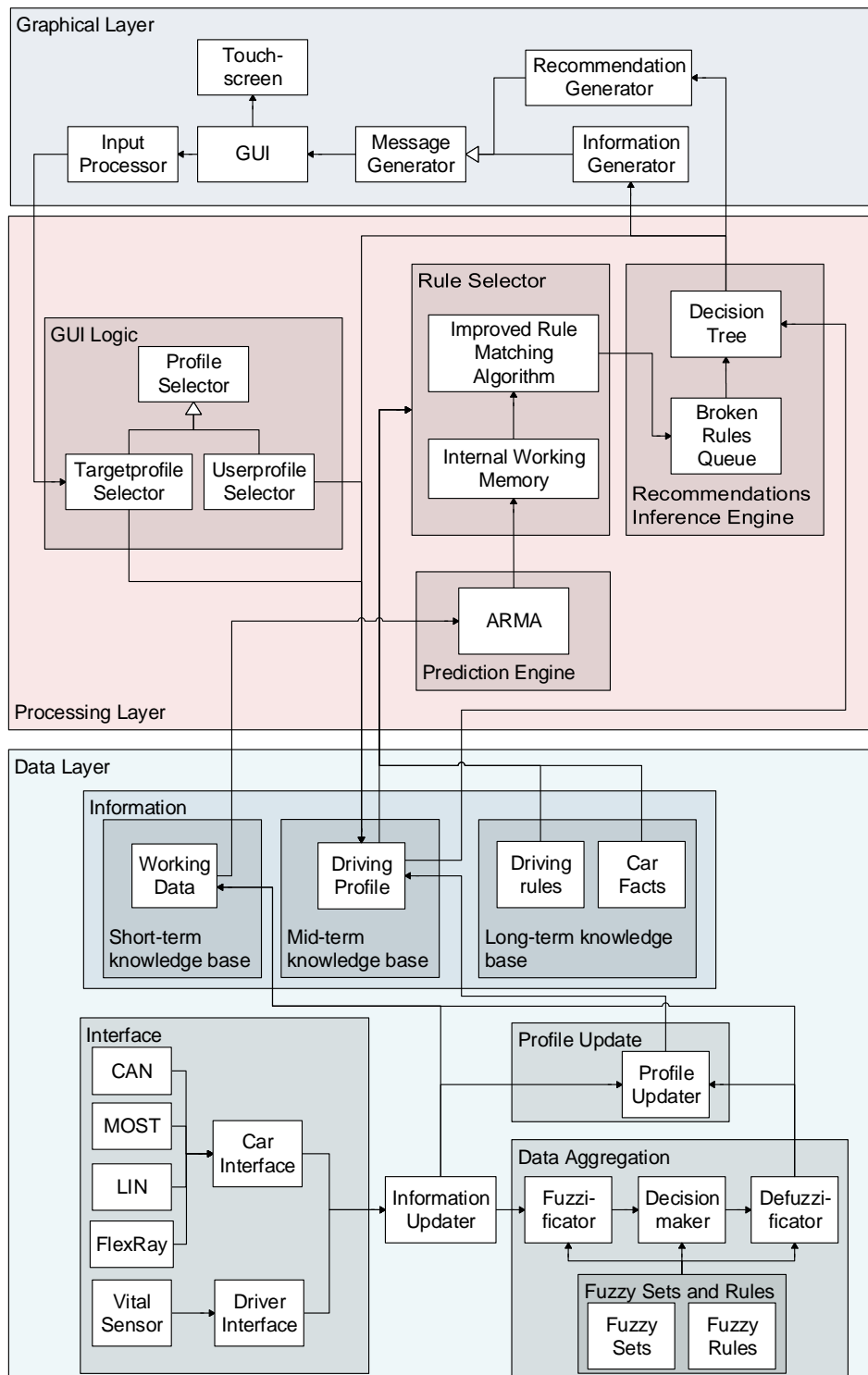

Figure 7.2: The architecture of the prototype driving system

the driver as well as the driver stress level. When a recommendation should be shown to the driver, it is passed to the graphical layer. Section 7.2 explains realisation of the processing layer in the prototype of the driving system.

The graphical layer is responsible for the interaction between the driving system and the driver. Therefore, it shows a graphical user interface to the driver that provides the opportunity to choose the driving profile or the area of improvement, such as safety, energy-efficiency or both. Furthermore, the graphical layer shows recommendations to the driver when the processing layer decides that a recommendation should be given to the driver. The graphical layer renders the recommendations for example on the graphical user interface using text or by using an audio voice. The development of the graphical layer within the prototype of the driving system is described in Section 7.4 in detail.

7.2 Data layer

The data layer is responsible for gathering and preparing the information from the car, the driver and the environment. Furthermore, the gathered and prepared information are provided to the processing layer that analyses the driving behaviour and decides whether to show a recommendation. In the first step, the data layer gathers information from the car, the driver and the environment using the interface module. It implements interfaces to the car and the environment as well as to the driver. The interface module supports the well-established serial-bus systems in the automotive area to obtain information about the car, i.e. speed or distance to the car in front, and the environment. The environmental sensors, like the rain or weather sensor, are also attached to the in-vehicle serial-bus systems [57]. The support of the well-established serial-bus systems CAN, LIN, MOST or FlexRay allows the driving system to be used in different cars. A detailed description of the serial-bus systems and available environmental sensors can be found in Section 3.6.1 and 3.6.2. If additional car interfaces are needed in the driving system, the interface module provides a car interface class that can be extended by the needed car interface. Furthermore, as the driving system needs information about the driver stress level, the interface module provides an interface to a vital sensor that allows to measure the driver stress level on the basis of the heart rate variability. Section 3.6.3 explains the stress level detection on the basis of the heart rate variability. If more sensors are needed to

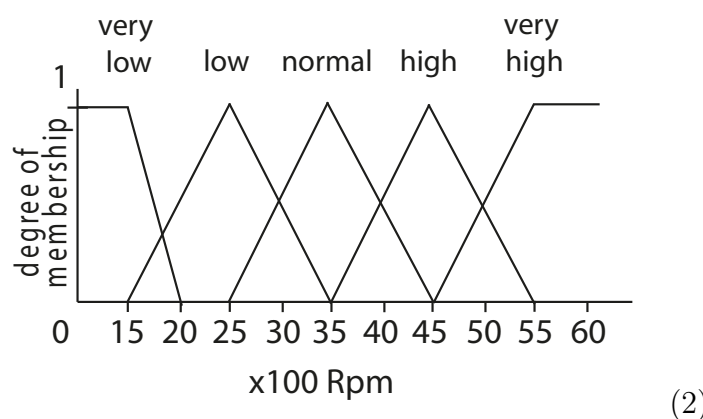
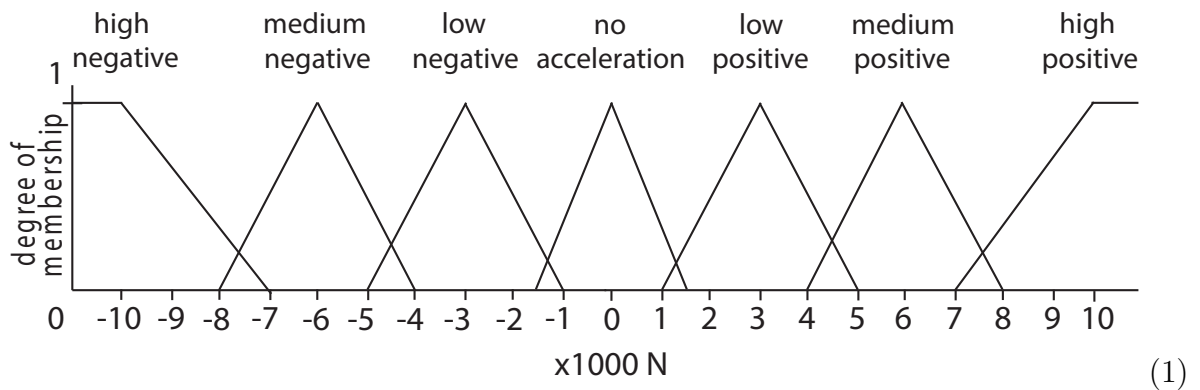

Figure 7.3: The fuzzy sets of the acceleration (1) and the manner of driving (2) used in the prototype for fuzzification

obtain additional vital information from the driver, the interface module provides a driver interface class that allows to attach more sensors to the driving system. The implemented interfaces gather new information from the in-vehicle serial-bus systems and from the vital sensor, which is connected to the driver, and passes the obtained information to the information updater class.

The information updater is responsible for collecting the information provided by the interface module and distributing the obtained information simultaneously to the data aggregation and profile update module. Additionally, it stores the incoming information from the interface module within the working memory, that is placed in the short-term knowledge base. This allows to synchronise the information that is received from the interface module, as the interface module receives information from the car and driver interface asynchronously.

The data aggregation module of the data layer aggregates the information that is passed by the information updater. For the aggregation of the information the data aggregation module uses fuzzy logic, that is described in Section 3.7 in detail. In the prototype of the driving system the manner of driving as well as the acceleration force information are aggregated. Thus, fuzzy sets and fuzzy rules were created that allows the aggregation of these information. Figure 7.3 shows the fuzzy set of the acceleration (1) and the manner of driving (2). On the basis of the defined fuzzy sets, the fuzzificator fuzzifies the information of the engine speed and the acceleration force that is gathered from the in-vehicle serial-bus system.

Accelerationforce (1)

```
RULE 0: IF accelerationForce IS highPositive THEN
        acceleration IS highPositive;
RULE 1: IF accelerationForce IS mediumPositive THEN
        acceleration IS mediumPositive;
RULE 2: IF accelerationForce IS lowPositive THEN
        acceleration IS lowPositive;
RULE 3: IF accelerationForce IS noAcceleration THEN
        acceleration IS noAcceleration;
RULE 4: IF accelerationForce IS lowNegative THEN
        acceleration IS lowNegative;
RULE 5: IF accelerationForce IS mediumNegative THEN
        acceleration IS mediumNegative;
RULE 6: IF accelerationForce IS highNegative THEN
        acceleration IS highNegative;
```

Manner of driving (2)

```
RULE 0: IF rpm IS veryHigh THEN mannerOfDriving IS veryHigh;
RULE 1: IF rpm IS high THEN mannerOfDriving IS high;
RULE 2: IF rpm IS normal THEN mannerOfDriving IS normal;
RULE 3: IF rpm IS low THEN mannerOfDriving IS low;
RULE 4: IF rpm IS veryLow THEN mannerOfDriving IS veryLow;
```

Listing 7.1: Fuzzy rules that are applied on the fuzzified acceleration force (1) and engine speed (2)

Listing 7.1 shows the fuzzy rules that are applied in the decision maker on the fuzzified information from the engine speed and the acceleration force. Using the fuzzy rules and the fuzzified information, the decision maker determines the grade of membership of the rule consequences. To be able to use the fuzzified information for further processing, the defuzzificator defuzzifies the grade of membership of the consequence into a crisp value. The result of the defuzzification is the crisp value

that represents the manner of driving and the acceleration force that was calculated on the basis of the fuzzified information. After the defuzzification, the crisp values are stored in the working memory and are passed to the profile update module for further processing.

The profile update module is responsible for updating the driving profile that represents the typical driving behaviour of the driver. Therefore, the profile update module gets information about the current driving behaviour of the driver from the information updater class and the data aggregation module. The current driving behaviour of the driver is used to update the typical driving behaviour, as the typical driving behaviour of the driver is varying for example due to improvements of the driving behaviour. The update of the driving profile is done by processing the gathered information with the simple exponential smoothing technique, explained in Section 3.8. The simple exponential smoothing technique is applied to each information stored in the driving profile, like the manner of driving or the driving speed. After updating the driving profile with the collected and aggregated information, the driving behaviour stored in the driving profile is able to represent the typical driving behaviour of the driver until the current measurement.

The short-term knowledge base of the data layer contains, after the collection and aggregation of the information, the data that is able to represent the current driving situation. Furthermore, the mid-term knowledge base is able to represent the typical driving behaviour of the driver that considers the changes of the typical driving behaviour until the current measurement. The car facts and the driving rules are stored in the long-term knowledge base. However, the long-term knowledge base is not updated during the journey. Instead, the car facts and the driving rules are loaded into the long-term knowledge base at the start of the driving system using the in-vehicle serial-bus systems and the DRR files. Finally, when the knowledge bases of the data layer were updated with the current information, which represent the current driving situation, they can be used by the processing layer to start the decision process of whether to show a recommendation to the driver.

However, to make the information in the mid- and long-term knowledge base available for the next journeys, a database is used to store the collected information. At the beginning of a journey the information that is stored in the database is loaded into the mid- and long-term knowledge base, whereas the driving profile is loaded into the mid-term knowledge base when the database contains a driving profile of the

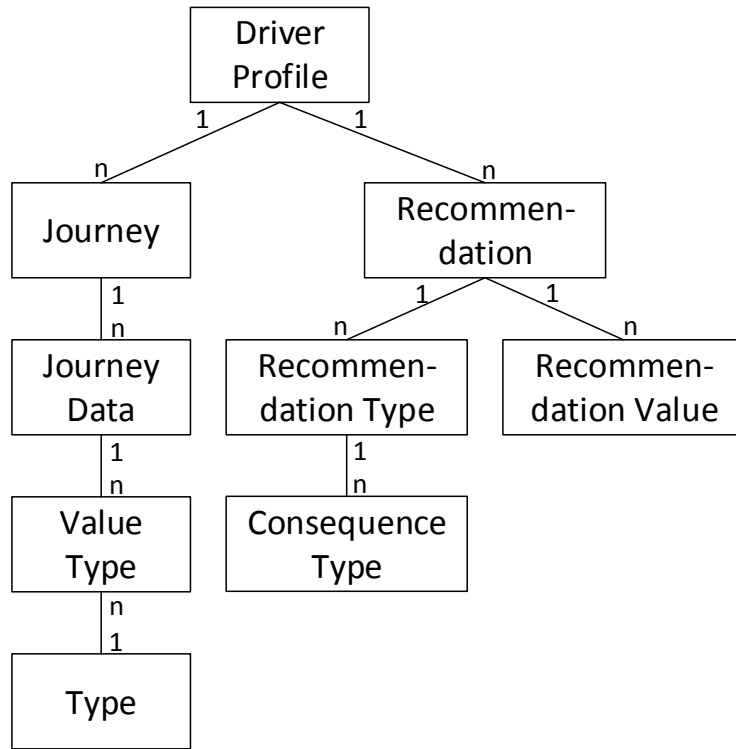

Figure 7.4: The structure of the database that is used to store the driving profile and the consequences of the driving rules

driver. In contrast, when there is no driving profile the data layer generates a new driving profile for the driver. The driving profile that is altered during the journey is stored in the database at the end of every journey in order to reuse the altered driving profile in the next journey. The long-term knowledge base loads the information about the driving rule consequences from the database at the beginning of every journey. The driving rule consequences stored in the database contain information about the recommendation text that should be shown and the audio file that contains the recommendation.

A SQLite database¹ is used in the driving system to store the information of the driving profile and the driving rules, as it is an serverless, local and transactional database engine. Thus, the SQLite database does not need additional resources or need to be maintained. Figure 7.4 shows the database structure that is used to store the driving profile and the driving rules. The basis of the database structure is the table driver profile that is created for every driver and contains the name of the

¹More information about the SQLite database can be found on <http://www.sqlite.org>

driver as well as the area of improvement. Each driver profile is associated with one or more journeys and recommendations. The table journey stores information about the time when the journey was started. During the journey one or more information can be stored in the table journey data that represents the typical driving behaviour of the driver. The table journey data contains information about the typical driving behaviour during every journey of a driver. The stored information has different categories that are defined in the table value type, such as the average speed during the speed limit of 70 km/h. This allows capturing the typical driving behaviour in different driving situations and, thus, to represent the typical driving behaviour in the driving system more accurate. The different value types are again categorised in the table type using a generic term. For example, the average speed during the speed limit of 70 km/h and 100 km/h are categorised with the type average speed, as they are describing the typical driving speed of the driver.

The table recommendation represents the driver reaction to a shown recommendation. It stores the recommendation lag as well as the ignorance counter and the time when a recommendation was shown the last time. For each recommendation stored in the recommendation table, the information that caused the showing of the recommendation is stored in the table recommendation value. The type of the recommendation that is stored in the recommendation table is defined in the table recommendation type. It contains the different types of the recommendations, such as do not exceed the speed limit. Furthermore, the information about the consequences of the recommendations are stored in the consequence type table, such as playing an audio file or showing a text. This allows to define different ways of transporting the recommendations to the driver, i.e. using text and an audio file.

7.3 Processing layer

The processing layer consists of the prediction engine, rule selector, recommendations inference engine and the GUI logic module. On the basis of the modules, the processing layer decides whether to show a recommendation to the driver and allows the driver to create a new and modify an existing driving profile. The modification of the driving profile is located within the GUI logic module that consists of the logic behind the graphical user interface. It allows the driver to create and to choose a driving profile by using the userprofile selector. Furthermore, the targetprofile selector allows

the driver to choose the area of improvement, like the area of safety, energy-efficiency or both areas. According to the selection of the driver, the driving system will show only recommendations that are related to the chosen area of improvement.

In the first step of the processing layer, the prediction engine module gathers the information from the current driving situation that is stored in the working data of the short-term knowledge base. On the basis of the gathered information the prediction engine module predicts the car state that is described by the engine speed, car speed and the distance to the car in front. As explained in Chapter 4, the autoregressive moving-average algorithm is used to predict the car state. The prediction engine module passes the predicted car state with the gathered information from the working memory to the rule selector module for checking if the driver has broken a driving rule or if there is a deviation of the current driving behaviour from the typical driving behaviour. For detecting a broken rule or a deviation from the typical driving behaviour, the rule selector module consists of an internal working memory and the improved rule matching algorithm, explained in Section 5.4. During the initialisation phase of the driving system, the internal working memory gathers the typical driving behaviour of the driver from the driving profile. Furthermore, the improved rule matching algorithm is initialised. In case no driving profile is available in the mid-term knowledge base of the data layer, as it may be the first usage of the driving system, the deviation from the typical driving behaviour is not detected by the rule selector module. The internal working memory stores the information of the current driving situation as well as the predicted car state and the state of the typical driving behaviour. Furthermore, it is the basis for the detection of a broken driving rule or deviation from the typical driving behaviour. When the internal working memory was updated, the improved rule matching algorithm checks the current driving situation against the driving rules and car facts of the long-term knowledge base to find broken driving rules. Furthermore, the improved rule matching algorithm compares the typical driving behaviour that is stored in the internal working memory against the current driving behaviour in order to find a deviation from the typical driving behaviour. The process of the improved rule matching algorithm is described in Section 5.4 in detail. When a broken driving rule or a deviation from the typical driving behaviour is detected, the broken driving rule or the deviation is put into the broken rules queue of the recommendations inference engine. Besides the broken rule or deviation, the information that caused the breaking or deviation as well as the driver stress level are also passed to the broken rules queue.

```
1 #rule
2 "ecoRPM"
3 #when
4 Rpm > 2500 & Gear < 6 & acceleratorPressed = 1
5 #then
6 ShiftGear
7 #end
8
9 #rule
10 "typicalDrivingManner"
11 #when
12 AverageMannerOfDriving > TypicalAverageMannerOfDriving
13 #then
14 BadAverageMannerOfDriving
15 #end
16
17 #rule
18 "speedLimit"
19 #when
20 Carspeed > Speedlimit & Speedlimit > 0
21 #then
22 SpeedlimitExceeded
23 #end
```

Listing 7.2: An excerpt of the driving rules that are defined in the DRR files for the usage in the driving system

In the prototype of the driving system rules were defined to check the typical driving behaviour of the driver as well as the driving rules for energy-efficiency and safety. Listing 7.2 shows an excerpt of the energy-efficiency and safety relevant driving rules that are described in the DRR files. The first rule *ecoRPM* is an energy-efficiency relevant driving rule. The consequence of the rule is to show the recommendation to shift the gear when the driver is accelerating, the engine speed is above 2500 revolutions per minute and the driver did not reach the maximum gear. Further energy-efficiency relevant rules, which are part of the energy-efficiency driving rules described in Section 3.3, are defined in the DRR file. The second rule *typicalMannerOfDriving* is related to the deviation of the current driving behaviour from the typical driving behaviour. A deviation from the typical manner of driving is recognised when the current manner of driving is getting worse. Thus, the driving system will show a recommendation that tells the driver to decrease the engine speed while driving. Besides this rule, further rules to detect a deviation from the typical driving behaviour are also defined in the DRR file. The last recommendation *speedLimit* has the conse-

quence that recommends the driver to slow down as the driver exceeded the speed limit. However, if there is no speed limit, like on German highways, the consequence of the driving rule should not be fired. Besides this safety relevant rule, further rules are defined in the DRR file that cover the different aspects of the safety relevant driving rules described in Section 3.3.

The recommendations inference engine consists of the broken rules queue and the decision tree that is explained in Section 6.3. The broken rules queue contains the broken rules and deviations that were detected by the rule selector modules. The decision tree process the broken rules or deviations stored in the broken rules queue according to the first in, first out principle. For each broken rule or deviation from the typical driving behaviour a recommendation is created. On the basis of the driver stress level gathered from the broken rules queue and the driver reaction to already shown recommendations, which is stored in the driver profile, the decision tree decides whether to show or to suppress the created recommendation. The decision is done according to the definition when a recommendation should be shown, see Section 6.1. Furthermore, the decision tree detects the driver reaction to the last shown recommendation and modifies the lag of the recommendation according to the results of the driver reaction detection. The modified recommendation lag is stored in the driver profile. When the decision tree decides to show a recommendation, it is passed to the graphical layer with the purpose to show the recommendation to the driver. Additionally, the time when the recommendation is shown is stored in the driver profile.

7.4 Graphical layer

The graphical layer is responsible for the presentation of the recommendations and other messages to the driver. Therefore, it provides an information and a recommendation generator. The information generator is used to show messages to the driver that are not recommendations, like the current fuel usage or information about the current speed limit. In contrast, the recommendation generator is used to present recommendations to the driver. It allows the rendering of the recommendation on the graphical user interface (GUI) and the presentation of the recommendation using an audio voice. This allows to present the driver the recommendations without distracting the driver during the journey. When an additional message type is needed,

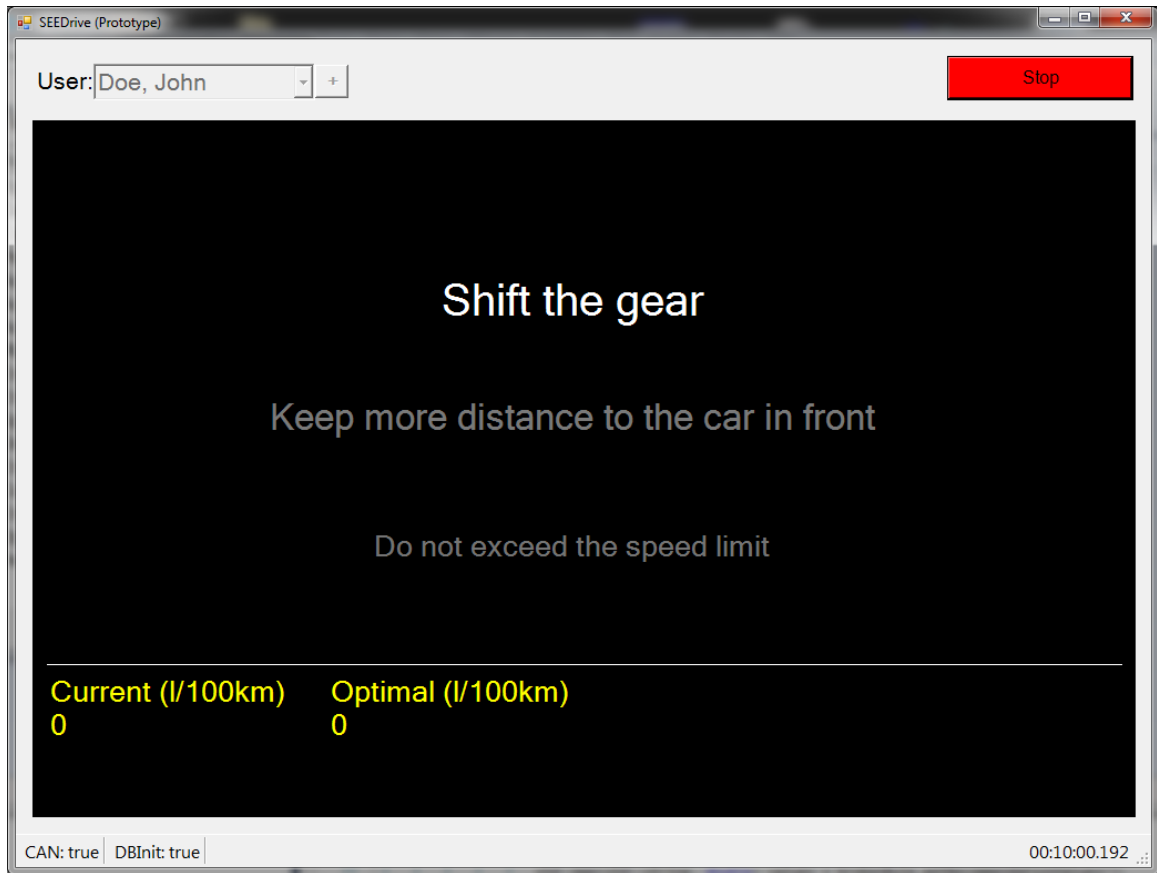

Figure 7.5: The graphical user interface of the prototype

the message generator can be used as a basis for a new type of a message generator that is able to display the needed message type on the GUI. The graphical user interface allows the interaction of the driver with the driving system using a touch screen. The interaction of the driver with the graphical user interface is processed by the input processor that is connected to the GUI logic module of the processing layer.

Figure 7.5 shows the graphical user interface of the driving system. The driver has the opportunity to choose and to create a new driving profile on the top left of the graphical user interface. During the creation of the driving profile, the driver has the opportunity to choose the area of improvement, such as safety, energy-efficiency or both. After creating a driving profile the driving system can be started to monitor the driving behaviour using the start/stop button on the top right. When the driving system is stopped, the button is coloured green, whereas the button colour turns to red when the driving system is running. However, the driving system can only be started by the driver when there is a connection to the in-vehicle serial-bus system and

when the database of the driving system is initialised. The status of the connection to the in-car serial-bus system and the initialisation status of the database is indicated on the left side of the status bar that is placed at the bottom of the graphical user interface. On the right side of the status bar is the usage time of the driving system. The main area, in which the recommendations and information of the driving system are shown, has a black background colour. On the upper part of the black area are the recommendations that are shown to the driver. The recommendations are shown to the driver in three stages. The current recommendation is shown on the top with a large and white font. Besides the textual rendering of the current recommendation, the recommendations are presented to the driver also by using an audio voice. This allows presenting the recommendations without distracting the driver by forcing the driver to read the recommendation from the graphical user interface. Furthermore, the presentation of the recommendation using an audio voice allows the driver to avoid the missing of a recommendation. After five seconds, the recommendation is passed to the second stage that is placed in the middle. The second stage shows the past recommendation with a medium sized and grey font. Finally, the recommendation of the second stage is transferred to the third stage that shows the recommendation that was important ten seconds ago. Beneath the area, in which the recommendations are shown, is the current and optimal fuel usage shown to the driver. The current fuel usage shows how much fuel is burnt per 100 km by the car with the current driving behaviour of the driver. The optimal fuel usage per 100 km is also shown to the driver in order to set incentives to the driver to adhere the recommendations shown by the driving system.

Chapter 8

Evaluation

The goal of the evaluation was the examination of the research questions, which were defined in Section 1.2. For the evaluation, the created prototype of the adaptive and rule-based driving system and a driving simulator, which is explained in Section 8.1, was used. In order to get the needed information from the car, the driver and the environment, the prototype was connected to the driving simulator and adapted to the interfaces and the sensor information provided by the driving simulator. The connection of the prototype is described in Section 8.1. The hypotheses that were used in the evaluation are explained in Section 8.2. Furthermore, in this section, the experimental set-up, which was used to evaluate the defined hypotheses, is also explained. Finally, the evaluation plans for testing the hypotheses are described in detail in Section 8.2.1 and 8.2.2

8.1 Driving simulator

The driving simulator, shown in Figure 8.1, is used to evaluate the driving system. It consists of three displays that are placed in front of a driving seat for visualising the environment. Furthermore, to allow the most possible immersion, five speakers surround the driving seat that allow to simulate the environment of the driver using audio. The driver has the opportunity to control the virtual car using a steering wheel and a gear knob as well as the accelerator, the brake and the clutch pedal. Furthermore, the heartbeat and the brain activity of the driver can be monitored using an ear sensor and a electroencephalogram (EEG). The dashboard is placed behind the steering wheel and provides information about the driving speed, fuel level



Figure 8.1: The driving simulator that is used in the evaluation

and the engine speed to the driver. A touchscreen on the right side of the steering wheel represents the centre console of the car, in which for example the interaction of the driver with a driving system can be realised. During the evaluation, the prototype of the driving system will run on the touchscreen and, thus, the recommendations of the driving system will be presented to the driver using the touchscreen.

Besides the in- and output interfaces to the driver, the driving simulator consists of three computers: that are responsible for the simulation of the car and the environment, the collection of the vehicle and driver data and the presentation of the developed applications to the driver on the touchscreen. Figure 8.2 shows the components of the driving simulator and the communication structure between the computers and their tasks within the driving simulator. The input devices of the car, like the steering wheel, the pedals and the gear knob as well as the output devices, like the three screens and the five speakers, are connected to the simulation computer. The simulation computer runs the driving simulation software OpenDS¹ that gets the driving instructions of the driver and starts to calculate the car physics and to visualise the car and the environment on the basis of the gathered instructions. The visualisation of the car and the environment is done using the connected displays and

¹OpenDS is an open source driving simulation originally developed by the German Research Center for Artificial Intelligence (DFKI GmbH). More information about OpenDS can be found on www.opends.de

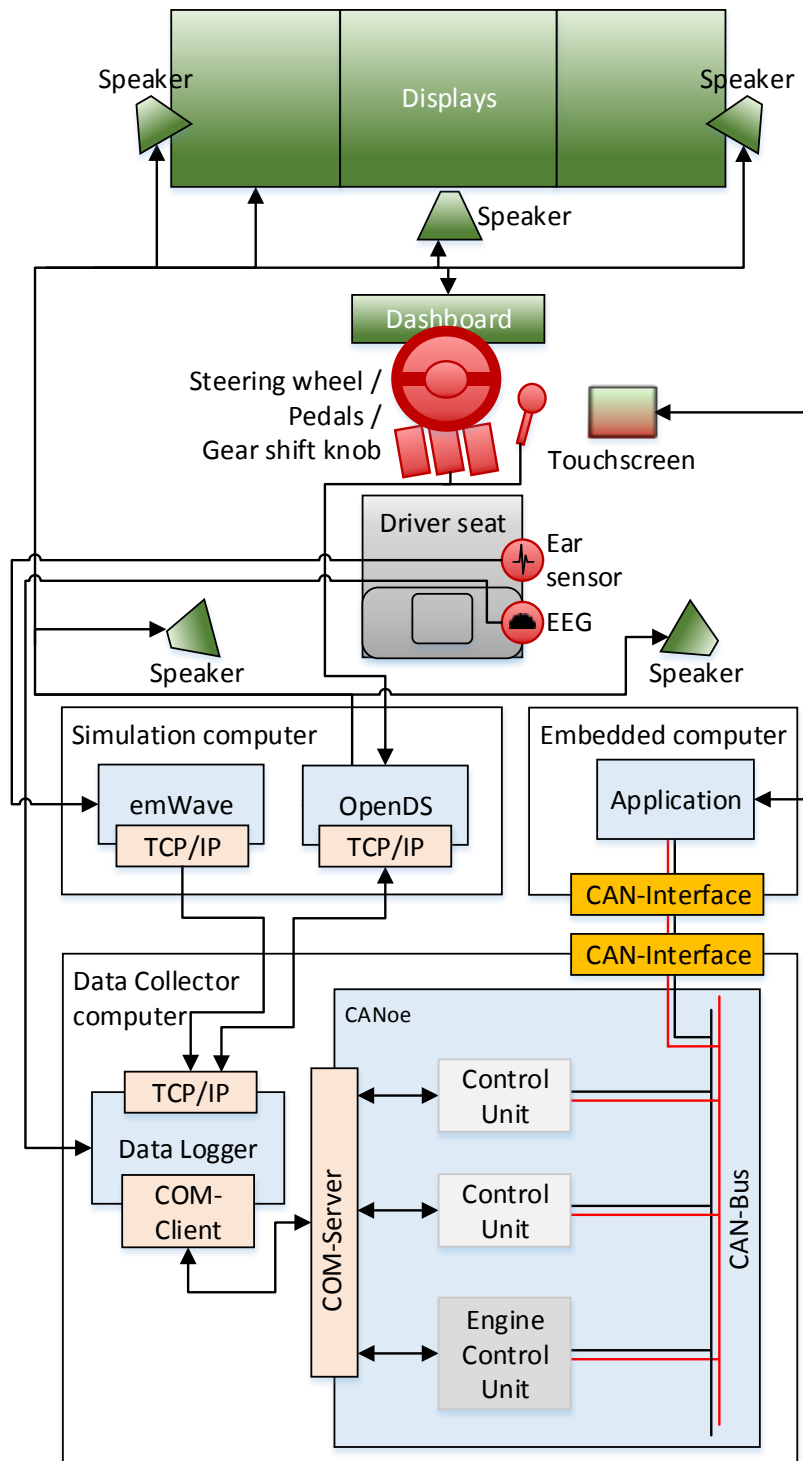

Figure 8.2: The architecture of the driving simulator, in which the red colour indicates the input devices and the green colour the output devices

speakers. During the calculation of the car physics, the simulation computer updates also the information presented on the dashboard and sends the updated information to the data collector computer using a tcp/ip connection between the computers. Additionally, the driving simulation allows the steering of the virtual car using the information received from the tcp/ip connection. The ear sensor that monitors the heartbeat of the driver is connected to the emWave² software in the simulation computer. The software receives the heartbeat information of the driver and calculates the heart rate variability. On the basis of the heart rate variability, the software classifies the stress level of the driver in low, medium and high stress.

The data collector computer contains a simulation of the remaining bus and a data logger application that receives the information provided by the applications OpenDS and emWave and the EEG sensor. Besides the receiving of the information, the data logger application allows also to send information from the simulation of the remaining bus to the simulation computer, for example to steer the vehicle. The main task of the data logger is to collect and to log the data from the connected applications and sensors. The data logger additionally passes the collected information to the simulation of the remaining bus. The communication between the data logger and the remaining bus simulation is done using the Component Object Model (COM) interface. Therefore, the data logger provides a COM-client that connects to the COM-server of the remaining bus simulation that allows the COM-client to put or to get information from the control units of the remaining bus simulation. The software CANoe³ is used to simulate the remaining bus. It allows the simulation of the well-established serial-bus system CAN, MOST, LIN or FlexRay. The serial-bus system CAN is used in the driving simulator to represent the serial-bus system of the virtual car. Table 8.1 shows the data of the available virtual control units that is represented by the information provided by the driving simulation, the EEG and the calculation of the driver stress. When receiving for example the information about the simulated engine speed from the OpenDS, the data logger puts the information into the corresponding control unit, which would be the engine control unit in this case. The newly received information from the data logger is provided by the control units within the serial-bus system CAN to other control units. The remaining bus

²emWave is a software of the company HeartMath Inc. that calculates the heart rate variability and the stress level. More information about emWave can be found on www.heartmath.com/emwave-technology

³CANoe is a software of Vector GmbH that allows the simulation of the remaining bus, like CAN, MOST, LIN or FlexRay. More information about CANoe can be found on www.vector.com

Control Unit Name	Information
Environment	Speedlimit
Engine	Speed
	Acceleration
	State
Engine Information	Milage
	Maximum Speed
EEG	Low Alpha
	High Alpha
	Beta
	Gamma
	Theta
	Meditation
	Excitement
Fuel	Fuel Consumption
	Optimal Fuel Consumption
	Petrol Level
Gear	Position
GPS	Heading
	Longitude
	Latitude
Powertrain	Brake
	Engine speed
	Throttle
	Engine Power
Steering	Steeringwheel Angle
	Horn
Stress Monitor	Stress
	IBI
	Accumulated Stress

Table 8.1: The information with their corresponding electronic control units that is provided by the driving simulator in the simulation of the remaining bus

simulation allows to connect external applications or hardware control units to the simulation of the remaining bus by using a hardware interface. As in the evaluation the serial-bus system CAN was used, the CAN hardware interface was used to connect the remaining bus simulation with the embedded computer. However, it is also possible to use for example a FlexRay interface for connecting the embedded computer with the remaining bus simulation, when the serial-bus system FlexRay is simulated in CANoe.

The embedded computer contains the applications that are developed to run on the centre console of the car, like the developed prototype of the driving system. Therefore, the embedded computer is connected to a touchscreen for showing the graphical user interface of the application to the driver. Furthermore, the touchscreen allows the driver to control the application using the touch capability of the touchscreen. As the embedded computer is connected to the simulation of the remaining bus using the hardware CAN-interface, the application has the opportunity to work with the data of the control units shown in Table 8.1 that are part of the simulated CAN.

For example, the developed prototype of the driving system was running during the evaluation on the embedded computer of the driving simulator, why the prototype first had to be connected to the interfaces of the driving simulator. This was done by using the CAN interface provided within the embedded computer. The CAN interface allowed the prototype of the driving system to gather the necessary information from the virtual vehicle and the driver. Therefore, the interface module of the prototype was modified to work with the provided hardware CAN interface of the embedded computer. Furthermore, the simulated control units of the remaining bus simulation, shown in Table 8.1, were registered in the interface module of the prototype. The registration allowed the interface module of the driving system to access the information of the simulated control units by using the hardware CAN-interface of the driving simulator.

8.2 Experimental set-up

The experimental set-up of the evaluation was created on the basis of hypotheses that were defined using the research questions proposed in Section 1.2. However, the evaluation was separated in two experimental set-ups, one set-up for each research question. The separation of the evaluation allowed to limit the duration of a test drive to a maximum of one hour per test person. This allowed to reduce the influence of a bad driving behaviour to the results of the evaluation, as a long evaluation period can cause inattention or disincentive and, thus, to a bad driving behaviour. Furthermore, the separation allowed the verification or the refutation of the defined hypotheses during the evaluation of the adaptive and rule-based driving system. Thus,

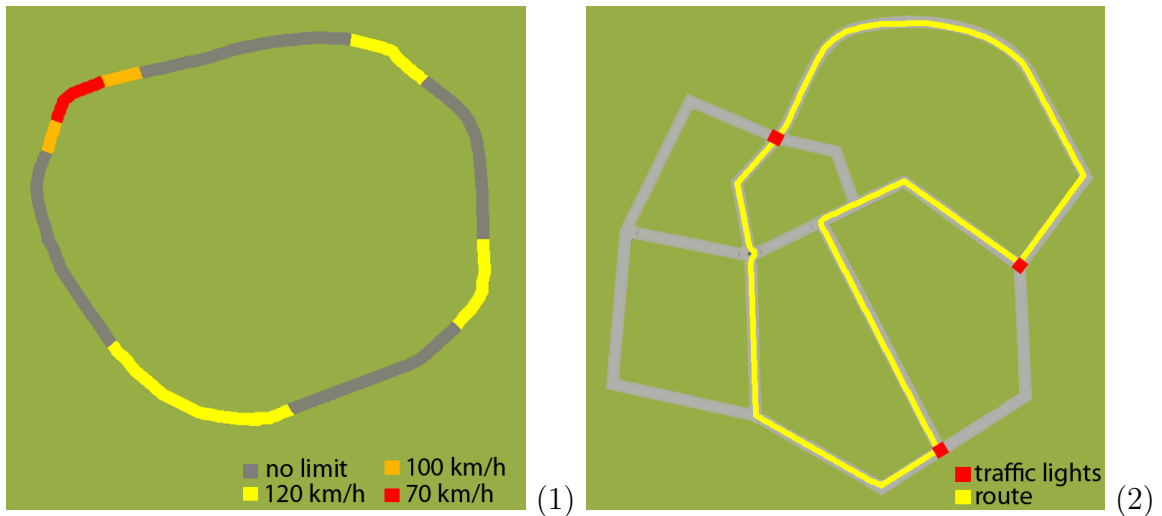

Figure 8.3: The routes of the evaluation on the highway (1) and the city (2)

the proposed research questions could be answered on the basis of the evaluation results. The following hypotheses were created and used in the evaluation of the driving system to answer the proposed research questions:

1. The driving system improves the driving behaviour in terms of energy-efficiency and safety by giving driving recommendations on time, while considering the driver condition and the individual driving behaviour.
2. The adaptiveness of the driving system increases the user acceptance of the driving system.

The evaluation of the driving system was done in Germany using 42 test drivers. Each test driver was attached with an ear and an EEG sensor to obtain the stress level and the EEG. The first 20 test drivers were used to test hypothesis (1), whereas 22 test drivers were used for testing hypothesis (2). Each test driver had to drive four journeys on the driving simulator. Two journeys on a highway and two journeys within a city. Figure 8.3 shows the routes on the highway and within the city. The highway is a circular route with four lanes, in which one lap is about 12 kilometres. The test drivers had to drive 16 kilometres, however only the last 10 kilometres of the journey were considered in the evaluation, as the drivers had to get familiar in the first kilometres with the route and the driving system. In order to represent a German highway, there are parts on the highway with no speed limit. However, there are also parts on the highway with a speed limit of 70 km/h, 100 km/h, and

120 km/h. Furthermore, there was traffic on the highway with cars that drive at a maximum speed of 120 km/h on the left lane and 80 km/h on the right lane. In the city, the drivers had to drive a defined circular route. One lap on the route has a length of about 1.5 kilometres. In order to represent the roads in a Germany city, the speed limits were set to 50 km/h. The test drivers had to drive about six kilometres or four laps on the defined route. However, to get familiar with the route and the driving simulator, only the last 4 kilometres of the city route were considered in the evaluation. Besides a roundabout, the route consisted of five crossroads. Three crossroads were using traffic lights to regulate the traffic at the crossroads. The traffic cars on the route adhered the speed limit of 50 km/h, whereas most of the traffic cars drove at 30 km/h.

During the evaluation of the hypotheses, the driving system showed recommendations to the test drivers on the basis of the measured information from the car, the driver and the environment. A recommendation to the test drivers were shown when the driving system detected a deviation from the typical driving behaviour or a broken driving rule. Due to the limited information gathered from the driving simulator, the driving system considered only two aspects of the typical driving behaviour that are the typical manner of driving and the typical stress level. Furthermore, the driving system showed a recommendation to the test drivers when a broken driving rule was detected. In the following the driving rules are listed that were considered by the driving system to show a recommendation:

- Shift into a higher gear as soon as possible at the latest at 2500 revolutions
- Switch the engine off when it is planned to idle longer than a minute
- Do not exceed the speed limit
- Keep enough distance to the preceding car

8.2.1 Evaluating the first hypothesis

To test hypothesis (1) in the first part of the evaluation, metrics were defined on the basis of the definition of energy-efficiency and safety. Energy-efficiency is defined in Section 1.4.2 as the ratio of the travelled distance and the burned fuel, whereas safety is defined in Section 1.5.2 as the ratio of travelled distance and the usage of the road

without casualties. Thus, to test the hypothesis (1), the fuel consumption as well as the mileage of the car and the occurred casualties were recorded during the four journeys of the 20 test drivers. In the evaluation a casualty was defined as exceeding the speed limit. The distance to car in front was not considered as a casualty in the evaluation, although the driving system shows a recommendation to the driver when the driver has not enough distance to the car in front. During the evaluation an equal condition could not be guaranteed for the distance to the car in front, in which the test drivers had the same amount of virtual cars in front. Thus, only the fuel consumption as well as the mileage of the car and the time in which the speed limit was exceeded were recorded during the evaluation.

Journey	Use driving system	Even subject number	Odd subject number
1	No	Highway (16km)	City (6km)
2	No	City (6km)	Highway (16km)
3	Yes	Highway (16km)	City (6km)
4	Yes	City (6km)	Highway (16km)

Table 8.2: The within-group design of the hypothesis (1) evaluation including the Latin square that was used to order the routes

To measure an improvement of the driving behaviour in terms of energy-efficiency or safety, the 20 test drivers had to drive without and with the driving system on the highway and the city. Due to the limited resources of test drivers, the within-group design [106] was chosen for the evaluation of hypothesis (1). Furthermore, the Latin square was used to order the driving sequence of the routes. This allows to avoid the influence of the journey order to the results, why the drivers had to start to drive either on the highway or in the city based on their subject number. Table 8.2 shows the within-group design of the hypothesis (1) evaluation including the Latin square that was used to order the routes.

In the first two journeys the drivers had to drive without the driving system and, thus, got no recommendations to improve the driving behaviour. This allowed to determine the typical driving behaviour of the test drivers and to record the driving behaviour without the influence of the driving system, as the driver may have driven more efficient or safe when the driver had known the purpose of the evaluation. Thus, at the beginning of the evaluation the drivers were not told the purpose of the evaluation. Instead, they were told to drive in their usual manner. In the first

Questionnaire

Personal Information

Age _____ **Sex** m f **How long do you hold a driving licence?** _____

Questions

Do you drive regularly?

Yes No

If yes, how often? _____

Please determine how often you are driving in which area (in %):

City Highway Rural roads

Have you heard about energy-efficient or eco driving?

Yes No

Have you been in a driver training with the focus on energy-efficient or eco driving?

Yes No

If yes, how often and how long (Days / Hours)?

Have you been in a driver training with the focus on safety?

Yes No

If yes, how often and how long (Days / Hours)?

How do you feel at the moment?

Concentrated Stressed Relaxed Nervous tired

How long do you sleep regularly?

< 5 6 7 8 9 <

Figure 8.4: The first page of the questionnaire that was used in the evaluation of hypothesis (1) to get information about the driver (*cont.*)

Are you easy distractible? (0 easy concentrated – 4 easy distractible)														
	0	1	2	3	4									
	<input type="checkbox"/>	<input type="checkbox"/>	<input type="checkbox"/>	<input type="checkbox"/>	<input type="checkbox"/>									
How often do you play video games? (0 not at all – 4 very often)														
	0	1	2	3	4									
	<input type="checkbox"/>	<input type="checkbox"/>	<input type="checkbox"/>	<input type="checkbox"/>	<input type="checkbox"/>									
						1	2	3	4	5	6	7		n/a
I like it to save fuel	Totally disagree	<input type="checkbox"/>	<input type="checkbox"/>	<input type="checkbox"/>	<input type="checkbox"/>	<input type="checkbox"/>	<input type="checkbox"/>	<input type="checkbox"/>	<input type="checkbox"/>	<input type="checkbox"/>	<input type="checkbox"/>	<input type="checkbox"/>	Totally agree	<input type="checkbox"/>
I like it to increase the safety on the road	Totally disagree	<input type="checkbox"/>	<input type="checkbox"/>	<input type="checkbox"/>	<input type="checkbox"/>	<input type="checkbox"/>	<input type="checkbox"/>	<input type="checkbox"/>	<input type="checkbox"/>	<input type="checkbox"/>	<input type="checkbox"/>	<input type="checkbox"/>	Totally agree	<input type="checkbox"/>
I would change my driving behaviour to save fuel	Totally disagree	<input type="checkbox"/>	<input type="checkbox"/>	<input type="checkbox"/>	<input type="checkbox"/>	<input type="checkbox"/>	<input type="checkbox"/>	<input type="checkbox"/>	<input type="checkbox"/>	<input type="checkbox"/>	<input type="checkbox"/>	<input type="checkbox"/>	Totally agree	<input type="checkbox"/>
I would change my driving behaviour to increase the road safety	Totally disagree	<input type="checkbox"/>	<input type="checkbox"/>	<input type="checkbox"/>	<input type="checkbox"/>	<input type="checkbox"/>	<input type="checkbox"/>	<input type="checkbox"/>	<input type="checkbox"/>	<input type="checkbox"/>	<input type="checkbox"/>	<input type="checkbox"/>	Totally agree	<input type="checkbox"/>
I would like to use a driving system that tries to improve my driving behaviour	Totally disagree	<input type="checkbox"/>	<input type="checkbox"/>	<input type="checkbox"/>	<input type="checkbox"/>	<input type="checkbox"/>	<input type="checkbox"/>	<input type="checkbox"/>	<input type="checkbox"/>	<input type="checkbox"/>	<input type="checkbox"/>	<input type="checkbox"/>	Totally agree	<input type="checkbox"/>

Figure 8.4: The second page of the questionnaire that was used in the evaluation of hypothesis (1) to get information about the driver

journey, the drivers with an even subject number drove 16 km on the highway and 6 km on the city route during the second journey. In contrast, the drivers with an odd subject number drove first in the city and afterwards on the highway. After the first two journeys the driving system was introduced to the drivers. If possible, the test drivers should adhere the recommendations shown by the driving system during the next journeys. In the third journey the drivers with the even subject number drove on the highway and in the last journey within the city. In contrast, test drivers with an odd subject number drove in the third journey in the city and then on the highway. However, during the last two journeys, recommendations were shown to the drivers by the driving system in order to improve their driving behaviour in terms of energy-efficiency and safety. This allowed to record the fuel consumption of the car and the mileage of the drivers when driving according to the recommendations.

At the end of the evaluation of hypothesis (1), a questionnaire was presented to the drivers. As the questionnaire contained questions about energy-efficiency and safety on the road and, thus, the driver may have driven more energy-efficient or safer when the driver knew or sensed the purpose of the evaluation, the questionnaire had to be at the end of the evaluation. This allowed not to influence the driving behaviour during the first and second journey, in which the typical driving behaviour

of the driver was measured. As the evaluation was done in Germany, the questions of the questionnaire were in the German language. Figure 8.4 shows the translated questionnaire that was used in the evaluation of hypothesis (1). The first questions of the questionnaire allowed to get an overview of the age and the driving experience. Furthermore, the questionnaire consisted of questions to obtain the information about the state of the driver. For example, questions about the current feeling as well as the sleeping period and the information about the distractibility. This allowed to measure if the drivers felt for example stressed or sleepy after using the driving system. In order to determine if the test drivers had experience with driving in simulated environments, a question about playing video games was asked. Finally, to obtain information about the stance on energy-efficient and safe driving as well as the stance of the drivers on energy-efficient and safe driving systems, several questions were asked at the end of the questionnaire with the focus on obtaining personal information about the drivers.

8.2.2 Evaluating the second hypothesis

In the second part of the evaluation, hypothesis (2) was tested, using a questionnaire. For evaluating hypothesis (2) 22 test drivers drove 4 journeys. The test drivers drove two journeys on the highway and two journeys on the city route. The routes of the highway and the city were the same as in the first part of the evaluation. In contrast to the evaluation of hypothesis (1), the test drivers were using the driving system in every journey. However, instead of adhering the shown recommendations, the test drivers had the opportunity to ignore the shown recommendations in the evaluation of hypothesis (2). This allowed the driving system to adapt itself to the individual driving behaviour on the basis of the ignored recommendations. Furthermore, the energy-efficiency and safety of the journeys were not measured, as only the user acceptance was for interest in the evaluation of the hypothesis (2).

The adaptive feature of the driving system was turned off in two journeys of the driving system, whereas the adaptive feature was turned on in the second two journeys of the evaluation. However, the 22 test drivers did not know when the adaptive feature was turned on or off in order not to influence the result of the evaluation. Table 8.3 shows the evaluation plan of the hypothesis (2). Due to the limited resources of test drivers, the within-group design [106] was chosen for the evaluation of hypothesis (2). Furthermore, the Latin square was used to order the sequence of the routes and the sequence of the usage of the driving systems adaptive feature. This allowed to avoid

Journey	Adaptation		Even subject number	Odd subject number
	Even subject number	Odd subject number		
1	No	Yes	Highway (16km)	City (6km)
2	No	Yes	City (6km)	Highway (16km)
User Acceptance Survey				
3	Yes	No	Highway (16km)	City (6km)
4	Yes	No	City (6km)	Highway (16km)
User Acceptance Survey				

Table 8.3: The driving rules with parameters and corresponding recommendations

the influence of the journey order and the order of the turned on adaptive feature. Thus, the drivers had to start to drive either on the highway or in the city and with or without the adaptive feature based on their subject number.

In the first two journeys, the test drivers with an even number had to drive without the adaptive feature of the driving system. In this case, the driving system showed recommendations to the driver when detected a broken driving rule without considering the driver condition or the driver reaction to an already shown recommendation. First, the test drivers drove on the highway, that was followed by the city route. In contrast, the test drivers with an odd subject number drove in the first two routes with the adaptive feature turned on. Furthermore, they drove first within the city and then on the highway. After the first two journeys, the test drivers had to fill out the user acceptance questionnaire based on the experience with the driving system in the first two journeys. After filling out the journey, the test drivers with an even subject number started to drive first on the city route and then on the highway. Furthermore, the adaptive feature was turned on for the test drivers with an even subject number. For the test drivers with an odd subject number, the adaptive feature of the driving system was turned off in the last two journeys. Furthermore, they started to drive first within the city and then on the highway. After the last two journeys, the test drivers had to fill out a second questionnaire on the basis of their experience with the turned on or turned off adaptive feature of the driving system.

The questionnaire that was used for measuring the user acceptance of the driving system was created on the basis of the Usefulness, Satisfaction, and Ease of Use (USE) questionnaire of Lund [107]. The questions of the USE questionnaire are categorised in usefulness, ease of use, ease of learning and satisfaction. However, the

USE questionnaire was modified by removing questions about the ease of use and other questions that did not fit into the evaluation and by adding new questions. For example questions were added to obtain information about the driver, which were also used in the questionnaire for the evaluation of hypothesis (1), or questions about the recommendation frequency. The following listing categorises the used questions for analysing the user acceptance into the categories of the USE questionnaire:

Usefulness

- It helps me to drive energy-efficient
- It helps me to drive safe
- It is useful
- It is disturbing
- It meets my needs
- It does everything I would expect it to do

Ease of Use

- It is easy to use
- It is user friendly
- It is flexible
- The recommendations are easy to understand
- The frequency of the recommendations is acceptable
- Using it is effortless
- I can use it without written instructions
- I don't notice inconsistencies as I use it
- Both, professional and regular users would like it

Satisfaction

- I am satisfied with it
- I would recommend it to a friend
- It is fun to use
- It works the way I want it to work
- It is wonderful
- I feel, I need to have it

Figure 8.5 shows the modified USE questionnaire. The first part of the questionnaire contains questions about the driving experience, the age of the driver and the stance on energy-efficient or safe driving. The questions about the personal information had to be filled out by the test drivers only in the questionnaire after the first two journeys. In contrast, the questions about the usefulness, satisfaction, ease of use, ease of learning and the mental state had to be answered in the first and second questionnaire, respectively after the second and the fourth journey. The test drivers had also the opportunity to write down positive or negative aspects of the driving system. Thus, The two surveys allowed to measure the user acceptance of the two driving systems with the turned on or off adaptive feature.

Questionnaire

Personal Information

Age _____ Sex m f How long do you hold a driving licence? _____

Do you drive regularly?

Yes No

If yes, how often? _____

Please determine how often you are driving in which area (in %):

City Highway Rural roads

How long do you sleep regularly?

< 5 6 7 8 9 <

Are you easy distractible? (0 easily concentrated– 4 easily distractible)

0 1 2 3 4

How often do you play racing games? (0 not at all – 4 very often)

0 1 2 3 4

Questions

		1	2	3	4	5	6	7	Total	n/a
I like it to save fuel	Totally disagree	<input type="checkbox"/>	<input type="checkbox"/>	<input type="checkbox"/>	<input type="checkbox"/>	<input type="checkbox"/>	<input type="checkbox"/>	<input type="checkbox"/>	agree	<input type="checkbox"/>
I like it to increase the safety on the road	Totally disagree	<input type="checkbox"/>	<input type="checkbox"/>	<input type="checkbox"/>	<input type="checkbox"/>	<input type="checkbox"/>	<input type="checkbox"/>	<input type="checkbox"/>	agree	<input type="checkbox"/>
I would change my driving behaviour to increase the energy-efficiency	Totally disagree	<input type="checkbox"/>	<input type="checkbox"/>	<input type="checkbox"/>	<input type="checkbox"/>	<input type="checkbox"/>	<input type="checkbox"/>	<input type="checkbox"/>	agree	<input type="checkbox"/>
I would change my driving behaviour to increase the road safety	Totally disagree	<input type="checkbox"/>	<input type="checkbox"/>	<input type="checkbox"/>	<input type="checkbox"/>	<input type="checkbox"/>	<input type="checkbox"/>	<input type="checkbox"/>	agree	<input type="checkbox"/>
I would like to use a driving system that tries to improve my driving behaviour	Totally disagree	<input type="checkbox"/>	<input type="checkbox"/>	<input type="checkbox"/>	<input type="checkbox"/>	<input type="checkbox"/>	<input type="checkbox"/>	<input type="checkbox"/>	agree	<input type="checkbox"/>

Figure 8.5: The first page of the questionnaire was used in the evaluation of hypothesis (2) to get information about the driver (*cont.*)

It helps me to drive energy efficient	Totally disagree	<input type="checkbox"/>	<input type="checkbox"/>	<input type="checkbox"/>	<input type="checkbox"/>	<input type="checkbox"/>	<input type="checkbox"/>	<input type="checkbox"/>	Total agree	<input type="checkbox"/>
It helps me to drive safe	Totally disagree	<input type="checkbox"/>	<input type="checkbox"/>	<input type="checkbox"/>	<input type="checkbox"/>	<input type="checkbox"/>	<input type="checkbox"/>	<input type="checkbox"/>	Total agree	<input type="checkbox"/>
It is useful	Totally disagree	<input type="checkbox"/>	<input type="checkbox"/>	<input type="checkbox"/>	<input type="checkbox"/>	<input type="checkbox"/>	<input type="checkbox"/>	<input type="checkbox"/>	Total agree	<input type="checkbox"/>
It is disturbing	Totally disagree	<input type="checkbox"/>	<input type="checkbox"/>	<input type="checkbox"/>	<input type="checkbox"/>	<input type="checkbox"/>	<input type="checkbox"/>	<input type="checkbox"/>	Total agree	<input type="checkbox"/>
It meets my needs	Totally disagree	<input type="checkbox"/>	<input type="checkbox"/>	<input type="checkbox"/>	<input type="checkbox"/>	<input type="checkbox"/>	<input type="checkbox"/>	<input type="checkbox"/>	Total agree	<input type="checkbox"/>
It does everything I would expect it to do	Totally disagree	<input type="checkbox"/>	<input type="checkbox"/>	<input type="checkbox"/>	<input type="checkbox"/>	<input type="checkbox"/>	<input type="checkbox"/>	<input type="checkbox"/>	Total agree	<input type="checkbox"/>
It is easy to use	Totally disagree	<input type="checkbox"/>	<input type="checkbox"/>	<input type="checkbox"/>	<input type="checkbox"/>	<input type="checkbox"/>	<input type="checkbox"/>	<input type="checkbox"/>	Total agree	<input type="checkbox"/>
It is user friendly	Totally disagree	<input type="checkbox"/>	<input type="checkbox"/>	<input type="checkbox"/>	<input type="checkbox"/>	<input type="checkbox"/>	<input type="checkbox"/>	<input type="checkbox"/>	Total agree	<input type="checkbox"/>
It is flexible	Totally disagree	<input type="checkbox"/>	<input type="checkbox"/>	<input type="checkbox"/>	<input type="checkbox"/>	<input type="checkbox"/>	<input type="checkbox"/>	<input type="checkbox"/>	Total agree	<input type="checkbox"/>
The recommendations are easy to understand	Totally disagree	<input type="checkbox"/>	<input type="checkbox"/>	<input type="checkbox"/>	<input type="checkbox"/>	<input type="checkbox"/>	<input type="checkbox"/>	<input type="checkbox"/>	Total agree	<input type="checkbox"/>
The frequency of the recommendations is acceptable	Totally disagree	<input type="checkbox"/>	<input type="checkbox"/>	<input type="checkbox"/>	<input type="checkbox"/>	<input type="checkbox"/>	<input type="checkbox"/>	<input type="checkbox"/>	Total agree	<input type="checkbox"/>
Using it is effortless	Totally disagree	<input type="checkbox"/>	<input type="checkbox"/>	<input type="checkbox"/>	<input type="checkbox"/>	<input type="checkbox"/>	<input type="checkbox"/>	<input type="checkbox"/>	Total agree	<input type="checkbox"/>
I can use it without written instructions	Totally disagree	<input type="checkbox"/>	<input type="checkbox"/>	<input type="checkbox"/>	<input type="checkbox"/>	<input type="checkbox"/>	<input type="checkbox"/>	<input type="checkbox"/>	Total agree	<input type="checkbox"/>
I don't notice any inconsistencies as I use it	Totally disagree	<input type="checkbox"/>	<input type="checkbox"/>	<input type="checkbox"/>	<input type="checkbox"/>	<input type="checkbox"/>	<input type="checkbox"/>	<input type="checkbox"/>	Total agree	<input type="checkbox"/>
Both, professional and regular users would like it	Totally disagree	<input type="checkbox"/>	<input type="checkbox"/>	<input type="checkbox"/>	<input type="checkbox"/>	<input type="checkbox"/>	<input type="checkbox"/>	<input type="checkbox"/>	Total agree	<input type="checkbox"/>
I am satisfied with it	Totally disagree	<input type="checkbox"/>	<input type="checkbox"/>	<input type="checkbox"/>	<input type="checkbox"/>	<input type="checkbox"/>	<input type="checkbox"/>	<input type="checkbox"/>	Total agree	<input type="checkbox"/>
I would recommend it to a friend	Totally disagree	<input type="checkbox"/>	<input type="checkbox"/>	<input type="checkbox"/>	<input type="checkbox"/>	<input type="checkbox"/>	<input type="checkbox"/>	<input type="checkbox"/>	Total agree	<input type="checkbox"/>
It is fun to use	Totally disagree	<input type="checkbox"/>	<input type="checkbox"/>	<input type="checkbox"/>	<input type="checkbox"/>	<input type="checkbox"/>	<input type="checkbox"/>	<input type="checkbox"/>	Total agree	<input type="checkbox"/>
It works the way I want it to work	Totally disagree	<input type="checkbox"/>	<input type="checkbox"/>	<input type="checkbox"/>	<input type="checkbox"/>	<input type="checkbox"/>	<input type="checkbox"/>	<input type="checkbox"/>	Total agree	<input type="checkbox"/>
It is wonderful	Totally disagree	<input type="checkbox"/>	<input type="checkbox"/>	<input type="checkbox"/>	<input type="checkbox"/>	<input type="checkbox"/>	<input type="checkbox"/>	<input type="checkbox"/>	Total agree	<input type="checkbox"/>
I feel, I need to have it	Totally disagree	<input type="checkbox"/>	<input type="checkbox"/>	<input type="checkbox"/>	<input type="checkbox"/>	<input type="checkbox"/>	<input type="checkbox"/>	<input type="checkbox"/>	Total agree	<input type="checkbox"/>
How do you feel at the moment?										
Concentrated	Stressed	Relaxed	Nervous	Tired						
<input type="checkbox"/>	<input type="checkbox"/>	<input type="checkbox"/>	<input type="checkbox"/>	<input type="checkbox"/>						

Figure 8.5: The second page of the questionnaire was used in the evaluation of hypothesis (2) to measure the user acceptance of the adaptive and non-adaptive driving systems

Chapter 9

Results

The focus in the first part of the evaluation was on the energy-efficiency and safety of the driving system. 20 test drivers drove four journeys, in which the energy-efficiency and safety were measured during the journey. In the first two journeys the drivers drove without the driving system. During the last two journeys the test drivers got energy-efficiency and safety relevant recommendations by the driving system. At the end of the four journeys, the drivers had to fill out a questionnaire that allowed to get information about the driver.

The result of the questionnaire is presented in Table 9.1. It shows that the 20 test drivers had an average age of 23.6. whereas 3 test drivers were female and 17 male. In average, the test drivers hold the driving licence about 5 years and drove about 4 times a week with their car. The test drivers had the most driving experience in the city (51.65 %), which is followed by the driving experience on rural roads (28.90 %) and on the highway (19.40 %). The average test driver sleeps 6.85 hours. All test drivers had heard about energy-efficiency driving, however none of the test drivers attended to a driver training with the focus on energy-efficiency. In contrast, five test drivers attended in average once for one day to a driver training with the focus on safety. 4 test drivers felt concentrated after the journey, while 9 were relaxed and 10 tired. The question if the test drivers were easy distractible were answered in average with 1.75 on a scale between 0 and 4, in which 0 is easy concentrated and 4 easy distractible. The average test driver played racing games in an average of 0.95 on a scale between 0, not at all, and 4, very often. In the last five questions, the test drivers had to determine if they agree or disagree with a statement. A scale between 1, totally disagree, and 7, totally agree, were used. The statement that the

Questions	Units	Overall Average
Age		23.60
Gender		3 female / 17 male
How long do you hold a driving licence?	(in years)	5.04
Do you drive regularly?	(h / week)	4.15
Please determine how often you are driving in the following areas	city (in %)	51.65
	highway (in %)	19.40
	rural (in %)	28.90
How long do you sleep regularly?	(in hours)	6.85
Did you hear about energy-efficient driving?		20 yes / 0 no
Did you attend to a driver training with the focus on energy-efficiency?		0 yes / 20 no
Did you attend to a driver safety training?		5 yes / 15 no
- If yes, how often and how long?		Once, for 1 day
How do you feel at the moment?	concentrated	4
	relaxed	9
	tired	10
Are you easy distractible?	easy concentrated - easy distractible (0-4)	1.75
How often do you play racing games?	not at all - very often (0-4)	0.95
I like it to save fuel	totally disagree - totally agree (1-7)	6.00
I like it to increase the safety on the road	totally disagree - totally agree (1-7)	6.35
I would change my driving behaviour to increase the energy-efficiency	totally disagree - totally agree (1-7)	5.60
I would change my driving behaviour to increase the road safety	totally disagree - totally agree (1-7)	6.15
I would like to use a driving system that tries to improve my driving behaviour	totally disagree - totally agree (1-7)	4.55

Table 9.1: The results of the questionnaire used in the first part of the evaluation to get information about the test drivers

test drivers liked to save fuel were answered with an average result of 6.00. The result of the statement I like to increase the safety on the road was answered with 6.35 in average. However, the test drivers tend to agree to the statement to change their driving behaviour to increase the road safety in average with 5.60. The test

User	City (~4km)					
	Without driving system		With driving system		Difference	
	Fuel consumption (litre)	Speed limit adherence	Fuel consumption (litre)	Speed limit adherence	Fuel consumption (litre)	Speed limit adherence
1	0.29	98.75%	0.31	99.18%	0.02	0.44%
2	0.29	97.87%	0.24	96.56%	-0.04	-1.31%
3	0.33	95.87%	0.26	94.37%	-0.07	-1.50%
4	0.56	95.49%	0.24	99.05%	-0.32	3.56%
5	0.35	92.71%	0.33	95.27%	-0.02	2.56%
6	0.41	95.78%	0.27	96.99%	-0.14	1.21%
7	0.36	99.11%	0.39	97.77%	0.03	-1.34%
8	-	-	-	-	-	-
9	0.42	95.96%	0.32	96.00%	-0.10	0.04%
10	0.30	96.31%	0.23	95.40%	-0.07	-0.91%
11	0.33	89.46%	0.30	88.10%	-0.03	-1.36%
12	0.28	96.25%	0.25	99.45%	-0.04	3.20%
13	0.52	96.12%	0.34	93.14%	-0.18	-2.98%
14	0.26	90.10%	0.26	94.39%	0.00	4.29%
15	0.34	98.54%	0.28	96.84%	-0.06	-1.69%
16	0.60	93.12%	0.43	93.20%	-0.17	0.07%
17	0.27	99.56%	0.25	99.83%	-0.02	0.27%
18	0.28	95.69%	0.24	98.74%	-0.04	3.05%
19	-	-	-	-	-	-
20	0.38	86.33%	0.29	92.40%	-0.09	6.06%
21	0.34	96.95%	0.29	96.09%	-0.05	-0.86%
22	0.37	92.37%	0.30	91.81%	-0.07	-0.56%
Total Average	0.36	95.12%	0.29	95.73%	-0.07	0.61%
				For 100 km	-1.80	

Table 9.2: The results of the first part of the evaluation, in which hypothesis (1) was evaluated on the city route

drivers would agree in average with 6.15 to the statement that they would change the driving behaviour to increase the road safety. The statement that the test drivers would like to use a driving system to improve their driving behaviour was answered in average with 4.55.

The results of evaluating the effects of the driving system to the driving behaviour in terms of energy-efficiency and safety are shown in Table 9.2 for the city route and in Table 9.3 for the highway. During the evaluation the test drivers 8 and 19 had to cancel the evaluation due to simulator sickness¹. Thus, two more test drivers attended in the first part of the evaluation in order to get 20 test drives. The result

¹Simulator sickness is triggered by deceiving the sensory organs using virtual reality. The sickness occurs often when there is a discrepancy between the visual information and the vestibular system.

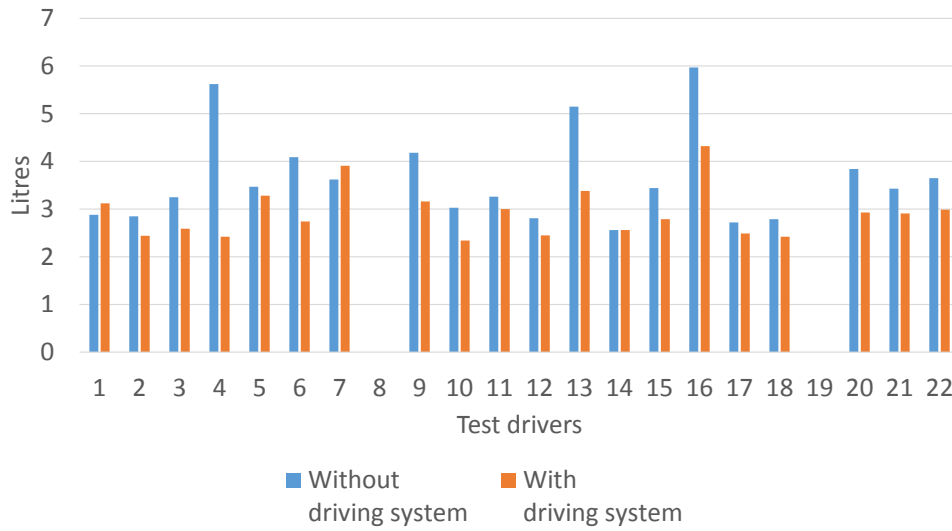

Figure 9.1: The fuel consumption of the test drivers on the 4 km city route

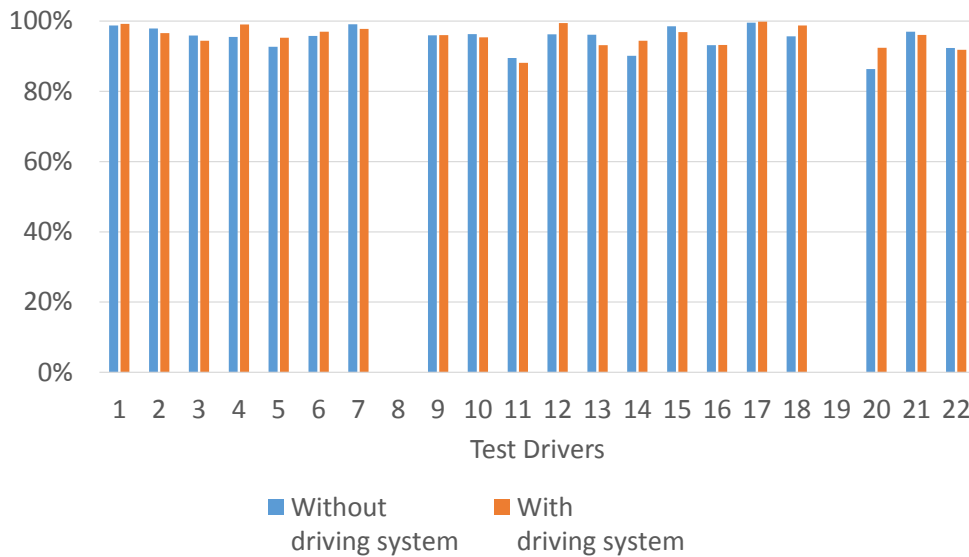

Figure 9.2: The speed limit adherence of the test drivers on the 4 km city route

show that the 20 test drivers needed on the city route in average 0.36 litres for 4 km and had a speed limit adherence of 95.12 % when not using the driving system. A speed limit adherence of 100 % indicates the adherence of the speed limit during the whole journey, whereas 0 % indicates an exceeding of the speed limit during the whole journey. When using the driving system in the city, the test drivers needed about 0.29 litres fuel. Furthermore, the speed limit adherence increased slightly to 95.73 %. Thus, a decrease of the fuel consumption by 0.07 litres for 4 km or 1.8 litres/100 km and an increase of the speed limit adherence by 0.61 % were measured.

User	Highway (~10km)					
	Without driving system		With driving system		Difference	
	Fuel consumption (litre)	Speed limit adherence	Fuel consumption (litre)	Speed limit adherence	Fuel consumption (litre)	Speed limit adherence
1	0.48	65.49%	0.42	92.76%	-0.06	27.27%
2	0.52	75.85%	0.47	86.86%	-0.06	11.01%
3	0.47	83.22%	0.43	84.34%	-0.04	1.12%
4	0.64	82.46%	0.52	97.18%	-0.13	14.72%
5	0.66	45.69%	0.47	69.82%	-0.20	24.14%
6	0.61	45.22%	0.56	53.66%	-0.05	8.45%
7	0.55	92.63%	0.49	96.40%	-0.06	3.77%
8	-	-	-	-	-	-
9	0.49	83.94%	0.46	91.17%	-0.02	7.22%
10	0.48	47.45%	0.54	53.28%	0.05	5.83%
11	0.49	66.44%	0.44	76.43%	-0.05	9.99%
12	0.52	84.01%	0.56	96.12%	0.04	12.11%
13	0.60	61.73%	0.49	88.30%	-0.11	26.57%
14	0.42	62.27%	0.41	93.17%	-0.01	30.90%
15	0.43	89.25%	0.38	82.14%	-0.05	-7.11%
16	0.64	33.18%	0.61	42.50%	-0.03	9.32%
17	0.49	86.29%	0.43	95.42%	-0.06	9.13%
18	0.48	85.11%	0.54	96.42%	0.06	11.31%
19	-	-	-	-	-	-
20	0.68	69.09%	0.54	86.31%	-0.15	17.22%
21	0.65	44.10%	0.55	88.76%	-0.10	44.66%
22	0.50	53.35%	0.47	65.75%	-0.03	12.40%
Total Average	0.54	67.84%	0.49	81.84%	-0.05	14.00%
				For 100 km	-0.52	

Table 9.3: The results of the first part of the evaluation, in which hypothesis (1) was evaluated on the highway

Figure 9.1 shows the fuel consumption of each test driver when using the driving system and when not using the driving system. It can be seen that the majority of test drivers needed less fuel when using the driving system. However, test driver 1 and 7 needed more fuel when using the driving system, while test driver 14 needed the same amount of fuel on the 4 km city route. The adherence of the speed limit on the city route is shown for each test driver in Figure 9.2. 7 test drivers adhered the speed limit more often when using the driving system. 4 test drivers did not change their driving behaviour when using the driving system and, thus, no difference were measured in the adherence of the speed limit when using or not using the driving system. However, 9 test drivers slightly worsen the speed limit adherence when using the driving system on the city route.

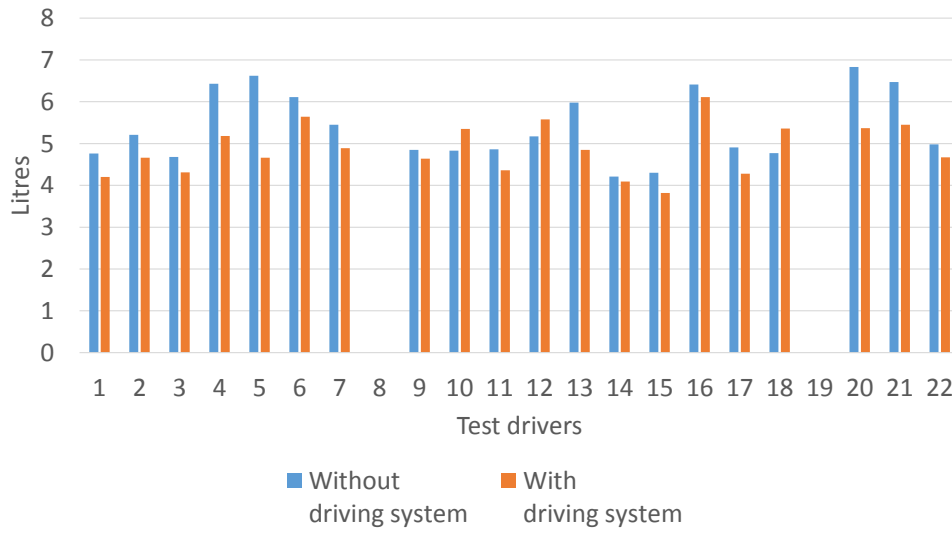

Figure 9.3: The fuel consumption of the test drivers on the 10 km highway

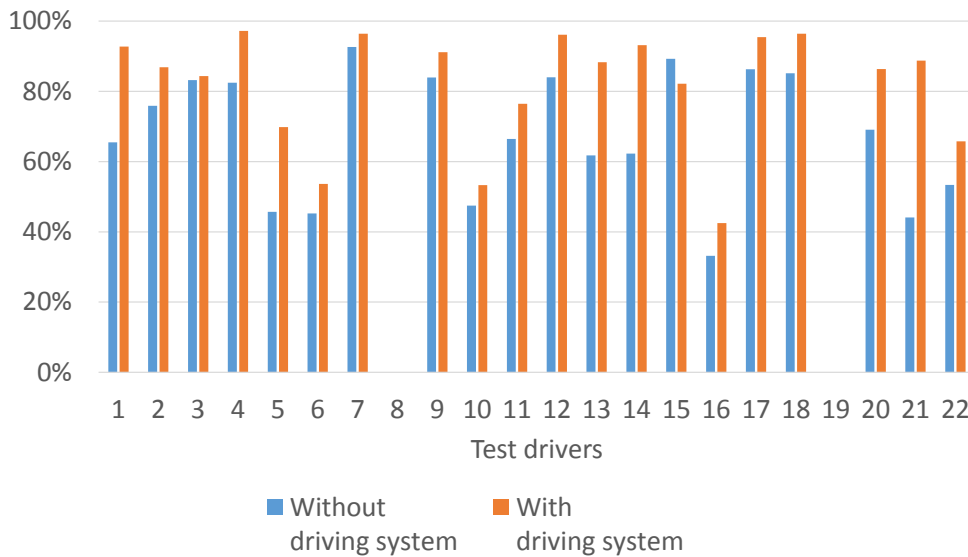

Figure 9.4: The speed limit adherence of the test drivers on the 10 km highway

Table 9.3 shows the results of the first evaluation part on the highway. The average fuel consumption of the 20 test drivers was 0.54 litres on the 10 km highway route without using the driving system. The average speed limit adherence was about 67.84 % on the highway when the driving system was not used. After introducing the driving system to the drivers, an average decrease of the fuel consumption by 0.05 litres for 10 km were detected. Thus, the test drivers burned 0.49 litres or

4.9 litres/100 km fuel for driving 10 km on the highway. Furthermore, when the driving system was used, the speed limit was adhered on the highway 81.84 % of the driving time. This is an increase of the speed limit adherence of 14 %.

Figure 9.3 shows the fuel consumption on the highway for each driver. 17 out of 20 test drivers reduced their fuel consumption when using the driving system. In contrast, the fuel consumption increased for the test drivers 10, 12 and 18 when the driving system was used. The adherence of the speed limit with and without the driving system is illustrated for each driver in Figure 9.4. 19 test drivers increased the adherence of the speed limit when the driving system was used. However, test driver number 15 decreased the adherence of the speed limit in comparison to the journey, in which the driving system was not used.

In the second part of the evaluation, it was tested if the adaptive feature of the driving system increases the user acceptance of the driving system. Therefore, 22 test drivers drove four journeys. The user acceptance of the driving system was measured using a modified USE questionnaire. In two journeys the adaptive feature was turned off. After the two journeys the test drivers had to answer the questions of the questionnaire. In the next two journeys the adaptive feature of the driving system was turned on. Afterwards, the test drivers had to answer again the questions of the questionnaire.

Table 9.4 shows the results of the questionnaire that was used to collect information about the test drivers. One female and 21 male test drivers attended in the second part of the evaluation. Furthermore, the test drivers were in average 26.55 years old and held their driving licence in average 8.27 years. The test drivers drove about 6.23 times per week with their vehicle. Furthermore, they drove in average 45.45 % in the city, 21.23 % on the highway and 33.77 % on rural roads. The 22 test drivers slept in average 6.95 hours per night and tend to be easy concentrated, as the average answer to the question if they are easy distractible was 1.55 on a scale from 0, easy concentrated, to 4, easy distractible. The answer how often the test drivers play video games was 1.27 on a scale from 0, not at all, to 4, very often. The scales for the last five questions were from 1, totally disagree, to 7, totally agree. The test drivers liked to save fuel with 5.95 and agreed to like the increasing of road safety in average with 6.14. However, the test drivers agreed in average with 5.23 to change their driving behaviour to increase energy-efficiency. In contrast, the average

Questions	Units	Overall Average
Age		26.55
Gender		1 female / 21 male
How long do you hold a driving licence?	(in years)	8.27
Do you drive regularly?	(h / week)	6.23
Please determine how often you are driving in the following areas	city (in %)	45.45
	highway (in %)	21.23
	rural (in %)	33.77
How long do you sleep regularly?	(in hours)	6.95
Are you easy distractible?	easy concentrated - easy distractible (0-4)	1.55
How often do you play racing games?	not at all - very often (0-4)	1.27
I like it to save fuel	totally disagree - totally agree (1-7)	5.95
I like it to increase the safety on the road	totally disagree - totally agree (1-7)	6.14
I would change my driving behaviour to increase the energy-efficiency	totally disagree - totally agree (1-7)	5.23
I would change my driving behaviour to increase the road safety	totally disagree - totally agree (1-7)	5.55
I would like to use a driving system that tries to improve my driving behaviour	totally disagree - totally agree (1-7)	4.50

Table 9.4: The results of the questionnaire used in the second part of the evaluation to get information about the test drivers

acceptance of the test drivers to change the driving behaviour to increase the road safety was 5.55. The test drivers would agree to use a driving system to improve their driving behaviour in average with 4.5.

On the basis of the modified USE questionnaire the user acceptance of two the versions of the driving system were measured. One version of the driving system was with and one without the adaptive feature. The questionnaire used a scale for measuring the user acceptance that was from 1, totally disagree, to 7, which meant totally agree. Furthermore, the questions of the questionnaire were categorised to measure the usefulness, ease of use and satisfaction of the driving systems.

Questions	Units	Adaptive	Non-Adaptive
It helps me to drive energy efficient	totally disagree - totally agree (1-7)	4.91	4.55
It helps me to drive safe	totally disagree - totally agree (1-7)	4.55	4.05
It is useful	totally disagree - totally agree (1-7)	5.09	4.64
It is disturbing	totally disagree - totally agree (1-7)	4.00	5.00
It meets my needs	totally disagree - totally agree (1-7)	4.17	3.36
It does everything I would expect it to do	totally disagree - totally agree (1-7)	5.05	4.12
Usefulness		4.63	4.29
It is easy to use	totally disagree - totally agree (1-7)	6.42	6.08
It is user friendly	totally disagree - totally agree (1-7)	5.91	5.31
It is flexible	totally disagree - totally agree (1-7)	4.21	4.00
The recommendations are easy to understand	totally disagree - totally agree (1-7)	6.55	6.59
The frequency of the recommendations is acceptable	totally disagree - totally agree (1-7)	5.05	2.91
Using it is effortless	totally disagree - totally agree (1-7)	6.00	5.95
I can use it without written instructions	totally disagree - totally agree (1-7)	6.45	6.27
I don't notice any inconsistencies as I use it	totally disagree - totally agree (1-7)	4.95	4.77
Both professional and regular users would like it	totally disagree - totally agree (1-7)	4.37	3.75
Ease of Use		5.55	5.07
I am satisfied with it	totally disagree - totally agree (1-7)	4.88	3.86
I would recommend it to a friend	totally disagree - totally agree (1-7)	4.59	3.64
It is fun to use	totally disagree - totally agree (1-7)	3.95	3.05
It works the way I want it to work	totally disagree - totally agree (1-7)	4.32	3.55
It is wonderful	totally disagree - totally agree (1-7)	3.35	2.60
I feel I need to have it	totally disagree - totally agree (1-7)	3.14	2.23
Satisfaction		4.04	3.15

Table 9.5: The results of the questionnaire used in the second part of the evaluation to measure the user acceptance

The results of the modified USE questionnaire are shown in Table 9.5. In terms of usefulness, the adaptive driving system was doing better than the non-adaptive driving system, as the average result of the adaptive driving system was 4.63 in contrast to 4.29 of the non-adaptive driving system. In the sense of the test drivers, the adaptive driving system helped the drivers to drive more energy-efficient and safe. Furthermore, it was more useful and less disturbing than the driving system without the adaptive feature. Finally, the adaptive driving system fitted the needs and the expectations of the test drivers better than the non-adaptive driving system.

The result in the category ease of use showed that the adaptive driving system (5.55) was rated in average better than the non-adaptive driving system (5.07). The test drivers agreed that the adaptive driving system is easier to use, user friendlier and more flexible than the driving system without the adaptive feature. In both driving systems, the drivers understood the recommendation easily. However, the test drivers disagreed with the recommendation frequency of the non-adaptive driving system. In contrast, the test drivers agreed that the recommendation frequency of the adaptive driving system was acceptable. The test drivers agreed that both driving systems were effortless to use and can be used without written instructions. Furthermore, the test drivers tended to notice slightly less inconsistencies during the usage of the adaptive driving system than during the usage of the non-adaptive driving system. In the sense of the test drivers professional and regular users would like the adaptive driving system more than the driving system without the adaptive feature.

Finally, the test drivers were more satisfied by the adaptive driving system that was rated in this category in average with 4.04, in contrast to 3.15 for the non-adaptive driving system. In this category, the test drivers agreed with 4.88 to be satisfied with the adaptive driving system. In contrast, the test drivers tend to disagree in terms of satisfaction with 3.86 when thinking about the non-adaptive driving system. Furthermore, the test drivers would recommend the adaptive driving system to a friend instead of the non-adaptive driving system. In terms of fun to use, the non-adaptive driving system was rated less than the adaptive driving system. For the test drivers, the adaptive driving system worked better in the way they wanted it to work. Furthermore, the test drivers seen the adaptive driving system more wonderful and felt that they need to have it.

Chapter 10

Discussion

In the first part of the evaluation, the effect of the driving system on the energy-efficiency and safety was measured on the city and highway route. Therefore, the fuel consumption, the adherence of the speed limit and the duration of the journey was captured. The metrics were used to validate the following hypothesis that was tested in the evaluation of the energy-efficiency and safety:

- The driving system improves the driving behaviour in terms of energy-efficiency and safety by giving driving recommendations on time, while considering the driver condition and the individual driving behaviour.

Figure 10.1 compares the needed fuel of all test drivers on the city and highway routes when using the driving system and when the driving system was not used. During journeys of the test drivers in the city, the fuel consumption was in sum about 19.44 % higher when the driving system was not used. Furthermore, the test drivers needed in sum about 9.26 % more fuel on the highway route without the usage of the driving system. However, the decrease of the fuel consumption was not as much as on the city route, as the driving system showed only recommendations relating to the driving rule to shift up as soon as possible and the test drivers drove without the driving system already with the highest gear. Thus, the test drivers did not broke the driving rule "shift as soon as possible" on the highway as much as on the city route. However, according to the results of the measured fuel consumption, it can be seen that there is a tendency that the presented driving system is able to increase

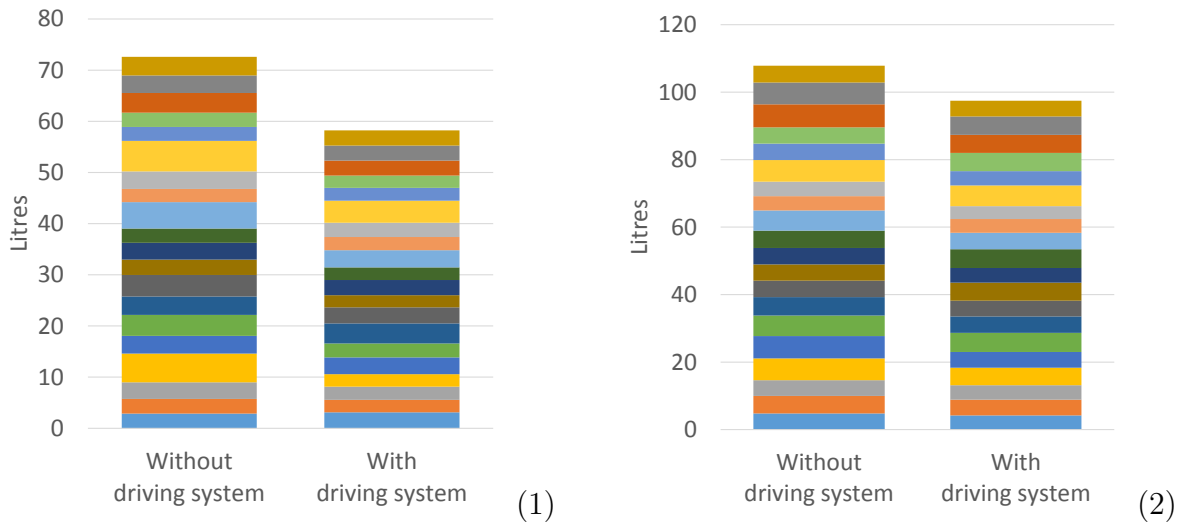

Figure 10.1: Comparison of fuel consumption of all drivers with and without the usage of the driving system on the city (1) and the highway (2) route

the energy-efficiency in total by 14.35 %. An increase of the energy-efficiency of a vehicle, when adhering the recommendations for energy-efficient driving, has been also reported by van den Hoed et al. [26] and van Mierlo et al. [11].

Figure 10.2 shows the comparison of the speed limit adherence of all drivers on the city and highway route when driving with and without the driving system. The test drivers adhered the speed limit on the city route without using the driving system in sum 0.61 % less than on the journey when the driving system was used. This was due to the characteristics of the city route that forced the test drivers to drive slowly within the city, why the test drivers were not able to driver faster than the speed limit of 50 km/h. In contrast to the city route, the results of the speed limit adherence differ significantly on the highway. The adherence of the different speed limits on the highway was in sum 14 % higher when using the driving system, as the driving system showed recommendations to the drivers when the test drivers exceeded the speed limit. It can be seen that there is a tendency that the presented driving system is able to increase the road safety in total by 7.31 %. An improvement of the driving behaviour in terms of safety was also reported by Lotan and Toledo [17] during the evaluation of their driving system.

The presented results of the energy-efficiency and safety evaluation show that the driving system has an influence on the driving behaviour. Furthermore, the results show that the driving system was able to improve the driving behaviour in terms of energy-efficiency and safety by showing recommendations, while the driving system

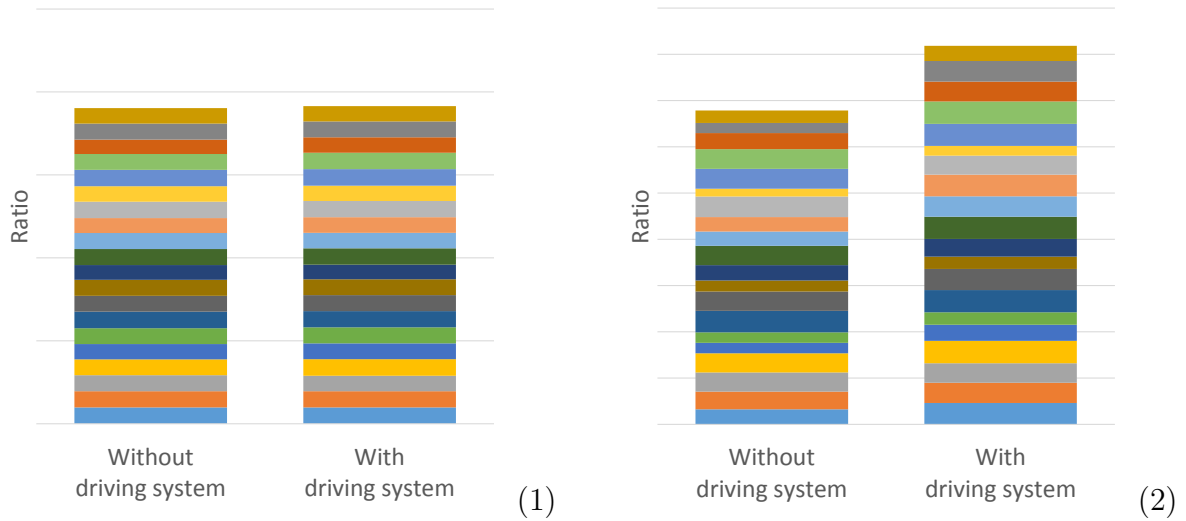

Figure 10.2: Comparison of speed limit adherence of all drivers with and without the usage of the driving system on the city (1) and the highway (2) route

considered also the driver condition and the individual driving behaviours of the test drivers. However, the energy-efficiency and safety could be increased more, when considering more driving rules in the driving system, as only two energy-efficiency and one safety relevant driving rules were considered in the evaluation. According to the results, the hypothesis can be answered positively in this part of the evaluation, as the driving system increased the energy-efficiency and safety while also considering the driver condition and the individual driving behaviour. Thus, the driving system had a positive influence to the driving behaviour of the test drivers. This was also proven in the studies of van den Hoed et al. [26] and Lotan and Toledo [17].

In the second part of the evaluation, the USE questionnaire was used to measure if the adaptive feature of the driving system has an influence on the acceptance of the driving system. The USE questionnaire was separated in questions about the usefulness, satisfaction and ease of use of the driving system. The questionnaire was used to validate the following hypothesis that was tested in the evaluation of the user acceptance:

- The adaptiveness of the driving system increases the user acceptance of the driving system.

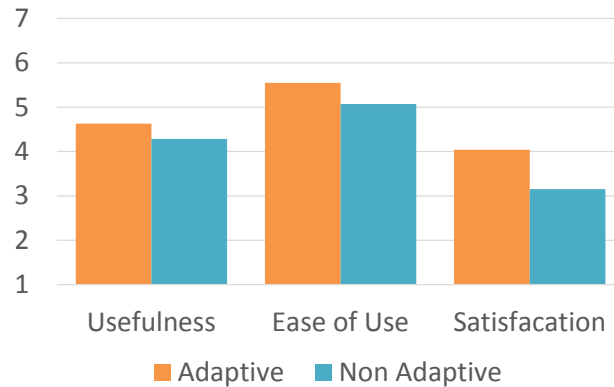

Figure 10.3: Comparison of usefulness, ease of use and satisfaction of the driving system with and without the adaptive feature

The results of the questionnaire are shown in Figure 10.3. It can be seen that the test drivers answered the questions related to the usefulness of the driving system about 7.34 % more positive when the adaptive feature of the driving system was turned on. Furthermore, the positive answers about the ease of use increased about 8.65 % and the satisfaction of the driving system increased about 22.03 %, when the test drivers used the adaptive driving system. Thus, it can be seen that the adaptive feature of the driving system is able to increase the user acceptance. However, according to the results of the questions about the satisfaction, the acceptance of the driving system could be increased more by creating a more user friendly interface, in which the recommendations are shown to the driver related to their importance. For example, instead of presenting all recommendations to the driver using an audio voice, some recommendations, like to shift the gear, could be presented by showing a symbol. Additionally, gamification¹ aspects, like setting incentives or using ratings to indicate the energy-efficiency and safety, could be integrated in the driving system in order to increase the user acceptance and the joy of use.

The presented results of the user acceptance evaluation show that the adaptive feature of the driving system increased the usefulness, satisfaction and the ease of use of the driving system. Thus, the acceptance of the driving system was higher when the adaptive feature of the driving system was active. According to these findings, the hypothesis that was used in the evaluation of the user acceptance can be confirmed, as the adaptive feature of the driving system had a positive influence on the user acceptance.

¹Gamification is the usage of game mechanics in a non-gaming area to allow the increase of user's commitment to solve problem

In the first part of the evaluation 17 male and 3 female test drivers were used, who had an average age of 23.6 years. 21 male and 1 female with an average age of 26.55 years attended in the second part of the evaluation. Thus, the results of the energy-efficiency, safety and user acceptance evaluation cannot be transferred to all drivers, as the amount of test drivers were too less in each part of the evaluation and did not provide a representation of the average driver. Nevertheless, the result of the evaluation showed an improvement of the driving behaviour in terms of energy-efficiency and safety as well as an increased user acceptance when the adaptive feature of the driving system was used. Thus, it can be assumed, based on the validated hypotheses, that the research questions introduced in Chapter 1.2 can be positively answered.

Chapter 11

Conclusions

This thesis was focused on the problem of a growing energy consumption through vehicles and the high number of accidents with personal injury. One problem of the growing energy consumption is the resulted higher output of CO² gases that facilitates the global warming. Furthermore, the society and politics got aware of the finiteness of the oil, why saving energy became fundamental for them. Thus, several laws were enacted for example by the European Union to reduce the greenhouse gases and to save energy. Besides the growing energy consumption, the growing number of vehicles on the road leded also to more accidents and fatalities on the road. Most of the accidents with personal injury were caused by driver mistakes.

Car manufacturers reacted to these facts by improving the car itself, like the car body or engine, in terms of energy-efficiency and safety. However, besides the improvement of the car, there is also the possibility to decrease the fuel consumption and to increase the road safety by adapting the driving behaviour to the given driving situation. There are already several driving systems that try to improve the driving behaviour in terms of either energy-efficiency or safety. However, these driving systems covers either the aspects of energy-efficiency or safety and do not consider the individual driving behaviour or the driver condition.

In this thesis an adaptive and rule based driving system was developed that tries to improve the driving behaviour in terms of energy-efficiency and safety, while considering also the driver condition, like the driver stress level, and the individual driving behaviour. The detection of an inefficient and unsafe driving behaviour is done on the basis of energy-efficiency and safety relevant driving rules and by using an improved

rule matching algorithm that was developed in this thesis. Furthermore, the driving system is adapted to the individual driving behaviour as well as to the driver condition by using a decision tree. The decision tree was created on the basis of the definitions when a recommendation should be shown and how to detect a driver reaction to a shown recommendation. The adaptation to the driving behaviour and to the driver condition allows the driving system to show recommendations in dependence of the individual driving behaviour and the driver condition that can lead to an increase of the user acceptance. The driving system tries also to predict the future car state by using the autoregressive-moving average algorithm. This allows the driving system to show a recommendation before the driver is driving energy-inefficient or unsafe. Furthermore, the driving system shows a recommendation to the driver, besides the energy-efficiency and safety relevant recommendations, when the current driving behaviour differs from the typical driving behaviour in order to avoid the drivers to revert back to their old habits that caused the inefficient or unsafe driving behaviour. The detection of the deviation from the typical driving behaviour is done using the developed improved rule matching algorithm.

The developed driving system has been evaluated regarding the energy-efficiency and safety. Furthermore, it has been evaluated if the adaptive feature of the driving system increases the user acceptance of the driving system. The evaluation was done on a driving simulator using a city and a highway route. 20 test drivers were used to evaluate the energy-efficiency and safety, whereas 22 test drivers were used to evaluate the user acceptance of the driving system in the categories usefulness, ease of use and satisfaction.

The results of the evaluation showed that the energy-efficiency can be increased in average by 14.35 % and the safety in average by 7.31 % when using the introduced driving system. Furthermore, the user acceptance can be improved when the adaptive feature of the driving system was used, as the usefulness was increased by 7.34 %, the ease of use by 8.65 % and the satisfaction by 22.03 %. According to these results, it can be assumed that the driving system improves the driving behaviour in terms of energy-efficiency and safety. Furthermore, the results showed that the adaptive feature of the driving system increases user acceptance of the driving system and, thus, can lead to a steady usage of the driving system.

Chapter 12

Future work

The current developed prototype of the driving system considers only the driving rules "shift as soon as possible", "turn off the engine, when it is planned to idle longer than a minute", "don't exceed the speed limit" and "keep enough distance to the car in front". Thus, the future work of the driving system comprises the consideration of all energy-efficiency and safety relevant driving rules that were presented in Chapter 2. Furthermore, besides the driver stress level, further work concentrates also on the consideration of the distraction level of the driver and other driver conditions like fatigue and fitness to drive. Based on the consideration of all driving rules and driving conditions, like distraction or fatigue, it has to be investigated if the consideration all driving rules and driver conditions within the driving system cause a further improvement of the driving behaviour in terms of energy-efficiency and safety.

The current evaluation of the driving system was done using 42 test drivers that had an average age of 25.08 years and were mainly male. Thus, the results of the test drivers are only valid for that group. However, to show a significance of the presented findings and to validate the found tendency of an improved driving behaviour and an increased user acceptance, an evaluation with a bigger set of test drivers will be done. The test drivers for the future evaluation will be chosen to represent the average driver. Additionally, a long-term evaluation of the driving system will be done in order to investigate the long-term effects of the driving system on the driving behaviour. The results of the long-term evaluation can be correlated for example with the findings of Lotan and Toledo [17], who examined a return to the initial driving behaviour after five months of using a driving system.

Another part of the future work is the improvement of the graphical user interface as well as the communication of the driving system with the driver. The usability of the driving system in terms of user-friendliness and joy of use must be improved in order to increase the acceptance of the driving system and, thus, to increase the duration of using the driving system. Besides the improvement of the user-friendliness and joy of use, future work comprises also the creation of a human machine interface concept for the driving system that follows the recommendations for in-vehicle information systems of the European Commission [108]. During the creation of the concept, the improvement of presenting the recommendations must be considered, as some drivers felt bothered by the driving system as it presented all recommendations using an audio voice. Thus, the presentation of the recommendations must be improved in order to present the recommendations in a noticeable way, however, without distracting or bothering the driver.

Finally, the driving system has to be evaluated in a real environment in order to validate the evaluation results of this thesis. However, before starting the evaluation in a real environment, the driving system has to be prepared to be connected with a real vehicle. Thus, the interfaces of the driving system have to be adapted to the available serial-bus interface of the vehicle. Furthermore, also the vehicle has to be prepared by adding missing sensors to the vehicle, like an ECG or EEG, that measure for example the driver stress level or the driver distraction. On the basis of the preparations, the evaluation of the driving system can be done in a real environment using test drivers that represent the average driver.

Appendix A

Publications

The following listing shows the papers that were published until 2016 on the basis of the findings of this thesis.

- E. Yay, N. Martnez Madrid, J. A. Ortega Ramrez. Influence of stress in driving behaviour, MEDICON 2016, Paphos, Cyprus, 2016.
- E. Yay, N. Martnez Madrid, J. A. Ortega Ramrez. Detecting the adherence of driving rules in an energy-efficient, safe and adaptive driving system, Expert Systems with Applications, Volume 47, Pages 58-70, ISSN 0957-4174, 2016.
- E. Yay, N. Martnez Madrid, J. A. Ortega Ramrez. Using an improved rule match algorithm in an expert system to detect broken driving rules for an energy-efficiency and safety relevant driving system, Procedia Computer Science, Volume 35, Pages 127-136, ISSN 1877-0509, 2014.
- E. Yay, N. Martnez Madrid. An adaptive driving system regarding energy-efficiency and safety, AITA - Workshop on Ambient Intelligence for Telemedicine and Automotive domains, ISBN 978-84-697-0147-8, Seville, Spain, 2014.
- E. Yay, N. Martnez Madrid, J. Antonio Ortega Ramrez. Using an improved rule match algorithm for the detection of broken driving rules in an energy-efficient and safety relevant driving system, XVI Jornadas de ARCA, Qualitative Systems and their Applications in Diagnosis, Robotics and Ambient Intelligence, ISBN 978-84-606-6085-9, Cdiz, Spain, 2014.

- E. Yay and N. Martnez Madrid. Considering driver stress to increase the user acceptance while generating recommendations in an energy-efficiency and safety relevant driving system, Workshop on Mobile Networks for Biometric Data Analysis, ISBN 978-8-8875-4803-7, Ancona, Italy, 2014.
- E. Yay and N. Martnez Madrid. SEEDrive - An Adaptive and Rule Based Driving System, The 9th International Conference on Intelligent Environments - IE'13, ISBN 978-0-7695-5038-1, Athens, Greece, 2013.
- E. Yay and N. Martnez Madrid. SEEDrive - Using in-car serial-bus systems for safe and energy efficient driving, Proceedings of the Eleventh Workshop on Intelligent Solutions in Embedded Systems (WISES), ISBN 978-3-00-042899-9, Plzen, Czech Republic, 2013.
- E. Yay and N. Martnez Madrid. An educational driving system towards energy-efficient and safe driving behaviour, XV Jornadas de ARCA, Qualitative Systems and their Applications in Diagnosis, Robotics and Ambient Intelligence, ISBN 978-84-616-7622-4, Murcia, Spain, 2013.
- E. Yay and N. Martnez Madrid. A new driving system towards energy-efficient and safe driving behaviour, Proceedings of the Tenth Workshop on Intelligent Solutions in Embedded Systems (WISES), ISBN 978-1-4673-2464-9, Klagenfurt, Austria, 2012.

References

- [1] European Commission - Eurostat. Supply, transformation, consumption - all products - annual data [nrg_100a], 2014.
Available at http://appsso.eurostat.ec.europa.eu/nui/show.do?dataset=nrg_100a
Last visit 04.08.2014.
- [2] Bernd Wessellink, Robert Harmsen, and Winfried Eichhammer. *Energy Savings 2020*. EcoFys and Fraunhofer Institut, 2010.
- [3] European Commission - Eurostat. Consumption of Energy, 2014.
Available at http://epp.eurostat.ec.europa.eu/statistics_explained/index.php/Consumption_of_energy
Last visit 03.08.2014.
- [4] Siddharth K. Patil. Regenerative Braking System in Automobiles. *International Journal of Research in Mechanical Engineering and Technology*, 2:45–46, 2012.
- [5] David Burton, Amanda Delaney, Stuart Newstead, David Logan, and Brian Fildes. Evaluation of Anti-lock Braking Systems Effectiveness, 2004.
- [6] German Statistical Office. Verkehr - Verkehrsunfälle 2013, 2014.
- [7] Hoong-Chor Chin and Ser-Tong Quek. Measurement of Traffic Conflicts. *Safety Science*, 26(3):169–185, 1997.
- [8] Fan Xiaoqiu, Ji Jinzhang, and Zhang Guoqiang. Impact of Driving Behavior on the traffic safety of Highway Intersection. *Third International Conference on Measuring Technology and Mechatronics*, pages 370–373, 2011.
- [9] Narelle Haworth and Mark Symmons. Driving to reduce fuel consumption and improve road safety. *Proceedings Road Safety Research, Policing and Education Conference*, 2001.

- [10] Hinrich Helms, Udo Lambrecht, and Jan Hanusch. Energieeffizienz im Verkehr. *Energieeffizienz*, pages 309–329, 2010.
- [11] Joeri Van Mierlo, Gaston Maggetto, Erik van de Burgwal, and Raymond Gense. Driving style and traffic measures - influence on vehicle emissions and fuel consumption. *Proceedings / Institution of Mechanical Engineers*, 218, Part D: J. Automobile Engineering:43–50, 2004.
- [12] Adolph-Eugen Bongard. The environment and the driving instructor, 2007. Available at <http://www.drivers.com/article/413/>
Last visit 05.08.2014.
- [13] Christoper Spencer. Ford Tests Show ECO-Driving Can Improve Fuel Economy by an Average of 24 Percent, 2008. Available at <http://www.at.ford.com/news/cn/ArticleArchives/27527.aspx>
Last visit 05.08.2014.
- [14] Jack N. Barkenbus. Eco-driving: An overlooked climate change initiative. *Energy Policy*, 38(2):762–769, 2009.
- [15] Fiat. Eco-driving uncovered: The benefits and challenges of eco-driving, based on the first study using real journey data, 2010.
- [16] Hyun Jin Cho. Eco driving system, 2008. Available at <http://kia-buzz.com/eco-driving-system/>
Last visit 05.08.2014.
- [17] Tsippy Lotan and Tomer Toledo. An In-Vehicle Data Recorder for Evaluation of Driving Behavior and Safety. *Transportation Research Board of the National Academies*, 2006.
- [18] Karel A. Brookhuis and Dick de Waard. Monitoring drivers mental workload in driving simulators using physiological measures. *Accident Analysis and Prevention*, 42(3):898–903, 2009.
- [19] Murray G. Patterson. What is energy efficiency: Concepts, indicators and methodological issues. *Energy Efficiency*, 24(5):377–390, 1996.
- [20] Kazunori Kojima and Lisa Ryan. Transport Energy Efficiency - implementation of IEA recommendations since 2009 and next steps. *Energy Efficiency Series*, 2010.

- [21] William W. Lowrance. *Of Acceptable Risk: Science and the Determination of Safety*. Kaufmann, William, Incorporated, Los Altos, Calif., 1976.
- [22] International Transportation Forum. TOWARDS ZERO - Ambitious Road Safety Targets and the Safe System Approach, 2008.
- [23] Nick Sanders and Esko Keskinen. EU NovEV PROJECT - Evaluation of post-licence training schemes for novice drivers FINAL REPORT, 2014.
- [24] Ecodrive.org. ECODRIVEN Campaign Catalogue for European Ecodriving & Traffic Safety Changes, 2006.
- [25] Peter Wilbers and Henk Wardenaar. The Dutch national ecodriving programme Het Nieuwe Rijden: A success story. *Proceedings of ECEEE 2007 SUMMER STUDY - SAVING ENERGY - JUST DO IT!*, pages 1673–1678, 2007.
- [26] Robert van den Hoed, Mirjam Harmelink, and Suzanne Joosen. Evaluation of the dutch ecodrive programme, 2006.
- [27] International Transportation Forum. Speed Management, 2006.
- [28] UNECE - United Nations Economic Commission for Europe. Aggressive driving behaviour (background paper), 2004.
Available at <http://www.unece.org/trans/roadsafe/rs4aggr.html>
Last visit 30.09.2014.
- [29] Organisation for Economic Co-Operation and Development (OECD) and European Conference of Ministers of Transport (ECMT). Speed management, 2006.
- [30] C. N. Kloeden, G. Ponte, and A. J. McLean. Travelling Speed and the Risk of Crash Involvement on Rural Roads. *Department of Transport and Regional Services - Australian Transport Safety Bureau*, 2001.
- [31] M. C. Tayler, D. A. Lynam, and A. Baruya. The effects of drivers' speed on the frequency of road accidents. *Transport Research Laboratory (TRL)*, 2000.
- [32] Simone Bosetti, Caterina Corrias, Rosario Scatamacchia, Alessio Sitran, and Eef Delhaye. FINAL misc - VOLUME 1 - EX-POST EVALUATION OF THE RSAP, 2009.

- [33] Suzanne P. McEnvoy, Mark R. Stevenson, Anne T. McCartt, Mark Woodward, Claire Haworth, Peter Palamara, and Rina Cercarelli. Role of mobile phones in motor vehicle crashes resulting in hospital attendance: a case-crossover study. *BMJ*, 331(7514):428, 2005.
- [34] Fernando A. Wilson and Jim P. Stimpson. Trends in Fatalities From Distracted Driving in the United States, 1999 to 2008. *American Journal of Public Health*, 100(11):2213–2219, 2010.
- [35] Timmo Janitzek, Andreas Brenck, Samatha Jamson, Oliver Carsten, and Vojtech Eksler. Study on the regulatory situation in the member states regarding brought-in (i.e. nomadic) devices and their use in vehicles. *SMART 2009/0065*, 2010.
- [36] Fridulv Sagberg. Road accidents caused by drivers falling asleep. *Accident Analysis and Prevention*, 31:639–649, 1999.
- [37] New Zealand Transport Agency and Accident Compensation Corporation (ACC). Your safe driving policy - Helping you to manage work-related road safety and keep your employees and vehicles safe on the roads, 2007.
- [38] Conference of European Directors of Rads TG Road Safety. Safe distance between vehicles, 2010.
- [39] Timmo Janitzek, Andreas Brenck, Samatha Jamson, Oliver Carsten, and Vojtech Eksler. Study on the regulatory situation in the member states regarding brought-in (i.e. nomadic) devices and their use in vehicles, 2010.
- [40] Tobias Bär, Ralf Kohlhaas, J. Marius Zllner, and Kay-Ulrich Scholl. Anticipatory driving assistance for energy efficient driving. *Integrated and Sustainable Transportation Systems*, 2011.
- [41] Victor Corcoba Magana and Mario Munoz Organero. Artemisa, Using an Android device as an Eco-Driving assistant. *Cyber Journals: Multidisciplinary Journals in Science and Technology, Journal of Selected Areas in Mechatronics (JMTC)*, 2011.
- [42] NISSAN. World first eco pedal helps reduce fuel consumption, 2008. Available at http://www.nissan-global.com/EN/NEWS/2008/_STORY/080804-02-e.html
Last visit 06.11.2014.

- [43] Reiner Onken. DAISY, an Adaptive, Knowledge-based Driver Monitoring and Warning System. *Proceedings of Intelligent Vehicles '94 Symposium*, pages 544–549, 1994.
- [44] R. Risack, N. Mohler, and W. Enkelmann. A Video-based Lane Keeping Assistant. *Proceedings of IEEE Intelligent Vehicles Symposium*, pages 356–361, 2000.
- [45] Vicente Milanés, Joshué Pérez, Jorge Godoy, and Enrique Onieva. A fuzzy aid rear-end collision warning/avoidance system. *Expert Systems with Applications*, 39(10):9097–9107, 2012.
- [46] Hardeep Singh, J.S. Bhatia, and Jasbir Kaur. Eye tracking based driver fatigue monitoring and warning system. *2010 India International Conference on Power Electronics (IICPE)*, pages 1–6, 2011.
- [47] Arun Sahayadhas, Kenneth Sundaraj, and Murugappan Murugappan. Eye tracking based driver fatigue monitoring and warning system. *Sensors*, 12(12):1–6, 2012.
- [48] Patrick Stahl, Birsén Donmez, and Greag Jamieson. Anticipation in Driving: The Role of Experience in the Efficacy of Pre-event Conflict Cues. *IEEE Transactions on Human-Machine Systems*, 44(5):1673–1678, 2014.
- [49] R. Ghandour, A. Victorino, M. Doumiati, and A. Charara. Tire/road friction coefficient estimation applied to road safety. *18th Mediterranean Conference on Control Automation (MED)*, pages 1485–1490, 2010.
- [50] Rune Elvik, Alena Høy, Truls Vaa, and Michael Sørensen. *The Handbook of Road Safety Measures - Second Edition*. Emerald Group Publishing Limited, 2009.
- [51] Harry Zhang and Matthew Smith. SAFETY VEHICLES using adaptive Interface Technology - A Literature Review of Visual Distraction Research, 2004.
- [52] European Commission - Mobility and Transport. Fitness to drive, 2014. Available at http://ec.europa.eu/transport/road_safety/topics/behaviour/fitness_to_drive/index_en.htm
Last visit 10.02.2015.

- [53] Michael Bohlander. Translation of the german criminal code, 2013.
Available at http://www.gesetze-im-internet.de/englisch_stgb/german_criminal_code.pdf
Last visit 02.02.2015.
- [54] John K. Pollard, Eric D. Nadler, and Mary D. Stearns. Review of Technology to Prevent Alcohol-Impaired Crashes, 2007.
- [55] Eugen Mayer. Serial bus systems in the automobile - Part 1: Motivation, advantages, tasks and architecture of serial bus systems in the automobile. *Elektronik Automotive*, 7:70–73, 2006.
- [56] BMW Technology Guide. Flex ray, 2011.
Available at http://www.bmw.com/com/en/insights/technology/technology_guide/articles/flex_ray.html
Last visit 12.02.2015.
- [57] Konrad Reif. *Bosch Autoelektrik und Autoelektronik - Bordnetze, Sensoren und elektronie Systeme*. Vieweg+Teubner Verlag / Springer Fachmedien Wiesbaden GmbH, Wiesbaden, 2011.
- [58] Ramzi Abou-Jaoude. ACC Radar Sensor Technology, Test Requirements, and Test Solutions. *IEEE Transactions on Intelligent Transportation Systems*, 40(3):115–122, 2003.
- [59] Eugen Mayer. Serielle Bussysteme - Teil 1: Architektur, Aufgaben und Vorteile. *Elektronik Automotive*, 7:70–73, 2006.
- [60] ITS International. Pioneering sensors collect weather data from moving vehicles, 2011.
Available at <http://www.itsinternational.com/sections/nafta/features/pioneering-sensors-collect-weather-data-from-moving-vehicles/>
Last visit 22.02.2015.
- [61] Keiji Fujimura and Takashi Sakamoto. Road Surface Sensor. *Fujitsu technical journal*, 1:64–72, 1988.
- [62] Christopher Paul Urmson, Michael Steven Montemerlo, and Jiajun Zhu. Detecting road weather conditions, 2014. US Patent App. 13/623,397.

-
- [63] BMW Technology Guide. Speed Limit Info, 2012.
Available at http://www.bmw.com/com/en/insights/technology/technology_guide/articles/speed_limit_info.html
Last visit 13.02.2015.
- [64] Eugen Mayer. Serielle Bussysteme - Teil 1: Architektur, Aufgaben und Vorteile. *Elektronik Automotive*, 7:70–73, 2006.
- [65] Mohit Kumar, Matthias Weippert, Reinhard Vilbrandt, Steffi Kreuzfeld, and Regina Stoll. Fuzzy Evaluation of Heart Rate Signals for Mental Stress Assessment. *IEEE Transactions on Fuzzy Systems*, 15(5):791 – 808, 2007.
- [66] Lizawati Salahuddin and Desok Kim. Detection of Acute Stress by Heart Rate Variability Using a Prototype Mobile ECG Sensor. *Proceedings of the 2006 International Conference on Hybrid Information Technology*, 2:453–459, 2006.
- [67] Jennifer Healey and Rosalind Picard. Detecting Stress During Real-World Driving Tasks Using Physiological Sensors. *IEEE Transaction on Intelligent Transportation Systems*, 6(2):156–166, 2005.
- [68] Sang-Joong Jung, Heung-Sub Shin, and Wan-Young Chung. Driver fatigue and drowsiness monitoring system with embedded electrocardiogram sensor on steering wheel. *IET Intelligent Transport Systems*, 8(11):43–50, 2014.
- [69] G. Calcagnini, G. Biancalana, F. Giubilei, S. Strano, and S. Cerutti. Spectral analysis of heart rate variability signal during sleep stages. *Engineering in Medicine and Biology Society, 1994. Engineering Advances: New Opportunities for Biomedical Engineers. Proceedings of the 16th Annual International Conference of the IEEE*, 4:1252–1253, 1994.
- [70] ITS International. ATTENTION ASSIST: Drowsiness-detection system warns drivers to prevent them falling asleep momentarily, 2008.
Available at <http://media.daimler.com/dcmedia/0-921-658892-1-1147698-1-0-1-999999-0-1-0-854934-0-1-0-0-0-0-0.html>
Last visit 16.02.2015.
- [71] American Beverage Institute. Alcohol Detection Technologies: Present and Future, 2009.

REFERENCES

- [72] Robert Swift. Direct measurement of alcohol and its metabolites. *Addiction*, 98(2):73–80, 2003.
- [73] Susan A. Ferguson, Abdullatif Zaouk, Neeraj Dalal ad Clair Strohl, Eric Traube, and Robert Strassburger. Alcohol Detection Technologies: Present and Future. *Proceedings of the 22rd International Technical Conference on the Enhanced Safety of Vehicles*, pages 1–14, 2013.
- [74] T.D. Ridder, S.P. Hendee, and C.D. Brown. Noninvasive Alcohol Testing Using Diffuse Reflectance Near-Infrared Spectroscopy. *Applied Spectroscopy*, 59(2):181–189, 2005.
- [75] TruTouch. Product information, 2014.
Available at <http://tttinc.com/product/>
Last visit 18.02.2015.
- [76] USAToday. Toyota creating alcohol detection system, 2007.
Available at http://usatoday30.usatoday.com/tech/news/techinnovations/2007-01-03-toyota-drunken-driving_x.htm
Last visit 17.02.2015.
- [77] Nissan. Drunk-driving prevention concept car, 2007.
Available at <http://www.nissan-global.com/EN/TECHNOLOGY/OVERVIEW/dpcc.html>
Last visit 17.02.2015.
- [78] Volvo. Volvo cars launches new alcoguard to help reduce the number of alcohol-related road accidents, 2007.
Available at <https://www.media.volvocars.com/global/en-gb/media/pressreleases/12151>
Last visit 18.02.2015.
- [79] T. Victor. A technical platform for driver inattention research, *Volvo technical misc for project NUTEK Dnr 1P21-99-4131*, 2000.
- [80] John Lee, Michelle Reyes, and Daniel McGehee. SAFETY VEHICLES using adaptive Interface Technology (Task 5) - A Literature Review of Cognitive Distraction, 2004.

- [81] Lotfi A. Zadeh. The Role Of Fuzzy Logic In The Management Of Uncertainty In Expert Systems. *Fuzzy Sets and Systems*, 11:199–227, 1983.
- [82] Hans-Jürgen Zimmermann. *Fuzzy Set Theory - and Its Applications, Fourth Edition*. Springer Science+Business Media New York, 2001.
- [83] William Siler and James J. Buckley. *Fuzzy Expert Systems And Fuzzy Reasoning*. Wiley Interscience, 2005.
- [84] Haykin. *Neural Networks: A Comprehensive Foundation*. Prentice Hall, 1994.
- [85] Detlef Nauck, Rudolf Kruse, and Frank Klawonn. Neuronale Fuzzy Systeme. *Spektrum der Wissenschaften, Dossier: Kopf oder Computer*, 4, 1997.
- [86] Lotfi A. Zadeh. Fuzzy Sets. *Information and Control*, 8:338–353, 1965.
- [87] Everette S. Gardner Jr. Exponential smoothing: The state of the art-part {II}. *International Journal of Forecasting*, 22(4):637–666, 2006.
- [88] Chris Chatfield, Anne B. Koehler, J. Keith Ord, and Ralph D. Snyder. A new look at models for exponential smoothing. *The Statistician*, 50(2):147–159, 2001.
- [89] Greg Welch and Gary Bishop. An Introduction to the Kalman Filter. *SIGGRAPH 2001 course 8*, 2001.
- [90] Alex Pentland and Andrew Liu. Modelin and PredictThe Statisticianion of Human Behaviour. *Neural Computation*, 11(1):229–242, 1999.
- [91] Alexandre Costa, Antonio Crespo, Jorge Navarro, Gil Lizcano, Henrik Madsen, and Everaldo Feitosa. A review on the young history of the wind power short-term prediction. *Renewable and Sustainable Energy Reviews*, 12(6):1725–1744, 2008.
- [92] Peter J. Brockwell and Richard A. Davis. *Introduction to Time Series and Forecasting, Second Edition*. Springer, 2002.
- [93] W. J. Dixon. *BMDP Statistical Software Manual Volume 1*. University of California Press, 1992.

- [94] Juan M. Lujano-Rojas, José L. Bernal-Augustín, Rodolfo Dufo-López, and José A. Domínguez-Navarro. Forecast of Hourly Average Wind Speed Using ARMA Model with Discrete Probability Transformation. *Electrical Engineering and Control*, 98(1):1003–1010, 2011.
- [95] Shuona Xu and Biqing Zeng. Network Traffic Prediction Model Based on Auto-regressive Moving Average. *Journal of Networks*, 9(3):653–659, 2014.
- [96] Charles L. Forgy. Rete: A fast algorithm for the many pattern/many object pattern match problem. *Artificial Intelligence*, 19(1):17–37, 1982.
- [97] Daniel P. Miranker. Treat: A better match algorithm for ai production systems. *AAAI-87 Proceedings*, 1(1):42–47, 1987.
- [98] Pandurang Nayak, Anoop Gupta, and Paul Rosenbloom. Comparison of the rete and treat production matchers for soar (a summary). *The Soar papers*, 1(1):621–626, 1993.
- [99] Daniel P. Miranker. On the performance of lazy matching in production systems. *AAAI-90 Proceedings*, 1(1):68–692, 1990.
- [100] Tom M. Mitchell. *Machine Learning*. McGraw-Hill Inc., 1997.
- [101] Gunnar Johansson and Kare Rumar. Drivers' Brake Reaction Times. *Human Factors*, 13:23–27, 1971.
- [102] Gunnar Johansson and Kare Rumar. Drivers' Brake Reaction Times. *Proceedings of the Human Factors and Ergonomics Society 54th Annual Meeting*, 1:2076–2080, 2000.
- [103] Heikki Summala. Driver/Vehicle Steering Responses Latencies. *Human Factors: The Journal of the Human Factors and Ergonomics Society*, 26(6):683–692, 1981.
- [104] Arthur C. Graesser, Nicholas L. Hoffman, and Leslie F. Clark. Structural Components of Reading Time. *Journal of Verbal Learning and Verbal Behavior*, 19:135–151, 1980.
- [105] Arthur Gill. *Introduction to Theory of Finite-state Machines*. McGraw-Hill Inc., 1962.

- [106] Jonathan Lazar, Jinjuan Feng, and Harry Hochheiser. *Research Methods in Human-Computer Interaction*. Wiley, 2011.
- [107] Arnold M. Lund. Measuring Usability with the USE Questionnaire. *Usability and User Experience*, 8(2), 2001.
Available at http://web.archive.org/web/20141206144115/http://www.stcsig.org/usability/newsletter/0110_measuring_with_use.html
Last visit 13.06.2015.
- [108] European Commission. COMMISSION RECOMMENDATION on safe and efficient in-vehicle information and communication systems: update of the European Statement of Principles on human machine interface. *Official Journal of the European Union*, 50, 2007.