

Aleš Jančář^a & Zdeněk Kopecký^a

František Cvachovec^c, Jan Dressler^a, Martin Veškrna^{a,b}, Lukáš Džbánek^a

^aVF, a.s. company & ^bMasaryk University, Faculty of Informatics, ^cUniversity of Defence

Abstract

The poster includes experimental measurements with ^3He and the latest scintillation materials EJ-299-33 in fields of neutron and photon radiation using modern electronics which we designed. Electronic part of the measuring system is built on recently developed AD converter with very high sampling frequency (1 GHz). In the theoretical part, the Monte Carlo simulations of response characteristics of the measured scintillation materials are presented.

Fast Digitizer Card

The fast digitizer is based on AD converters, type ADC12D1000 by Texas Instruments, and connected to the Combo card via XGMII (10 Gigabit Media Independent Interface). The converters operate with a resolution of 12 bits and have two differential inputs with a sampling frequency 1 GHz. The output interface consists of 4 sets of 12-bit outputs. For transferring data between AD converters and PC memory the transmission protocol has been designed. Information about the measurement, and lost data, is contained within the protocol. XGMII interface between the ADC card and Combo card uses a standard Ethernet protocol.

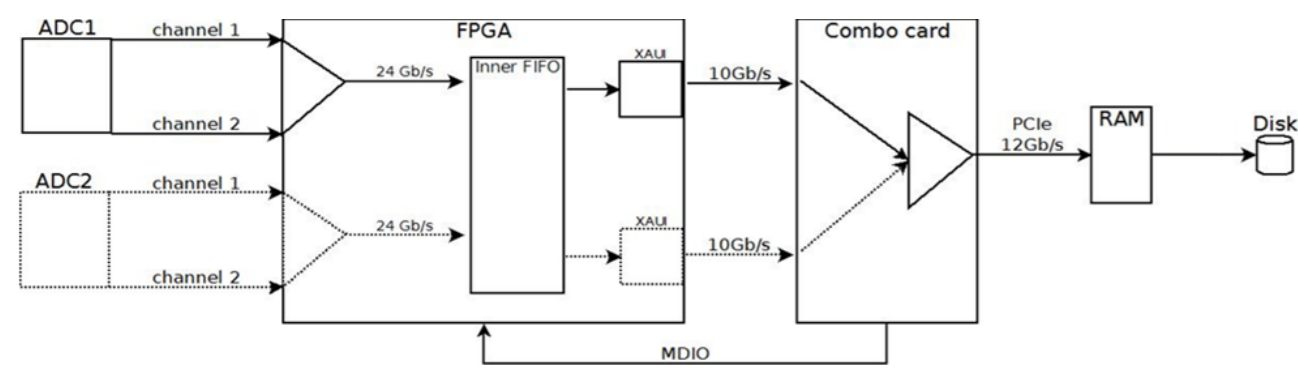

Figure 1: Schematic representation of the data transfer.

Data transfer is limited by the transmission capacity of the lines and buffer sizes. The internal FIFO memory of the FPGA has a size of 1536 kilobytes. In interlaced mode of AD converter and sampling frequency 2 GHz a FIFO card is able to store approximately 62 μs . This value is a maximum pulse length which ensures that data will not be lost.

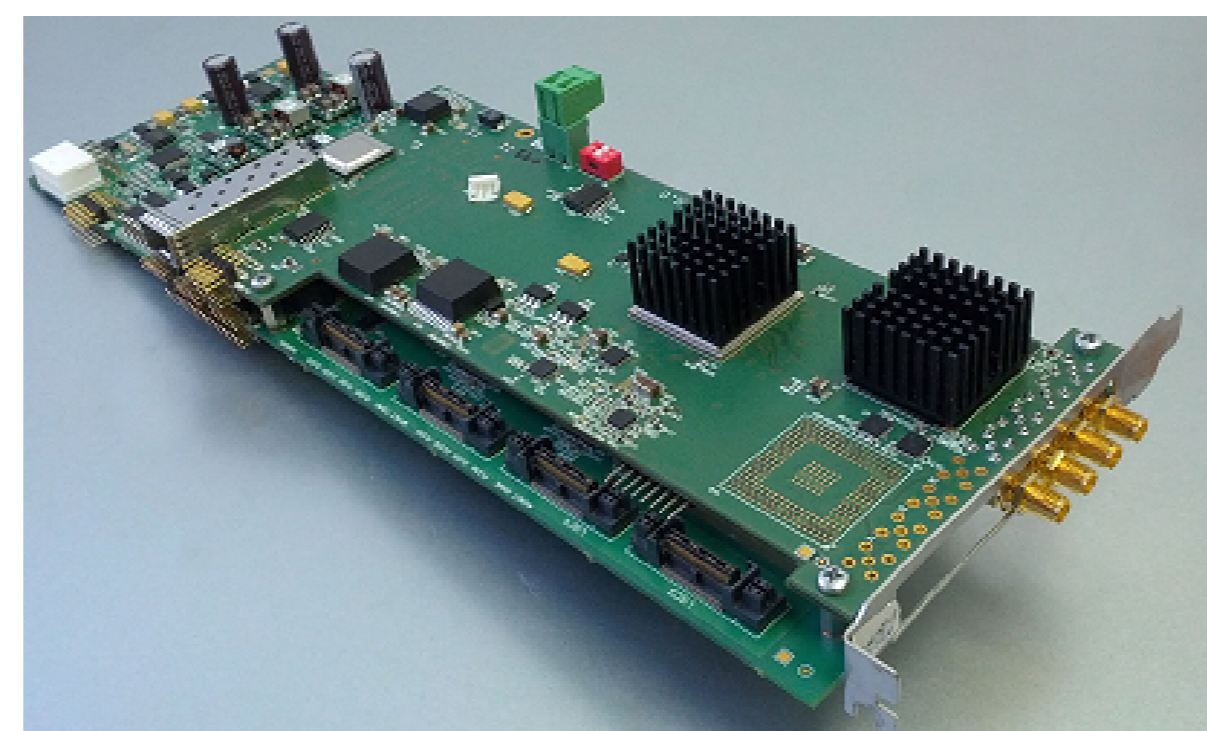

Figure 2: The fast digitizer. The fast digitizer consists of two cards, an ADC card with converters (in the front), and a Combo card (in the back).

Measurement with ^3He Proportional Detector

^3He proportional counters are widely used as neutron detectors. It's known (see, for example, [1]) that ^3He counters are capable of detecting other types of particles like photons, betas, and alphas, and that it is possible to distinguish them according to the pulse shape. We used the fast digitizer (described above) in the oscilloscope mode to verify that the typical gamma pulse has considerably smaller amplitude and longer risetime ($\sim 2 \mu\text{s}$) in comparison with the typical thermal neutron pulse ($\sim 0.5 \mu\text{s}$). The experimental arrangement with ^{137}Cs gamma source and PuBe neutron source is shown in the Fig. 4, the preamplifier, the fast digitizer and the measuring server is in the Fig. 3. Resulting pulse height spectrum is in the Fig. 5.



Figure 4: Arrangement of the detector (in the middle), ^{137}Cs source (on the left) and PuBe source (on the right).

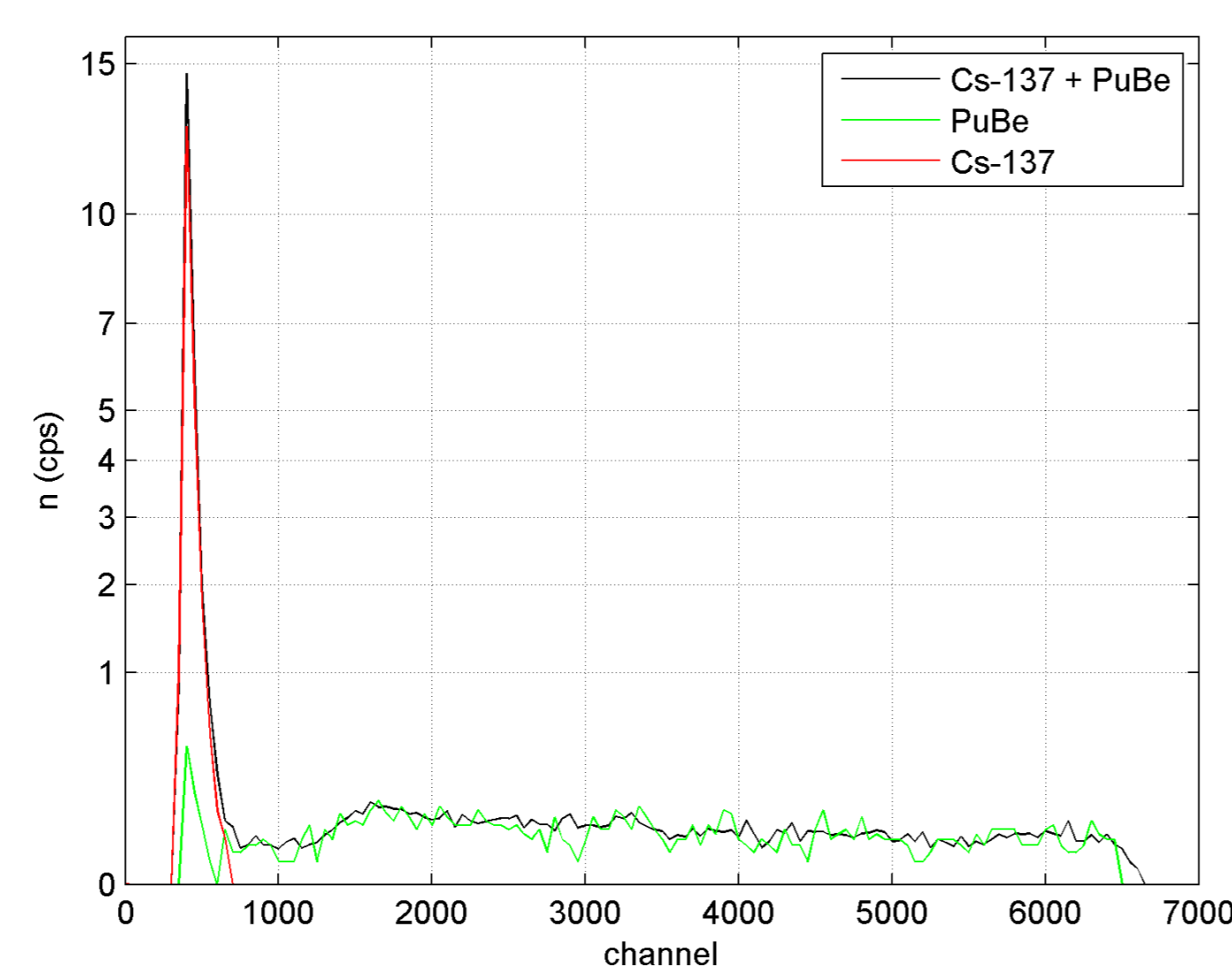

Figure 5: Pulse height spectrum from ^3He proportional detector with the 10'' Bonner sphere using ^{137}Cs source (green line), PuBe source (red line) and both sources (black line).

Digital Neutron-Gamma Discrimination with Liquid and Plastic Scintillators

Liquid scintillating detectors are widely used to achieve neutron - gamma discrimination due to their excellent Pulse Shape Discrimination (PSD) properties. Recently, a new class of plastic scintillating materials with PSD properties has been developed. The availability of these new detection materials in commercial form is very recent. Eljen Technologies has manufactured a number of experimental

plastic scintillator materials classed as EJ-299. The PSD properties of the new plastic scintillator EJ-299-33 and an NE-213 type scintillator has been compared by the measurement of neutron-gamma radiation emitted by a ^{252}Cf source.

EJ-299-33 detector: Cylindrical detection part: 7.62 cm (thickness) x 7.62 cm (diameter), photomultiplier: HAMAMATSU R6233-01.

NE-213 (BC 501A) detector: Cylindrical detection part: 5.08 cm (thickness) x 12.7 cm (diameter), photomultiplier: HAMAMATSU R1250. A PSD parameter is calculated to separate off neutron and photon events. The parameter is given by the ratio

$$PSD = \frac{\int_{T_{\text{tail}}}^{T_{\text{end}}} \text{pulse}(t) dt}{\int_0^{T_{\text{end}}} \text{pulse}(t) dt} \quad (1)$$

where T_{tail} is an optimized beginning of the tail part of the pulse and T_{end} is an optimized end point of the pulse.

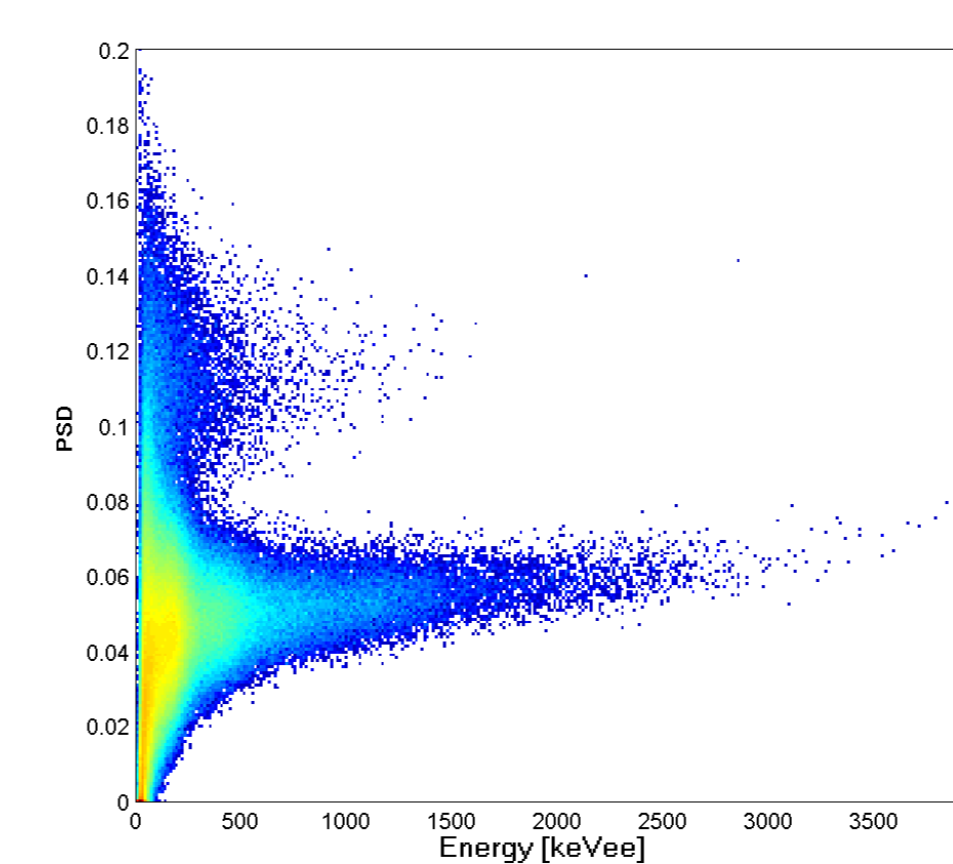

Figure 6: 2D plot Energy versus PSD (EJ-299-33)

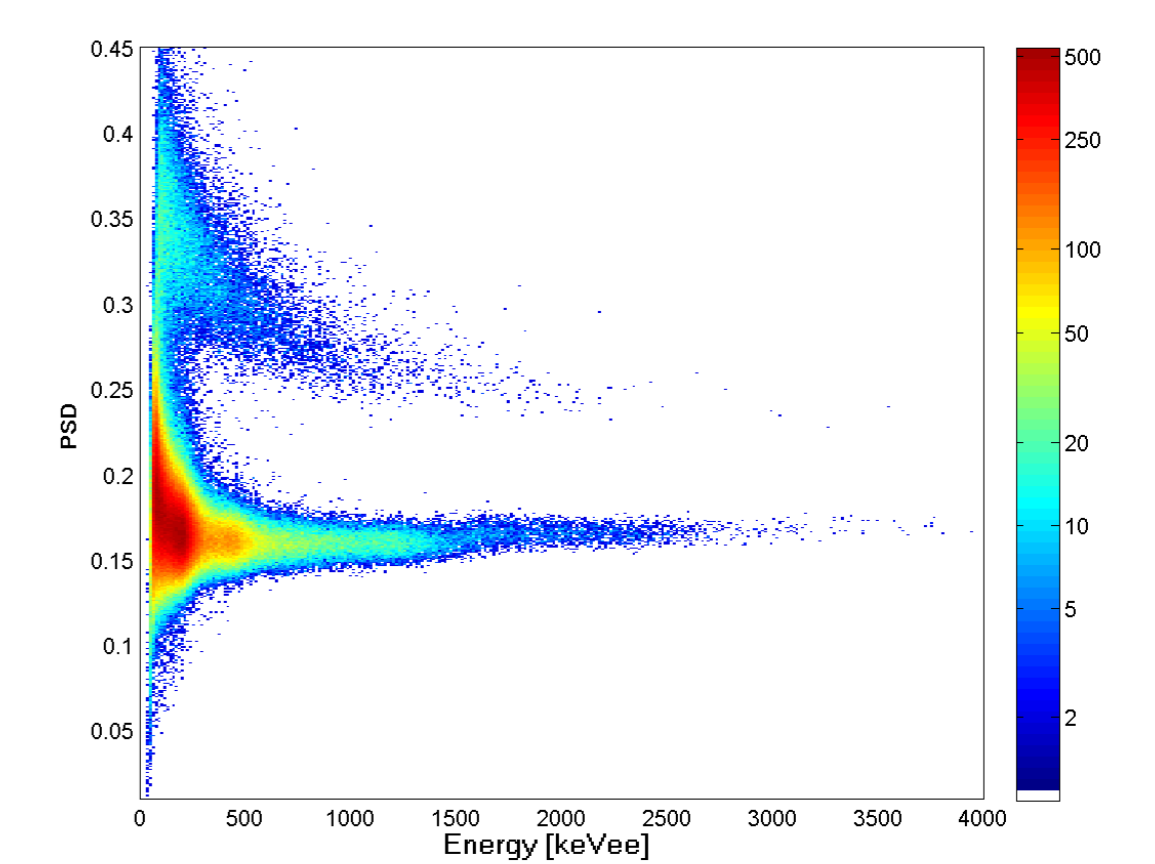

Figure 7: 2D plot Energy versus PSD (NE-213)

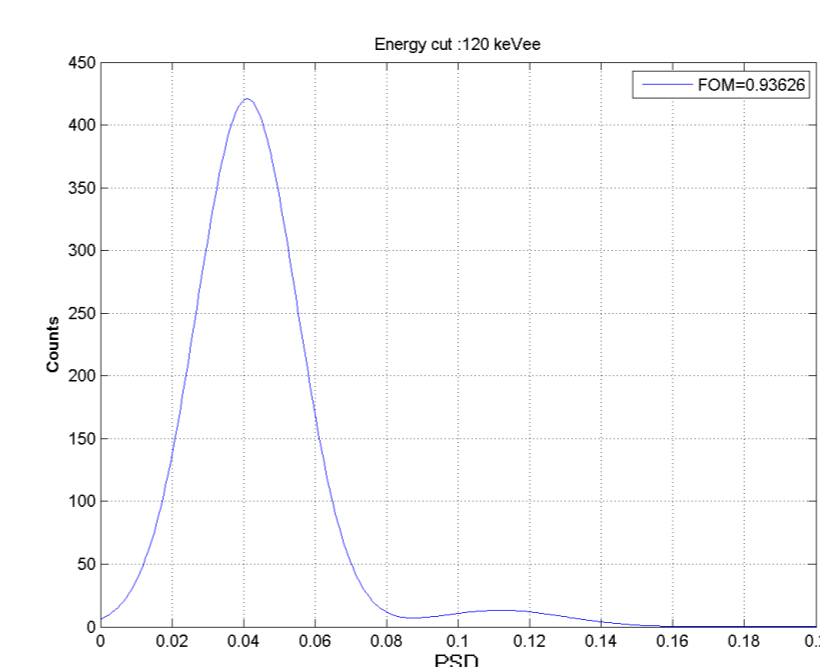

Figure 8: Figure of Merit (FOM) plot: 120 keVee Energy Cut (EJ-299-33)

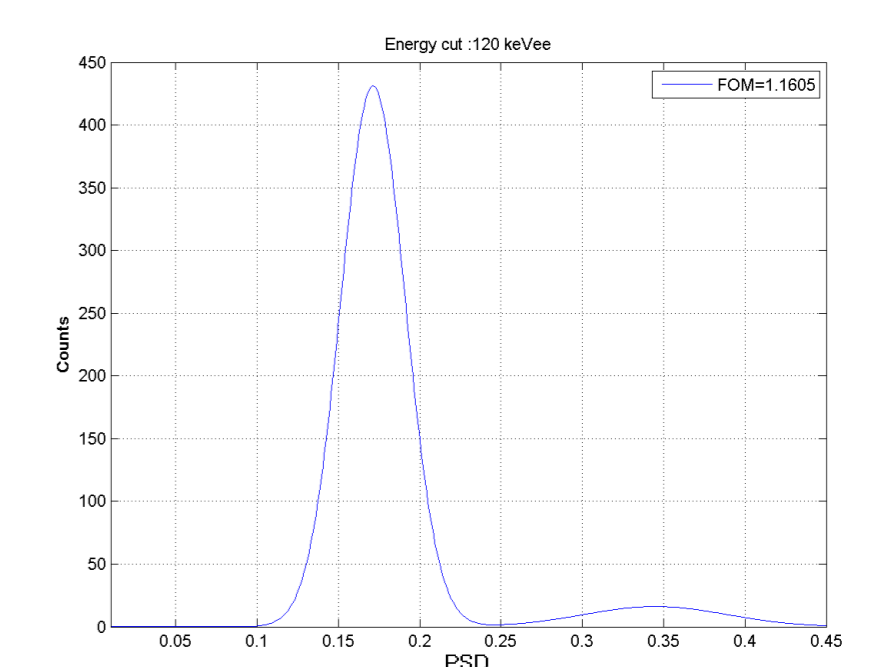

Figure 9: Figure of Merit (FOM) plot: 120 keVee Energy Cut (NE-213)

Monte Carlo Simulation of Response Matrix

Monte Carlo simulations of the response matrices were performed using MCNPX 2.7.0 + MCUNED. A new interface for tracking particle events in the MPI mode has been developed.

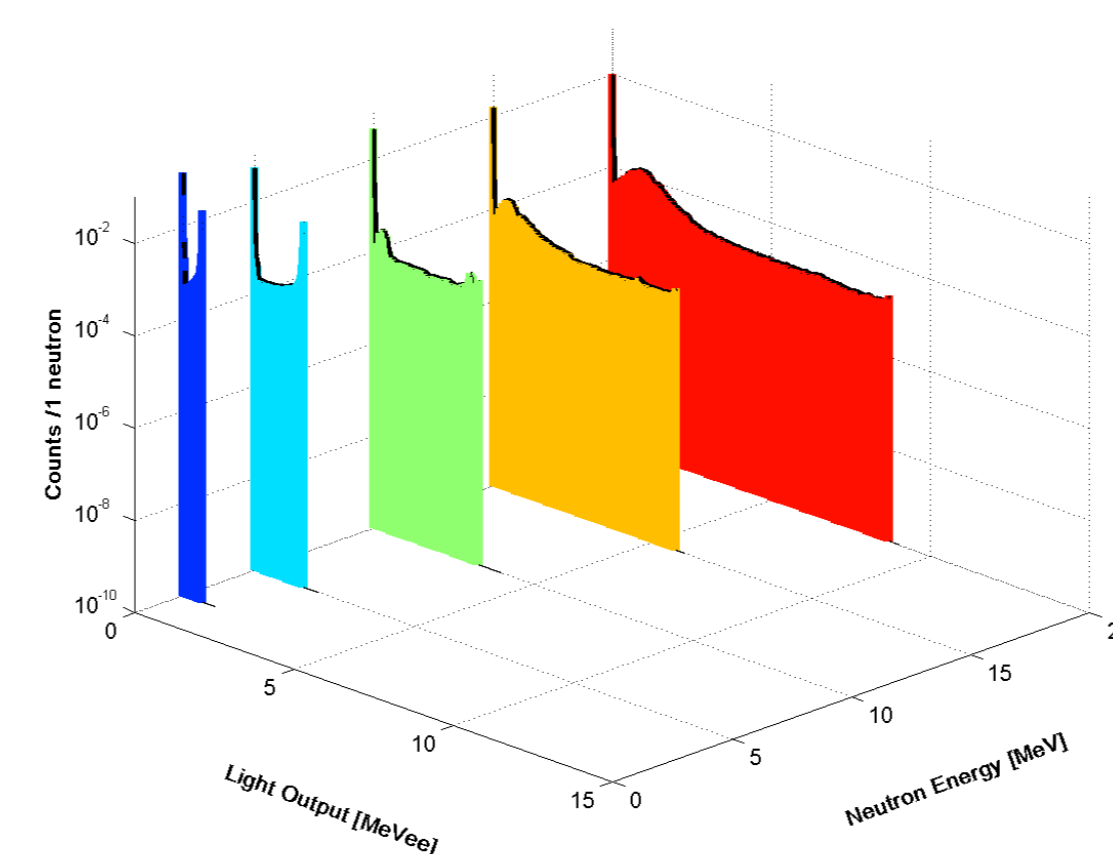

Figure 10: Detector Response Matrix Simulation (EJ-299-33)

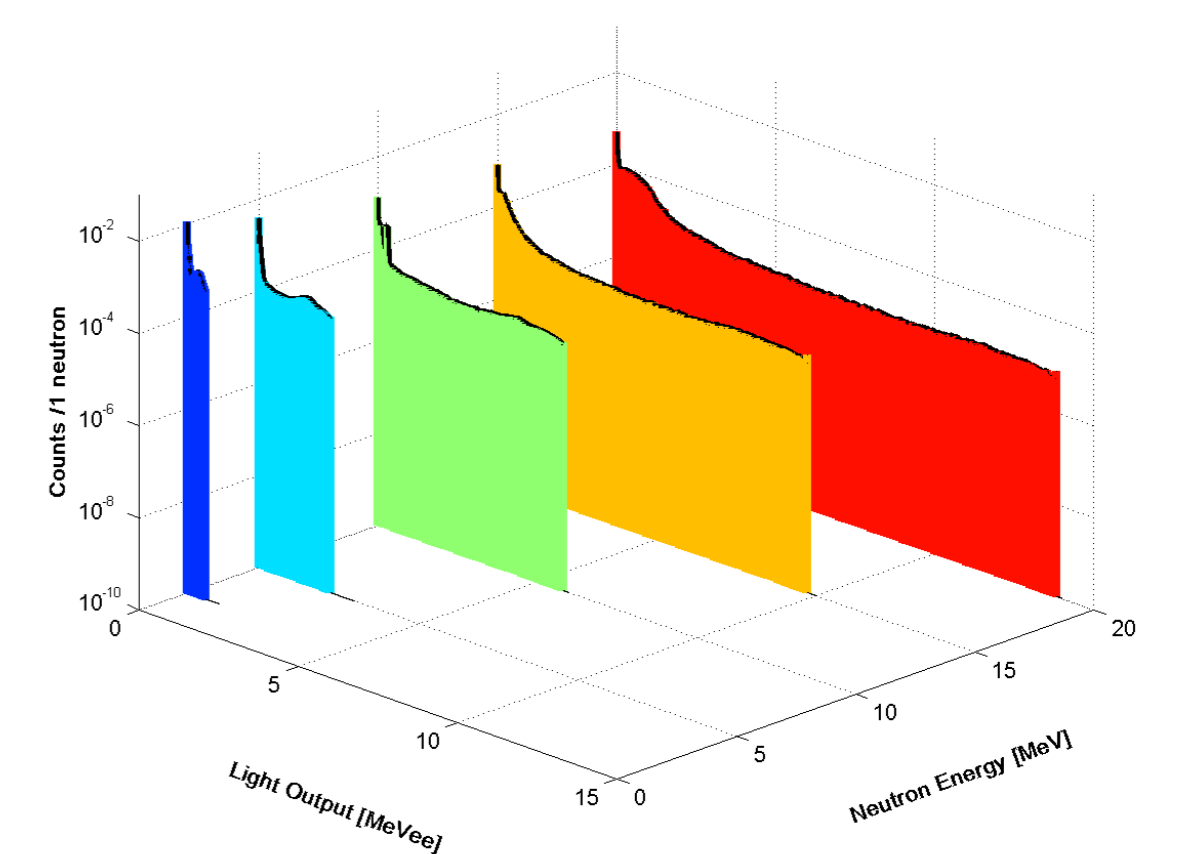

Figure 11: Detector Response Matrix Simulation (NE-213)

Acknowledgment

The presented work has been supported by the Technology Agency of the Czech Republic within the project SPECTRUM, No. TA01011383.

References

- [1] T. J. Langford, C. D. Bass, E. J. Beise, H. Breuer, D. K. Erwin, C. R. Heimbach, J. S. Nico: Event Identification in ^3He Proportional Counters Using Risetime Discrimination, *Nuclear Instruments and Methods*, Volume 717, 21 July 2013, Pages 51–57
- [2] Benjamin Klopper, Natalie Cranston, Markus Alekxy, Marcel Dix: Developing portable FPGA applications, *Industrial Informatics (INDIN)*, *IEEE International Conference*, 29-31 July 2013