



VCU

Virginia Commonwealth University
VCU Scholars Compass

Theses and Dissertations

Graduate School

2011

Cyclic-di-GMP Signaling in the *Borrelia Spirochetes*

John Freedman
Virginia Commonwealth University

Follow this and additional works at: <https://scholarscompass.vcu.edu/etd>



Part of the [Medicine and Health Sciences Commons](#)

© The Author

Downloaded from

<https://scholarscompass.vcu.edu/etd/269>

This Dissertation is brought to you for free and open access by the Graduate School at VCU Scholars Compass. It has been accepted for inclusion in Theses and Dissertations by an authorized administrator of VCU Scholars Compass. For more information, please contact libcompass@vcu.edu.

John Courtland Freedman 2011

All Rights Reserved

CYCLIC-DI-GMP SIGNALING IN THE *BORRELIA* SPIROCHETES

A dissertation submitted in partial fulfillment of the requirements for the degree of
Doctor of Philosophy at Virginia Commonwealth University

by

John Courtland Freedman

Bachelor of Science, Virginia Polytechnic Institute and State University, May
2005

Director: Richard T. Marconi, Ph.D.

Professor, Department of Microbiology and Immunology

Virginia Commonwealth University

Richmond, Virginia

September 2011

Acknowledgements

Upon entrance into graduate school, my expectation was that I would acquire the skills and thinking processes required to forge a successful career in the biological sciences. While I was correct in these assumptions, I was ignorant to the fact that in my tenure as a graduate student, that I would learn many valuable life lessons and attain unimaginable growth, both on scientific and personal levels. This would not have been possible without my advisor, lab mates, friends, and family.

It is with great pleasure that I thank my advisor, Dr. Richard T. Marconi, for allowing me this opportunity and for being a fantastic mentor. His knowledge, support, and advice over the past several years has shaped me into the person I am today, both as a scientist and as a person. I am indebted to my lab mates, past and present, for their words, support, and assistance over the years. I would like to give special thanks to past lab members Dr. Beth Abdunnur for getting the cyclic-di-GMP work off of the ground, Dr. Chris Earnhart for his library-sized amount of knowledge and advice involving everything science, and Dr. Lee Szkotnicki, mentor and friend, for his advice and assistance. I would also like to thank present lab members Jess Kostick for her assistance and discussions about cyclic-di-GMP and *Borrelia*, Dr. John McDowell for his advice and friendship, and a special thanks to Dr. Jesse Frederick who has been nothing but a great friend and mentor.

I also need to thank all of my friends, past and present, for their support and friendship over the years. Thanks go out to my friends from Roanoke, VA, my college roommates and lifelong friends from Virginia Tech, and everyone whom I have come to know in Richmond, VA. You're ALL amazing people.

Finally, I wouldn't be here today if it weren't for my family. I am hugely indebted to my mother, Augusta Freedman, and my father, Gene Freedman, for their love and support over my life's course. I thank my stepmother, Mary Freedman, for her unwavering support and friendship. I also need to thank my grandparents, alive and deceased for their love, support, and interest in my life's endeavors over the years. Also, thanks go out to my aunts, uncles, and cousins who have given me many smiles and laughs over the years.

Table of Contents

	Page
Acknowledgements.....	ii
List of Tables.....	vii
List of Figures.....	viii
List of Abbreviations.....	x
Abstract.....	xiv
Chapter	
1 Introduction.....	1
Lyme disease.....	1
Tick-borne relapsing fever.....	6
<i>Borrelia</i>	7
Cyclic-di-GMP and TCRS signaling in <i>Borrelia spp.</i>	12
Research Objectives.....	25
2 Materials and methods.....	28
<i>Borrelia</i> strains and cultivation.....	28
DNA isolation.....	28
Polymerase chain reaction (PCR).....	29
Site-directed mutagenesis.....	40
TOPO-TA Cloning.....	40

Cloning of <i>plzA</i> , <i>plzB</i> , <i>rrp1</i> , and <i>wspR</i> for protein expression.....	41
Recombinant protein expression and purification.....	42
Expression and purification of r-PdeA (BH0363).....	43
Synthesis of c-di-GMP and [³² P]c-di-GMP.....	44
PdeA phosphodiesterase assays.....	44
Analysis of c-di-GMP binding to wild type and site-directed substitution mutants of PlzA an PlzB.....	45
Preparation and analysis of <i>B. burgdorferi</i> / <i>B. hermsii</i> RNA from cultures and from <i>I. scapularis</i> ticks infected with <i>B. burgdorferi</i>	45
Preparation of RNA from the organs and tissues of mice infected with <i>B. burgdorferi</i>	47
Real-time quantitative reverse transcriptase-PCR (qRT-PCR) of RNA isolated from animal tissue.....	47
Allelic exchange mutagenesis.....	48
Pulsed-field gel electrophoresis (PFGE).....	50
Mutant growth rate analysis.....	51
Motility analysis.....	51
Swarming motility analysis assays.....	51
Capillary chemotaxis assays.....	52
Lyme disease model of murine infection.....	52
Tick studies.....	53
Relapsing fever model of murine infection.....	53
Sodium dodecyl sulphate-polyacrylamide gel electrophoresis (SDS-PAGE) and immunoblotting (western blotting).....	54
ELISA and seroconversion.....	55
Determination of intracellular c-di-GMP concentration.....	55

3	Identification and molecular characterization of a cyclic-di-GMP effector protein, PlzA (BB0733): evidence for the existence of a functional cyclic-di-GMP regulatory network in <i>Borrelia burgdorferi</i>	57
	Analysis of the distribution of PlzA among pathogenic <i>Borrelia</i> species.....	57
	Transcriptional analysis of <i>plzA</i> during <i>in vitro</i> cultivation, in ticks, and in infected C3H/HeJ mice.....	61
	Synthesis of c-di-GMP using recombinant diguanylate cyclases derived from <i>B. burgdorferi</i> and <i>P. aeruginosa</i>	66
	Generation of r-PlzA and r-PlzA site-directed mutants and analysis of their c-di-GMP binding ability.....	69
	Discussion.....	72
	Acknowledgements.....	78
4	Analysis of the impact of the PilZ-domain containing proteins, PlzA and PlzB, on motility and the enzootic cycle of the Lyme disease spirochetes.....	79
	<i>plzB</i> is variably distributed throughout <i>Borrelia burgdorferi</i> sensu lato.....	79
	PlzB is a cyclic-di-GMP binding PilZ domain protein.....	80
	Allelic exchange mutagenesis: inactivation of <i>plzA</i> , complementation with <i>plzA</i> and <i>plzB</i> , and analysis of mutant growth rates.....	80
	<i>plzB</i> is unable to complement <i>plzA</i> motility functions.....	86
	<i>plzA</i> , but not <i>plzB</i> , plays a role important in murine infectivity.....	91
	<i>plzA</i> is nonessential for survival in ticks, but is required for murine infection via tick bite; <i>plzB</i> cannot complement this function.....	95
	Discussion.....	99
	Acknowledgements.....	108

5	Metabolism of c-di-GMP in the tick-borne relapsing fever spirochete, <i>Borrelia hermsii</i> , plays an integral role in motility and virulence.....	109
	Rrp1 is a phosphorylation-dependent, response regulator/diguanylate cyclase protein.....	109
	PdeA is an EAL domain-containing phosphodiesterase.....	110
	Generation and characterization of a <i>rrp1</i> and <i>pdeA</i> deletion mutant and complement strains.....	110
	<i>B. hermsii</i> cells lacking <i>pdeA</i> accumulate cyclic-di-GMP compared to the wild type and <i>rrp1</i> mutant.....	121
	Loss of both <i>rrp1</i> and <i>pdeA</i> result in an attenuated murine infection.....	121
	Characterization of the roles of PdeA and Rrp1 in motility and chemotaxis.....	129
	Discussion.....	129
	Acknowledgements.....	138
6	Conclusions.....	139
	Literature Cited.....	142
	Vita.....	160

List of Tables

	Page
Table 1: Published phenotypes of <i>B. burgdorferi</i> c-di-GMP signaling mutants.....	26
Table 2: <i>Borrelia</i> isolates used in this study.....	30
Table 3: Oligonucleotides used in this study.....	33
Table 4: Similarity and identity values for PlzA from <i>Borrelia</i> species.....	60
Table 5: Average run velocity and flexes/sec of <i>B. burgdorferi</i> <i>plzA</i> mutants.....	92
Table 6: Outgrowth of spirochetes from murine biopsies.....	98
Table 7: PlzA regulation of tick survival by <i>B. burgdorferi</i>	100

List of Figures

	Page
Figure 1: The enzootic cycle of <i>Borrelia burgdorferi</i>	3
Figure 2: Genetic organization of <i>B. burgdorferi</i>	9
Figure 3: Ultrastructure and motility of <i>Borrelia spp</i>	13
Figure 4: Cyclic-di-GMP signaling overview.....	19
Figure 5: Distribution of PlzA in pathogenic <i>Borrelia spp</i>	58
Figure 6: Phylogenetic analysis of PlzA in pathogenic <i>Borrelia spp</i>	62
Figure 7: Consensus analysis of PlzA in pathogenic <i>Borrelia spp</i>	64
Figure 8: <i>In vitro</i> and <i>in vivo</i> transcriptional analyses of <i>rrp1</i> and <i>plzA</i>	67
Figure 9: HPLC analysis of c-di-GMP synthesis by r-WspR and r-Rrp1.....	70
Figure 10: C-di-GMP binds to PlzA of <i>Borrelia burgdorferi</i> with high specificity.....	73
Figure 11: PlzB is a PilZ domain-containing protein that binds c-di-GMP with high specificity.....	81
Figure 12: Characterization of <i>plzA</i> allelic exchange and deletion mutants.....	83
Figure 13: Growth rates of <i>plzA</i> allelic exchange/deletion mutants.....	87
Figure 14: PlzA but not PlzB, regulates the swarming motility of <i>B. burgdorferi</i>	89
Figure 15: PlzA but not PlzB regulates motility patterns of <i>B. burgdorferi</i>	93
Figure 16: PlzA regulates processes important in mammalian infection.....	96
Figure 17: PlzA is necessary for the transmission of <i>B. burgdorferi</i> to mammalian hosts during the tick-mouse-tick enzootic cycle.....	101

Figure 18: Rrp1 of <i>B. hermsii</i> is a GGEEF domain-containing protein exhibiting DGC activity.....	111
Figure 19: PdeA of <i>B. hermsii</i> is a c-di-GMP specific EAL phosphodiesterase.....	113
Figure 20: Generation and characterization of a <i>rrp1</i> and <i>pdeA</i> deletion mutant and complemented strains.....	116
Figure 21: <i>B. hermsii</i> cells lacking <i>pdeA</i> accumulate cyclic-di-GMP compared to the wild type and <i>rrp1</i> mutant.....	122
Figure 22: Loss of both <i>rrp1</i> and <i>pdeA</i> result in an attenuated murine infection.....	125
Figure 23: Serological analysis of mice infected with <i>rrp1</i> and <i>pdeA</i> deletion mutants.....	127
Figure 24: Characterization of PdeA and Rrp1 mutants effect on motility and chemotaxis.....	130

Abstract

CYCLIC-DI-GMP SIGNALING IN THE *BORRELIA* SPIROCHETES

By John Courtland Freedman

A dissertation submitted in partial fulfillment of the requirements for the degree of Doctor of Philosophy at Virginia Commonwealth University

Virginia Commonwealth University 2011

Major Director: Richard T. Marconi, Ph.D.

Professor, Department of Microbiology and Immunology

Lyme disease is the most common tick-borne disease in North America, with approximately 35,000 cases reported to the Centers for Disease Control in 2008. The genome of its causative agent, *Borrelia burgdorferi*, encodes for a set of genes involved in the metabolism and regulatory activities of the second messenger nucleotide, cyclic-di-GMP (c-di-GMP). Rrp1 is a response regulatory-diguanylate cyclase, and its regulatory capability is likely mediated via production of c-di-GMP, as it lacks a DNA-binding domain. One known class of c-di-GMP effector/binding proteins are those that harbor a PilZ domain. The genome of *B. burgdorferi* strain 5A4 encodes for one chromosomally-carried PilZ domain, which we have designated PlzA. Additionally, certain *B. burgdorferi* strains encode for a second PilZ domain-containing protein (PlzB) which is plasmid-carried. Both PlzA and PlzB were found to bind specifically to c-di-GMP, and c-di-GMP binding by PlzA was found to be dependant upon arginine residues

in the c-di-GMP binding region. Additionally, expression of PlzA was found to be upregulated by tick feeding and was constitutive in the mammalian host. We next constructed two deletion/allelic exchange mutants – one with the targeted deletion of PlzA, and one that replaced PlzA with PlzB in a strain lacking the *plzB* gene. Our studies demonstrated that $\Delta plzA$ was deficient in motility and was also non-infectious in the mouse model of *B. burgdorferi* infection. Additionally, this strain remained viable in larval *Ixodes* ticks. Also, B31-*plzB* KI was deficient in motility, as well as infectivity, demonstrating that PlzB is unable to complement for functions of PlzA *in vitro* and *in vivo* and that it may play other roles in the biology of *B. burgdorferi* strains carrying the *plzB* gene. These studies represent the first identification of a c-di-GMP binding protein in any spirochete, but also represent the first demonstration of the importance of PilZ domain proteins in a spirochetal system. We additionally examined the effects of c-di-GMP synthesis and breakdown in the related bacterium, *B. hermsii*, a causative agent of tick-borne relapsing fever (TBRF). Deletion mutants in Rrp1 (*B. hermsii*'s sole diguanylate cyclase) and PdeA (*B. hermsii*'s only EAL domain-containing phosphodiesterase) were created. These strains were analyzed in order to determine: 1) the effect(s) of the loss of Rrp1/PdeA on intracellular spirochete c-di-GMP levels, and 2) the effects of Rrp1/PdeA on the establishment of murine infection and on gross motility/chemotaxis. It was demonstrated that c-di-GMP accumulates intracellularly in the cells lacking PdeA. Additionally, spirochetes were shown to chemotax towards N-acetyl-glucosamine (NAG) and they did not form soft agar swarms. In contrast, cells lacking Rrp1 did not accumulate detectable levels of c-di-GMP, demonstrated a reduced ability to chemotax towards NAG, and swarmed on soft agar in a fashion

indistinguishable from wild type. Despite these differences in phenotype, both mutant strains display an attenuated murine infectivity. These results indicate that c-di-GMP is indeed important in the TBRF spirochete, *B. hermsii* and this vital second messenger plays key roles in virulence, motility, and chemotaxis. These studies also pave the way for future investigation of *B. hermsii* through use of targeted genetic manipulation.

Chapter 1: Introduction

Lyme disease

Lyme disease is the most common tick-borne illness in North America and Eurasia, with approximately 30,000 cases reported annually to the Centers for Disease Control (CDC) (32, 153). However, this figure is believed to be an underestimate of the actual number of cases, as a result of physician misdiagnosis and noncompliance in reporting. In 1975, the town of Lyme, Connecticut (CT) became an epicenter of epidemiological study. Thirty-nine children within a small area of Lyme, CT were diagnosed with symptoms of juvenile arthritis – the cause, unknown (156). Valiant efforts and fervent communication between public health officials, physicians, and top researchers of tick-borne illness, lead to the discovery in 1981 that Lyme disease was caused by the spirochete, *Borrelia burgdorferi* (named after Willy Burgdorfer, its lead discoverer) (14, 23, 154). Though it was known that the causative agent of Lyme disease was tick-borne, it was confirmed that *B. burgdorferi* is transmitted by the bite of infected *Ixodes scapularis* ticks (9). Almost thirty years later, Lyme disease researchers have obtained a breadth of knowledge as to a number of molecular mechanisms that underlie the ability of *B. burgdorferi* (as well as *B. garinii* and *B. afzelii* in Asia and Europe) to establish and cause productive infection (152).

Lyme *Borrelia spp.* exist in an enzootic cycle between hard-bodied ticks of the genus, *Ixodes*, and a number of hosts including mammals and birds. It is important to note that humans are accidental hosts of Lyme spirochetes. The ticks that transmit the Lyme *Borrelia* are found worldwide, making Lyme disease a health hazard of global concern. *I. scapularis* transmits *B. burgdorferi* in the eastern regions of the United States (US), and *I. pacificus* transmits these organisms in the western US. The species, *I. ricinus* and *I. persulcatus*, respectively, transmit disease in Europe and Asia (4). The life cycle of *Ixodes* ticks falls in conjunction with the transmission of Lyme disease spirochetes. Adult ticks lay eggs in the spring, which hatch into larval ticks in the summer time. In the summer, the larvae take a blood meal on potentially infected rodent, birds, or other animals. If the animal they feed upon is infected, they may acquire the Lyme *Borrelia*. During the fall and winter, the now-infected larval tick moults, and matures into the nymphal form. By spring, the nymphal tick is ready to take another blood meal, and is capable of transmitting *Borrelia* to other animals, including accidental human hosts. Following the same time line, nymphal ticks moult into adult male and female ticks, which are then able to lay eggs in the spring, thus perpetuating the tick life cycle. Importantly, transovarial transmission of the Lyme spirochetes does not occur (Figure 1) (4).

Following the initial tick bite, the spirochetes begin to disseminate laterally through tissues, initially causing an erythema migrans (EM) rash in 80% of patients. The EM rash manifests itself as a 'bull's-eye' pattern, with the center lesion at the site of the tick bite being 5 - 6.8 cm in diameter. However, more often than not infected individuals do not recall a tick bite (155, 171). The EM rash grows in diameter over

Figure 1. The enzootic cycle of *Borrelia burgdorferi*. *B. burgdorferi* is maintained in nature in an enzootic cycle between *Ixodes spp.* ticks and mammalian hosts. Shown is the three stage life cycle of *Ixodes scapularis*. Larval, nymphal, and adult stages are indicated. Larval, nymphal, and adult ticks take a blood meal in the seasons indicated and where are shown in proximity to mammalian or avian hosts. Larval and nymphal ticks undergo moulting and adult ticks lay eggs following the bloodmeal. Larval ticks most commonly acquire Lyme *Borrelia* from the mammalian host, and nymphal ticks are the most common to transmit Lyme *Borrelia* to other mammalian hosts, including humans. See text for further detail.

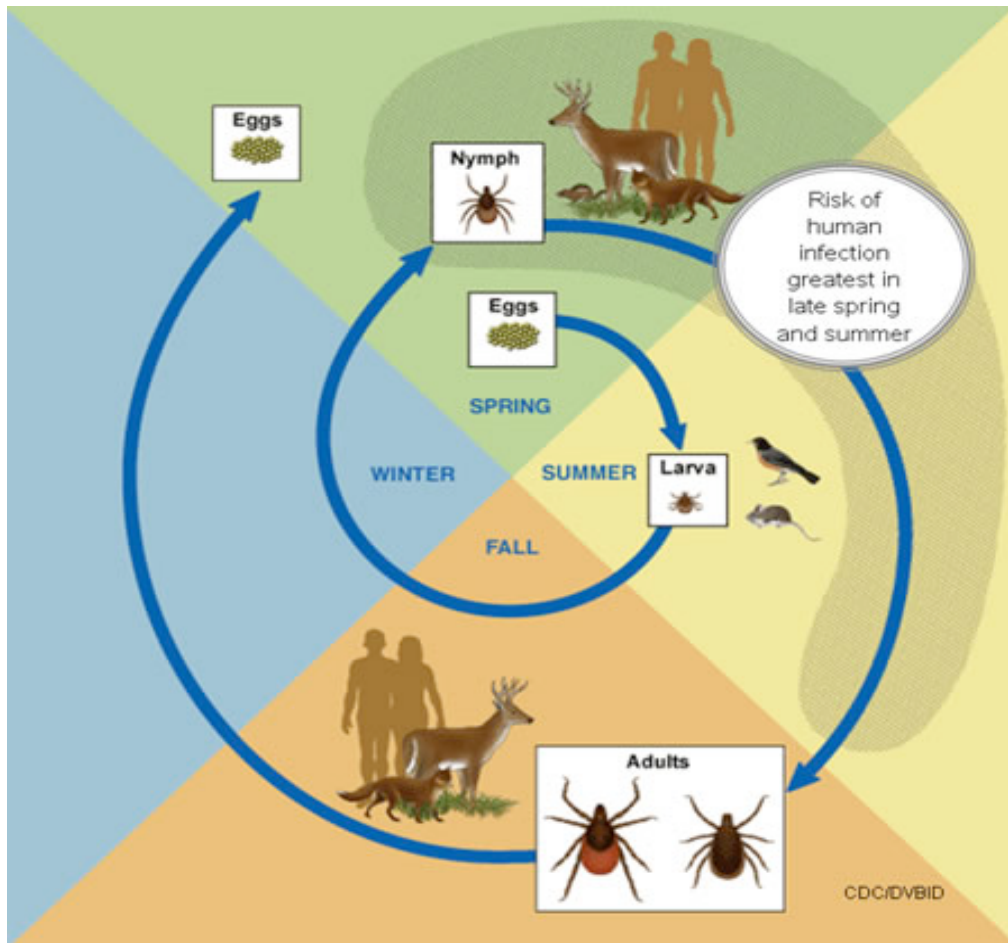

Image adapted from Centers for Disease Control

time, with the final diameter reaching up to 12 inches in size. Concurrent with the EM rash, are manifestations that include chills, fever, headache, myalgia, and arthralgia (7). If left untreated, the motile spirochetes can enter into the vasculature and disseminate into other tissues (106). Late stage manifestations of Lyme disease include arthritis, dermatological, neurological, and cardiovascular disorders. Patterns of dissemination may differ upon species and strains of the Lyme *Borrelia*, affecting the clinical outcome of disease (104).

Lyme arthritis is reported in 60% of untreated cases, and is most commonly reported unilaterally in the knees. Inflammation can be severe, and the accompanying arthritis is the most common symptom occurring in US infection (50, 170). Unlike Gram-negative bacteria, the *Borrelia* do not produce lipopolysaccharide (LPS), and evidence supports that the expansive array of membrane lipoproteins are responsible for the inflammation (45, 142). The most common dermatological manifestation is acrodermatitis chronica atrophicans (ACA), which manifests itself as a skin lesion, typically on the backs of hands and feet. Initially, swelling of the skin occurs and later hyper-pigments and atrophies. These symptoms are most commonly associated with *B. afzelii* infection (70). Neurological manifestations (neuroborreliosis) are most commonly found in those infected with *B. garinii*, and include meningitis and cranial neuritis. Meningitis is the most common form of neuroborreliosis and symptoms include headache, stiff neck, malaise, and photosensitivity. Cranial neuritis affects the cranial nerve, and may additionally affect the facial nerve, causing unilateral facial palsy (Bell's palsy) (66, 108). Carditis also may occur, but is not associated with a specific species of *Borrelia* (54, 131).

Treatment of Lyme disease involves the use of antimicrobial therapy, with oral doxycycline being the major drug utilized for early localized and/or disseminated disease. Intravenous (IV) ceftriaxone is the antibiotic of choice for late stage and disseminated infection (21, 50).

Tick-borne relapsing fever

Tick-borne relapsing fever (TBRF) is also caused by species of the genus *Borrelia*. Three species have the potential to cause disease in North America (*B. hermsii*, *B. turicatae*, and *B. parkeri*) and greater than 20 have the potential to cause disease in Africa (73, 138). While instances of the disease are low in North America (<25 cases/year), they are quite high in sub-Saharan Africa, with certain villages having reported rates of up to 30%. Spread by the bite of infected soft-bodied tick vectors of the genus *Ornithodoros*, TBRF has also been reported to be a top ten killer of youth in these regions (42). In Africa, endemic and epidemic disease cases are associated with conditions of drought, while in North America, most cases occur in mountainous regions and are associated with campers staying in close proximity to *Ornithodoros* ticks in rustic cabins and caves (87). *Ornithodoros* ticks are the major reservoirs of the TBRF *Borrelia* and have a life cycle that differs from the *Ixodes* ticks. Differences are that the *Ornithodoros* ticks undergo many nymphal blood meals and molts. Also, unlike *Ixodid* ticks which feed for 24-48 hours, *Ornithodoros* ticks feed as quickly as 30-45 minutes. As such, tick acquisition and transmission processes of the TBRF *Borrelia* are likely to differ greatly from those species that cause Lyme disease (96).

Also in comparison to Lyme disease, are the differing disease processes, manifestations, and clinical outcomes of TBRF. TBRF *Borrelia* quickly gain entry into the bloodstream following the tick bite. In fact, the hallmark of TBRF is high numbers of spirochetes in the blood (up to 10^6 spirochetes/mL), which correlate with high fever, malaise, and generalized “flu-like” symptoms (47). Due to allelic exchange of *vmp* (*variable major protein*) gene cassettes on linear plasmids, the relapsing fever *Borrelia* are able to express and present different Vmps on the surface, allowing escape from the adaptive immune system. This form of antigenic variation allows for outgrowth of *Borrelia* expressing previously unrecognized Vmp types in the blood. This outgrowth correlates with the previously mentioned symptoms, and is responsible for the number of relapses that occur over the course of disease. However, over time, the TBRF spirochetes are typically cleared via the adaptive-humoral immune response by a bacteriocidal and complement-independent IgM antibodies. (40, 77, 99, 121, 157). Three to 10 relapses may occur over the course of infection, if left misdiagnosed or untreated (33). Treatment of TBRF typically occurs with a 7 day course of doxycycline (87, 168). In infection that is left untreated, many organ systems of the body can become infected, with mortality most commonly being associated with myocarditis (27).

Borrelia

Species of the genus *Borrelia* are unique and highly diverse prokaryotic organisms of the phylum *Spirochaetes*, which includes the genera *Treponema* and *Leptospira*, also of human health significance. All *Borrelia* spp. share a common cellular morphology (i.e. they appear as ‘spirals’), a segmented, and variable genome,

and are dependent upon animal hosts for their survival in nature (10, 31, 36, 55).

Borrelia spp. can be grouped into several clades based upon their genetic makeup, thus affecting the specific enzootic niche and disease that they cause. *Borrelia spp.* cause Lyme disease (*B. burgdorferi*, *B. afzelii*, and *B. garinii*), relapsing fever (*B. hermsii*, along with others), avian borreliosis (*B. anserina*), and epizootic bovine abortion (*B. coriaciae*) (25, 56, 64, 73, 95, 98, 136, 141).

The ultrastructure of *Borrelia spp.* is unique in that they contain an inner membrane, a single periplasmic layer of peptidoglycan, periplasmic flagella, and an outer membrane with an expansive repertoire of lipidated proteins (46, 102, 120). Within the inner membrane is the unique, segmented genome composed of a linear chromosome of approximately 900 kb, and up to 21 linear and circular plasmids (30, 31, 43, 52, 55, 78, 89, 122). Though genetic organization is similar between *Borrelia spp.*, it is important to note that the chromosome encodes predominantly for housekeeping proteins, while the plasmids predominantly encode for proteins involved in specific disease processes (30, 31, 43, 52, 55, 78, 89, 122). Chromosomal organization is maintained significantly between *Borrelia spp.*, while plasmid repertoire may differ greatly between species and strains. The genetic constituents of *B. burgdorferi* B31 are shown in Figure 2. It is thought that the phenomena of plasmid repertoire/organization play a role in disease manifestations and clinical outcomes. It is noteworthy that *Borrelia spp.* have minimal metabolic capabilities. The limited *de novo* biosynthetic capabilities of the *Borrelia* keep them restricted to a host-dependant lifestyle. Genomic analysis indicates that they are homofermenters and rely on glycolysis with lactate as a terminal electron-acceptor. Additionally, they lack the enzymes required for nucleotide,

Figure 2. Genetic organization of *B. burgdorferi*. The genome of *B. burgdorferi* consists of a linear chromosome of approximately 910 kilobase pairs. Additionally, approximately 21 linear and circular plasmids are maintained by the organism. The chromosome encodes predominately house keeping genes, while the plasmids encode for genes important for host dependent processes. Plasmids shown in red have been shown to be important in processes important in host infection.

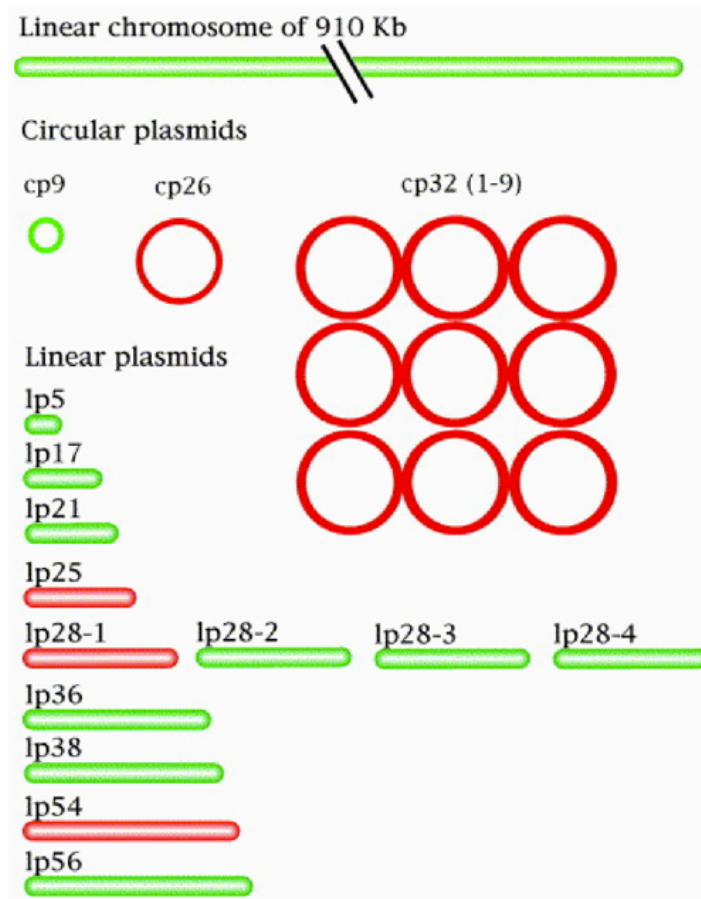

Adapted with permission from Stewart PE, Byram R, Grimm D, Tilly K, Rosa PA, 2005. *Plasmid*, 53(1). (197).

amino acid, and fatty acid biosynthesis, and must rely on transport of these compounds from the host environment (55). These organisms encode for several ABC transporters as well as P66, which is a pore-forming outer membrane protein (147, 148). There are approximately 100 predicted proteins involved in transport across membranes. The *Borrelia* also lack enzymes required for the TCA cycle, oxidative phosphorylation, and lipopolysaccharide synthesis. ATP is generated from substrate level phosphorylation and a V-Type ATPase in the inner membrane, as they lack an electron transport chain (55).

Moving outwards is the periplasmic space which contains a single layer of peptidoglycan and periplasmic flagella (35, 102). The flagella of the *Borrelia* form helical bundles around the protoplasmic cylinder, which attribute to the cells a flat-wave morphology and ability to be motile. *Borrelia spp.* have 2 flagellar bundles attached near each end of the cell cylinder containing 7-11 flagellar filaments each. Flagellar filaments extend towards the center of the cell, and it is believed that their rotation against the cell cylinder allows the cells to gyrate and move through viscous media, and more importantly, tissue during *in vivo* infection (Figures 3A and 3B) (34-36, 46, 81, 93). Interestingly, while the *Borrelia* encode for homologs of most flagellar, flagellar motor, and chemotaxis proteins found in other genera of bacteria, they encode for multiple and heterologous copies of FliG (FliG-1 and FliG-2) as well as proteins involved in chemotaxis (55, 62, 63). As is the case with other bacteria, the *Borrelia* use the proton motive force to generate energy for gyration of the flagellar motors (143). Gyration of the motors occurs at both ends of the cells. Simultaneous gyration in the counterclockwise (CCW) or clockwise (CW) results in flexes/pauses, equivalent to the

'tumbles' observed in rod-shaped bacteria such as the *Enterobacteriaceae*. When either end of the cell rotates in opposing directions, the cell moves in the direction of the cell pole that is turning CCW (Figure 3C). Typical *Borrelia* motility follows a pattern of a run, followed by a flex/pause, followed by a reverse run (90, 160). It is thought that this pattern of motility may be a result of the chemotactic response, important in homing of the *Borrelia* towards attractants and away from repellants (8, 90, 144).

The outer membrane of the *Borrelia* displays an expansive repertoire of lipitated proteins, important for survival in the tick vector, transmission from the tick vector to the mammalian reservoir, and establishment/maintenance of mammalian infection (2, 84, 110, 119, 120, 140, 165, 175). Many of these outer membrane proteins are antigenic in nature and it is believed that they may be responsible for inflammation encountered during mammalian infection (11). Outer surface proteins important during tick transmission and mammalian infection include Outer surface protein A (OspA), and OspC. While these surface proteins are important for infection, many of the proteins important for establishment of mammalian infection, as well as tick survival, acquisition, and transmission from/to the mammal, are those involved in two-component regulatory system (TCRS) signaling, as well as in signaling by the second-messenger nucleotide, cyclic-di-GMP (18, 28, 116, 160, 174).

Cyclic-di-GMP and TCRS signaling in *Borrelia* spp.

Within the past several decades, the study of intracellular signaling by second messenger nucleotides has come to the forefront of prokaryotic physiological research

Figure 3. Ultrastructure and motility of *Borrelia spp.* A) The top portion shows an entire view of the *Borrelia* spirochete. The outer membrane is shown in pink, the periplasmic cylinder (including the inner membrane) is shown in yellow, and the periplasmic flagella are shown, wrapping around the cylinder from both ends of the cell. A view of the cellular structure is amplified in the bottom portion of the figure, where the outer membrane, inner membrane, periplasmic space/flagella/peptidoglycan are shown. B) Transmission electron micrograph showing 9 flagellar bundles wrapped in parallel fashion around the periplasmic cylinder. Rotation against the cell cylinder is thought to generate torque to drive the spirochetes through host tissue. C) Graphical representation of bi-polar cell rotation and movement. Cells gyrating in the same direction (CW or CCW) causes a flex or pause, and cells gyrating in opposite directions move in the direction of the pole moving CCW.

A)

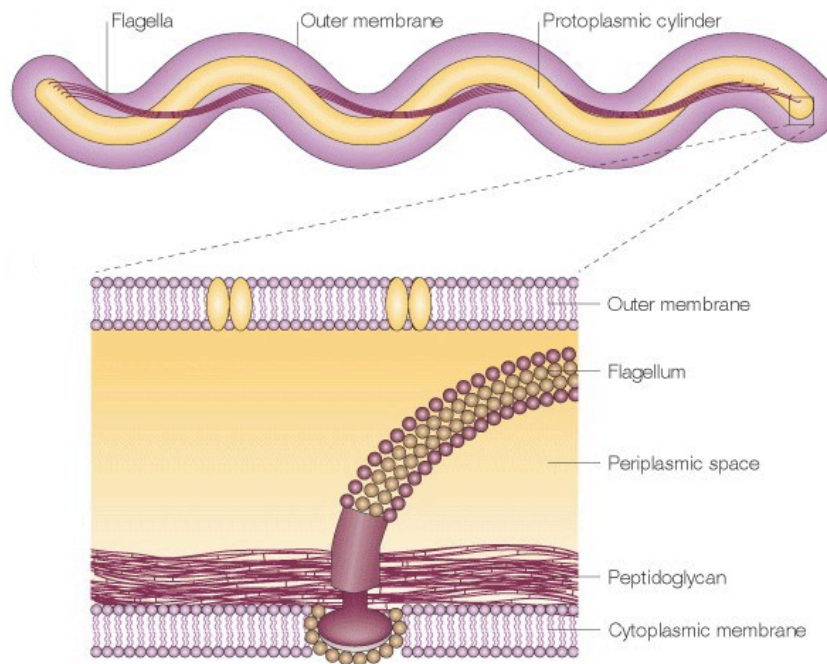

Adapted with permission from Rosa, PA *et al.* Nat Rev Microbiol. 2005 Feb;3(2):129-43.

B)

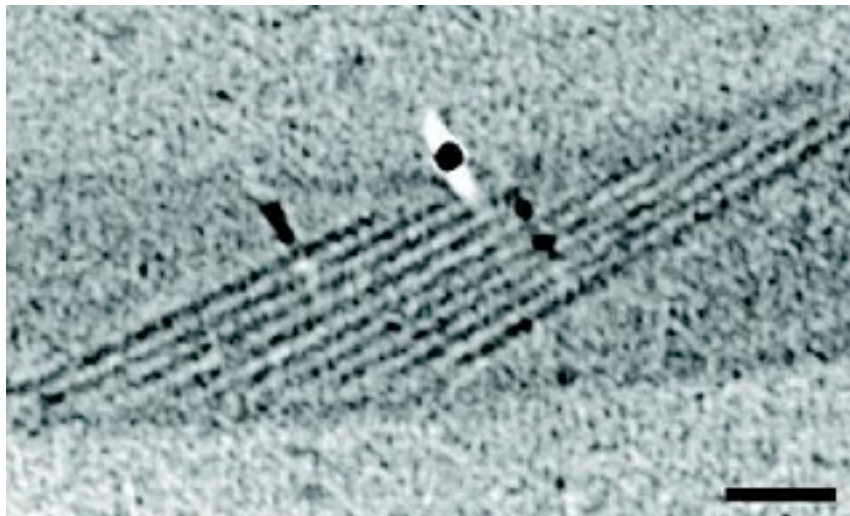

Adapted with permission from Charon, NW *et al.* J Bacteriol. 2009 Jan;191(2):600-7. Epub 2008 Nov 14.

c)

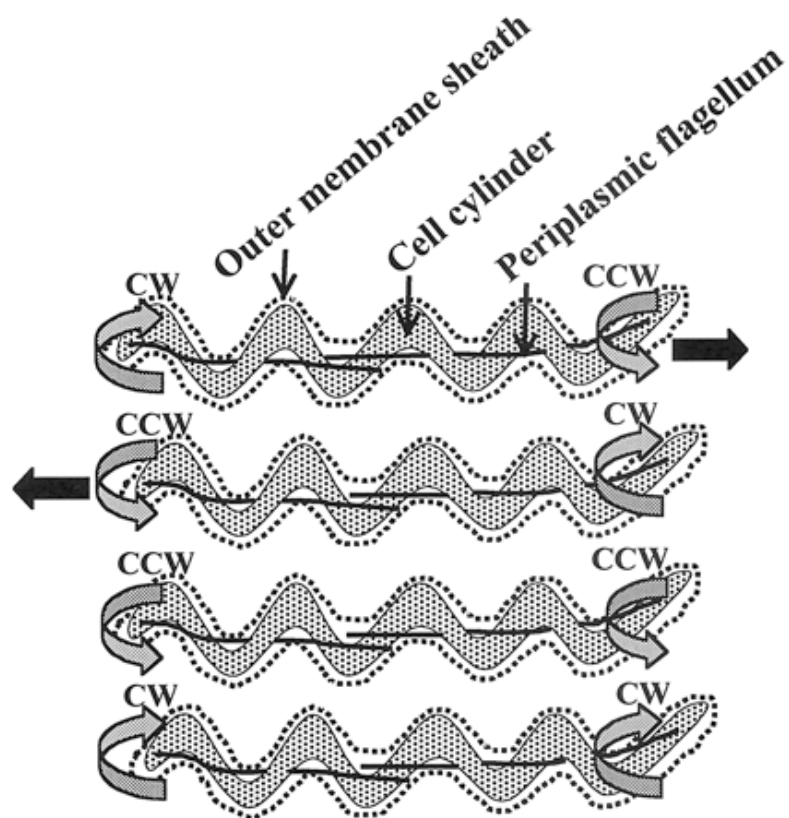

Adapted with permission from Li, C *et al.* Proc Natl Acad Sci U S A. 2002 Apr 30;99(9):6169-74. Copyright (2002) National Academy of Sciences, U.S.A.

(15, 16, 176). Initial efforts focused on cyclic mononucleotides, however, in 1985, a cyclic dinucleotide was identified in *Gluconacetobacter xylinus* that acted as an allosteric activator of cellulose synthase (128, 129). The nucleotide was 3',5'-Cyclic diguanylic acid (cyclic-di-GMP, or c-di-GMP), which was later realized to be a globally distributed second messenger in the prokaryotic kingdom (69, 135). It was recognized via bioinformatic analyses and later biochemical analyses, that c-di-GMP is produced via proteins containing a GG(D/E)EF domain, named after the amino acid motif present at the active site. Proteins with the GG(D/E)EF domain are also known as diguanylate cyclases (DGCs), named after their ability to convert 2 molecules of guanosine-5'-triphosphate (GTP) into c-di-GMP. DGCs are encoded for by almost all prokaryotic genomes, including Gram-negative, Gram-positive, and spirochetal species (6, 60, 114, 135).

Down regulating the levels of c-di-GMP are phosphodiesterases (PDEs) containing EAL and HD-GYP domains (132, 146, 163, 166). EAL domain-containing proteins and HD-GYP domain-containing proteins break c-di-GMP into linear-di-GMP (l-di-GMP, pGpG) and GMP respectively. Like DGCs, most bacterial genomes harbor multiple copies of EAL domains, though HD-GYP domains are more rare (60, 133, 149). *E. coli* encodes for 29 DGCs and EAL PDEs and *Vibrio spp.* encode for more than 50 DGCs and PDEs (69, 167). However, specific DGCs and PDEs appear to have differential functions dependent upon differential gene expression, temporal activity in response to environmental stimuli, and spatial separation of signaling components, which allows for sequestration of specific c-di-GMP signaling components (29, 65, 75, 113, 151). In other words, regulation of localized levels of c-di-

GMP appears to be the driving force in the regulation phenotypes associated with the second messenger.

Differential regulation has been demonstrated to be important in regulating c-di-GMP signaling in *E. coli* via the DGCs YcdT and YdeH. Both proteins are downregulated via the mRNA-binding protein CsrA, which inhibits poly-*N*-acetylglucosamine (PNAG) synthesis and stimulates expression of the flagellar regulator FlhDC. This allows for the upregulation of the PDE YhjH, and subsequent transition towards motile behavior (74, 75, 162). Temporal activity becomes important in the cases of c-di-GMP signaling components that are part of TCRS. Several bacteria encode for response regulators that synthesize c-di-GMP following phosphorylation by their cognate histidine protein kinase (1, 28, 80, 85, 112, 135). Spatial separation of c-di-GMP signaling components has been documented in several bacterial species, but most well studied is the example of PleD in *Caulobacter crescentus*. Following phosphorylation of PleD by PleC or DivJ, PleD dimerizes and localizes at the cell pole. This allows for localized production of c-di-GMP and is important in *Caulobacter* cell cycle progression. In terms of most bacterial species, high levels of c-di-GMP correlate with transition towards a non-motile and sessile state, biofilm formation, exopolysaccharide (EPS) production, and expression of adhesive molecules which allow for multicellular behaviors, important during certain infection phases (65, 113). Low levels of c-di-GMP correlate with decreased biofilm formation and transition towards a motile state. This has been observed in *E. coli*, *S. enterica*, and *P. aeruginosa* (76, 91, 94, 115, 117, 134, 146).

Because c-di-GMP does not act independently, it needs to be able to interact with a number of different effector molecules, that in turn, translate levels of c-di-GMP into physiological outcomes. Examples of c-di-GMP effector molecules include GEMM RNA riboswitches, transcription factors, and PilZ domain-containing proteins (3, 37, 71, 83, 101, 117, 150, 158). C-di-GMP exerts its effects through interaction with GEMM RNA riboswitches by interacting with the 5' untranslated region (UTR). C-di-GMP interaction with such molecules positively affects translation or stability of the RNA molecule. For example, the Vc2 riboswitch (which resides upstream of a transcription factor in *V. cholerae*), was shown to be an 'on' switch for protein translation when levels of c-di-GMP are high (158). The interaction with transcription factors such as FleQ from *Pseudomonas aeruginosa*, has been shown to regulate processes including EPS production. FleQ acts to suppress proteins in the *pel* operon which is responsible for EPS production. When c-di-GMP levels are elevated, this suppression is relieved and the components of the *pel* operon are expressed (71). Finally, interaction with PilZ domain-containing proteins, has been shown to affect various cellular processes, including, but not limited to cell motility/flagellar function. This has been demonstrated in *V. cholerae*, *P. aeruginosa*, and the *Enterobacteriaceae* (41, 79, 88, 111, 117, 134). The most notable and well-described mechanism is that of YcgR. YcgR of the enterobacteria adopts a modulated structure upon binding to c-di-GMP, in turn, increasing its ability to interact with the flagellar motor components FliG, FliM, and MotA, causing a transition towards a sessile state (79, 111, 134). PilZ proteins have also been demonstrated to control EPS production in organisms such as *P. aeruginosa*. Alg44, and c-di-GMP binding by Alg44, was shown to be important in the biosynthesis

Figure 4. Cyclic-di-GMP signaling overview. C-di-GMP is produced from 2 molecules of GTP by diguanylate cyclases containing a GGDEF domain. Opposing c-di-GMP synthesis, are phosphodiesterases containing EAL or HD-GYP domains, which cleave c-di-GMP into l-di-GMP or GMP respectively. Following synthesis, c-di-GMP can interact with a number of effector molecules including proteins containing PilZ domains, transcriptional regulators, or GEMM RNA riboswitches. Increased levels of C-di-GMP have been shown to negatively influence motility and virulence and promote sessility and biofilm formation in a number of organisms. They have also been shown to positively affect cell cycle progression in *Caulobacter crescentus*.

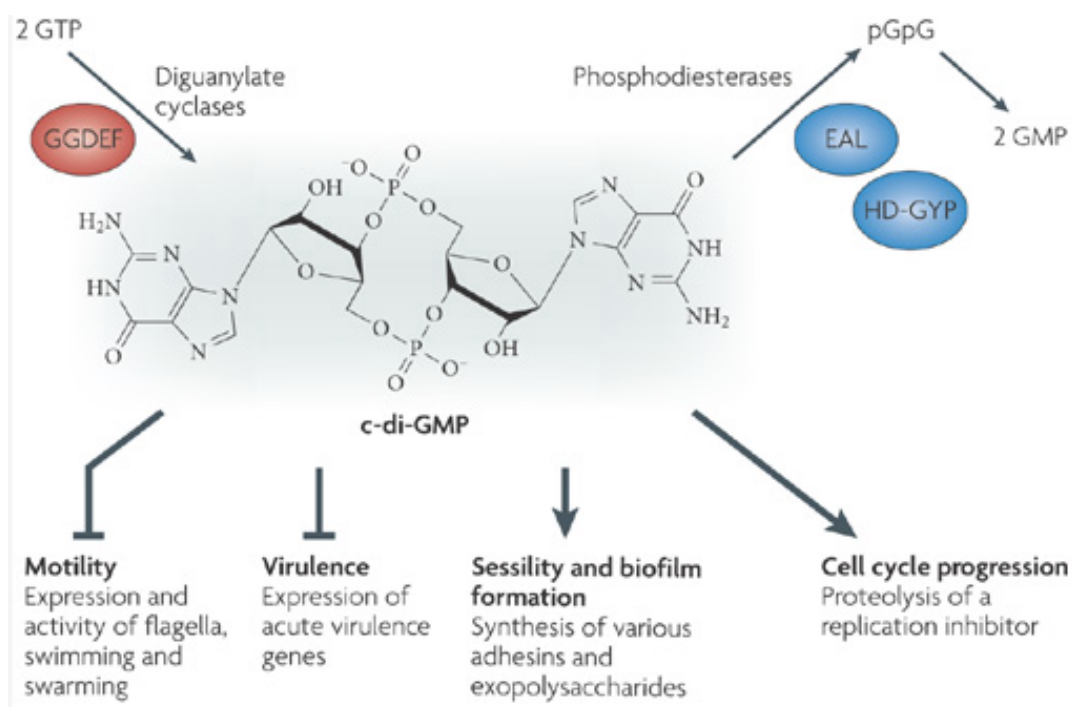

Adapted with permission from Hengge, R. Nat Rev Microbiol. 2009 Apr;7(4):263-73.

of alginate, an important *Pseudomonas* virulence factor (101). While these phenomena have been marginally described in other bacteria, little is known about c-di-GMP signal transduction in a spirochetal system. Figure 4 shows a basic diagram of c-di-GMP signaling. Genomic analyses have indicated that the proteins involved in c-di-GMP synthesis, breakdown, and effector functions are present within the genomes of the spirochetal genera *Leptospira*, *Treponema*, and *Borrelia* (57, 58, 80, 116, 125, 160).

In *Borrelia spp.*, c-di-GMP signaling appears to be governed by one of its five putative TCRS (28, 55, 80, 125). Because the *Borrelia* must rapidly adapt physiologically to withstand different environments encountered within tick and mammalian hosts, TCRS are a prime means to overcome such stresses and changes (9). TCRS consist of a histidine protein kinase (Hpk) and a response regulatory protein (Rrp). The Hpk is able to sense a specific environmental cue such as solute, oxygen levels, and membrane stress – autophosphorylate itself, and transfer the phosphate group to the Rrp. Following phosphorylation, the Rrp, can then carry out a specific activity, which includes DNA-binding, RNA-binding, or an enzymatic activity (59, 61, 161). While three of the putative TCRS encoded for by the *Borrelia* genome appear to govern processes in chemotaxis, two of these have global regulatory capability (24, 103, 109, 125). One with global regulatory capability is the Hpk2-Rrp2 TCRS. Hpk2 and Rrp2 predominantly govern gene regulation of plasmid carried genes. Interestingly, most Hpks are found within the cytoplasmic membrane, but Hpk2 is predicted to be cytosolic. Following phosphorylation/activation of Rrp2 by Hpk2 or acetyl phosphate (AcP), it then acts in conjunction with the sigma factor, RpoN, to activate expression of RpoS via DNA-binding, which governs expression of proteins such as OspC, DbpB/A,

and BBK32 (fibrinogen-binding protein). Additionally, evidence suggests that Rrp2 may act independently as an activator or repressor (17, 18, 67, 109, 172, 174).

The other TCRS encoded for by the *Borrelia* is the Hpk1-Rrp1 system. Different from the Hpk2-Rrp2 system, is that Hpk1 is predicted to traverse the inner membrane, but more importantly, Rrp1 lacks a DNA-binding domain and instead has a C-terminal GGEEF domain. Following phosphorylation of Rrp1, the protein then enzymatically synthesizes c-di-GMP from two molecules of GTP (28, 58, 80, 125, 135). Until recent years, nothing was known about c-di-GMP signaling in bacteria of the genus *Borrelia* or in any spirochetal system. Bioinformatic analyses demonstrated the presence of one DGC (BB0419, or Rrp1), two c-di-GMP PDEs (EAL – BB0363, or PdeA; HD-GYP – BB0374, or PdeB), and one PilZ domain-containing protein (BB0733, or PlzA) in *B. burgdorferi* B31 (58, 125). However, certain strains of *B. burgdorferi* harbor a second PilZ domain-containing protein (PlzB) encoded for on one of the linear plasmid 28 (lp28) extrachromosomal genomic constituents. PlzB is 78% identical to PlzA, however, it is unknown whether it functions similarly to PlzA (58, 80, 125).

In terms of this TCRS, it is interesting to note that *rrp1* is located just downstream of the gene encoding its cognate histidine protein kinase, Hpk1, and both are cotranscribed. Rogers *et al.* spearheaded the study of c-di-GMP signaling in *B. burgdorferi* by creating a deletion mutant of *rrp1* in the non-infectious *B. burgdorferi* B31 derivative, 5A13. Microarray analyses demonstrated the importance of Rrp1 and, by extension, c-di-GMP in the gene regulation of the Core *Borrelia* Genome, which includes the chromosome, linear plasmid 54 (lp54) and circular plasmid 26 (cp26). The genes regulated by Rrp1 constitute 10% of the genome, and include genes functioning

in motility/chemotaxis, metabolism, nucleotide metabolism, transport, immune evasion, and other cellular processes (125).

More recently, Kostick *et al.*, created an *rrp1* deletion mutant in the infectious *B. burgdorferi* B31 derivative, 5A4, in order to assess its effects on motility, chemotaxis, infectivity, and ability to complete the tick-mammal transmission cycle. Additionally, these aspects of *Borrelia* biology were examined in an *rrp1* overexpressing strain using a pBRV2 expressed *rrp1* under control of the *flgB* promoter. Deletion of *rrp1* had significant effects on motility and chemotaxis, as drastic decreases in swarming motility and chemotaxis towards *N*-acetylglucosamine were observed. While the *rrp1* deletion mutant was still infective in mice, the *rrp1* overexpressing strain was noninfective. Spirochetes in the *rrp1* deletion background were unable to colonize and survive in ticks following immersion feeding, and as such, *Ixodes* ticks were unable to acquire spirochetes from mammalian hosts (80). He *et al.* also demonstrated similar phenotypes in an *rrp1* deletion strain, both in terms of infectivity and in tick survival. Interestingly, microarray analyses demonstrated a significant decrease in expression of a four gene operon involved in glycerol transport and metabolism (BB0240-BB0243; *glp*). Both the *rrp1* and *glp* null strains demonstrated a significant growth defect in glycerol-containing media (BSK-glycerol). Likewise, the *glp* deletion mutant was also infectious, but had reduced survivability in ticks. When the *glp* operon was overexpressed in the *rrp1* deletion mutant, the growth defect in BSK-glycerol was restored, and the ability to survive in ticks was also partially restored. Thus, it may be that c-di-GMP governs a metabolic shunt in the tick environment (68).

Similarly, a recent paper by Caimano *et al.*, describes the deletion of *hpk1* in two infectious background strains of *B. burgdorferi*. Analyses of both mutants demonstrate similar phenotypes to the *rrp1* deletion mutant created by Kostick *et al.* and He *et al.* Deletion of *hpk1* revealed a phenotype in which the mutants are able to fully infect C3H/HeJ mice. Larval *I. scapularis* ticks are able to acquire spirochetes lacking *hpk1* via feeding, but spirochetes were unable to survive within the tick midguts. This phenotype may account for the lack of tick acquisition observed in the *rrp1* deletion mutant, which additionally provides supporting evidence for phosphorelay between Hpk1 and Rrp1 (28).

Additionally, Sultan, *et al.*, reported on the function of PdeA on *B. burgdorferi* motility, infectivity, and the ability of the organism to survive in *Ixodes scapularis* ticks. PdeA was shown to have a positive impact on motility, as the deletion of BB0363 caused a very slight decrease in motility. Additionally, its deletion eliminated the ability of *B. burgdorferi* to successfully infect C3H/HeJ mice, as well as survive in ticks. Thus, it appears as if elevated levels of c-di-GMP negatively impact these processes. However, the discrepancy between similar phenotypes in *rrp1* and *pdeA* deletion mutants and their presumed differences in c-di-GMP levels, have not yet been explained. PlzA has recently been investigated by Pitzer *et al.* and was shown to play roles important in *B. burgdorferi* motility and virulence. Similarly to the *rrp1* and *pdeA* mutants, the *plzA* deletion mutant displayed a reduced swarming diameter, indicating that the protein plays an important role in positively regulating *Borrelia* motility. Additionally, the *B. burgdorferi* *plzA* deletion mutant displayed a reduced ability to infect

mice as compared to wild type, in addition to a decreased ability to survive in fed ticks (116).

Most recently, Sultan *et al.* published on PdeB of *B. burgdorferi*. PdeB was shown to be an active HD-GYP domain-containing protein, and was shown to affect cell motility, as a PdeB deletion mutant demonstrated increased flexing relative to the wild type strain. The *pdeB* null strain was infectious in mice, but demonstrated reduced viability in the tick vector – a phenotype seen in all *B. burgdorferi* c-di-GMP signaling mutants (159). Phenotypes associated with c-di-GMP signaling in *B. burgdorferi* are shown in Table 1. Based upon the present knowledge base of c-di-GMP signaling in *Borrelia spp.*, it is clear that c-di-GMP and the protein components involved in synthesis, turnover, and effector functions are important in the biology of this species. However, a marked amount of work remains to be performed in order to better understand each of the components involved in Hpk1 signaling/phosphorelay, c-di-GMP production, breakdown, and the effector mechanisms of c-di-GMP itself, through c-di-GMP-binding proteins and potential undiscovered targets. The work here aims to demonstrate a deeper understanding of c-di-GMP signaling through the study of PilZ domain-containing proteins PlzA and PlzB, as well through a basic analysis of Rrp1 and PdeA in the relapsing fever spirochetal species, *B. hermsii* strain DAH.

Research Objectives

Because c-di-GMP signaling is important in the Lyme spirochete, *B. burgdorferi*, we wished to further characterize c-di-GMP signaling by the PilZ domain-containing proteins PlzA and PlzB. Additionally, we wanted to characterize c-di-GMP signaling by

Table 1. Published phenotypes of *B. burgdorferi* c-di-GMP signaling mutants

	Swarming Motility	Pattern of motility	Chemotaxis	Mouse infectivity	Tick survival
Strain					
ΔBB0363 (5A3-PdeA)	Decreased	Run-pause- no reverse	N/D	(-)	(-)
ΔBB0374 (5A3-PdeB)	Normal	Increased flexing	N/D	(+)	(-)
ΔBB0419 (5A4-Rrp1)	Decreased	Runs, infrequent pauses	Decreased	(+)	(-)
ΔBB0420 (297-Hk1)	Normal	Normal	N/D	(+)	(-)
ΔBB0733 (5A3-PlzA)	Decreased	Normal	N/D	(+/-)	(-)

References (28, 80, 116, 159,160)

Rrp1 and PdeA of *B. hermsii* and the impacts of these proteins on motility and on mammalian infectivity. In order to first assess the impact of PlzA, we desired to examine the distribution of the *plzA* gene amongst the Lyme *Borrelia*, the basic expression patterns of *plzA* during tick and mammalian infection, as well as the basic biochemistry and analysis of c-di-GMP binding to PlzA. Next, we wished to examine the effects of PlzA and PlzB on *B. burgdorferi* motility, chemotaxis, mammalian infection, and ability of the spirochetes to complete the enzootic cycle between *Ixodes* ticks and mammalian hosts. This was done by creating several mutants in a sequenced, wild type strain *B. burgdorferi* B31 clone 5A4. The first mutant constructed is a *plzA* deletion mutant. The other constructed mutants are allelic exchange derivatives in which *plzB* replaces *plzA* in strain 5A4, which does not harbor a plasmid-encoded *plzB* gene. These mutants were used to assess the above hypothesized functions of PlzA and PlzB. Finally, we wished to assess c-di-GMP signaling in the tick-borne relapsing fever spirochete, *B. hermsii*. Because *B. hermsii* causes such a drastically different disease than Lyme disease, we desired to see if Rrp1 and PdeA have similar or different functions compared to that of the Lyme disease *Borrelia*. The research carried forth here not only strengthens our knowledge of c-di-GMP signaling in species of the genus *Borrelia* and other spirochetes, but is also a step forward in techniques used for *B. hermsii* genetic manipulation and phenotypic analysis, as well as our understanding of c-di-GMP effector proteins in spirochetal species.

Chapter 2: Materials and methods

***Borrelia* strains and cultivation**

All *B. burgdorferi*, *B. garinii*, and *B. afzelii* isolates were cultivated in BSK-H complete media containing 6% rabbit serum, and all *B. hermsii* isolates were cultivated in BSK-H (Barbour-Stoenner-Kelly) complete media containing 12% rabbit serum. Cultures were maintained at 25, 33, or 37°C within capped conical tubes stored in humidified incubators under conditions of 5% CO₂. All isolates used are listed within Table 2. Spirochetes were selected in media containing streptomycin (200 µg/mL), kanamycin (100 µg/mL), or gentamicin (40 µg/mL), as needed.

DNA isolation

Borrelia genomic DNA was isolated using a MasterPure DNA purification kit (Epicentre). Cultures were harvested by centrifugation at 6,000 x g at 4°C for 15 minutes. Cells were washed in 1 mL PBS, collected again by centrifugation as described above, and resuspended in 250 µL PBS and lysed by addition of 3 mL Tissue and Cell Lysis Solution with 500 µg of proteinase K at 65°C for 20 minutes, and periodic vortexing of samples every 5 minutes. The samples were placed at 37°C, and 50 µg of RNase A was added and incubated with the lysed samples for 40 minutes. Following RNase treatment, samples were cooled on ice for 10 minutes, 1.75 mL of MCP Protein

Precipitation Reagent was added and the mixture was briefly vortexed for approximately 10 seconds. Cell debris was collected by centrifugation at 10,000 x g for 20 minutes, the supernatant was placed in a clean 15 mL tube, and 5 mL isopropanol was added to the supernatant. Tubes were inverted several times, and DNA was pelleted at 14,000 x g at 4°C for 20 minutes. The collected pellets were rinsed twice with 75% ethanol and resuspended in 50 µL water, and DNA concentration was determined using a UV spectrophotometer.

Polymerase chain reaction (PCR)

PCR was performed using the PTC-100 Thermal Cycler from MJ Research, Inc., and the following cycle conditions were used: 1 cycle at 98°C for 2 minutes, and 35 cycles of 98°C for 20 seconds, 55°C for 15 seconds, 72°C for 1.5 minutes, and final extension of 72°C for 4 minutes. Each PCR reaction contained 15 µL of 2x Phusion buffer (containing proprietary buffer components and 3 mM MgCl₂, 400 µM dNTP, and Phusion polymerase), 13.55 µL MilliQ water, 0.23 µL of each primer (0.75 pmol/µL of each primer) and 1 µL of DNA template (containing 1-10 ng genomic DNA or 0.1-1 ng plasmid DNA). All primers are listed in Table 3 and were designed based upon published genomic sequences of *B. burgdorferi* B31, *B. burgdorferi* ZS7, or *B. hermsii* DAH. All DNA amplicons were analyzed by electrophoresis in 1% agarose gels in Tris-acetate-EDTA (TAE) buffered and visualized by staining with ethidium bromide.

Table 2. *Borrelia* isolates used in this study

Species/Isolate	Geographic Origin	Source
<i>B. burgdorferi</i>		
64b	New York	Human
72a	New York	Human
80a	New York	Human
94a	New York	Human
118a	New York	Human
156a	New York	Human
20004	France	<i>Ixodes ricinus</i>
21343	Wisconsin	White-footed mouse
297	Connecticut	Human CSF
29805	Connecticut	<i>Ixodes scapularis</i>
3028	Texas	Human skin
5A3	New York	B31 derivative, infectious
5A4	New York	B31 derivative, infectious
B31	New York	<i>Ixodes scapularis</i>
Bol26	Italy	<i>Ixodes ricinus</i>
CA3	California	<i>Ixodes pacificus</i>
CA4	California	<i>Ixodes pacificus</i>
CA8	California	<i>Ixodes pacificus</i>
CA9	California	<i>Ixodes pacificus</i>
CA11.2a	California	<i>Ixodes pacificus</i>
CA12	California	<i>Ixodes pacificus</i>
CA-2-72	California	<i>Ixodes pacificus</i>
CA-2-87	California	<i>Ixodes pacificus</i>
FRED	Missouri	Human
LP4	Connecticut	Human skin
LP5	Connecticut	Human skin
LP7	Connecticut	Human skin

MAC13	New York	Human skin
NY-1-86	New York	Human skin
R1000	United States	<i>Ixodes scapularis</i>
T2	United States	<i>Ixodes scapularis</i>
Veery	Connecticut	Veery bird
VS293	Switzerland	<i>Ixodes scapularis</i>
WI91-23	Wisconsin	Bird
ZS7	Germany	<i>Ixodes ricinus</i>

B. afzelii

ACA-1	Sweden	Human skin
ECMI	Sweden	Human skin
IP21	Russia	<i>Ixodes persulcatus</i>
PKo	Germany	Human ACA
U01	Sweden	Human skin
UM01	Sweden	Human skin
VS461	Switzerland	<i>Ixodes scapularis</i>

B. garinii

Far04	Faeroe Islands	Puffin blood
FRG	Germany	<i>Ixodes ricinus</i>
G2	Germany	Human CSF
IP89	Russia	<i>Ixodes persulcatus</i>
PBi	Germany	<i>Ixodes ricinus</i>
PBr	Germany	Human CSF

B. spielmanii

A14S	Netherlands	Human skin
------	-------------	------------

B. valaisiana

VS116	Switzerland	<i>Ixodes ricinus</i>
-------	-------------	-----------------------

Table 3. Oligonucleotides used in this study

Oligonucleotide	Sequence (5' to 3')
Primers for cloning of recombinant proteins	
Rrp1-pMAL- <i>Bam</i> HIF	CGGATCCGTGGAAATGATAATTAAGATAAA
Rrp1-pMAL- <i>Sal</i> IR	CCCGTCGACTTAATATCTAAACTGATTTCTTCC
PlzA-pMAL- <i>Bam</i> HIF	GGATCCTTGTTTAGTATTTTTATATTCAAAA AAAGGAGAAAGGAGAGGT
PlzA-pMAL- <i>Sal</i> IR	GTCGACTTAATTGAAATAATCATGGATCAAC ATAGTATACTCAAGTGGTA
PlzA-R150DR154D-F	CCTGGGCAAATCAGGATATTCATGAGGATAAT
PlzA-R150DR154D-R	ATTATCCTCATGAATATCCTGATTTTGCCCAGG
PlzA-R150KR154K-F	CCTGGGCAAATCAGAAAATTCATGAGAAAAAT
PlzA-R150KR154K-R	ATTTTTCTCATGAATTTTCTGATTTTGCCCAGG
WspRpTyb12- <i>Bsm</i> IF	GAATGCTATGCACAACCCTCATGAGAGCAAG
WspRpTyb12- <i>Eco</i> R/IR	GAATTCTCAGCCCGCCGGGGCCGG
PlzB-pMAL- <i>Bam</i> HIF	GGATCCATGGCAGTATCATCTAAAAAGATA AGAGAGTATAGAAA
PlzB-pMAL- <i>Sal</i> IR	GTCGACTCAGTCTTCAAAAAAATTAATAATT ATGGATTATCATAGTATACTCAA
BHRrp1-pMAL-F	CGGATCCATGATGAAAGGTGTGAATTGG
BHRrp1-pMAL-R	CCAAGCTTTTAATATTTAAACTGATTTCGA
BHPdeA-pMAL-F	CATGAGGGATCCATAATAGAAGTAAATTT AAAAG
BHPdeA-pMAL-R	CATGAGCTGCAGCTAATGGTGATGGTGATG GTGAATAGGTTCTGGTTTATGCC

**Primers for construction
of allelic exchange vectors**

BB0733USF	CATTTGATACAACCTTGGTTTAAAACCTG
BB0733USR	ACCGGTCTAGACGTCAGCTTCAAATTGTT TTAAACAGTTTTAC
BB0733DSF	GACGTCTCAAAGGATTGAAATTTTTCT TATGTGATTATG
BB0733DSR	ACCGGTCAGAATATATTCCCAAAGTGCCC
BB0733KIF	GACGTCTTGTTTAGTATTTTTATATTCAAAA AAAGGAGAAAAG
BB0733KIR	TATCACCCCGGGTTAATTGAAATAATCA TGGATCAACATAGTATACTC
BB0733USFPlzB	CATTTGATACAACCTTGGTTTAAAACCT
BB0733USRPlzB	TATCACACCGGTGACGTCAAACCTCTCCTTTCT CCTTTTTTT G
pflgB-aphI-T7(BB0733)KIF	GTATACTATGTTTAGCCATGATTATTTCAATTAA CTAATACCCGAGCTTCAAGG
pflgB-aphI-T7KIR	GACGTCCAGATCCGGATATAGTTCCTCCTTTC
<i>p/zBKIF</i>	GACGTCATGGCAGTATCATCTAAAAAGATA AGA GAG
<i>p/zBKIR</i>	TATCACCCCGGGTCAGTCTTCAAAAAAATTTAA ATAATTATGGATTATC
KanF	TATCACCCCGGGCTAATACCCGAGCTTCA AGGAAGA
KanR	TATCACGACGTCTTAGAAAACTCATCGAGCAT CAAATGAAAC
BH0363USF	TATAAATTATCCTAGCTGGTTAC

BH0363USR	ACCGGTGACGTCCTTATTTAAATAAATTTATA TTAATTTTG
BH0363DSF	GACGTCAAATACACAAATGTTTTTTAATAC
BH0363DSR	ACCGGTACATACAGCGGTTTTGCTTGGTG
BH0419USF	ATAATGAAATTAATCAGAAG
BH0419USR	ACCGGTGACGTCTACTTCTCTATATTACTAGC ATTC
BH0419DSF	GACGTCAGTTAAATTTTATAAGTTAAAG
BH0419DSR	ACCGGTTAGTGCTGATATTTTTACAG
BHpflgB-AacCR	AACATCGTTGCTGCTGCGTAACATATGAACA CCCTCTATATCACAAATTGCTT
BHpflgB-AacCF	ATGTTACGCAGCAGCAACGATGTT
BHpflgB-F	TATCACGACGTCGTTAAAGAAAATTGAAATAAA CTTGGACTATG
AacC-AatII-R	TATCACGACGTCTTAGGTGGCGGTACTIONTGG GTC
BHKanRAatII-R	TATCACGACGTCTTAGAAAACTCATCGAGC ATCAAATGAAAC
GentGFP-F	AGTGATGCACTTTGATATCGACCCAAGTAC CGCCACCTAAGGGCGAATTCGGCT
GentGFP-R	TTAATCTTTAGTTAGTTAGGGAATAAGCCGAAT TCGCCCTTAGGTGGCGGTACTIONTGGGTC
GFP-AatII-R	GACGTCCTATTTGTATAGTTC
KanGFPBH0363	GACAAGGATTCCTATGGCATAAACCAGAAC CTATTTAAGCTAGCGTTGATCTTATAAATC
BH0363OLR	GATTTTACATCAGTTTGATTTATAAGATCA ACGCTAGCTTAAATAGGTTCTGGTTTATGC
BH0363F	GTACATGACGTCATGAAAAATCCAAATGCA ATTG

KanGFPBH0419 AAGCTAAGATTTCTGGTCGAAATCAGTTTAAAT
ATTAAGCTAGCGTTGATCTTA

BH0419OLR ATTTTACATCAGTTTGATTTATAAGATCAACGC
TAGCTTAATATTTAAACTGATTTTCGAC

BH0419F GTACATGACGTCATGATGAAAGGTGTGATT
TTG

**Primers for screening
of allelic exchange
mutants**

BBA16F GCACAAAAAGGTGCTGAG

BBA16R CACTTGCTGATCCTTCAG

BBB19F AATAATTCAGGGAAAGATGGG

BBB19R AGGTTTTTTTTGGACTTTCTGCC

BBC10F GAACTATTTATAATAAAAAGGAGAGC

BBC10R ATCTTCTTCAAGATATTTTATTATAC

BBD21F CTACCTTAAGCGGAAATATTGC

BBD21R GAATAATTCTTCGCTCCCAAAGCTC

BBE16F ATGGGTAAAATATTATTTTTTTGGG

BBE16R AAGATTGTATTTTGGCAAAAAATTTTC

BBF20F ATGAACAAAAAATTTTCTATTTTC

BBF20R GTTGCTTTTGCAATATGAATAGG

BBG02F TCCCTAGTTCTAGTATCTACTAGACCG

BBG02R TTTTTTTTGTATGCCAATTGTATAATG

BBH28F GGCTTCAATTAAGGGAGGAG

BBH28R CACAATATAATCCGCAACATTC

BBI26F	GCAAGGACTTTGCCACATGCTG
BBI26R	CGAAATAGCACATAGATAATTCC
BBJ34F	AAATTCTATGGAAGTGATG
BBJ34R	CGAAATAGCACATAGATAATTCC
BBK19F	AAGTTTATGTTTATTATTCCG
BBK19R	ATTGTTAGGTTTTTCTTTTCC
BBL32/33F	GAAGATTTAAACAAAAAAATTGCG
BBL32/33R	GTAATCACTTCTTTTTTACCATCG
BBM32F	GACTTTACATAGTATAAATGCTTTTGG
BBM32R	TCTCGTTATTATAAAATAAGTAGG
BBN32/33F	TATCAAAAAAGTGCTGTTTTATAG
BBN32/33R	TAATCTCAAATATTCTTCTTTATG
BBO32F	GGAATGTATTAATTGATAATTCAG
BBO32R	GCGAAATAAATAGTGCCTTATGGG
BBP33F	ACGATAGGGTAATATCAAAAAAGG
BBP33R	AGTTCATCTAATAAAAATCCCGTG
BBQ47F	AAGATTGATGCAACTGGTAAAG
BBQ47R	CTGACTGTAAGTATGTATCC
BBR33F	AGATCCTCAAATAGTTTAACCAG
BBR33R	TTAATATTGGCAGAGAGTCTACAG
BBS53F	TTACGAAAAAATAGAAAAACTAGG
BBS35R	TTTCCACTGCCCACTTTTCAGCCG
LP5F	CTTGCTTTAAGCCCTATTTAC

LP5R	GCACACTACCCATTTTTGAATC
BBU21F	AGTAAAGGAGTTCTGCAAAAATT
BBU21R	GTTGTCACCTCGTGTAATATG
BB0733>1000US	CCCAATAAATCTGATATCGCATCACT
BB0733>1000DS	CCTTTAATAGTACATGTTGATACGG
Spec5'R	TCCTTGAAGCTCGGGTATTA
Spec3'F	GGCGAGATCACCAAGGTAGTC
Kan5'R	GTTTAAAAATTTTTTTCAAATCGTCTA
Kan3'F	ATCAGAATTGGTTAATTGGTTGTAACA
PlzBR	CTCAAGCGGGATATTACTCTCATC
BH0363>1000US	TTAAGGAAACAAAACATGATG
BH0363>1000DS	TATGTCTGATACGAAATATTC
BH0419>1000US	TCTGATTGGATTAGAAATGG
BH0419>1000DS	GAAAATCTAACACTAGACATGC
Gent5'R	GTAACATCGTTGCTGCTGCG
GFP3'F	CATGGCATGGATGAACTATACAAATAG
Primers for RT and qPCR	
Rrp1-QF	CGGGATCGCTTTTTAGCTTT
Rrp1-QR	TTGAGGTTGCAACAAATGGA
PlzA-QF	CTTTTGATTATGGGGATGTCTG
PlzA-QR	AAAGCAATACCAAGCGCAA
FlaB-QF	GCTCCTTCCTGTTGAACACC

FlaB-QR	TTCATGTTGGAGCAAACCAA
FlaB-QF(Tick)	GCAGCTAATGTTGCAAATCTTTTC
FlaB-QR(Tick)	TGAGCTCCTTCCTGTTGA
BB0733F-RT	CTGATAAAGCTTTTATCAAGTTTAATGGAG
BB0733R-RT	AGCGCAAAAACCTTTCCGCT
BBU_ZS7F20F-RT	TAGTATACTCAAGCGGGATATTACTC
BBU_ZS7F20R-RT	GGAATCCTTGATGAAGACATGG
BB0337F-RT	GCTTGAACCTTGATGGCACCCCTAC
BB0337R-RT	GTACGCTCCAAGATATTGATAAGG
BH0363F-RT	AACAACATCAGCGAATTAAGCGA
BH0363R-RT	TGGGAGTTCAAGTTCTTTGCTGCC
BH0419F-RT	AACTCCTCACCCACATAACGAGCA
BH0419R-RT	TCTTGGATGCAAGCCTTGGAGCAT
BH0337F-RT	TGCTTGCACTTGACGGAACTCCTA
BH0337R-RT	GTGGGCGCCGCCATTTATATTGTT

Site-directed mutagenesis

Site directed mutagenesis was conducted using a PCR approach. Firstly, mutagenic primers were designed that contained in-frame codon mutations for the purpose of generating mutant recombinant proteins. The gene of interest (*plzA*) was then amplified as two different amplicons. For the 5' end of *plzA* was amplified using a forward primer with specific restriction sites and a reverse primer which contained the desired in-frame sequence changes. The 3' end of the gene was amplified using a reverse primer (again with specific restriction sites for use in downstream cloning), and the forward primer contained the desired mutated sequence. Amplicons were produced via PCR and purified using the QIAquick Gel Extraction Kit (Qiagen) following electrophoretic analysis of the products. Following purification of both products, a second round of PCR was performed using both the 5' and 3' end products. Both mutagenic primers overlapped, in order for complementary annealing to occur during the second round of PCR, such that the desired changes could be introduced. The resulting amplicons were purified using the QIAquick Gel Extraction kit and were cloned into pCR2.1-TOPO as described below. Plasmid inserts were sequenced to verify the intended changes.

TOPO-TA Cloning

For the generation of vectors used in recombinant protein expression, as well as the generation of vectors used in allelic exchange mutagenesis, TOPO-TA cloning was performed. PCR products were amplified, analyzed by gel electrophoresis, and purified using the QIAquick Gel Extraction kit (Qiagen). Four μL of the PCR product was

aliquoted into a separate tube, 1 μ L of the provided Salt Solution (Invitrogen) was added, and lastly, 1 μ L of pCR2.1-TOPO (Invitrogen) was added. The tube was incubated at room temperature for 5 minutes, and 1 μ L was used to transform the provided One Shot® *E. coli* TOP10 cells (Invitrogen). Cells were transformed by adding 1 μ L of the TOPO-TA reaction to the prealiquoted cells (20 μ L). Cells were incubated on ice for 5 minutes, heat shocked at 42°C for 30 seconds, placed back on ice for 2 minutes, and 80 μ L SOC media was added to the cells. This was the transformation protocol used for all cell types and vectors/vector reactions. Cells were incubated at 37°C for 1 hour, and plated onto solid Luria-Bertoni (LB) plates containing ampicillin (Amp) at 50 μ g/mL and bromo-chloro-indolyl-galactopyranoside (X-gal; 40 μ L of 40 mg/mL spread on top of the plate). Plates were incubated at 37°C overnight and the resulting colonies were screened by blue/white screening and PCR. Positive colonies were grown overnight at 37°C, and vectors were harvested using the QIAprep Spin Miniprep Kit (Qiagen).

Cloning of *plzA*, *plzB*, *rrp1*, and *wspR* for protein expression

Vector pCR2.1-TOPO containing *plzA*, mutant *plzA*, *plzB*, or *rrp1* contained a *Bam*HI restriction site 5' to the open reading frame and a *Sall* restriction site 5' to the open reading frame. pCR2.1-TOPO vectors and the pMAL-c4x expression vector (New England Biolabs) were digested with *Bam*HI and *Sall* (New England Biolabs) for 60 minutes at 37°C. Additionally, pMAL-c4x was treated with calf intestine alkaline phosphatase (CIP, New England Biolabs) for an additional 60 minutes at 37°C. Proper excision of the genes from pCR2.1-TOPO and proper linearization of pMAL-c4x was

analyzed by the use of agarose gel electrophoresis and ethidium bromide staining. The excised gene products and linearized pMAL-c4x were purified using the QIAquick Gel Extraction kit (Qiagen). Inserts were ligated into pMAL-c4x using T4 DNA Ligase (New England Biolabs) and ligated vector was transformed into NovaBlue *E. coli* cells. Positive colonies were selected by PCR and propagated overnight as described above. Vector was purified using the QIAprep Spin Miniprep Kit (Qiagen) and transformed into BL21(DE3) *E. coli* cells for protein expression. Likewise, *wspR* (originally amplified from *P. aeruginosa* strain FRD-1, kindly provided by Dr. Dennis E. Ohman) was excised from pCR2.1-TOPO using *BsmI* and *EcoRI* and ligated into vector pTYB12 (New England Biolabs). The resulting vector was transformed into *E. coli* ER2566 for protein expression.

Recombinant protein expression and purification

To generate r-proteins from pMAL-c4x, BL21(DE3) *E. coli* was grown with shaking (250 rpm) at 37°C in LB broth containing 50 µg/mL Amp for approximately 2.5 hours, until an OD₆₀₀ of 0.5-0.8 was reached. Cells were shifted to 25°C and IPTG was added to a final concentration of 1 mM. Protein expression was allowed to proceed for 3 hours, at which time, cells were harvested by centrifugation (6,000 x g, 4°C, 10 minutes). Harvested cells were lysed by sonication, and supernatants were collected via centrifugation (15,000 x g, 4°C, 20 minutes). Supernatant was passed over amylose resin (New England Biolabs) to allow binding of the N-terminal mannose-binding protein (MBP) to the amylose, washed in PBS (MBP-PlzA and MBP-PlzB) or diguanylate cyclase reaction buffer (Tris (pH 7.8), 250 mM NaCl, 25 mM KCl, 10 mM MgCl₂) in the

case of MBP-Rrp1. Proteins were eluted in the appropriate buffer containing 10 mM maltose and stored at 4°C for further use.

WspR was expressed in *E. coli* ER2566 by growing the cells at 37°C to an OD₆₀₀ of 0.3 and was induced with 0.3 mM IPTG at 18°C overnight. Cells were collected by centrifugation as described above, lysed by sonication and protein was purified using chitin affinity chromatography. Intein cleavage by dithiothreitol (DTT, 50 mM) was allowed to proceed for 48 hours at 4°C, and protein was eluted with reaction buffer (75 mM Tris, pH 7.8, 250 mM NaCl, 25 mM KCl, 10mM MgCl₂). Protein was dialyzed over diguanylate cyclase reaction buffer containing 40% glycerol and was also stored at 4°C for further use.

Expression and purification of r-PdeA (BH0363)

pdeA (amino acids 386-663) was amplified by PCR and cloned into pMAL-c4x (New England Biolabs) using restriction sites engineered into cloning primers (Table 3). Additionally, BH0363 was tagged C-terminally with sequence encoding for a 6xHis tag by including sequence encoding for the His tag in the antisense primer. Protein expression from *E. coli* BL21(DE3) was carried out as described above. Cells were lysed by sonication, soluble fractions were collected by centrifugation, and recombinant protein was purified using nickel affinity chromatography using a Ni-NTA column (GE Life Sciences) on an AKTApurifier (GE Life Sciences). Protein purification was confirmed by staining with Coomassie and by western blotting. Protein was dialyzed overnight in PDE buffer (75 mM Tris pH 8.0, 250 mM NaCl, 25 mM KCl, 10 mM MgCl₂, 30% glycerol) and concentrations were determined using the BCA assay (Pierce).

Synthesis of c-di-GMP and [³²P]c-di-GMP

r-WspR and r-Rrp1 were used to generate radiolabeled and cold c-di-GMP. The r-Rrp1 (both *B. burgdorferi* and *B. hermsii* Rrp1) and r-WspR (5 mM) were incubated with 25 mM acetyl phosphate (37°C for 30 minutes) to potentially activate the proteins. To generate cold c-di-GMP, GTP was added to each reaction at a final concentration of 150 mM (37°C; 60 minutes). To generate radiolabeled c-di-GMP, the reactions were spiked with [α -³²P]GTP (0.33 mM). The production and purity of the c-di-GMP was assessed using HPLC. GTP (Sigma-Aldrich) and unlabeled c-di-GMP (Biolog) served as standards. HPLC was performed essentially as described by Ryjenkov *et al.* (132). Briefly, the samples were boiled, filtered (Ultrafree centrifugal filters; Millipore), applied to a 15 x 4.6 cm Supelcosil LC-18-T column (Supelco) and separated on an AKTApurifier (GE Health Sciences) by reverse-phase HPLC. The gradient system utilized buffers A (100 mM KH₂PO₄, 4 mM tetrabutyl ammonium hydrogen sulfate, pH 5.9) and B (75% buffer A, 25% methanol). The protocol utilized is as follows (in the format of minutes transpired; % buffer B): 0.0, 0; 2.5, 0; 5.0, 30; 10.0, 60; 14.0, 100; 21.0, 100; 22.0, 50; and 23.0, 0 at a flow rate of 700 μ L/minute. Nucleotides were detected at a wavelength of 254 nm.

PdeA phosphodiesterase assays

Phosphodiesterase assays were carried out essentially as described by Sultan, *et al* (160, 163). Radiolabeled c-di-GMP was synthesized using *B. hermsii* Rrp1 as described above, and was subsequently treated with 1 unit of calf intestine alkaline phosphatase (CIP; New England Biolabs) to hydrolyze any remaining GTP. Reactions

were boiled for 3 minutes, and filtered through Ultrafree centrifugal filters (Millipore). The resulting [³²P]c-di-GMP (~6 nM) was added to 2 µg of PdeA (in the presence or absence of 50 mM MnCl₂). Snake venom phosphodiesterase (SVPD; 0.3 units) served as a positive control, and r-PlzA served as a negative control. Reactions were carried out for 1 hour at room temperature, and time points were taken at 0, 15, 30, 45, and 60 minutes. Reactions were stopped by spotting 0.5 µL onto PEI-cellulose plates (Selecto). Plates were developed in 1:1.5 (v/v) 4M H₄SO₄ and 1.5 M KH₂PO₄, pH 3.60, air-dried, and exposed to X-ray film overnight at room temperature.

Analysis of c-di-GMP binding to wild type and site-directed substitution mutants of PlzA and PlzB

r-PlzA, site-directed substitution mutants (R150D,R154D and R150K,R154K), r-PlzB and control proteins were tested for c-di-GMP binding. The r-proteins (0.25 mg) (including Rrp1 and a MBP-tagged negative control protein) were spotted onto nitrocellulose and allowed to air dry. The membranes were incubated with [³²P]c-di-GMP (2 nM) alone, or in combination with 750 nM of GTP, GMP, ATP, cGMP, or cAMP (PBS with 1% milk; 2h; room temperature). The membranes were washed three times for 5 min in PBS at room temperature and exposed to film overnight.

Preparation and analysis of *B. burgdorferi*/*B. hermsii* RNA from cultures and from *I. scapularis* ticks infected with *B. burgdorferi*

To assess expression of genes from *in vitro* cultures, RNA was isolated from *Borrelia* cultures using the RNeasy Midi kit as described by the manufacturer (Qiagen)

and treated with DNase I (Invitrogen). cDNA was generated using the Superscript III First Strand cDNA Synthesis kit (Invitrogen), 50 ng of random hexamer primers and 1 µg of total RNA. RT-PCR was performed with SYBR green PCR Master Mix (Applied Biosystems) with primers listed in Table 3. The following cycle parameters were used: one cycle of 10 min at 95°C followed by 40 cycles of 10 s at 94°C, 30 s at 50°C and 30 s at 72°C. Melting curves were generated over the temperature range 45–95°C to assess amplification specificity. All reactions were run in triplicate with three biological replicates and the data were normalized against enolase (*eno*). Statistical analyses were performed using a paired, two-tailed *t*-test. Alterations of gene expression were considered significant if $P < 0.05$.

To allow for the analysis of specific *B. burgdorferi* transcript levels in *Ixodes scapularis* ticks, it was first necessary to infect mice so that naïve ticks could be infected by natural feeding. Mice (C3H/HeJ; Jackson labs) were inoculated with *B. burgdorferi* B31 5A4 (10^4 cells; subcutaneous) and infection was confirmed by culture of ear biopsies and by serology. The naïve larval ticks, provided by Dr. Durland Fish (Yale University), were placed on infected mice (150–200 per mouse) and fed to repletion (48–96 h). The ticks were collected and maintained for 8-10 weeks in desiccator chambers (21°C; 100% humidity) until molting to the nymphal stage. Two weeks post-molt, pools of 100 infected flat nymphs were used for RNA isolation. The remaining infected flat nymphs (~30) were placed on naïve, uninfected C3H/HeJ mice and fed to repletion. All mice became infected as confirmed by culture positivity of ear tissues. To isolate RNA, 100 flat nymphs or 30 fed nymphs were crushed in glass homogenizers containing 1mL of TRizol reagent (Invitrogen) and debris was removed by centrifugation

(300 x g). Supernatants were used for RNA isolation according to the manufacturer's instructions (Invitrogen). To remove contaminating genomic DNA, RNA samples were treated twice with RNase-free DNase using the Ambion DNA free kit.

Preparation of RNA from the organs and tissues of mice infected with *B.*

burgdorferi

Mice were infected as described above with *B. burgdorferi* B31-5A4 (a clonal derivative of B31 kindly provided by Jon Skare, Texas A&M). Note that for logistical reasons a separate pool of mice were used for these analyses than those described above. Mice were sacrificed at 2, 4, 6 and 13 weeks (five mice per time point) and the urinary bladders were collected and prepared for RNA analyses. RNA was isolated as described previously (125).

Real-time quantitative reverse transcriptase-PCR (qRT-PCR) of RNA isolated from animal tissue

Total RNA isolated from ticks or from urinary bladders of infected mice was reverse transcribed using 10U AMV reverse transcriptase and random hexamers as described by the supplier (Promega). The cDNA was used as template for qPCR with gene-specific primers (designed using PRIMER EXPRESS software, version 2.0; Applied Biosystems) as described previously (124, 125). All primers are listed in Table 3. Duplicate or triplicate assays were carried out with each RNA sample and were performed with RNA obtained from two separate pools of flat nymphs, three separate pools of fed nymphs or with RNA from murine bladders. qPCR data were normalized

against *flaB* transcript levels. To verify the purity of the PCR product, melting curve analyses were performed and a no-template negative reaction control was included. The statistical significance of observed expression differences between flat and fed nymphs was evaluated by an unpaired t-test with two-tailed P-values and 95% confidence interval using GRAPHPAD PRISM software (v 5.0) (La Jolla, CA).

Allelic exchange mutagenesis

Allelic exchange mutagenesis was carried out using protocols first described by Samuels *et al* (137). In brief, separate PCR reactions were prepared to amplify the upstream and downstream regions of *plzA* (1000 bp on each side), and the resulting products were cloned into pCR2.1-TOPO. The primers used to generate pCR2.1-upstream and pCR2.1-downstream contained restriction sites to facilitate the following cloning steps (Table 3). pCR2.1-upstream and pCR2.1-downstream were digested with *AatII* and *AgeI*, and the excised fragment from pCR2.1-downstream was ligated into pCR2.1-upstream to create pCR2.1-up/down. Next, to generate the vector for deletion of *plzA*, we excised the spectinomycin/streptomycin resistance cassette derived from pKFSSI-*AatII* and it was inserted in between the up and downstream fragments at an *AatII* site to generate p Δ *plzA*. To create the vector used for generation of our complementation mutant, we carried out overlap-extension PCR to fuse *plzA* with a kanamycin resistance cassette derived from pBSV2. This product was cloned into the *AatII* site in the pCR2.1-up/down vector to create *pplzA*-KI. Next PCR was carried out to amplify *BbuCA12plzB* and *pflgB-kanR* in which the sense primer contained an *XmaI* site and anti-sense primer contained an *AatII* restriction site for downstream cloning.

The resulting PCR products were cloned into pCR2.1-TOPO, and digested with *XmaI* and *AatII*, which was also used to digest pCR2.1-up/down. The excised band was ligated into pCR2.1-up/down to create *pplzB-KI*. *pΔpIzA*, *pplzA-KI*, and *pplzB-KI* were propagated in NovaBlue *E. coli* (Invitrogen), purified, linearized with *ScaI*, and electroporated into *B. burgdorferi* clone 5A4. Clonal populations were obtained by subsurface plating and plasmid content was assessed by PCR using plasmid specific primers. The resulting clones were screened by PCR for correct insertion, and mutants were sequenced to ensure proper crossover.

To generate vectors for deletion and complementation of *pdeA* and *rrp1* of *B. hermsii* DAH, identical strategies were utilized. In brief, 1000 base pairs upstream and 1000 base pairs downstream of the coding regions of BH0363 and BH0419 were PCR amplified. The resulting products were cloned into pCR2.1-TOPO vector (Invitrogen). The plasmids containing the downstream fragments were purified, digested (*AatIII/AgeI*), and ligated into pre-digested plasmid (*AatIII/AgeI*) containing the upstream fragments. This created 2 plasmids that contain the 1000 bps upstream and downstream of BH0363 and BH0419, separated by an *AatII* site. The *pflgB-kanR-gfp* cassette was used to create a *pflgB::gentR-gfp* flanked by *AatII* sites. The *AatII* containing amplicon was digested with *AatII* and ligated into the pCR2.1-up/down plasmids, creating the deletion vectors (*pΔBH0363* and *pΔBH0419*). Complementation vectors were created using overlap-extension PCR to fuse the *pflgB::kanR-gfp* cassette to the coding regions for both BH0363 and BH0419. This method produced *AatII* flanked regions that contain the respective coding sequence followed by *pflgB::kanR-gfp*. The resulting fragments were cloned into pCR2.1 TOPO vector (Invitrogen). Subsequent *AatII* digestion and

ligation into the pCR2.1-up/down vectors created the complementation vectors (pBH0363-KI and pBH0419-KI). The resulting plasmids were propagated in NovaBlue *E. coli* (Invitrogen), purified, linearized with *ScaI*, and electroporated into *B. hermsii* DAH to create the *BhDAHΔrrp1* and *BhDAHΔpdeA* deletion strains, and the *BhDAHrrp1::kanR* and *BhDAHpdeA::kanR* complementation strains.

B. hermsii electroporation was carried out as described in Fine, *et al* (53). Limiting dilutions were used to obtain clonal *B. hermsii* cultures as described in Hofmeister *et al.* (72). In brief, the dilutions were carried out in 96 ELISA plates, which were covered to prevent BSK-H evaporation. Growth was assessed at 5, 10 and 15 days post-dilution. Potential positive clones were inoculated into fresh media and confirmed later by change in the media indicator from red to yellow.

Pulsed-field gel electrophoresis (PFGE)

For analysis of *B. hermsii* plasmid content following electroporation, PFGE was performed. First, plugs were generated by pelleting 2×10^8 bacterial cells via centrifugation (6,000 x g, 15 minutes, 4°C), and resuspending the pellet in 500 μL of TN buffer (50 mM Tris HCl pH 8.0, 150 mM NaCl). The suspension was mixed with an equal volume of 1.4% low melting temperature InCert agarose (Lonza) at 50°C. The resulting mixture was transferred to a plug caster for solidification. Plugs were treated overnight with proteinase K (1 mg/mL) at 45°C in 50 mM Tris HCl pH 8.0, 50 mM EDTA, 1.5% SDS. Plugs were inserted into a 1% pulsed-field gel (Seakem Gold; Lonza) made with 0.5x Tris-boric acid-EDTA buffer (TBE), sealed with 0.7% low melting point agarose, and full genomic content was separated using a BioRad contour-clamped

homogenous electric field (CHEF) mapper system in 0.5 x TBE. Plasmid content was analyzed following staining in ethidium bromide by visualization on a UV light box.

Mutant growth rate analysis.

Growth rates of *Borrelia* stains were assessed by inoculation of BSK-H with equal numbers of early log phase spirochetes (1 spirochete/40x field). The cultures were grown at 25, 33, and 37°C. Cells were enumerated daily until they reached their respective maximum densities, as determined by dark-field microscopy. Each day, 10 fields of 40x magnification were used to determine the average spirochetes per field. Assays were performed in triplicate.

Motility analysis

Motility in BSK-H complete media with 1% methylcellulose was examined using differential interference contrast (DIC) microscopy. Movies of spirochetes were recording using time-lapse photography and were analyzed using Slidebook 5 motion-tracking software (Intelligent Imaging Innovations). Measurements of velocity were calculated using 20 motion-course tracks per strain. Microscopy was performed at the Virginia Commonwealth University Department of Anatomy and Neurobiology Core Microscopy Facility.

Swarming motility analysis assays

Swarming motility assays were carried out as described in Motaleb *et al.* (102). Briefly, 5×10^5 spirochetes in 5 μ L of a 1:10 dilution of BSK-H in dPBS were pipetted onto

agarose plates containing 0.35% (wt/vol) Seakem GTG agarose in BSK-H. The plates were incubated at 33°C (*B. burgdorferi* mutants) or 37°C (*B. hermsii* mutants). Swarm diameters were measured at 2, 4, and 6 days using electronic calipers. Assays were performed in triplicate and representative swarms were photographed at each time point.

Capillary chemotaxis assays

Capillary chemotaxis assays were performed using a modified version of the protocol from Motaleb, *et al* (90). In brief, cells were harvested by centrifugation and resuspended in motility buffer containing 1% (wt/vol) BSA and 1% (wt/vol) methylcellulose at 10^7 cells/ml. The cells were then aliquoted into the wells of a 96 well plate. Capillary tubes were filled with motility buffer with or without chemoattractant (0.1 M N-acetyl-D-glucosamine) and were capped at one end with Critoseal (Leica). The open ends of the capillary tubes were inserted into the wells and the plates were incubated at 37° for 2h. Following the incubation, the contents of the capillary tubes were expelled into microcentrifuge tubes, and dark-field microscopy was used to determine the number of spirochetes per field. Assays were performed in triplicate.

Lyme disease model of murine infection

Numbers of *B. burgdorferi* 5A4 and mutant strains were enumerated by counting ten 40x fields via dark-field microscopy. Cells were pelleted by centrifugation (6,000 x g, 15 minutes, 4°C), and resuspended in BSK-H such that the final volume contained 1×10^4 cells/100 μ L. C3H/HeJ (Jackson Laboratories) mice were injected with 1×10^4 cells

subcutaneously. Infection was allowed to proceed for 4 weeks at which time serum was collected, mice were sacrificed, and the heart, ear, and urinary bladders were harvested to assess outgrowth of spirochetes in BSK-H growth media containing 1x *Borrelia* Antibiotic Cocktail (20 µg/ml phosphomycin, 50 µg/ml rifampicin and 2.5 µg/ml amphotericin B) (Sigma Aldrich). Outgrowth was assessed at 2 and 4 weeks post-sacrifice. Serum was used for western blots and ELISA assays to assess seroconversion as described below.

Tick studies

Ixodes scapularis ticks (naïve larval-stage; Oklahoma State University Tick Rearing Facility) were brushed onto mice 4 weeks post-inoculation with the *B. burgdorferi* strains described above and used in these studies. Ticks were fed until repletion, were collected, and DNA was isolated using the DNeasy Blood and Tissue kit (Qiagen). qPCR was performed using a *B. burgdorferi flaB* specific primers and data was normalized versus tick rDNA using RIB-3 and RIB-4 primers. To assess strain survival in larval ticks, naïve *I. scapularis* ticks were submerged in *B. burgdorferi* cultures (10^8 cells/mL; 33°C; 2 h), washed, allowed to dry for one week and then fed to repletion on naïve mice. One week after the ticks dropped off, DNA was isolated and analyzed by qPCR as described above.

Relapsing fever model of murine infection

Infectivity of the various *B. hermsii* strains was assessed by dark field microscopy of blood collected from infected C3H/HeJ mice, and seroconversion analysis by western

blot and ELISA. Mice (n=3) were subcutaneously needle inoculated between the shoulder blades with 1×10^4 spirochetes in BSK-H as described for *B. burgdorferi* and mutants. A single microliter of blood was collected by tail snip from the mice at day 3 post-infection and for 12 days thereafter. Blood was diluted 1:20 in PBS each day, and cells were enumerated via the counting of ten 40x fields by darkfield microscopy. Total numbers of spirochetes/mL was calculated and plotted over a time course to show levels of spirochetemia.

Sodium dodecyl sulphate-polyacrylamide gel electrophoresis (SDS-PAGE) and immunoblotting (western blotting)

To assess expression of r-proteins, purification of r-proteins, and to separate *Borrelia* whole cell lysates, SDS-PAGE was performed. In brief, samples were separated on 15% Criterion Precast Gels (Bio-Rad) by SDS-PAGE, and blotted onto polyvinylidene difluoride (PVDF) membranes (Millipore). Expression and purification of recombinant proteins was assessed using polyclonal rabbit anti-MBP IgG (1:2,000; New England Biolabs) which recognizes all r-proteins used in these studies (with the exception of WspR, in which expression was analyzed using staining with Coomassie R-250, and subsequent destaining). Detection of bound antibody was performed using goat anti-rabbit IgG-horseradish peroxidase (HRP) conjugated antibody (1:40,000).

In order to assess seroconversion of mice infected with *B. burgdorferi* 5A4 and mutants and *B. hermsii* DAH and mutants, *Borrelia* whole cell lysates blotted onto PVDF were screened with antisera at a 1:1,000 dilution. Secondary detection was achieved using HRP-conjugated goat anti-mouse IgG. Dilution was performed in 5% milk in PBS-

T (1x PBS, 0.2% Tween-20). Washes in PBS-T were performed between all detection steps, and detection was achieved using chemiluminescent substrate (Super Signal West Pico; Pierce) and exposure to X-ray film.

ELISA and seroconversion

To assess seroconversion by ELISA, *Borrelia* cells at a concentration of $OD_{600}=0.1$ per 100 μ L of carbonate buffer (pH 9.6; overnight; 4°C) were coated onto to well surface of 96 well plates. Plates were subsequently blocked with 1% BSA in PBS-T and serial dilutions of antiserum were performed, beginning at 1:50 and following with subsequent 1:3 dilutions of each concentration. Plates were incubated for 1 hour at room temperature with shaking during all screening steps. Plates were washed three times using a plate washer, and bound IgG was detected using peroxidase-conjugated goat-anti-mouse IgG antiserum (1:20,000). Following subsequent washes, ABTS chromagen was added, incubated for 10 minutes at room temperature, and plates were read at a wavelength of 405 nm. Measurements from duplicate samples were averaged, plotted on a \log_{10} scale, and titers were determined using a 50% maximum cut-off. Infection was defined as a log IgG titer greater than 2.0.

Determination of intracellular c-di-GMP concentration

B. hermsii cultures grown in BSK-H complete medium at 37°C (50 mL), were collected by centrifugation, and resuspended in 0.35 mL 0.4 M ice-cold $HClO_4$. Cells were lysed by sonication and centrifuged at 16,000 x g for 3 minutes at 4°C to remove cellular debris. Supernatants were neutralized with 0.16 M K_2CO_3 , kept on ice for 10

minutes, and centrifuged at 16,000 x g for 3 min at 4°C prior to injection into the HPLC system. Neutralized supernatants of the Δ BH0363 mutant were divided into two identical samples. To one sample (spiked sample), 20 pmol of c-di-GMP was added. HPLC separation was performed as described in by Antoniani, *et al.* (5).

Chapter 3: Identification and molecular characterization of a cyclic-di-GMP effector protein, PlzA (BB0733): evidence for the existence of a functional cyclic-di-GMP regulatory network in *Borrelia burgdorferi*

Analysis of the distribution of PlzA among pathogenic *Borrelia* species.

B. burgdorferi B31 possesses a single ORF (BB0733) that encodes a protein with a PilZ domain. The consensus sequence for PilZ domains is RxxxR...D/NzSxxG with x being any amino acid and z being any hydrophobic residue (3, 126, 134). PCR analyses of a panel of Lyme disease isolates previously shown to carry *rrp1* (125) revealed that all harbor BB0733 (Figure 5)(Freedman, *et al.* 2009)(58). We have designated this ORF as *plzA*. Other species of the *B. burgdorferi* sensu lato complex and the relapsing fever spirochetes also possess a chromosomally-encoded PlzA ortholog. Analysis of several recently released *B. burgdorferi* sensu lato complex genome sequences indicate that some isolates possess a second gene encoding a PilZ domain-containing protein that is present on plasmids of the lp28 group (<http://cmr.icvi.org>). Identity and similarity values for the PilZ domain-containing proteins of the *Borrelia* are indicated in Table 4 and

Figure 5. Distribution of PlzA in pathogenic *Borrelia* spp. The distribution of the *plzA* gene in *Borrelia burgdorferi*, *Borrelia garinii*, and *Borrelia afzelii* was assessed by PCR using full-length primers, and products were visualized by ethidium bromide staining and UV detection. Strain and species designations are indicated on the top, and ORF is indicated on the right.

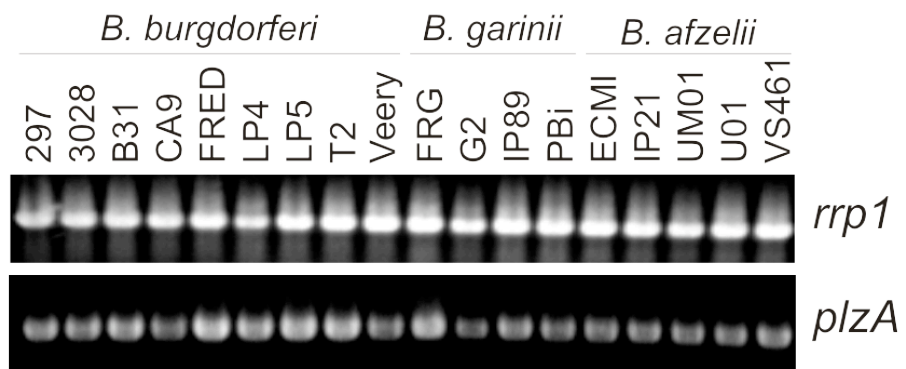

Table 4. Similarity and identity values for PlzA from *Borrelia* species

	1	2	3	4	5	6	7	8	9	10	11	12	13	14	15
1 <i>Bb</i> B31		99.6	99.6	94.3	92.0	92.0	62.8	64.4	64.4	91.6	92.0	64.5	64.9	68.2	68.6
2 <i>Bb</i> 94a	99.6		99.2	93.9	92.0	92.0	62.8	64.0	64.0	92.0	91.6	64.5	64.9	68.2	68.6
3 <i>Bb</i> 118a	99.6	99.2		93.9	91.6	91.6	62.5	64.0	64.0	91.2	91.6	64.1	64.5	67.8	68.2
4 <i>Ba</i> Pko	97.7	97.3	97.3		96.2	95.8	65.1	64.8	64.8	94.6	95.4	65.6	66.0	69.0	69.0
5 <i>Bg</i> PBi	96.6	96.2	96.2	97.7		98.9	65.4	63.7	63.7	94.3	94.3	66.5	66.9	68.6	69.0
6 <i>Bg</i> PBr	95.8	95.4	95.4	96.9	99.2		65.8	63.7	63.7	94.3	94.3	66.2	66.5	69.0	69.3
7 <i>Bg</i> PBr (lp28-1)	82.2	81.8	81.8	82.9	82.9	82.9		58.1	58.1	65.1	66.5	52.9	53.3	50.9	53.2
8 <i>Bb</i> 156a (lp28-5)	80.5	80.1	80.1	82.3	80.8	80.1	78.4		99.6	64.0	64.0	53.2	53.6	53.0	51.9
9 <i>Bb</i> ZS7 (lp28-1)	80.5	80.1	80.1	82.3	80.8	80.1	78.8	99.6		64.0	64.0	53.2	53.6	53.0	51.9
10 <i>Bs</i> A14S	96.6	96.9	96.2	97.7	97.3	96.9	82.5	80.1	80.1		93.9	64.5	64.9	68.6	68.2
11 <i>Bv</i> VS116	96.9	96.6	96.6	97.3	97.3	96.9	83.3	81.6	81.6	96.9		64.9	65.3	68.2	69.3
12 <i>Br</i> A1	83.6	83.6	83.2	84.7	85.9	85.9	77.3	74.8	74.8	85.1	84.4		99.6	80.5	79.0
13 <i>Bd</i> Ly	84.0	84.0	83.6	85.1	86.3	86.3	77.7	75.2	75.2	85.5	84.7	99.6		80.9	79.4
14 <i>Bt</i> 91E135	84.3	84.3	83.9	84.7	84.3	84.3	74.7	73.7	73.7	83.9	83.9	92.0	92.4		90.0
15 <i>Bh</i> DAH	83.9	83.5	83.5	84.7	83.9	83.9	75.1	74.4	74.4	83.1	83.9	93.1	93.5	96.2	

Identity is indicated on the top, similarity is indicated on the bottom.

relationships to one another are displayed in the phylogenetic tree presented in Figure 6. An alignment of PilZ domain amino acid sequences with the PilZ domain residues indicated is presented in Figure 7. To establish a workable nomenclature for the PilZ domain-containing proteins of the *Borrelia*, gene/protein designations were assigned based on phylogenetic relationships using nomenclature guidelines recommended by the American Society for Microbiology (see Instructions for authors pertaining to journal submissions). The chromosomal and plasmid-encoded PilZ proteins of *B. burgdorferi* sensu lato complex isolates are designated as PlzA and PlzB, respectively. The PilZ domain-containing proteins of the relapsing fever spirochetes are designated as PlzC. The universal distribution of Rrp1 and PilZ domain-containing proteins among the *Borrelia* supports the existence of a functional c-di-GMP regulatory network in all *Borrelia* species.

Transcriptional analysis of *plzA* during *in vitro* cultivation, in ticks, and in infected C3H/HeJ mice.

To determine if *plzA* is transcriptionally active during *in vitro* cultivation, in ticks and in mammals, expression was assessed using qRT-PCR. Focusing first on *in vitro* analyses, expression was determined to be constitutive and not influenced by temperature (Figure 8A). The constitutive expression reported here is consistent with earlier microarray analyses (22, 107, 123). *plzA* expression was also assessed and detected in flat and fed infected nymphal ticks. Expression was significantly upregulated upon feeding (Figure 8B) ($p=0.0165$).

Figure 6. Phylogenetic analysis of PlzA in pathogenic *Borrelia spp.* A neighbor-joining phylogenetic tree is presented in to show the phylogeny of PlzA in *B. burgdorferi*, *B. garinii*, and *B. afzelii*. The scale represents distance as the number of amino acid changes per 100 amino acids. PlzB is included in the tree and is indicated by the designation of its location on plasmids of the lp28 group.

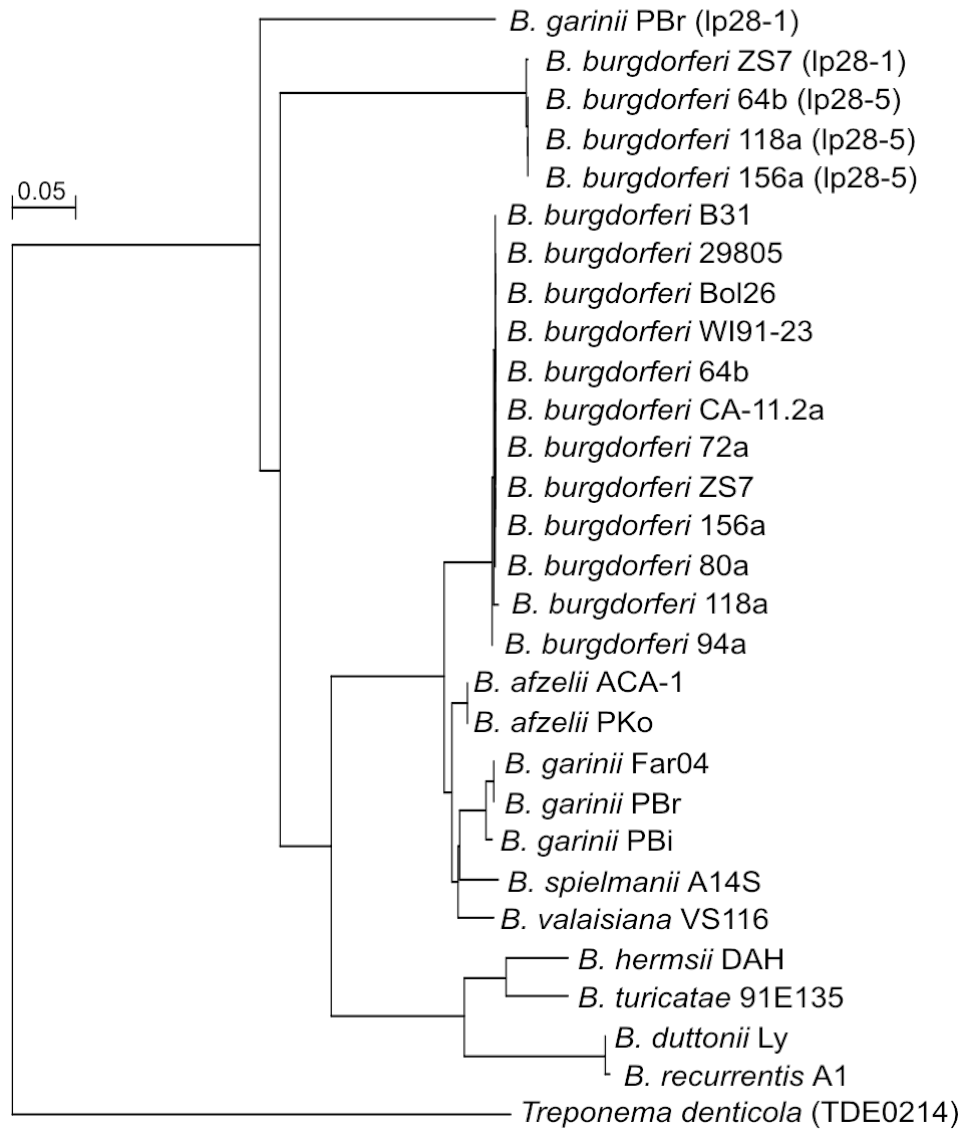

Figure 7. Consensus analysis of PlzA in pathogenic *Borrelia* spp. Consensus is presented in to show the sequence homology of PlzA in *B. burgdorferi*, *B. garinii*, and *B. afzelii*. The scale represents distance as the number of amino acid changes per 100 amino acids.

As a control for transcriptional transitions that occur in *B. burgdorferi* upon exposure to the bloodmeal, we also determined the expression levels of the *ospC* gene. As expected a dramatic increase in *ospC* transcript levels was observed upon feeding (data not shown). To determine if *plzA* and *rrp1* are produced by spirochetes during murine infection, urinary bladders were harvested from infected mice at 2, 4, 6 or 13 weeks. The urinary bladder has been demonstrated to be the most consistent organ for the detection of spirochetes (139), and hence transcriptional analyses were focused on RNA extracted from this organ. Detection of the *flaB* transcript served as the positive control for the detection of spirochetal RNA. Both *plzA* and *rrp1* mRNA was detected in the bladder at 2 weeks (Figure 8C) with transcript also detected at week 13 (the last time point to be tested). In summary it can be concluded that *plzA* expression is constitutive *in vitro*, is upregulated by the bloodmeal, and its expression is maintained throughout the enzootic cycle. The expression patterns for *plzB* and *plzC* remain to be determined.

Synthesis of c-di-GMP using recombinant diguanylate cyclases derived from *B. burgdorferi* and *P. aeruginosa*.

To allow for the assessment of c-di-GMP binding to PlzA, c-di-GMP was produced using *B. burgdorferi* Rrp1 or *P. aeruginosa* WspR. C-di-GMP production by WspR was phosphate-independent, while synthesis from Rrp1 was determined to be phosphate-dependent (Figure 9; note that due to minor differences in the HPLC protocols used during the analysis of c-di-GMP

Figure 8. *In vitro* and *in vivo* transcriptional analyses of *rrp1* and *plzA*. (a) *Borrelia burgdorferi* B31 grown at 23, 33, and 37°C were assessed for *rrp1* and *plzA* expression using qRT-PCR as detailed in the text. In all panels, the number of *rrp1* or *plzA* transcripts is presented as the number of copies per 100 copies of *flaB*. (b) The results of qRT-PCR analysis of *rrp1* and *plzA* in flat or fed nymphal ticks. Note that the *rrp1* data in (b) are derived from an earlier analysis (125) and is included solely for comparative reference. The absence of error bars for that specific set of data was due to the limited amount of RNA that was available for analysis. (c) The results of qRT-PCR analysis of *rrp1* and *plzA* in the bladders of infected C3H/HeJ mice after 2, 4, 6 or 13 weeks of infection. pi, postinfection.

A

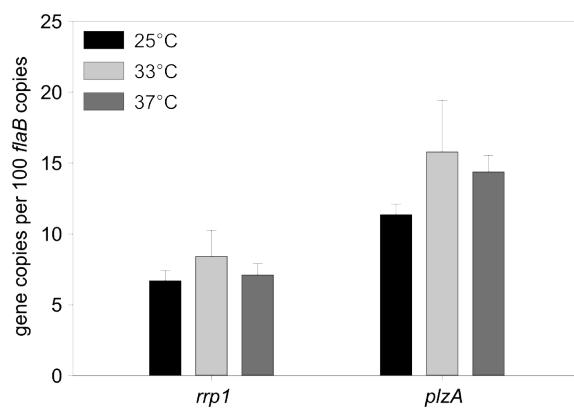

B

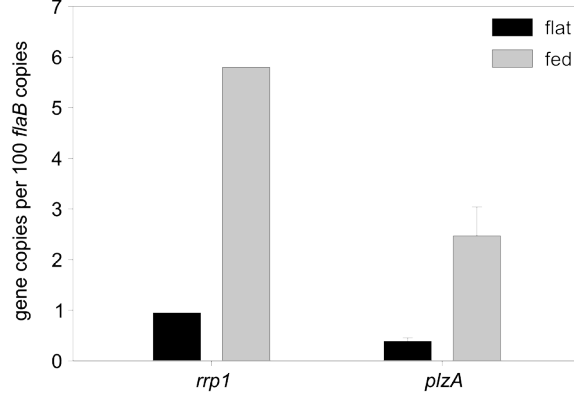

C

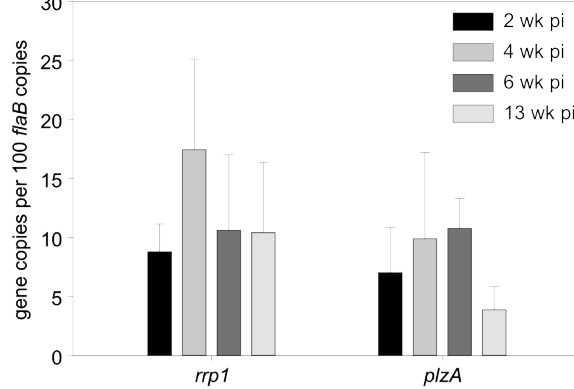

production by Rrp1, there are slight differences in retention time). These findings are consistent with earlier reports regarding the phosphate activation requirements of these DGCs (44, 135). Both WspR and phosphate activated Rrp1 efficiently converted GTP to c-di-GMP with no significant nucleotide contaminants or residual GTP evident in the c-di-GMP preparations (as determined by HPLC; Figure 9). The fractions containing the c-di-GMP were pooled and employed in the analyses below.

Generation of r-PlzA and r-PlzA site-directed mutants and analysis of their c-di-GMP binding ability.

It has been demonstrated that R residues within the RxxxR...D/NzSxxG PilZ domain are critical determinants for c-di-GMP binding (38, 101, 134). To gain further insight into the determinants required for c-di-GMP binding by PlzA and to verify that the interaction of PlzA with c-di-GMP is specific, wild type and double substitution mutants (R150D,R154D and R150K,R154K) were tested for their ability to bind [³²P]c-di-GMP. While strong binding of [³²P]c-di-GMP was observed with wild type PlzA, no significant binding of [³²P]c-di-GMP to the mutant proteins (or negative control) was observed. The complete loss of [³²P]c-di-GMP binding by the RxxxR site-directed mutants demonstrates the absolute requirement for these residues of the PilZ domain in the interaction between PlzA and c-di-GMP and demonstrates that the interaction of c-di-GMP with PlzA is specific. Note that no binding of [^α-³²P]GTP was observed to any of the proteins.

Figure 9. HPLC analysis of c-di-GMP synthesis by r-WspR and r-Rrp1. The ability of r-WspR (panel a) and r-Rrp1 (panel b) to produce c-di-GMP was assessed using HPLC. The top graph demonstrates the retention time of GTP with no protein added. This control is presented for both WspR and Rrp1 since slightly different solvent conditions were used with each protein. r-WspR and r-Rrp1 were incubated with or without acetyl phosphate (+AcP or -AcP, as indicated in the figure) before the addition of GTP to assess the dependence of c-di-GMP production on phosphate activation. The r-proteins were then incubated with GTP and the nucleotide products were analyzed by HPLC as detailed in the text. Note that the slight differences in the retention times for c-di-GMP generated with r-Rrp1 and r-WspR are the result of slight differences in solvent conditions for each run.

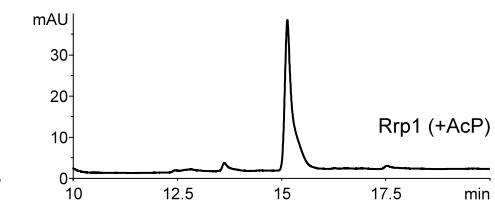
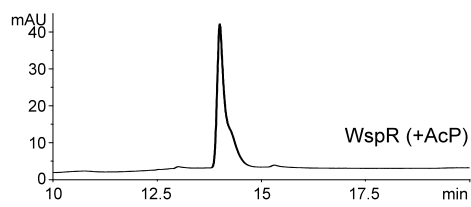
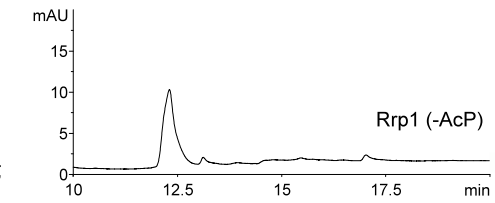
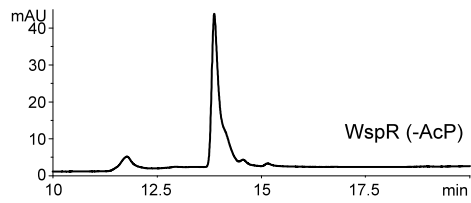
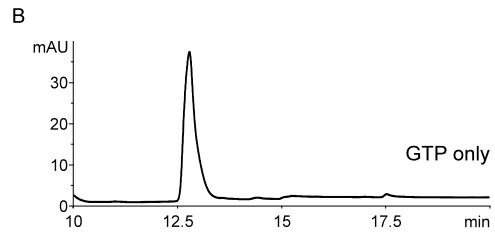
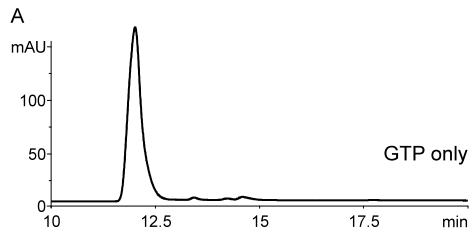

demonstrating that the interaction is specific for c-di-GMP. In summary, these data represent the first direct demonstration of c-di-GMP binding to a spirochetal protein and support the hypothesis that PlzA is a functional component of the c-di-GMP regulatory network (Figure 10).

Discussion

Recently, c-di-GMP has come to the forefront of study of the prokaryotic kingdom, as a major regulator of cellular processes (reviewed in (41, 69)). While DGC, PDE, and PilZ domain-containing proteins are widely distributed amongst the eubacteria, many remain uncharacterized. For example, among the spirochetes, only a single DGC has been partially characterized, and there are only limited published analyses of PDE or PilZ proteins (80, 116, 125, 135, 159, 160). In several organisms such as *Vibrio cholera*, *Shewanella oneidensis*, and *Escherichia coli*, the analysis of specific proteins of the c-di-GMP regulatory network, with regards to bacterial physiology, is complicated by the functional redundancy of their output domains (91, 164). *Borrelia spp.* serve as an ideal model system for studying c-di-GMP, due to the fact that they only encode one DGC (BB0419 - Rrp1), two PDEs (BB0363 - PdeA and BB0374 - PdeB) and one PilZ domain-containing protein (BB0733 - PlzA) (28, 68, 80, 116, 125, 159, 160). The major goals of this study were to determine if PlzA is universally encoded amongst *B. burgdorferi* sensu lato complex isolates from diverse geographical and enzootic niches, transcribed during specific phases of the Lyme disease enzootic cycle, and if it has potential to serve as a downstream effector protein

Figure 10. C-di-GMP binds to PlzA of *Borrelia burgdorferi* with high specificity. R-PlzA, r-PlzA mutants R150D,R154D and R150K,R154K, and r-Rrp1 were expressed as N-terminal MBP fusions and were assessed for their ability to bind to [³²P]c-di-GMP. The r-proteins used in the analyses are designated across the top of the panels. The ratio of competing nucleotide to [³²P]c-di-GMP is indicated to the right (no competitor was added in the top panel). The second panel from the bottom was screened with [α -³²P]GTP alone (with no c-di-GMP added) and the bottom panel is a Western blot using anti-MBP antibody.

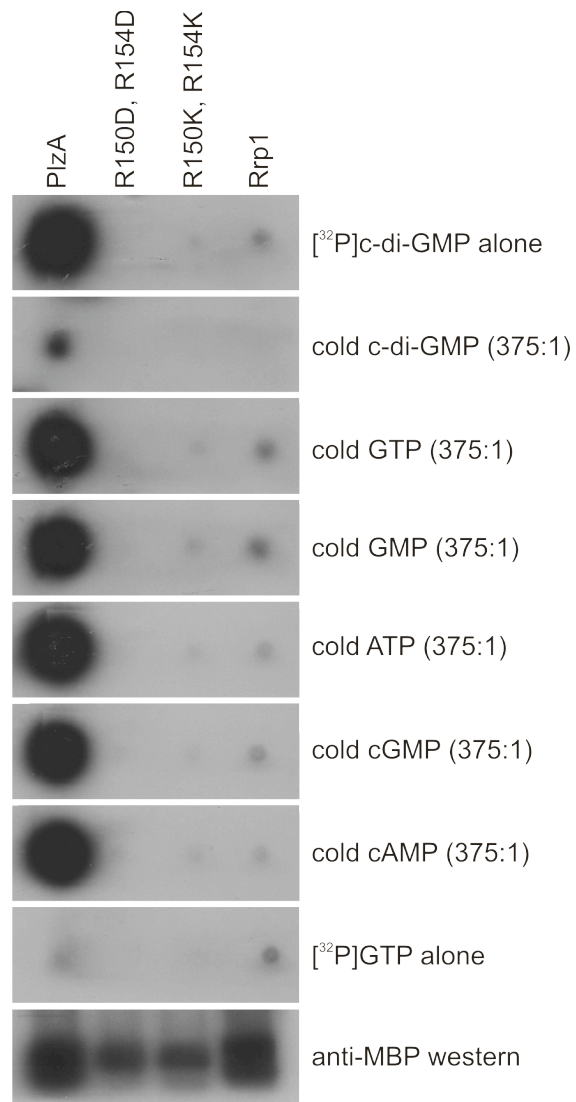

in the c-di-GMP regulatory network via the binding of c-di-GMP.

As demonstrated through PCR analyses and bioinformatic analyses of recently published genome sequences of *B. burgdorferi* sensu lato isolates, we found that the gene encoding PlzA is universally distributed amongst all *Borrelia* isolates analyzed and is present in all *Borrelia* species for which genome sequences are currently available. Interestingly, several isolates of *B. garinii* and *B. burgdorferi* encode for two PilZ domain-containing proteins, where one is encoded for on the linear chromosome and the other by a linear plasmid of 28 kb (lp28 group). The protein sequence of the chromosomally-encoded PilZ domain-containing protein is significantly conserved amongst *B. burgdorferi* sensu lato complex isolates (identity values >90%) and as such, represents a conserved distribution of a PlzA ortholog. Additionally, the plasmid-carried PilZ domain-protein sequences are equally as distant from PlzA (amino acid identity, ~64%) as the chromosomally-encoded PilZ-domain sequences of the TBRF *Borrelia* are to the B31 PlzA sequence (identity values of ~65 to 69%). Based upon protein sequence alignments and phylogenetic analyses, the lp28-encoded PilZ domain ORF of *B. burgdorferi* sensu lato isolates, and the chromosomally-encoded PilZ domain of the TBRF *Borrelia*, exhibit enough divergence to warrant separate gene titles – proposed as PlzB and PlzC, respectively. It is noteworthy that the domains associated with the synthesis/breakdown of c-di-GMP or effector functions of c-di-GMP are located in proteins that possess differing output domains. This suggests that PlzA, PlzB, and PlzC may respond differently to the binding of c-di-GMP. Plz proteins of the *Borrelia* do not

harbor identifiable functional domains other than the PilZ-domain involved in c-di-GMP binding, making potential mechanisms of action difficult to predict.

In studies published by Rogers, *et al.*, it was demonstrated that *rrp1* of *B. burgdorferi* is constitutively transcribed during *in vitro* cultivation and that its transcription is upregulated in ticks following a bloodmeal of mammalian origin (125). We hypothesized that because Rrp1 and PlzA appear to be functionally linked, that PlzA and Rrp1 would have similar expression patterns. *plzA* transcript was detected under all environmental conditions tested (23, 33, and 37°C) and no significant changes in expression levels were documented. However, *plzA* transcription was significantly upregulated in fed versus flat nymphal ticks, indicating that factors in the bloodmeal trigger transcription through unknown mechanisms. The elevated temperature encountered during tick feeding does not appear to be a source of *rrp1/plzA* expression, because temperature did not have an effect on *plzA* expression during *in vitro*-cultivation of *B. burgdorferi*. The molecular signal(s) resulting in the upregulation of *plzA* upon tick feeding are not yet known. One possibility is that *rrp1*, which is also upregulated by the bloodmeal, directly or indirectly influences *plzA* transcription through the synthesis of c-di-GMP. In earlier and more recent microarray studies, the inactivation of *rrp1* did not lead to a repression of *plzA* (28, 68, 125). As such, it is hypothesized that Rrp1, c-di-GMP, or an unidentified effector molecule involved in c-di-GMP genetic and/or physiologic regulation serves as a transcriptional activator of *plzA* that enhances its expression above threshold levels. Expression of *plzA* and *rrp1* was also assessed during murine infection. Expression of *plzA* and *rrp1* was detected in the urinary bladders of infected mice throughout the 13 week infection period. Collectively,

these data suggest that the synthesis of c-di-GMP and its downstream effector(s) contributes to the proper regulation of cellular processes during the enzootic cycle of the Lyme *Borrelia*.

While the presence of the c-di-GMP binding switch of the PilZ domain is indicative of c-di-GMP binding activity, it was necessary to directly demonstrate this activity for PlzA. For these analyses, r-DGC proteins were constructed, purified, and used to produce radiolabeled or nonradiolabeled c-di-GMP, and then used to assess binding to PlzA. A c-di-GMP/r-PlzA complex was readily detected using an overlay-based approach. C-di-GMP binding to PlzA was specific, as only trace levels of binding to Rrp1 were observed. The nucleotide binding specificity of PlzA was assessed using several different nucleotides as nonspecific and nonlabeled competitors. As predicted, excess unlabeled c-di-GMP substantially decreased the binding of radiolabeled c-di-GMP to PlzA, indicating saturable binding and competitive inhibition. None of the other tested nucleotides influenced the binding of radiolabeled c-di-GMP to PlzA when present in vast excess. These analyses confirm the highly specific nature of the interaction between c-di-GMP and PlzA.

To more adequately assess the molecular determinants involved in c-di-GMP binding by PlzA, site-directed mutants of PlzA were generated and tested for c-di-GMP binding. The targeted Arg residues of the c-di-GMP binding switch were chosen based upon similar analyses of the YcgR PilZ domain-containing protein of *E. coli* (134) in which Arg residues within the PilZ domain were demonstrated to be essential for binding. We generated r-proteins containing two double amino acid substitutions; R150D,R154D and R150K,R154K. Both mutants were readily expressed by *E. coli* and

were soluble. Neither mutant bound c-di-GMP indicating that the amino acid substitutions perturb the molecular binding determinants of PlzA. These data confirm the importance of the Arg residues in the c-di-GMP binding switch of the PilZ domain and provide further evidence that the interaction of c-di-GMP with PlzA is highly specific.

In summary, in this study we demonstrate that *B. burgdorferi* encodes for a functional c-di-GMP binding protein that we have designated as PlzA. PlzA expression was observed during both tick and mammalian stages of the enzootic cycle of the Lyme spirochetes. Binding analyses utilizing site-directed mutants of PlzA, as well as competitive inhibition experiments using excess amounts of different nucleotides, demonstrated that the interaction between PlzA and c-di-GMP is highly specific. The basic characterization of PlzA presented here is an important step forward in the understanding of the c-di-GMP regulatory network of the Lyme disease spirochetes. The analyses detailed within provide insight into a potential functional linkage between Rrp1, c-di-GMP, and PlzA, in terms of the hypothesized regulatory cascade driven by c-di-GMP. Specific roles of PlzA and the processes that it influences are described in the following chapter.

Acknowledgements

We thank Durland Fish (Yale University) for providing *I. scapularis* larvae and Christopher G. Earnhart (Virginia Commonwealth University) for providing the pTYB12-wspR vector for expression of WspR.

Chapter 4: Analysis of the impact of the PilZ-domain containing proteins, PlzA and PlzB, on motility and the enzootic cycle of the Lyme disease spirochetes

plzB* is variably distributed throughout *Borrelia burgdorferi sensu lato

Previously and through the use of bioinformatic analyses, we identified a paralog of *plzA*, that is harbored on a linear plasmid of 28 kb (lp28) in certain sequenced *B. burgdorferi* and *B. garinii* isolates (58). Using genomic DNA from a library of isolates obtained from a wide array of geographic locations and sources, we conducted PCR analyses to assess the distribution of the *plzB* gene. It was found that 9 out of the 22 additional strains tested contained the gene (data not shown). Strains 20004, CA3, CA8, CA12, CA-2-72, CA-2-87, MAC13, NY-1-86, R1000, and VS293 contained the allele, and certain strains contained a deletion mutation, creating a truncated protein lacking the c-di-GMP binding switch of the PilZ domain. It was determined that the distribution of *plzB* did not depend upon the geographic origin or animal/tissue source. Additionally, there was no correlation between MLST (multilocus sequence typing) type and the distribution of this gene.

PlzB is a cyclic-di-GMP binding PilZ domain protein

To determine whether or not PlzB was capable of binding c-di-GMP, overlay assays were performed as previously described (58). r-PlzB, r-PlzA (positive control), and r-Rrp1 were spotted onto nitrocellulose and screened in the presence of [³²P]c-di-GMP with or without cold, competitor nucleotides as indicated in Figure 11. Binding to PlzB was demonstrated by a decrease in signal with a 375:1 excess of cold c-di-GMP, and a lack of signal decrease with GTP, GMP, cGMP, cAMP, and ATP. Thus, like PlzA, PlzB is a c-di-GMP binding protein with high specificity for its ligand.

Allelic exchange mutagenesis: inactivation of *plzA*, complementation with *plzA* and *plzB*, and analysis of mutant growth rates

In order to examine the effects of PlzA and PlzB on the motility, chemotaxis, and processes important in the enzootic cycle of *B. burgdorferi*, *plzA* was inactivated by the insertion of a spectinomycin/streptomycin resistance cassette (B31- Δ *plzA*). Additionally, two complementary mutants were made. The first contains *plzA* in the wild type locus (BB0733)(B31-*plzA* KI), and the second placed *plzB* into the same genomic location (B31-*plzB* KI). Both complementation mutants contain a kanamycin resistance cassette 3' to the gene insertion and were selected for by growth in BSK-H containing kanamycin (Figure 12A). Successful deletion and complementation of *plzA/plzB* was confirmed via PCR analyses using primers specific for regions within the genome and the insertion (Figure 12B). Additionally, expression of the allelic exchange mutants was confirmed via reverse transcriptase PCR (Figure 12C).

Figure 11. PilZ is a PilZ domain-containing protein that binds c-di-GMP with high specificity. R-PilZ, and r-Rrp1 were expressed as N-terminal MBP fusions and were assessed for their ability to bind to [³²P]c-di-GMP. The r-proteins used in the analyses are designated across the top of the panels. The ratio of competing nucleotide to [³²P]c-di-GMP is indicated to the right (no competitor was added in the top panel). The second panel from the bottom was screened with [α -³²P]GTP alone (with no c-di-GMP added) and the bottom panel is a Western blot using anti-MBP antibody.

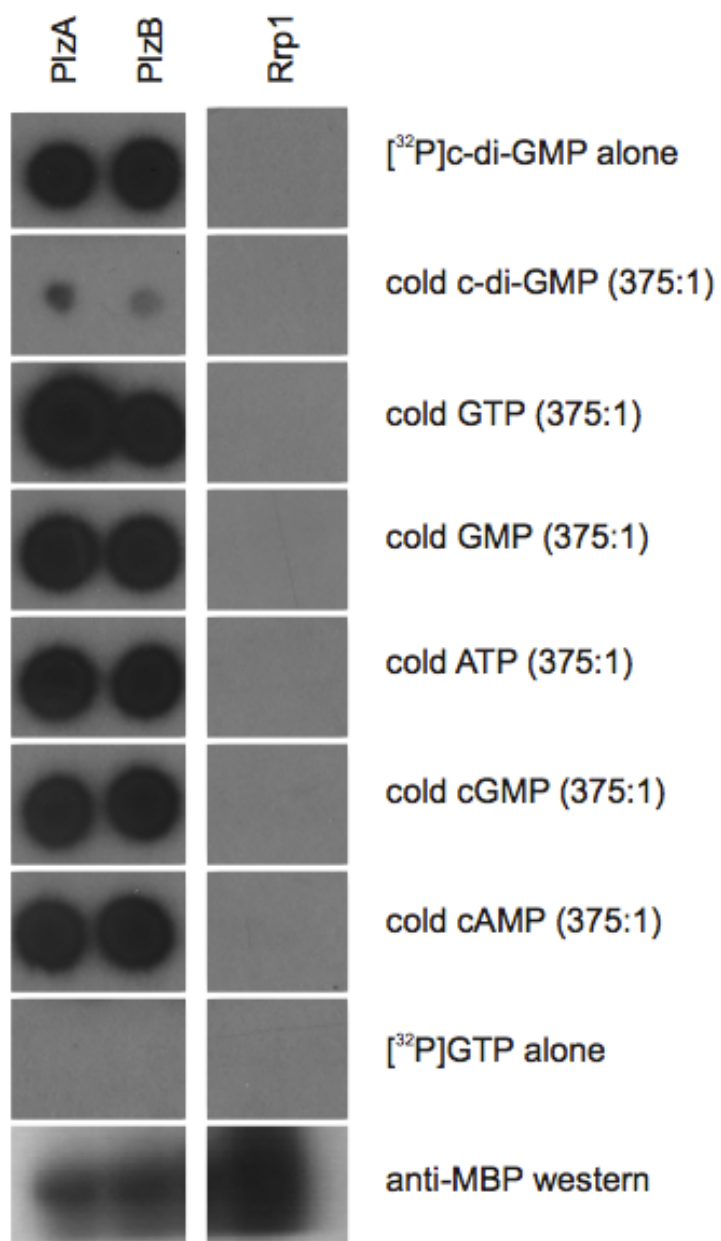
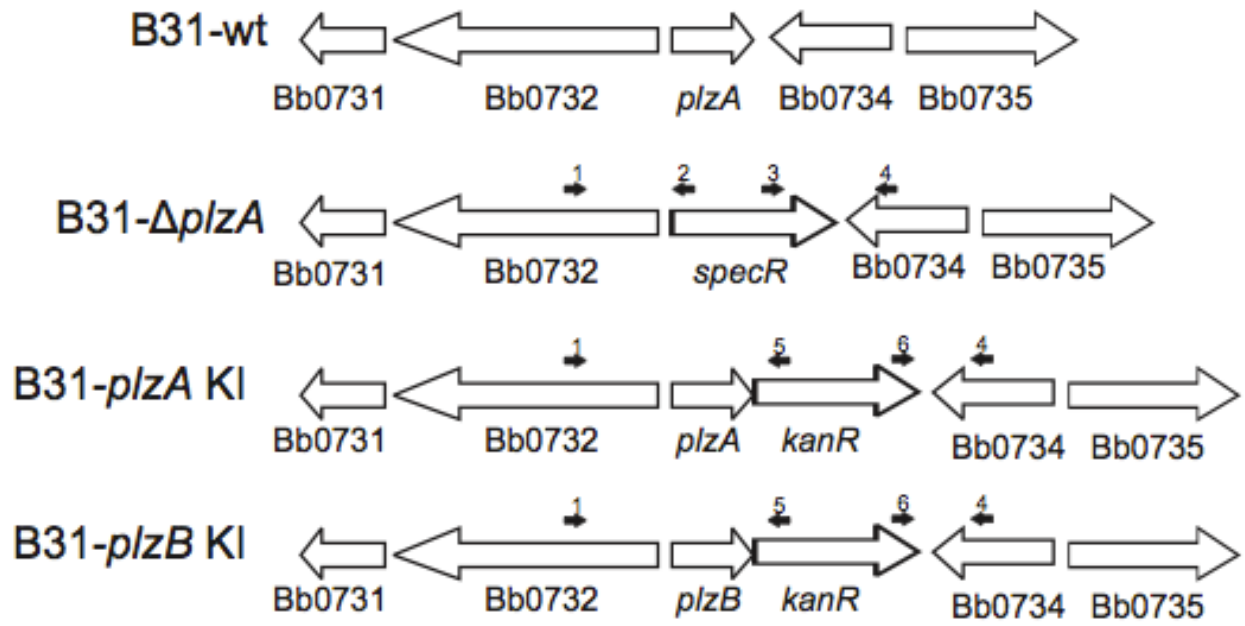
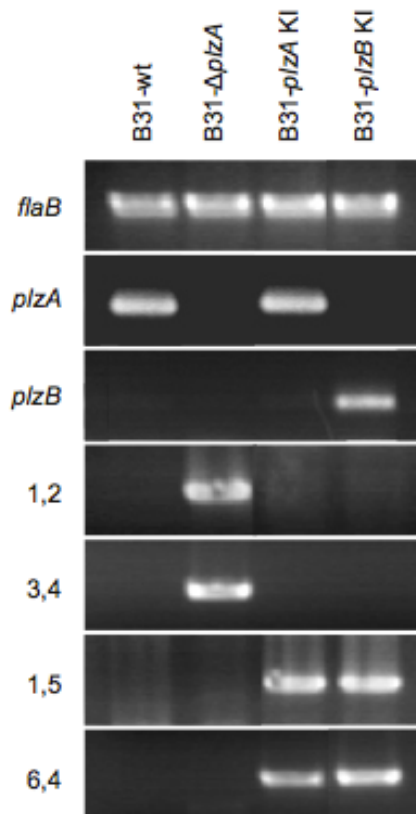

Figure 12. Characterization of *plzA* allelic exchange and deletion mutants. (A) Wild type and allelic exchange mutants were constructed by the deletion or complementation of the chromosomally-encoded BB0733. Diagrams represent the genomic arrangement of wild type, deletion, and complemented strains. (B) Successful deletion and complementation mutants were confirmed by PCR analysis. Primer pairs are indicated spacially in panel A, and the respective strain designations are shown on the top. (C) Expression of *plzA* and *plzB* were demonstrated via reverse transcriptase PCR. The genes analyzed are shown on the left, and again, the strain designations are shown on top.

A)



B)



C)

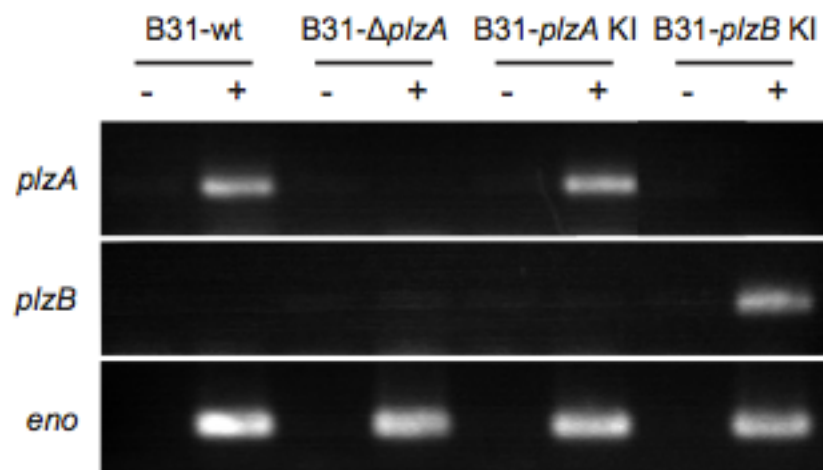

Because plasmids of *Borrelia spp.* are frequently lost during cultivation and transformation/electroporation, the total plasmid content of clonal populations of all mutants was assessed by PCR using primers specific for ORFs harbored on each of plasmids of *B. burgdorferi* 5A4 (Table 3). Clones containing the full repertoire of plasmids were selected and used in later analyses.

To assess the effects of deletion and allelic replacement of *plzA* on potential growth defects of these strains, clonal populations of B31- Δ *plzA*, B31-*plzA* KI, and B31-*plzB* KI were assessed for growth rates at 33°C and 37°C. Both the knockout and *plzA* complement displayed similar growth rates to wild type *B. burgdorferi*, 5A4, while the *plzB* complemented strain displayed a slightly reduced growth rate during logarithmic phase, and was unable to reach numbers as high as the wild type (Figure 13). The above work was conducted in collaboration with Jessica L. Kostick and Dr. Beth Rogers Abdunnur.

***plzB* is unable to complement *plzA* motility functions**

In order to assess the potential roles of *plzA* and *plzB* in the motility of *B. burgdorferi*, swarming assays and video-tracking experiments were performed. Swarm assays were conducted in semi-solid media containing BSK-H complete and agarose (0.35%). Relative to wild type, B31- Δ *plzA* demonstrated a swarm diameter that was 56.7% decreased, and B31-*plzB* KI demonstrated swarm diameters with a decrease of 68.7% (Figure 14). These differences were determined to be significant and p-values are indicated in Figure 14. Motility patterns were assessed in BSK-H complete growth media containing 1% methylcellulose. Methylcellulose increases media viscosity by

Figure 13. Growth rates of *plzA* allelic exchange/deletion mutants. Growth of B31- $\Delta plzA$, B31-*plzA* KI, and B31-*plzB* KI were assessed at 33, and 37°C by microscopic analysis until stationary phase was reached. Equal numbers of cells were used to start cultures, and 10 40x fields were counted each day. B31- $\Delta plzA$ and B31-*plzA* KI displayed similar growth rates at all temperatures tested, and B31-*plzB* KI displayed a slightly slower growth rate during logarithmic phase and did not reach levels as high as wild type.

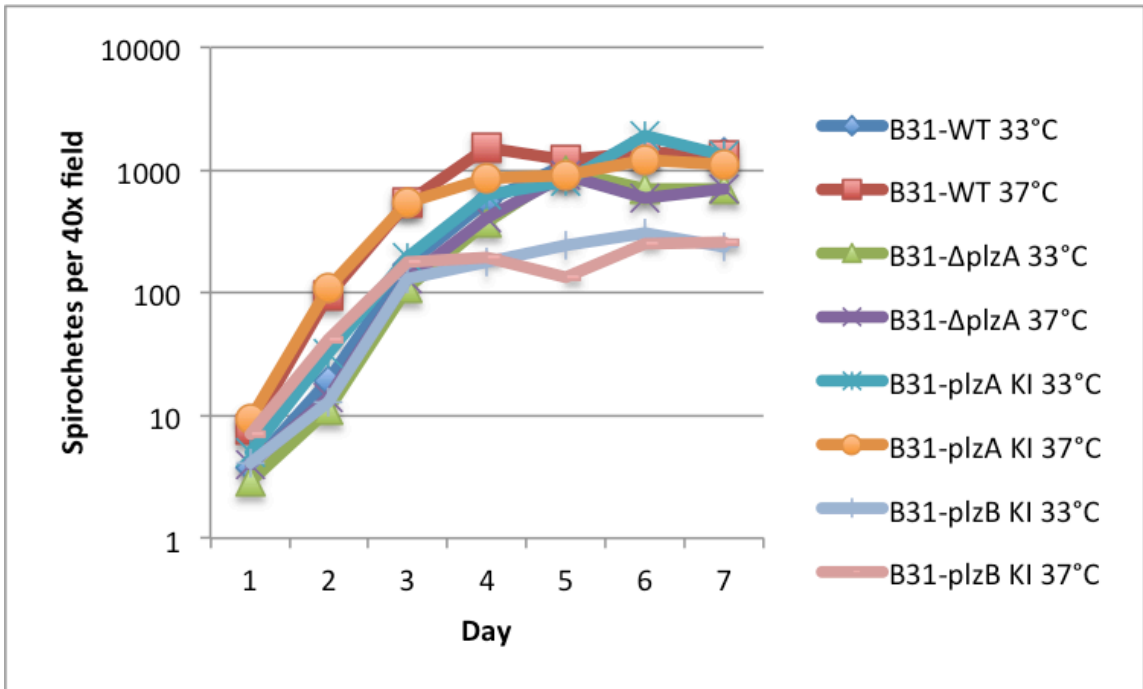
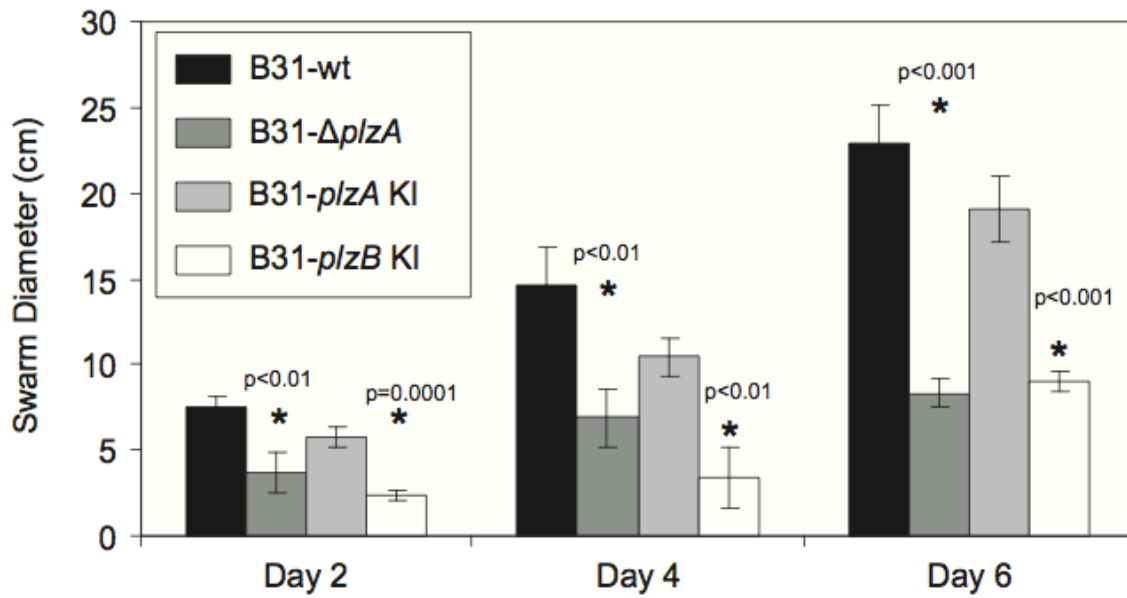
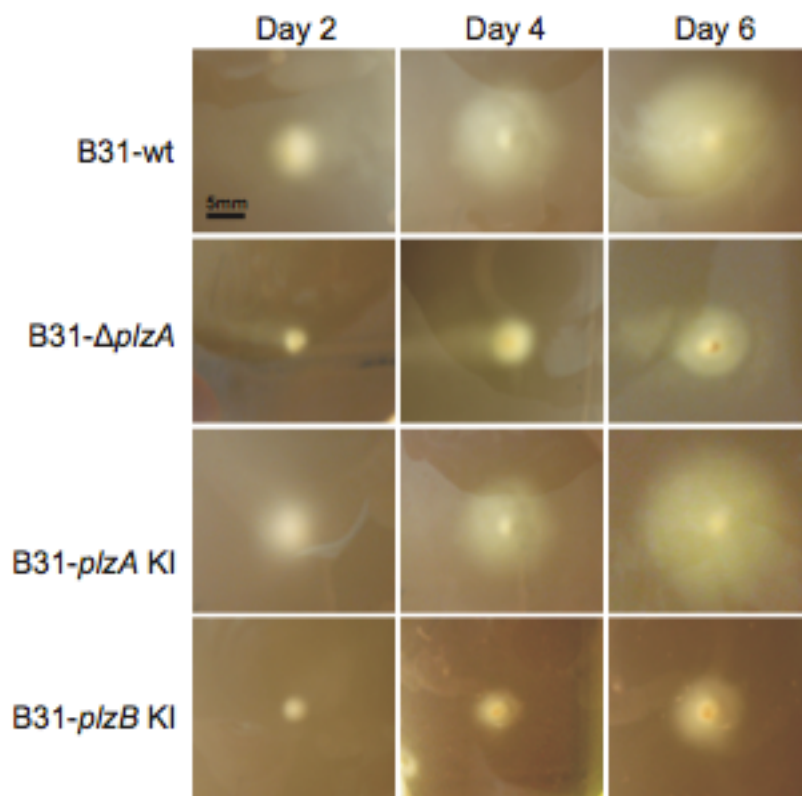

Figure 14. PlzA but not PlzB, regulates the swarming motility of *B. burgdorferi*. (A) Wild type and mutant *B. burgdorferi* strains were assessed for their ability to swarm in semi-solid agarose BSK-H plates. Spirochetes (5×10^5) were spotted into plates at day 0, and swarm diameters were measured at days 2, 4, and 6. Assays were performed in triplicate, and significance was assessed by Student's t-test with a confidence interval of 95%. (B) Images of representative swarm diameters were taken at days 2, 4, and 6. Strain designations are shown on the left axis and the day is indicated at the top. Soft agar swarming assays were performed by Jessica L. Kostick.

A)



B)



creating a matrix through which the spirochetes are able to move (130). Twenty spirochetes were used to calculate all measurements. Both B31- $\Delta plzA$ and B31- $plzB$ KI had slower average run speeds ($1.6500 \pm 0.7339 \mu\text{m}/\text{sec}$ and $1.5793 \pm 0.7369 \mu\text{m}/\text{sec}$, respectively) and decreased flexes (0.0783 ± 0.0313 flexes/second and 0.0078 ± 0.0109 flexes/second) relative to B31-wt. The average velocity for B31-wt was $4.1578 \pm 0.7788 \mu\text{m}/\text{sec}$ and the average flexes were 0.0783 ± 0.0313 . As expected, B31- $plzA$ KI displayed similar average run velocities and flexes/second to that of the wild type strain (Table 5 and Figure 15). These differences were determined to be significant with p-values < 0.0001 . Taken together, the swarm assay and video tracking analyses demonstrate that $plzA$ is important for the proper regulation of motility as well cellular flexing during motility via unknown mechanisms, and that $plzB$ is unable to complement for these functions. Motion-tracking analyses were performed by Dr. Lee T. Szkotnicki. Defects in the chemotaxis of the plz mutants towards N-acetyl-glucosamine were not detected, indicating that PlzA and PlzB do not play a role in the chemotaxis of *B. burgdorferi* (Jessica L. Kostick, unpublished data).

***plzA*, but not *plzB*, plays a role important in murine infectivity**

Subcutaneously needle-inoculated mice were sacrificed at 4 weeks post-inoculation and assessed for infection by wild type, B31- $\Delta plzA$, B31- $plzA$ KI, and B31- $plzB$ KI, using seroconversion analyses and observation of outgrowth of spirochetes from biopsied tissues. Mice infected with B31- $\Delta plzA$ and B31- $plzB$ KI displayed markedly reduced anti-*Borrelia* IgG titers compared to that of wild type and B31- $plzA$ KI (Figure 16A). Low level IgG titers were similar to those observed in previous infection

Table 5. Average run velocity and flexes/sec of *B. burgdorferi* *plzA* mutants

Strain	Average Run Velocity	Flexes/sec
B31-wt	4.1578 ± 0.7788 μm/sec	0.0783 ± 0.0313
B31-Δ <i>plzA</i>	1.6500 ± 0.7339 μm/sec	0.0043 ± 0.0115
B31- <i>plzA</i> KI	4.1706 ± 0.8714 μm/sec	0.1024 ± 0.0541
B31- <i>plzB</i> KI	1.5793 ± 0.7369 μm/sec	0.0078 ± 0.0109

Figure 15. PlzA but not PlzB regulates motility patterns of *B. burgdorferi*. Motility in BSK-H complete media with 1% methylcellulose was examined using differential interference contrast (DIC) microscopy. Movies of spirochetes were recording using time-lapse photography and were analyzed using Slidebook 5 motion-tracking software (Intelligent Imaging Innovations). Measurements of velocity were calculated using 20 motion-course tracks per strain. Images of representative fields/spirochetes are shown at 0, 5, 10, and 20 seconds. Course of movement is indicated by the rainbow-colored line, with movement progressing from violet to red and strain designation is shown on the top of the image.

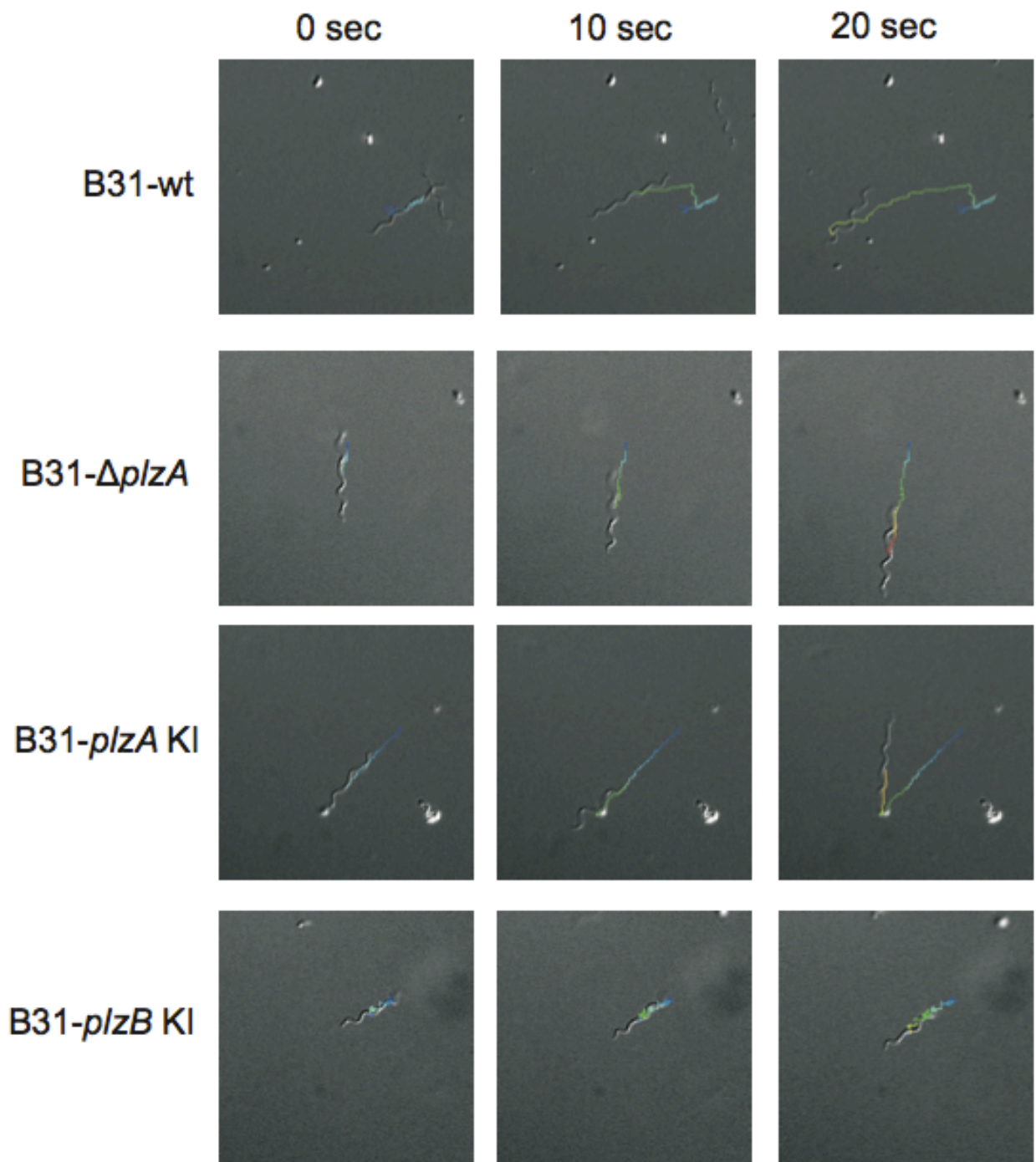

studies (48, 80). To compare the pattern of antigen recognition of mice infected with each strain, immunoblots screening *B. burgdorferi* 5A4 whole cell lysates were performed. As expected based upon the ELISA IgG titer assays, serum from mice infected B31- $\Delta plzA$ and B31-*plzB* KI did not recognize any proteins. No differences in antigenic profile were observed between the wild type strain and B31-*plzA* KI (Figure 16B).

In order to assess infectivity and dissemination, outgrowth of spirochetes from biopsied organs was assessed. As expected from the seroconversion data, no spirochetes were observed in mice inoculated with B31- $\Delta plzA$ and B31-*plzB* KI. Outgrowth of spirochetes from the skin, heart, and urinary bladders were observed in all mice infected with wild type and B31-*plzA* KI strains (Table 6). From these data, it can be concluded that *PlzA* is required for mammalian infection and that *PlzB* is unable to complement for its functions during the mammalian stage of the enzootic cycle. These studies were performed in collaboration with Jessica L. Kostick.

***plzA* is nonessential for survival in ticks, but is required for murine infection via tick bite; *plzB* cannot complement this function**

Several components of the *B. burgdorferi* c-di-GMP signaling network have been shown to be important in the survival of *Ixodes scapularis* ticks (28, 68, 80, 159, 160). To assess survival in artificially infected ticks, mouse-independent immersion inoculation was performed. Naïve larval ticks were submerged in BSK-H complete media containing 10^8 spirochetes/mL, allowed to dry for one week, and fed to repletion

Figure 16. PlzA regulates processes important in mammalian infection. C3H/HeJ murine subjects were inoculated subcutaneously with wild type, B31- $\Delta plzA$, B31-*plzA* KI, and B31-*plzB* KI strains. At 4 weeks, serum was harvested and IgG titers were assessed by ELISA. Strain designations are shown on the bottom, and horizontal lines indicate the mean Log (Anti-*Borrelia* IgG titer). Individual points represent titers for individual mice (A). Patterns of antigen recognition were assessed by immunoblotting against *B. burgdorferi* whole cell lysates (B). P-values were determined in comparison to B31-wt.

A)

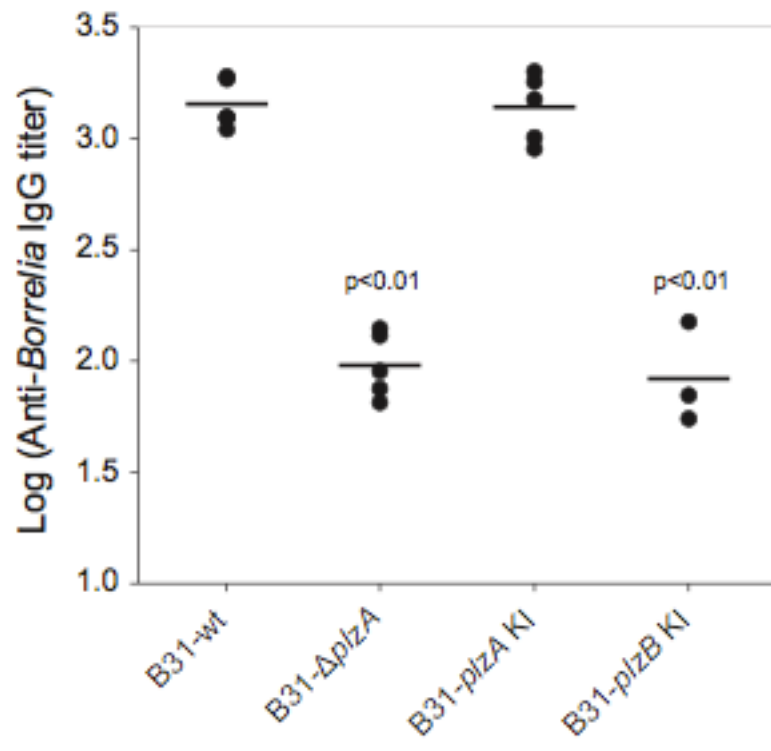

B)

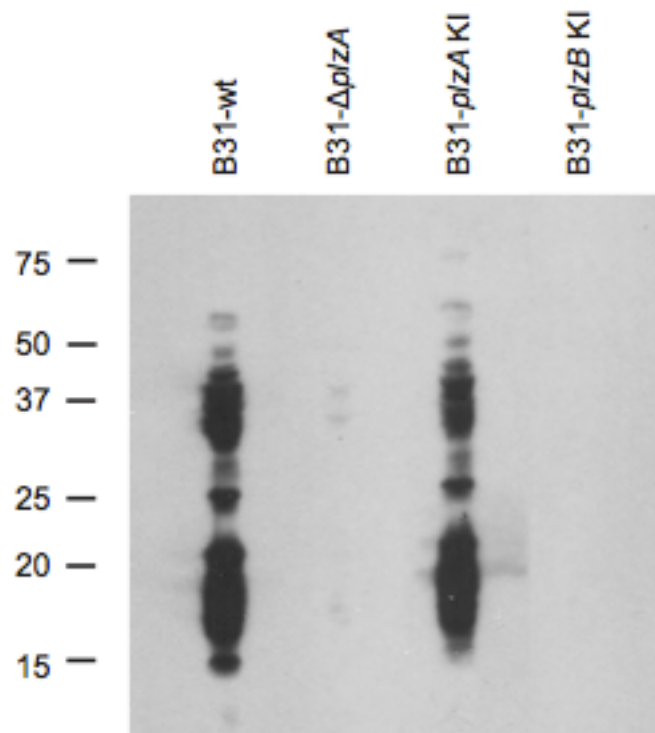

Table 6. Outgrowth of spirochetes from murine biopsies

Strain	Bladder	Heart	Skin (ear)
B31-wt	5/5	5/5	5/5
B31- $\Delta plzA$	0/5	0/5	0/5
B31- <i>plzA</i> KI	5/5	5/5	5/5
B31- <i>plzB</i> KI	0/3	0/3	0/3

on naïve C3H/HeJ mice. Ticks were collected, and assessed by qPCR for the presence of spirochetes. Spirochetes from each strain (wild type, B31- $\Delta plzA$, B31-*plzA* KI, and B31-*plzB* KI) were detected in the majority of artificially infected *I. scapularis* ticks. Thus, *plzA* is dispensable for spirochete survival in larval *I. scapularis* ticks (Table 7).

To examine whether *plzA* can allow for infection of mice via the natural route, and whether or not *plzB* can complement its function, infected ticks were placed onto naïve C3H/HeJ mice. Four weeks post-feeding, mice were sacrificed and serum was collected for seroconversion analyses. As was seen for the needle inoculated mice, B31- $\Delta plzA$ and B31-*plzB* KI displayed markedly reduced titers as compared to the wild type and B31-*plzA* KI strains. Taken together, these results demonstrate that PlzA is nonessential for survival in ticks, but is required for murine infection via tick bite, and also that PlzB cannot complement PlzA function during tick transmission and/or mouse infection (Figure 17). This work was conducted in collaboration with Jessica L. Kostick, Dr. Lee T. Szkotnick, and Katie Mallory.

Discussion

To date, species of the genus *Borrelia* are the only spirochetes in which c-di-GMP signaling has been studied. In staying with the theme that c-di-GMP acts as a molecular “on-off switch” for the regulation of opposing phenotypes (37, 76, 94, 111, 115, 117, 146), it is logical that the second messenger would regulate processes important in an organism that must withstand vastly different environments in a two-host enzootic cycle. The cascade of c-di-GMP signaling in *B. burgdorferi*, begins with

Table 7. PlzA regulation of tick survival by *B. burgdorferi*

Strain	# of <i>Borrelia</i> positive ticks after mouse-independent immersion inoculation (qPCR)	# of seroconversion positive mice after infected tick feeding (ELISA)
B31-wt	10/10	3/3
B31- $\Delta plzA$	8/10	0/3
B31- <i>plzA</i> KI	8/10	1/3
B31- <i>plzB</i> KI	8/10	0/3

Figure 17. PlzA is necessary for the transmission of *B. burgdorferi* to mammalian hosts during the tick-mouse-tick enzootic cycle. Artificially infected ticks were placed onto naïve mice and allowed to feed to repletion. Following feeding, ticks were harvested, and mice were held for 4 weeks to allow potential infection and dissemination to progress. At 4 weeks, mice were sacrificed and analyzed by ELISA for seroconversion. Strain designations are shown on the bottom, and horizontal lines indicate the mean Log (Anti-*Borrelia* IgG titer). Individual points represent titers for individual mice.

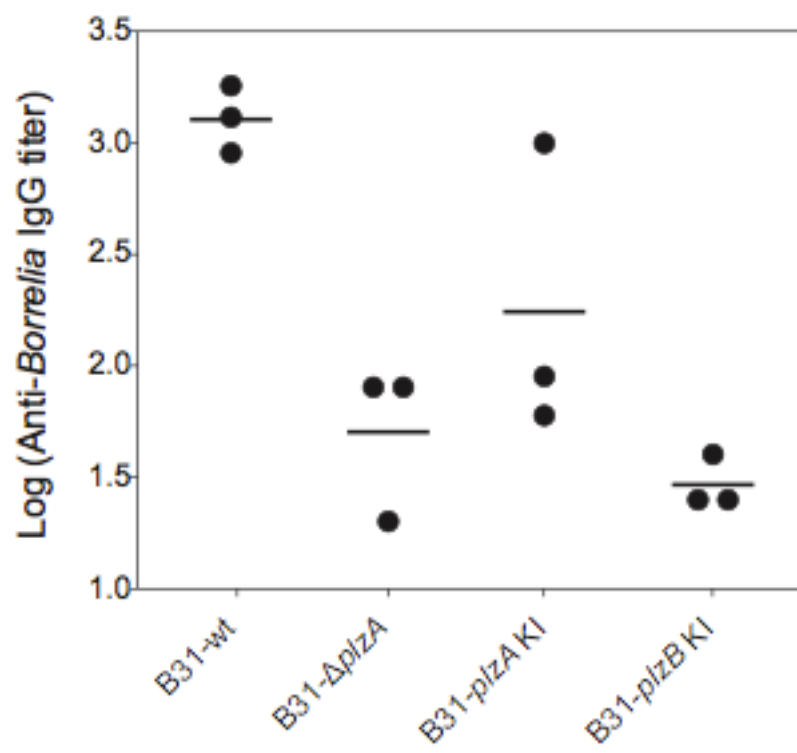

activation of Hk1, phosphotransfer to Rrp1, and synthesis of c-di-GMP. Rrp1, and presumably c-di-GMP have demonstrated to be important in motility, chemotaxis, and processes important in tick survival and mammalian infectivity (28, 68, 80, 125). Likewise, the EAL domain-containing PDE, PdeA, the HD-GYP domain-containing protein, PdeB, and the PilZ domain-containing protein, PlzA have been demonstrated to be important in similar processes (116, 159, 160). This study further supports the context of the literature, that c-di-GMP is an important molecule *in vivo* in the life cycle of *B. burgdorferi*

Because c-di-GMP exerts its effects through the interaction with down stream effector molecules such as PilZ-domain containing proteins, transcriptional regulators, and GEMM RNA riboswitches (3, 13, 58, 71, 79, 83, 101, 134, 150), we desired to assess the effects of PlzA and the variably distributed PlzB PilZ domain-containing proteins of *B. burgdorferi* on motility, chemotaxis, and ability to complete the tick-mouse enzootic cycle (58). Previous studies by our lab demonstrated that *plzA* is widely distributed across the genus, that *plzA* is upregulated at the time of tick feeding, expressed during mammalian infection, and that PlzA is capable of binding to c-di-GMP in a highly specific manner, *in vitro*. Taken together, these data suggest that PlzA is a c-di-GMP effector protein, important in the enzootic cycle of the Lyme disease spirochetes (58).

In previous studies, it was found through bioinformatics analysis, that certain Lyme *Borrelia* harbor a second, plasmid (lp-28) harbored PilZ domain-containing protein, which we named PlzB. PlzB harbors a putative PilZ domain, and shares 64.4 and 80.5% identity and similarity with PlzA from *B. burgdorferi* B31. The majority of

homology exists within c-di-GMP binding switch region harboring the RxxxR...D/NzSxxG binding motif (58). To further assess the distribution of *plzB* amongst the Lyme disease spirochetes, we performed PCR using *plzB*-specific primers and a library of genomic DNA from a wide array of geographic and host-derived sources. Similarly to what is seen in the literature, approximately 40% of the isolates tested contained the *plzB* allele (58). Sequence analysis of the amplified *plzB* alleles showed that certain alleles encode truncated proteins lacking a PilZ domain. Full length *plzB* amplified from *B. burgdorferi* strain CA12 was used in all biochemical and *ex vivo* and *in vivo* analyses, and is identical in sequence to PlzB of *B. burgdorferi* strain 64b.

In order demonstrate that PlzB is a c-di-GMP binding protein, overlay assays were performed as previously described (58, 117). Like PlzA, PlzB binds c-di-GMP with high specificity. While we did not assess the roles of the arginine residues in the c-di-GMP binding switch of PlzB, it is highly likely that they are essential for c-di-GMP binding as has been demonstrated for PlzA and other PilZ domain-containing proteins (37, 58, 101, 134). Based upon the similarity of the c-di-GMP binding switch regions of PlzA and PlzB, it is likely that these proteins evolved concurrently, and evolved separate functions and/or genomic locations at a later time.

In these studies, we generated a series of *plzA* allelic exchange mutants (B31- $\Delta plzA$, B31-*plzA* KI, and B31-*plzB* KI) and utilized them to analyze the effects of PlzA and PlzB on motility, chemotaxis and tick/mouse survival, infectivity, and transmission - processes demonstrated to be affected by c-di-GMP signaling in *Borrelia* and other prokaryotic organisms. Deletion of *plzA* resulted in reduced swarming on semi-solid media, and additionally resulted in slower velocity and decreased flexing as noted by

DIC microscopy. Not surprisingly, PlzB, which only shares moderate homology with PlzA, was unable to complement the functions of the chromosomally-encoded PlzA. These analyses demonstrate that PlzA positively regulates the proper motility of *B. burgdorferi*, but that PlzB cannot complement for defects in PlzA signaling. While the differences in chemotaxis were not significant between Plz mutants, these data may suggest that PlzA and PlzB have evolved separate functions, where PlzA directly or indirectly regulates motility and PlzB regulates unknown or yet-to-be described processes. PilZ domain-containing proteins have been shown to regulate motility and chemotaxis in the enterobacteria (YcgR) and *Caulobacter crescentus* (DgrA), via interaction with proteins of the flagellar motor (3, 20, 37, 39, 111, 134). It may be that *B. burgdorferi* and other Lyme spirochetes have evolved similar PilZ-flagellar interactions in order to quickly translate environment cues into increased motility and/or chemotaxis, processes potentially important during tick transmission and mammalian infection. Likewise, the c-di-GMP-PlzA/PlzB interaction may affect motility and/or chemotaxis via other yet-to-be described mechanisms.

Needle inoculation of C3H/HeJ mice with wild type *B. burgdorferi* strain 5A4, B31- $\Delta plzA$, B31-*plzA* KI, and B31-*plzB* KI imply that PlzA is required for mammalian infectivity, and that PlzB cannot complement PlzA functions important in infection and/or dissemination. These observations are based upon seroconversion and tissue outgrowth experiments. Additionally, PlzA was dispensable for survival in larval *Ixodes scapularis* ticks (fed via submersion), and PlzB had no further positive or negative effects. As expected, B31- $\Delta plzA$ and B31-*plzB* KI were unable to be transmitted to

mice fed on by infected *I. scapularis* ticks. While it is possible that these strains do not traffic correctly through the tick for natural infection, they were both non-infectious by needle inoculation as previously mentioned. Taken together this study demonstrates the importance of PlzA in motility and steps important in the enzootic cycle of the Lyme spirochetes, as well as the potential importance of PlzB in chemotaxis. It is possible that while PlzB does not complement the phenotypes associated with loss of PlzA, that PlzB may offer strains harboring the *plzB* gene on an lp-28 advantages in chemotaxis towards mammalian factors during transmission, or tick acquisition of infecting spirochetes. Other potential roles cannot be discounted. Unfortunately, because B31- $\Delta plzA$ and B31-*plzB* KI were noninfectious, tick acquisition experiments were unable to be performed. While certain strains of *B. burgdorferi* have evolved and maintained *plzB*, it still remains unclear what advantages this second allele may have in nature. Further studies will have to be performed utilizing a *plzB*-lacking strain, expressing a plasmid-carried *plzB* to tease apart the intricacies of PlzB function in the presence of PlzA.

Like the other signaling components of the c-di-GMP signaling network of *B. burgdorferi*, PlzA and potentially PlzB, may be important for process important in the enzootic cycle and survival in nature by the Lyme disease spirochetes (28, 58, 68, 80, 116, 125, 159, 160). The results here are only somewhat in agreement to what was observed by Pitzer *et al.* (116). Those studies demonstrated that PlzA is not required for infection and that a *plzA* deletion mutant showed decreased survival in ticks. Additionally, the *plzA* null strain created by Pitzer *et al.*, did not exhibit different motility patterns in 1% methylcellulose. While there is a discrepancy with these data presented

here, two different parent strains were utilized. (116). While not all of the nuances of c-di-GMP signaling are understood in *B. burgdorferi*, it appears as if the synthesis, breakdown, and binding of c-di-GMP is a fine-tuned system. Deletion of the components of c-di-GMP signaling in *B. burgdorferi* has revealed discrepant phenotypes. For example, strains lacking Rrp1 or PdeA (low or high levels of c-di-GMP, respectively) both demonstrate decreased motility and survivability in ticks (28, 68, 80, 160). It may be that processes important in tick survival, acquisition, and/or transmission are highly regulated and extremely fine-tuned at the level of c-di-GMP synthesis and breakdown, affecting different processes as the spirochetes encounter differing environments within the tick and/or mammalian host. Disregulation of c-di-GMP levels at different times during the enzootic cycle may be deleterious to *Borrelia* survival. The importance of c-di-GMP and its role in motility/chemotaxis *in vivo* remains to be determined, but it may be that motility is important in trafficking through the tick vector or into deeper tissues in mammalian infection. Regardless, the phenomena described here support the notion that c-di-GMP signaling is important in the enzootic cycle of *B. burgdorferi*. These analyses identify potential roles for the two known c-di-GMP binding proteins of *B. burgdorferi*, and strengthen our understanding of PilZ domain-containing proteins of the spirochetes. While it remains to be determined what the mechanism of action of the *Borrelia* PilZ proteins is, the analyses here provide a framework for piecing together the intricate puzzle of c-di-GMP signaling in *B. burgdorferi*.

Acknowledgements

I would like to thank Jessica Kostick for her work with the characterization of these mutants, as well as Dr. Lee Szkotnicki for his work with the still images and work performed at the VCU Microscopy Core Facility.

Chapter 5: Metabolism of c-di-GMP in the tick-borne relapsing fever spirochete, *Borrelia hermsii*, plays an integral role in motility and virulence

Rrp1 is a phosphorylation-dependent, response regulator/diguanylate cyclase protein

Recently, it was demonstrated that Rrp1 of *B. burgdorferi* exhibits DGC activity when in an “activated”, phosphorylated state. To show that Rrp1 of *B. hermsii* is also a hybrid response regulator/DGC, we carried out *in vitro* c-di-GMP synthesis assays as previously described (58, 135). Because r-Hpk1 was unavailable as a source of phosphotransfer, we used acetyl phosphate (AcP) as a phosphate donor in order to phosphorylate the receiver domain of r-Rrp1. Following incubation with AcP, and subsequent incubation with GTP, r-Rrp1 produced c-di-GMP as indicated by a retention time equal to that of the c-di-GMP standard. As expected, in the absence of AcP, r-Rrp1 does not produce c-di-GMP. Instead, it appeared as if r-Rrp1 broke GTP into two unidentified products. Because neither observed peak was retained equally to GTP or GMP standards, we are unable to say what either of the peaks may be. However, based upon the data, it is clear that Rrp1 of *B. hermsii* is a phosphorylation-dependent response regulator/DGC hybrid protein (Figure 18).

PdeA is an EAL domain-containing phosphodiesterase

Previously, bioinformatics analysis and later biochemical evaluation revealed that PdeA of *B. burgdorferi* is an active EAL domain-containing PDE (160). To determine the functionality of PdeA of *B. hermsii*, we used an approach utilized by Tamayo *et al.* and Sultan *et al.* (160, 163). r-Rrp1 from *B. hermsii* was used to synthesize [³²P]c-di-GMP, which was used in this analysis. [³²P]c-di-GMP was incubated with our negative (r-PlzA) and positive controls (snake venom phosphodiesterase; SVPD), or r-PdeA with Mg²⁺ in the presence or absence of Mn²⁺. After incubation with c-di-GMP, we found that PdeA breaks down the second messenger nucleotide into linear-di-GMP (l-di-GMP, or pGpG) as indicated by the spot migrating with a retention factor (Rf) value of 0.55, and the increase in intensity of this spot over time (Figure 19). Unlike *B. burgdorferi* PdeA, we did not observe increased activity in the presence of Mn²⁺.

Generation and characterization of a $\Delta rrp1$ and $\Delta pdeA$ deletion mutant and complement strains.

Recent advances in the techniques used to transform *B. hermsii* have allowed us to assess the role c-di-GMP metabolism has on the motility, chemotaxis, and infectivity of *B. hermsii* DAH (12, 53). To assess this, we replaced both *pdeA* and *rrp1* with a tandem gentamicin (*gentR*) resistance-green fluorescent protein (*gfp*) cassette. The resulting strains were designated *BhDAH Δ rrp1* and *BhDAH Δ pdeA* (Figure 20A). We also generated a cis-complemented strain through introduction of the wild type genes appended with a downstream tandem kanamycin (*kanR*) resistance-*gfp* cassette.

Figure 18. Rrp1 of *B. hermsii* is a GGEEF domain-containing protein exhibiting DGC activity. The ability of r-Rrp1 to produce c-di-GMP was assessed using HPLC. The top graphs demonstrate the elution volumes (mL) of the indicated nucleotides. r-Rrp1 was incubated with or without acetyl phosphate (+AcP or -AcP, as indicated in the figure) before the addition of GTP to assess the dependence of c-di-GMP production on phosphate activation. The r-proteins were then incubated with GTP and the nucleotide products were analyzed by HPLC as detailed in the text.

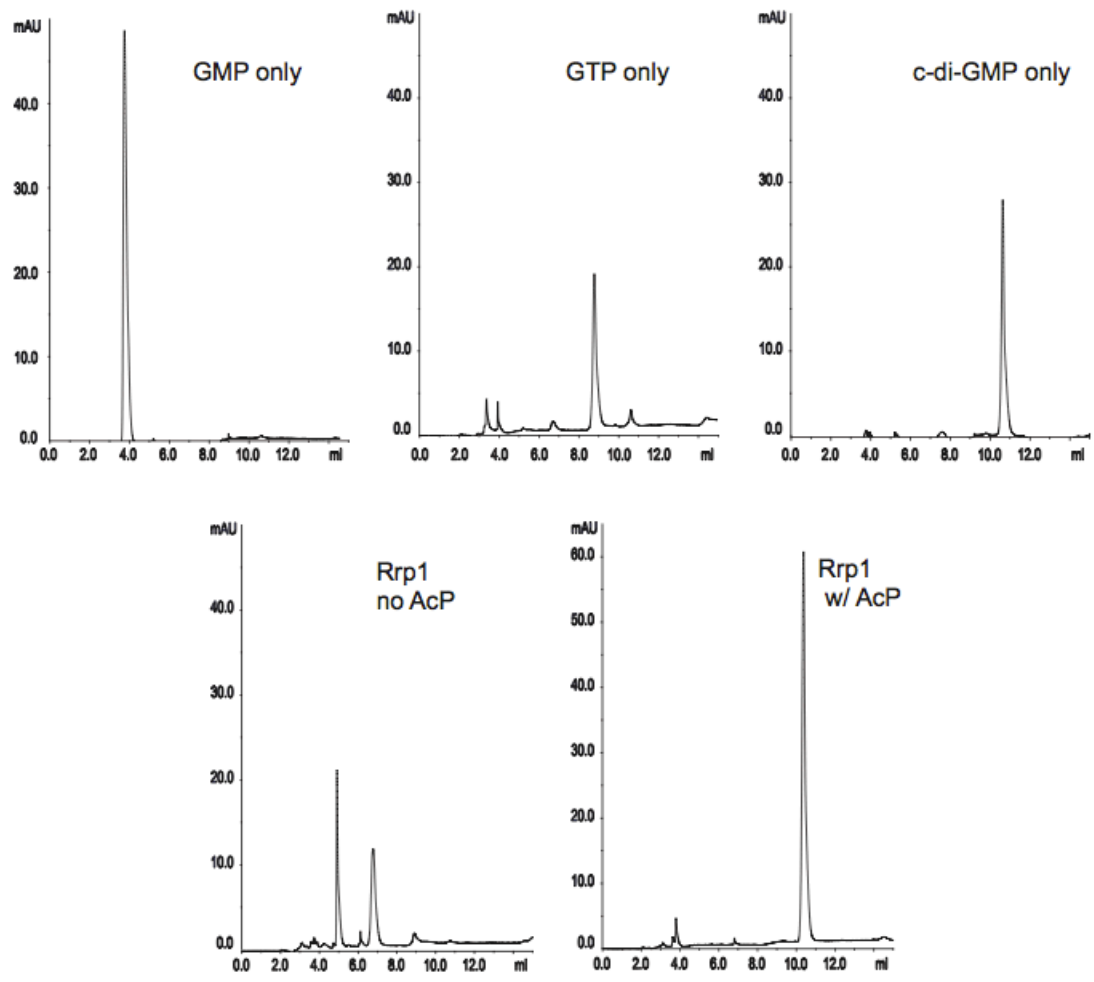
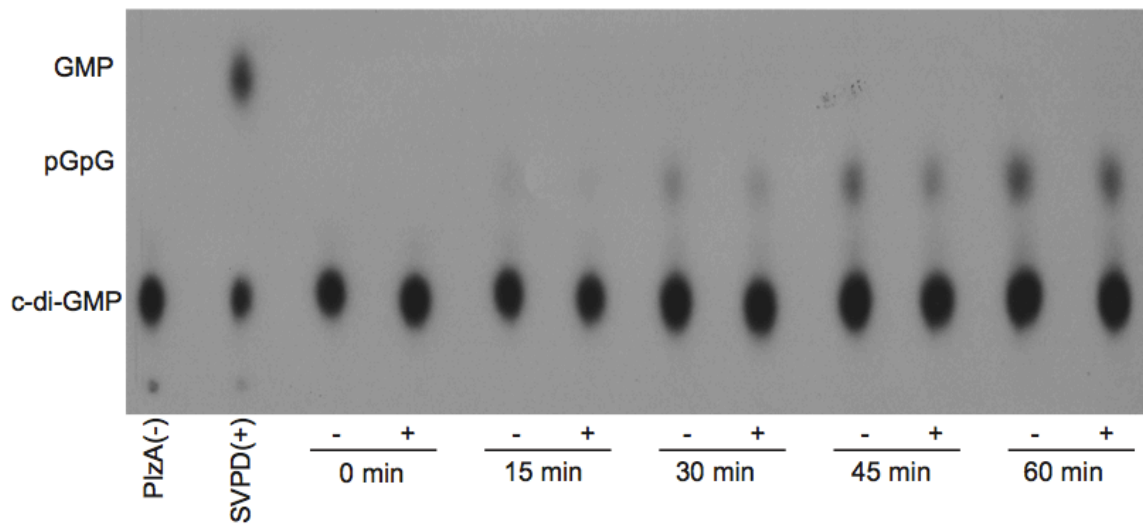

Figure 19. PdeA of *B. hermsii* is a c-di-GMP specific EAL phosphodiesterase.

The ability of r-PdeA to break c-di-GMP into l-di-GMP was assessed using TLC. r-PdeA, positive (SVPD), and negative controls were incubated with [³²P]c-di-GMP for one hour at room temperature. Reactions were then spotted onto PEI-cellulose membranes at 0, 15, 30, 45, and 60 minutes to stop the reaction. Reactions took place in the presence or absence of Mn²⁺ as indicated by the “+” or “-” symbols at the bottom of the figure.



These strains were designated *BhDAHrrp1::kanR* and *BhDAHpdeA::kanR* (Figure 20B). Clonally-derived populations of both deletion and complemented strains were isolated through the use of limiting dilution, and proper insertion of the *gentR-gfp* or *rrp1/pdeA-kanR-gfp* cassettes was confirmed via PCR using primers designated in Figures 21A, 21B, and Table 3 (Figure 20C). Growth curve analysis was performed to identify any possible growth defects associated with any of the insertions in their respective genomic locations. All *B. hermsii* cultures appeared to have similar growth rates at all tested temperatures (Figure 20D). Electroporation of a related spirochete *B. burgdorferi* often results in loss of DNA elements (86, 118, 127). This often results in loss of genes required for mammalian infectivity and tick survival, acquisition, and transmission (26, 145, 173). Typically *B. burgdorferi* plasmid content is determined through a series of plasmid-specific PCR reactions (97). As the sequences for all *B. hermsii* plasmids are not yet available, we used PFGE to assess plasmid content in our knockout and complement strains (Figure 20E). As determined by PFGE, there were no visible changes in the plasmid profile of the deletion and complemented strains. To further assess these strains, we performed SDS-PAGE and Coomassie R-250 staining to determine if gross alterations in protein profile were observed in any of the strains used in these studies. No changes were detected (Figure 20F). This work was performed in collaboration with Dr. Lee T. Szkotnicki and Katie Mallory.

Figure 20. Generation and characterization of a *Δrrp1* and *ΔpdeA* deletion mutant and complement strains. To determine if cyclic-di-GMP metabolism influences the pathogenesis of *B. hermsii*, null strains *BhDAHΔpdeA* and *BhDAHΔrrp1* and allelic replacement strains *BhDAHpdeA::kanR* and *BhDAHrrp1::kanR* were generated using allelic exchange mutagenesis (B). PCR confirmed proper integration (C). Primer locations are indicated in A and B. Growth rates were determined at 25, 33, and 37°C (D)(Graph representative of 37°C). Linear plasmid profile was determined for each strain by pulsed-field gel electrophoresis (E). A total protein profile for each tested strain was obtained by running cell lysate on an acrylamide gel and subsequently staining with coomassie blue (F).

A.

$\Delta pdeA$

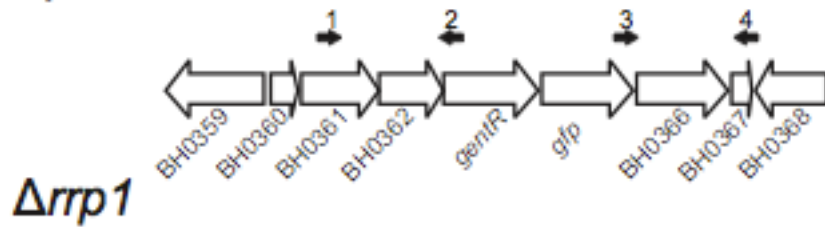

$\Delta rrp1$



B.

$pdeA::kanR$

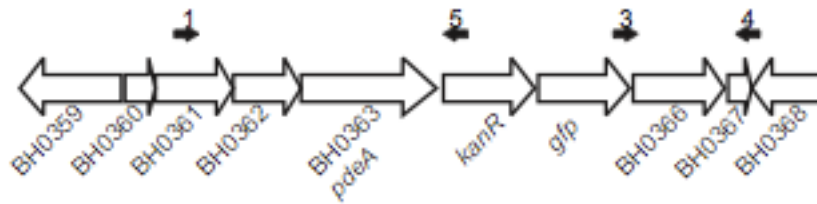

$rrp1::kanR$



C.

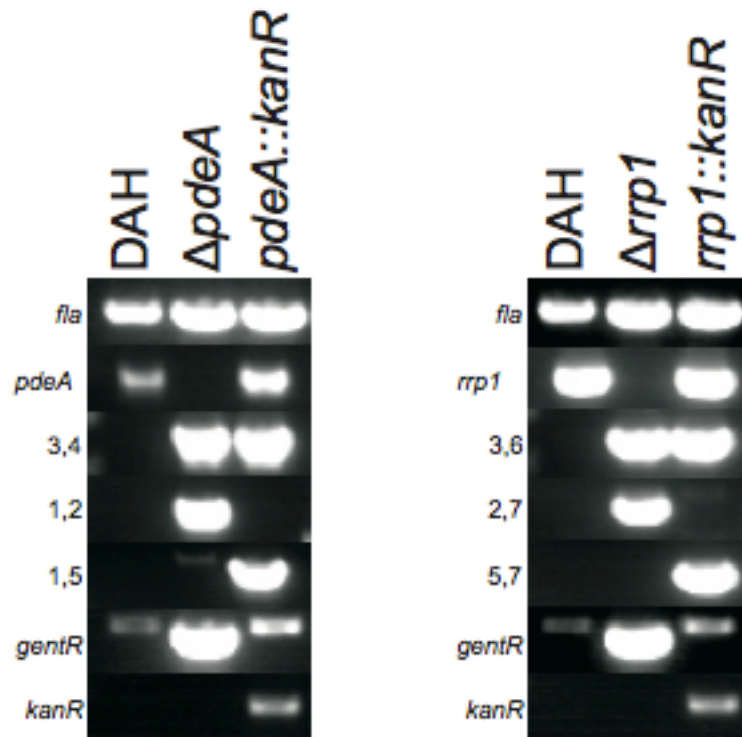

D.

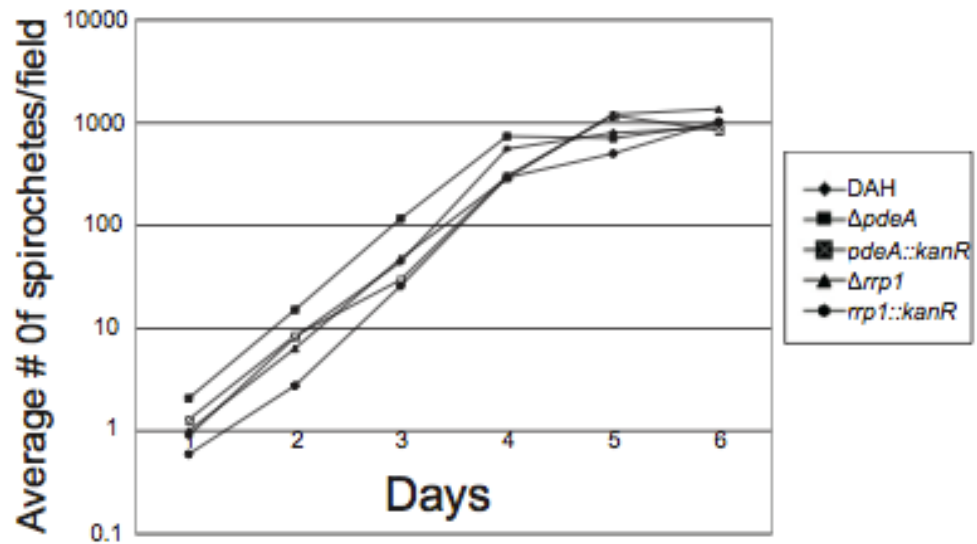

E

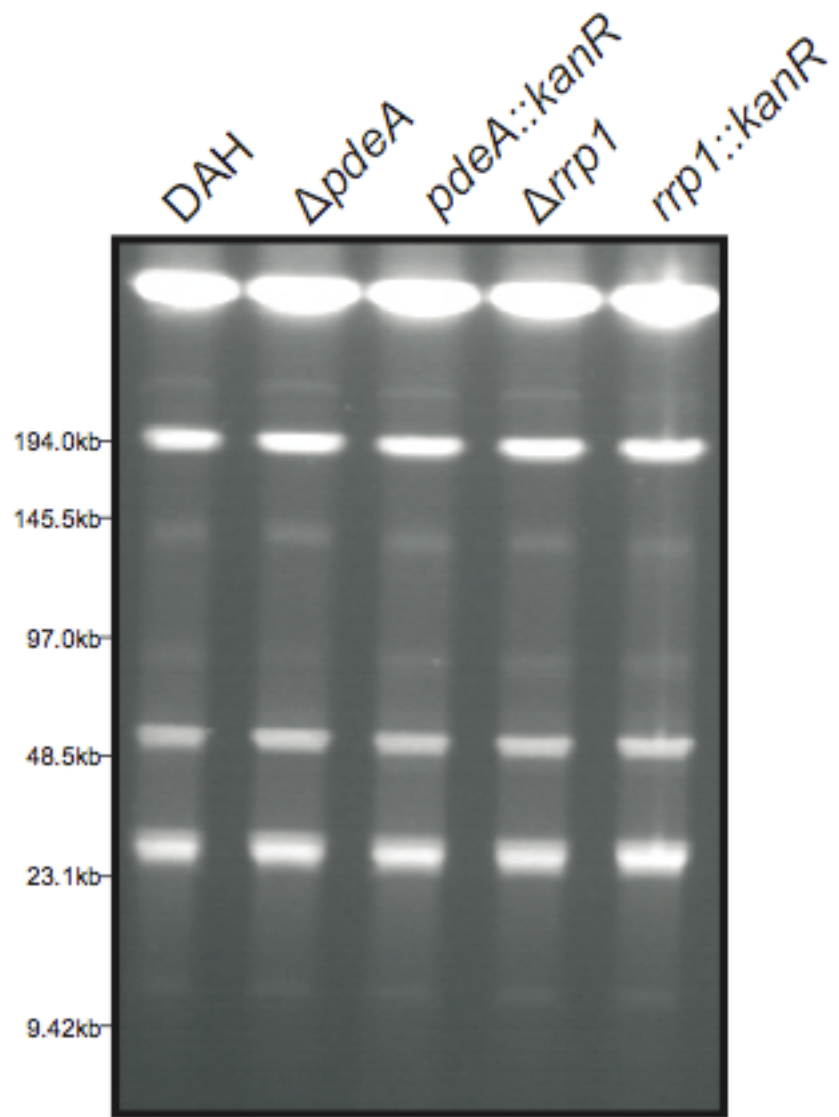

F.

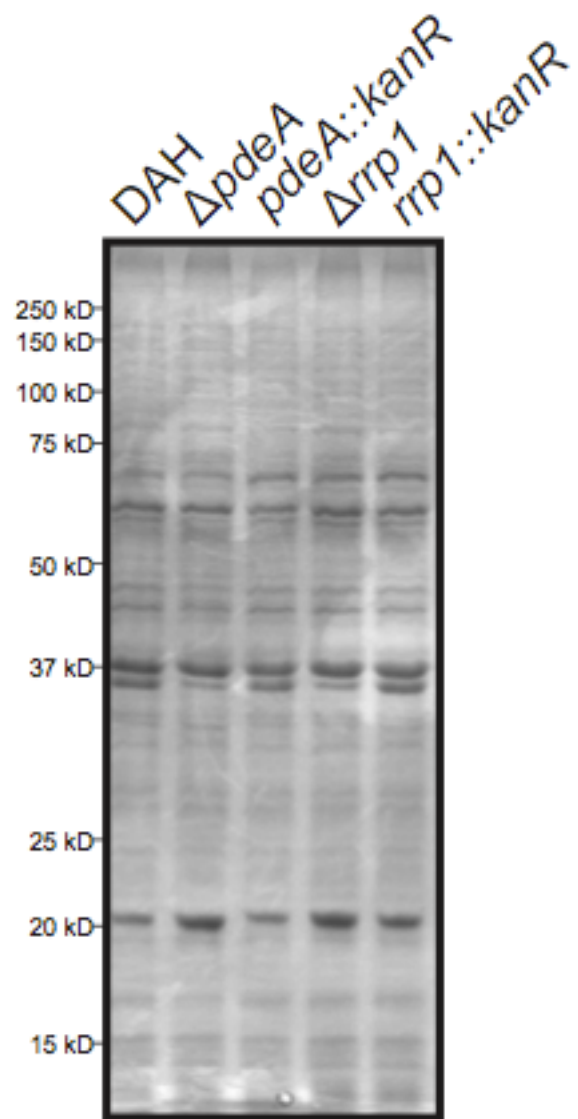

***B. hermsii* cells lacking *pdeA* accumulate cyclic-di-GMP compared to the wild type and *rrp1* mutant**

In order to understand the role of c-di-GMP in the TBRF spirochete, *B. hermsii*, it was essential to determine the intracellular levels both in wild type and mutant strains. C-di-GMP content was determined in all *B. hermsii* strains by HPLC analysis as described in Antoniani *et al.* (5). C-di-GMP was detected in the *BhDAHΔpdeA* strain, as demonstrated by the spiked c-di-GMP standard co-eluting with the peak from the acid-soluble phase from this strain (Figure 21A). Notably, the peak was not detected in the wild-type, *BhDAHΔrrp1*, *BhDAHrrp1::kanR* or *BhDAHpdeA::kanR* strains. (Figure 21A-B). The peak identified in the *BhDAHΔpdeA* mutant was confirmed by identical UV absorption with c-di-GMP standard (not shown) and by the increase of the peak area of the c-di-GMP peak when purified c-di-GMP was added to the *BhDAHΔpdeA* acid-soluble extract (Fig 21C). Cyclic-di-GMP content in the *BhDAHΔpdeA* mutant strain was normalized to the cell dry weight and was determined to be 1.83 ± 0.2 pmol/mg. This work was performed in collaboration with Paola Bocci and Nadia Raffaelli (Univesita Politecnica delle Marche).

Loss of both *rrp1* and *pdeA* result in an attenuated murine infection

In order to assess infectivity, 1×10^4 spirochetes (wild type, *rrp1/pdeA* deletion and complemented strains) were subcutaneously injected into mice. At 3 days post-inoculation, blood was collected and the presence of spirochetes was assessed by dark-field microscopy and by fluorescent detection of GFP. This collection continued daily for 12 days. The average spirochete load for the mice (n=3) is shown in Figure 22.

Figure 21. *B. hermsii* cells lacking *pdeA* accumulate cyclic-di-GMP compared to the wild type and *rrp1* mutant. To determine the intracellular levels of cyclic-di-GMP, HPLC chromatograms of acid soluble extracts were prepared from *B. hermsii* wild type (green peak), *pdeA/rrp1* deletion mutant (blue peak), and its complemented strain (pink peak) (A and B). The chromatographic profile of a c-di-GMP standard is depicted as a dotted line in both A and B. The peak observed in the $\Delta pdeA$ strain was confirmed by addition of cyclic-di-GMP standard to the $\Delta pdeA$ extract. HPLC chromatogram of the unspiked extract of *pdeA* deletion mutant (blue peak) in comparison with c-di-GMP spiked extract (red peak) (C).

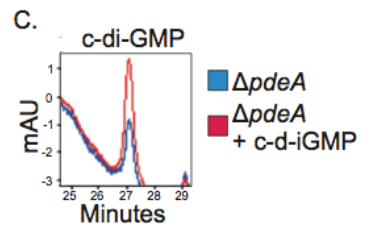
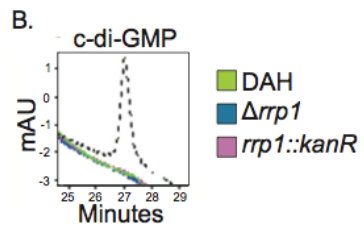
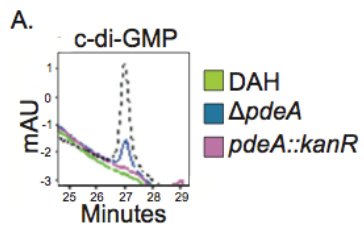

The wild type, *BhDAHrrp1::kanR* and *BhDAHpdeA::kanR* strains all displayed similar levels of spirochetemia in the blood, with observable spirochetes in 3 out of 3 mice at the two days displaying peaks (Day 4 and Day 10). The *BhDAHΔrrp1* and *BhDAHΔpdeA* mutant cells displayed very different patterns of spirochetemia. While we were never able to detect the *BhDAHΔrrp1* spirochetes in blood, the *BhDAHΔpdeA* mutant strain was detectable at very low levels. *BhDAHΔpdeA* demonstrated observable spirochetes in the blood, concurrent with the initial peak observed in the control strains. Additionally, spirochetes were observed in this strain at Day 8 (in 1 of 3 mice) and Day 13 (in 2 of 3 mice).

In order to further assess infectivity, serum was collected from the same mice at 4 weeks post-inoculation and used to determine seroconversion through ELISA and western blotting (Figure 23A and B). Mice infected with wild type, *BhDAHrrp1::kanR*, and *BhDAHpdeA::kanR* all had equivalent IgG titers while the *BhDAHΔrrp1* and *BhDAHΔpdeA* both displayed a significant 3-fold reduction in IgG titer. In an effort to compare the IgG responses of the infected mice, the pattern of antigen recognition was assessed by blotting *B. hermsii* DAH whole cell lysates onto PVDF and screening the blots with equivalent amounts of serum from each infected mouse. Similar to the results obtained in the ELISA, the immunoblot showed attenuation in antigenic recognition by mice infected with the *rrp1* and *pdeA* deletion strains. These data suggest that proper regulation of c-di-GMP levels is required for productive *B. hermsii* infection. This analysis was performed in collaboration with Dr. Lee T. Szkotnicki.

Figure 22. Loss of both *rrp1* and *pdeA* result in an attenuated murine infection.

Infectivity of both *rrp1* and *pdeA* mutants were determined by subcutaneously needle inoculation of 10^4 spirochetes in C3H-HeJ mice (3 mice per *Borrelia* genotype).

Spirochetemia was assessed from days 3-14 and spirochetes/mL of blood were calculated using enumeration of 10 40x fields at each day. Average numbers from each time point were graphed and representative peaks are shown in the graph.

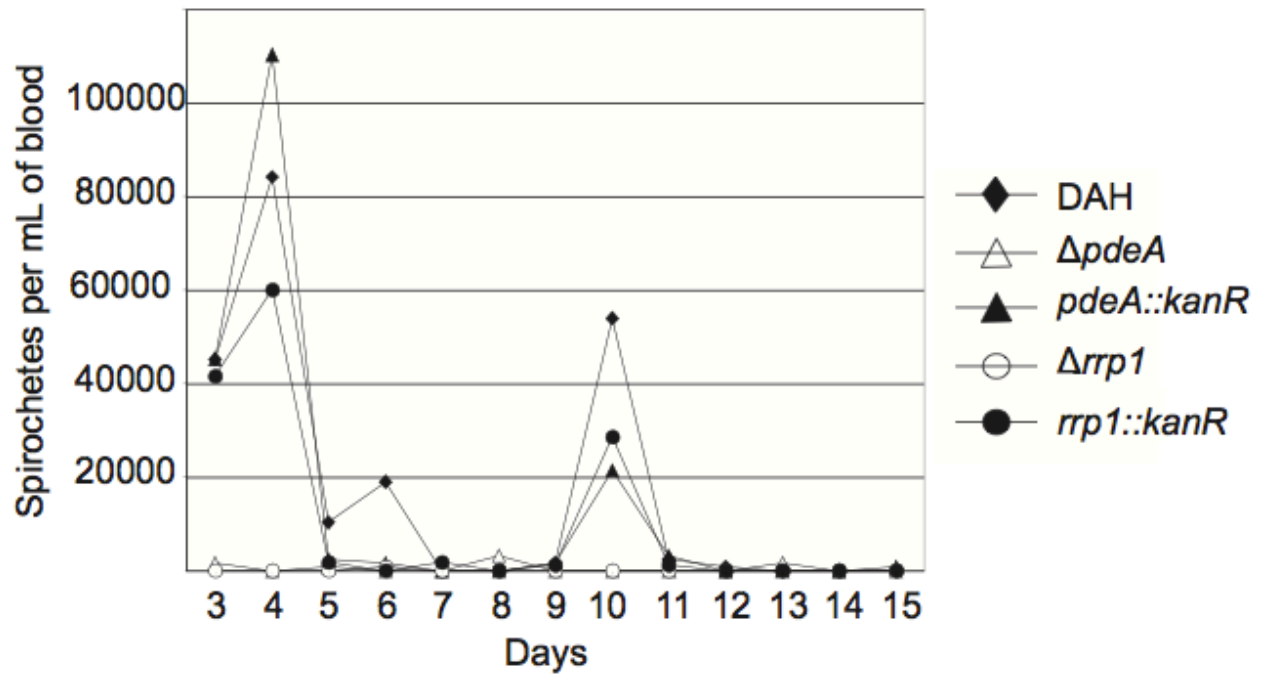
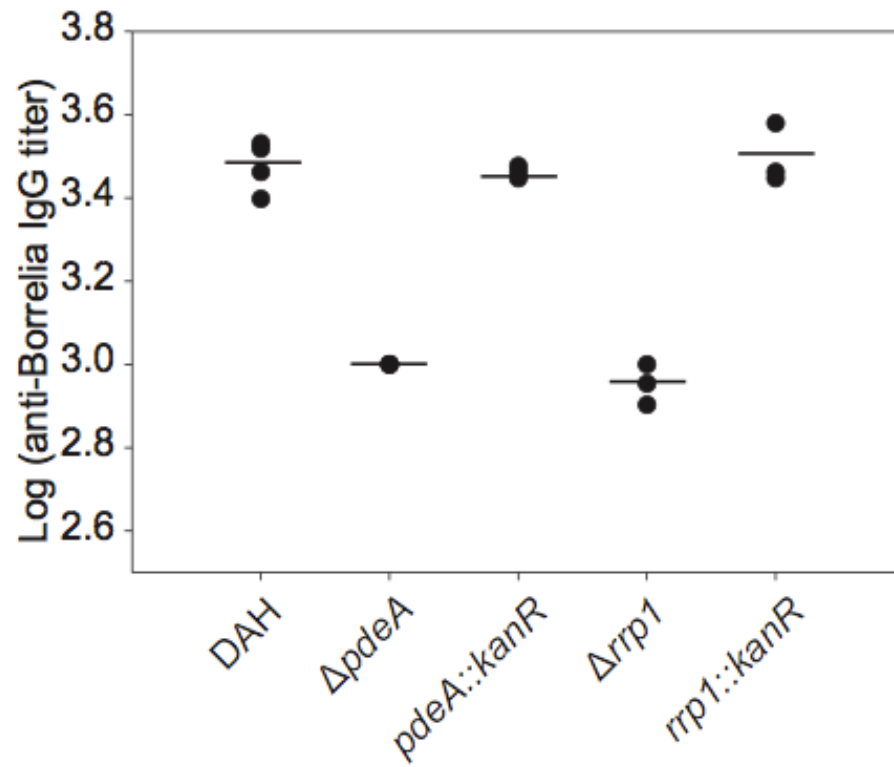
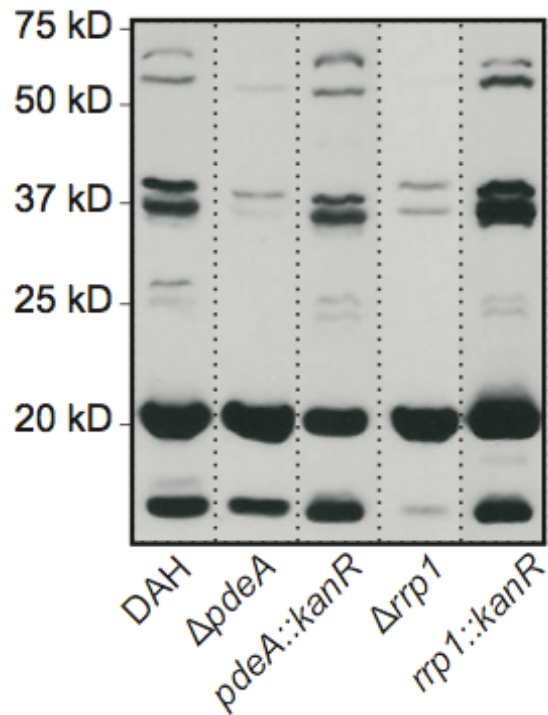

Figure 23. Serological analysis of mice infected with *rrp1* and *pdeA* deletion mutants. Seroconversion was assessed 4 weeks post-infection by whole cell ELISA and western blot. Serum was harvested from infected mice and IgG titers were assessed by ELISA (A) and patterns of antigen recognition were assessed by immunoblotting against *B. burgdorferi* whole cell lysates (B).

A)



B)



Characterization of the roles of PdeA and Rrp1 in motility and chemotaxis

Recent work in *B. burgdorferi* has demonstrated that cells lacking either Rrp1 or PdeA display dramatic motility and chemotaxis defects (80, 125, 160). This combined with other previous work in *Vibrio*, *Escherichia*, and *Salmonella*, suggests that altered motility may play a role in the attenuation of the mutant *B. hermsii* infectivity (41, 79, 88, 111, 117, 134). We assessed the effects of Rrp1 and PdeA on the *B. hermsii* motility by observing and recording cell movement in the presence of 1% methylcellulose. Subsequent movies were used to calculate the average velocity and motility patterns of the TBRF spirochetes. All strains displayed similar patterns of wave propagation, average run speed and average number of stops/reverses (Figure 24A). Additionally we assessed motility using agarose swarming assays. Only cells lacking *pdeA* displayed a significant reduction in swarming diameter compared to the other 4 strains used in all studies (Figure 24B). Finally, we assessed chemotaxis towards a known *B. burgdorferi* chemoattractant, N-acetyl-D-glucosamine (NAG). NAG is a monomer of chitin, a molecule abundant in ticks, which is required for growth of *B. burgdorferi* in culture. Wild type *B. hermsii* and *BhDAHΔpdeA* are equally attracted to NAG. Conversely, the *rrp1* containing strain showed reduced attraction to NAG. Taken together, levels of c-di-GMP appear to be important in coordination of motility and chemotaxis (Figure 24C). Motility analyses were performed by Dr. Lee. T. Szkotnicki.

Discussion

Cyclic di-GMP is an integrally important bacterial second messenger that has been linked to pathogenesis in a number of different microorganisms including *V.*

Figure 24. Characterization of PdeA and Rrp1 mutants effect on motility and chemotaxis. Translational movement patterns were obtained by capturing DIC microscopy movies of the wild type mutant and complement strains. Motion tracking software was used to display the movement patterns of the spirochetes. Stills taken from representative movies are shown in (A). The ability of the *B. hermsii* mutants to swarm in semi-solid BSK plates was determined as described for *B. burgdorferi*. Motility defects were found to be statistically significant (B). Attraction towards *N*-acetyl-D-glucosamine was determined by use of a modified capillary assay as described in the methods and materials and text (C).

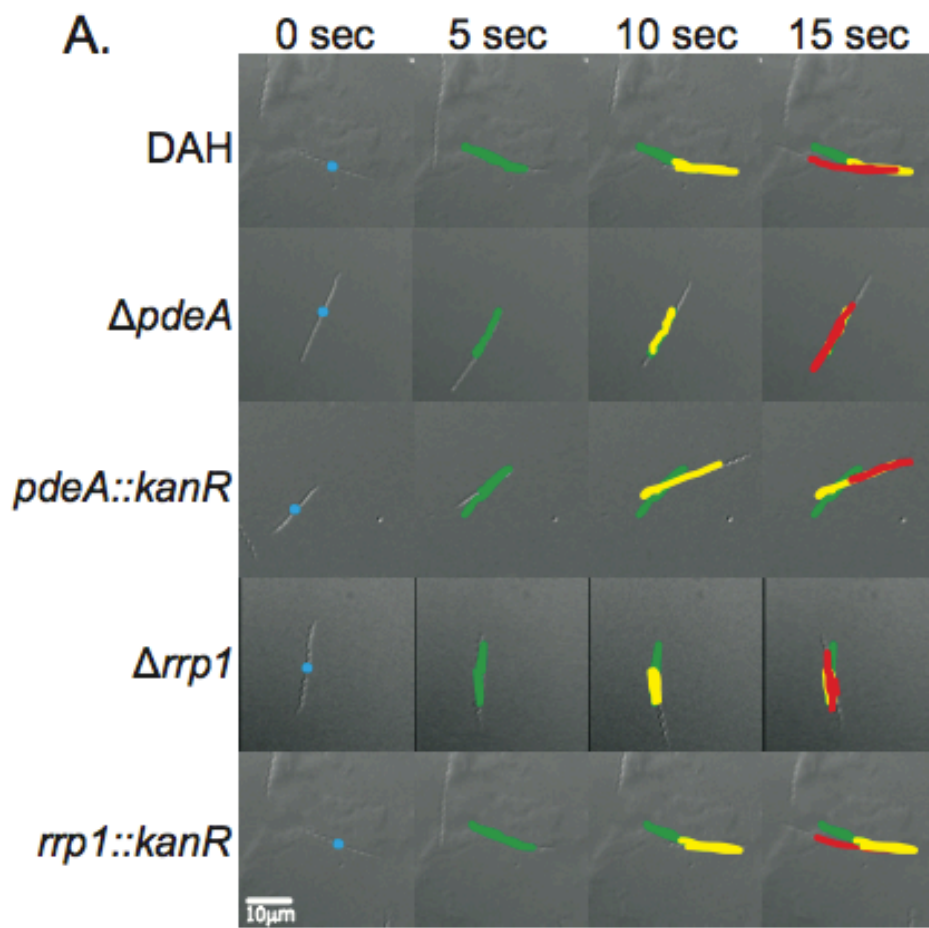

B.

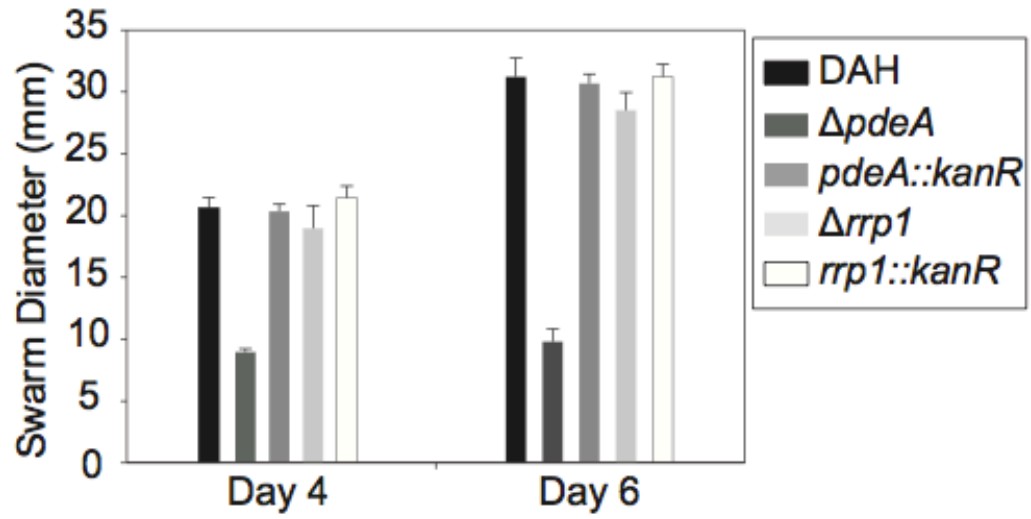

C.

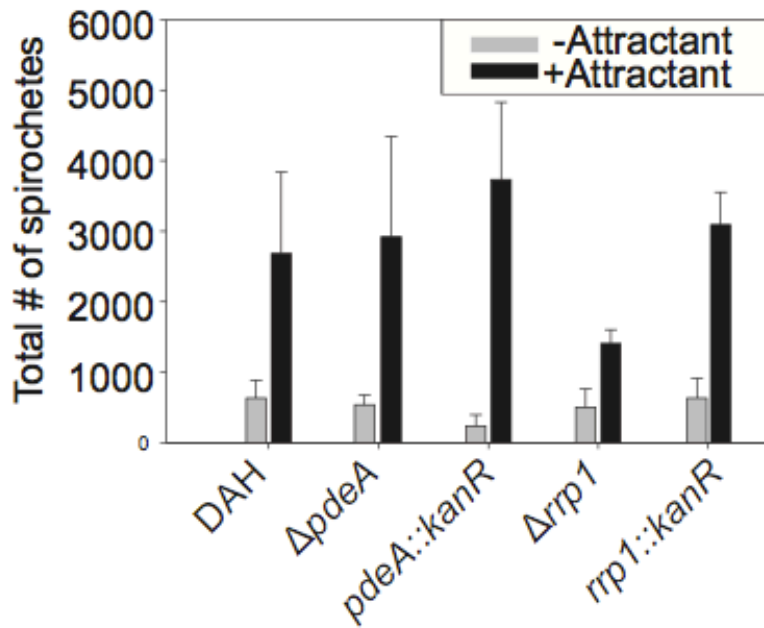

cholerae, *E. coli*, *S. enterica*, *P. aeruginosa*, and *B. burgdorferi* among others. Results have shown effects of cyclic di-GMP on locomotion, biofilm formation, chemotaxis, as well as changes in gene expression (19, 20, 58, 71, 82, 92, 100, 105, 111, 116, 125, 126, 160). Some of the more recent work has been focused on the elucidation of the role of c-di-GMP in the Lyme disease spirochete *B. burgdorferi*. In fact, several recent papers have detailed allelic replacement and analysis of the sole diguanylate cyclase (*rrp1*), EAL domain-containing phosphodiesterase (*pdeA*), HD-GYP domain-containing protein (*pdeB*), and the PilZ domain-containing protein of *BbB31* (PlzA) (28, 58, 68, 80, 116, 125, 159, 160).

The goal of this study was to bring TBRF spirochetes into the forefront of the c-di-GMP signaling field as a model organism for its study. Much like the Lyme spirochete, *B. burgdorferi*, *B. hermsii* provides an ideal system in which to study c-di-GMP-mediated regulation, as its genome contains only a single copy of the genes required to synthesize and degrade cyclic di-GMP. A significant difference between these species is the fact that *B. hermsii* is capable of reaching truly staggering numbers in the host animal's blood (51). The large number and swift peaking of spirochetes in the blood allows for simple observation of infection, and will allow for monitoring of gene expression and various phenotypes at different time points during infection. This offers an advantage over the Lyme disease model in that more time points can be taken and fewer animals need be used. Thus, a wider depth of knowledge of signaling in this unique organism will be obtained.

Initially, we identified genes responsible for c-di-GMP metabolism, and subsequent *in vitro* experimentation provided evidence that the PdeA and Rrp1

components of the *B. hermsii* c-di-GMP signaling pathway are active enzymes capable of the breakdown and synthesis of c-di-GMP, respectively (58, 135, 160). Here, we demonstrate that Rrp1 of *B. hermsii* is an active DGC upon phosphorylation of an aspartic acid of the receiver domain (Figure 18). While we artificially phosphorylated the protein using AcP, we believe that the cognate histidine kinase of Rrp1, Hpk1, activates the hybrid response regulator/DGC within bacterial cells. Of note, is that when unphosphorylated Rrp1 is incubated with GTP, we observed 2 peaks shifted to the left relative to retention volume of GTP. One possibility is that non-activated Rrp1 is capable of cleaving the γ or β phosphates of GTP, while not being able to carry out any cyclase activity. It is unknown what, if any, relevance this activity has to either relapsing fever or Lyme *Borrelia* biology.

As was demonstrated for PdeA from *B. burgdorferi*, PdeA from *B. hermsii* is an EAL domain-containing PDE capable of the specific breakdown of c-di-GMP into l-di-GMP. Additionally, PdeA from *B. hermsii* did not demonstrate an increase in activity in the presence of Mn^{2+} as was the case for PdeA from *B. burgdorferi* (160). Differences in divalent specificity may be because of slight differences in protein sequence and structure, such that proper coordination of the divalent cation at the active site is achieved (116, 159, 160). Taken together, *B. hermsii* possesses the components needed to synthesize c-di-GMP in a signal/activation-dependant manner, as well as degrade it into l-di-GMP. It is unknown what, if any, effects l-di-GMP might have in the *Borrelia* or in other species. However, it is important to note that these opposing activities may regulate processes important in motility and mammalian infection.

As previously described, genetic manipulation of *B. hermsii* has recently come to the forefront of emerging techniques important in understanding these unique organisms (12, 53). These important molecular tools will be paramount in describing virulence factors important in the *B. hermsii* disease process. Here, we deleted the open reading frames encoding the proteins PdeA and Rrp1, by allelic exchange with a gentamycin resistance-*gfp* cassette. We also created strains that were functionally complemented *in cis* with a kanamycin resistance-*gfp* cassette. Initial growth analyses demonstrated equal growth rates at 23°C, 33°C, and 37°C of all strains (Figure 20D). Additional testing revealed that both linear plasmid composition (Figure 20E) and protein profile (Figure 20F) are indistinguishable for wild type and mutant strains.

It is currently unknown what signal results in the activation of Rrp1 and thus in the production of cyclic-di-GMP. We have been unsuccessful in detecting c-di-GMP in wild type *B. hermsii* growing in an *in vitro* setting. These results are similar to those described in Kostick *et al.* (80) in that we were also unable to detect cyclic-di-GMP in the wild-type *B. burgdorferi* or *rrp1* deletion strains. However, we successfully demonstrated by quantitative HPLC that our *pdeA* null strain does accumulate cyclic-di-GMP. It may be that the signal(s) responsible for Hpk1/Rrp1 activation are not present under *in vitro* conditions, as c-di-GMP is not robustly present in wild type and *rrp1* deletion strains. These signals may be present in tick environment, as it has been shown that the proteins involved in c-di-GMP synthesis/breakdown and binding have their largest effects in tick environment (28, 58, 68, 80, 116, 125, 159, 160).

In order to assess the effects of the c-di-GMP signaling components of *B. hermsii* on mammalian infectivity, we infected C3H/HeJ mice (n=3) subcutaneously with 10^4

spirochetes of *BhDAHΔrrp1*, *BhDAHΔpdeA*, *BhDAHpdeA::kanR*, *BhDAHrrp1::kanR*, and the wild type strains. Spirochete burden in the blood was analyzed each day for 21 days via microscopy and counting, and infectivity was also assessed via serology using ELISA and western blotting analysis. Via microscopy, we observed zero spirochetes in *BhDAHΔrrp1*, and seldom viewed spirochetes in *BhDAHΔpdeA* at any time point. Conversely, wild type *B. hermsii* and both complemented strains were counted in blood, and peaks of spirochetemic relapses coincided with each other. Additionally, we assessed antibody titers by ELISA, and observed a three-fold lower titer in both $\Delta pdeA$ and $\Delta rrp1$ as compared to wild type *B. hermsii* DAH and complemented strains. We also assessed seroconversion by screening immobilized *B. hermsii* whole cell lysate with serum collected from the infected mice. While we observed seroconversion in all cases, band intensity was markedly reduced when sera from mice infected with $\Delta pdeA$ and $\Delta rrp1$ was employed. Based upon these observations, we conclude that PdeA and Rrp1 are not essential for infection, yet they are required for establishment of a productive relapsing fever infection. It remains to be determined why the deletion mutants failed to thrive in the mammalian environment, and why there was seldom observation of these strains in the blood, i.e. why they display attenuated infectivity. One possibility is that they are unable to reach the bloodstream when inoculated subcutaneously, due to deficiencies in motility and/or chemotaxis, as well as other physiological processes. Another possibility is that these strains are rapidly cleared, while a few persisting cells are able to cause infection long enough to elicit an immune response without causing infection. This is different than the Rrp1 and PdeA signaling components of the Lyme disease spirochete *B. burgdorferi*, where Rrp1 is dispensable

for productive infection and PdeA is absolutely necessary to cause infection. Both diseases and disease processes are quite different, and it may be that these signaling components and c-di-GMP itself, function differently between the different species.

Because c-di-GMP has been described to affect motility and chemotaxis in *B. burgdorferi* and other organisms, we assessed the ability of *B. hermsii* DAH deficient in Rrp1 and PdeA, to move and chemotax normally as compared to the parental strain (116, 117, 134, 160, 169) Microscopic analysis of movement demonstrated that *rrp1* and *pdeA* null strains behave similarly to wild type *B. hermsii* DAH, as they all displayed similar patterns of wave propagation, average run speed and average number of stops/reverses. Additionally, we assessed motility using the well-described soft agar swarming assay. Only the *pdeA* null strain demonstrated a reduction in swarming, indicating that elevated levels of c-di-GMP may inhibit motility on or in surfaces that support spirochetal growth. This is similar to what has been described in *B. burgdorferi*, however, the phenotype exhibited appears to be much more affected by elevated c-di-GMP levels in *B. hermsii*. In fact high levels of cyclic-di-GMP have been shown in other systems to be indicative of a sedentary, non-motile existence (69). Differences in motility control may be affected adversely at the level of protein-protein, protein-RNA, or protein-DNA interactions, as controlled by a yet-to-be described means of c-di-GMP-mediated motility control. Such interactions have been described in other organisms such as *E. coli* and *V. cholerae* (49, 76, 150). Finally, the chemotactic response was decreased in the *rrp1* null strain, indicating that Rrp1 and thus c-di-GMP positively regulates chemotaxis of *B. hermsii* towards *N*-acetyl glucosamine. This result is surprisingly similar to those recently described in Kostick *et al.* (80).

In summary, this study demonstrates that Rrp1 and PdeA of *B. hermsii* regulate processes important in the infection and motility of the TBRF spirochetes. Deletion of both *rrp1* and *pdeA* prevented the establishment of a productive population during murine infection. While the deletion of *rrp1* attenuated swarming motility of *B. hermsii*, deletion of *pdeA* did not. Similarly to *B. burgdorferi*, Rrp1 was found to be important in chemotactic responses. Both motility and chemotactic responses are likely to be critical for processes important for *B. hermsii* mammalian infection and potentially, survival in the tick environment. Unfortunately, access to *Ornithodoros hermsii* ticks is extremely limited and these experiments were unable to be performed. Since both Rrp1 and PdeA have DGC and PDE activity, respectively, it is likely important that levels of c-di-GMP are crucial for the phenotypes observed. Because the Rrp1 and PdeA-associated phenotypes in *B. hermsii* are slightly different than those observed in *B. burgdorferi*, it may be that c-di-GMP works in a different manner in both of these systems. It will be important to consider these differences in future studies of both organisms.

Acknowledgements

I would like to thank Dr. Lee Szkotnicki for all of his help and discussion about the project. Additionally, I would like to thank him for his work at the VCU Microscopy Facility.

Chapter 6: Conclusions

Both Lyme disease and tick-borne relapsing fever (TBRF) are diseases of worldwide health importance. The Lyme disease *Borrelia* exist in nature in an enzootic cycle between *Ixodes* hard-bodied tick vectors and mammalian reservoirs, and the TBRF *Borrelia* exist in an enzootic niche involving *Ornithodoros* soft-bodied tick vectors and mammals. While both groups of *Borrelia* exist in diverse reservoirs, geographic locations, and cause different diseases, they have both evolved and maintained the same and/or similar putative physiological and genetic regulatory mechanisms. As is such, both groups of *Borrelia* have the capacity to rapidly adapt to changing environmental conditions in ticks/mammals. One way in which they are able to do this is through the use of one of the two two-component regulatory systems (TCRS) with global regulatory capabilities. Of interest is the TCRS involving Hpk1/Rrp1 and the production of the second messenger c-di-GMP. Because c-di-GMP must interact with downstream effector molecules in order to translate its synthesis into physiological outcomes, we analyzed the PilZ domain-containing proteins PlzA and PlzB of *B. burgdorferi* with the goal of defining functions of PlzA and PlzB, as well as building a better understanding c-di-GMP signaling in the Lyme disease spirochetes. It was determined that *plzA* is universally distributed amongst *B. burgdorferi sensu lato*, that it is

upregulated in ticks during feeding, and that its expression is maintained during mammalian infection. These data are similar to what was seen for *rrp1*, as both have similar patterns of expression. With the fact that Rrp1 is the lone DGC encoded for in the *Borrelia* genome, it is not surprising that a proposed effector protein would be important during similar times during the enzootic cycle. Additionally, it was demonstrated that both PlzA and PlzB bind c-di-GMP with high specificity, and that this binding is accomplished via arginine residues that are a part of c-di-GMP binding switch (in terms of PlzA, and likely PlzB).

The distribution of *plzB* was also assessed in a diverse range of strains, and was found to be carried in about 40% of isolates tested. What advantage PlzB offers such isolates remains unclear. PlzA was shown to be important in the motility of *B. burgdorferi*, as its deletion results in decreases swarming, slower velocity, and decreased flexing. This aberrant motility may provide a clue as to why deletion of *plzA* results in noninfective spirochetes. Simply, motility as regulated by c-di-GMP and PlzA, may be important for transmission to the mammalian host, as well as dissemination through host tissues, processes that are likely important in host survival and evasion. PlzB was unable to compensate for a loss of PlzA function in all phenotypes examined. Taken together, these studies indicate that PlzA is essential in successful completion of the enzootic cycle of *B. burgdorferi*, and that it may directly or indirectly regulate the motility of this unique organism.

Finally, we assessed the DGC, Rrp1, and EAL PDE, PdeA of *B. hermsii*. Both proteins maintained their enzymatic activity as described for *B. burgdorferi*, and both were shown to be necessary for productive infection TBRF infection. PdeA, but not

Rrp1, was shown to be important in the positive regulation of motility. Interestingly, Rrp1 of *B. burgdorferi* was nonessential for murine infection and was shown to be a positive regulator of motility. Rrp1 of *B. hermsii* was also shown to be important in the chemotaxis towards NAG. While these proteins have similar functions, it may be that the regulation and/or activities of the *B. hermsii* c-di-GMP signaling components are needed during different processes important for their survival in nature.

Taken together, the work provided here demonstrates an importance for c-di-GMP and c-di-GMP signaling in the Lyme disease and tick-borne relapsing fever *Borrelia*. While all of the answers involving the importance of c-di-GMP and its mechanism(s) of action are not clear, the work here provides a framework for future experiments that will allow for the synthesis of a well-defined model of c-di-GMP signaling in *Borrelia spp.* A better understanding of c-di-GMP signaling in the *Borrelia* may shine light onto other c-di-GMP signaling networks in other bacteria and may provide a pillar for future drug discovery and or treatments.

Literature Cited

Literature Cited

1. **Aldridge, P., R. Paul, P. Goymer, P. Rainey, and U. Jenal.** 2003. Role of the GGDEF regulator PleD in polar development of *Caulobacter crescentus*. *Mol. Microbiol.* **47**:1695-1708.
2. **Alverson, J., S. F. Bundle, C. D. Sohaskey, M. C. Lybecker, and D. S. Samuels.** 2003. Transcriptional regulation of the *ospAB* and *ospC* promoters from *Borrelia burgdorferi*. *Mol. Microbiol.* **48**:1665-1677.
3. **Amikam, D., and M. Y. Galperin.** 2006. PilZ domain is part of the bacterial c-di-GMP binding protein. *Bioinformatics* **22**:3-6.
4. **Anderson, J. F., and L. A. Magnarelli.** 2008. Biology of ticks. *Infect. Dis. Clin. North Am.* **22**:195-215, v.
5. **Antoniani, D., P. Bocci, A. Maciag, N. Raffaelli, and P. Landini.** 2010. Monitoring of diguanylate cyclase activity and of cyclic-di-GMP biosynthesis by whole-cell assays suitable for high-throughput screening of biofilm inhibitors. *Appl. Microbiol. Biotechnol.* **85**:1095-1104.
6. **Ausmees, N., R. Mayer, H. Weinhouse, G. Volman, D. Amikam, M. Benziman, and M. Lindberg.** 2001. Genetic data indicate that proteins containing the GGDEF domain possess diguanylate cyclase activity. *FEMS Microbiol. Lett.* **204**:163-167.
7. **Bacon, R. M., K. J. Kugeler, and P. S. Mead.** 2008. Surveillance for Lyme disease--United States, 1992-2006. *MMWR. Surveill. Summ.* **57**:1-9.
8. **Bakker, R. G., C. Li, M. R. Miller, C. Cunningham, and N. W. Charon.** 2007. Identification of specific chemoattractants and genetic complementation of a *Borrelia burgdorferi* chemotaxis mutant: flow cytometry-based capillary tube chemotaxis assay. *Appl. Environ. Microbiol.* **73**:1180-1188.
9. **Barbour, A. G., and S. F. Hayes.** 1986. Biology of *Borrelia* species. *Microbiol. Rev.* **50**:381-400.

10. **Baril, C., C. Richaud, G. Baranton, and I. Saint Girons.** 1989. Linear chromosome of *Borrelia burgdorferi*. Res. Microbiol. **140**:507-516.
11. **Batsford, S., J. Dunn, and M. Mihatsch.** 2004. Outer surface lipoproteins of *Borrelia burgdorferi* vary in their ability to induce experimental joint injury. Arthritis Rheum. **50**:2360-2369.
12. **Battisti, J. M., S. J. Raffel, and T. G. Schwan.** 2008. A system for site-specific genetic manipulation of the relapsing fever spirochete *Borrelia hermsii*. Methods Mol. Biol. **431**:69-84.
13. **Benach, J., S. S. Swaminathan, R. Tamayo, S. K. Handelman, E. Folta-Stogniew, J. E. Ramos, F. Forouhar, H. Neely, J. Seetharaman, A. Camilli, and J. F. Hunt.** 2007. The structural basis of cyclic diguanylate signal transduction by PilZ domains. EMBO J. **26**:5153-5166.
14. **Benach, J. L., E. M. Bosler, J. P. Hanrahan, J. L. Coleman, G. S. Habicht, T. F. Bast, D. J. Cameron, J. L. Ziegler, A. G. Barbour, W. Burgdorfer, R. Edelman, and R. A. Kaslow.** 1983. Spirochetes isolated from the blood of two patients with Lyme disease. N Engl J Med **308**:740-742.
15. **Bernlohr, R. W., M. K. Haddox, and N. D. Goldberg.** 1974. Cyclic guanosine 3':5'-monophosphate in *Escherichia coli* and *Bacillus licheniformis*. J. Biol. Chem. **249**:4329-4331.
16. **Black, R. A., A. C. Hobson, and J. Adler.** 1980. Involvement of cyclic GMP in intracellular signaling in the chemotactic response of *Escherichia coli*. Proc. Natl. Acad. Sci. U. S. A. **77**:3879-3883.
17. **Blevins, J. S., H. Xu, M. He, M. V. Norgard, L. Reitzer, and X. F. Yang.** 2009. Rrp2, a σ^{54} -dependent transcriptional activator of *Borrelia burgdorferi*, activates rpoS in an enhancer-independent manner. J. Bacteriol. **191**:2902-2905.
18. **Boardman, B. K., M. He, Z. Ouyang, H. Xu, X. Pang, and X. F. Yang.** 2008. Essential role of the response regulator Rrp2 in the infectious cycle of *Borrelia burgdorferi*. Infect. Immun. **76**:3844-3853.
19. **Bobrov, A. G., O. Kirillina, and R. D. Perry.** 2007. Regulation of biofilm formation in *Yersinia pestis*. Adv. Exp. Med. Biol. **603**:201-210.
20. **Boehm, A., M. Kaiser, H. Li, C. Spangler, C. A. Kasper, M. Ackermann, V. Kaever, V. Sourjik, V. Roth, and U. Jenal.** Second messenger-mediated adjustment of bacterial swimming velocity. Cell **141**:107-116.
21. **Bratton, R. L., J. W. Whiteside, M. J. Hovan, R. L. Engle, and F. D. Edwards.** 2008. Diagnosis and treatment of Lyme disease. Mayo Clin. Proc. **83**:566-571.

22. **Brooks, C. S., P. S. Hefty, S. E. Joliff, and D. R. Akins.** 2003. Global analysis of *Borrelia burgdorferi* genes regulated by mammalian host-specific signals. *Infect. Immun.* **71**:3371-3383.
23. **Burgdorfer, W., A. G. Barbour, S. F. Hayes, J. L. Benach, E. Grunwaldt, and J. P. Davis.** 1982. Lyme disease--a tick-borne spirochetosis? *Science* **216**:1317-1319.
24. **Burnnick, M. N., J. S. Downey, P. J. Brett, J. A. Boylan, J. G. Frye, T. R. Hoover, and F. C. Gherardini.** 2007. Insights into the complex regulation of *rpoS* in *Borrelia burgdorferi*. *Mol. Microbiol.* **65**:277-293.
25. **Busch, U., C. Hizo-Teufel, R. Boehmer, V. Fingerle, H. Nitschko, B. Wilske, and V. Preac-Mursic.** 1996. Three species of *Borrelia burgdorferi* sensu lato (*B. burgdorferi* sensu lato, *B. afzelii*, and *B. garinii*) identified from cerebrospinal fluid isolates by pulsed field gel electrophoresis and PCR. *J. Clin. Microbiol.* **34**:1072-1078.
26. **Busch, U., G. Will, C. Hizo-Teufel, B. Wilske, and V. Preac-Mursic.** 1997. Long-term in vitro cultivation of *Borrelia burgdorferi* sensu lato strains: influence on plasmid patterns, genome stability and expression of proteins. *Res. Microbiol.* **148**:109-118.
27. **Cadavid, D., and A. G. Barbour.** 1998. Neuroborreliosis during relapsing fever: Review of the clinical manifestations, pathology and treatment of infections in humans and experimental animals. *Clin. Infect. Dis.* **26**:151-164.
28. **Caimano, M. J., M. R. Kenedy, T. Kairu, D. C. Desrosiers, M. Harman, S. Dunham-Ems, D. R. Akins, U. Pal, and J. D. Radolf.** 2011. The Hybrid Histidine Kinase Hk1 Is Part of a Two-Component System That Is Essential for Survival of *Borrelia burgdorferi* in Feeding Ixodes scapularis Ticks. *Infect. Immun.* **79**:3117-3130.
29. **Camilli, A., and B. L. Bassler.** 2006. Bacterial small-molecule signaling pathways. *Science* **311**:1113-1116.
30. **Casjens, S., and W. M. Huang.** 1993. Linear chromosomal physical and genetic map of *Borrelia burgdorferi*, the Lyme disease agent. *Mol. Microbiol.* **8**:967-980.
31. **Casjens, S., N. Palmer, R. van Vugt, W. M. Huang, B. Stevenson, P. Rosa, R. Lathigra, G. Sutton, J. Peterson, R. J. Dodson, D. Haft, E. Hickey, M. Gwinn, O. White, and C. M. Fraser.** 2000. A bacterial genome in flux: the twelve linear and nine circular extrachromosomal DNAs in an infectious isolate of the Lyme disease spirochete *Borrelia burgdorferi*. *Mol. Microbiol.* **35**:490-516.

32. **CDC.** 2010. Reported Lyme disease cases by state, 1999-2009 . Centers for Disease Control and Prevention
http://www.cdc.gov/lyme/stats/chartstables/reportedcases_statelocality.html.
33. **CDC.** 2010. Tick Borne Relapsing Fever Symptoms. Division of Vector Borne Infectious Diseases
http://www.cdc.gov/ncidod/dvbid/RelapsingFever/TBRF_Symptoms.html.
34. **Charon, N. W., S. F. Goldstein, S. M. Block, K. Curci, J. D. Ruby, J. A. Kreiling, and R. J. Limberger.** 1992. Morphology and dynamics of protruding spirochete periplasmic flagella. *J. Bacteriol.* **174**:832-840.
35. **Charon, N. W., S. F. Goldstein, M. Marko, C. Hsieh, L. L. Gebhardt, M. A. Motaleb, C. W. Wolgemuth, R. J. Limberger, and N. Rowe.** 2009. The flat-ribbon configuration of the periplasmic flagella of *Borrelia burgdorferi* and its relationship to motility and morphology. *J. Bacteriol.* **191**:600-607.
36. **Charon, N. W., E. P. Greenberg, M. B. Koopman, and R. J. Limberger.** 1992. Spirochete chemotaxis, motility, and the structure of the spirochetal periplasmic flagella. *Res. Microbiol.* **143**:597-603.
37. **Christen, M., B. Christen, M. G. Allan, M. Folcher, P. Jenö, S. Grzesiek, and U. Jenal.** 2007. DgrA is a member of a new family of cyclic diguanosine monophosphate receptors and controls flagellar motor function in *Caulobacter crescentus*. *Proc. Natl. Acad. Sci. U. S. A.* **104**:4112-4117.
38. **Christen, M., B. Christen, M. Folcher, A. Schauerte, and U. Jenal.** 2005. Identification and characterization of a cyclic di-GMP-specific phosphodiesterase and its allosteric control by GTP. *J. Biol. Chem.* **280**:30829-30837.
39. **Claret, L., S. Miquel, N. Vieille, D. A. Ryjenkov, M. Gomelsky, and A. Darfeuille-Michaud.** 2007. The flagellar sigma factor FliA regulates adhesion and invasion of Crohn disease-associated *Escherichia coli* via a cyclic dimeric GMP-dependent pathway. *J. Biol. Chem.* **282**:33275-33283.
40. **Connolly, S. E., D. G. Thanassi, and J. L. Benach.** 2004. Generation of a Complement-Independent Bactericidal IgM against a Relapsing Fever *Borrelia*. *J. Immunol.* **172**:1191-1197.
41. **Cotter, P. A., and S. Stibitz.** 2007. c-di-GMP-mediated regulation of virulence and biofilm formation. *Curr. Opin. Microbiol.* **10**:17-23.
42. **Cutler, S. J.** 2010. Relapsing fever--a forgotten disease revealed. *J. Appl. Microbiol.* **108**:1115-1122.

43. **Davidson, B. E., J. MacDougall, and I. Saint Girons.** 1992. Physical map of the linear chromosome of the bacterium *Borrelia burgdorferi* 212, a causative agent of Lyme disease, and localization of rRNA genes. *J. Bacteriol.* **174**:3766-3774.
44. **De, N., M. Pirruccello, P. V. Krasteva, N. Bae, R. V. Raghavan, and H. Sondermann.** 2008. Phosphorylation-independent regulation of the diguanylate cyclase WspR. *PLoS Biol* **6**:e67.
45. **de Souza, M. S., E. Fikrig, A. L. Smith, R. A. Flavell, and S. W. Barthold.** 1992. Nonspecific proliferative responses of murine lymphocytes to *Borrelia burgdorferi* antigens. *J. Infect. Dis.* **165**:471-478.
46. **Dombrowski, C., W. Kan, M. A. Motaleb, N. W. Charon, R. E. Goldstein, and C. W. Wolgemuth.** 2009. The elastic basis for the shape of *Borrelia burgdorferi*. *Biophys. J.* **96**:4409-4417.
47. **Dworkin, M. S., T. G. Schwan, D. E. Anderson, Jr., and S. M. Borchardt.** 2008. Tick-borne relapsing fever. *Infect. Dis. Clin. North Am.* **22**:449-468, viii.
48. **Earnhart, C. G., D. V. Leblanc, K. E. Alix, D. C. Desrosiers, J. D. Radolf, and R. T. Marconi.** 2010. Identification of residues within ligand-binding domain 1 (LBD1) of the *Borrelia burgdorferi* OspC protein required for function in the mammalian environment. *Mol. Microbiol.* **76**:393-408.
49. **Fang, X., and M. Gomelsky.** A post-translational, c-di-GMP-dependent mechanism regulating flagellar motility. *Mol. Microbiol.* **76**:1295-1305.
50. **Feder, H. M., Jr., M. Abeles, M. Bernstein, D. Whitaker-Worth, and J. M. Grant-Kels.** 2006. Diagnosis, treatment, and prognosis of erythema migrans and Lyme arthritis. *Clin. Dermatol.* **24**:509-520.
51. **Felsenfeld, O.** 1971. *Borrelia*. Strains, vectors, human and animal borreliosis. Warren H. Green, Inc., St. Louis.
52. **Ferdows, M. S., and A. G. Barbour.** 1989. Megabase-sized linear DNA in the bacterium *Borrelia burgdorferi*, the Lyme disease agent. *Proc. Natl. Acad. Sci. USA* **86**:5969-5973.
53. **Fine, L. M., C. G. Earnhart, and R. T. Marconi.** 2011. Genetic transformation of the relapsing fever spirochete *Borrelia hermsii*: stable integration and expression of green fluorescent protein from linear plasmid 200. *J. Bacteriol.* **193**:3241-3245.
54. **Fish, A. E., Y. B. Pride, and D. S. Pinto.** 2008. Lyme carditis. *Infect. Dis. Clin. North Am.* **22**:275-288, vi.

55. **Fraser, C. M., S. Casjens, W. M. Huang, G. G. Sutton, R. Clayton, R. Lathigra, O. White, K. A. Ketchum, R. Dodson, E. K. Hickey, M. Gwinn, B. Dougherty, J. F. Tomb, R. D. Fleischmann, D. Richardson, J. Peterson, A. R. Kerlavage, J. Quackenbush, S. Salzberg, M. Hanson, R. van Vugt, N. Palmer, M. D. Adams, J. Gocayne, J. Weidman, T. Utterback, L. Watthey, L. McDonald, P. Artiach, C. Bowman, S. Garland, C. Fuji, M. D. Cotton, K. Horst, K. Roberts, B. Hatch, H. O. Smith, and J. C. Venter.** 1997. Genomic sequence of a Lyme disease spirochaete, *Borrelia burgdorferi*. *Nature* **390**:580-586.
56. **Fraser, C. M., S. J. Norris, G. M. Weinstock, O. White, G. G. Sutton, R. Dodson, M. Gwinn, E. K. Hickey, R. Clayton, K. A. Ketchum, E. Sodergren, J. M. Hardham, M. P. McLeod, S. Salzberg, J. Peterson, M. Chidambaram, T. Utterback, L. McDonald, P. Artiach, C. Bowman, M. D. Cotton, C. Fujii, S. Garland, B. Hatch, K. Horst, K. Roberts, M. Sandusky, J. Weidman, H. O. Smith, and J. C. Venter.** 1998. Complete genome sequence of *Treponema pallidum*, the syphilis spirochete. *Science* **281**:375-388.
57. **Frederick, J. R., J. Sarkar, J. V. McDowell, and R. T. Marconi.** 2011. Molecular Signaling Mechanisms of the Periopathogen, *Treponema denticola*. *J. Dent. Res.*
58. **Freedman, J. C., E. A. Rogers, J. L. Kostick, H. Zhang, R. Iyer, I. Schwartz, and R. T. Marconi.** 2009. Identification and molecular characterization of a cyclic-di-GMP effector protein, PlzA (BB0733): additional evidence for the existence of a functional cyclic-di-GMP regulatory network in the Lyme disease spirochete, *Borrelia burgdorferi*. *FEMS Immunol. Med. Microbiol.* **58**:285-294.
59. **Galperin, M. Y.** 2006. Structural classification of bacterial response regulators: diversity of output domains and domain combinations. *J. Bacteriol.* **188**:4169-4182.
60. **Galperin, M. Y., A. N. Nikolskaya, and E. V. Koonin.** 2001. Novel domains of the prokaryotic two-component signal transduction systems. *FEMS Microbiol. Lett.* **203**:11-21.
61. **Gao, R., T. R. Mack, and A. M. Stock.** 2007. Bacterial response regulators: versatile regulatory strategies from common domains. *Trends Biochem. Sci.* **32**:225-234.
62. **Ge, Y., and N. W. Charon.** 1997. Identification of a large motility operon in *Borrelia burgdorferi* by semi-random PCR chromosome walking. *Gene* **189**:195-201.

63. **Ge, Y., I. G. Old, I. Saint Girons, and N. W. Charon.** 1997. Molecular characterization of a large *Borrelia burgdorferi* motility operon which is initiated by a consensus sigma70 promoter. *J. Bacteriol.* **179**:2289-2299.
64. **Gern, L., and P. F. Humair.** 1998. Natural history of *Borrelia burgdorferi sensu lato*. *Wien. Klin. Wochenschr.* **110**:856-858.
65. **Guvener, Z. T., and C. S. Harwood.** 2007. Subcellular location characteristics of the *Pseudomonas aeruginosa* GGDEF protein, WspR, indicate that it produces cyclic-di-GMP in response to growth on surfaces. *Mol. Microbiol.* **66**:1459-1473.
66. **Halperin, J. J.** 2008. Nervous system Lyme disease. *Infect. Dis. Clin. North Am.* **22**:261-274, vi.
67. **He, M., B. K. Boardman, D. Yan, and X. F. Yang.** 2007. Regulation of expression of the fibronectin-binding protein BBK32 in *Borrelia burgdorferi*. *J. Bacteriol.* **189**:8377-8380.
68. **He, M., Z. Ouyang, B. Troxell, H. Xu, A. Moh, J. Piesman, M. V. Norgard, M. Gomelsky, and X. F. Yang.** 2011. Cyclic di-GMP is Essential for the Survival of the Lyme Disease Spirochete in Ticks. *PLoS Pathog* **7**:e1002133.
69. **Hengge, R.** 2009. Principles of c-di-GMP signalling in bacteria. *Nat Rev Microbiol* **7**:263-273.
70. **Hengge, U. R., A. Tannapfel, S. K. Tyring, R. Erbel, G. Arendt, and T. Ruzicka.** 2003. Lyme borreliosis. *Lancet Infect Dis* **3**:489-500.
71. **Hickman, J. W., and C. S. Harwood.** 2008. Identification of FleQ from *Pseudomonas aeruginosa* as a c-di-GMP-responsive transcription factor. *Mol. Microbiol.* **69**:376-389.
72. **Hofmeister, E. K., G. E. Glass, J. E. Childs, and D. H. Persing.** 1999. Population dynamics of a naturally occurring heterogeneous mixture of *Borrelia burgdorferi* clones. *Infect. Immun.* **67**:5709-5716.
73. **Hovis, K. M., J. V. McDowell, L. Griffin, and R. T. Marconi.** 2004. Identification and characterization of a linear-plasmid-encoded factor H-binding protein (FhbA) of the relapsing fever spirochete *Borrelia hermsii*. *J. Bacteriol.* **186**:2612-2618.
74. **Jonas, K., A. N. Edwards, I. Ahmad, T. Romeo, U. Romling, and O. Melefors.** 2010. Complex regulatory network encompassing the Csr, c-di-GMP and motility systems of *Salmonella Typhimurium*. *Environ Microbiol* **12**:524-540.
75. **Jonas, K., A. N. Edwards, R. Simm, T. Romeo, U. Romling, and O. Melefors.** 2008. The RNA binding protein CsrA controls cyclic di-GMP metabolism by

- directly regulating the expression of GGDEF proteins. *Mol. Microbiol.* **70**:236-257.
76. **Kim, Y. K., and L. L. McCarter.** 2007. ScrG, a GGDEF-EAL protein, participates in regulating swarming and sticking in *Vibrio parahaemolyticus*. *J. Bacteriol.* **189**:4094-4107.
 77. **Kitten, T., and A. G. Barbour.** 1990. Juxtaposition of expressed variable antigen genes with a conserved telomere in the bacterium *Borrelia hermsii*. *Proc. Natl. Acad. Sci.* **87**:6077-6081.
 78. **Kitten, T., and A. G. Barbour.** 1992. The relapsing fever agent *Borrelia hermsii* has multiple copies of its chromosome and linear plasmids. *Genetics* **132**:311-324.
 79. **Ko, J., K. S. Ryu, H. Kim, J. S. Shin, J. O. Lee, C. Cheong, and B. S. Choi.** 2010. Structure of PP4397 reveals the molecular basis for different c-di-GMP binding modes by PilZ domain proteins. *J. Mol. Biol.* **398**:97-110.
 80. **Kostick, J. L., L. T. Szkotnicki, E. A. Rogers, P. Bocci, N. Raffaelli, and R. T. Marconi.** 2011. The diguanylate cyclase, Rrp1, regulates critical steps in the enzootic cycle of the Lyme disease spirochetes. *Mol. Microbiol.* **81**: 219–231.
 81. **Kudryashev, M., M. Cyrklaff, W. Baumeister, M. M. Simon, R. Wallich, and F. Frischknecht.** 2009. Comparative cryo-electron tomography of pathogenic Lyme disease spirochetes. *Mol. Microbiol.* **71**:1415-1434.
 82. **Kulasakara, H., V. Lee, A. Brencic, N. Liberati, J. Urbach, S. Miyata, D. G. Lee, A. N. Neely, M. Hyodo, Y. Hayakawa, F. M. Ausubel, and S. Lory.** 2006. Analysis of *Pseudomonas aeruginosa* diguanylate cyclases and phosphodiesterases reveals a role for bis-(3'-5')-cyclic-GMP in virulence. *Proc. Natl. Acad. Sci. U. S. A.* 2006 February 21; **103**(8): 2839–2844.
 83. **Kulshina, N., N. J. Baird, and A. R. Ferre-D'Amare.** 2009. Recognition of the bacterial second messenger cyclic diguanylate by its cognate riboswitch. *Nat Struct Mol Biol* **16**:1212-1217.
 84. **Lagal, V., D. Postic, and G. Baranton.** 2002. Molecular diversity of the ospC gene in *Borrelia*. Impact on phylogeny, epidemiology and pathology. *Wien. Klin. Wochenschr.* **114**:562-567.
 85. **Lai, T. H., Y. Kumagai, M. Hyodo, Y. Hayakawa, and Y. Rikihisa.** 2008. *Anaplasma phagocytophilum* PleC Histidine Kinase and PleD Diguanylate Cyclase Two-Component System and Role of Cyclic Di-GMP in Host-cell Infection. *J. Bacteriol.* **191**:693-700.

86. **Lawrenz, M. B., H. Kawabata, J. E. Purser, and S. J. Norris.** 2002. Decreased electroporation efficiency in *Borrelia burgdorferi* containing linear plasmids lp25 and lp56: Impact on transformation of infectious *B. burgdorferi*. *Infect. Immun.* **70**:4798-4804.
87. **Lecompte, Y., and J. F. Trape.** 2003. [West African tick-borne relapsing fever]. *Ann. Biol. Clin. (Paris)*. **61**:541-548.
88. **Lee, V. T., J. M. Matewish, J. L. Kessler, M. Hyodo, Y. Hayakawa, and S. Lory.** 2007. A cyclic-di-GMP receptor required for bacterial exopolysaccharide production. *Mol. Microbiol.* **65**:1474-1484.
89. **Lescot, M., S. Audic, C. Robert, T. T. Nguyen, G. Blanc, S. J. Cutler, P. Wincker, A. Couloux, J. M. Claverie, D. Raoult, and M. Drancourt.** 2008. The genome of *Borrelia recurrentis*, the agent of deadly louse-borne relapsing fever, is a degraded subset of tick-borne *Borrelia duttonii*. *PLoS Genet* **4**:e1000185.
90. **Li, C., R. G. Bakker, M. A. Motaleb, M. L. Sartakova, F. C. Cabello, and N. W. Charon.** 2002. Asymmetrical flagellar rotation in *Borrelia burgdorferi* nonchemotactic mutants. *Proc. Natl. Acad. Sci. U. S. A.* **99**:6169-6174.
91. **Lim, B., S. Beyhan, J. Meir, and F. H. Yildiz.** 2006. Cyclic-diGMP signal transduction systems in *Vibrio cholerae*: modulation of rugosity and biofilm formation. *Mol. Microbiol.* **60**:331-348.
92. **Lim, B., S. Beyhan, and F. H. Yildiz.** 2007. Regulation of *Vibrio* polysaccharide synthesis and virulence factor production by CdgC, a GGDEF-EAL domain protein, in *Vibrio cholerae*. *J. Bacteriol.* **189**:717-729.
93. **Liu, J., T. Lin, D. J. Botkin, E. McCrum, H. Winkler, and S. J. Norris.** 2009. Intact flagellar motor of *Borrelia burgdorferi* revealed by cryo-electron tomography: evidence for stator ring curvature and rotor/C-ring assembly flexion. *J. Bacteriol.* **191**:5026-5036.
94. **Liu, X., S. Beyhan, B. Lim, R. G. Linington, and F. H. Yildiz.** 2010. Identification and characterization of a phosphodiesterase that inversely regulates motility and biofilm formation in *Vibrio cholerae*. *J. Bacteriol.* **192**:4541-4552.
95. **McBride, A. J., D. A. Athanazio, M. G. Reis, and A. I. Ko.** 2005. Leptospirosis. *Curr Opin Infect Dis* **18**:376-386.
96. **McCoy, B. N., S. J. Raffel, J. E. Lopez, and T. G. Schwan.** 2010. Bloodmeal size and spirochete acquisition of *Ornithodoros hermsi* (Acari: Argasidae) during feeding. *J. Med. Entomol.* **47**:1164-1172.

97. **McDowell, J. V., S. Y. Sung, M. Labandeira-Rey, J. T. Skare, and R. T. Marconi.** 2001. Analysis of mechanisms associated with loss of infectivity of clonal populations of *Borrelia burgdorferi* B31MI. *Infect. Immun.* **69**:3670-3677.
98. **McDowell, J. V., E. Tran, D. Hamilton, J. Wolfgang, K. Miller, and R. T. Marconi.** 2003. Analysis of the ability of spirochete species associated with relapsing fever, avian borreliosis, and epizootic bovine abortion to bind factor H and cleave c3b. *J. Clin. Microbiol.* **41**:3905-3910.
99. **Meier, J. T., M. I. Simon, and A. G. Barbour.** 1985. Antigenic variation is associated with DNA rearrangements in a relapsing fever *Borrelia*. *Cell* **41**:403-409.
100. **Meissner, A., V. Wild, R. Simm, M. Rohde, C. Erck, F. Bredenbruch, M. Morr, U. Romling, and S. Haussler.** 2007. *Pseudomonas aeruginosa* cupA-encoded fimbriae expression is regulated by a GGDEF and EAL domain-dependent modulation of the intracellular level of cyclic diguanylate. *Environ Microbiol* **9**:2475-2485.
101. **Merighi, M., V. T. Lee, M. Hyodo, Y. Hayakawa, and S. Lory.** 2007. The second messenger bis-(3'-5')-cyclic-GMP and its PilZ domain-containing receptor Alg44 are required for alginate biosynthesis in *Pseudomonas aeruginosa*. *Mol. Microbiol.* **65**:876-895.
102. **Motaleb, M. A., L. Corum, J. L. Bono, A. F. Elias, P. Rosa, D. S. Samuels, and N. W. Charon.** 2000. *Borrelia burgdorferi* periplasmic flagella have both skeletal and motility functions. *Proc. Natl. Acad. Sci. U. S. A.* **97**:10899-10904.
103. **Motaleb, M. A., M. R. Miller, C. Li, R. G. Bakker, S. F. Goldstein, R. E. Silversmith, R. B. Bourret, and N. W. Charon.** 2005. CheX is a phosphorylated CheY phosphatase essential for *Borrelia burgdorferi* chemotaxis. *J. Bacteriol.* **187**:7963-7969.
104. **Murray, T. S., and E. D. Shapiro.** 2010. Lyme disease. *Clin. Lab. Med.* **30**:311-328.
105. **Nakhamchik, A., C. Wilde, and D. A. Rowe-Magnus.** 2008. Cyclic-di-GMP regulates extracellular polysaccharide production, biofilm formation, and rugose colony development by *Vibrio vulnificus*. *Appl. Environ. Microbiol.* **74**:4199-4209.
106. **Norman, M. U., T. J. Moriarty, A. R. Dresser, B. Millen, P. Kubes, and G. Chaconas.** 2008. Molecular mechanisms involved in vascular interactions of the Lyme disease pathogen in a living host. *PLoS Pathog* **4**:e1000169.
107. **Ojaimi, C., C. Brooks, D. Akins, S. Casjens, P. Rosa, A. Elias, A. Barbour, A. Jasinskas, J. L. Benach, L. Katona, J. D. Radolf, M. Caimano, J. Skare, K.**

- Swingle, S. Sims, and I. Schwartz.** 2002. *Borrelia burgdorferi* gene expression profiling with membrane-based arrays. *Methods Enzymol.* **358**:165-177.
108. **Oschmann, P., W. Dorndorf, C. Hornig, C. Schafer, H. J. Wellensick, and K. W. Pflughaupt.** 1998. Stages and symptoms of neuroborreliosis. *J Neurology* **245**:262-272.
109. **Ouyang, Z., J. S. Blevins, and M. V. Norgard.** 2008. Transcriptional interplay among the regulators Rrp2, RpoN and RpoS in *Borrelia burgdorferi*. *Microbiol.* **154**:2641-2658.
110. **Pal, U., X. Yang, M. Chen, L. K. Bockenstedt, J. F. Anderson, R. A. Flavell, M. V. Norgard, and E. Fikrig.** 2004. OspC facilitates *Borrelia burgdorferi* invasion of *Ixodes scapularis* salivary glands. *J. Clin. Invest.* **113**:220-230.
111. **Paul, K., V. Nieto, W. C. Carlquist, D. F. Blair, and R. M. Harshey.** 2011. The c-di-GMP binding protein YcgR controls flagellar motor direction and speed to affect chemotaxis by a "backstop brake" mechanism. *Mol. Cell* **38**:128-139.
112. **Paul, R., S. Abel, P. Wassmann, A. Beck, H. Heerklotz, and U. Jenal.** 2007. Activation of the diguanylate cyclase PleD by phosphorylation-mediated dimerization. *J. Biol. Chem.* **282**:29170-29177.
113. **Paul, R., S. Weiser, N. C. Amiot, C. Chan, T. Schirmer, B. Giese, and U. Jenal.** 2004. Cell cycle-dependent dynamic localization of a bacterial response regulator with a novel di-guanylate cyclase output domain. *Genes Dev.* **18**:715-727.
114. **Pei, J., and N. V. Grishin.** 2001. GGDEF domain is homologous to adenylyl cyclase. *Proteins* **42**:210-216.
115. **Pesavento, C., G. Becker, N. Sommerfeldt, A. Possling, N. Tschowri, A. Mehli, and R. Hengge.** 2008. Inverse regulatory coordination of motility and curli-mediated adhesion in *Escherichia coli*. *Genes Dev.* **22**:2434-2446.
116. **Pitzer, J. E., S. Z. Sultan, Y. Hayakawa, G. Hobbs, M. R. Miller, and M. A. Motaleb.** 2011. Analysis of the *Borrelia burgdorferi* cyclic-di-GMP binding protein PlzA reveals a role in motility and virulence. *Infect. Immun.* **79**:1815-1825.
117. **Pratt, J. T., R. Tamayo, A. D. Tischler, and A. Camilli.** 2007. PilZ domain proteins bind cyclic diguanylate and regulate diverse processes in *Vibrio cholerae*. *J. Biol. Chem.* **282**:12860-12870.
118. **Purser, J. E., and S. J. Norris.** 2000. Correlation between plasmid content and infectivity in *Borrelia burgdorferi*. *Proc. Natl. Acad. Sci. USA* **97**:13865-13870.

119. **Radolf, J. D., and M. J. Caimano.** 2008. The long strange trip of *Borrelia burgdorferi* outer-surface protein C. *Mol. Microbiol.* **69**:1-4.
120. **Radolf, J. D., M. S. Goldberg, K. Bourell, S. I. Baker, J. D. Jones, and M. V. Norgard.** 1995. Characterization of outer membranes isolated from *Borrelia burgdorferi*, the Lyme disease spirochete. *Infect. Immun.* **63**:2154-2163.
121. **Restrepo, B. I., and A. G. Barbour.** 1994. Antigen diversity in the bacterium *B. hermsii* through "somatic" mutations in rearranged *vmp* genes. *Cell* **78**:867-876.
122. **Restrepo, B. I., T. Kitten, C. J. Carter, D. Infante, and A. G. Barbour.** 1992. Subtelomeric expression regions of *Borrelia hermsii* linear plasmids are highly polymorphic. *Mol. Microbiol.* **6**:3299-3311.
123. **Revel, A. T., A. M. Talaat, and M. V. Norgard.** 2002. DNA microarray analysis of differential gene expression in *Borrelia burgdorferi*, the Lyme disease spirochete. *Proc. Natl. Acad. Sci.* **99**:1562-1567.
124. **Rogers, E. A., S. V. Abdunnur, J. V. McDowell, and R. T. Marconi.** 2009. Comparative analysis of the properties and ligand binding characteristics of CspZ, a factor H binding protein, derived from *Borrelia burgdorferi* isolates of human origin. *Infect. Immun.* **77**:4396-4405.
125. **Rogers, E. A., D. Terekhova, H. M. Zhang, K. M. Hovis, I. Schwartz, and R. T. Marconi.** 2009. Rrp1, a cyclic-di-GMP-producing response regulator, is an important regulator of *Borrelia burgdorferi* core cellular functions. *Mol. Microbiol.* **71**:1551-1573.
126. **Romling, U., and D. Amikam.** 2006. Cyclic di-GMP as a second messenger. *Curr. Opin. Microbiol.* **9**:218-228.
127. **Rosa, P. A., K. Tilly, and P. E. Stewart.** 2005. The burgeoning molecular genetics of the Lyme disease spirochaete. *Nat Rev Microbiol* **3**:129-143.
128. **Ross, P., Y. Aloni, C. Weinhouse, D. Michaeli, P. Weinberger-Ohana, R. Meyer, and M. Benziman.** 1985. An unusual guanyl oligonucleotide regulates cellulose synthesis in *Acetobacter xylinum*. *FEBS Lett.* **186**:191-196.
129. **Ross, P., H. Weinhouse, Y. Aloni, D. Michaeli, P. Weinberger-Ohana, R. Mayer, S. Braun, E. de Vroom, G. A. van der Marel, J. H. van Boom, and M. Benziman.** 1987. Regulation of cellulose synthesis in *Acetobacter xylinum* by cyclic diguanylic acid. *Nature* **325**:279-281.
130. **Ruby, J. D., and N. W. Charon.** 1998. Effect of temperature and viscosity on the motility of the spirochete *Treponema denticola*. *FEMS Microbiol. Lett.* **169**:251-254.

131. **Ruderman, E. M., J. S. Kerr, S. R. Telford, 3rd, A. Spielman, L. H. Glimcher, and E. M. Gravalles.** 1995. Early murine Lyme carditis has a macrophage predominance and is independent of major histocompatibility complex class II-CD4+ T cell interactions. *J. Infect. Dis.* **171**:362-370.
132. **Ryan, R. P., Y. Fouhy, J. F. Lucey, L. C. Crossman, S. Spiro, Y. W. He, L. H. Zhang, S. Heeb, M. Camara, P. Williams, and J. M. Dow.** 2006. Cell-cell signaling in *Xanthomonas campestris* involves an HD-GYP domain protein that functions in cyclic di-GMP turnover. *Proc. Natl. Acad. Sci. U. S. A.* **103**:6712-6717.
133. **Ryan, R. P., J. Lucey, K. O'Donovan, Y. McCarthy, L. Yang, T. Tolker-Nielsen, and J. M. Dow.** 2009. HD-GYP domain proteins regulate biofilm formation and virulence in *Pseudomonas aeruginosa*. *Environ Microbiol* **11**:1126-1136.
134. **Ryjenkov, D. A., R. Simm, U. Romling, and M. Gomelsky.** 2006. The PilZ domain is a receptor for the second messenger c-di-GMP: the PilZ domain protein YcgR controls motility in enterobacteria. *J. Biol. Chem.* **281**:30310-30314.
135. **Ryjenkov, D. A., M. Tarutina, O. V. Moskvina, and M. Gomelsky.** 2005. Cyclic diguanylate is a ubiquitous signaling molecule in bacteria: insights into biochemistry of the GGDEF protein domain. *J. Bacteriol.* **187**:1792-1798.
136. **Sambri, V., A. Marangoni, A. Olmo, E. Storni, M. Montagnani, M. Fabbi, and R. Cevenini.** 1999. Specific antibodies reactive with the 22 kilodalton major outer surface protein of *Borrelia anserina* Ni-NL protect chicks from infection. *Infect. Immun.* **67**:2633-2637.
137. **Samuels, D. S., K. Mach, and C. F. Garon.** 1994. Genetic transformation of the Lyme disease agent *Borrelia burgdorferi* with coumarin-resistant *gyrB*. *J. Bacteriol.* **176**:6045-6049.
138. **Schott, M., S. Grosskinsky, C. Brenner, P. Kraiczy, and R. Wallich.** 2010. Molecular characterization of the interaction of *Borrelia parkeri* and *Borrelia turicatae* with human complement regulators. *Infect. Immun.* **78**:2199-2208.
139. **Schwan, T. G., W. Burgdorfer, M. E. Schrupf, and R. H. Karstens.** 1988. The urinary bladder, a consistent source of *Borrelia burgdorferi* in experimentally infected white-footed mice (*Peromyscus leucopus*). *J. Clin. Microbiol.* **26**:893-895.
140. **Schwan, T. G., and J. Piesman.** 2000. Temporal changes in outer surface proteins A and C of the Lyme disease-associated spirochete, *Borrelia burgdorferi*, during the chain of infection in ticks and mice. *J. Clin. Microbiol.* **38**:382-388.

141. **Sela, M.** 2001. Role of *Treponema denticola* in periodontal diseases. Crit. Rev. Oral Biol. Med. **12**:399-413.
142. **Sellati, T. J., D. A. Bouis, R. L. Kitchens, R. P. Darveau, J. Pugin, R. J. Ulevitch, S. C. Gangloff, S. M. Goyert, M. V. Norgard, and J. D. Radolf.** 1998. *Treponema pallidum* and *Borrelia burgdorferi* lipoproteins and synthetic lipopeptides activate monocytic cells via a CD14-dependent pathway distinct from that used by lipopolysaccharide. J. Immunol. **160**:5455-5464.
143. **Shi, W., Z. Yang, Y. Geng, L. E. Wolinsky, and M. A. Lovett.** 1998. Chemotaxis in *Borrelia burgdorferi*. J. Bacteriol. **180**:231-235.
144. **Shih, C. M., L. L. Chao, and C. P. Yu.** 2002. Chemotactic migration of the Lyme disease spirochete (*Borrelia burgdorferi*) to salivary gland extracts of vector ticks. Am. J. Trop. Med. Hyg. **66**:616-621.
145. **Siebers, A., W. Zhong, R. Wallich, and M. M. Simon.** 1999. Loss of pathogenic potential after cloning of the low-passage *Borrelia burgdorferi* ZS7 tick isolate: a cautionary note. Med. Microbiol. Immunol. **188**:125-130.
146. **Simm, R., M. Morr, A. Kader, M. Nimtz, and U. Romling.** 2004. GGDEF and EAL domains inversely regulate cyclic di-GMP levels and transition from sessility to motility. Mol. Microbiol. **53**:1123-1134.
147. **Skare, J. T., C. I. Champion, T. A. Mirzabekov, E. S. Shang, D. R. Blanco, H. Erdjument-Bromage, P. Tempst, B. L. Kagan, J. N. Miller, and M. A. Lovett.** 1996. Porin activity of the native and recombinant outer membrane protein Oms28 of *Borrelia burgdorferi*. J. Bacteriol. **178**:4909-4918.
148. **Skare, J. T., T. A. Mirzabekov, E. S. Shang, D. R. Blanco, H. Erdjument-Bromage, J. Bunikis, S. Bergstrom, P. Tempst, B. L. Kagan, J. N. Miller, and M. A. Lovett.** 1999. The Oms66 (p66) protein is a *Borrelia burgdorferi* porin. Infect. Immun. **65**:3654-3661.
149. **Slater, H., A. Alvarez-Morales, C. E. Barber, M. J. Daniels, and J. M. Dow.** 2000. A two-component system involving an HD-GYP domain protein links cell-cell signalling to pathogenicity gene expression in *Xanthomonas campestris*. Mol. Microbiol. **38**:986-1003.
150. **Smith, K. D., S. V. Lipchock, T. D. Ames, J. Wang, R. R. Breaker, and S. A. Strobel.** 2009. Structural basis of ligand binding by a c-di-GMP riboswitch. Nat Struct Mol Biol **16**:1218-1223.
151. **Sommerfeldt, N., A. Possling, G. Becker, C. Pesavento, N. Tschowri, and R. Hengge.** 2009. Gene expression patterns and differential input into curli fimbriae

- regulation of all GGDEF/EAL domain proteins in *Escherichia coli*. *Microbiol.* **155**:1318-1331.
152. **Steere, A. C.** 2001. Lyme disease. *N. Eng. J. Med.* **345**:115-125.
 153. **Steere, A. C., J. Coburn, and L. Glickstein.** 2004. The emergence of Lyme disease. *J. Clin. Invest.* **113**:1093-1101.
 154. **Steere, A. C., R. L. Grodzicki, A. N. Kornblatt, J. E. Craft, A. G. Barbour, W. Burgdorfer, G. P. Schmid, E. Johnson, and S. E. Malawista.** 1983. The spirochetal etiology of Lyme disease. *N. Eng. J. Med.* **308**:733-740.
 155. **Steere, A. C., S. E. Malawista, J. A. Hardin, S. Ruddy, W. Askenase, and W. A. Andiman.** 1977. Erythema chronicum migrans and Lyme arthritis. The enlarging clinical spectrum. *Ann. Intern. Med.* **86**:685-698.
 156. **Steere, A. C., S. E. Malawista, D. R. Snyderman, R. E. Shope, W. A. Andiman, M. R. Ross, and F. M. Steele.** 1977. Lyme arthritis: an epidemic of oligoarticular arthritis in children and adults in three Connecticut communities. *Arthritis Rheum.* **20**:7-17.
 157. **Stoenner, H. G., T. Dodd, and C. Larsen.** 1982. Antigenic variation of *Borrelia hermsii*. *J. Exp. Med.* **156**:1297-1311.
 158. **Sudarsan, N., E. R. Lee, Z. Weinberg, R. H. Moy, J. N. Kim, K. H. Link, and R. R. Breaker.** 2008. Riboswitches in eubacteria sense the second messenger cyclic di-GMP. *Science* **321**:411-413.
 159. **Sultan, S. Z., J. E. Pitzer, T. Boquoi, G. Hobbs, M. R. Miller, and M. A. Motaleb.** 2011. Analysis of the HD-GYP Domain Cyclic Dimeric GMP Phosphodiesterase Reveals a Role in Motility and the Enzootic Life Cycle of *Borrelia burgdorferi*. *Infect. Immun.* **79**:3273-3283.
 160. **Sultan, S. Z., J. E. Pitzer, M. R. Miller, and M. A. Motaleb.** 2010. Analysis of a *Borrelia burgdorferi* phosphodiesterase demonstrates a role for cyclic-di-guanosine monophosphate in motility and virulence. *Mol. Microbiol.* **77**:128-142.
 161. **Szurmant, H., and J. A. Hoch.** 2010. Interaction fidelity in two-component signaling. *Curr. Opin. Microbiol.* **13**:190-197.
 162. **Tagliabue, L., D. Antoniani, A. Maciag, P. Bocci, N. Raffaelli, and P. Landini.** 2010. The diguanylate cyclase YddV controls production of the exopolysaccharide poly-N-acetylglucosamine (PNAG) through regulation of the PNAG biosynthetic *pgaABCD* operon. *Microbiol.* **156**:2901-2911.

163. **Tamayo, R., A. D. Tischler, and A. Camilli.** 2005. The EAL domain protein VieA is a cyclic diguanylate phosphodiesterase. *J. Biol. Chem.* **280**:33324-33330.
164. **Thormann, K. M., S. Duttler, R. M. Saville, M. Hyodo, S. Shukla, Y. Hayakawa, and A. M. Spormann.** 2006. Control of formation and cellular detachment from *Shewanella oneidensis* MR-1 biofilms by cyclic di-GMP. *J. Bacteriol.* **188**:2681-2691.
165. **Tilly, K., J. G. Krum, A. Bestor, M. W. Jewett, D. Grimm, D. Bueschel, R. Byram, D. Dorward, M. J. Vanraden, P. Stewart, and P. Rosa.** 2006. *Borrelia burgdorferi* OspC protein required exclusively in a crucial early stage of mammalian infection. *Infect. Immun.* **74**:3554-3564.
166. **Tischler, A. D., and A. Camilli.** 2004. Cyclic diguanylate (c-di-GMP) regulates *Vibrio cholerae* biofilm formation. *Mol. Microbiol.* **53**:857-869.
167. **Weber, H., C. Pesavento, A. Possling, G. Tischendorf, and R. Hengge.** 2006. Cyclic-di-GMP-mediated signalling within the sigma network of *Escherichia coli*. *Mol. Microbiol.* **62**:1014-1034.
168. **Whitney, M. S., T. G. Schwan, K. B. Sultemeier, P. S. McDonald, and M. N. Brillhart.** 2007. Spirochetemia caused by *Borrelia turicatae* infection in 3 dogs in Texas. *Vet Clin Pathol* **36**:212-216.
169. **Wolfe, A. J., and K. L. Visick.** 2008. Get the message out: cyclic-Di-GMP regulates multiple levels of flagellum-based motility. *J. Bacteriol.* **190**:463-475.
170. **Wooten, R. M., and J. J. Weis.** 2001. Host-pathogen interactions promoting inflammatory Lyme arthritis: use of mouse models for dissection of disease processes. *Curr. Opin. Microbiol.* **4**:274-279.
171. **Wormser, G. P., E. Masters, A. D. Liveris, J. Nowakowski, R. B. Nadelman, D. Holmgren, S. Bittker, D. Cooper, G. Wang, and I. Schwartz.** 2005. Microbiologic Evaluation of Patients from Missouri with Erythema Migrans. *Clin. Infect. Dis.* **40**:423-428.
172. **Xu, H., M. J. Caimano, T. Lin, M. He, J. D. Radolf, S. J. Norris, F. Gheradini, A. J. Wolfe, and X. F. Yang.** 2010. Role of acetyl-phosphate in activation of the Rrp2-RpoN-RpoS pathway in *Borrelia burgdorferi*. *PLoS Pathog* **6**.(9): e1001104.
173. **Xu, Y., C. Kodner, L. Coleman, and R. C. Johnson.** 1996. Correlation of plasmids with infectivity of *Borrelia burgdorferi* sensu stricto type strain B31. *Infect. Immun.* **64**:3870-3876.

174. **Yang, X. F., S. M. Alani, and M. V. Norgard.** 2003. The response regulator Rrp2 is essential for the expression of major membrane lipoproteins in *Borrelia burgdorferi*. Proc. Natl. Acad. Sci. USA **100**:11001-11006.
175. **Yang, X. F., U. Pal, S. M. Alani, E. Fikrig, and M. V. Norgard.** 2004. Essential role for OspA/B in the life cycle of the Lyme disease spirochete. J. Exp. Med. **199**:641-648.
176. **Zubay, G., D. Schwartz, and J. Beckwith.** 1970. Mechanism of activation of catabolite-sensitive genes: a positive control system. Proc. Natl. Acad. Sci. U. S. A. **66**:104-110.

Vita

John Courtland Freedman

Department of Microbiology and Immunology
Virginia Commonwealth University
P.O. Box 980678
Richmond, VA 23298
804-828-3888
Email: freedmanjc@vcu.edu

Education:

- 2005 – Present Ph.D. Candidate, Department of Microbiology and Immunology, Virginia Commonwealth University, Richmond, Virginia
- 2001 – 2005 B.S. in Biology, College of Science, Virginia Polytechnic Institute and State University, Blacksburg, Virginia

Teaching and mentor experience:

- Summer 2006 Teaching Assistant, Medical Microbiology, Virginia Commonwealth University
- Fall 2007 –
Winter 2008 Mentored Math and Science Student from Clover Hill High school (Hanting Feng)
- Spring 2008 Teaching Assistant, Dental/Pharmacy Microbiology, Virginia Commonwealth University
- Summer 2010 Mentored Howard Hughes Medical Institute Summer Student (Mohammed Kahn)
- Fall 2010 -
Spring 2011 Mentored VCU-PREP student (Michael Kassa)

Awards and grants:

2007 – awarded GSA Student Travel Grant for poster presentation at Mid-Atlantic Microbial Pathogenesis Meeting – Wintergreen, VA.

2008 - awarded GSA Student Travel Grant for oral presentation at Virginia American Society for Microbiology Branch Meeting – James Madison University, Harrisonburg, VA.

2010 – awarded GSA Student Travel Grant for poster presentation at the Gordon Research Conference – Biology of Spirochetes - Ventura Beach, CA.

2011 – awarded travel grant for oral and poster presentation from Mid-Atlantic Microbial Pathogenesis Meeting – Wintergreen, VA

Publications:

Accepted:

Hovis KM, **Freedman JC**, Zhang H, Forbes JL, Marconi RT. Identification of an antiparallel coiled-coil/loop domain required for ligand binding by the *Borrelia hermsii* FhbA protein: additional evidence for the role of FhbA in the host-pathogen interaction. *Mol Microbiol.* 2009 Mar;71(6):1551-73.

Freedman JC, Rogers EA, Kostick JL, Zhang H, Iyer R, Schwartz I, Marconi RT. Identification and molecular characterization of a cyclic-di-GMP effector protein, PlzA (BB0733): additional evidence for the existence of a functional cyclic-di-GMP regulatory network in the Lyme disease spirochete, *Borrelia burgdorferi*. *FEMS Immunol Med Microbiol.* 2010 Mar;58(2):285-94.

In preparation:

Kostick JL, **Freedman JC**, Szkotnicki LT, Mallory K, Marconi RT. Analysis of the impact of the PilZ-domain containing proteins, PlzA and PlzB, on motility and the enzootic cycle of the Lyme disease spirochetes.

Freedman JC, Szkotnicki LT, Kostick JL, and Marconi RT. Metabolism of c-di-GMP in the tick-borne relapsing fever spirochete, *Borrelia hermsii*, plays an integral role in motility and virulence

Abstracts:

Freedman JC, Hovis KM, Earnhart CG, Sadlon T, Gordon DL, and Marconi RT. 2007. Analysis of the Interaction between Factor H/FHL-1 and the Tick-borne Relapsing Fever Spirochete, *Borrelia turicatae*. Poster presentation. Mid-Atlantic Microbial Pathogenesis Meeting, Wintergreen, Virginia.

Freedman JC, Hovis KM, Earnhart CG, Sadlon T, Gordon DL, and Marconi RT. 2007. Analysis of the Interaction between Factor H/FHL-1 and the Tick-borne Relapsing

Fever Spirochete, *Borrelia turicatae*. Departmental seminar. Virginia Commonwealth University. Department of Microbiology and Immunology.

Freedman JC, Hovis KM, Earnhart CG, Sadlon T, Gordon DL, and Marconi RT. 2007. *Borrelia turicatae*, a causative agent of tick borne relapsing fever, produces a unique factor H/FHL-1 binding protein. Watts Day poster presentation. Virginia Commonwealth University. Department of Microbiology and Immunology.

Freedman JC, Hovis KM, Earnhart CG, Sadlon T, Gordon DL, and Marconi RT. 2007. Factor H binding and serum sensitivity of the relapsing fever *Borrelia*. Departmental Seminar. Virginia Commonwealth University. Department of Microbiology and Immunology.

Freedman JC, Rogers EA, and Marconi RT. 2008. Cyclic-di-GMP as a Second Messenger in the *Borrelia*. Departmental Seminar. Virginia Commonwealth University. Department of Microbiology and Immunology.

Freedman JC, Rogers EA, and Marconi RT. 2008. Cyclic-di-GMP as a Second Messenger in the Tick-Borne Relapsing Fever Agent, *Borrelia hermsii*. Oral presentation. Virginia American Society for Microbiology Branch Meeting. James Madison University, Harrisonburg, VA.

Freedman JC, Rogers EA, Kostick JL, and Marconi RT. 2009. PlzA is a Cyclic-di-GMP Binding Protein, Integral to the Lyme disease enzootic cycle. Departmental Seminar. Virginia Commonwealth University. Department of Microbiology and Immunology.

Freedman JC, Kostick JL, Rogers, EA, Szkotnicki LT, and Marconi RT. 2010. The Rrp1 Cyclic-di-GMP Signaling Network of *Borrelia burgdorferi*: a new frontier in genetic regulation. Poster presentation. Gordon Research Conference – Biology of Spirochetes - Ventura Beach, CA.

Freedman JC, Kostick JL, Rogers, EA, Szkotnicki LT, and Marconi RT. 2011. PlzA, a Cyclic-di-GMP binding protein of the Lyme disease spirochete, *Borrelia burgdorferi*, regulates motility, chemotaxis and pathogenesis. Oral and poster presentation. Mid-Atlantic Microbial Pathogenesis Meeting. Wintergreen, VA.