



RESEARCH ARTICLE

WILEY

Overland flow velocity and soil properties in established semi-natural woodland and wood pasture in an upland catchment

Felicity Monger¹  | Stephanie Bond²  | Dominick V Spracklen¹ | Mike J Kirkby² 

¹School of Earth and Environment, University of Leeds, Leeds, UK

²School of Geography, University of Leeds, Leeds, UK

Correspondence

Felicity Monger, School of Earth and Environment, University of Leeds, Leeds, UK.
Email: eefam@leeds.ac.uk

Funding information

United Bank of Carbon; University of Leeds

Abstract

Management of upland land-use has considerable potential for mitigating flood risk by increasing topsoil storage and slowing overland flow. Recent work has highlighted the potential for vegetation to impact the velocity of saturation-excess overland flow. Woodland creation is widely proposed for Natural Flood Management (NFM), but data on saturation-excess overland flow in woodland habitats is lacking. Here we measure soil properties and overland flow velocities in established broadleaf woodland and wood pasture with an understorey dominated by either grass or bracken. We show that wood pasture dominated by bracken has overland flow velocity 12–20% lower than established broadleaf woodland and 19–27% lower than grass-dominated wood pasture. Established woodland soils exhibited eight times higher saturated hydraulic conductivity than bracken-dominated wood pasture and 80 times higher than grass-dominated wood pasture. We conclude that upland habitats can be managed to reduce flood risk, first by storing storm water in the soil and then by reducing overland flow velocity through rough surface vegetation. These factors combine to reduce floods by delaying the onset of overland flow runoff and slowing its delivery to streams. It is clear that Manning's n is far from constant in these shallow overland flows, the development of overland flow datasets is, therefore, also beneficial for improving the theory and practice of hillslope rainfall-runoff modelling.

KEYWORDS

bracken, flood mitigation, land cover, overland flow, soil properties, UK uplands

1 | INTRODUCTION

Flooding has increased across the globe over the past three decades (Kundzewicz et al., 2014; Wingfield et al., 2019) and the frequency of flood events is expected to increase further under future climate change (Blöschl et al., 2019; Iacob et al., 2017). Traditional flood management methods have consisted of expensive, hard-engineered structures. Recently, both researchers and policy makers have shown greater interest in the use of Natural Flood Management (NFM) strategies (Dadson et al., 2017; Stevens et al., 2016). NFM aims to work

with natural processes to enhance the water storage capacity of a catchment and to 'slow the flow'. Examples of approaches include the development of built water storage (Nicholson et al., 2020; Quinn et al., 2013), river restoration (Dixon et al., 2016), leaky debris dams (Ashbrook, 2020; Thomas & Nisbet, 2012) and land-use management (Spray et al., 2016).

In recent years land-use management, particularly in the uplands (>250–300 m above sea level in the UK) has been increasingly debated as an effective method of NFM. The management of upland areas is crucial to managing future flood risk (Murphy et al., 2020) as

This is an open access article under the terms of the Creative Commons Attribution-NonCommercial License, which permits use, distribution and reproduction in any medium, provided the original work is properly cited and is not used for commercial purposes.

© 2022 The Authors. *Hydrological Processes* published by John Wiley & Sons Ltd.

these regions are experiencing greater increases in precipitation compared to lowland areas (Burt & Holden, 2010; Murphy et al., 2019) and play a principal role in river flow generation (Robinson et al., 2013). Many upland soils are often in poor condition, due to a legacy of soil compaction from long-term over grazing (Holden et al., 2007; Murphy et al., 2020; Sansom, 1999). Soil degradation can increase flood risk due to the loss of macro-porous structures within the soil profile reducing water storage and soil permeability (Alaoui et al., 2018; Murphy et al., 2020; Palmer & Smith, 2013). When implemented in the uplands, NFM land-use management strategies aim to improve the condition of these soils through a number of interventions, including reductions in grazing, peatland restoration and tree planting. However, a lack of empirical data on the impact of NFM interventions on soil and vegetation properties (Bond et al., 2020; Ngai, 2017; Wheeler & Evans, 2009) and downstream flooding is a barrier to effective and widespread implementation (Dadson et al., 2017).

There has been a particular interest in tree planting as a method of NFM, as woodland soils are often associated with higher permeability and increased water storage compared to other land covers (Agnese et al., 2011; Archer et al., 2013; Calder et al., 2008; Carroll et al., 2004; Mawdsley et al., 2017; McCulloch & Robinson, 1993; Monger et al., 2021; Murphy et al., 2020; Zimmermann et al., 2006). For example, Archer et al. (2013) found that areas of established woodland exhibited permeability rates 5 to 6 times higher than neighbouring grazed grasslands. Monger et al. (2021) found woodland soils had permeability rates 11–20 times greater than pasture soils. This is often attributed to increased organic matter from leaf litter and the action of tree roots which enhance woodland soils macroporosity and soil structure (Archer et al., 2013; Nisbet & Thomas, 2006). The evidence supporting the benefits of woodland on soil properties has increased in recent years (Burgess-Gamble et al., 2017; Stratford et al., 2017).

Wood pasture are woodland areas grazed by livestock resulting in dynamic systems with a mosaic of different successional stages between grassland and woodland (Peringer et al., 2013; Smit et al., 2005; Uytvanck et al., 2008). Wood pasture has declined drastically in Europe over the last few decades (Smit et al., 2005). Recently there have been several efforts to restore and create wood pasture for conservation and environmental benefits (Uytvanck et al., 2008). Wood pasture offers a compromise to those in land management (including but not exclusively, land owners, land managers and farmers) who want to combine grazing livestock and the benefits of woodland. However, there is limited information available regarding the potential of wood pasture for reducing flood risk (Krašić et al., 2018). Therefore, there is a pressing need to better understand the role of wooded upland habitats in managing flood risk.

The focus on land-use management for NFM has primarily concentrated on the impact of land cover on soil properties through soil permeability and storage (Bronstert et al., 2002; Carroll et al., 2004; Marshall et al., 2014; Monger et al., 2021). Recently, Bond et al. (2020) also highlighted the role of land cover on surface roughness and the

importance for flood mitigation. Surface roughness plays a crucial role by reducing the velocity of overland flow and hindering water flow connectivity, 'slowing the flow' and reducing downstream flood peaks. Although the role of roughness has been well studied regarding channel and bank flow (Medeiros et al., 2012), investigations into the impact of vegetation on hillslope roughness are rare (Pan et al., 2016), and measurements of the impact of hillslope vegetation on overland flow have commonly been limited to slopes of less than 1% and/or have been restricted to semi-arid environments (Dunkerley et al., 2001; Emmett, 1970; Kuhn et al., 2003). An important study by Chow (1959), reported Manning's n roughness values for a range of vegetation types on floodplain channels, including cropland and woodland. These values are still commonly used as an estimate of roughness (Burgess-Gamble et al., 2017) but are of limited relevance for shallow overland flow on hillslopes.

Recent studies have started to provide data of hillslope vegetation impacts on overland flow velocity and roughness (Bond et al., 2020; Holden et al., 2008; Wallace et al., 2021). Holden et al. (2008) found the mean overland flow velocity for moss (*Sphagnum*) cover was more than 5 times slower than for a bare peat surface. Gao et al., 2016 used the fully distributed SD-TOPMODEL to estimate that the reduction in overland flow reduced flow peaks by up to 13.4%. Bond et al. (2020) found overland flow velocity varied by a factor 1.5 between four upland grassland habitats. Grass, leaves, stems and litter all contribute differently to resistance to overland flow (Pan et al., 2016) meaning complex responses to changes in vegetation are likely.

Here we expand on these previous studies and report soil properties and hillslope overland flow velocity for one area of upland established semi-natural woodland and two areas of wood pasture; bracken-dominated wood pasture and grass-dominated wood pasture, for which data is currently lacking. Empirical evidence collected in this study will be useful to inform rainfall-runoff model parameters.

2 | METHODS

2.1 | Study site

Fieldwork took place in the Naddle catchment, Cumbria, UK (54°31'50.9"N, 2°45'37.3"W) (Figure 1a). The area is managed by the RSPB (The Royal Society for the Protection of Birds) on behalf of the landowners, United Utilities. The Naddle catchment consists of a mixture of grazed pasture, grazed wood pasture and un-grazed semi-natural broadleaf woodland. The catchment experiences mild winters and cool summers (Kenworthy, 2014), with mean monthly temperatures ranging from -0.3 to 18.3°C and mean annual precipitation of 1779 mm, with monthly rainfall ranging from 88 to 231 mm (1981–2010 mean, Shap weather station at 255 m AoD, 5.73 km SE [Met Office, 2020]). Soils in the study area are upland organo-mineral soils, predominately Malvern 611a (Chromic Endoleptic Umbrisol), a free draining acid loamy soil (Cranfield University, 2019).

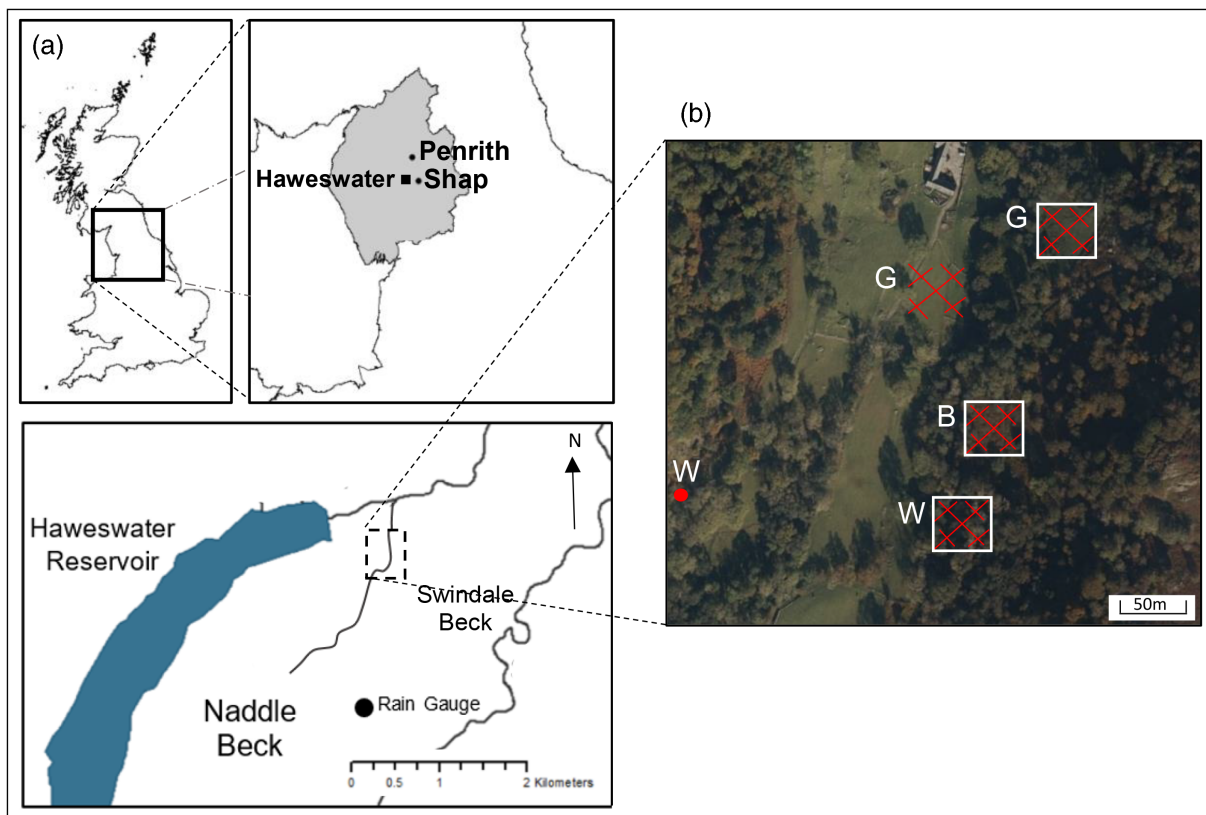

FIGURE 1 (a) Location of the Naddle catchment, Lake District, UK. (b) Locations for data collection of soil properties (white box) and overland flow velocity measurements (red crosshatch, multiple flume locations or circle, singular flume location). W: Established semi-natural woodland. G: Grass wood pasture. B: Bracken wood pasture

2.2 | Data collection

Three UK upland land covers were investigated in this study, 1) an established mature semi-natural broadleaf woodland, 2) wood pasture with an understorey dominated by grass and 3) wood pasture with an understorey dominated by bracken (Table 1). Bracken, *Pteridium aquilium*, is a common fern often regarded as a weed species, found on all continents except Antarctica (Rasmussen et al., 2003). Bracken originated as a woodland plant crucial to succession, however it now dominates large tracts of land outside woodland in temperate climates, causing problems for land management (Marrs et al., 2000).

Soil sampling and overland flow velocity measurements were completed in October 2019 and October 2020 (Table 2). Soil data were collected at 5 m intervals (25 soil sampling sites) across 20 m by 20 m plots established within each of the land covers investigated (Figure 1b, white boxes).

To investigate overland flow velocity in the established woodland and bracken wood pasture, flume locations were selected at random within ~10 m of the plots established for soil sampling. With the exception of one established woodland flume location (Figure 1b, red crosshatch, multiple flume locations or circle, singular flume location). Due to changes in land management, the overland flow velocity sampling locations for the grassland wood pasture was moved following the October 2019 field campaign (2 flume locations in 2019, 5 flume

locations in 2020). Overland flow velocity measurement sites were restricted to locations with a local gradient of between 11° and 16° and away from field boundaries to reduce edge effects. Sampled elevations range from 250 to 292 m AOD.

2.3 | Soil properties

We measured soil bulk density, saturated hydraulic conductivity (K_{sat}), soil moisture and organic matter. To calculate K_{sat} ($m \cdot s^{-1}$), intact soil cores were taken using Eijelkamp bulk density rings from the upper 5 cm of soil. Any vegetation present was clipped using shears as low as possible (Cresswell & Hamilton, 2002). Soil cores were placed in an Eijelkamp Permeameter and K_{sat} measurements taken following the method set out by Eijelkamp (2011). Saturated soil cores were then transferred to pre-weighed containers and dried overnight at 105°C (a minimum of 16 h) to remove moisture. On removal from the oven, samples were placed in a desiccator to cool and then reweighed to determine bulk density ($g \cdot cm^{-3}$) (Cresswell & Hamilton, 2002). Finally, to calculate the percentage organic matter (%) of the soil, the loss on ignition method at 550°C was used (Dean, 1974).

Soil moisture content (%) was measured in the field using a Delta-T Ltd. 'theta probe'. Approximately 225 readings were taken at each land use. Measurements were taken during within a 24 hour

TABLE 1 Land cover descriptions in Naddle Valley. Grazing intensity as LU·ha⁻¹



Land cover	Dominant ground cover species	Management	Example site
Established Semi-natural Woodland	<i>Nardus stricta</i> , <i>Molinia caerulea</i> , <i>Sphagnum sp.</i> , <i>Trifolium repens</i> , <i>Euphrasia sp.</i>	Deer fenced to exclude livestock and deer grazing. An area of ancient semi-natural upland woodland designated as a site of special scientific interest (SSSI). The NVC classification is W7, W9, W11 – upland mixed woodland and wet woodland.	
Bracken wood pasture	<i>Pteridium aquilium</i> , <i>Oxalis sp.</i> , <i>Deschampsia flexuosa</i> .	Intermittent grazing at 0.05 LU·ha ⁻¹ sheep, with Red and Roe deer. An area of upland wood pasture dominated by bracken, <i>Pteridium aquilium</i> , with scattered established trees. Little regeneration due to opportunistic grazing by deer.	
Grass wood pasture	<i>Nardus stricta</i> , <i>Molinia caerulea</i> , <i>Anthoxanthum odoratum</i> , <i>Cynosurus cristatus</i> , <i>Festuca spp.</i> , <i>Trifolium repens</i> , <i>Rumex acetosa</i> , <i>Ranunculus repens</i> , <i>Achillea millefolium</i>	All-year round grazing at 0.10 LU·ha ⁻¹ sheep, with Red and Roe deer. An area of upland wood pasture dominated by grassland, with scattered established trees.	

TABLE 2 Sampling strategy, number of individual measurements (number of flume locations/soil sampling sites)

Measurement		Established semi-natural woodland	Bracken wood pasture	Grass wood pasture
Overland flow velocity	1.2 L/min	27 (7)	36 (8)	35 (7)
	6 L/min	33 (7)	38 (8)	35 (7)
	12 L/min	35 (7)	40 (8)	35 (7)
Soil properties	Bulk density	25 (25)	25 (25)	25 (25)
	Saturated hydraulic permeability	25 (25)	25 (25)	25 (25)
	Soil moisture	250 (25)	250 (25)	250 (25)
	Organic matter	25 (25)	25 (25)	25 (25)

period to reduce any potential weather impacts. The ‘theta probe’ uses a simplified time-domain reflectometry (TDR) technique to derive instant values of volumetric moisture content (Delta-T, 1999).

2.4 | Overland flow velocity

Overland flow velocity was measured using the portable hillslope flume described in detail by Bond et al. (2020). The portable flume was constructed by hammering aluminium side panels into the ground to create a 0.4 m by 2.0 m bounded plot with a z-shape base panel (0.4 m wide with three 0.2 m long faces angled at 60° to form the z-

shape) dug into the ground, so that the upper surface of the base panel was level with the soil, downslope of the aluminium side panels (Figure 2). The z-shape was driven ~2 cm into the soil face to create a seal between the ground surface and z-shape. A plastic funnel was then fitted level to the z-shape on the opposing side using tape to secure and petroleum jelly to make watertight. The funnel collected and subsequently channelled water that had travelled the length of the flume through the attached Seapoint Rhodamine fluorometer. The fluorometer logged the fluorescence of water in SEVolts every 1 s using a CR220x data logger. A low-concentration tracer, Rhodamine water tracing (WT) dye, was injected at the inlet of the flume to enable automated velocity measurements. Mean overland flow

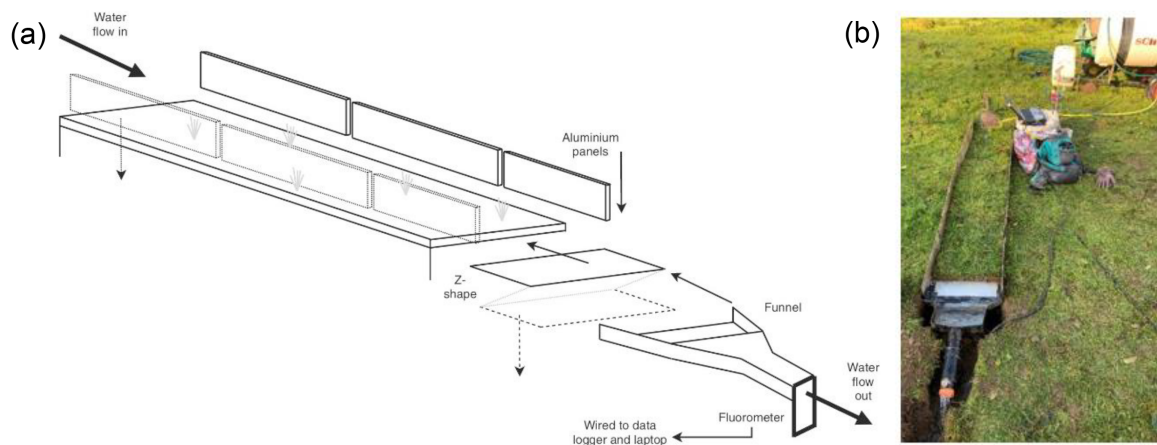

FIGURE 2 (a) Overland flow hillslope flume design (Bond et al., 2020); (b) example of portable flume installed in the grass wood pasture habitat

velocity was calculated for three discharge rates (30, 15 and 3 L·m⁻¹·s⁻¹), with a minimum of 5 Rhodamine tracer injections recorded at each discharge rate.

As set out in Bond et al. (2020), mean overland flow velocity, U (m·s⁻¹) was calculated using an inverse time weighting (i.e. linear in distance) summed over r sequential time steps where:

$$U = \frac{\sum_{i=1}^r \frac{1}{t_i v_{q_i}}}{\sum_{i=1}^r v_{q_i}} \quad (1)$$

where:

l is the vegetated flume length (m);

t is the time difference from point of Rhodamine tracer injection (s);

v_q is fluorescence strength.

Further information about these calculations, including a list of abbreviations and examples of breakthrough curves, can be found in appendices S1 and S3 of Bond et al. (2020).

Manning's n roughness (s·m^{-1/3}) was calculated as a commonly used measure of roughness:

$$n = \frac{R^{2/3} S^{1/2}}{U} \quad (2)$$

where:

R is the hydraulic radius (m);

S is the slope (radians).

Mean flow depth, d (m) was calculated from mean overland flow velocity, U , the fixed flume width, w (m) and the set discharge rate, Q (m³·s⁻¹):

$$d = \frac{Q}{wU} \quad (3)$$

Mean overland flow velocity was calculated for the three discharge rates (30, 15 and 3 L·m⁻¹·s⁻¹), with a minimum of 5 Rhodamine tracer injections recorded at each discharge rate.

2.5 | Statistical analysis

Shapiro–Wilk tests were used to test the normality of soil properties and overland flow velocity. Normally distributed data was then analysed using ANOVA, followed by Tukey's post hoc tests to identify significant differences ($p < 0.05$) between land covers, whilst non-normal data was analysed using Kruskal–Wallis and Conover's post-hoc tests.

Statistics were performed using the Python SciPy (Virtanen et al., 2019) and scikit-posthocs (Terpilowski, 2019) packages.

3 | RESULTS

3.1 | Soil properties

Bulk density data was normally distributed, whilst Ksat, soil moisture and soil organic matter was non-normally distributed. A post-hoc Tukey's test found that the bulk density of established woodland soil was significantly ($p < 0.05$) lower than both bracken wood pasture and grass wood pasture soils (respectively 21% and 18% lower) (Figure 3a, Table 3). However, there was no significant difference between bracken wood pasture and grass wood pasture. Using a post-hoc Conover's test we found that established woodland soils exhibited significantly ($p < 0.05$) higher Ksat compared with bracken wood pasture and grass wood pasture soils, by 8 times and 80 times respectively (Figure 3b). Bracken wood pasture Ksat was significantly ($p < 0.05$) (10 times) higher than grass wood pasture. Soil moisture in semi-natural woodland soils (86.5%) was significantly ($p < 0.05$) greater than bracken wood pasture (75.5%) and grass wood pasture (78.5%). Additionally, grass wood pasture soil moisture was significantly ($p < 0.05$) higher than bracken wood pasture. The organic matter of semi-natural woodland soils (24.0%) was significantly ($p < 0.05$) higher than the bracken wood pasture (18.4%) and grass wood pasture (16.6%) soils. There was no significant difference between bracken wood pasture and grass wood pasture.

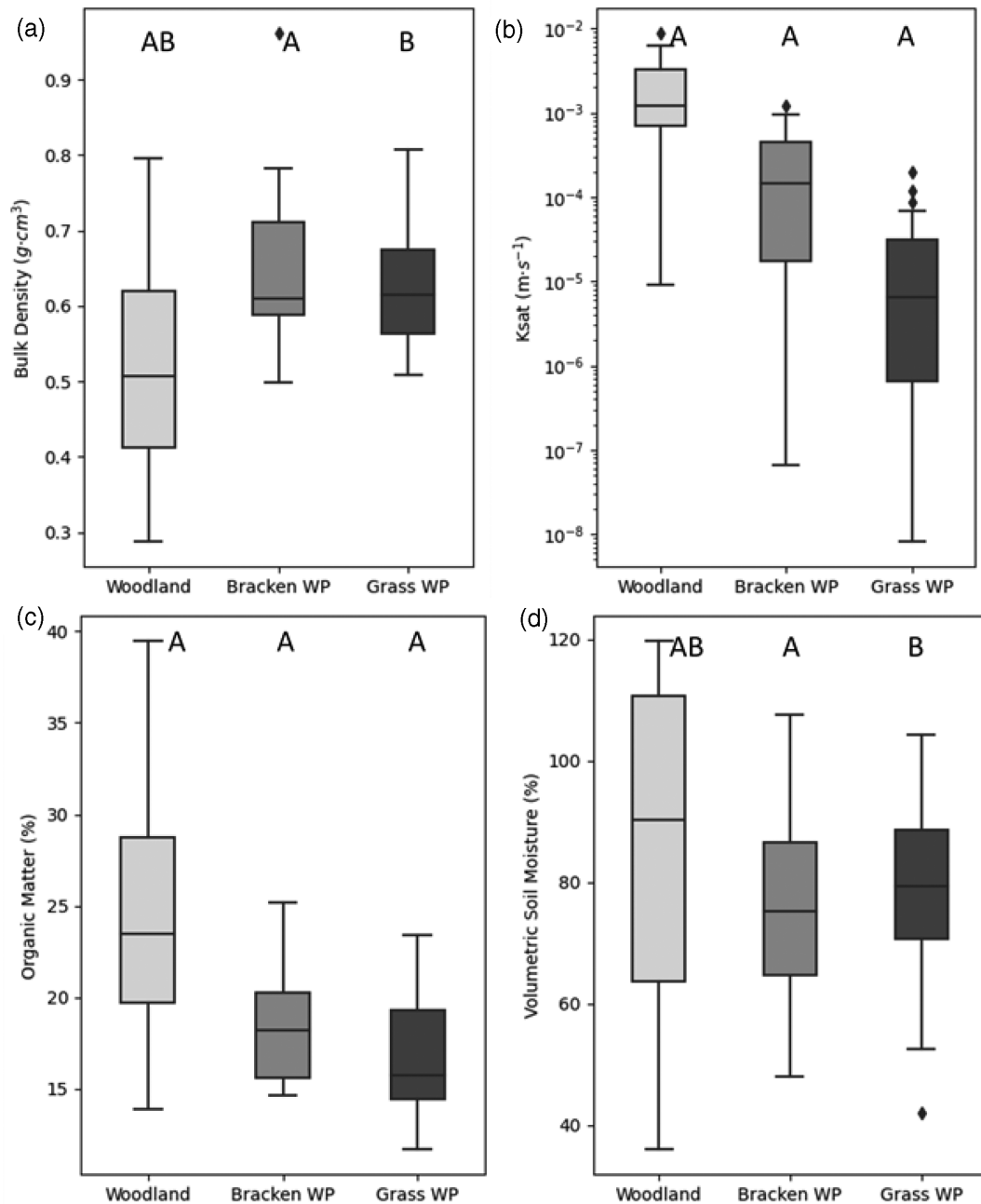

FIGURE 3 Soil properties including (a) bulk density ($\text{g}\cdot\text{cm}^{-3}$), (b) saturated hydraulic conductivity (K_{sat} , $\text{m}\cdot\text{s}^{-1}$), (c) soil moisture (%), (d) soil organic matter (%) shown as median (line), 25th to 75th percentile (box), 5th to 95th percentile (whiskers). Sites that are statistically different share a letter

3.2 | Overland flow

The lowest mean overland flow velocity was found at the bracken wood pasture site under all discharge rates, whilst grass wood pasture site had the highest mean overland velocity (Table 4). Mean overland flow at the bracken wood pasture was 12–20% lower than the semi-natural woodland and 19–27% lower than the grass-dominated wood pasture (Figure 4). Overland flow velocity data collected for all three discharge rates was non-normally distributed. Therefore Kruskal-Wallis followed by Conover's post-hoc tests were used to identify

significant differences between land covers. At the lowest discharge rate ($3 \text{ L}\cdot\text{m}^{-1}\cdot\text{s}^{-1}$), overland flow velocity at the bracken wood pasture site was significantly ($p < 0.05$) lower than both grass wood pasture and established woodland, with no significant difference between grass wood pasture and established woodland. At both 15 and $30 \text{ L}\cdot\text{m}^{-1}\cdot\text{s}^{-1}$, overland flow velocity at the bracken wood pasture site was significantly ($p < 0.05$) lower than both grass wood pasture and established woodland. In addition, overland flow velocity at the established woodland site was significantly ($p < 0.05$) lower than the grass wood pasture site.

TABLE 3 Median (η), mean (μ), and standard error (SEM) for bulk density, permeability, soil moisture and organic matter at each habitat

Habitat	Bulk density ($\text{g}\cdot\text{cm}^{-3}$)			Permeability ($\text{m}\cdot\text{s}^{-1}$)			Soil moisture (%)			Organic matter (%)		
	η	μ	SEM	η	μ	SEM	η	μ	SEM	η	μ	SEM
Established Semi-natural Woodland	0.51	0.51	0.03	1.23×10^{-3}	2.28×10^{-3}	4.90×10^{-4}	92.7	86.5	1.6	23.5	24.0	1.4
Bracken wood pasture	0.61	0.65	0.02	1.50×10^{-4}	2.90×10^{-4}	7.00×10^{-5}	74.6	75.5	0.9	18.2	18.4	0.6
Grass wood pasture	0.61	0.63	0.02	1.00×10^{-5}	3.00×10^{-5}	1.00×10^{-5}	78.7	78.5	0.8	15.7	16.6	0.6

TABLE 4 Overland flow velocity (U) recorded at 30, 15 and 3 $\text{L}\cdot\text{m}^{-1}\cdot\text{s}^{-1}$

Habitat	Velocity, U ($\text{m}\cdot\text{s}^{-1}$)			Manning's n ($\text{s}\cdot\text{m}^{-\frac{1}{3}}$)	Slope	Depth (m)
	Count, n	μ	SEM			
3 $\text{L}\cdot\text{m}^{-1}\cdot\text{s}^{-1}$						
Established semi-natural Woodland	27	0.010	0.0005	2.41	0.24	0.011
Bracken wood pasture	30	0.008	0.0005	2.54	0.22	0.009
Grass wood pasture	33	0.011	0.0003	1.89	0.23	0.009
15 $\text{L}\cdot\text{m}^{-1}\cdot\text{s}^{-1}$						
Established semi-natural Woodland	32	0.028	0.0007	0.76	0.24	0.009
Bracken wood pasture	34	0.023	0.0006	1.00	0.22	0.011
Grass wood pasture	33	0.031	0.0008	0.52	0.23	0.006
30 $\text{L}\cdot\text{m}^{-1}\cdot\text{s}^{-1}$						
Established semi-natural Woodland	34	0.043	0.001	0.59	0.24	0.012
Bracken wood pasture	38	0.038	0.001	0.67	0.22	0.013
Grass wood pasture	31	0.047	0.001	0.50	0.23	0.011

Note: Count represents the number of Rhodamine injections per habitat. For velocity, the mean (μ) and standard error of the mean (SEM) is given. For slope, the mean (μ) slope in radians is shown.

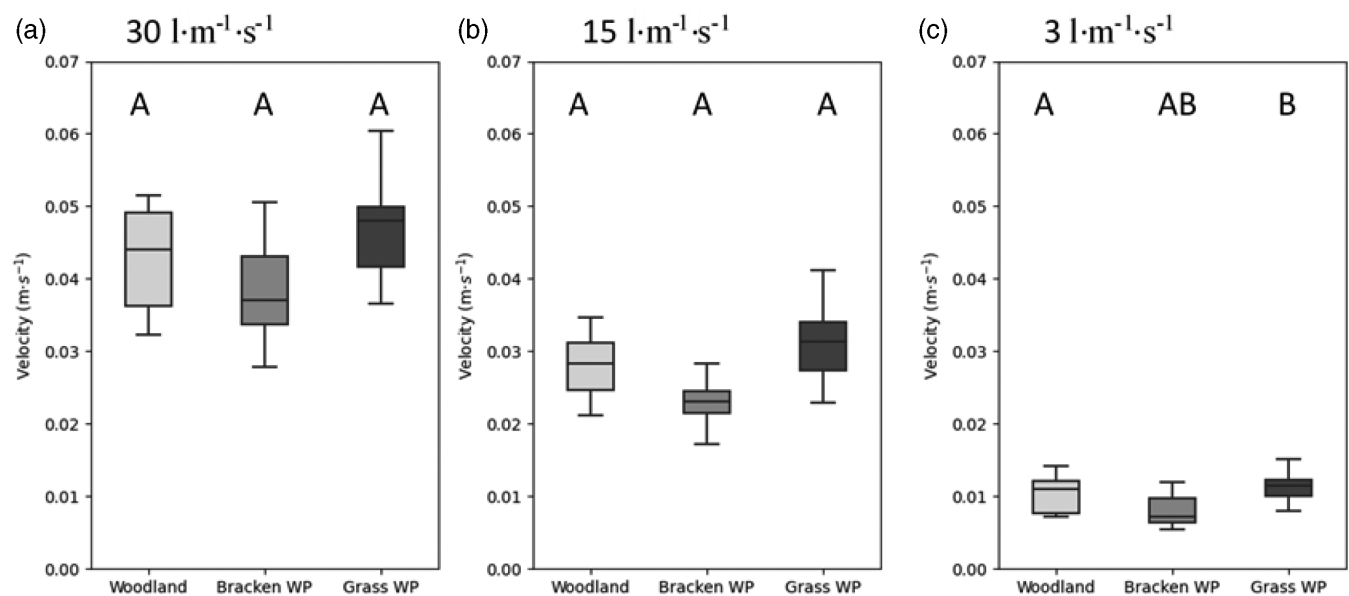
**FIGURE 4** Distribution of flow velocity for flow rates of (a) $30\text{ L}\cdot\text{m}^{-1}\cdot\text{s}^{-1}$, (b) $15\text{ L}\cdot\text{m}^{-1}\cdot\text{s}^{-1}$, (c) $3\text{ L}\cdot\text{m}^{-1}\cdot\text{s}^{-1}$ at the three different habitats. Shown as median (line), 25th to 75th percentile (box), 5th to 95th percentile (whiskers). Sites that are statistically different share a letter

When converted to Manning's n roughness, values ranged between 0.50 and 2.54 ($\text{s}\cdot\text{m}^{-\frac{1}{3}}$). Grass wood pasture consistently had the lowest Manning's n values across the three discharge rates.

Mean flow depth ranged between 0.006 and 0.013 m across the three discharge rates. At the lowest discharge rate ($3 \text{ L}\cdot\text{m}^{-1}\cdot\text{s}^{-1}$), depth was greatest for semi-natural woodland sites. However, for the other two discharge rates, bracken wood pasture had the greatest depth and grass wood pasture the shallowest.

4 | DISCUSSION

Our study reports some of the first upland hillslope overland flow velocity measurements for established semi-natural woodland and wood pasture. We demonstrate the importance of trees as a potential NFM strategy whether as part of a woodland or wood pasture habitat.

4.1 | Comparison of soil properties in established woodland and wood pasture

We found that semi-natural woodland soils exhibited higher K_{sat} and lower bulk density when compared to other vegetation types, consistent with current understanding (Archer et al., 2013; Calder et al., 2008; Carroll et al., 2004; McCulloch & Robinson, 1993). Higher K_{sat} is attributed to a more open soil structure, evidenced by lower bulk density and greater organic matter in woodland soils. Semi-natural woodland soils also exhibited significantly higher soil moisture compared to wood pasture soils, possibly due to lack of livestock and lower levels of grazing at the woodland site (Xu et al., 2014). However, the grass wood pasture had higher grazing intensity but also exhibited higher soil moisture compared to the bracken wood pasture. The larger range of soil moisture in woodland soils may be explained by a more porous structure meaning soils can store greater rainfall volumes and so there is potential for higher and lower soil moisture compared to grazed pasture systems. There was no significant difference in bulk density and organic matter between the two wood pasture habitats, yet the soils at the bracken wood pasture site had significantly higher K_{sat} . Whilst it is well understood that grazing modifies vegetation structure, soil composition (Milligan et al., 2016; Orr & Carling, 2006) and water storage capacity (Meyles et al., 2006), the influence of different grazing patterns and foraging behaviour is less well studied. Therefore, the presence of bracken, which is a less favourable grazing environment than the grassland dominated site, due to its toxicity, may have influenced grazing regimes and therefore impacted soil characteristics.

4.2 | Comparison of overland flow velocity in established woodland and wood pasture

Land management impacts soil properties and vegetation composition which both influence the generation of overland flow and the

potential for downstream flooding (Stratford et al., 2017). We found that woodland soils had greater K_{sat} and lower bulk density, which may contribute to delays in the formation and reduce the volume of saturation excess overland flow (Monger et al., 2021). Infiltration excess overland flow may be generated when rainfall intensity exceeds infiltration rates or where compaction is high. Regardless of how overland flow is generated, surface roughness plays a dominant role in delaying delivery of water to streams, extending the tail of the hydrograph and reducing the flood risk. Vegetation alters the velocity of overland flow through controlling the roughness of the surface (Bond et al., 2020; Holden et al., 2008). We found that the bracken wood pasture sites had the greatest surface roughness and the lowest overland flow velocity across all three discharge rates analysed. This could be explained by the accumulations of bracken leaf litter, creating friction between the vegetation and overland flow. Contrastingly, grass wood pasture sites had short-cropped vegetation and the highest overland flow velocity. Bracken is generally considered as a problem species and often heavily managed due to its toxicity to livestock (Marrs et al., 2000; Pakeman & Marrs, 1992). Here we identify a positive and largely unrecognized benefit of a bracken understorey for reducing overland flow.

4.3 | How does woodland and wood pasture compare to other upland habitats?

Table 5 compares overland flow velocities measured in our study against those from upland peat (Holden et al., 2008) and grassland (Bond et al., 2020). For a discharge rate of $30 \text{ L}\cdot\text{m}^{-1}\cdot\text{s}^{-1}$, overland flow velocities varied from $0.023 \text{ m}\cdot\text{s}^{-1}$ for peatland habitats dominated by grass and moss, $0.028 \text{ m}\cdot\text{s}^{-1}$ for low-density grazed pasture, $0.038 \text{ m}\cdot\text{s}^{-1}$ for bracken wood pasture, $0.050 \text{ m}\cdot\text{s}^{-1}$ for bare peat to $0.052 \text{ m}\cdot\text{s}^{-1}$ for hay meadows. The presence of moss, with its coarse structure, appears a contributing factor to lower overland flow velocities and higher roughness in both the peatland and low-density grazed pasture. This highlights the importance of vegetation structure in the first few centimetres (Pan et al., 2016) as this is the part that interacts with overland flow.

As overland flow velocity decreased (vegetation roughness increased) there was proportional increase in flow depth. Overland flow velocity is dependent on the 'roughness', which is related to the vegetation density of the first few cm of vegetation, where the overland flow is being intercepted by the vegetation. This is further highlighted through further comparison between the grass wood pasture and the grassland habits studied by Bond et al. (2020) (Table 6). The grass wood pasture investigated in our study had a lower grazing intensity ($0.10 \text{ LU}\cdot\text{ha}^{-1}$) but higher overland velocity compared to the 'low-density grazing' ($0.25 \text{ LU}\cdot\text{ha}^{-1}$) site in Bond et al. (2020). The generally higher flow depth exhibited by the habitats studied by Bond et al. (2020) suggest that more of the vegetation is intercepting overland flow down the hillslope. Bond et al., (2020) attributed this to the mossy understorey found at the 'low-density grazing' site. Furthermore, the rank grassland site, where grazing had been removed for 6 years, also exhibited lower overland flow velocities compared with

TABLE 5 Comparison of overland flow velocities at flow rates of 30, 15 and 3 L·m⁻¹·s⁻¹ recorded in our study against previous work

Habitat	Study	Flow rates			Mean overland flow velocity, <i>U</i>
		3 L·m ⁻¹ ·s ⁻¹	15 L·m ⁻¹ ·s ⁻¹	30 L·m ⁻¹ ·s ⁻¹	
Grass wood pasture	This	<i>U</i> = 0.011 <i>n</i> = 1.890 <i>f</i> = 0.026 <i>d</i> = 0.009	<i>U</i> = 0.031 <i>n</i> = 0.518 <i>f</i> = 0.066 <i>d</i> = 0.006	<i>U</i> = 0.047 <i>n</i> = 0.502 <i>f</i> = 0.100 <i>d</i> = 0.011	0.033
Hay meadows	Bond et al., (2020)	<i>U</i> = 0.012 <i>n</i> = 0.917 <i>f</i> = 0.052 <i>d</i> = 0.005	<i>U</i> = 0.031 <i>n</i> = 0.545 <i>f</i> = 0.039 <i>d</i> = 0.009	<i>U</i> = 0.052 <i>n</i> = 0.341 <i>f</i> = 0.154 <i>d</i> = 0.010	0.032
Bare peat	Holden et al., (2008)	-	-	<i>U</i> = 0.050	-
Established Semi-natural Woodland	This	<i>U</i> = 0.010 <i>n</i> = 2.410 <i>f</i> = 0.022 <i>d</i> = 0.011	<i>U</i> = 0.028 <i>n</i> = 0.76 <i>f</i> = 0.058 <i>d</i> = 0.009	<i>U</i> = 0.043 <i>n</i> = 0.592 <i>f</i> = 0.081 <i>d</i> = 0.012	0.027
Rushes	Bond et al., (2020)	<i>U</i> = 0.007 <i>n</i> = 2.238 <i>f</i> = 0.023 <i>d</i> = 0.008	<i>U</i> = 0.026 <i>n</i> = 0.747 <i>f</i> = 0.071 <i>d</i> = 0.011	<i>U</i> = 0.039 <i>n</i> = 0.586 <i>f</i> = 0.093 <i>d</i> = 0.014	0.024
Bracken wood pasture	This	<i>U</i> = 0.008 <i>n</i> = 2.543 <i>f</i> = 0.019 <i>d</i> = 0.009	<i>U</i> = 0.023 <i>n</i> = 1.003 <i>f</i> = 0.052 <i>d</i> = 0.011	<i>U</i> = 0.038 <i>n</i> = 0.674 <i>f</i> = 0.075 <i>d</i> = 0.013	0.023
Peat grassland	Holden et al., (2008)	-	-	<i>U</i> = 0.037	-
Rank Grassland	Bond et al., (2020)	<i>U</i> = 0.004 <i>n</i> = 5.699 <i>f</i> = 0.010 <i>d</i> = 0.013	<i>U</i> = 0.019 <i>n</i> = 1.403 <i>f</i> = 0.039 <i>d</i> = 0.015	<i>U</i> = 0.030 <i>n</i> = 1.007 <i>f</i> = 0.056 <i>d</i> = 0.019	0.018
Low-density Grazing	Bond et al., (2020)	<i>U</i> = 0.006 <i>n</i> = 3.255 <i>f</i> = 0.016 <i>d</i> = 0.009	<i>U</i> = 0.018 <i>n</i> = 1.392 <i>f</i> = 0.040 <i>d</i> = 0.016	<i>U</i> = 0.028 <i>n</i> = 1.053 <i>f</i> = 0.054 <i>d</i> = 0.020	0.017
Peat grassland and moss mix	Holden et al., (2008)	-	-	<i>U</i> = 0.023	-
Peat moss	Holden et al., (2008)	-	-	<i>U</i> = 0.023	-
Mean overland flow velocity, <i>U</i>		0.008	0.025	0.040	

Note: Measurements from Bond et al. (2020) are from November, as the closest seasonal comparison to our study.

Abbreviations: *U*, mean overland flow velocity (m·s⁻¹); *n*, estimate of Manning's *n* coefficient (s·m^{-1/3}); *f*, Darcy-weisbach roughness 1/sqrt(*f*); *d*, mean flow depth (m).

sites investigated in our study. The rank grassland site looks visibly rougher, see Table 6, indicating the potential benefits of removing grazing. Comparing these grassland habitats offers an insight into the variability the management of land and species presence can have on overland flow.

Surface roughness and overland flow velocity depend on habitat management and vary seasonally due to changes in vegetation over the growing season (Bond et al., 2020). It would be expected that the habitats we investigated would also be impacted by seasonality, but we our unable to assess this since our study was restricted to measurements taken in October. The seasonal growth and dieback of bracken would likely influence roughness throughout the year dependent on management. Depending on how bracken grows and decays, its influence on roughness in the first few cm will vary and future work is needed to confirm its control on overland flow seasonally.

4.4 | Impact of grazing

The wood pasture environments investigated in this study were managed with a relatively low grazing intensity. Soil properties and vegetation roughness are strongly influenced by grazing regimes (Drewry et al., 2008) and we compared our findings with areas of grassland managed at different grazing intensities in the neighbouring valley, Swindale. The frequency of overland flow occurrence will determine the relative importance of surface roughness or permeability for flood management. If soils are shallow then overland flow may occur despite high *K*_{sat}, and therefore surface roughness is of greater importance. If compaction is preventing infiltration, then improving soil aeration and therefore *K*_{sat}, may be the best method. Grazing livestock can exert considerable pressure on the soil surface, causing compaction (Chandler et al., 2018; Wheeler et al., 2002), and reducing

TABLE 6 Comparison of grassland habitats with Bond et al. (2020)

Study	Bond et al., 2020	Bond et al., 2020	This study
Habitat	Low-density grazing	Rank grassland	Grazed wood pasture
Site description	Consisting of common grasses, underlain by moss throughout. Due to grazing, these species remain close to ground level. Grazing occurs in this area for short periods of time for treatments, shearing and separating lambs from ewes.	Typically species poor, rank grassland is dominated by tall, tussocky and coarse grass species and is produced in unmanaged, ungrazed grasslands.	Open pasture with scattered established trees. Grazed all year round, with intermittent high density grazing due to its preferential location next to farm buildings.
Grazing Intensity	0.25 LU·ha ⁻¹	No grazing for 6 years	0.10 LU·ha ⁻¹
Visual comparison			

soil porosity (Clarke et al., 2008). If grazing density is too high, then decreasing stocking levels is likely to increase both roughness and K_{sat} . Future work is needed to investigate how different grazing intensity and livestock (e.g. cattle versus sheep) impacts on vegetation roughness and overland flow velocity. Some grazing systems may develop more heterogeneity in vegetation (Lunt et al., 2021) and roughness, with possible implications for downstream flood peaks.

4.5 | Impact of tree canopy

This study has identified potential co-benefits and tradeoffs between tree canopy cover, understorey vegetation and grazing. Chandler et al. (2018) found that both tree species and forest management (grazed versus ungrazed) have important effects on soil hydraulic properties with implications for surface runoff. Future research is needed to compare a wider range of tree species, woodland management and tree density.

Woodlands with closed canopy cover will typically have sparse understorey vegetation (Alder et al., 2018), resulting in lower surface roughness and greater overland flow velocity. Mature semi-natural woodlands with a varied age structure and canopy gaps, woody debris, shade-tolerant woodland flora communities and greater understorey are likely to result in greater surface roughness and reduced overland flow. Woodlands with a relatively open canopy may therefore combine the higher soil permeability typical of woodland soils in combination with the higher surface roughness associated with a denser understorey. In contrast, wood pasture has less permeable soils likely due to the lower density of trees but greater surface roughness where the ground vegetation below the open canopy is dominated by bracken. Wood pasture has a wide range of grazing regimes,

understorey vegetation, tree density and canopy cover. Careful control of grazing levels to allow natural regeneration and increased tree density could increase soil permeability towards levels seen in woodlands whilst maintaining vegetation understorey and associated lower overland flow velocity.

4.6 | Suitability of Manning's n roughness coefficient

We found that the Manning's n values calculated for the three habitats investigated in this study can be an order of magnitude higher than previous values reported by Chow (1959) and others (Arcement & Schneider, 1989). We compare our grass wood pasture site ($n = 0.50$ – 1.89) to the Chow (1959) floodplain habitat described as a short grass habitat ($n = 0.030$), the bracken wood pasture ($n = 0.67$ – 2.54) with floodplain covered with medium to dense brush ($n = 0.100$) and established woodland ($n = 0.59$ – 2.41) to the 'heavy stand of timber, a few down trees, little undergrowth, flood stage below branches' ($n = 0.100$). This supports the potential unsuitability of Manning's n roughness coefficients to represent hillslope vegetation roughness and shallow overland flows in hydrological modelling (Arcement & Schneider, 1989; Rose & Rosolova, 2015). Manning's n is not constant in these environments and varies with water depth across vegetated surfaces (Zhang et al., 2021). Different types of vegetation cover have more resistance to overland flow and are 'rougher' (Bond et al., 2020; Holden et al., 2008). Rougher land covers reduce the velocity of overland flow and can contribute to reducing flood risk further down the catchment (Gao et al., 2016). Therefore, it is important to represent these environments as accurately as possible when modelling for future flood.

4.7 | Woodland creation and management for NFM

Our results show the potential for woodland and wood pasture in the UK uplands to increase soil permeability and surface roughness and reduce overland flow. Results from our study and others (Chandler et al., 2018; Murphy et al., 2020) suggest that woodland type and management are important controls over soil permeability and overland flow velocity. We found bracken-dominated wood pasture to have the slowest overland flow, whilst the established woodland had the highest K_{sat} values. Bracken is often considered to be a weed that needs to be managed; our results demonstrate the benefits bracken can have on slowing overland flow. Trees play an important role in altering soil properties and permeability but tree density may not necessarily be the most important factor (Murphy et al., 2020). Future work is needed to assess the effects of tree stocking density on soil permeability and surface roughness to inform woodland creation grant schemes (e.g., England Woodland Creation Offer).

Many UK woodlands are grazed by sheep and deer with important impacts on tree regeneration and ground vegetation (Ford & Smith, 2016) that will alter soil properties including permeability, surface roughness and overland flow. Long-term changes in understorey are also occurring across UK woodlands due to changes in management and deer density (Amar et al., 2010) but the impacts on surface roughness and overland flow are not known. The impact of grazing intensity in wood pasture on tree regeneration, soil properties and surface roughness also needs further investigation.

In addition, modelling work is needed to understand the relative impacts of greater permeability in mature woodland compared to lower overland flow in bracken wood pasture on downstream flooding. Future work is needed to explore potential tradeoffs between tree density, biomass carbon storage, soil permeability and overland flow and the implications for both climate mitigation and NFM.

5 | CONCLUSION

In this study, we report saturated hydraulic conductivity (K_{sat}) and overland flow velocity in established semi-natural woodland and wood pasture dominated by either a bracken or grass understorey. We find that mature semi-natural woodland soils have the highest K_{sat} and storage of soil water, whilst the bracken wood pasture has the roughest surface, resulting in the lowest overland flow. However, it is important to note our study is carried out in a limited area to represent the three land covers investigated, further sites are needed to ensure these sites are consistent with other areas of similar land cover.

Combined, these habitats have the potential to reduce flood risk by temporarily retaining surface and subsurface storm water. During the initial stages of a storm, woodland soils have the potential to delay and reduce peak flow through storing storm water. However, once available soil storage is filled or compaction reduces infiltration,

reductions in overland flow velocity are crucial. This is where areas of bracken wood pasture can play their part. Bracken, whilst often seen as a nuisance, can be beneficial on the slopes of a catchment to increase surface roughness, reducing overland flow velocity.

Future work is needed to understand how variations in canopy cover and understorey vegetation within woodland and wood pasture impact both soil permeability and surface roughness. Improved understanding may allow land management to be crafted to maximize the benefits of both woodlands and wood pasture for reduced downstream flooding.

ACKNOWLEDGEMENTS

This research was supported by the United Bank of Carbon (UBoC) and the European Research Council (ERC) under the European Union's Horizon 2020 Research and Innovation programme (DECAF project; grant no. 771492). Dominick Spracklen acknowledges a Philip Leverhulme Prize. The authors thank United Utilities, and RSPB Haweswater, for granting access, permissions and equipment storage. We also thank volunteers for assisting with field measurements.

DATA AVAILABILITY STATEMENT

The data that support the findings of this study are openly available in the University of Leeds repository at <https://doi.org/10.5518/1059>

ORCID

Felicity Monger  <https://orcid.org/0000-0002-1780-2144>

Stephanie Bond  <https://orcid.org/0000-0003-4820-243X>

Mike J Kirkby  <https://orcid.org/0000-0003-2036-1770>

REFERENCES

- Agnese, C., Bagarello, V., Baiamonte, G., & Iovino, M. (2011). Comparing physical quality of forest and pasture soils in a Sicilian watershed. *Soil Science Society of America Journal*, 75, 1958–1970. <https://doi.org/10.2136/sssaj2011.0044>
- Alaoui, A., Rogger, M., Peth, S., & Blöschl, G. (2018). Does soil compaction increase floods? A review. *Journal of Hydrology*, 557, 631–642. <https://doi.org/10.1016/j.jhydrol.2017.12.052>
- Alder, D. C., Fuller, R. J., & Marsden, S. J. (2018). Implications of transformation to irregular silviculture for woodland birds: A stand wise comparison in an English broadleaf woodland. *Forest Ecology and Management*, 422, 69–78. <https://doi.org/10.1016/j.foreco.2018.04.004>
- Amar, A., Smith, K. W., Butler, S., Lindsell, J. A., Hewson, C. M., Fuller, R. J., & Charman, E. C. (2010). Recent patterns of change in vegetation structure and tree composition of British broadleaved woodland: Evidence from large-scale surveys. *Forestry*, 83, 345–356. <https://doi.org/10.1093/forestry/cpq017>
- Arcement, G. J., & Schneider, V. R. (1989). *Guide for selecting Manning's roughness coefficients for natural channels and flood plains*. US Government Printing Office Washington.
- Archer, N. A. L., Bonell, M., Coles, N., MacDonald, A. M., Auton, C. A., & Stevenson, R. (2013). Soil characteristics and landcover relationships on soil hydraulic conductivity at a hillslope scale: A view towards local flood management. *Journal of Hydrology*, 497, 208–222. <https://doi.org/10.1016/j.jhydrol.2013.05.043>
- Ashbrook, J. D. (2020). *Assessing the effectiveness of leaky dams at Crimsworth Dean*. Bridge.
- Blöschl, G., Hall, J., Viglione, A., Perdigão, R. A. P., Parajka, J., Merz, B., Lun, D., Arheimer, B., Aronica, G. T., Bilbashi, A., Boháč, M.,

- Bonacci, O., Borga, M., Čanjevac, I., Castellarin, A., Chirico, G. B., Claps, P., Frolova, N., Ganora, D., ... Živković, N. (2019). Changing climate both increases and decreases European river floods. *Nature*, 573, 108–111. <https://doi.org/10.1038/s41586-019-1495-6>
- Bond, S., Kirkby, M. J., Johnston, J., Crowle, A., & Holden, J. (2020). Seasonal vegetation and management influence overland flow velocity and roughness in upland grasslands. *Hydrological Processes*, 34, 3777–3791. <https://doi.org/10.1002/hyp.13842>
- Bronstert, A., Niehoff, D., & Bürger, G. (2002). Effects of climate and land-use change on storm runoff generation: Present knowledge and modelling capabilities. *Hydrological Processes*, 16, 509–529. <https://doi.org/10.1002/hyp.326>
- Burgess-Gamble L, Ngai R, Wilkinson M, Nisbet T, Pontee N, Harvey R, Kipling K, Addy S, Rose S, Maslen S. 2017. Working with natural processes—evidence directory. Environmental agency, Report No. SC150005.
- Burt, T., & Holden, J. (2010). Changing temperature and rainfall gradients in the British uplands. *Climate Research*, 45, 57–70. <https://doi.org/10.3354/cr00910>
- Calder I, Harrison J, Nisbet T, Smithers R. 2008. *Woodland actions for biodiversity and their role in water management*. Woodland Trust. http://www.woodlandtrust.org.uk/SiteCollectionDocuments/pdf/woodswater26_03-08.pdf
- Carroll, Z., Bird, S., Emmett, B., Reynolds, B., & Sinclair, F. (2004). Can tree shelterbelts on agricultural land reduce flood risk? *Soil Use Management*, 20, 357–359. <https://doi.org/10.1111/j.1475-2743.2004.tb00381.x>
- Chandler, K. R., Stevens, C. J., Binley, A., & Keith, A. M. (2018). Influence of tree species and forest land use on soil hydraulic conductivity and implications for surface runoff generation. *Geoderma*, 310, 120–127. <https://doi.org/10.1016/j.geoderma.2017.08.011>
- Chow, V. T. (1959). *Open-channel hydraulics*. McGraw-Hill civil engineering series.
- Clarke M, Creamer R, Deeks L, Gowing D, Holman I, Jones R, Palmer R, Potts S, Rickson R, Ritz K. 2008. Scoping study to assess soil compaction affecting upland and lowland grassland in England and Wales. In: Final project (BD2304) report to Defra, DEFRA.
- Cranfield University. 2019. *The soils guide*. Cranfield Univeristy.
- Cresswell, H., & Hamilton, G. (2002). Bulk density and pore space relations. In N. McKenzie, K. Coughlan, & H. Cresswell (Eds.), *Soil physical measurement and interpretation for land evaluation*. Csiro Publishing.
- Dadson, S. J., Hall, J. W., Murgatroyd, A., Acreman, M., Bates, P., Beven, K., Heathwaite, L., Holden, J., Holman, I. P., Lane, S. N., O'Connell, E., Penning-Rowsell, E., Reynard, N., Sear, D., Thorne, C., & Wilby, R. (2017). A restatement of the natural science evidence concerning catchment-based 'natural' flood management in the UK. *Proceedings of the Royal Society A: Mathematical, Physical and Engineering Science*, 473, 20160706. <https://doi.org/10.1098/rspa.2016.0706>
- Dean, W. E. (1974). Determination of carbonate and organic matter in calcareous sediments and sedimentary rocks by loss on ignition; comparison with other methods. *Journal of Sedimentary Research*, 44, 242–248. <https://doi.org/10.1306/74D729D2-2B21-11D7-8648000102C1865D>
- Delta-T. 1999. Theta probe soil moisture sensor user manual: Type ML2x. In: Delta-T Devices Ltd..
- Dixon, S. J., Sear, D. A., Odoni, N. A., Sykes, T., & Lane, S. (2016). The effects of river restoration on catchment scale flood risk and flood hydrology. *Earth Surface Processes and Landforms*, 41, 997–1008. <https://doi.org/10.1002/esp.3919>
- Drewry, J. J., Cameron, K. C., & Buchan, G. D. (2008). Pasture yield and soil physical property responses to soil compaction from treading and grazing review. *Soil Research*, 46, 237–256. <https://doi.org/10.1071/SR07125>
- Dunkerley, D., Domelow, P., & Tooth, D. (2001). Frictional retardation of laminar flow by plant litter and surface stones on dryland surfaces: A laboratory study. *Water Resources Research*, 37, 1417–1423. <https://doi.org/10.1029/2000WR900399>
- Eijkelkamp. 2011. Eijkelkamp Operating instructions. 09.02 Laboratory-permeameters.
- Emmett, W. W. (1970). *The hydraulics of overland flow on hillslopes* (Vol. 662). US Government Printing Office.
- Ford, H., & Smith, A. (2016). Trees, water storage and flooding in upland agricultural landscapes: Why do we need to know more? *Forestry & Timber news*, 27, 27–28.
- Gao, J., Holden, J., & Kirkby, M. (2016). The impact of land-cover change on flood peaks in peatland basins. *Water Resources Research*, 52, 3477–3492. <https://doi.org/10.1002/2015wr017667>
- Holden J, Chapman P, Evans M, Hubacek K, Kay P, Warburton J. 2007. Vulnerability of organic soils in England and Wales: Final technical report to DEFRA and Countryside Council for Wales DEFRA Project SP0532.
- Holden, J., Kirkby, M. J., Lane, S. N., Milledge, D. G., Brookes, C. J., Holden, V., & McDonald, A. T. (2008). Overland flow velocity and roughness properties in peatlands. *Water Resources Research*, 44, W06415. <https://doi.org/10.1029/2007WR006052>
- Iacob, O., Brown, I., & Rowan, J. (2017). Natural flood management, land use and climate change trade-offs: The case of Tarland catchment, Scotland. *Hydrological Sciences Journal*, 62, 1931–1948. <https://doi.org/10.1080/02626667.2017.1366657>
- Kenworthy JM. 2014. Regional weather and climates of the British Isles – Part 7: North West England and the Isle of Man. 69: 87–93. DOI: <https://doi.org/10.1002/wea.2256>.
- Krašić, D., Groner, E., Mészáros, M., Nikolić, T., Radišić, D., Milić, S., Kebert, M., Milić, D., Vujić, A., & Galić, Z. (2018). Riverine wood-pasture responds to grazing decline. *Ecological Research*, 33, 213–223. <https://doi.org/10.1007/s11284-017-1540-6>
- Kuhn, N. J., Bryan, R. B., & Navar, J. (2003). Seal formation and interrill erosion on a smectite-rich Kastanozem from NE-Mexico. *Catena*, 52, 149–169. [https://doi.org/10.1016/S0341-8162\(02\)00091-7](https://doi.org/10.1016/S0341-8162(02)00091-7)
- Kundzewicz, Z. W., Kanae, S., Seneviratne, S. I., Handmer, J., Nicholls, N., Peduzzi, P., Mechler, R., Bouwer, L. M., Arnell, N., & Mach, K. (2014). Flood risk and climate change: Global and regional perspectives. *Hydrological Sciences Journal*, 59, 1–28. <https://doi.org/10.1080/02626667.2013.857411>
- Lunt, P. H., Leigh, J. L., McNeil, S. A., & Gibb, M. J. (2021). Using Dartmoor ponies in conservation grazing to reduce *Molinia caerulea* dominance and encourage germination of *Calluna vulgaris* in heathland vegetation on Dartmoor, UK. *Conservation Evidence Journal*, 18, 25–30. <https://doi.org/10.52201/CEJ18SVSR7750>
- Marrs, R. H., Le Duc, M., Mitchell, R., Goddard, D., Paterson, S., & Pakeman, R. (2000). The ecology of bracken: Its role in succession and implications for control. *Annals of Botany*, 85, 3–15. <https://doi.org/10.1006/anbo.1999.1054>
- Marshall, M., Ballard, C., Frogbrook, Z., Solloway, I., McIntyre, N., Reynolds, B., & Wheeler, H. (2014). The impact of rural land management changes on soil hydraulic properties and runoff processes: Results from experimental plots in upland UK. *Hydrological Processes*, 28, 2617–2629. <https://doi.org/10.1002/hyp.9826>
- Mawdsley, T., Chappell, N., & Swallow, E. (2017). *Hydrological change on Tebay common following fencing and tree planting: A preliminary dataset*. Lancaster University.
- McCulloch, J. S., & Robinson, M. (1993). History of forest hydrology. *Journal of Hydrology*, 150, 189–216.
- Medeiros, S. C., Hagen, S. C., & Weishampel, J. F. (2012). Comparison of floodplain surface roughness parameters derived from land cover data and field measurements. *Journal of Hydrology*, 452–453, 139–149. <https://doi.org/10.1016/j.jhydrol.2012.05.043>
- Met.Office. 2020. UK climate averages.
- Meyles, E. W., Williams, A. G., Ternan, J. L., Anderson, J. M., & Dowd, J. F. (2006). The influence of grazing on vegetation, soil properties and stream discharge in a small Dartmoor catchment, Southwest England, UK. *Earth Surface Processes and Landforms*, 31, 622–631. <https://doi.org/10.1002/esp.1352>

- Milligan, G., Rose, R. J., & Marrs, R. H. (2016). Winners and losers in a long-term study of vegetation change at Moor House NNR: Effects of sheep-grazing and its removal on British upland vegetation. *Ecological Indicators*, 68, 89–101. <https://doi.org/10.1016/j.ecolind.2015.10.053>
- Monger F, V Spracklen D, J Kirkby M, Schofield L. 2021. The impact of semi-natural broadleaf woodland and pasture on soil properties and flood discharge *Hydrological Processes* 36: e14453. DOI: <https://doi.org/10.1002/hyp.14453>.
- Murphy, T., Hanley, M., Ellis, J., & Lunt, P. (2019). Deviation between projected and observed precipitation trends greater with altitude. *Climate Research*, 79, 77–89. <https://doi.org/10.3354/cr01583>
- Murphy, T. R., Hanley, M. E., Ellis, J. S., & Lunt, P. H. (2020). Native woodland establishment improves soil hydrological functioning in UK upland pastoral catchments. *Land Degradation and Development*, 32, 1034–1045. <https://doi.org/10.1002/ldr.3762>
- Ngai R, Wilkinson M, Nisbet T, Harvey R, Addy S, Burgess-Gamble L, Rose S, Maslen S, Nicholson A, Page T, Jonczyk J, Quinn P. 2017. Working with Natural Processes – Evidence Directory: Appendix 2: Literature review., DEFRA (ed.) Environment Agency.
- Nicholson, A. R., O'Donnell, G. M., Wilkinson, M. E., & Quinn, P. F. (2020). The potential of runoff attenuation features as a natural flood management approach. *Journal of Flood Risk Management*, 13, e12565. <https://doi.org/10.1111/jfr3.12565>
- Nisbet T, Thomas H. 2006. *The role of woodland in flood control: A landscape perspective*. Forest Research, Alice Holt Lodge, Farnham, Surrey.
- Orr, H. G., & Carling, P. A. (2006). Hydro-climatic and land use changes in the river lune catchment, north West England, implications for catchment management. *River Research and Applications*, 22, 239–255. <https://doi.org/10.1002/rra.908>
- Pakeman, R. J., & Marrs, R. H. (1992). The conservation value of bracken *Pteridium aquilinum* (L.) Kuhn-dominated communities in the UK, and an assessment of the ecological impact of bracken expansion or its removal. *Biological Conservation*, 62, 101–114. [https://doi.org/10.1016/0006-3207\(92\)90931-C](https://doi.org/10.1016/0006-3207(92)90931-C)
- Palmer, R., & Smith, R. (2013). Soil structural degradation in SW England and its impact on surface-water runoff generation. *Soil Use and Management*, 29, 567–575. <https://doi.org/10.1111/sum.12068>
- Pan, C., Ma, L., Wainwright, J., & Shangquan, Z. (2016). Overland flow resistances on varying slope gradients and partitioning on grassed slopes under simulated rainfall. *Water Resources Research*, 52, 2490–2512. <https://doi.org/10.1002/2015WR018035>
- Peringer, A., Siehoff, S., Chételat, J., Spiegelberger, T., Buttler, A., & Gillet, F. (2013). Past and future landscape dynamics in pasture-woodlands of the Swiss Jura Mountains under climate change. *Ecology and Society*, 18 <http://www.jstor.org/stable/26269345>
- Quinn, P., O'Donnell, G., Nicholson, A., Wilkinson, M., Owen, G., Jonczyk, J., Barber, N., Hardwick, M., & Davies, G. (2013). *Potential use of runoff attenuation features in small rural catchments for flood mitigation*. Newcastle University.
- Rasmussen, L. H., Kroghsbo, S., Frisvad, J. C., & Hansen, H. C. B. (2003). Occurrence of the carcinogenic bracken constituent ptaquiloside in fronds, topsoils and organic soil layers in Denmark. *Chemosphere*, 51, 117–127. [https://doi.org/10.1016/S0045-6535\(02\)00694-X](https://doi.org/10.1016/S0045-6535(02)00694-X)
- Robinson, M., Rodda, J. C., & Sutcliffe, J. V. (2013). Long-term environmental monitoring in the UK: Origins and achievements of the Plynlimon catchment study. *Transactions of the Institute of British Geographers*, 38, 451–463. <https://doi.org/10.1111/j.1475-5661.2012.00534.x>
- Rose S, Rosolova Z. 2015. *Energy crops and floodplain flows report - SC060092/R2*. Environment Agency: Bristol.
- Sansom, A. (1999). Upland vegetation management: The impacts of overstocking. *Water Science and Technology*, 39, 85–92. [https://doi.org/10.1016/S0273-1223\(99\)00322-4](https://doi.org/10.1016/S0273-1223(99)00322-4)
- Smit, C., Béguin, D., Buttler, A., & Müller-Schärer, H. (2005). Safe sites for tree regeneration in wooded pastures: A case of associational resistance? *Journal of Vegetation Science*, 16, 209–214. <https://doi.org/10.1111/j.1654-1103.2005.tb02357.x>
- Spray, C., Arthur, S., Bergmann, E., Bell, J., Beevers, L., & Blanc, J. (2016). Land management for increased flood resilience. In *Centre of Expertise for waters (CREW) facilitation team*.
- Stevens, A. J., Clarke, D., & Nicholls, R. J. (2016). Trends in reported flooding in the UK: 1884–2013. *Hydrological Sciences*, 61, 50–63. <https://doi.org/10.1080/02626667.2014.950581>
- Stratford CM, J.; House, A.; Old, G.; Acreman, M.; Duenas-Lopez, M.A.; Nisbet, T.; Burgess-Gamble, L.; Chappell, N.; Clarke, S.; Leeson, L.; Monbiot, G.; Paterson, J.; Robinson, M.; Rogers, M.; Tickner, D. . 2017. Do trees in UK-relevant river catchments influence fluvial flood peaks?: a systematic review., NERC/Centre for Ecology & Hydrology, pp: 46.
- Terpilowski, M. (2019). Scikit-posthocs: Pairwise multiple comparison tests in python. *Journal of Open Source Software*, 4, 1169. <https://doi.org/10.21105/joss.01169>
- Thomas, H., & Nisbet, T. (2012). Modelling the hydraulic impact of reintroducing large woody debris into watercourses. *Journal of Flood Risk Management*, 5, 164–174. <https://doi.org/10.1111/j.1753-318X.2012.01137.x>
- Uytvanck, J. V., Maes, D., Vandenhoute, D., & Hoffmann, M. (2008). Restoration of woodpasture on former agricultural land: The importance of safe sites and time gaps before grazing for tree seedlings. *Biological Conservation*, 141, 78–88. <https://doi.org/10.1016/j.biocon.2007.09.001>
- Virtanen, P., Gommers, R., Burovski, E., Oliphant, T. E., Cournapeau, D., Weckesser, W., Peterson, P., Mayorov, N., van der Walt, S., & Wilson, J. (2019). *scipy/scipy*. *SciPy*, 1(2), 1. <https://doi.org/10.5281/zenodo.2560881>
- Wallace, E. E., McShane, G., Tych, W., Kretschmar, A., McCann, T., & Chappell, N. A. (2021). The effect of hedgerow wild-margins on topsoil hydraulic properties, and overland-flow incidence, magnitude and water-quality. *Hydrological Processes*, 35, e14098. <https://doi.org/10.1002/hyp.14098>
- Wheater, H., & Evans, E. (2009). Land use, water management and future flood risk. *Land Use Policy*, 26, 251–264. <https://doi.org/10.1016/j.landusepol.2009.08.019>
- Wheeler, M. A., Trlica, M., Frasier, G. W., & Reeder, J. (2002). Seasonal grazing affects soil physical properties of a montane riparian community. *Journal of Range Management*, 55, 49–56. <https://doi.org/10.2307/4003262>
- Wingfield, T., Macdonald, N., Peters, K., Spees, J., & Potter, K. (2019). Natural flood management: Beyond the evidence debate. *Area*, 51, 743–751. <https://doi.org/10.1111/area.12535>
- Xu, M.-y., Xie, F., & Wang, K. (2014). Response of vegetation and soil carbon and nitrogen storage to grazing intensity in semi-arid grasslands in the agro-pastoral zone of northern China. *PLoS One*, 9, e96604. <https://doi.org/10.1371/journal.pone.0096604>
- Zhang, J., Zhang, S., Chen, S., Liu, M., Xu, X., Zhou, J., Wang, W., Ma, L., & Wang, C. (2021). Overland Flow Resistance Law under Sparse Stem Vegetation Coverage. *Water*, 13, 1657. <https://doi.org/10.3390/w13121657>
- Zimmermann, B., Elsenbeer, H., & De Moraes, J. M. (2006). The influence of land-use changes on soil hydraulic properties: Implications for runoff generation. *Forest Ecology and Management*, 222, 29–38. <https://doi.org/10.1016/j.foreco.2005.10.070>

How to cite this article: Monger, F., Bond, S., Spracklen, D. V., & Kirkby, M. J. (2022). Overland flow velocity and soil properties in established semi-natural woodland and wood pasture in an upland catchment. *Hydrological Processes*, 36(4), e14567. <https://doi.org/10.1002/hyp.14567>