

## Mechanistic Inquiry and Scientific Pursuit: The Case of Visual Processing

Philipp Haueis<sup>1\*</sup> and Lena Kästner<sup>2\*</sup>

1 Department of Philosophy, Bielefeld University, Germany

2 Department of Philosophy, Saarland University, Germany

\* authors contributed equally

**ABSTRACT:** Why is it rational for scientists to pursue multiple models of a phenomenon at the same time? The literatures on mechanistic inquiry and scientific pursuit each develop answers to a version of this question which is rarely discussed by the other. The mechanistic literature suggests that scientists pursue different *complementary* models because each model provides detailed insights into different aspects of the phenomenon under investigation. The pursuit literature suggests that scientists pursue *competing* models because alternative models promise to solve outstanding empirical and conceptual problems. Looking into research on visual processing as a case study, we suggest an integrated account of why it is rational for scientists to pursue *both* complementary *and* competing models of the same mechanism in scientific practice.

**Keywords:** Pursuit, Mechanism, Mechanistic Explanation, Discovery, Models, Visual Processing

## 1. Introduction

Philosophers and historians of science increasingly recognize that scientific inquiry does not proceed in a straight line. On the road from discovering a phenomenon to an acceptable explanation of its behavior, scientists often encounter choice points where they need to decide how to proceed further (Bechtel and Richardson, 2010). One decision is whether to develop an existing model or theory explaining the phenomenon further or whether to create a new model or theory (Kuhn, 1962; Kitcher, 1993).

Accounts of scientific pursuit are tailor-made to deal with competing theories and theory choice. Advocates of pursuit stress that scientists often pursue novel hypotheses, models, theories or research traditions even if they do not currently have adequate reasons to accept them as true (Laudan, 1979; Whitt, 1992). They consequently propose criteria which specify when some unit of inquiry is *pursuitworthy*, e.g., because it has a high rate of problem-solving progress (Laudan, 1979), or because it has programmatic character by providing heuristic strategies to solve outstanding empirical or conceptual problems in a field of research (Šešelja and Strasser, 2014). Pursuitworthiness criteria specify why it is rational that scientists work on new theories that might seem initially inferior to established ones, e.g. because they appear less accurate or less intelligible.

While the pursuit literature on the whole focuses on cases of competition between theories, some authors acknowledge that non-rivaling or complementary theories are also important for scientific progress (Šešelja and Straßer, 2014; Lichtenstein, 2021). For example: between two rivaling theories scientists should pursue the one which is consistent with a non-rivaling theory (Šešelja and Straßer, 2014). Yet scientists can also pursue a theory that is inconsistent with non-rivaling theories if it has programmatic character; viz. it provides a methodological plan of how to address this and other problems (Šešelja and Straßer, 2014, p. 3131). Either way, complementary models only play a role for assessing the pursuitworthiness of competing units of scientific inquiry. Yet it is clear that there are choice points on the way to explaining a phenomenon where scientists simply develop multiple complementary models or theories without the goal of assessing competing accounts of that phenomenon. Because pursuit

accounts are tailored to cases of competition, they do not answer when and why scientists work with multiple complementary models of the same phenomenon.<sup>1</sup>

However, this feature of scientific inquiry is widely acknowledged within the philosophy of science. The principal idea that many different models may be fruitfully combined to help scientists make progress is familiar from debates about, e.g., explanatory perspectives (e.g., Giere, 2006; Potochnik, 2010), robustness (e.g., Wimsatt, 1994; Lehtinen, 2018; Ylikoski and Aydinonat, 2014), pluralism (e.g., Elgin, 2017; Mitchell, 2003), and explanatory integration (e.g. Brigandt, 2013a, 2013b; Kästner, 2018; O'Malley, 2013; Plutynski, 2013; Wayne, 2018). It is particularly nicely captured by mechanistic discovery accounts (Bechtel and Richardson, 2010; Craver and Darden, 2013). These accounts emphasize that discovery and explanation are guided by normative constraints, such as to increase the intelligibility of the phenomenon and to uncover its causal structure completely and accurately (Kästner and Haueis, 2019). Since such constraints can be differentially emphasized and their satisfaction needs to be coordinated throughout scientific inquiry, mechanistic discovery accounts naturally accommodate for situations where researchers construct multiple models which capture different aspects of how the various entities and activities contribute to a mechanism's operation (Hochstein, 2016; Kästner, 2018). When mechanistic discovery accounts address the choice between competing models, they focus on cases where scientists accept one model because it is superior with regard to explanatory constraints. This is the case, for instance, if a given model captures the causal structure of the phenomenon more accurately and completely (Craver and Darden, 2013), or makes it more intelligible to researchers (Bechtel and Richardson, 2010) than a competing model it is compared to. But—short of an explicit pursuitworthiness criterion—mechanistic discovery accounts do not illuminate why researchers sometimes pursue models which are less intelligible, accurate, or complete than their competitors.

The above contraposition shows that accounts of mechanism discovery and pursuit highlight two different roles of multiple models of the same phenomenon that coexist in scientific

---

<sup>1</sup> Lichtenstein (2021) includes Barbara McClintock's work on genetic transposition in maize as a case of complementary pursuit without competition. In this case, however, different biologists pursued models of different phenomena. Lichtenstein's account thus does not address the pursuit of multiple complementary models of the same phenomenon.

practice. The mechanistic literature suggests that scientists pursue different *complementary* models to explain a phenomenon because each model provides insights into different entities, activities and the organization of the mechanism responsible for the phenomenon under investigation (Hochstein, 2016). The pursuit literature suggests that scientists pursue *competing* models to explain a phenomenon because each promise to solve outstanding empirical and conceptual problems faced by their alternatives. What is missing so far, however, is an account which combines insights from the mechanistic and pursuit literatures to answer why it is rational for a scientific community to pursue both complementary and competing models of the same phenomenon in order to explain it.

Our project in this paper is thus to provide such an integrative account by explicating how pursuitworthiness and mechanistic inquiry are linked. While the pursuit literature speaks of theories from rivaling research traditions (e.g. Laudan, 1977; Lichtenstein 2021), the mechanistic literature largely focuses on models being pursued (Colombo, Hartmann and van Iersel, 2015; Hochstein, 2016). For our analysis here we focus on the pursuit of mechanistic models describing entities and their causal interactions (activities) which are responsible for the phenomenon to be explained (Craver and Darden, 2013). Pursuit, as we see it, is accordingly characterized as the process of developing explanatory mechanistic models.<sup>2</sup>

We shall develop our account by looking into research on visual processing. Visual processing research provides a case in which researchers developed either complementary or competing models when encountering various choice points (sections 2.1 and 2.2, respectively). To establish that these are genuine cases of pursuit, we discuss how researchers made decisions on what research path to follow by analysing a sequence of published papers and by referring to existing historical research (Plebe 2018, Haueis 2021a). Next, we build on the pattern account of mechanistic inquiry (Kästner and Haueis, 2019) to show why it is rational for a scientific community to pursue *both* complementary *and* competing models of the same mechanism in scientific practice (section 3.1). The pattern account is particularly suited to the task: since our

---

<sup>2</sup> We follow Šešelja and Weber (2012) in assuming that what is rational to pursue is determined at the level of a scientific *community*, not individual scientists.

case study comes from neuroscience—a paradigm domain of mechanistic inquiry—it seems natural to supplement a mechanistic account with insights from the pursuit literature.<sup>3</sup> Besides, the pattern account provides an analytic toolkit that we use to (i) locate the pursuit of multiple models in the *multiplicity of epistemic operations* scientists employ during mechanistic inquiry and (ii) offer specific criteria to distinguish between complementary and competing models (section 3.2). Finally, we suggest that, in mechanistic inquiry, a model’s programmatic character is what enables researchers to investigate a given phenomenon beyond the parts of the mechanism the model actually describes (section 3.3). We conclude that, vis-à-vis the pattern account, the literatures on mechanistic explanation and scientific pursuit are fundamentally linked and highlight congenial aspects of scientific inquiry.

## 2. The pursuit of multiple models in visual neuroscience

In this section, we present two historical episodes in which neuroscientists pursued multiple models of cortical visual processing after facing choice points. Our reconstruction builds on a sequence of published papers which show how researchers decided to refine existing or develop new models trying to explain how the cortex transforms visual input from the retina, relayed via the optic nerve and subcortical regions, into output which ultimately leads to conscious visual perception or overt behavior (e.g., eye movements). The models of cortical visual processing we discuss below complement or compete with the so-called “ice-cube” model (Hubel and Wiesel, 1972, 1977). This model was a landmark achievement in understanding the organization of the primary visual cortex (V1) in particular, and the characteristics of visual processing as a whole. Figure 1a displays the first published version of the ice-cube model which combines several experimental findings about the anatomical inputs, local structure and function of V1.<sup>4</sup> First,

---

<sup>3</sup> One might alternatively develop a pursuit account Šešelja and Straßer’s (2014) or Lichtenstein’s (2021) to address complementary models of the same phenomenon and apply it to a case of mechanism discovery. Although we do not think that such an approach is impossible in principle, our discussion shows that the pattern account already naturally accommodates both competing and complementary models in an integrated manner.

<sup>4</sup> Note that Hubel and Wiesel’s diagrams of V1 architecture pre-date the term “ice-cube model” which was first introduced by Hubel and Livingstone (1983). In this paper, the first published version of the model (see Fig. 1a) appears alongside a simplified representation as a cube without thalamic inputs and the revised ice-cube model we discuss in section 2.1.

unlike neurons from which they receive input, V1 neurons are *orientation selective*: they respond more strongly to bars at a certain angle in the visual field. Second, every neuron has a right or left *ocular dominance*: it responds more strongly to stimuli presented to the left or right eye. Third, orientation-selective cells and ocular dominance cells are organized into *columns*—vertical structures whose neurons have similar functional response properties. The ice-cube model thus decomposes V1 into anatomically uniform functional modules, which contain a full set of orientation columns (responding to angles from 0°–180°), that orthogonally intersect with two ocular dominance columns.

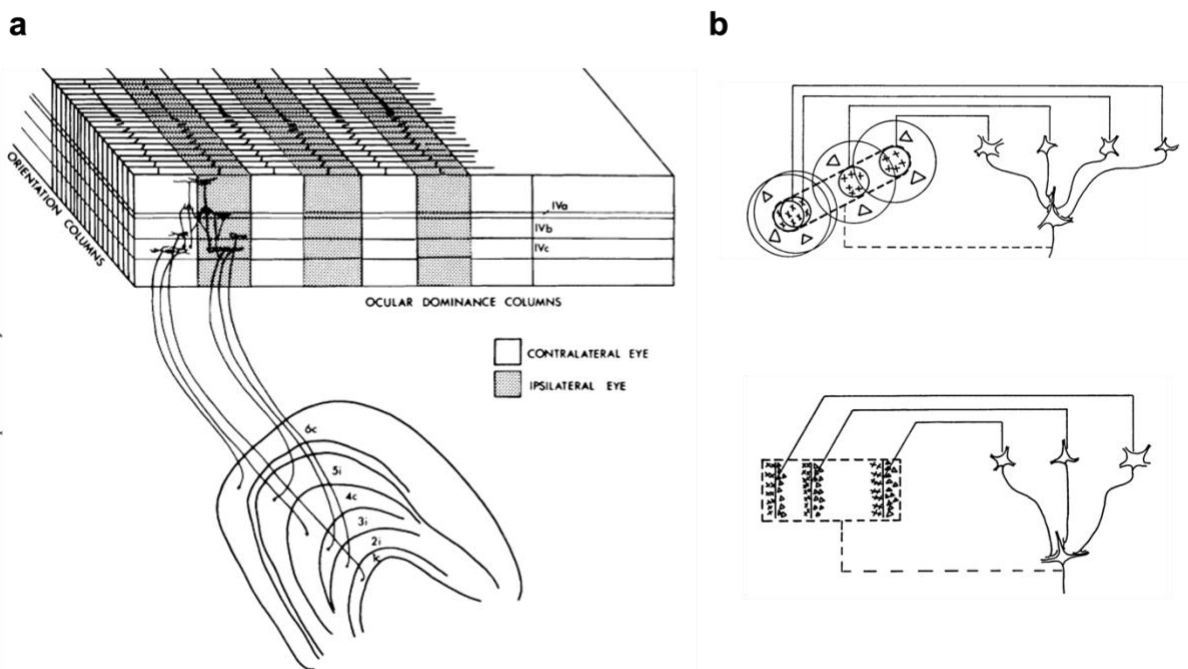

**Fig. 1a** Left: Ice-cube model of V1, Hubel and Wiesel (1972), **1b** Right: Hierarchical wiring schemes used to explain orientation selectivity in simple cells in layer 4 (top) and invariance to stimulus location in a complex cell (bottom), adopted from Hubel and Wiesel (1962).

The ice-cube model describes how V1 analyzes the “building blocks for perception” (Hubel and Wiesel, 1977, p. 17) by combining a columnar view of cortical architecture (Fig. 1a) with the *modular functional hierarchy* (MFH) view of function (Fig. 1b). The MFH view explains perception as the processing of increasingly abstract (i.e., stimulus-invariant) representations (Burnston, 2016). For example, subcortical cells (Fig. 1a, bottom) forward information about different locations to a V1 cell in layer 4 (Fig. 1a, top right). This cell has a “simple” receptive field because

it which represents the orientation of an edge at a particular place in the visual field (Fig. 1b top). Multiple simple cells then forward this information to a single “complex” cell, which represents the orientation wherever it occurs across the receptive fields of the simple cells (Fig. 1b bottom). The ice-cube model presupposes this hierarchical scheme because it describes functional modules composed of orientation columns – each of which consists of simple cells and complex cells with the same orientation selectivity and similar receptive field position (Hubel and Wiesel 1977, p. 25).

The ice-cube model contributes to a mechanistic explanation of visual processing because it decomposes V1 into entities (simple cells, complex cells) and activities (orientation selective responses) and shows how they are organized (columnar architecture, modular functional hierarchy) to represent the orientation and motion of contours from a particular portion of the visual field (Bechtel, 2008, p. 105). Despite its potential explanatory value, the model also faces various conceptual and empirical problems, the resolution of which led visual neuroscientists to pursue multiple models of cortical visual processing.

### *2.1 Choice point 1—Pursuing multiple complementary models: pathways and wiring diagrams*

The first problem of the ice-cube model is that it subdivides V1 into units with “arbitrary” boundaries (Hubel and Wiesel, 1977, p. 17) because the lines that delineate functional modules in Fig. 1a do not correspond to detectable anatomical locations in V1. The discovery of *cytochrome oxidase blobs* apparently solved this problem. By staining V1 with cytochrome oxidase (CO), Hubel and his collaborators discovered 200 $\mu$ m wide “blobs”. Since the CO blobs have detectable anatomical locations in V1, they resolve the issue that the boundaries of modules in the ice-cube model are arbitrarily chosen. In the revised version of the ice-cube model (Fig. 8 in Livingstone and Hubel, 1983), two blobs are included at the center of each ocular dominance column. Therefore, the outer boundaries of the left and right ocular dominance columns can be regarded as nonarbitrary boundaries of the functional modules described by the ice-cube model.

Although CO blobs were initially used to revise the ice-cube model, they subsequently contributed to a complementary model because they were unexpectedly involved in *color vision*. Color is a central feature of visual perception, but the ice-cube model does not tell researchers how color information is processed. Color thus marked a choice point for Hubel and his coworkers: “we began with an interest in blobs, and that led us to color because color is what the blobs seem to be largely concerned with” (Hubel and Livingstone 1983, p. 1441). The pursuit of color processing is a choice point in the sense of Bechtel and Richardson (2010) because it reflects a shift from direct localization to the complex localization of multiple subtasks. While neuroscientists initially assumed that visual processing was directly localized in V1 (Bechtel, 2008, pp. 91f.), Hubel and Wiesel’s research showed that V1 is only involved in “the first five or six steps in the processing of visual information” (Hubel and Wiesel, 1977, p. 5). To search for further steps, one had to complement the ice-cube model of V1 with research on other cortical areas.

The discovery of CO blobs provided an opportunity to do just that. Livingstone and Hubel (1984) showed that blob cells are not orientation- but color-selective, whereas cells located between the blobs—in “interblobs”—were orientation- but not color-selective. Anatomical tracer experiments showed that blobs and interblobs connect to different CO *stripes* that run in parallel throughout the secondary visual cortex (V2). To describe the function of the blob and stripe systems, Livingstone and Hubel (1988) linked them to different *visual pathways*, which run from the retina via subcortical regions to different visual cortical areas. Taken together, Livingstone and Hubel’s papers on CO blobs and color vision show how the researchers’ interests gradually shifted from a focus on columns and V1 architecture (Hubel & Livingstone 1983, Livingstone & Hubel 1984, p. 353; 1987 p. 3428; Hubel & Livingstone, 1987, p. 3389f., p. 3405) to being largely about the processing of more specific visual features in different visual pathways (Livingstone and Hubel 1988).



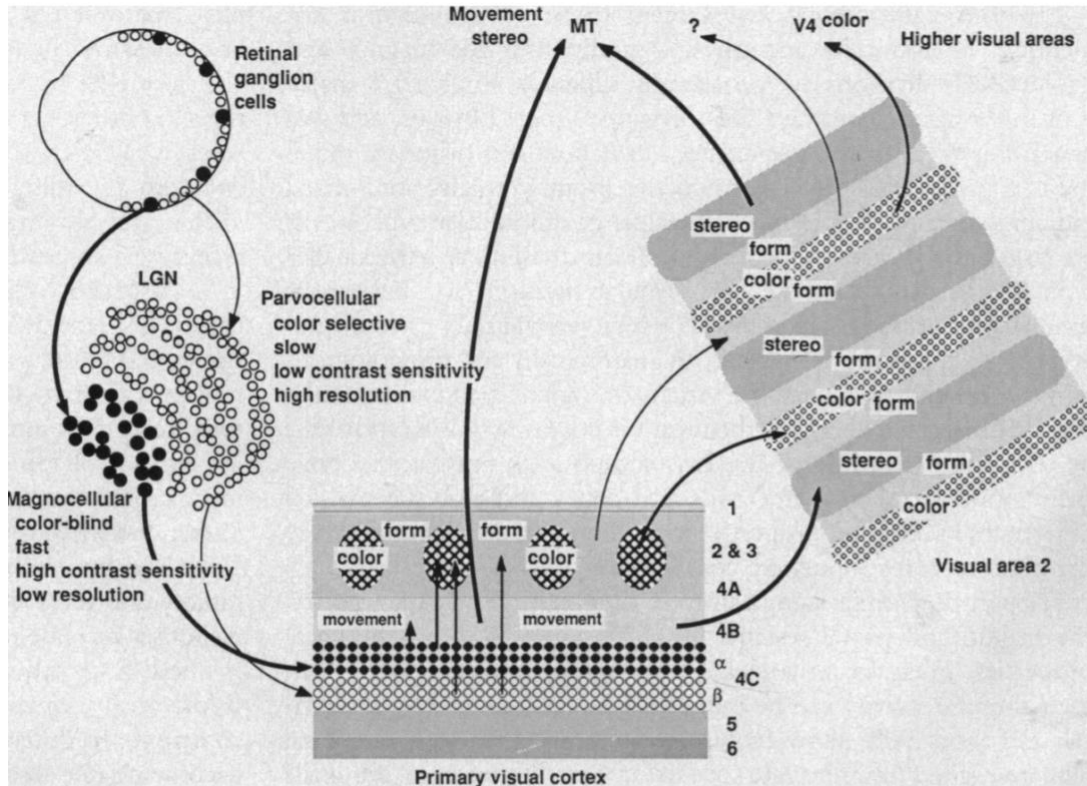

**Fig. 2** Diagram of functionally segregated pathways in the visual system (Livingstone and Hubel 1988, Fig. 4).

In Fig. 2, V1 blobs and thin V2 stripes are located in the *parvocellular* pathway, which starts from small retinal cells that provide inputs to thalamic and cortical neurons that are color-selective and respond slowly to resolve stimuli with high precision. By including retinal and subcortical stations, the *parvocellular* pathway goes beyond what Ungerleider et al. (1983) called the ‘what’ pathway involved in object identification. By contrast, neurons in the *magnocellular* pathway receive inputs from retinal neurons with large cell bodies which are not color-selective and respond quickly to resolve contrasts at a coarse resolution. This pathway projects to interblobs in layer 4C $\alpha$  and from there to the V2 stripes and motion- and disparity-selective cells in area MT. As such, the magnocellular pathway goes beyond what Ungerleider et al. (1983) called the ‘where’ pathway involved in tasks involving object position.

The model of visual pathways in Fig. 2 complements the ice-cube model in three ways. First, it distinguishes novel functional subdivisions in V1 besides orientation and ocular dominance columns: blobs process information about color, interblobs process information about form, and

layer 4B cells process information about the motion of visual stimuli. These processing functions complement the processing of local contours described by the ice-cube model. Second, because each subdivision has distinct anatomical inputs and outputs, the processing functions within V1 are functionally segregated in the larger visual system (Fig. 2, black arrows). This supports the view that “the visual system is subdivided into separate parts whose functions are quite distinct” (Livingstone and Hubel 1988, p. 740). One such visual-system function is the fast but color-blind processing of brightness and motion; another is the slow but detailed processing of form and color.

Third, while the ice-cube model primarily describes the local terrain in V1, the pathway model also maps how neural signals transit through different parts of that terrain.<sup>5</sup> For example: The ice cube model describes how a cell in an upper cortical layer gets a complex receptive field and responds to input from both eyes because it is wired to multiple cells from layer 4, which have simple receptive fields (Fig. 1b) and which receive input from one eye only (Hubel and Wiesel 1977, Fig. 12). This is a description of the local terrain which relates features of vertical columns (ocular dominance, orientation) to cells located in different horizontal layers. By contrast, the pathway model describes anatomical subdivisions in each layer based on their parvocellular or magnocellular inputs (Fig. 2). This is a description of how signals flow through the local terrain in V1 which distinguishes subdivisions based on “the kinds of visual information they carry, as in earlier stages [of visual processing]” (Livingstone and Hubel 1988, p. 742).

A second model complementing the ice-cube model was the wiring diagram of V1 developed by Wiesel and Gilbert (1983) to account for horizontal connections. The ice-cube model was based on known thalamic inputs to V1 (Fig. 1a) and assumes that cells within the same orientation column are likely interconnected to minimize wiring length (Hubel and Wiesel 1977, p. 9, 25, 40). However, cells within one orientation column frequently have horizontal connections extending to neighboring columns. This finding presented a potential problem to the ice-cube model, which predicts that “cells of different orientation preference would not be expected to be interconnected except possibly by inhibitory synapses.” (Hubel and Wiesel, 1977,

---

<sup>5</sup> We thank an anonymous reviewer for suggesting this formulation.

p. 9). Thus, excitatory connections between neighboring columns would present an issue to the ice-cube model. To tackle this issue, Wiesel and Gilbert (1983) combined two experimental techniques not used in Hubel and Wiesel's original studies: intracellular recordings to measure the functional responses of neurons and the injection of horseradish peroxidase to visualize the axonal and dendritic branching pattern of those neurons. Wiesel and Gilbert proposed a wiring diagram of incoming, internal and outgoing connections (Fig. 3, middle). They supplemented the wiring diagram with three hypothetical mechanisms specifying the functional role of three types of inter-column connections:

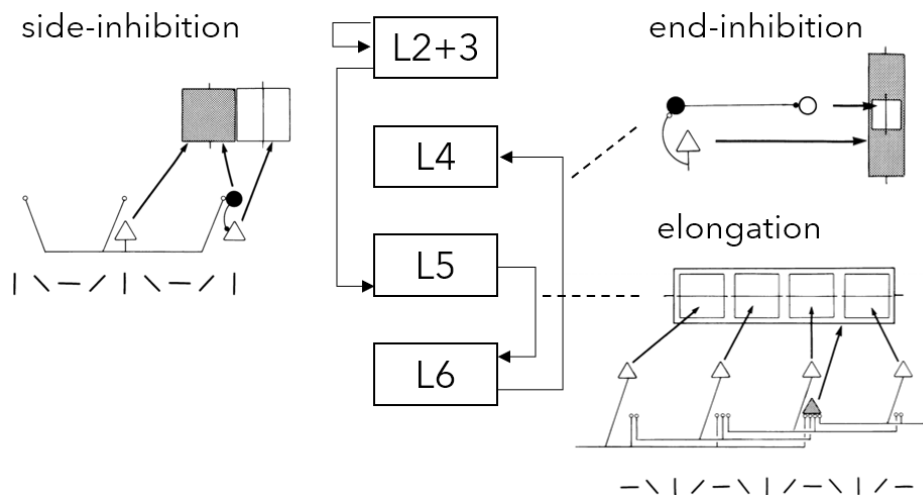

**Fig. 3** Schematic wiring diagram displaying three types of connections between layers of V1 (middle) and three hypothetical mechanisms explaining the functional role of these connections (based on Wiesel and Gilbert 1983, Figs. 2, 6, 9 and 13).

For present purposes, what matters are not the details of these hypothetical mechanisms, but the fact that like Hubel and Wiesel's model, this model explains observed functional responses of V1 in terms of the capacities of different neuronal populations within a column. By applying new methods to the same anatomical structures, Wiesel and Gilbert gained additional insights about horizontal connections between columns. The resulting wiring diagram shows that this information is consistent with a modular and hierarchical view of visual processing (section 3.2). The posited mechanisms and wiring diagram complement the ice-cube model by reconciling evidence for horizontal connections with the columnar functional architecture.

Both the discovery of color blobs and inter-columnar connections initially presented challenges for the original ice-cube model. In response, scientists focused on different aspects of the phenomenon of cortical visual processing, e.g., how the cortex processes information about color, form and motion, or which mechanisms underlie orientation-selective responses in V1. To explain these aspects, researchers provided complementary models—of visual pathways and wiring diagrams—that served to reconcile the ice-cube model with the novel findings. Importantly, complementary models do not simply add information about the larger system (that would be to change the phenomenon characterization and thus the explanandum). Rather, they model the very phenomenon under scrutiny in such a way that outstanding issues which other models do not or cannot address get resolved. This can be achieved either by discovering new entities or activities within a given system, or by discovering new details about known entities and activities (section 3.2). Importantly, neither Livingstone and Hubel’s model of visual pathways, nor Wiesel and Gilbert’s diagram were intended to replace the ice-cube model or to explain visual processing in isolation. They both served to complement the ice-cube model in different ways by focusing in on different anatomical and functional details of the early visual system uncovered through additional research and new methodologies.

The researchers’ choice to pursue complementary models rather than to discard the ice-cube model fits well with the mechanistic story of scientific inquiry. First, mechanist philosophers highlight that discovery and explanation of a phenomenon is an incremental process (Craver and Darden, 2013, p. 31). Some scientists may focus on a specific component or functional unit within a larger-scale mechanism and uncover how precisely that part of the overall mechanism works while other scientists may focus on a different component or aspect of organization. Applied to the case above, we might say that models of visual pathways and wiring diagrams provided insights into different aspects of the overall mechanism underlying visual perception. Generally speaking, such division of labor seems not only viable but a rational and promising way to make headway in science. Different members of the community will use their tools, background knowledge and experience to fill in specific details of the mechanism.

Second, research on different aspects of a phenomenon must eventually be integrated (Craver, 2007, ch. 7). While mechanistic integration is a somewhat vexed issue (see Kästner,

2017), it seems hard to deny that “an individual [mechanistic] model is rarely applied in isolation, and is often used to complement a huge body of background information and pre-existing models about the target system” (Hochstein, 2016, p. 1401). Against this background, Eric Hochstein suggests a distributed account of mechanistic explanation, according to which an explanation for a phenomenon is “distributed across sets of scientific models, with each model in the set contributing a piece to the same overall explanatory whole.” (Hochstein, 2016, p. 1401). The ice-cube model, the visual pathway diagram and the wiring diagram form such a set because they contribute to explain cortical visual processing. The different models provide information about different features or aspects of a phenomenon, “and so can be used to inform one another [...] by characterizing different causal, organizational, or behavioural properties that will allow us to rule out some models, and refine others” (Hochstein, 2016, p. 1403).

In our case, information about visual pathways rules out models which posit that areas beyond V1 are not specialized for visual processing (Bechtel, 2008, p. 106), and information about V1 wiring refines the ice-cube model. Mechanistic accounts thus explain that it is rational for a community of researchers to pursue multiple complementary models because each of them provides different constraints on the explanation of the phenomenon. It was rational for Livingstone, Hubel, Gilbert and Wiesel to pursue multiple models because each of them provided non-redundant information about different entities and activities that further constrained the space of plausible mechanisms for cortical visual processing.

## 2.2 Choice point 2—Pursuing competing models: canonical microcircuits

While mechanistic accounts helpfully explain that complementary models are pursuitworthy when each provides distinct explanatory constraints, these accounts have little to say about why scientists also pursue multiple competing models.<sup>6</sup> In cases of competition, two

---

<sup>6</sup> Hochstein (2016, p. 1402) acknowledges that researchers sometimes need to choose from “different conflicting models from different research traditions” when building a mechanistic explanation. In the concrete case he discusses, each model provides a separate constraint (e.g. behavioral and structural constraints) to which the explanation needs to conform. Hochstein does not, however, discuss how researchers decide between models which provide conflicting formulations of the *same* constraint (e.g. different models of circuit structure in V1 see below).

models provide mutually incompatible information about the same aspect of the phenomenon in question (see section 3.2). Scientists thus need to choose which model to include in the overall mechanistic explanation. According to mechanistic discovery accounts, scientists should choose the model which captures part of the causal structure of the phenomenon more accurately and completely (Craver, 2007, p. 27, pp. 117–121; Craver and Kaplan, 2020, p. 299) or which makes the particular aspect of the phenomenon more intelligible than the competitor model (Bechtel and Richardson, 2010, p. 28, pp. 234–239). However, this story overlooks typical situations known from the pursuit literature in which scientists pursue a model even though it is inferior to its competitor with regard to epistemic values or explanatory norms such as accuracy or intelligibility. We now describe such a situation by analyzing the pursuit of the canonical microcircuit as a competitor model in response to evidence conflicting with the previous models.

Hubel and Wiesel's extracellular recordings revealed that receptive fields in V1 consist of antagonistic subfields: in the 'on' field an optimal stimulus increases action potential discharges, while optimal stimuli in the 'off' field or non-optimal stimuli decrease discharge (Hubel and Wiesel 1962, p. 109). In simple cells, this decrease can be either explained by diminished excitatory input from the thalamus, or by inhibitory synaptic activity in the 'off' subfield (Fig. 1b, top, cf. Hubel and Wiesel 1962, p. 142). In complex cells, the decrease in the 'off' field can be explained by the mechanism of side-inhibition, in which excitatory input from another orientation column drives cortical inhibitory neurons (Fig. 2 top left). Thus, both the ice-cube model and the V1 wiring diagram discussed in section 2.1 include inhibitory activity in their explanation of orientation-selectivity. However, they both leave the details of the inhibitory mechanisms in the cortex unspecified.

In order to explore these unknown details of intracortical inhibition, Oxford-based neuroscientists Rodney Douglas, Kevan Martin and Daniel Whitteridge combined intra- and extracellular recordings with horseradish peroxidase staining to link the V1 responses to visual stimuli with synaptic connectivity structure (Martin 1988, Douglas et al., 1991). The details discovered by the group were incompatible with the explanations of V1 orientation selectivity: The convergence of excitatory thalamic inputs (Fig. 1b top) is incompatible with the fact that

most inhibitory synaptic potentials occur during optimal stimulation of the ‘on field’ (Douglas et al. 1991, p. 660). The problem with explaining orientation-selectivity via synaptic inhibition of the ‘off field’ in simple cells and side-inhibition in complex cells is that inhibitory and excitatory neurons are not wired specifically enough to produce the required effect (Martin, 1988, p. 689; 691). The fact that neither the ice-cube model nor the wiring diagram, nor any of the other proposed models of orientation-selectivity at the time could account for all the novel findings about V1 organization led Martin (1988) to conclude:

For those of us working on the functional microcircuitry of the visual cortex, the past decade has been undeniably productive. Naturally, over this period our concepts of cortical organization have altered radically [...] Where the coupling between one cell and the next was thought to be strong, now we know it to be weak [...] Where vertical columns were thought to be the quintessential feature of cortical architecture, horizontal now dominates the landscape [...] the list of significant findings and new concepts could occupy several more pages. These concepts and findings must form the *basis of new theories and models of cortical function* (Martin 1988, p. 694–695, emphasis added).

This quote demonstrates that while the Oxford group set out to discover unknown details about V1 microcircuitry (Douglas et al. 1991), their findings and the concepts they developed deviated so radically from existing models of visual processing that they decided to pursue an entirely new model: the *canonical microcircuit* (CMC).<sup>7</sup> Douglas and Martin (1991a) built this model by electrically stimulating thalamic fibers and recording intracellular responses in V1 from layer-specific neuron types. Based on these recordings, their circuit model (Fig. 4) characterizes the interaction between excitatory and inhibitory activity and can be used to simulate the intracellular response patterns in V1.

---

<sup>7</sup> Note that this decision is not a reconstitution of phenomena at a lower level (Bechtel and Richardson 2010, ch. 8) because (i) Douglas and Martin (1991b) view the CMC model as integrating evidence from multiple levels, and (ii) they agree with previous models that stimulus-selectivity at the level of cortical areas is what V1 models of visual processing need to explain. The fact that Douglas and Martin’s choice to build the CMC model is not easily captured in Bechtel and Richardson’s taxonomy of choice points corroborates the claim defended in this section, i.e., that mechanistic discovery accounts have paid insufficient attention to the pursuit of competing models of phenomena.

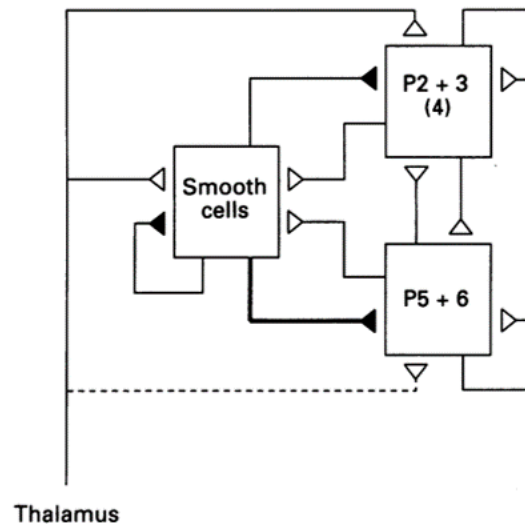

**Fig. 4** The canonical microcircuit model of V1 (adopted from Douglas and Martin (1991a), Fig. 6). Black filled triangles represent inhibitory synapses, black open triangles represent excitatory synapses; thickness of lines represents connection strength, dotted lines indicate weak connections.

The CMC consists of two populations of excitatory pyramidal cells (one in superficial layers 2, 3 and 4, one in deep layers 5 and 6) and one inhibitory population (smooth cells). They all receive thalamic input and are recurrently connected to each other, with the inhibitory activity on deep pyramidal cells being relatively greater than on superficial pyramidal cells. These relative differences in inhibitory strength in the model account for temporal differences in hyperpolarization between deep and superficial layers observed experimentally.

While the ice-cube model still served as a starting point for physiological and computational studies of visual processing, researchers increasingly recognized its empirical shortcomings and pursued competing models of V1 organization (Dow and Baxter 1989, Bartfeld and Grinvald 1992). Here, we focus on three ways in which CMC model competes with the ice-cube model. First, in the ice-cube model thalamic input is strong and primarily targeting neurons in layer 4 (Fig. 1a); in the CMC model this input is weak and also targets neurons in the other layers. Second, the CMC model competes with Hubel and Wiesel's explanation of orientation-selectivity in terms of feedforward excitatory activity (Fig. 1b). This wiring pattern is incompatible with the ubiquitous presence of inhibitory connections and with temporal aspects of V1 response



patterns observed in intracellular recordings (Douglas and Martin 1991b, p. 287). Third, the ice-cube model assumes anatomical modularity, i.e., that the units doing the visual processing are columns with discrete anatomical boundaries. The CMC only assumes functional modularity but rejects anatomical modularity (da Costa and Martin, 2010, p. 8). Since Douglas and Martin reject central tenets of the ice-cube model based on newly discovered lower-level details, their CMC model does not merely serve to fill in details that previously remained unspecified. Rather, it replaces strong selective thalamic input, serial feedforward hierarchy and anatomical modularity with distributed weak input, massive intracortical excitatory-inhibitory feedback and functional modularity, respectively, as explanatory factors. Hence, the CMC model significantly competes with the ice-cube model: it aims to explain the same aspect of cortical visual processing—how V1 produces stimulus-selective outputs from nonselective thalamic inputs (Douglas and Martin, 1991a, p. 735)—while rejecting foundational assumptions of the ice-cube model.

Now that we have introduced CMC model, let's return to the mechanistic ideal that amongst competing models researchers should choose the one that captures the causal structure relevant for the phenomenon most accurately and completely. On the surface, the CMC model seems to satisfy this ideal because it described inhibition more *accurately* and modeled the circuit architecture within V1 more *completely*, relative to the researchers' goal of explaining stimulus-selectivity in V1 (Martin 1988, p. 650). However, unlike the ice-cube model, the CMC model does not specify the anatomical organization of V1 into columns or blobs. In contrast to Gilbert and Wiesel's wiring diagram, the CMC model only distinguishes three and not five layer-specific cell types and their connections. Thus, despite including more information about inhibition mechanisms, the CMC model actually appears less accurate and complete than the previous models since they abstract away from known anatomical details included in previous models of visual processing in V1.

In other words, increased accuracy and completeness cannot be the sole reason for the CMC model to be pursued. Instead, we propose, it has been pursued because it served as a resource to systematically explain various kinds of stimulus-selective processing in V1 while avoiding problems of previous models. Take for instance the explanation of direction-selectivity.

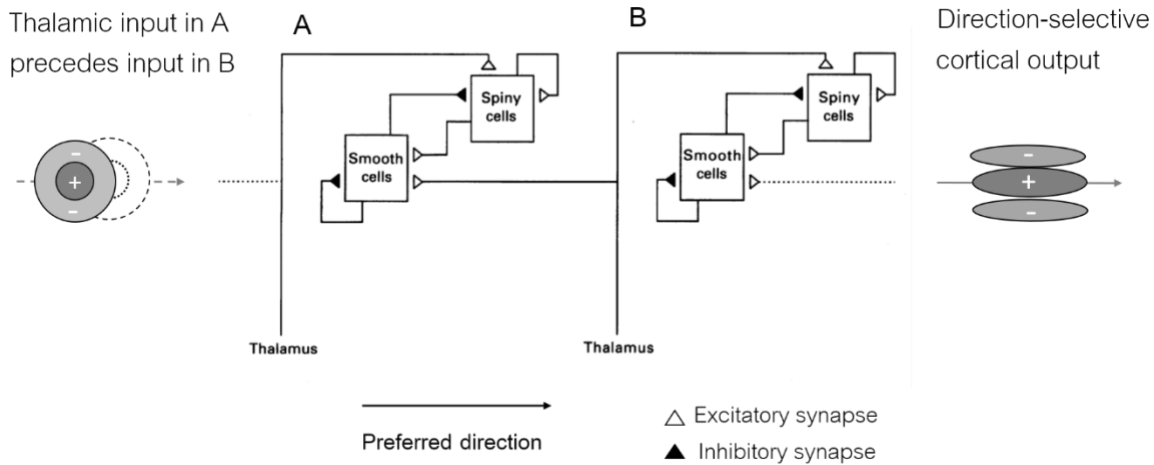

**Fig. 5:** Explanation of direction-selective responses in V1 (based on Douglas and Martin, 1991a, Fig. 12).

In Fig. 5, direction-selective responses are explained by the temporal difference in non-selective input from the visual thalamus (circles, left) to two simplified CMCs (A and B). When a stimulus occurs in the preferred direction (dashed arrow left), thalamic activity arrives first in module A, which then excites itself and circuit B. The result is that the temporal order of activation tracks the spatial direction of motion—the output of both circuits is *direction-selective* (elongated receptive field, right). When a stimulus occurs in the non-preferred direction, thalamic activity first activates inhibitory neurons in module A. This early inhibition prevents recurrent excitation of A and B. This explanation adds details about behaviorally relevant information processing to the CMC model. It avoids a problem of previous models, viz., that no strong inhibitory activity is found when the circuits process motion in the non-preferred direction. It instead explains that in non-preferred directions, inhibitory activity occurs *earlier* than in the preferred case.

In light of this example, we propose that the CMC model's ability to provide better explanations of aspects of cortical visual processing demonstrates its *programmatic character*:

A [model] has programmatic character if it is embedded in a theoretical and methodological framework which allows for the further research of the [model] to proceed in spite of the encountered problems, and towards their systematic resolution (Šešelja and Straßer, 2014, p. 3131).

The CMC model has programmatic character in part because it resolves known issues with earlier models of visual processing such as inaccurately characterizing intra-cortical inhibition. The model is embedded in a theoretical framework that provides researchers with a recipe to generate explanations. To explain a particular phenomenon, researchers need to add explanatorily relevant details to this descriptive model (Haueis, 2021b). To explain direction-selectivity, for instance, they need to add temporally displaced thalamic input to two CMC units. The crucial point here is that the CMC model provides a *systematic* strategy that can be extended to further phenomena:

With little modification, and using the same principles of operation we can, in principle, account for other selectivities in cortical neurones, including orientation, end-inhibition and binocular disparity tuning (Douglas and Martin, 1991a, p. 761).

The fact that this list includes some of the *same* phenomena targeted by models from section 2.1 underlines that the CMC competes with these models. It also illustrates why a model can have programmatic character “even if it does not exhibit a high *actual* explanatory power” (Šešelja and Straßer, 2014, p. 3131).<sup>8</sup> Douglas and Martin (1991a) do not actually show how the CMC can be used to explain orientation-selectivity or end-inhibition. Yet, their explanation of direction-selectivity demonstrates that the CMC provides the principal resources for scientists to do so in future.

We propose that the programmatic character of the CMC model explains why Douglas and Martin pursued the CMC model although it was less detailed and initially explained fewer aspects of visual processing than the ice-cube model it competed against. To pursue the CMC model was rational for circuit researchers because it systematically accounted for new research findings the ice-cube model could not account for (such as inhibition) and because it provided strategies to resolve outstanding issues. These strategies formed part of a larger methodological framework

---

<sup>8</sup> There is a philosophical debate on what precisely “explanator power” is (e.g., Ylikoski and Kuorikoski, 2014). For current purposes, we shall use it to refer to a model’s potential to explain specific aspects of a phenomenon. Šešelja and Straßer (2014) contrast actual and potential explanatory power. Models that are worthy of pursuit frequently have high *potential* explanatory power even though their *actual* explanatory power is still small. The CMC model is a case in point: it was initially developed to explain direction-selectivity but can in principle also be used to explain all kinds of stimulus-selective responses in V1.

the CMC was embedded in. Part of this framework is a “middle out strategy” which includes microscale details while using a minimal number of circuit components to maintain generality (da Costa and Martin, 2013). Following this strategy enabled researchers to update the initial CMC model to produce models of V1 circuitry with great quantitative accuracy (Binzegger et al., 2004). This updated model in turn contributed to novel explanations. For example: Heinzle et al. (2007) adopted the updated CMC to the frontal eye field by adding area-specific connections and motor outputs to the superior colliculus to explain how activity in the frontal eye field contributes to eye-saccade behavior. Similarly, the CMC model is used even today to explain hierarchical processing across the visual system (as discussed in Haueis 2021b). These developments show that the CMC *remains* pursuitworthy because following the systematic strategies, researchers solved problems only hinted towards by its initial programmatic character (Šešelja and Straßer, 2014, p. 3133).

### **3. Analyzing Scientific Inquiry with the Pattern Account**

Our exposition thus far has shown that throughout the inquiry on visual processing, researchers have encountered various choice points and thus operated with multiple models. As a result, complementary as well as competing models have productively co-existed within *a single research practice* searching for explanations of the same phenomenon, viz. seeking to uncover the mechanism(s) responsible for cortical visual processing.

While mechanist accounts neatly capture why complementary models of visual processing have been pursued to further develop the ice-cube model (section 2.1), recent accounts of scientific pursuit help us grasp why competing models of visual processing have been pursuitworthy (section 2.2). While the pursuit literature usually discusses how competing models are utilized across different research traditions, the case of visual processing research highlights that scientific progress within a single research practice may also involve competing models (proposed by different members of a single research community). Thus, we argue, an adequate

account of scientific inquiry should capture why *both* complementary *and* competing models are being used within a single research practice on the road from discovering a phenomenon to an acceptable explanation of its behavior. To achieve this, we adopt the *pattern account* of mechanistic inquiry developed by Kästner and Haueis (2019).

We will first sketch the pattern account (in section 3.1) before illustrating precisely how it accommodates for the roles of competing and complementary models in scientific inquiry using the case of visual processing research (in section 3.2). Finally, we shall discuss why scientific pursuit is fundamentally linked to mechanistic accounts of scientific inquiry and suggest that, in mechanistic inquiry, a model's programmatic character is what enables researchers to investigate a given phenomenon beyond the parts of the mechanism the model actually describes (section 3.3).

### *3.1 The pattern account and the neuroscience of visual processing*

The pattern account conceives of scientific inquiry as a process of pattern recognition (Kästner and Haueis, 2019). Figure 6 visualizes the structure of a pattern recognition practice. In this case, it consists of two different epistemic activities (cf. Chang, 2014, p. 72) (modeling (left), experimenting (right)) which are based on scientist's skills, their tools, concepts and models (symbolized by the icons in the top circles). As part of their epistemic activities, scientists perform different epistemic operations (e.g., specific experiments; cf. Chang, 2014, p. 72) to track various entities and activities in the mechanism they investigate.<sup>9</sup> A pattern recognition practice is thus individuated by the mechanism researchers search for when trying to explain the phenomenon under investigation (e.g., visual processing).

---

<sup>9</sup> Different epistemic activities may be associated with different epistemic perspectives (Kästner, 2018) or different explanatory styles (Potochnik and de Oliveria, 2020). In each case, different experts or research groups contribute specific insights based on their disciplinary background, tools, skills, training, methods, etc. to an integrated overall explanation of a phenomenon.

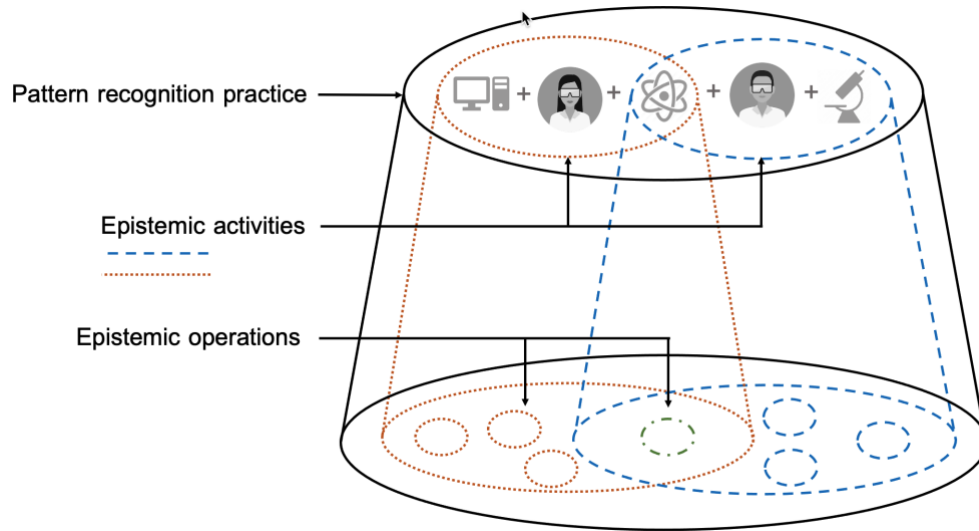

**Fig. 6** The structure of a pattern recognition practice (adopted from Kästner and Haueis 2019, Fig. 2)

Applying this account to visual processing research, we can say that the corresponding pattern recognition practice involves skills such as presenting stimuli and recognizing neural responses to them, tools like electrode recordings and anatomical staining techniques, and concepts like 'cortical column' and models like ice-cube or the CMC model. All of these elements belong to the same practice because neuroscientists used them to investigate the single cortical mechanism that they assumed to be responsible for visual processing (Bechtel, 2008, ch. 3).

The starting point for a pattern recognition practice is usually a rough characterization of the overall pattern through one or more epistemic activities (e.g. computational modeling and lesion studies in visual neuroscience, cf. Bechtel, 2008, pp. 90ff.). In the case of cortical visual processing, researchers began their investigations by discovering that damage to striate cortex (which includes V1) inhibits visual perception. Subsequently, they used electrophysiological experiments to specify which stimuli V1 systematically responds to (section 2.1), and computer modeling to describe how a V1 circuit transforms thalamic input into output to higher visual areas (section 2.2). Each of these epistemic activities crucially involved skills, tools and concepts/models; some of which were shared between, while others were peculiar to specific epistemic activities. Those epistemic activities utilized to investigate the same phenomenon form a coherent set that constitutes a pattern recognition practice.

Over time, researchers within a single pattern recognition practice will employ an increasing number of epistemic activities and operations to track different entities and activities (such as columns, CO blobs, or inhibitory activity), to study specific features of the phenomenon under investigation, and to highlight specific features of the mechanism responsible for it—such as hierarchical processing principles (Hubel and Wiesel, 1962) and canonical circuit wiring (Douglas and Martin, 1991a,b) in the case of visual processing. As they do so, they will develop multiple complementary and/or competing models to explain the target phenomenon and encounter various choice points.

To bring together their various findings, researchers must *integrate* their evidence into a coherent model that can be used to explain a given phenomenon. Generally speaking, integration—even just explanatory integration—has a variety of faces (cf. Brigandt 2013a). For current purposes, we consider integration a process that consists in a specifiable set of activities (O'Malley, 2013) helping researchers to combine insights about a phenomenon to be investigated. While the details of this process and the activities it encompasses will inevitably depend on the specific contexts (cf. O'Rourke, Crowley and Gonnerman, 2016), integration crucially relies on the *coordination* of various practices and among different scientists (cf. Brigandt, 2013a, b). According to the pattern account, this coordination of epistemic activities is constrained by the causal structure of the world (ontic constraints) and by the cognitive systems scientists operate with (epistemic constraints). An ontic constraint is that epistemic operations tracking the same entity or activity (epistemic operation in the middle of Figure 6) cannot produce findings that remain mutually incompatible (cf. Haugeland, 1998, p. 335). If the findings are incompatible, one operation describes the spatiotemporal structure of the entity or activity inaccurately. Similarly, an epistemic constraint is that epistemic operations tracking different entities or activities (epistemic operations left and right in Figure 6) must cohere with relevant background knowledge (Colombo, Hartmann and van Iersel, 2015, pp. 198f). Incoherent results cannot be integrated into a mechanistic explanation which makes the phenomenon intelligible. Both constraints figure centrally in how the pattern account explains the mutual coexistence of complementary and competing models in scientific practice (section 3.2).

Naturally, models of complex biological structures and processes will sometimes involve abstractions and idealizations. This is the case for models of cortical visual processing such as the ice-cube model or Gilbert and Wiesel's wiring diagram, too (cf. section 2, footnote 4). However, this does not prohibit integration. For as long as scientists are keeping track of the idealizations and abstractions used in their models, they can—as part of the coordination process—determine which idealizations and abstractions to adopt and which to reject when piecing together an integrated explanatory model for a given phenomenon. This way, contradictions that might potentially arise due to different abstractions and idealizations can be prohibited.<sup>10</sup>

Eventually, the pattern recognition practice as a whole will carve out the details and boundaries of the mechanism responsible for the phenomenon initially characterized (Figure 7). However, this may take quite some time. Even after a century of visual neuroscience research, for instance, many details of the visual processing mechanism remain unknown (Bechtel, 2008, p. 126).

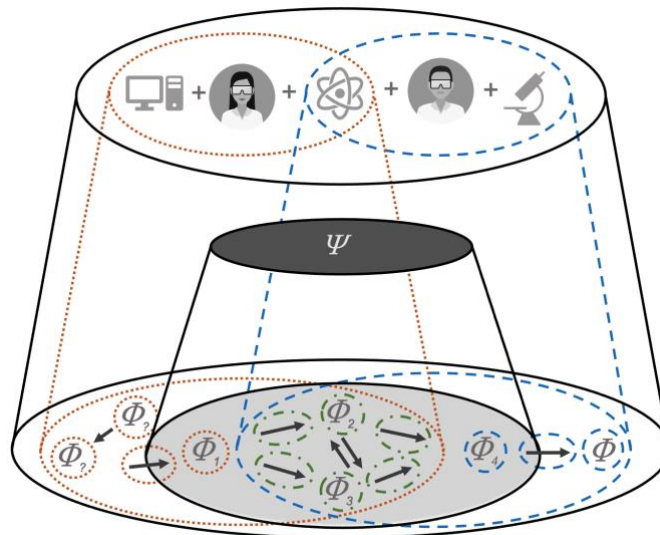

**Fig. 7** Successful discovery: pattern recognition practice as a whole has the full mechanism in view, i.e. each entity ( $\phi_{1-4}$ ) and activity (arrows) responsible for the phenomenon ( $\Psi$ ) is being tracked by at least one epistemic operation (circles).

<sup>10</sup> We thank an anonymous reviewer for highlighting this point.



### 3.2 *Competing and complementary models in pattern recognition practices*

According to the pattern account, a practice progresses in discovering a mechanism by introducing epistemic activities to characterize the overall pattern and more and more epistemic operations to track entities and activities which are part of the overall pattern (section 3.1). We claim that the *multiplicity of epistemic operations* is the common source from which complementary and competing models emerge within a pattern recognition practice. The central difference between them is whether the models in question involve epistemic operations which provide consistent or conflicting information about the entities and/or activities in the mechanism.

Intuitively speaking, two models could be complementary because they provide insights about different entities and/or activities within a mechanism. Or they could be complementary because they reveal different aspects or features of the same entity or activity (think of functional and structural properties of cells, for instance). What is crucial in both cases is that complementary models, if coordinated in the right way, each provide different details about the mechanism that do not contradict one another. Using the pattern account, we characterize complementary models in two ways; let us start with complementary models of *different* entities and activities:

(COMPL<sub>diff</sub>) Two models M1 and M2 of the mechanism responsible for a phenomenon are *complementary* iff

- a. M1 is based on an epistemic operation  $O_1$  which generates results about entity  $e_1$  or activity  $a_1$ , whereas M2 is based on an epistemic operation  $O_2$  which generates results about  $e_2$  or  $a_2$ ,
- b. both  $e_1$  or  $a_1$  and  $e_2$  or  $a_2$  are components in the mechanism in question, and
- c. M1 and M2 provide consistent and non-redundant information about  $e_1$  or  $a_1$  and  $e_2$  or  $a_2$  that is coherent with background knowledge and evidence about the mechanism responsible for the phenomenon to be explained.

Using the same schema, we can capture the complementary models targeting the same entities and activities as follows:

(COMPL<sub>same</sub>) Two models M1 and M2 of the mechanism responsible for a phenomenon are *complementary* iff

- a. M1 and M2 are based on an epistemic operation  $O_1$  and  $O_2$ , respectively, where  $O_1$  and  $O_2$  generate results about different features of the same entity  $e_x$  or activity  $a_x$ .
- b.  $e_x$  or  $a_x$  are components in the mechanism in question, and
- c. M1 and M2 provide consistent and non-redundant information about different features of  $e_x$  or  $a_x$  that is coherent with background knowledge and evidence about the mechanism responsible for the phenomenon to be explained.

While condition a. in both (COMPL<sub>diff</sub>) and (COMPL<sub>same</sub>) reiterate the intuitions formulated above, condition b. rules out (i) that M1 and M2 are actually models of different mechanisms and (ii) that some of the entities or activities are outside the mechanism under investigation. Of course, there can be more than two complementary or competing models within a given pattern recognition practice—but for simplicity we shall limit our discussion here to two models under consideration. Condition c. is analogous to the core message of Hochstein’s (2016) distributed account of mechanistic explanation; it ensures that (i) each model makes a unique contribution to the overall explanation of the phenomenon under scrutiny while (ii) it ensures that the information M1 and M2 provide, respectively, is coherent with background knowledge and existing evidence about the mechanism being investigated. This is an important precondition for integrating multiple models. Identifying whether or to what extent multiple models are compatible with certain background knowledge and existing evidence about a mechanism is achieved through coordination of epistemic activities (section 3.1).

Let us now apply the conditions formulated above to the models from section 2. The case captured by (COMPL<sub>diff</sub>) is exemplified by the ice- cube model (Fig. 1a) and Livingstone and Hubel’s model of visual pathways (Fig. 2). These models are complementary in the sense that they generate non-conflicting information about different entities and activities. The ice-cube

model is based on an epistemic operation  $O_1$  (say, vertical electrode recording) that generates results about columns in V1 (or their activity); the model of visual pathways involves at least one other epistemic operation  $O_2$  (e.g. CO staining) which generates results about entities (CO stripes in V2) or activities (color-selective neural responses) that are not included in the ice-cube model.<sup>11</sup> Using the diagram schema of the pattern account, Fig. 8 illustrates complementary models within a pattern recognition practice as specified in ( $\text{COMPL}_{\text{diff}}$ ).

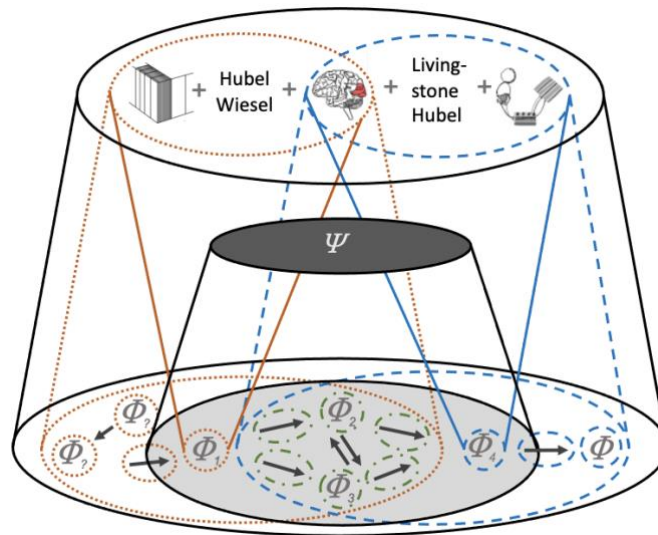

**Fig. 8** The pattern account applied to complementary models of cortical visual processing as captured by ( $\text{COMPL}_{\text{diff}}$ ).

However, this is not the only way that complementary models have featured in visual processing research. The case captured by ( $\text{COMPL}_{\text{same}}$ ) is exemplified by the ice-cube model (Fig. 1a) and Gilbert and Wiesel's wiring diagram (Fig. 3). The ice-cube model is based on an epistemic operation  $O_1$  (extracellular recording) that generates results which suggest that V1 neurons in cortical layer 3 have complex receptive fields and respond to inputs of the same orientation from each eye (Fig. 3 and 5 in Hubel and Wiesel, 1977). The wiring diagram by Wiesel and Gilbert is partly based on a different epistemic operation (horseradish peroxidase) which

---

<sup>11</sup> (C1) delivers the same result for the ice-cube model and the V1 wiring diagram (Fig. 3), which involves epistemic operations (e.g. horseradish peroxidase staining) that generate results about entities not included in the ice-cube model (e.g. dendrites and axons connecting different V1 neurons).

generates novel results about the same entities, e.g. that layer 3 neurons have axonal connections to layer 5 (Fig. 7–10 in Wiesel and Gilbert, 1983). The wiring diagram thus provides information that is both consistent with the ice-cube model (because it shows that layer 3 neurons can send their orientation-selective binocular output to layer 5), and that is non-redundant (because the ice-cube model contains no layer 3 to 5 axonal connections). Fig. 9 illustrates complementary models within a pattern recognition practice as specified in (COMPL<sub>same</sub>).

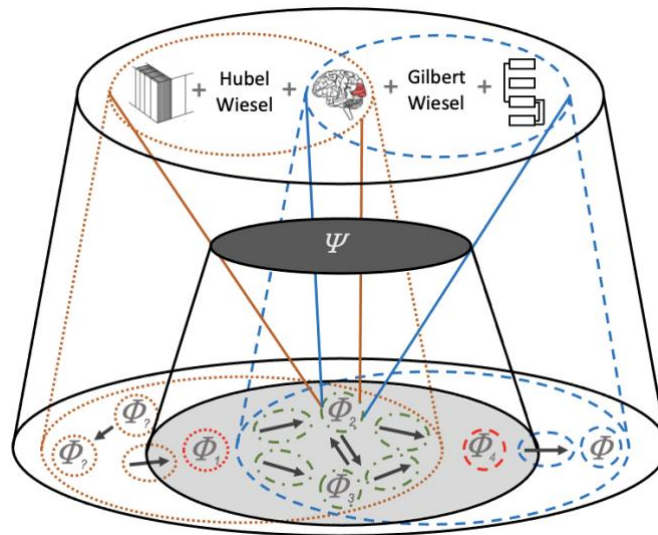

**Fig. 9** The pattern account applied to complementary models of cortical visual processing as captured by (COMPL<sub>same</sub>).

There are several reasons why complementary models of both kinds might arise. For instance, they might result from a division of scientific labor (or apparent fragmentation of scientific practice) where each model “contributes limited, but essential, information to the same mechanistic explanation” (Hochstein, 2016, p. 1388). Whereas Hubel and Wiesel (1977) essentially used the same epistemic activities and operations when working out the ice-cube model, each of them developed novel operations when they started research with their collaborators Livingstone and Gilbert (see Fig. 7, upper left and right scientist icons). These novel operations reflect the decisions Hubel and Wiesel took when encountering a choice point at which multiple different aspects of cortical visual processing (visual pathways, V1 microanatomy)

appeared worthy of pursuit (cf. section 2.1). Mastering a novel epistemic operation requires considerable skill and resources. Therefore, individual researchers or research groups can usually only apply a limited set of all epistemic operations required to target entities and activities within the mechanism the practice investigates. As a result, the practice will naturally fragment into multiple groups whose epistemic operations target different entities and activities. This is familiar from contemporary research in many special sciences where, say, psychologists, neuroscientists and geneticists all study mental illnesses with their specific tools and techniques. When each group represents the results of the operations in different models, the models will complement each other because each only describes some entities and activities in the mechanism, while deliberately excluding others. To gain a full picture, we must consider the whole collection of models, “each of which may be informative of the mechanism in some ways.” (Hochstein, 2016, p. 1403). We must “move between the different models in our collection as the need arises, drawing information from each when appropriate.” (Hochstein, 2016, p. 1402) An important precondition for such fruitful combination of complementary models is that the models in question actually originate from the same pattern recognition practice; viz. that researchers operate with the same general characterization of the phenomenon. In the case of visual processing, this condition is satisfied. Proponents of both the ice-cube and visual pathway models agreed to investigate the phenomenon of visual processing, which they characterized as hierarchical as modular and which they assumed to be localized (in part) in V1 (see icon in upper middle).

Let us now turn to competing models. Unlike complementary models, competing models *always* provide information about the same entities and activities. They are competing, because the details they provide contradict one another even if the models are properly coordinated; i.e., different idealizations and abstractions are not the source of the contradictions in question (section 3.1). Using the pattern account, we characterize competing models as follows:

(COMPETE) Two models M1 and M2 of the mechanism responsible for a phenomenon are *competing* iff

- a. they are based on epistemic operations  $O_1$  and  $O_2$  which each generate different results about the same entity or activity, and
- b. M1 and M2 contain mutually incompatible information about the entities and activities in the mechanism responsible for the phenomenon to be explained.

While condition a. expresses the intuition formulated at the beginning of this section, we must recognize that two models could fulfil this condition but fail to compete if they generate results that are still compatible. If, for instance, two models based on different background assumptions generate convergent results about the same entity or activity, these models should be considered *robust* rather than competing (Weisberg, 2013, pp. 162ff.)—and in fact they would probably satisfy (COMPL<sub>same</sub>). While robust models help integrate evidence from different research communities into a coherent picture, competing models are often found where there is peer disagreement about mechanistic details. To accommodate for this feature, we must include condition b. It ensures that the proposed (competing) models cannot both be fully accurate at the same time.

For an illustration of how competing models have contributed to visual processing research, consider the ice-cube model (Fig. 1a) and Douglas and Martin's CMC model (Fig. 4). Operations of the former (again, say, vertical electrode recording) and the latter (e.g. intracellular recordings) generate results about the same entities and activities, i.e. neurons in V1 and their stimulus-specific responses.

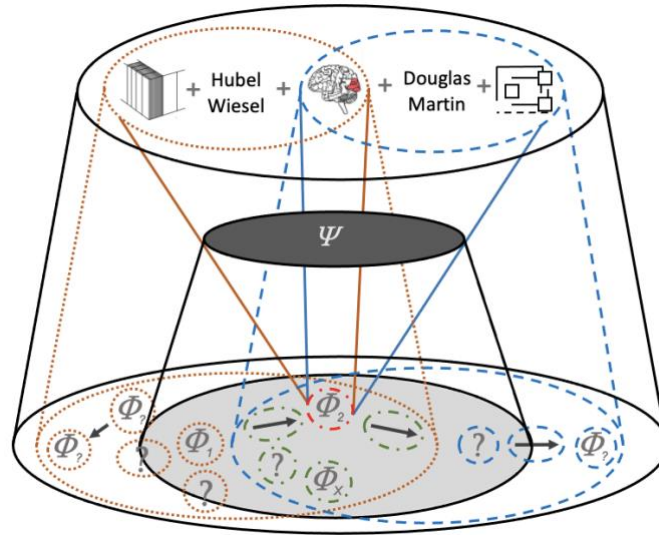

**Fig. 10** The pattern account applied to multiple competing models of cortical visual processing as captured by (COMPETE).

Using the diagram schema of the pattern account, Fig. 10 illustrates the case of competing models within a pattern recognition practice. These typically arise where different epistemic operations are applied to the same entity or activity. This happens, for instance, when scientists engaging in different epistemic activities (e.g., different research groups working with different methods) aim to reduce errors in different ways. For instance, while Hubel and Wiesel’s ice-cube model was based on epistemic operations which could not adequately characterize intra-cortical inhibition, Douglas and Martin’s CMC model used results from novel operations (e.g. intracellular recording, computer simulations) to reduce erroneous modeling of V1 inhibitory activity. According to the pattern account, scientists should select epistemic operations which accurately characterize the characteristics of entities and activities they are supposed to target (cf. Kästner and Haueis, 2019, p. 15). Douglas and Martin’s choice of intra- over extracellular recordings to characterize inhibitory activity reflects this ontic accuracy constraint. Besides choosing ontically accurate operations, researchers need to combine results from multiple such operations into a single representation (e.g. a diagrammatic or mathematical model) which makes (aspects of) the phenomenon intelligible. Which particular model researchers select is dictated by epistemic constraints, such as mathematical tractability and programmatic character: “[model] selection marks a choice point along the trajectory the discovery process takes through search space”

(Kästner and Haueis, 2019, p. 21) along with considerations of a model's potential to solve the research problems at hand (reduce error, incorporate new research findings, etc.). Douglas and Martin's choice to pursue the CMC model exhibited programmatic character since it promised to resolve known issues of the ice-cube model (section 2.2).

### 3.3 *The place of pursuitworthiness in mechanistic inquiry*

A comprehensive account of scientific inquiry needs to take into account that multiple models may be pursued in parallel throughout scientific inquiry. Thus far, we argued that researchers develop competing and/or complementary models when they encounter choice points (sections 2.1, 2.2) and that the pattern account of mechanistic inquiry can accommodate for the presence of competing as well as complementary models within a single pattern recognition practice (section 3.2). Still, one might wonder if our proposal actually combines the mechanistic and pursuit literatures to provide a more comprehensive account of scientific inquiry. After all, (COMPL<sub>same</sub>), (COMPL<sub>diff</sub>) and (COMPETE) still do not explicitly include criteria of pursuitworthiness—such as programmatic character—and thus do not explain *why* researchers pursue complementary and competing models.

The reason for this absence is the following: pursuitworthiness and mechanistic inquiry are connected at a fundamental level. *All* of the models developed within a given pattern recognition practice, complementary as well as competing, have an inherent programmatic character so long as they allow researchers to investigate a given phenomenon beyond the parts of the mechanism the model actually describes.<sup>12</sup> Investigating and modeling entities and activities of a mechanism presupposes not only adequate epistemic activities and operations (tools, skills, and concepts) but also committing to at least a preliminary characterization of the phenomenon which these entities and activities contribute to. Such a *phenomenon characterization* comes with assumptions about the organization of the mechanism *beyond* the parts which the models

---

<sup>12</sup> As can be seen from (COMPL<sub>diff</sub>), (COMPL<sub>same</sub>) and (COMPETE), we take it that two models of the same mechanism within a single pattern recognition practice must be either competing or complementary. If two models do not compete, they will complement one another. Tertium non datur.



actually represent. Because these assumptions are tentative, the preliminary characterization of the phenomenon to be explained prompts open questions and problems not answered by the existing models. Still, researchers can uphold that characterization even in the face of fragmented or conflicting evidence if they have systematic strategies to tackle these problems. It is these strategies, we suggest, which endow a (mechanistic) phenomenon characterization with programmatic character as defined by Šešelja and Strasser (2014). While mechanistic accounts of inquiry such as Bechtel and Richardson (2010), Craver and Darden (2013), and Kästner and Haueis (2019) focus on how researchers use details about the mechanism to revise a phenomenon's characterization throughout the discovery process, these accounts have not discussed strategies and reasons for scientists to uphold the phenomenon characterization despite conflicting evidence. The role of pursuitworthiness in mechanistic inquiry has thus gone unnoticed, although it plays an important role in empirical research practice.<sup>13</sup>

In section 2.2, we already discussed why characterizing cortical visual processing in terms of canonical microcircuits has programmatic character. To see why complementary models also have programmatic character, consider how the ice-cube model characterizes cortical visual processing as hierarchical and modular. This characterization provides systematic strategies to tackle empirical and conceptual problems of the ice-cube model. One problem is that regions between CO blobs respond to color differences, despite them being part of a pathway that is supposed to be color-blind (Fig. 2). To counter this problem, Livingstone and Hubel (1988, pp. 744ff.) argued that interblob regions *explicitly* represent edges, while color only *modifies* their response. This represents a systematic strategy to tackle problems with characterizing visual processing as hierarchical (Burnston, 2015). A similar point holds for Gilbert and Wiesel, who used systematic strategies of the column literature to tackle apparent counterevidence to the claim that columnar modules have sharp anatomical boundaries (cf. Haueis, 2021a, p. 107). The ability to use these strategies to resolve problems, in turn, makes the hierarchical and modular characterization of visual processing pursuitworthy.

---

<sup>13</sup> Colaço (2020) discusses in detail when scientists do not recharacterize a phenomenon despite mechanistic details conflicting with the characterization. His discussion, however, is not linked to pursuitworthiness.

The pattern account of mechanistic inquiry as initially formulated did not take into account pursuitworthiness. Neither did it discuss the role of multiple complementary and/or competing models of a mechanism. Our application to the case of visual processing makes the role of pursuitworthiness and multiple models in scientific inquiry explicit and thus extends the pattern account. According to this extended pattern account, scientific inquiry essentially aims to solve research problems and provide explanations for phenomena. To this end, scientists initially commit to an overall phenomenon characterization specifying the explanandum along with the broad outlines of a responsible mechanism. They employ epistemic activities to track and model parts of that mechanism. Over time, multiple different models of the mechanism will be produced and researchers will employ systematic strategies to deal with this fragmented or conflicting evidence when they encounter choice points. To characterize scientific inquiry, what matters is not so much whether scientists develop competing or complementary models, or which ones win out, but that developing both complementary and competing models has programmatic character.

Thus, the extended pattern account highlights that although the literatures on scientific pursuit and mechanistic inquiry have focused on competing and complementary models, respectively, combining them provides a more comprehensive picture of scientific practice. It highlights that pursuing both competing and complementary models is an integral part of scientific inquiry and that multiple models plays a vital role in constructing scientific explanations and driving scientific progress.

#### **4. Conclusion**

We have two central message to drive home. First, our analysis of visual processing research highlights that it is not only rational for scientists to pursue complementary *as well as* competing explanatory mechanistic models; it is in fact a crucial motor for scientific inquiry. Both the mechanistic and pursuit literatures pay close attention to scientific practice and reject the context distinction (Reichenbach, 1938). Although they only emphasize the role of

complementary and competing models, respectively, both literatures actually make mutually reinforcing claims. We have demonstrated this by examining the case of cortical visual processing research. To explain how cortex transforms visual input from the retina, relayed via the optic nerve and subcortical regions, into output which ultimately leads to conscious perception or overt behavior (e.g., eye movements), visual neuroscientists focused on specific aspects of the visual system throughout different discovery episodes. In an effort to build increasingly sophisticated models of visual processing, they faced a number of choice points. In response, researchers pursued research on various functional as well as structural properties of the visual system leading them to develop both complementary *and* competing models.

Second, we highlight that pursuitworthiness and mechanistic inquiry are actually connected at a fundamental level. We extended the pattern account to locate the pursuit of complementary as well as competing models in the same research practice and offered criteria for distinguishing between them. The extended pattern account acknowledges that any model of a given phenomenon—be it by providing fragmented or contradictory evidence—contributes to its explanation so long as the phenomenon characterization is upheld. Thus, the pattern account explicates the intricate link between mechanistic inquiry and pursuit while also refining our understanding of programmatic character: in mechanistic inquiry, a model's programmatic character enables researchers to investigate a phenomenon beyond what the model already describes.

## Acknowledgements

For discussions and comments on this work we'd like to thank Dunja Šešelja, the participants of the Master's course "Discovery, Pursuit & Justification in Science", as well as two anonymous reviewers. For their help with finalizing the manuscript we are indebted to Barnaby Crook and Maximilian Klein.

## References

- Baxter, W. T., and Dow, B. M. (1989) Horizontal organization of orientation-sensitive cells in primate visual cortex. *Biol. Cybernetics* 61(3), 171–82.
- Bartfeld, E., and Grinvald, A. (1992). Relationships between orientation-preference pinwheels, cytochrome oxidase blobs, and ocular-dominance columns in primate striate cortex. *Proceedings of the National Academy of the Sciences* 89, pp. 11905–11509.
- Bechtel W. and Richardson, R. (2010). *Discovering complexity. Decomposition and Localization as Strategies in Scientific Research*. Cambridge, MA: MIT Press.
- Bechtel, W. (2008). *Mental mechanisms. Philosophical Perspectives on Cognitive Neuroscience*. London: Routledge.
- Binzegger T., Douglas R. J. and Martin K. A. C. (2004). A Quantitative Map of the Circuit of Cat Primary Visual Cortex. *J. Neurosci.* 24(39), 8441–53.
- Brigandt, I. (2013a). Integration in biology: Philosophical perspectives on the dynamics of interdisciplinarity. *Studies in History and Philosophy of Biological and Biomedical Sciences* 44(4), 461–465. <https://doi.org/10.1016/j.shpsc.2013.09.009>
- Brigandt, I. (2013b). Explanation in Biology: Reduction, Pluralism, and Explanatory Aims. *Science and Education* 22(1), 69–91.
- Burnston, D. C. (2016). A contextualist approach to functional localization in the brain. *Biology and Philosophy* 31(4), 527–50. <https://doi.org/10.1007/s10539-016-9526-2>
- Chang, H. (2014). Epistemic Activities and Systems of Practice: Units of Analysis in Philosophy of Science after the Practice Turn. In L. Soler, S. Zwart, M. Lynch and V. Israel-Jost (eds.), *Science after the Practice Turn in the Philosophy, History, and Social Studies of Science* (pp. 67–79). London: Routledge.

- Colaço, D. (2020). Recharacterizing scientific phenomena. *European Journal for Philosophy of Science* 10(14).
- Colombo, M., Hartmann, S. and van Iersel, R. (2015). Models, Mechanisms, and Coherence. *The British Journal for Philosophy of Science* 66(1), 181–212.
- Craver, C. (2007). *Explaining the Brain. Mechanisms and the Mosaic Unity of Neuroscience*. Oxford: Oxford University Press.
- Craver, C. and Darden, L. (2013). *In Search of Mechanisms: Discoveries across the Life Sciences*. Chicago: University of Chicago Press.
- Craver, C. and Kaplan, D. (2020). Are More Details Better? On the Norms of Completeness for Mechanistic Explanations. *British Journal for the Philosophy of Science* 71(1), 287–319.
- da Costa, N. M. and Martin, K. A. C. (2010). Whose cortical column would that be? *Frontiers in Neuroanatomy* 4(16). <https://doi.org/10.3389/fnana.2010.00016>
- da Costa, N. M. and Martin, K. A. C. (2013). Sparse reconstruction of brain circuits: Or, how to survive without a microscopic connectome. *Neuroimage* 80, 27–36. <https://doi.org/10.1016/j.neuroimage.2013.04.054>
- Douglas, R. J. and Martin, K. A. C. (1991a). A functional microcircuit for cat visual cortex. *J. Physiol.* 440, 735–69.
- Douglas, R. J. and Martin, K. A. C. (1991b). Opening the grey box. *Trends Neurosci.* 14(7), 286–93.
- Douglas, R. J., Martin, K. A. C. and Whitteridge, D. (1991). An intracellular analysis of the visual responses of neurones in cat visual cortex. *Journal of Physiology* 440, 659–96.
- Elgin, C. Z. (2017). *True Enough*. Cambridge, MA: MIT Press.
- Giere R. N. (2006). *Scientific perspectivism*. Chicago: University of Chicago Press.
- Haugeland, J. (1998). Pattern & Being. In. idem. (ed.), *Having Thought. Essays in the Metaphysics of Mind* (pp. 267–90). Cambridge, MA: Harvard University Press.
- Haueis, P. and Slaby J. (2017). Connectomes as constitutively epistemic objects. Critical perspectives on modelling in current neuroanatomy. In. T. Mahfoud, S. McLean and N. Rose (eds.), *Progress in Brain Research Volume 233: The Making and Use of Animal Models in Neuroscience and Psychiatry* (pp. 149–77). Amsterdam: Academic Press.

- Haueis, P. (2021a). The death of the cortical column? Patchwork structure and conceptual re-  
irement in neuroscientific practice. *Studies in history and philosophy of science* 85,  
101–13. [10.1016/j.shpsa.2020.09.010](https://doi.org/10.1016/j.shpsa.2020.09.010)
- Haueis, P. (2021b). Multiscale Modeling of Cortical Gradients: The Role of Mesoscale Circuits  
for Linking Macro- and Microscale Gradients of Cortical Organization and Hierarchical  
Information Processing. *NeuroImage* 232. [10.1016/j.neuroimage.2021.117846](https://doi.org/10.1016/j.neuroimage.2021.117846)
- Heinzle, J., Hepp, K. and Martin, K. A. C. (2007). A Microcircuit Model of the Frontal Eye Fields.  
*J. Neurosci.* 27(35), 9341–53.
- Hochstein, E. (2016). One mechanism, many models: a distributed theory of mechanistic ex-  
planation. *Synthese* 193(5), 1387–1407. <https://doi.org/10.1007/s11229-015-0844-8>
- Hubel, D. H. and Livingstone, M. S. (1983). The 11th J. A. F. Stevenson Memorial Lecture: Blobs  
and color vision. *Canadian Journal of Physiology and Pharmacology* 61(12), 1433–41.  
<https://doi.org/10.1139/y83-205>
- Hubel, D. H. and Wiesel, T. N. (1962). Receptive fields, binocular interaction and functional  
architecture in the cat's visual cortex. *Journal of Physiology*, 160(1), 106–54.
- Hubel, D. H. and Wiesel T. N. (1972). Laminar and columnar distribution of geniculo-cortical fibers  
in the macaque monkey. *The Journal of Comparative Neurology* 146(4), 421–50.  
<https://doi.org/10.1002/cne.901460402>
- Hubel, D. H. and Wiesel, T. N. (1977). Ferrier lecture. Functional architecture of macaque  
monkey visual cortex. *Philosophical Transactions of the Royal Society of London B* 198  
(1130), 1–59. <https://doi.org/10.1098/rspb.1977.0085>
- [Hubel, D. H. and Wiesel, T. N. \(1987\). Segregation of form, color and stereopsis in primate area  
18. \*Journal of Neuroscience\* 7\(11\), 3378–415. <https://doi.org/10.1523/JNEUROSCI.07-11-03378.1987>](https://doi.org/10.1523/JNEUROSCI.07-11-03378.1987)
- Kästner, L. (2018). Integrating mechanistic explanations through epistemic perspectives. *Stud-*  
*ies in history and philosophy of science* 68, 68–79.
- Kästner, L. and Haueis, P. (2019). Discovering Patterns: On the Norms of Mechanistic Inquiry.  
*Erkenntnis* 174. <https://doi.org/10.1007/s10670-019-00174-7>

Penultimate draft published in *Studies in History and Philosophy of Science* 93, 123-135. doi: 10.1016/j.shpsa.2022.03.007 Please cite postprint version.

- Kitcher, P. (1993). *The Advancement of Science: Science Without Legend, Objectivity Without Illusions*. Oxford: Oxford University Press.
- Kuhn, T. S. (1962). *The Structure of Scientific Revolutions*. Chicago: University of Chicago Press.
- Laudan, L. (1977). *Progress and its Problems: Toward a Theory of Scientific Growth*. Berkeley and Los Angeles: The University of California Press.
- Lehtinen, A. (2018). Derivational Robustness and Indirect Confirmation. *Erkenntnis* 83(3), 539–76.
- Livingstone, M. S. and Hubel, D. H. (1984). Anatomy and physiology of a color system in the primate visual cortex. *Journal of Neuroscience*, 4(1), 309–356.
- Livingstone, M. S. and Hubel, D. H. (1987). Psychophysical evidence for separate channels for the perception of form, color, movement, and depth. *Journal of Neuroscience* 7(11), 3416–3468. <https://doi.org/10.1523/JNEUROSCI.07-11-03416.1987>
- Livingstone, M. S. and Hubel, D. H. (1988). Segregation of form, color, movement, and depth: anatomy, physiology, and perception. *Science* 240(4853), 740–9. <https://doi.org/10.1126/science.3283936>
- Lichtenstein E. I. (2021). (Mis)Understanding scientific disagreement: Success versus pursuit-worthiness in theory choice. *Studies in history and philosophy of science* 85, 166–75. <https://doi.org/10.1016/j.shpsa.2020.10.005>
- Martin, K. A. C. (1988). The Wellcome Prize Lecture. *From single cells to simple circuits in the cerebral cortex*. *Quarterly Journal of Experimental Physiology* 73(5), 637–702. <https://doi.org/10.1113/expphysiol.1988.sp003190>
- Mitchell, S. (2003). *Biological Complexity and Integrative Pluralism*. Cambridge: Cambridge University Press.
- O'Malley, M. A. (2013). When integration fails: Prokaryote phylogeny and the tree of life. *Studies in History and Philosophy of Biological and Biomedical Sciences* 44(4), 551–62.
- O'Rourke, M., Crowley, S. and Gonnerman C. (2016). On the nature of cross-disciplinary integration: A philosophical framework. *Studies in History and Philosophy of Biological and Biomedical Sciences* 56, 62–70.

Penultimate draft published in *Studies in History and Philosophy of Science* 93, 123-135. doi: 10.1016/j.shpsa.2022.03.007 Please cite postprint version.

- Plutynski, A. (2013). Cancer and the goals of integration. *Studies in History and Philosophy of Biological and Biomedical Sciences* 44(4), 466–76.
- Potochnik, A. (2010). Levels of Explanation Reconceived. *Philosophy of Science* 77(1), 59–72.
- Potochnik, A. and de Oliveira, G. S. (2020). Patterns in Cognitive Phenomena and Pluralism of Explanatory Styles. *Topics in Cognitive Science* 12(4), 1306–20.
- Šešelja, D. and Weber, E. (2012). Rationality and irrationality in the history of continental drift: Was the hypothesis of continental drift worthy of pursuit? *Studies in history and philosophy of science* 43(1), 612–34.
- Šešelja, D. and Straßer, C. (2014). Epistemic justification in the context of pursuit: a coherentist approach. *Synthese* 191, 3111–41. <https://doi.org/10.1007/s11229-014-0476-4>
- Ungerleider, L. G., Galkin, T. W. and Mishkin, M. (1983). Visuotopic organization of projections from striate cortex to inferior and lateral pulvinar in rhesus monkey. *The Journal of Comparative Neurology*, 217(2), 137–157. <https://doi.org/10.1002/cne.902170203>
- Wayne, A. (2018). Explanatory integration. *European Journal for Philosophy of Science* 8, 347–65.
- Weisberg, M. (2013). *Simulation and similarity: using models to understand the world*. Oxford: Oxford University Press.
- Wiesel, T. N. and Gilbert, C. D. (1983). The Sharpey-Schafer lecture. Morphological basis of visual cortical function. *Quarterly Journal of Experimental Physiology* 68(4), 525–43. <https://doi.org/10.1113/expphysiol.1983.sp002747>
- Wimsatt, W. C. (2007). *Re-Engineering Philosophy for Limited Beings. Piecewise Approximations to Reality*. Cambridge, MA: Harvard University Press.
- Whitt, L. A. (1992). Indices of the theory promise. *Philosophy of Science* 59(4), 612–34. <https://doi.org/10.1086/289698>
- Ylikoski, P. and Aydinonat N. E. (2014). Understanding with Theoretical Models. *Journal of Economic Methodology* 21(1), 19–36.