

Lithium ferro phosphate battery state of charge estimation using particle filter

By Noor Iswaniza Md Siam

Lithium ferro phosphate battery state of charge estimation using particle filter

Noor Haniza Md Siam¹, Tole Sutikno², Mohd Junaidi Abdul Aziz³

^{1,2}School of Electrical Engineering, Universiti Teknologi Malaysia, Johor, Malaysia

²Department of Electrical Engineering, Universitas Ahmad Dahlan, Yogyakarta, Indonesia

Article Info

Keywords:

Battery management system
Current discharge test
Particle Filter
Pulse discharge test
State of charge

ABSTRACT

Lithium ferro phosphate (LiFePO₄) has a promising battery technology with high charging/discharging behaviours make it suitable for electric vehicles (EVs) application. Battery state of charge (SOC) is a vital indicator in the battery management system (BMS) that monitors the charging and discharging operation of a battery pack. This paper proposes an electric circuit model for LiFePO₄ battery by using particle filter (PF) method to determine the SOC estimation of batteries precisely. The LiFePO₄ battery model is carried out using MATLAB software. Constant discharge test (CDT) is performed to measure the usable capacity of the battery and pulse discharge test (PDT) is used to determine the battery model parameters. Three parallel RC battery models have been chosen for this study to achieve high accuracy. The proposed PF implements recursive bayesian filter by Monte Carlo sampling which is robust for non-linear and/or non-Gaussian distributions. The accuracy of the developed electrical battery model is compared with experimental data for verification purpose. Then, the performance of the model is compared with experimental data and extended Kalman filter (EKF) method for validation purpose. A superior battery SOC estimator with higher accuracy compared to EKF method has been obtained.

This is an open access article under the [CC BY-SA](https://creativecommons.org/licenses/by-sa/4.0/) license.



1. INTRODUCTION

Burning of fossil fuels causes environmental problem such as global warming, acid rain and urban population [1]-[3]. By energy conversion, the resource of energy such as fossil fuel (coal, oil and natural gases) and nuclear can be extended to many years from getting totally exhausted [4], and this challenge can be tackled by the deployment of emission control systems. The transformation of energy technology, for example, electric vehicle (EV) and hybrid electric vehicle (HEV) are one of the efforts for improvement of traffic and healthier environment. Batteries technologies are the best choice and popular renewable energy than kinetic energy in flywheels, high capacity capacitors and high pressure compressed air [5] in term of higher efficiency, safe and recyclable. LiFePO₄ battery is popular in EV applications for storage of energy which can deliver higher capacity over longer time since it is environment-friendly to the users [6], [7]. Therefore, an accurate battery model is crucial to simulate the charging and discharging characteristic and detailed analysis. Furthermore, battery management system (BMS) can estimate all parameters accurately such as state of charge (SOC) and runtime in order to optimize the performance of battery.

SOC is defined as the percentage of the remaining capacity that is present inside of battery [8]. SOC cannot be measured directly in a battery and there are several methods to determine the SOC of battery. Particle filter (PF) is one of the methods that has been used for estimation of SOC with an improved degree of accuracy. PF is an iterative implementation of the Monte Carlo based on statistical signal processing application [9]-[11]. Figure 1 shows the basic idea of PF, as introduced by Gordon [11]-[13], which shows relationship between posterior probability density function (PDF) and the number of samples which is particles [14], [15]. PF method gained popularity in the mid-1990s due to technology development and this method was used for nonlinear state estimation. The researcher's development in PF over recent years with successfully applications such as model of statistics, learning of machine, processing of signal, econometrics, computer graphics, automation, communications, and others [16]-[18].

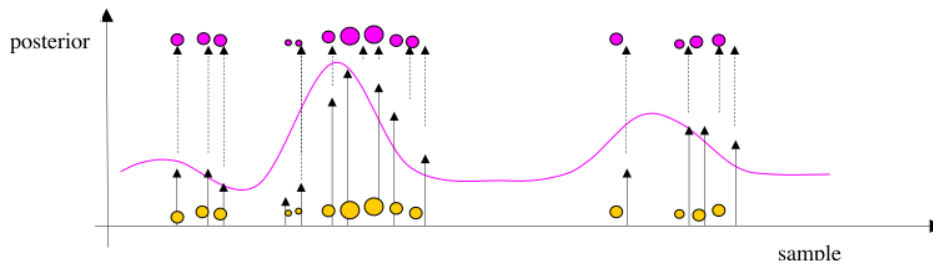

Figure 1. Basic idea of PF

In [19], the paper proposed PF method to estimate the state of vector with three degree of freedom (DOF) industrial robot by the measurement of fusion obtained from sensor. PF is more convenient for highly nonlinear systems and non-Gaussian noise system where EKF method does not work well on these systems. [52] ideas, marker-less tracking is technology broadly used in robot control method. The paper [20] introduced a marker-less human-robot interface using PF and Kalman filter (KF) methods. It was used for dual robot to track the human movement by a sensor. KF and PF are broadly used in robotics and control systems to integrate the robot orientation and position.

A new kinematic calibration method based on the extended Kalman filter (EKF) and PF algorithm presented in [21] to improve the robot position. The priori value is being provided by EKF algorithm and PF algorithm was used to successfully calibrate the parameter of robotic kinematic. In [22], the authors present a method for SOC estimation of LiFePO₄ batteries at dynamic current and temperatures using PF, whereas Thevenin model is proposed in this paper [23] to modelling of NMC cell for different aging levels and operating states. The double particle filter (D-PF) and double adaptive particle filter (D-APF) are developed for online parameters and SOC estimation of lithium-ion batteries to reduce computational cost and improve the accuracy of the SOC estimation [24].

In this paper, PF is applied to the electrical circuit model of LiFePO₄ cell to estimate the lithium cell SOC. The research methodology and procedure to estimate the SOC by the PF method are discussed in detail in Section 2. Then, the method is verified by comparison analysis of simulation results with experimental data of dynamic behaviors of lithium cell in Section 3. In this section, the performance of the model is not only compared with real experimental data but also to the same electrical circuit model using the EKF method for validation purposes. Finally, the conclusion is presented in Section 4.

2. RESEARCH METHOD

The 3.2V of 18Ah LiFePO₄ lithium cell is used for the battery modelling in this research and the detailed specifications of the battery are shown in Table 1 [26]. The work process is shown in Figure 2. Pulse discharge test (15%) and random test are performed to investigate the LiFePO₄ battery dynamic characteristics in this research. The measurement of voltage and current from the test is collected and stored in data acquisition system (DAQ) model NI9219. Next, the PF is developed for battery model and experimental data was obtained from the battery test will to simulate and analyse the PF performance by MATLAB simulation tool.

2.1. Battery test procedure

Figure 3 shows experimental assembly for test procedure. A 120V programmable electronic load device model IT8514C from ITECH with specification of 240 A and 1200 W, is used to act as constant current load in order to discharge the LiFePO₄ battery; and a DC power supply model E3373SI 8200-70R from Elektro-Automatik, capable of delivering 70A load with rating of 200 V and 5000 W, is used to charge the LiFePO₄ battery. The ambient temperature of the battery test was monitored by environment chamber which is JH-KE. The experimental results obtained from the battery test are collect and stored by National Instrument DAQ model NI9219. NI9219 is interfaced with LabVIEW software to gather the data from battery test. The experimental data was saved and stored in excel file to easily simulate and analyses the process using MATLAB software.

Table 1. Specification of LiFePO₄ battery

Characteristics	Rechargeable Lithium Ferro Phosphate (LiFePO ₄) Prismatic Battery
Dimension	18mm x 11mm x 95mm
Nominal voltage (V)	3.2V
Capacity	Min. 18Ah at 9A (0.5C) discharge to 2.0V at 20°C
Charging Method	9A (0.5C) to 3.65V for 2.5hrs at 20°C
Charging Termination Control	Taper Current 0.05C (0.9A) at 3.65V
Operating Temperature (°C)	Charge: 0 °C to 60 °C Discharge: -30 °C to 70 °C Storage: -20 °C to 45 °C
Internal Resistance (mΩ)	< 2 mΩ
Maximum Discharge Current (A)	180A (10C)
Cycle life	> 1000 cycle
Weight (kg)	~0.62kg

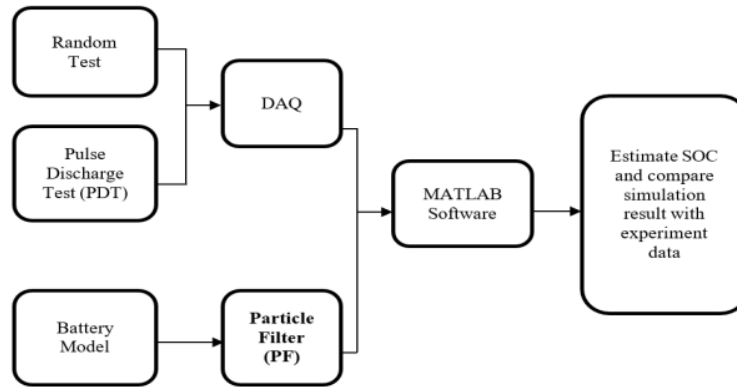

Figure 2. Flow Chart for the estimation SOC using PF

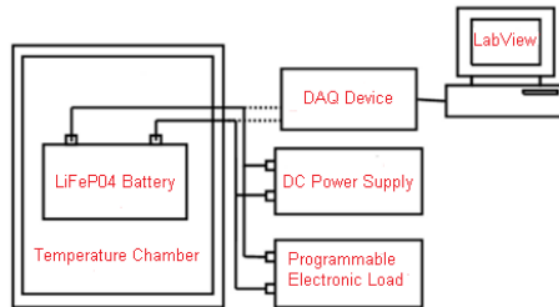

Figure 3. Experiment and battery test procedure

2.2. Experimental result

Two tests were performed on the LiFePO₄ battery to determine the performance of PF, which is PDT and random test. Figure 4 and Figure 5 represent the experimental measurement of current and voltage. PDT is conducted, which consists of a sequence of constant discharge current and rest duration as illustrated in Figure 3. The battery is discharged by 9A load current with a period time of 26980 seconds and six cycles of pulses for PDT. The battery's charge and discharge are shown in Figure 4, which is called a random test. The duration for the random test is 10320 seconds with 12 cycles of charging/discharging pulses.

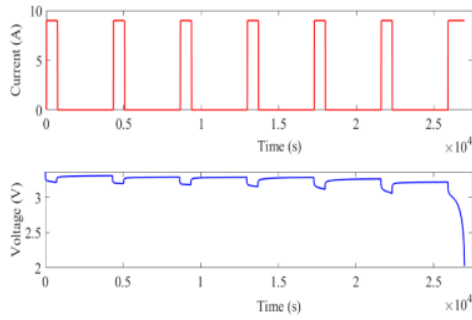

Figure 4. Profile of current and voltage for PDT (9A)

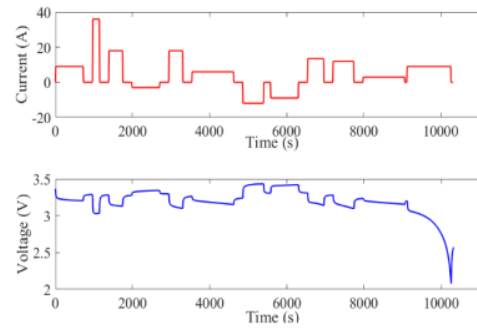

Figure 5. Profile of current and voltage for random test

2.3. Battery modelling

Figure 6 illustrates the model which was chosen in this research, as proposed by authors in [25]-[28]. The parameter of usable capacity (C_{capacity}), open-circuit voltage (OCV), and response of transient (three RC network with series resistance) are important parameters for dynamic characteristics of battery model.

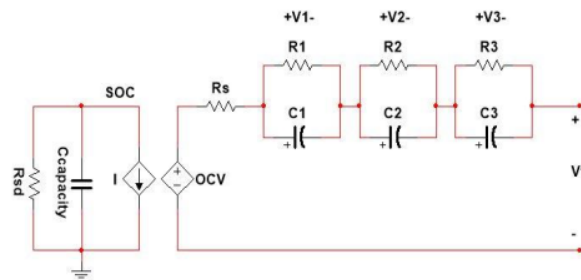

Figure 6. Three RC battery model with dynamic characteristic

The usable capacity is the extracted energy from the battery which presumes a battery is discharged from same charge state til the equal end-of-discharge voltage [26]. The usable capacity is determined from experimental result of constant discharge test (CDT) which is performed to measure the battery's capacity in a specified state. Figure 7 shows the experimental result for 9A CDT test and the equation of usable capacity expressed as (1) where the equation gets from the curve fitting tool by MATLAB software. The usable capacity (CN), can be expressed as:

$$CN = 4.559 \exp^{-0.4932 \times I_L} + 13.44 \exp^{-0.001729 \times I_L} \quad (1)$$

OCV-SOC relationship is crucial for battery modeling since it represents the terminal voltage level in three parallel RC battery model. The battery's OCV-SOC relationship is shown in Figure 8, which is an important parameter in nonlinear relations where the value of OCV is directly dependent on the value of SOC [29], [30]. OCV for a certain SOC can be identified based on PDT when the battery is at rest condition until it reaches a new equilibrium state shown in Figure 8 [31]. A fifth-order polynomial equation can be formulated by using curve fitting tool in MATLAB to present the OCV- SOC relationship as expressed in (3). Thus, the parameters can be determined by transient voltage response for discharge and rest, as illustrated in Figure 9, where the terminal voltage of the battery is derived as (4). Finally, the battery parameters that have been extracted from (4) are tabulated in Table 2.

$$\text{SoC}(t) = \text{SoC}(0) - \frac{1}{\text{CN} \times 3600} \int I_L(t) \quad (2)$$

$$\text{OCV}(\text{SoC}) = (4.513 \times 10^{-10})\text{SoC}^5 - (1.295 \times 10^{-7})\text{SoC}^4 + (1.505 \times 10^{-5})\text{SoC}^3 - 0.0008927\text{SoC}^2 + 0.02764\text{SoC} + 2.918 \quad (3)$$

$$V(t) = \text{OCV} - V_{\text{RC1}}(t) - V_{\text{RC2}}(t) - V_{\text{RC3}}(t) - I_L \times R_s(t) \quad (4)$$

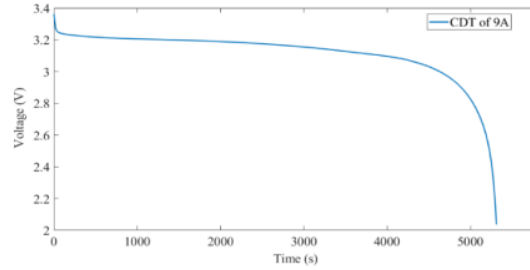

Figure 7. Experimental result for 9A CDT test

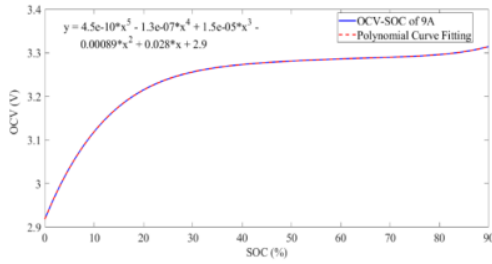

Figure 8. OCV-SOC relationship

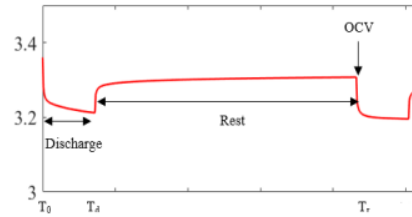

Figure 9. Transient voltage response for PDT

Table 2. Battery model parameters based extracted from CDT and PDT tests

Battery Parameters		
R1=0.0238 Ω	C1=171.6878 Farad	RS=68.896 μΩ
R2=0.0173 Ω	C2=4583.3 Farad	
R3=0.0165 Ω	C2=46879 Farad	

2.4. Particle filter (PF) algorithm

PF algorithm is applied in this research to achieve high accuracy of the OCV estimation. This value is used to determine SOC by utilizing SOC-OCV relationship curve as shown in Figure 7. The relation between SOC and OCV varies based on the type of battery and it is usually given by the manufacturer. The Recursive Bayesian estimation and importance sampling (IS), which is the general methods or technique for estimate properties of a particular distribution are used in PF algorithm as basic framework.

In this research, Monte Carlo is implemented based on IS to remove the particle from the posterior probability density (PDF) and weights of each particle. After that, the particles are filtered and updated according to their pdf weight. The OCV estimation can be computed based on pdf and weight of the updated particles. PF is not restricted by the assumption of linear model and Gaussian noise at the same time compared Kalman filter (KF) algorithm. As a result, PF become a popular method to solve the nonlinear and non-Gaussian state estimation problem [22]. The PF algorithm is explained in detailed in this section [32].

(a) Initialization $k=0$.

Generate initial particles within minimum voltage and maximum voltage with a uniform probability. Suppose the number of particles is N , the variance of measurement noise is v_k and the variance of process noise is w_k . These particles are denoted by X_0^i ($i = 1, 2, \dots, N$) for SOC.

(b) Prediction.

Generate N particle, last sampled particle X_{k-1}^i and get output estimation Y_k^i according to (5) and (6):

$$\begin{cases} x_{k+1} = Ax_k + Bu_k + w_k \\ y_k = Cx_k + Du_k + v_k \end{cases} \quad (5)$$

$$\begin{cases} \begin{bmatrix} \text{SoC}_{k+1} \\ V_{\text{RC1}_{k+1}} \\ V_{\text{RC2}_{k+1}} \\ V_{\text{RC3}_{k+1}} \end{bmatrix} = A_k \times \begin{bmatrix} \text{SoC}_k \\ V_{\text{RC1}_k} \\ V_{\text{RC2}_k} \\ V_{\text{RC3}_k} \end{bmatrix} + B_k \times I_{L_k} + w_k \\ V_{t,k} = \text{OCV} - V_{\text{RC1}_k} - V_{\text{RC2}_k} - V_{\text{RC3}_k} - I_{L_k} \times R_s + v_k \end{cases} \quad (6)$$

Where,

$$\hat{A}_k = \left. \frac{\partial f(\text{SoC}_k, V_{\text{RC1}}, V_{\text{RC2}}, V_{\text{RC3}})}{\partial \text{SoC}_k} \right|_{\text{SoC}_k = \widehat{\text{SoC}}_k} \quad (7)$$

$$\hat{A}_k = \begin{bmatrix} 1 & 0 & 0 & 0 \\ 0 & 1 - \frac{dt}{R_1 C_1} & 0 & 0 \\ 0 & 0 & 1 - \frac{dt}{R_2 C_2} & 0 \\ 0 & 0 & 0 & 1 - \frac{dt}{R_3 C_3} \end{bmatrix} \quad (8)$$

$$B_k = \begin{bmatrix} -\frac{dt}{\text{CN} \times 3600} \\ \frac{dt}{C_1} \\ \frac{dt}{C_2} \\ \frac{dt}{C_3} \end{bmatrix} \quad (9)$$

$$C_k = \left[\left. \frac{\partial g(\text{SoC}_k, V_{\text{RC1}}, V_{\text{RC2}}, V_{\text{RC3}})}{\partial \text{SoC}_k} \right|_{\text{SoC}_k = \widehat{\text{SoC}}_k} \quad -1 \quad -1 \quad -1 \right] \quad (10)$$

$$\frac{\partial(\text{OCV})}{\partial(\text{SoC})} = 5 \times (4.513 \times 10^{-10}) \text{SoC}^4 - 4 \times (1.295 \times 10^{-7}) \text{SoC}^3 + 3 \times (1.505 \times 10^{-5}) \text{SoC}^2 - 2 \times 0.0008927 \text{SoC} + 0.02764 \quad (11)$$

$$D_k = R_s \quad (12)$$

(c) Evaluate importance weight

Calculate the maximum q_i of the particles X_k^i according to the measurement y_k represented as (6):

$$q_i = p(y_k | X_k^i) = \frac{1}{\sqrt{2\pi R}} e^{-\frac{(y_k - y_k^i)^2}{2R}} \quad (13)$$

Normalized the importance weight as follow $q_i = q_i / \sum_{j=1}^N q_j$

(d) Resampling

Generate a set of posterior particles X_k^i based on their weights q_i by multinomial resampling method, $i=1, 2, \dots, N$

(e) Output

The state variables (OCV) after completion of the algorithm are obtained by $X_k = \sum_{i=1}^N q_i X_k^i$. Take X_k^i into OCV-SOC curve to obtain $\text{SOC}_{V,k}$

3. RESULTS AND DISCUSSION

The experimental result and the estimation of SOC from PF algorithm are presented and discussed in this section. The outcome for this research is presented in two different parts: i) PDT, and ii) random test.

The initial SOC (x_0), error covariance measurement update (P), process noise (w_k) and sensor noise (v_k) are assumed in (14) to (17). The initial SOC is set to 90% for PF method for analysis.

$$x_0 = [90 \ 0 \ 0 \ 0]^T \quad (14)$$

$$P = \begin{bmatrix} 19000 & 0 & 0 & 0 \\ 0 & 10 & 0 & 0 \\ 0 & 0 & 10 & 0 \\ 0 & 0 & 0 & 10 \end{bmatrix} \quad (15)$$

$$w_k = \begin{bmatrix} 0.1 & 0 & 0 & 0 \\ 0 & 0.01 & 0 & 0 \\ 0 & 0 & 0.01 & 0 \\ 0 & 0 & 0 & 0.01 \end{bmatrix} \quad (16)$$

$$v_k = [0.01] \quad (17)$$

3.1. Validation of terminal voltage

Figure 10 and Figure 11 show the comparison of the terminal voltage of the of LiFePO₄ battery for 9A PDT test and random test. The red line represents experimental voltage while the blue line represents estimated voltage by PF algorithm. As a result, the terminal voltage for both tests is nearly same between experimental and simulation result. However, noise is observed in simulation result of the PF estimated terminal voltage due to the existence of noise measurement in PF algorithm.

The mean absolute error (MAE), mean square error (MSE) and root mean square error (RMSE) are three types of error for analysis of the performance of the model for terminal voltage of the battery in this research. MAE is the average difference between estimated and measured value in the test or model as expressed in (18). MSE is the average squared difference between estimated and measured value in the test or model as defined as (19). While RMSE is defined as the square root of the MSE in (20).

$$MAE = \frac{1}{N} \sum_{i=1}^N |\text{Measured value} - \text{Estimated value}| \quad (18)$$

$$MSE = \frac{1}{N} \sum_{i=1}^N (\text{Measured value} - \text{Estimated value})^2 \quad (19)$$

$$RMSE = \sqrt{\frac{1}{N} \sum_{i=1}^N (\text{Measured value} - \text{Estimated value})^2} \quad (20)$$

Table 3 shows the error analysis between experimental voltage and PF estimated voltage for both tests. The MAE, MSE and RMSE of terminal voltage in 9A PDT test are 0.0091V, 0.0014V and 0.0373, respectively, which are 0.284%, 0.044% and 1.166% to the nominal voltage of LiFePO₄ battery. Whereas the MAE, MSE and RMSE of voltage in random test are 0.0456V, 0.0184V and 0.1357V respectively which are 1.425%, 0.575% and 4.241% to the nominal voltage of LiFePO₄ battery, respectively. It shows that PF has good performance to determine the terminal voltage during relaxation time even though the noise appear across PF estimated voltage especially during transient; both in PDT and random test. The proposed model by PF proves that PF algorithm can estimate the terminal voltage precisely.

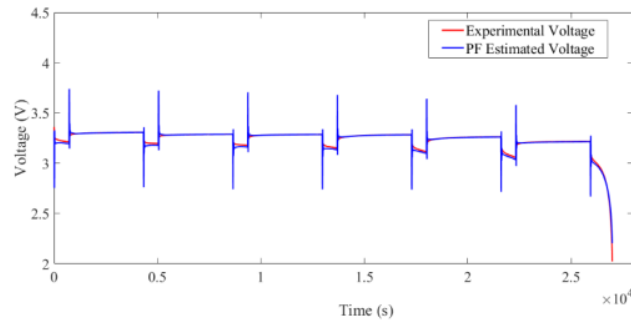

21

Figure 10. Comparison between experimental voltage and PF estimated voltage for PDT test

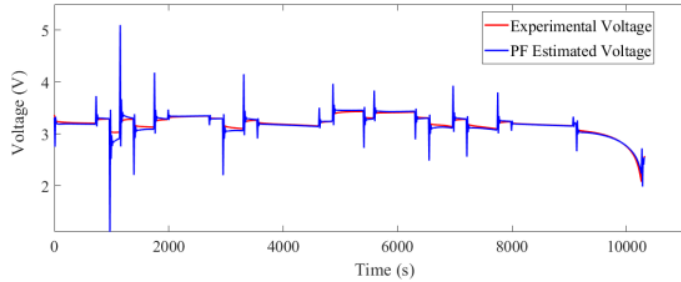

21

Figure 11. Comparison between experimental voltage and PF estimated voltage for random test

Table 3. Error analysis between experimental voltage and PF estimated voltage for PDT and random test.

Test	Mean Absolute Error (MAE)	Mean Square Error (MSE)	Root Mean Square Error (RMSE)
Pulse Discharge test (9A)	0.0091 V	0.0014 V	0.0373 V
Random test	0.0456 V	0.0184 V	0.1357 V

43

3.2. Validation of SOC estimation

23

The Coulomb counting method is used to measure the discharging current of the LiFePO₄ battery and integrates the discharging current over time with the purpose of estimating Real SOC. The Real SOC from Coulomb counting for PDT of 9A and the random test is illustrated in Figure 12 (a) and Figure 13 (a), respectively. While Figure 12 (b) and Figure 13 (b) show the comparison between Real SOC (red line), EKF estimated SOC (yellow line) and PF estimated SOC (blue line). Both methods are able to track and estimate the battery SOC accurately, especially when the SOC is higher than 20%. However, when battery SOC is less than 20%, both estimators are departing from real data. RMSE, absolute error, and relative error are used as a tool to validate and compare the performance of PF and EKF with real SOC. The RMSE and error analysis are denoted as (20) to (24).

$$\text{Average measured value, } V_M = \frac{1}{N} \sum_{i=1}^N \text{Measured value} \quad (21)$$

$$\text{Average estimated value, } V_E = \frac{1}{N} \sum_{i=1}^N \text{Estimated value} \quad (22)$$

$$\text{Absolute error} = |V_E - V_M| \quad (23)$$

$$\text{Relative error} = \frac{|V_E - V_M|}{V_M} \times 100\% \quad (24)$$

17

The absolute error is defined as the difference between the estimated value and the measured value. The relative error is the ratio of absolute error to the measured value. Table 4 tabulates the error analysis of the SOC estimation algorithm for PDT of 9A and random test. For PDT of 9A, the absolute error and percentage error for EKF estimated SOC is 0.0219% and 0.05%, respectively. Whereas the absolute error and percentage error for PF estimated SOC is 0.0184% and 0.04%, respectively. The difference in relative error for the PDT test between PF and EKF is 0.01%. For PDT of 9A, the RMSE for EKF and PF estimated SOC is 4.6153% and 4.9648%, respectively.

For the random test, the absolute error and relative error of SOC estimation by PF are 1.0622% and 2.58%, respectively. In comparison, the absolute error and relative error of SOC estimation by EKF are 1.2099% and 2.94%, respectively. The difference in relative error for the random test between PF and EKF is 0.36%. For the random test, the RMSE for EKF and PF estimated SOC is 2.3830% and 1.0657%, respectively. The Table 4 shows that the PF method has a lower absolute error and relative error in both tests. For RMSE, EKF is more accurate than PF, leaving it with a small marginal error in PDT while PF is superior

to EKF in random tests. Thus, it can be summarised that the performance of PF is comparable to the performance of EKF.

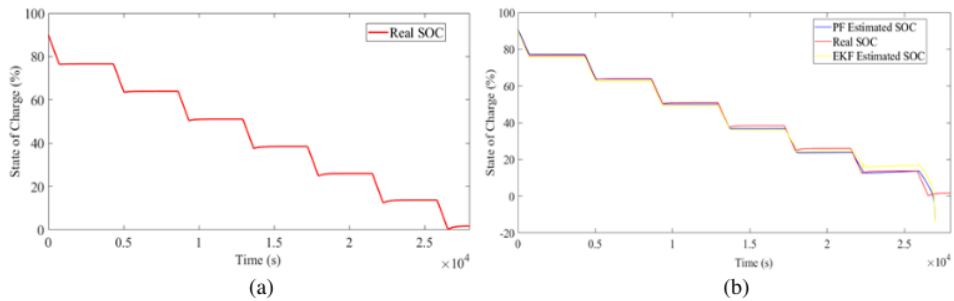

Figure 12. SOC from coulomb counting, (a) real SOC, (b) comparison between real SOC, EKF and PF for PDT of 9A

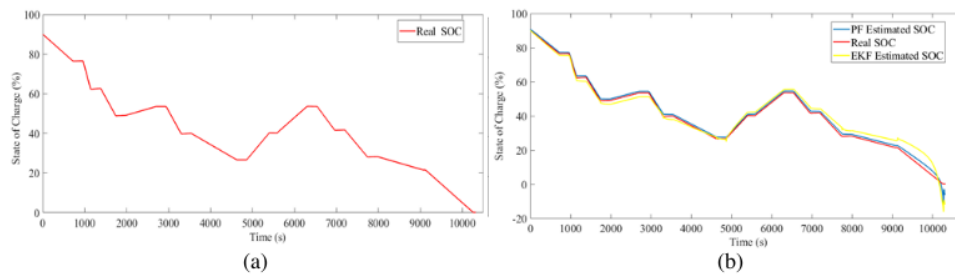

Figure 13. SOC form random test, (a) Real SOC (b) Comparison between real SOC, EKF and PF for random test

Table 32 Error analysis of SOC estimation

Methods		Absolute Error (%)	Relative Error (%)	Root Mean Square Error (%)
Pulse Discharge test (9A)	EKF	0.0219	0.05	4.6153
	PF	0.0184	0.04	4.9648
Random test	EKF	1.2099	2.94	2.3830
	PF	1.0622	2.58	1.0657

4. CONCLUSION

This paper presents battery modeling and development of particle filter (PF) algorithm to estimate the state of charge (SOC) of 18Ah LiFePO₄ battery. At the first stage, constant discharge test (CDT) and pulse discharge test (PDT) are performed to investigate the characteristics of the LiFePO₄ battery. Then, the performance of the PF-SOC estimation method is assessed by comparing it with experimental data of dynamic behaviors of LiFePO₄ lithium cell. Additionally, the performance of PF and extended Kalman filter (EKF)-SOC estimation is compared by error analysis. From the analysis, the PF is more accurate than EKF due to a robust procedure to undertake inference for non-linear or non-Gaussian models as compared to the EKF. From PDT and random test, it can be concluded that the PF method is accurate to determine the terminal voltage of the battery with an average error of less than 5% even though the noise appears across PF estimated voltage. Absolute error and relative error, which represent as error analysis of SOC for PDT test and the random test, show that the performance of PF-SOC estimation is more accurate and more precise than EKF-SOC estimation of battery. However, slow responses of the filter, particularly over relaxation time and the dynamic characteristics in terms of the open-circuit voltage (OCV)-SOC relationship of the LiFePO₄ battery, may restrict the performances of PF as shown in PDT. In general, it can be concluded that the PF performance is on par with EKF and worth applied for battery SOC estimation.

REFERENCES

- [1] B. K. Bose, "Advances in power electronics-its impact on the environment," *IEEE International Symposium on Industrial Electronics. Proceedings. ISIE'98* (Cat. No.98TH8357), 1998, pp. 28-30 vol.1, DOI: 10.1109/ISIE.1998.707743.
- [2] B. K. Bose, "Energy, environment, and advances in power electronics," in *IEEE Transactions on Power Electronics*, vol. 15, no. 4, pp. 688-701, July 2000, DOI: 10.1109/63.849039.
- [3] Ibrahim Dincer, "Renewable energy and sustainable development: a crucial review," *Renewable and sustainable energy reviews*, Vol. 4, no. 2, pp. 157-175, 2000, DOI: 10.1016/S1364-0321(99)00011-8.
- [4] Bimal, K. Bose, "Energy, Environment and Importance of Power Electronics," *Recent Researches in Environmental and Geological Science*, 38-47, 2018.
- [5] J.I. San Martín, I. Zamora, J.J. San Martín, V. Aperribay and P. Eguía, "Energy storage technologies for electric applications," in *International Conference on Renewable Energies and Power Quality (ICREPQ'11)*, Las Palmas de Gran Canaria (Spain), 13-15 April, 2011, pp. 593-598, DOI: 10.24084/repqj09.398.
- [6] J. Wang, Z. Sun and X. Wei, "Performance and characteristic research in LiFePO₄ battery for electric vehicle applications," *2009 IEEE Vehicle Power and Propulsion Conference*, 2009, pp. 1657-1661, DOI: 10.1109/VPPC.2009.5289664
- [7] Long Lam, P. Bauer and E. Kelder, "A practical circuit-based model for Li-ion battery cells in electric vehicle applications," *2011 IEEE 33rd International Telecommunications Energy Conference (INTELEC)*, 2011, pp. 1-9, DOI: 10.1109/INTLEC.2011.6099803.
- [8] Kwo Young, Caisheng Wang, Le Yi Wang and Kai Strunz, "Electric Vehicle Battery Technologies," *Power Electronics and Power Systems book series (PEPS)*, pp. 15-56, 2013, DOI: 10.1007/978-1-4614-0134-6_2.
- [9] M. S. Arulampalam, S. Maskell, N. Gordon and T. Clapp, "A tutorial on particle filters for online nonlinear/non-Gaussian Bayesian tracking," in *IEEE Transactions on Signal Processing*, vol. 50, no. 2, pp. 174-188, Feb. 2002, DOI: 10.1109/78.978374.
- [10] Doucet, A., S. Godsill, and C. Andrieu, "On sequential Monte Carlo sampling methods for Bayesian filtering," *Statistics and computing*, vol. 10, no. 3, pp. 197-208, 2000, DOI: 10.1023/A:1008935410038.
- [11] Gordon, N., B. Ristic, and S. Arulampalam, "Beyond the kalman filter: Particle filters for tracking applications," Artech House, London, 2004. 830: p. 5.
- [12] Gordon, Neil J., David J. Salmond, and Adrian FM Smith. "Novel approach to nonlinear/non-Gaussian Bayesian state estimation," *IEE proceedings F (radar and signal processing)*, vol. 140. no. 2. IET Digital Library, 1993, DOI: 10.1049/ip-f-2.1993.0015.
- [13] Simon, D., "Optimal state estimation: Kalman, H infinity, and nonlinear approaches," 2006: John Wiley & Sons.
- [14] Wenshuo Li, Zidong Wang, Yuan Yuan and Lei Guo, "Particle filtering with applications in networked systems: a survey," *Complex & Intelligent Systems*, vol. 2, no. 4, pp. 293-315, 2016, DOI: 10.1007/s40747-016-0028-2.
- [15] F. Gustafsson, "Particle filter theory and practice with positioning applications," in *IEEE Aerospace and Electronic Systems Magazine*, vol. 25, no. 7, pp. 53-82, July 2010, DOI: 10.1109/MAES.2010.5546308.
- [16] Zhe Sage Chen, "Bayesian filtering: From Kalman filters to particle filters, and beyond," *Statistics: A Journal of Theoretical and Applied Statistics*, vol. 182, no. 1, 2003 DOI:10.1080/02331880309257
- [17] Hsiao, K., J. Miller, and H. de Plinval-Salgues, "Particle filters and their applications," *Cognitive Robotics*, 2005. 4.
- [18] Ristic, B., Particle filters for random set models. Vol. 798. 2013: Springer.
- [19] G. G. Rigatos, "Particle Filtering for State Estimation in Nonlinear Industrial Systems," in *IEEE Transactions on Instrumentation and Measurement*, vol. 58, no. 11, pp. 3885-3900, Nov. 2009, DOI: 10.1109/TIM.2009.2021212.
- [20] G. Du and P. Zhang, "A Markerless Human-Robot Interface Using Particle Filter and Kalman Filter for Dual Robots," in *IEEE Transactions on Industrial Electronics*, vol. 62, no. 4, pp. 2257-2264, April 2015, DOI: 10.1109/TIE.2014.2362095.
- [21] Z. Jiang, W. Zhou, H. Li, Y. Mo, W. Ni and Q. Huang, "A New Kind of Accurate Calibration Method for Robotic Kinematic Parameters Based on the Extended Kalman and Particle Filter Algorithm," in *IEEE Transactions on Industrial Electronics*, vol. 65, no. 4, pp. 3337-3345, April 2018, DOI: 10.1109/TIE.2017.2748058.
- [22] Wang, Y., C. Zhang, and Z. Chen, "A method for state-of-charge estimation of LiFePO₄ batteries at dynamic currents and temperatures using particle filter," *Journal of power sources*, 2015. 279: p. 306-311, DOI: 10.1016/j.jpowsour.2015.01.005.
- [23] Min Yea, Hui Guo, Rui Xiong and Quanqing Yu, "A double-scale and adaptive particle filter-based online parameter and state of charge estimation method for lithium-ion batteries," *Energy*, 2018. 144: p. 789-799, DOI: 10.1016/j.energy.2017.12.061.
- [24] Group, G.P., GP Batteries Data Sheet: GP18EVLf, G.I. Ltd, Editor.
- [25] Shen, Y., "Hybrid unscented particle filter-based state-of-charge determination for lead-acid batteries," *Energy*, Vol. 74. 2014. 795-803, DOI: 10.1016/j.energy.2014.07.051.
- [26] Min Chen and G. A. Rincon-Mora, "Accurate electrical battery model capable of predicting runtime and I-V performance," in *IEEE Transactions on Energy Conversion*, vol. 21, no. 2, pp. 504-511, June 2006, DOI: 10.1109/TEC.2006.874229.
- [27] L. W. Yao, J. A. Aziz, P. Y. Kong and N. R. N. Idris, "Modeling of lithium-ion battery using MATLAB/simulink," *IECON 2013 - 39th Annual Conference of the IEEE Industrial Electronics Society*, 2013, pp. 1729-1734, DOI: 10.1109/IECON.2013.6699393.

- [28] Robyn Jackey, Michael Saginaw, Pravesh Sanghvi, Javier Gazzarri, Tarun Huria and Massimo Ceraolo, "Battery model parameter estimation using a layered technique: an example using a lithium iron phosphate cell," 2013, SAE Technical Paper.
 - [29] H. Dai, X. Wei and Z. Sun, "State and Parameter Estimation of a HEV Li-ion Battery Pack Using Adaptive Kalman Filter with a New SOC-OCV Concept," *2009 International Conference on Measuring Technology and Mechatronics Automation*, 2009, pp. 375-380, DOI: 10.1109/ICMTMA.2009.333.
 - [30] Caiping Zhang, Jiuchun Jiang, Linjing Zhang, Sijia Liu, Leyi Wang and Poh Chiang Loh, "A generalized SOC-OCV model for lithium-ion batteries and the SOC estimation for LNMCO battery," *Energies*, vol. 9, no. 11, pp. 900, 2016, DOI: 10.3390/en9110900.
 - [31] Hanlei Zhang and Mo-Yuen Chow, "Comprehensive dynamic battery modeling for PHEV applications," *IEEE PES General Meeting*, 2010, pp. 1-6, DOI: 10.1109/PES.2010.5590108.
 - [32] M. Gao, Y. Liu and Z. He, "Battery state of charge online estimation based on particle filter," *2011 4th International Congress on Image and Signal Processing*, 2011, pp. 2233-2236, DOI: 10.1109/CISP.2011.6100603.
-

Lithium ferro phosphate battery state of charge estimation using particle filter

ORIGINALITY REPORT

20%

SIMILARITY INDEX

PRIMARY SOURCES

- | | | |
|---|--|---------------|
| 1 | lilionbms.com
Internet | 47 words — 1% |
| 2 | www.mdpi.com
Internet | 35 words — 1% |
| 3 | Yao, Low Wen, J. A. Aziz, Pui Yee Kong, and N. R. N. Idris. "Modeling of lithium-ion battery using MATLAB/simulink", IECON 2013 - 39th Annual Conference of the IEEE Industrial Electronics Society, 2013.
Crossref | 31 words — 1% |
| 4 | ir.nsfc.gov.cn
Internet | 31 words — 1% |
| 5 | www.scilit.net
Internet | 30 words — 1% |
| 6 | Min Ye, Hui Guo, Rui Xiong, Quanqing Yu. "A double-scale and adaptive particle filter-based online parameter and state of charge estimation method for lithium-ion batteries", Energy, 2018
Crossref | 26 words — 1% |
| 7 | Gao, Mingyu, Yuanyuan Liu, and Zhiwei He. "Battery state of charge online estimation based on particle | 24 words — 1% |

filter", 2011 4th International Congress on Image and Signal Processing, 2011.

Crossref

8 Yujie Wang, Rui Pan, Chang Liu, Zonghai Chen, Qiang Ling. "Power capability evaluation for lithium iron phosphate batteries based on multi-parameter constraints estimation", Journal of Power Sources, 2018 20 words — 1%

Crossref

9 Saif Sabah Sami, Zeyad Assi Obaid, Mazin T. Muhssin, Ali N. Hussain. "Detailed modelling and simulation of different DC motor types for research and educational purposes", International Journal of Power Electronics and Drive Systems (IJPEDS), 2021 19 words — 1%

Crossref

10 core.ac.uk 19 words — 1%

Internet

11 eprints.utm.my 19 words — 1%

Internet

12 Xiaolong Yang, Yongji Chen, Bin Li, Dong Luo. "Battery states online estimation based on exponential decay particle swarm optimization and proportional-integral observer with a hybrid battery model", Energy, 2020 18 words — < 1%

Crossref

13 repository.ntu.edu.sg 18 words — < 1%

Internet

14 Dickson N. T. How, M. A. Hannan, M. S. Hossain Lipu, Pin Jern Ker. "State of Charge Estimation for Lithium-Ion Batteries Using Model-Based and Data-Driven Methods: A Review", IEEE Access, 2019 17 words — < 1%

Crossref

15	eprints.soton.ac.uk Internet	17 words — < 1%
16	journal2.uad.ac.id Internet	15 words — < 1%
17	Bin Xu, Yong Wang, Yijing Zhu, Hao Huang. "Research on Calculating Formula of Self-Weight of Column-Supported Space Truss", IOP Conference Series: Earth and Environmental Science, 2020 Crossref	14 words — < 1%
18	Vikas Mishra, Abid Rahman Kodakkadan, Rajesh Koduri, Sivaprasad Nandyala, Mithun Manalikandy. "Wireless Charging for EV/HEV with Prescriptive Analytics, Machine Learning, Cybersecurity and Blockchain Technology: Ongoing and Future Trends", SAE International, 2019 Crossref	14 words — < 1%
19	digitalcommons.library.umaine.edu Internet	13 words — < 1%
20	vbn.aau.dk Internet	13 words — < 1%
21	Engineering Computations, Volume 30, Issue 6 (2013-11-02) Publications	12 words — < 1%
22	M. Chen, G.A. Rincon-Mora. "Accurate Electrical Battery Model Capable of Predicting Runtime and I-V Performance", IEEE Transactions on Energy Conversion, 2006 Crossref	12 words — < 1%

23 Chang, Wen-Yeau. "The State of Charge Estimating Methods for Battery: A Review", ISRN Applied Mathematics, 2013. 11 words — < 1%
Crossref

24 www.iieta.org 11 words — < 1%
Internet

25 Omur Aydogmus, Muhammed Fatih Talu. "Comparison of Extended-Kalman- and Particle-Filter-Based Sensorless Speed Control", IEEE Transactions on Instrumentation and Measurement, 2012 10 words — < 1%
Crossref

26 Zhi Cao, Amin Mahmoudi, Solmaz Kahourzade, Wen L. Soong. "An Overview of Electric Motors for Electric Vehicles", 2021 31st Australasian Universities Power Engineering Conference (AUPEC), 2021 10 words — < 1%
Crossref

27 Zhihong Jiang, Weigang Zhou, Hui Li, Yang Mo, Wencheng Ni, Qiang Huang. "A New Kind of Accurate Calibration Method for Robotic Kinematic Parameters Based on the Extended Kalman and Particle Filter Algorithm", IEEE Transactions on Industrial Electronics, 2018 10 words — < 1%
Crossref

28 spectrum.library.concordia.ca 10 words — < 1%
Internet

29 www.freepatentsonline.com 10 words — < 1%
Internet

30 M.L. Hernandez, T. Kirubarajan, Y. Bar-Shalom. "Multisensor resource deployment using posterior Cramer-Rao bounds", IEEE Transactions on Aerospace and Electronic Systems, 2004 9 words — < 1%

31 Maamar Souaihia, Bachir Belmadani, Rachid Taleb, Kamel Tounsi. "State of charge estimation by using extended Kalman filter based on improved open circuit voltage model", International Journal of Applied Power Engineering (IJAPE), 2021

Crossref

32 Prashant Shrivastava, Tey Kok Soon, Mohd Yamani Idna Bin Idris, Saad Mekhilef. "Overview of model-based online state-of-charge estimation using Kalman filter family for lithium-ion batteries", Renewable and Sustainable Energy Reviews, 2019

Crossref

33 Rui Pan, Yujie Wang, Xu Zhang, Duo Yang, Zonghai Chen. "Power capability prediction for lithium-ion batteries based on multiple constraints analysis", Electrochimica Acta, 2017

Crossref

34 Witt, Anke, Christine Färst, Susanne Frank, Lars Koschke, and Franz Makeschin. "Regionalisation of Climate Change sensitive forest development types for potential afforestation areas", Journal of Environmental Management, 2012.

Crossref

35 Xinlan Jia, Prottay M. Adhikari, Luigi Vanfretti. "Cross-Platform Real-Time Simulation Models for Li-ion Batteries in Opal-RT and Typhoon-HIL", 2021 IEEE Texas Power and Energy Conference (TPEC), 2021

Crossref

36 ada-ihueze.hashnode.dev

Internet

-
- 37 depot-e.uqtr.ca Internet 9 words — < 1%
-
- 38 dr.ntu.edu.sg Internet 9 words — < 1%
-
- 39 scholarworks.uno.edu Internet 9 words — < 1%
-
- 40 Ahlam Luaibi Shuraiji, Buraq Abdulhadi Awad. "Performances analysis of interior permanent magnet motors having different rotor iron pole shapes", International Journal of Power Electronics and Drive Systems (IJPEDS), 2021 Crossref 8 words — < 1%
-
- 41 B.K. Bose. "Energy, environment, and advances in power electronics", IEEE Transactions on Power Electronics, 2000 Crossref 8 words — < 1%
-
- 42 Guoquan P. Huang, Stergios I. Roumeliotis. "Analytically-guided-sampling particle filter applied to range-only target tracking", 2013 IEEE International Conference on Robotics and Automation, 2013 Crossref 8 words — < 1%
-
- 43 Sepasi, Saeed, Reza Ghorbani, and Bor. Yann. Liaw. "SOC estimation for aged lithium-ion batteries using model adaptive extended Kalman filter", 2013 IEEE Transportation Electrification Conference and Expo (ITEC), 2013. Crossref 8 words — < 1%
-
- 44 V Karkuzhali, P Rangarajan, V Tamilselvi, P Kavitha. "Analysis of battery management system issues in electric vehicles", IOP Conference Series: Materials Science and Engineering, 2020 8 words — < 1%

-
- 45 [epdf.pub](#)
Internet 8 words — < 1%
-
- 46 [es.scribd.com](#)
Internet 8 words — < 1%
-
- 47 [manualzz.com](#)
Internet 8 words — < 1%
-
- 48 [patents.patsnap.com](#)
Internet 8 words — < 1%
-
- 49 [repository.up.ac.za](#)
Internet 8 words — < 1%
-
- 50 [www.scipress.com](#)
Internet 8 words — < 1%
-
- 51 "Recent Advances in Power Electronics and Drives", Springer Science and Business Media LLC, 2021
Crossref 7 words — < 1%
-
- 52 Ramtin Mojtahedi Saffari, Sattar Mirzakuchaki. "A novel FPGA design of a high dynamic human tracking system using particle filter", 2016 24th Iranian Conference on Electrical Engineering (ICEE), 2016
Crossref 7 words — < 1%
-
- 53 Xing, Yinjiao, Wei He, Michael Pecht, and Kwok Leung Tsui. "State of charge estimation of lithium-ion batteries using the open-circuit voltage at various ambient temperatures", Applied Energy, 2014.
Crossref 7 words — < 1%

54 Du, Guanglong, and Ping Zhang. "A novel human-manipulators interface using hybrid sensors with Kalman filter and particle filter", Robotics and Computer-Integrated Manufacturing, 2016. 6 words — < 1%

Crossref

55 Ha Xuan Nguyen, Hung Quang Cao, Ty Trung Nguyen, Thuong Ngoc-Cong Tran, Hoang Ngoc Tran, Jae Wook Jeon. "Improving Robot Precision Positioning Using a Neural Network Based on Levenberg Marquardt-APSO Algorithm", IEEE Access, 2021 6 words — < 1%

Crossref

56 Restaino, Rocco, and Walter Zamboni. "Comparing particle filter and extended kalman filter for battery State-Of-Charge estimation", IECON 2012 - 38th Annual Conference on IEEE Industrial Electronics Society, 2012. 6 words — < 1%

Crossref

57 Srinivas Singirikonda, Y. P. Obulesu. "Chapter 182 Advanced SOC and SOH Estimation Methods for EV Batteries—A Review", Springer Science and Business Media LLC, 2021 6 words — < 1%

Crossref

EXCLUDE QUOTES OFF
EXCLUDE BIBLIOGRAPHY ON

EXCLUDE MATCHES OFF