

УДК 007 : 159.955:519.768 : 621.372.852 : 621.372.413

A.G. YUSHCHENKO, Ph.D., prof. of «SI» Department, NTU «KhPI»;
D.B. MAMEDOV, master's degree candidates, NTU «KhPI»

INTELLECTUAL CAD OF MM WAVES WDR FILTERS WITH INCREASED STOP BAND ATTENUATION

У статті викладено фізичні принципи розробки оригінальної інтелектуальної САПР триланкових ХДР-фільтрів з розширеною областю позасмугового затухання. Проаналізовано електродинамічні параметри частково заповнених резонаторів з квазі- H_{101} - і квазі- H_{102} модами, які впливають на їх взаємну частотну відстань. Результати конструювання фільтрів відповідають новітнім стандартам ECMA-387, WirelessHD, IEEE 802.15.3c, IEEE 802.11ad.

Physical principles of the original intellectual CAD development for three-tier WDR filters with increased stop band attenuation are presented in the article. The electrodynamic parameters of the partly filled resonators with quasi- H_{101} and quasi- H_{102} eigenmodes, which influencing on their frequency separation are analysed. The results of filters designing, proper to the recent standards ECMA-387, WirelessHD, IEEE 802.15.3c, IEEE 802.11ad, are presented.

В статье представлены физические принципы разработки оригинальной интеллектуальной САПР трехзвенных ВДР фильтров с расширенной областью внеполосного подавления. Проанализированы электродинамические параметры частично заполненных резонаторов с квази- H_{101} - и квази- H_{102} модами, которые оказывают влияние на их взаимное частотное расстояние. Результаты конструирования фильтров соответствуют новейшим стандартам ECMA-387, WirelessHD, IEEE 802.15.3c, IEEE 802.11ad.

Introduction

Recently produced standardization of ranges 3-5 millimetre waves allows to expect dynamic growth of high – quality radio- telecommunication networks of information relaying [1-3]. According to this there is a necessity in development of the proper high-quality millimetre wave components base. Telecommunications wireless technology requires different types of band pass filters for selections and compactions of information channels. It is clear that the electromagnetic situation on the air requires constant improvement of receiver protection against electromagnetic interference as well as more strict requirements to transmitters, which are the sources of the interference. Traditionally these problems are solved using passive band filters mounted on receiver inputs and transmitter outputs. Various filters with different pass bands (or suppressed frequency bands) are used in metering apparatus while the most high-quality ones serve for frequency stabilization in oscillators. Among the known micro – and millimetre wave filters, the designs based on leucosapphire and quartz partially filled waveguide-dielectric resonators (WDR) pleased into cut-off waveguides are distinguished due to their general quality parameters, such as high unloaded Q's, sparse spectrum of parasitic eigenmodes and usable level of transmitted power [4,5]. The partial filling by this high

Q dielectric allows to increase to one order the unloaded Q of the resonator. Resonators partially filled in the waveguide H-plane, differ from E-plane ones in having a sparser spectrum of parasitic eigenmodes and somewhat lower unloaded Qs. Therefore they are perspective for development of filters with increased stop band attenuation, application of which allows to solve problems of electromagnetic compatibility of the receiving-passing telecommunications modules. Formulas for the calculation of eigen *quasi- H_{p0s}* eigenmodes of dielectric parallelepiped partly filling a cut-off waveguide on a width are shown in [4], the scattering problem solution methods of H_{10} -wave on the periodic system of resonators are described, and good accordance of results of calculation and experiment is demonstrated. In this article we will perform new results both as on spectrum optimization of quasi- H_{101} and quasi- H_{102} eigenmodes and filters designing, which proper to new standards of millimetre range on the basis of the noted theoretical solutions. As optimization of filters on a spectrum is a tough problem, intellectual CAD developed previously for LM mode was modernized for its realization [6].

Spectrum dynamics analysis of quasi- H_{101} and quasi- H_{102} eigenmodes

The design of the filter is shown in Fig. 1. Fig. 2 shows the quasi- H_{101} and quasi- H_{102} eigenmodes frequency separation calculated in different frequency ranges; increase in the width of cut-off waveguide was limited to decrease in the resonator length to manufacturing size of 0.4 mm. the end of stage option with a maximum value of the frequency separation is selected. At the second - construction of three-tier filter is optimized, as the initial parameters one-tier optimization results are used.

As follows from the dependencies, as well as those obtained in [4], the higher the dielectric permittivity of the resonator and, obviously, the less its length at a fixed operating frequency the higher is rarefaction of the eigenmodes spectrum.

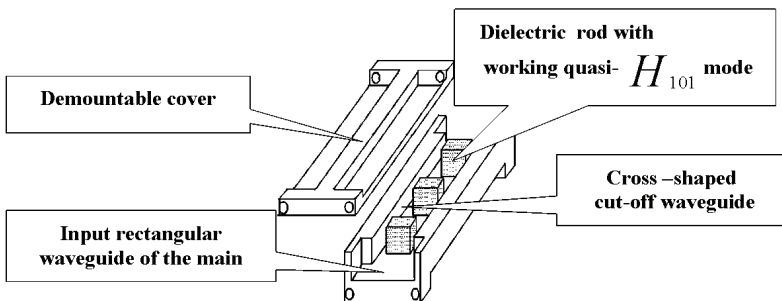

Figure 1 – The three-tier microwave WRD quasi- H_{101} filter with increased stop band attenuation design [7]

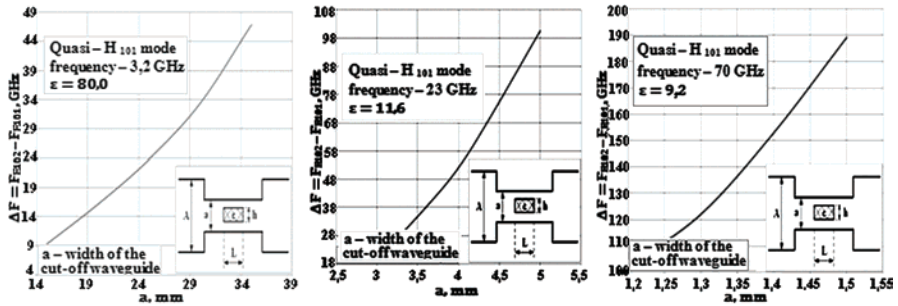

Figure 2 – Dynamics of quasi- H_{101} and quasi- H_{102} eigenmodes for fixed frequencies: 3.2, 23 and 70 GHz, accordingly

Physically it explains that at the edges of the resonator intensity of the electric field of the quasi- H_{102} higher than quasi- H_{101} eigenmodes, therefore, the frequency adjustment of the first one, higher than of the second one when the length changes. It's important to note that the same value of the resonator length can be obtained for different ratios of dielectric permittivity and width of cut-off waveguide. However, the realization of ultra-wideband waveguide filters with high cut-off waveguides is difficult because the values of loaded Q of the resonators are quite high even at zero values of the input cut-off section. These electromagnetic features of the WDR at cut-off waveguides make this task actual of the developing their computer-aided design systems to ensure optimization of designs on various parameters.

Intellectual CAD WDR filters with increased stop band attenuations results

Designs of three-tier WDR filters with increased stop band attenuations were calculated by modified intellectual CAD system [6]. On the basis of formalized physical knowledge about the behaviour of coupled resonators, the original CAD system analyses electromagnetic signal passing through a filter structure and makes decisions gradually approaching the optimal filter design through a series of changes in its geometry. Optimization of the filter design is carried out in two stages. At the first stage, the lengths of the resonators are calculated for various combinations of dielectric permittivity and widths of the cut-off waveguides, frequency separation between working quasi- H_{101} and parasitic quasi- H_{102} eigenmodes are also fixed.

At the filter design stages are illustrated below.

Fig. 3 demonstrates the concluding stage calculating the length of the central resonator with quasi- H_{101} mode under working frequency of 60 GHz. Upper frequency response image shows resonance splash proper to the current geometrical parameters of structure, low – frequency separation between eigenmodes quasi-

H_{101} (left splash) and quasi- H_{102} (right splash). Figure 4 demonstrates the concluding stage calculating the three-tier 60 GHz- filter design with quasi- H_{101} mode. The upper figure of the intellectual CAD menu shows bandwidth of the filter and the lower - frequency separation between its working bandwidth (left) and parasitic one (right).

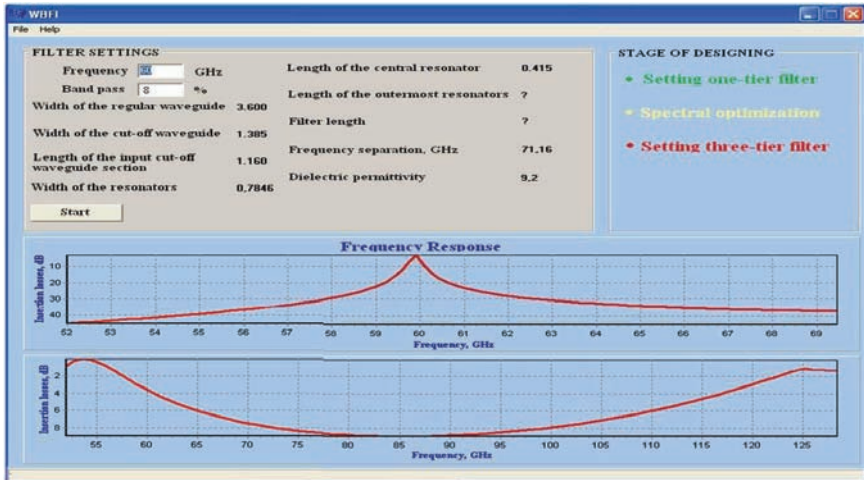

Figure 3 – The result of the spectral optimization of one-tier filter at a frequency of 60 GHz

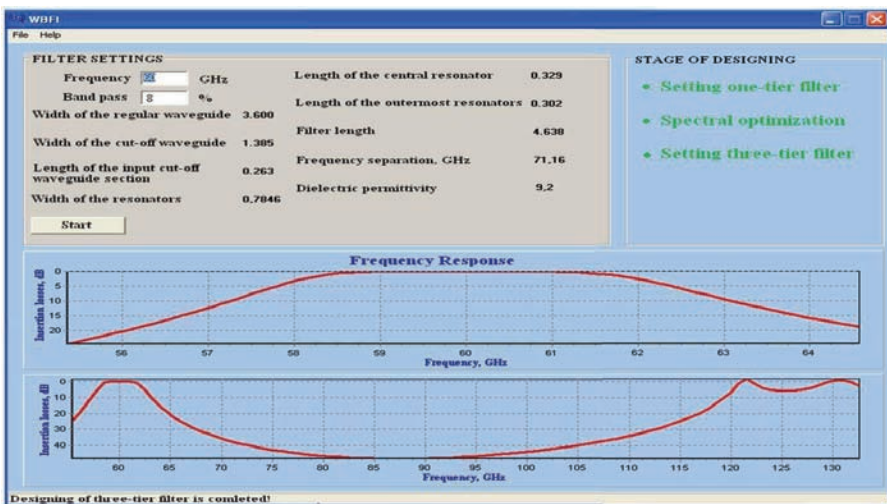

Figure 4 – The intellectual CAD system results of three-tier 60 GHz- filter design with spectral optimization

Analogically, Fig. 5 and Fig.6 show the results of the filters designing on the frequencies 83.5 and 73.5 GHz, respectively.

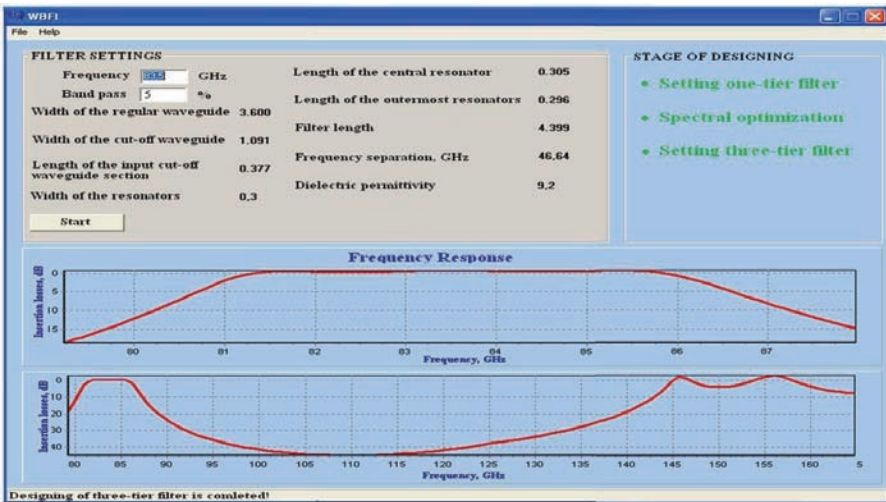

Figure 5 – The intellectual CAD system results of three-tier 83.5 GHz- filter design with spectral optimization

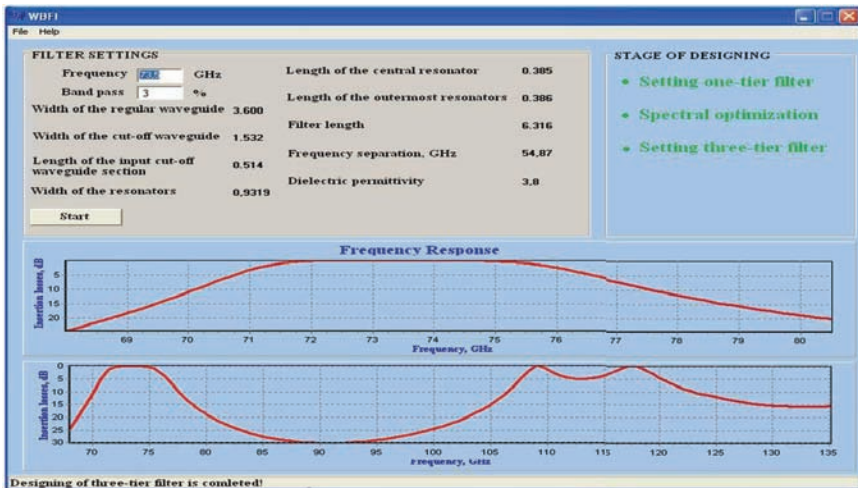

Figure 6a – The comparative characteristic of the frequency response of three-tier 73.5 GHz filter with band pass 3%

Fig. 6 shows the comparative characteristics of the frequency response of three-tier 73.5 GHz filters with different widths of band pass: 3, 7 and 20%, ac-

cordingly. The comparative analysis shows that frequency separation between the working band pass of and parasite did not change dramatically while level of stop band suppression, and accordingly, steepness of the high-frequency slope response are notably diminished with the increase of band pass width.

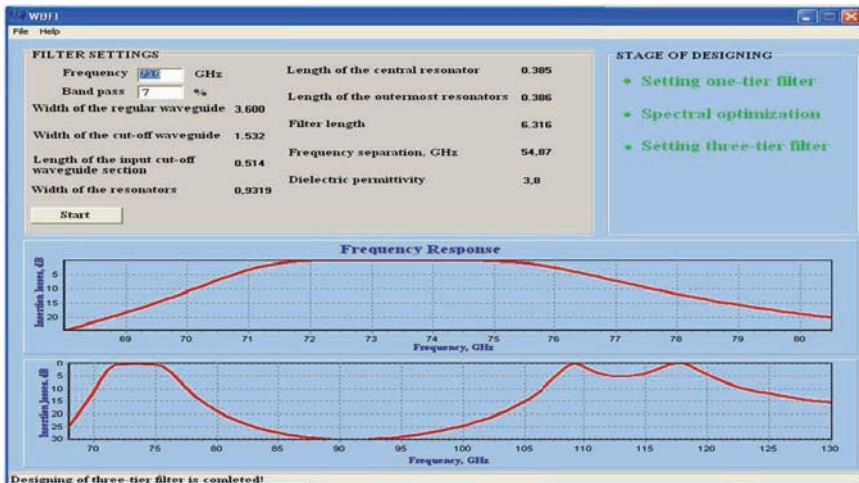

Figure 6b – The comparative characteristic of the frequency response of three-tier 73.5 GHz filter with band pass 7%

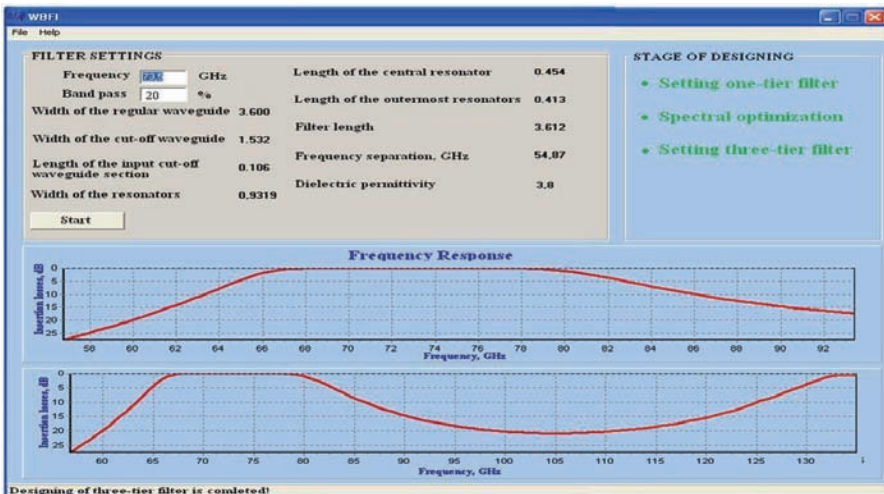
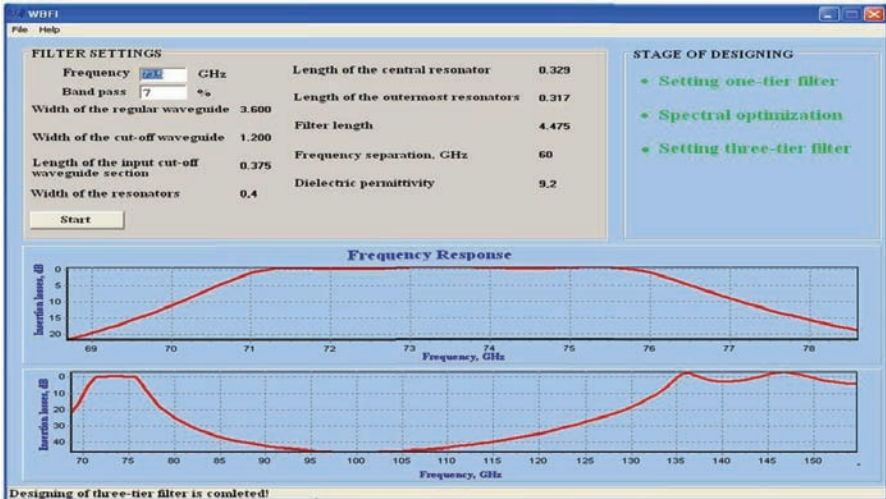

Figure 6c – The comparative characteristic of the frequency response of three-tier 73.5 GHz filter with band pass: 20%

On the Fig. 7 the results of such filter intellectual CAD system designing

with more high value of dielectric permeability $\epsilon = 9.2$, instead of $\epsilon = 3.8$ are represented; here the technological sizes of resonators are succeeded to be saved due to narrowing of cut-off waveguide. The comparison of this filter response with similar previous (Fig. 7, band pass – 7 %, $\epsilon = 3.8$) shows that the last variant appears to be preferable both on stop band suppression and on the steepness of response slopes.



Figures 7 – The intellectual CAD system results of three-tier 73.5 GHz- filter design with spectral optimization

Conclusions

Filters based on partially filled waveguide-dielectric resonators surpass in many quality aspects the well-known analogues, that is why they have a good chance of being widely used in new generation of receiver - transmitter wireless devices of the millimetre wave band. WDR filters can have the microstrip input \ output coupling elements and be adapted to plane technologies. It also has some perspectives to use quasi- H_{10n} resonators because their frequencies do not depend on the height of waveguide screen. In this aspect they are attractive for creation of a new generation telecommunications devices of millimetre range waves.

High speed of calculations is the distinctive feature of the intellectual system from the known ones, practically every successive step in calculations changes frequency response in the direction of all greater approximations to optimum, at the chosen values of dielectric permeability and width of cut-off waveguide. Thus, the system creates a base from the calculated variants of filters, giving possibility of manifest the best, as per the chosen criterion; in our case it is the maximal band pass at an erratical response no more than 0.2 dB.

The efficiency of intellectual CAD depends only on the accuracy of the

analysis problem solution and the exactness with which the application conditions of the rules applied match the data. Therefore it is high enough: the errors are less than 2% in both cases, i.e. for frequency and insertions losses.

Thus, the modified original intellectual CAD system effectively solves a problem of designing optimal three-tier wide band microwave WDR quasi- H_{101} filters with spectral optimization and may be considered as a prototype for designing filters with more tiers.

References: 1. Millimeter wave technology in wireless PAN, LAN, and MAN / Xiao, Shao-Qiu et al. CRC Press, 2008. 2. IEEE Std 802.15.3c-2009. Wireless Medium Access Control (MAC) and Physical Layer (PHY) Specifications for High Rate Wireless Personal Area Networks (WPANs). Amendment 2: Millimeter-wave-based Alternative Physical Layer Extension. – IEEE, 12 October 2009. 3. IEEE Std 802.15.3 Wireless Medium Access Control (MAC) and Physical Layer (PHY) Specifications for High Rate Wireless Personal Area Networks (WPANs). IEEE, 29 September 2003. 4. *A.G.Yushchenko* Waveguide-dielectric filters based on leucosapphire and quartz monocrystals // SPI's Int. Symp. on «Voice, Video and Data Communications». – V. 3232. – 1997. – PP.73-79. doi:10.1117/12.301020. 5. *A.G.Yushchenko* High unloaded-Qs WDR filters designing // International Journal of Infrared and Millimeters Waves. – Vol. 22, no. 12. – 2001. – PP. 1831-1836. doi:10.1023/A:1015031802727. 6. *A.Yushchenko, D.Mamedov, D.Zaytsev* Intellectual CAD for Three-Tier Wide Band WDR Filters // Wireless Engineering and Technology. – Vol. 3 No. 1. – 2012. – PP. 30-35. doi:10.4236/wet.2012.31005. 7. *A.G.Yushchenko* et al. Microwave Filter // Buluten Izobreteniy, (in Russian), Patent of Russia Federation №.2040080, 1995.

Поступила в редколлегию 12.04.2012