



# Nonlinear observer for the PM synchronous motor

Ramdane Tami, Driss Boutat, Gang Zheng

## ► To cite this version:

Ramdane Tami, Driss Boutat, Gang Zheng. Nonlinear observer for the PM synchronous motor. ACC, Jun 2014, Portland, United States. pp.4133 - 4138, 10.1109/ACC.2014.6859080 . hal-01094915

**HAL Id: hal-01094915**

**<https://hal.inria.fr/hal-01094915>**

Submitted on 14 Dec 2014

**HAL** is a multi-disciplinary open access archive for the deposit and dissemination of scientific research documents, whether they are published or not. The documents may come from teaching and research institutions in France or abroad, or from public or private research centers.

L'archive ouverte pluridisciplinaire **HAL**, est destinée au dépôt et à la diffusion de documents scientifiques de niveau recherche, publiés ou non, émanant des établissements d'enseignement et de recherche français ou étrangers, des laboratoires publics ou privés.

# Nonlinear Observer for the PM Synchronous Motor

Ramdane Tami<sup>\*,1</sup>, Driss Boutat<sup>1</sup> and Gang Zheng<sup>2</sup>

**Abstract**—This paper deals with nonlinear states and parameters estimation of a permanent magnet synchronous motor (PMSM) without mechanical sensors. In the proposed method, a change of coordinates is established in order to transform the PMSM system into an observer form which enables us to apply an adaptive or a high gain observer. Then the load torque, rotor speed and some parameters can be estimated from both measurable currents and voltages. The efficiency of the proposed methods is illustrated by the simulation results.

## I. INTRODUCTION

Synchronous motor is widely used in industry, particularly in energy and transport. It must not only be reliable, but also have an optimum performance which are strongly dependent on its control and the access to measurements and parameters.

Enhancing the performance of control and fault monitoring requires accurate estimation of state variables and identification of parameters. Numerous observer strategies are developed to estimate the states and the parameters of PMSM, such as adaptive observer [1], [2], sliding mode observer [3], [4], [5], [6] and Extended Kalman filter [7], [8], [9], [10]. Recently in [11], [12] an adaptive interconnected observer has been proposed.

This paper presents a new method to design nonlinear observer for PMSM. The strategy is based on constructing an extended output depending observer normal form through a change of coordinates [13], which enables us to apply the existing observers in the literatures, such as those presented in [14], [15], [16], [17].

The approach of observer normal form has been set up in [18] for a varying time and in [19] for an invariant time single output nonlinear dynamical system. Then, it has been adopted for the multiple outputs case in [20], [21]. After that, several relevant algorithms have been developed in [22], [23], [24], [25], [26], [27], [28], [29]. Besides, another interesting form, the so-called depending output observer normal form, was introduced by [30], and then was improved in [31] and [32]. The most recent normal form, called extended nonlinear observer normal form due to [33], allows us to enlarge the class of observer normal forms. It has been generalized by [34], [35], [36], [37], [38]. The idea of the last form is to add an auxiliary dynamics into the original system such that the augmented system fulfills existing conditions which

guarantee a transformation of the studied system into an extended normal form. On the other hand, this observer normal form constitutes a very powerful tool to solve the problem of simultaneous estimation of states and parameters [19], [14].

The paper is organized as follows: Firstly, the observer form is presented in Section II. In Section III, a change of coordinates which transforms the PMSM model into observer form is proposed. In Section IV, the load torque and rotor speed are estimated when parameters are considered as known. The case of simultaneous estimation of states variables and the unknown parameters is considered in Section V. Finally, simulation results and conclusion are discussed in the last section.

## II. BACKGROUND ON NONLINEAR EXTENDED OBSERVER NORMAL FORMS

In this section, a brief overview on the extended observer normal form is provided. We consider a multi-output nonlinear system in the following form:

$$\begin{cases} \dot{x} = f(x) \\ y = h(x) \end{cases} \quad (1)$$

where  $x \in U \subseteq \mathbb{R}^n$  represents the state and  $y \in \mathbb{R}^p$  denotes the outputs. We assume that the vectors field  $f$  and the output function  $h$  are sufficiently smooth.

Also, it is assumed that the pair  $(h, f)$  satisfies the observability rank conditions, thus the 1-forms  $\theta_i = dL_f^{i-1}h$  for  $1 \leq i \leq n$  are linearly independent where  $L_f^{i-1}h$  is the  $(i-1)^{th}$  Lie derivative of the output  $h$  in the direction of the vector field  $f$ , and  $d$  is the differential operator.

Under the above assumptions, theoretically the state can be estimated as  $x = \sigma(y, \dot{y}, \dots, y^{n-1})$  where  $\sigma$  is a function which can be determined from the dynamics of system (1). However, it has been established that the use of successive output derivatives amplifies the noise in the measurement. Therefore, the observer design is a powerful tool to address the state estimation problem. To do so, in the case of nonlinear system, the transformation into observer form is used for which the observer design is relatively straightforward.

Consider the nonlinear system (1), we seek a one dimensional auxiliary dynamics  $\dot{w} = \eta(y, w)$  so that the following extended dynamical system:

$$\dot{x} = f(x) \quad (2)$$

$$\dot{w} = \eta(y, w) \quad (3)$$

$$y = h(x) \quad (4)$$

might be transformed through a change of coordinates  $(\xi^T, \zeta)^T = \phi(x, w)$  into the following extended output

<sup>\*</sup>This work was supported by Région Centre France

<sup>1</sup> Ramdane Tami and Driss Boutat is with INSA Centre Val de Loire, Univ. d'Orléans, Laboratoire PRISME EA 4229, 88 BD Lahitolle, CS 60013, 18022 Bourges, France ramdane.tami@insa-cvl.fr, driss.boutat@insa-cvl.fr

<sup>2</sup> Gang Zheng is with INRIA Lille-Nord Europe, 40 Avenue Halley 59650 gang.zheng@inria.fr

depending observer form:

$$\dot{\xi} = A(y, w)\xi + B(y, w) \quad (5)$$

$$\dot{\zeta} = B_{n+1}(y, w) \quad (6)$$

$$y = C\xi \quad (7)$$

where  $\zeta \in \mathbb{R}$ ,  $w \in \mathbb{R}$  is an extra-output,  $C = [0, \dots, 0, 1]$ , and

$$A(y, w) = \begin{pmatrix} 0 & \dots & \dots & \dots & 0 \\ \alpha_2(y, w) & 0 & \dots & \dots & 0 \\ 0 & \alpha_3(y, w) & \dots & \dots & \dots \\ 0 & \dots & \dots & \dots & \dots \\ 0 & \dots & \dots & \alpha_n(y, w) & 0 \end{pmatrix} \quad (8)$$

where  $\alpha_i(y, w) \neq 0$ , for  $2 \leq i \leq n$  are functions depending only on the output  $y$  and the extra-output  $w$ . The normal form given by (5)-(7) allows to apply a high gain observer [15].

### III. PMSM MODEL

The model of PMSM [39] is described by a set of differential equations in  $(d - q)$  reference frame as follows:

$$\frac{d\Omega}{dt} = -\frac{f_v}{J}\Omega + \frac{p}{J}\phi_f i_q - \frac{1}{J}T_l \quad (9)$$

$$\frac{di_d}{dt} = -\frac{R_s}{L_s}i_d + p\Omega i_q + \frac{1}{L_s}u_d \quad (10)$$

$$\frac{di_q}{dt} = -\frac{R_s}{L_s}i_q - p\Omega i_d - p\frac{1}{L_s}\phi_f\Omega + \frac{1}{L_s}u_q \quad (11)$$

where  $\Omega$ ,  $i_d$ ,  $i_q$  are the rotor speed, the  $d$  and  $q$ -axis currents, respectively,  $u_d$  and  $u_q$  are the  $d$  and  $q$ -axis voltages, respectively,  $T_l$  is the load torque,  $R_s$  is the winding stator resistance,  $L_s$  is the stator winding inductance,  $\phi_f$  is the magnet flux,  $p$  is the number of the pair poles,  $J$  is the rotor moment inertia, and  $f_v$  is the viscous friction coefficient. In the rest of the of this paper, it is assumed that  $[\Omega, i_d, i_q]^T = [x_1, x_2, x_3]^T$ . The currents in the  $(d - q)$  reference frame are chosen as the measurement vectors such that :

$$y_1 = i_d \quad (12)$$

$$y_2 = i_q \quad (13)$$

#### A. Change of coordinates

In the following, two reduced observer forms can be constructed from the outputs  $y_1 = i_d$  and  $y_2 = i_q$ . The first one is realized with the dynamics of  $\Omega$  and  $i_d$ , the second one is realized with the dynamics of  $\Omega$  and  $i_q$ .

1) *Observer normal form by using a rotor mechanical speed dynamics ( $x_1 = \Omega$ ) and stator current ( $x_2 = i_d$ ):* Let us consider dynamics given in (9), (10), (12) and (13) as a subsystem:

$$\dot{x}_1 = -\frac{f_v}{J}x_1 + \frac{p}{J}\phi_f x_3 - \frac{1}{J}T_l \quad (14)$$

$$\dot{x}_2 = -\frac{R_s}{L_s}x_2 + px_1 x_3 + \frac{1}{L_s}u_d \quad (15)$$

$$y_1 = x_2 = i_d$$

$$y_2 = x_3 = i_q$$

*Proposition 1:* The change of coordinates

$$z_1 = x_1 e^{-\int_0^w \frac{1}{\kappa(s)} ds} \quad (16)$$

$$z_2 = x_2 \quad (17)$$

where  $\dot{w} = \eta = -\frac{f_v}{J}\kappa(w)$  and  $\kappa(w)$  is a function to be determined, transforms the dynamical system given by (14)-(15) into following observer form:

$$\dot{z}_1 = \left( \frac{p}{J}\phi_f y_2 - \frac{1}{J}T_l \right) e^{-\int_0^w \frac{1}{\kappa(s)} ds} \quad (18)$$

$$\dot{z}_2 = py_2 e^{\int_0^w \frac{1}{\kappa(s)} ds} z_1 - \frac{R_s}{L_s}y_1 + \frac{1}{L_s}u_d \quad (19)$$

*Proof:* The differential of (16) with respect to  $t$  gives:

$$\begin{aligned} \dot{z}_1 &= \dot{x}_1 e^{-\int_0^w \frac{1}{\kappa(s)} ds} - x_1 \frac{1}{\kappa(w)} \dot{w} e^{-\int_0^w \frac{1}{\kappa(s)} ds} \\ &= \left( -\frac{f_v}{J}x_1 + \frac{p}{J}\phi_f x_3 - \frac{1}{J}T_l \right) e^{-\int_0^w \frac{1}{\kappa(s)} ds} \\ &\quad - x_1 \frac{1}{\kappa(w)} \left( -\frac{f_v}{J}\kappa(w) \right) e^{\int_0^w \frac{1}{\kappa(s)} ds} \\ &= \left( \frac{p}{J}\phi_f x_3 - \frac{1}{J}T_l \right) e^{-\int_0^w \frac{1}{\kappa(s)} ds} \end{aligned}$$

Thus, we obtain:

$$\dot{z}_1 = \left( \frac{p}{J}\phi_f y_2 - \frac{1}{J}T_l \right) e^{-\int_0^w \frac{1}{\kappa(s)} ds}$$

Moreover, the differential of equation (17) gives

$$\dot{x}_2 = px_3 e^{\int_0^w \frac{1}{\kappa(s)} ds} z_1 - \frac{R_s}{L_s}x_2 + \frac{1}{L_s}u_d$$

Consequently:

$$\dot{z}_2 = py_2 e^{\int_0^w \frac{1}{\kappa(s)} ds} z_1 - \frac{R_s}{L_s}y_1 + \frac{1}{L_s}u_d$$

2) *Observer normal form by using a rotor mechanical speed dynamics ( $x_1 = \Omega$ ) and stator current ( $x_3 = i_q$ ):* Let us consider another subsystem constructed by the dynamics given by (9) and (11) such that:

$$\frac{dx_1}{dt} = -\frac{f_v}{J}x_1 + \frac{p}{J}\phi_f x_3 - \frac{1}{J}T_l \quad (20)$$

$$\frac{dx_3}{dt} = -\frac{R_s}{L_s}x_3 - px_1 x_2 - p\frac{1}{L_s}\phi_f x_1 + \frac{1}{L_s}u_q \quad (21)$$

$$y_1 = x_2 = i_d$$

$$y_2 = x_3 = i_q$$

*Proposition 2:* The following change of coordinates

$$\xi_1 = x_1 e^{-\int_0^w \frac{1}{\kappa(s)} ds} \quad (22)$$

$$\xi_2 = x_3 \quad (23)$$

where  $\dot{w} = \eta = -\frac{f_v}{J}\kappa(w)$  and  $\kappa(w)$  is a function to be determined, transforms the system given by (20)-(21) into following observer form:

$$\dot{\xi}_1 = \left( \frac{p}{J}\phi_f y_2 - \frac{1}{J}T_l \right) e^{-\int_0^w \frac{1}{\kappa(s)} ds} \quad (24)$$

$$\dot{\xi}_2 = -p \left( y_1 + \frac{\phi_f}{L_s} \right) e^{\int_0^w \frac{1}{\kappa(s)} ds} \xi_1 - \frac{R_s}{L_s} y_2 + \frac{1}{L_s} u_q \quad (25)$$

*Proof:* The differential of the change of coordinates (22) gives:

$$\begin{aligned} \dot{\xi}_1 &= \dot{x}_1 e^{-\int_0^w \frac{1}{\kappa(s)} ds} - x_1 \frac{1}{\kappa(w)} \dot{w} e^{-\int_0^w \frac{1}{\kappa(s)} ds} \\ &= \left( -\frac{f_v}{J} x_1 + \frac{p}{J} \phi_f x_3 - \frac{1}{J} T_l \right) e^{-\int_0^w \frac{1}{\kappa(s)} ds} \\ &\quad - x_1 \frac{1}{\kappa(w)} \left( -\frac{f_v}{J} \kappa(w) \right) e^{-\int_0^w \frac{1}{\kappa(s)} ds} \\ &= \left( \frac{p}{J} \phi_f x_3 - \frac{1}{J} T_l \right) e^{-\int_0^w \frac{1}{\kappa(s)} ds} \end{aligned}$$

Then

$$\dot{\xi}_1 = \left( \frac{p}{J} \phi_f y_2 - \frac{1}{J} T_l \right) e^{-\int_0^w \frac{1}{\kappa(s)} ds}$$

Also, the differential of change of coordinates (23) gives

$$\begin{aligned} \dot{\xi}_2 &= -p \left( x_2 + \frac{\phi_f}{L_s} \right) x_1 - \frac{R_s}{L_s} x_3 + \frac{1}{L_s} u_q \\ &= -p \left( x_2 + \frac{\phi_f}{L_s} \right) e^{\int_0^w \frac{1}{\kappa(s)} ds} \xi_1 - \frac{R_s}{L_s} x_3 + \frac{1}{L_s} u_q \end{aligned}$$

Then

$$\dot{\xi}_2 = -p \left( y_1 + \frac{\phi_f}{L_s} \right) e^{\int_0^w \frac{1}{\kappa(s)} ds} \xi_1 - \frac{R_s}{L_s} y_2 + \frac{1}{L_s} u_q$$

*Remark 1:* Both the systems given by the dynamical equations (18)-(19) and (24)-(25) are obviously observable with simple appropriate structure, thus we can easily use the existing observers in the literature to estimate the states. [15].

#### IV. HIGH GAIN OBSERVER

In this section, the load torque  $T_l$  and rotors speed  $\Omega$  are estimated when the parameters  $\phi_f$ ,  $L_s$ ,  $R_s$  are assumed to be known and the load torque  $T_l$  is considered as constant piecewise function. It is easy to see, with the dynamics  $\dot{T}_l = 0$ , (24) and (25), one can obtain the following output depending observer form:

$$\begin{aligned} \begin{bmatrix} \dot{T}_l \\ \dot{\xi}_1 \\ \dot{\xi}_2 \end{bmatrix} &= \begin{bmatrix} 0 & 0 & 0 \\ \alpha_{11}(y, w) & 0 & 0 \\ 0 & \alpha_{12}(y, w) & 0 \end{bmatrix} \begin{bmatrix} T_l \\ \xi_1 \\ \xi_2 \end{bmatrix} \\ &\quad + \begin{bmatrix} 0 \\ \frac{p}{J} \phi_f y_2 e^{-\int_0^w \frac{1}{\kappa(s)} ds} \\ -\frac{R_s}{L_s} y_2 + \frac{1}{L_s} u_q \end{bmatrix} \end{aligned}$$

where  $\alpha_{11}(y, w) = -\frac{1}{J} e^{-\int_0^w \frac{1}{\kappa(s)} ds}$  and  $\alpha_{12}(y, w) = -p \left( y_1 + \frac{\phi_f}{L_s} \right) e^{\int_0^w \frac{1}{\kappa(s)} ds}$ . The above form allows us to apply

the high gain observer presented in [15] as follows:

$$\dot{\hat{\xi}} = A(y, w)\hat{\xi} + B(w, y) - \Gamma^{-1}(y)R_\rho^{-1}C^T(C\hat{\xi} - \bar{y}) \quad (26)$$

where

$$G = \begin{pmatrix} 0 & \cdots & 0 & 0 \\ 1 & \cdots & 0 & 0 \\ \vdots & \ddots & \vdots & \vdots \\ 0 & \cdots & 1 & 0 \end{pmatrix}$$

$$\Gamma(y, w) = \text{diag} \left[ \prod_{i=2}^n \alpha_i(y, w), \prod_{i=3}^n \alpha_i(y, w), \dots, \alpha_n(y, w), 1 \right]$$

$$R_\rho(n+1-i, n+1-j) = \frac{(-1)^{i+j} C_{i+j-2}^{j-1}}{\rho^{i+j-1}}$$

for  $1 \leq i \leq n$  and  $1 \leq j \leq n$ .

If we set  $e = \hat{\xi} - \xi$  to be the observation error, then we see that its dynamics is governed by the following equation:

$$\dot{e} = \dot{\hat{\xi}} - \dot{\xi} = (A(y, w) - \Gamma^{-1}(y, w)R_\rho^{-1}C^T C)e.$$

If  $y$  and  $w$  are bounded, then the observation error dynamics is exponentially stable by well choosing  $\rho$ .

*Remark 2:* The rotor position can be estimated by integrating the rotor speed with the knowledge of the initial rotor position [6].

#### A. Simulation results with high gain observer

The efficiency of the previous approach to estimates the load torque and speed rotor is shown in Fig.1 and Fig.2.

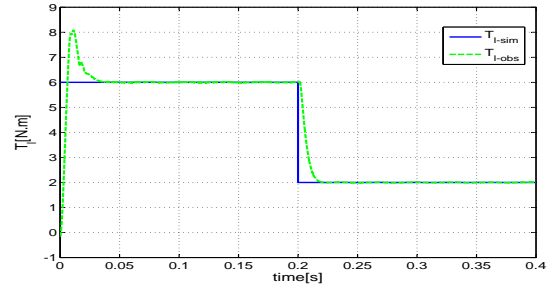

Fig. 1: Estimation of the load torque  $T_l$ .

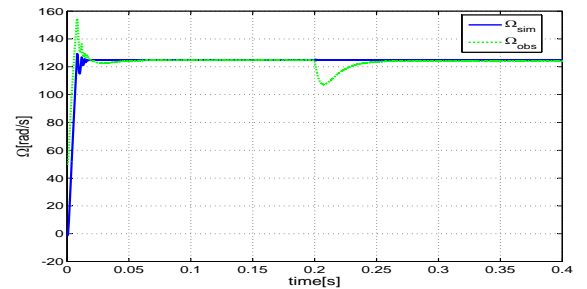

Fig. 2: Estimation of the rotor mechanical speed  $\Omega$ .

## V. ADAPTIVE OBSERVER

In this section, the parameters  $\phi_f$ ,  $L_s$ ,  $R_s$  are assumed to be unknown and  $T_l$  is considered as constant piecewise function. In what follows, we are going to estimate the load torque  $T_l$ , the rotor speed  $\Omega$ , magnet flux  $\phi_f$ , stator inductance  $L_s$ , and stator resistance  $R_s$  of PMSM, by applying the adaptive observer [14], [16] and [17]. For this, let us consider the system composed by the dynamics  $\dot{T}_l = 0$ , (18) and (19), then one obtains the following observer normal form:

$$\begin{bmatrix} \dot{T}_l \\ \dot{z}_1 \\ \dot{z}_2 \end{bmatrix} = \begin{bmatrix} 0 & 0 & 0 \\ \alpha_{21}(w, y) & 0 & 0 \\ 0 & \alpha_{22}(w, y) & 0 \end{bmatrix} \begin{bmatrix} T_l \\ z_1 \\ z_2 \end{bmatrix} + \begin{bmatrix} 0 & 0 & 0 \\ \frac{py_2 e^{-\int_0^w \frac{1}{\kappa(s)} ds}}{J} & 0 & 0 \\ 0 & -y_1 & u_d \end{bmatrix} \begin{bmatrix} \phi_f \\ \frac{R_s}{L_s} \\ \frac{1}{L_s} \end{bmatrix}$$

where  $\alpha_{21}(w, y) = -\frac{1}{J}e^{-\int_0^w \frac{1}{\kappa(s)} ds}$ ,  $\alpha_{22}(w, y) = pe^{\int_0^w \frac{1}{\kappa(s)} ds}$ . The above system can be written in the following form:

$$\begin{cases} \dot{z} = A(w, y)z + \phi(w, y)\theta \\ y = Cz \end{cases} \quad (27)$$

where  $z = [T_l \ z_1 \ z_2]^T$ ,  $\theta = [\phi_f \ \frac{R_s}{L_s} \ \frac{1}{L_s}]^T$

$$A(w, y) = \begin{bmatrix} 0 & 0 & 0 \\ -\frac{1}{J}e^{-\int_0^w \frac{1}{\kappa(s)} ds} & 0 & 0 \\ 0 & pe^{\int_0^w \frac{1}{\kappa(s)} ds} & 0 \end{bmatrix} \quad (28)$$

and

$$\phi(w, y) = \begin{bmatrix} 0 & 0 & 0 \\ \frac{p}{J}y_2 e^{-\int_0^w \frac{1}{\kappa(s)} ds} & 0 & 0 \\ 0 & -y_1 & u_d \end{bmatrix}$$

*Remark 3:* The dynamical system given by (27) is in adaptive observer form (with affine states and parameters) which enables to estimate the states and the parameters by using the adaptive observer.

Similarly to [17] and [16], it is assumed as well that there exist positive constants  $\alpha$ ,  $\beta$ ,  $T$  such that

$$\alpha I \leq \int_t^{t+T} \Lambda^T(\tau) C^T \Sigma(\tau) C(\tau) \Lambda(\tau) d\tau \leq \beta I$$

and

$$\alpha I \leq \int_t^{t+T} \Psi(t, \tau)^T C^T \Sigma(\tau) C \Psi(t, \tau) d\tau \leq \beta I \quad \forall t \geq t_0$$

where  $\Psi$  is the transition matrix for the following system:

$$\begin{cases} \dot{x} = A(y, w)x \\ y = Cx \end{cases}$$

and  $\Sigma$  is a positive definite symmetric matrix. Then, based on the results in [14], [16], [17], the following system:

$$\begin{aligned} \dot{\hat{x}} &= A(y, w)\hat{x} + \varphi(y) + \phi(y, w)\hat{\theta} \\ &+ \{\Lambda S_\theta^{-1} \Lambda^T C^T + S_x^{-1} C^T\} \Sigma (y - C\hat{x}) \end{aligned} \quad (29)$$

$$\dot{\hat{\theta}} = S_\theta^{-1} \Lambda^T C^T \Sigma (y - C\hat{x}) \quad (30)$$

$$\dot{\Lambda} = \{A(y, w) - S_x^{-1} C^T C\} \Lambda + \phi(y, w) \quad (31)$$

$$\dot{S}_x = -\rho_x S_x - A(y, w)^T S_x - S_x A(y, w) + C^T \Sigma C \quad (32)$$

$$\dot{S}_\theta = -\rho_\theta S_\theta + \Lambda^T C^T \Sigma C \Lambda, \quad S_x(0), S_\theta(0) > 0 \quad (33)$$

is an exponential adaptive observer for the nonlinear system (27), where  $\rho_x$  and  $\rho_\theta$  are positive constants.

### A. Simulation results with adaptive observer

In this subsection, the efficiency of the proposed approach to estimate both state variables and parameters of PMSM has been verified.

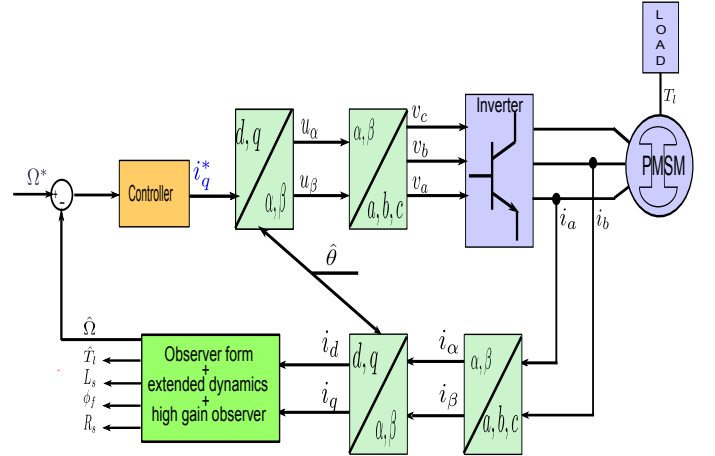

Fig. 3: Implementation of Adaptive observer.

The technical data for PMSM model used in simulations is given in Table I

Parameter	Symbol	Value
stator resistance	$R_s$	2.875 $\Omega$
stator inductance	$L_s$	8.5 mH
Number of pole pairs	$p$	3
Rotor magnetic flux	$\phi_f$	0.175 Wb
Moment of inertia	$J$	0.00003 kgm <sup>2</sup>
Viscous friction coefficient	$f_v$	0.0034 Nm/s

TABLE I: TABLE of MOTOR PARAMETERS

We take  $\kappa(w) = \frac{\sin^2(aw)}{(aw)^2}$  with  $a = 0.0005 \in ]0, 1[$ . The simulation results are presented in Fig. 4 and Fig. 5, Fig. 6, Fig. 7 and Fig. 8 respectively show the estimations of the load torque, the speed rotor, the magnet flux, the stator resistance and the winding inductance.

## VI. CONCLUSIONS

The estimation of the states and parameters of PMSM has been presented. By adding an extra-output dynamics to PMSM model, one can deduce a change of coordinates

which can transform the PMSM into an observer form. It was further shown that such a form allows us to apply successfully an adaptive or a high gain observer.

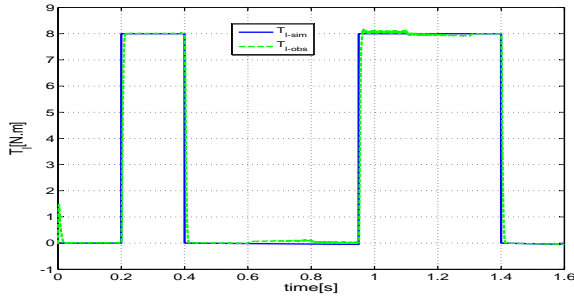

Fig. 4: Estimation of the load torque.

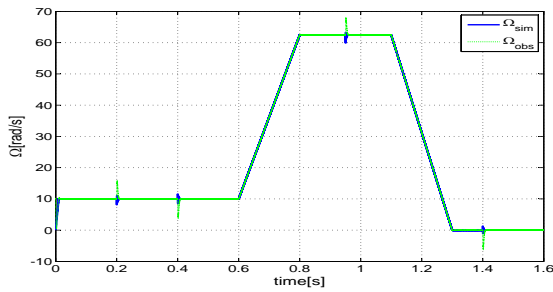

Fig. 5: Estimation of the rotor mechanical speed.

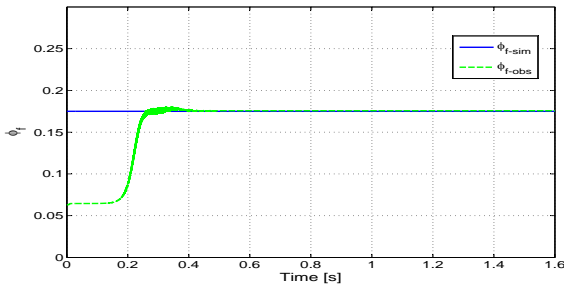

Fig. 6: Estimation of the magnet flux.

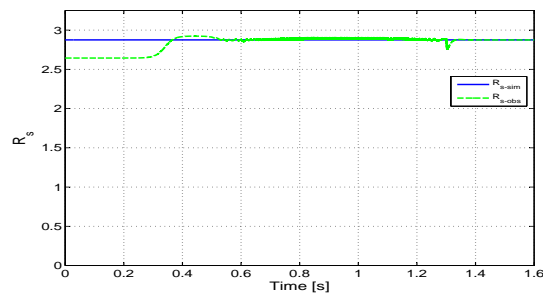

Fig. 7: Estimation of the stator resistance.

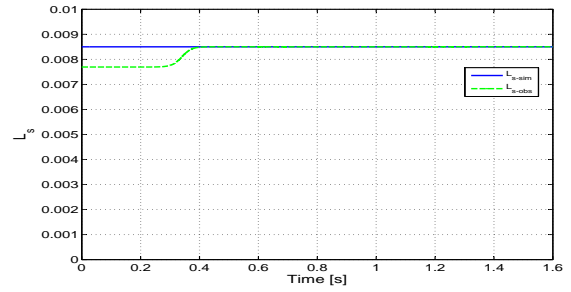

Fig. 8: Estimation of the winding inductance.

## REFERENCES

- [1] G. Besancon, J. De Leon-Morales, and O. Huerta-Guevara, "On adaptive observers for state affine systems," *International Journal of Control*, vol. 79, no. 06, pp. 581–591, 2006.
- [2] M. Ghanes, J.-B. Barbot, J. De Leon, and A. Glumineau, "A robust sensorless output feedback controller of the induction motor drives: new design and experimental validation," *International Journal of Control*, vol. 83, no. 3, pp. 484–497, 2010.
- [3] G. Cascella, N. Salvatore, and L. Salvatore, "Adaptive sliding-mode observer for field oriented sensorless control of spmsm," in *IEEE International Symposium on Industrial Electronics*, vol. 2, 2003, pp. 1137–1143.
- [4] K. Paponpen and M. Konghirun, "An improved sliding mode observer for speed sensorless vector control drive of pmsm," in *CES/IEEE 5th International Power Electronics and Motion Control Conference*, vol. 2, 2006, pp. 1–5.
- [5] M. Ghanes and G. Zheng, "On sensorless induction motor drives: sliding-mode observer and output feedback controller," *IEEE Transactions on Industrial Electronics*, vol. 56, no. 9, pp. 3404–3413, 2009.
- [6] D. Zaltini and M. Ghanes, "Observability analysis and improved zero-speed position observer design of synchronous motor with experimental results," *Asian Journal of Control*, vol. 15, no. 4, pp. 957–970, 2013.
- [7] S. Bolognani, R. Oboe, and M. Zigliotto, "Sensorless full-digital pmsm drive with ekf estimation of speed and rotor position," *IEEE Transactions on Industrial Electronics*, vol. 46, no. 1, pp. 184–191, 1999.
- [8] S. Bolognani, L. Tubiana, and M. Zigliotto, "Extended kalman filter tuning in sensorless pmsm drives," *IEEE Transactions on Industry Applications*, vol. 39, no. 6, pp. 1741–1747, 2003.
- [9] M. Boussak, "Implementation and experimental investigation of sensorless speed control with initial rotor position estimation for interior permanent magnet synchronous motor drive," *IEEE Transactions on Power Electronics*, vol. 20, no. 6, pp. 1413–1422, 2005.
- [10] D. Janiszewski, "Extended kalman filter based speed sensorless pmsm control with load reconstruction," in *IEEE Conference on Industrial Electronics*, 2006, pp. 1465–1468.
- [11] M. Ezzat, J. de Leon, and A. Glumineau, "Sensorless speed control of pmsm via adaptive interconnected observer," *International Journal of Control*, vol. 84, no. 11, pp. 1926–1943, 2011.
- [12] M. Hamida, J. De Leon, A. Glumineau, and R. Boisliveau, "An adaptive interconnected observer for sensorless control of pm synchronous motors with online parameter identification," *IEEE Transactions on Industrial Electronics*, vol. 60, no. 2, pp. 739–748, 2013.
- [13] J. Chiasson and R. Novotnak, "Nonlinear speed observer for the pm stepper motor," *IEEE Transactions on Automatic Control*, vol. 38, no. 10, pp. 1584–1588, 1993.
- [14] R. Marino and P. Tomei, "Global adaptive observers for nonlinear systems via filtered transformations," *IEEE Transactions on Automatic Control*, vol. 37, no. 8, pp. 1239–1245, 1992.
- [15] K. Busawon, M. Farza, and H. Hammouri, "A simple observer for a class of nonlinear systems," *Applied Mathematics Letters*, vol. 11, no. 3, pp. 27–31, 1998.
- [16] Q. Zhang, "Adaptive observer for multiple-input-multiple-output (mimo) linear time-varying systems," *IEEE Transactions on Automatic Control*, vol. 47, no. 3, pp. 525–529, 2002.

- [17] G. Besançon, J. de Leon-Morales, and O. Huerta-Guevara, "On adaptive observers for state affine systems and application to synchronous machines," in *42nd IEEE Conference on Decision and Control Proceedings*, vol. 3. IEEE, 2003, pp. 2192–2197.
- [18] D. Bestle and M. Zeitz, "Canonical form observer design for nonlinear time varying systems," *Internatio*, vol. 38, pp. 419–431, 1983.
- [19] A. Krener and A. Isidori, "Linearization by output injection and nonlinear observers," *Systems & Control Letters*, vol. 3, no. 1, pp. 47–52, 1983.
- [20] A. Krener and W. Respondek, "Nonlinear observers with linearizable error dynamics," *SIAM Journal on Control and Optimization*, vol. 23, no. 2, pp. 197–216, 1985.
- [21] X. Xia and W. Gao, "Nonlinear observer with linearizable error dynamics," *SIAM Journal on Control and Optimization*, vol. 27, pp. 199–216, 1989.
- [22] H. Keller, "Nonlinear observer design by transformation into a generalized observer canonical form," *International Journal of Control*, vol. 46(6), pp. 1915–1930, 1987.
- [23] A. Phelps, "On constructing nonlinear observers," *SIAM Journal on Control and Optimisation*, vol. 29, pp. 516–534, 1991.
- [24] J. Rudolph and M. Zeitz, "A block triangular nonlinear observer normal form," *Systems & Control Letters*, vol. 23, no. 1, pp. 1–8, 1994.
- [25] M. Hou and A. Pugh, "Observer with linear error dynamics for nonlinear multi-output systems," *Systems & Control Letters*, vol. 37, pp. 1–9, 1999.
- [26] R. Marino and P. Tomei, *Nonlinear control design: geometric, adaptive and robust*, P. H. I. U. Ltd, Ed., 1996.
- [27] D. Boutat, A. Benali, H. Hammouri, and K. Busawon, "New algorithm for observer error linearization with a diffeomorphism on the outputs," *Automatica*, vol. 45, no. 10, pp. 2187–2193, 2009.
- [28] A. Lynch and S. Bortoff, "Nonlinear observers with approximately linear error dynamics: the multivariable case," *IEEE Transactions on Automatic Control*, vol. 46, no. 6, pp. 927–932, jun 2001.
- [29] M. Lopez, F. Plestan, and A. Glumineau, "Linearization by completely generalized input output injection," *Kybernetika*, vol. 35, pp. 793–802, 1999.
- [30] W. Respondek, A. Pogromsky, and H. Nijmeijer, "Time scaling for observer design with linearizable error dynamics," *Automatica*, vol. 40 (2), pp. 277–285, 2004.
- [31] G. Zheng, D. Boutat, and J. Barbot, "A single output dependent observability normal form," *SIAM Journal on Control and Optimization*, vol. 46, no. 6, pp. 2242–2255, 2007.
- [32] Y. Wang and A. Lynch, "Observer design using a generalized time-scaled block triangular observer form," *Systems & Control Letters*, vol. 58, pp. 346–352, 2009.
- [33] P. Jouan, "Immersion of nonlinear systems into linear systems modulo output injection," *SIAM Journal on Control and Optimisation*, vol. 41(6), pp. 1756–1778, 2003.
- [34] D. Noh, N. Jo, and J. Seo, "Nonlinear observer design by dynamic observer error linearization," *IEEE Transactions on Automatic Control*, vol. 49, no. 10, pp. 1746–1753, 2004.
- [35] J. Back, K. T. Yu, and J. H. Seo, "Dynamic observer error linearization," *Automatica*, vol. 42, no. 12, pp. 2195–2200, 2006.
- [36] D. Boutat, "Geometrical conditions for observer error linearization via  $\int 0, 1, \dots, (n-2)$ ," in *7th IFAC Symposium on Nonlinear Control Systems NOLCOS'07*, 2007.
- [37] D. Boutat and K. Busawon, "On the transformation of nonlinear dynamical systems into the extended nonlinear observable canonical form," *International Journal of Control*, vol. 84, no. 1, pp. 94–106, 2011.
- [38] R. Tami, D. Boutat, and G. Zheng, "Extended output depending normal form," *Automatica*, vol. 49, no. 7, pp. 2192–2198, 2013.
- [39] J. Chiasson, *Modeling and High-performance Control of Electric Machines*. New York: John Wiley & Sons., 2005.