

**Purdue University**  
**Purdue e-Pubs**

---

International Refrigeration and Air Conditioning  
Conference

School of Mechanical Engineering

---

2008

# A New Liquid Desiccant System for Air-Conditioned Spaces with High Latent and Cooling Load

Yonggao Yin  
*Technical University of Catalonia*

Xiaosong Zhang  
*Southeast University*

Qingyan Chen  
*Purdue University*

Follow this and additional works at: <http://docs.lib.purdue.edu/iracc>

---

Yin, Yonggao; Zhang, Xiaosong; and Chen, Qingyan, "A New Liquid Desiccant System for Air-Conditioned Spaces with High Latent and Cooling Load" (2008). *International Refrigeration and Air Conditioning Conference*. Paper 861.  
<http://docs.lib.purdue.edu/iracc/861>

This document has been made available through Purdue e-Pubs, a service of the Purdue University Libraries. Please contact [epubs@purdue.edu](mailto:epubs@purdue.edu) for additional information.

Complete proceedings may be acquired in print and on CD-ROM directly from the Ray W. Herrick Laboratories at <https://engineering.purdue.edu/Herrick/Events/orderlit.html>

# A New Liquid Desiccant System for Air-Conditioned Spaces with High Latent and Cooling Load

Yonggao YIN<sup>1\*</sup>, Xiaosong ZHANG<sup>1</sup>, Qingyan CHEN<sup>2</sup>

<sup>1</sup>Southeast University, School of Energy and Environment,  
Nanjing, Jiangsu, China  
yiny@purdue.edu

<sup>2</sup>Purdue University, School of Mechanical Engineering,  
West Lafayette, IN, USA  
yanchen@purdue.edu

## ABSTRACT

This paper proposed a new ventilation system with radiant cooling by using liquid desiccant dehumidification, which provided very dry supply air and chilled water for radiant cooling. The dry air was from liquid desiccant dehumidification process and the chilled water was produced by liquid desiccant evaporative chilling. This study used an office with a high latent load to demonstrate the application of such a system. By using a validated Computational Fluid Dynamics (CFD) program to calculate the distributions of air temperature, humidity, and velocity as well as the Predicted Mean Vote in the office, the results showed that the new system could reduce the risk of condensation on the cooling panels and offer a comfortable indoor environment. The new system has a great potential for use in hot and humid climate regions.

## 1. INTRODUCTION

Radiant cooling has shown great advantages of improving thermal comfort due to reduced vertical temperature gradient in the occupied zone and to a low air speed (Behne, 1999; Imanari et al., 1999, Hao et al., 2007). Radiant cooling can also reduce energy demand because the energy used by its pump is lower than that by fan in all air systems (Sodec, 1999; Novoselac and Screbric, 2002). With radiant cooling, the room air temperature in summer could also be higher than that in all air systems so that the cooling load would become smaller. As a result, the energy demand can be further reduced (Feustel and Stetiu, 1995). Since radiant cooling alone cannot remove latent load and pollutants, such as volatile organic compounds, it should be supplemented with ventilation. In the 1990s, radiant cooling was used in combination with displacement ventilation in Europe. Experimental investigation and practical experiences in Europe (Givoni, 1991; IEA, 1998) have proved that radiant cooled ceilings are able to remove high cooling loads with good thermal comfort. For example, Niu (1994) found that cooled ceiling combined with displacement ventilation can produce a thermally comfortable environment at a cooling load up to 50 W/m<sup>2</sup>, compared with 40 W/m<sup>2</sup> with only displacement ventilation. However, Vangtook and Chirarattananon (2006) studied radiant cooling with natural ventilation under hot and humid climate in Thailand. The temperature of radiant cooled water was limited to 24°C to avoid condensation. They found that the low heat reception capacity of the panel would limit its use only to situations when loads were low. Obviously, the system is good for dry climate and could be problematic for humid climate. In the humid climate or high latent load space, such as operating theaters and certain hospital wards, a very high ventilation air requirement of a conventional system is essential or mandated, as pointed out by Ameen and Mahmud (2005), which would cause more energy consumption and cost, even discomfort.

Using desiccant dehumidified ventilation for the radiant cooling system could be competent for that situation. Desiccant dehumidified ventilation can provide very dry air to decrease the supply air flow rate, because the humidity ratio is lower than that obtained with a conventional vapor compression chiller used for all-air systems. This makes it desirable for buildings in hot and humid regions, like southeastern countries of Asia, where the risk of condensation is very high due to the low surface temperature in the radiant cooling panels. Another advantage is that sensible and latent cooling load are decoupled and controlled separately, which means that control of humidity can be achieved better than with conventional vapor compressive systems. Many investigations have been conducted on

using desiccant for radiant cooling. Niu et al. (2002) proposed a hybrid air conditioning system using desiccant rotor to dehumidify ventilated air. Their results show that up to 44% primary energy demand could be reduced with the hybrid system, in comparison with a conventional all-air system. Ameen and Mahmud (2005) conducted experiment study on desiccant dehumidification with hydronic radiant cooling system in humid tropical climates and the trial run confirmed that the condensation problem was not insurmountable; furthermore the system could be easy to agree with the load changing. Tsay et al. (2006) experimentally studied a desiccant cooling system with a heat pump by using the condensation heat for the desiccant rotor regeneration to improve the system thermal performance. Their results show that the COP of the desiccant system was estimated to be 2.32, which was higher than the thermal performance of heat-driven desiccant system. However, energy consumed by the system is high-grade electricity.

Convective radiant cooling uses chilled water from electricity-driven vapor compression chillers. The chillers have to use CFC or HCFC refrigerants at present and electricity. The use of such refrigerants is bad for the environment. Electricity is very high grade energy. Thus, it is necessary to find an alternative system that does not use vapor compressive chiller. This study proposes a new liquid desiccant cooling system for hot and humid climate. The system uses chilled water for radiant panels by dehumidifying and evaporative cooling while supplies dry air for space ventilation.

## 2. DESCRIPTION OF THE NEW LIQUID DESICCANT SYSTEM

Fig.1 (a) shows our new liquid desiccant dehumidification/radiant cooling system. The new system consists of four units: (I) liquid desiccant (LiCl-H<sub>2</sub>O) regeneration unit, (II) air dehumidification unit, (III) unit producing chilled water by evaporative cooling, and (IV) radiant cooling and dehumidified ventilation unit. The liquid desiccant regeneration unit is used to concentrate the diluted liquid desiccant from the dehumidifier by solar energy. Our early study (Yin et al., 2007) indicated that the regeneration of liquid desiccant could be driven by 60–80°C low-grade heat sources, such as solar energy. The air dehumidification unit uses liquid desiccant to produce very dry air for evaporative cooling unit and to condition the space. Different dehumidification processes could be used depending on the type of dehumidifiers, such as internally-cooled dehumidifiers and adiabatic dehumidifiers. The one shown in Figure 1 used an adiabatic dehumidifier. The air conditioned space can be kept as a thermally comfortable environment by radiant cooling and ventilation with dry air. The dry air is a part of that from the dehumidifier. The other part of the dry air enters the evaporative cooler to produce chilled water for the radiant ceiling panels. The temperature of the chilled water can be as low as 12°C with good thermal performance (Yin et al., 2006).

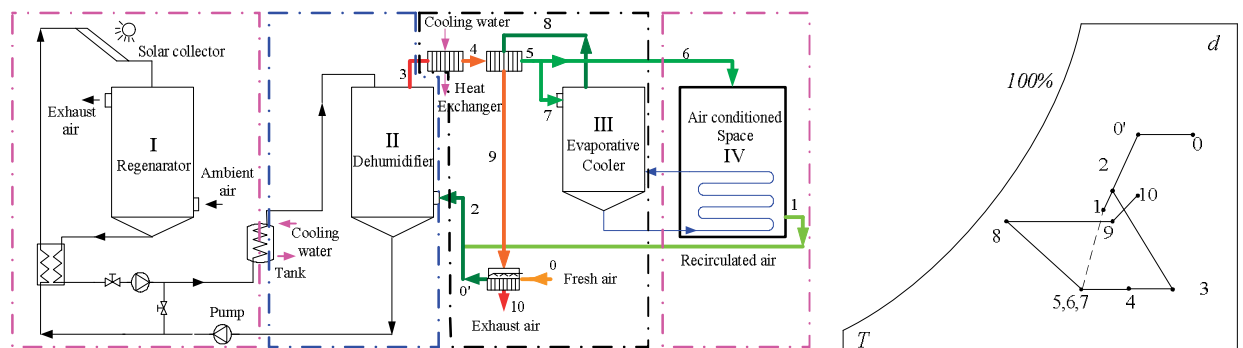

(a) System sketch (b) Air conditioning processes in psychrometric chart  
Fig.1 A new liquid desiccant dehumidification/radiant cooling system

Fig.1 (b) depicts the air conditioning processes of this new system on a psychrometric chart. Indoor air quality standard requires fresh air (state 0) being supplied to the system. The fresh air is then cooled by an indirect evaporative cooler to state 0' before it is mixed with return air (state 1) to state 2. The mixed air (state 2) enters the dehumidifier, which dries the air with reduced enthalpy to state 3. The air in state 3 is cooled naturally to state 4 with a cooling water coil, and is further cooled down to state 5 by the low-temperature air from the evaporative cooler. In succession, the air at state 5 is divided in to two parts. The part enters the evaporative cooler (state 7) absorbs moisture and cools down to state 8. The other part (state 6) enters the room to condition the room air to state

1. Finally the air at state 8 absorbs the heat from process 4 to 5 and then continues to absorb more heat from the fresh air (point 0) in combination of indirect evaporative cooling.

The new system also has some following advantages:

- (1) The system uses low-grade heat;
- (2) Due to the use of radiant cooling, the room air temperature in summer could also be higher than that in all air systems so that the cooling load would become smaller with the same comfort level;
- (3) The new system can decouple in removal sensible and latent heats, which provides flexibility for handling a large variation of sensible/latent heat ratio in the same building.

### 3. CASE SETUP AND RESEARCH METHOD

In order to demonstrate the suitability of the new system for hot and humid climate or space with high latent load, it is essential to ensure all the four units in the system are feasible. Our early studies (Yin et al., 2006; 2007) have demonstrated that the liquid desiccant (LiCl-H<sub>2</sub>O) regeneration unit and air dehumidification unit are feasible. The focus of this study was at the radiant cooling and dehumidified ventilation unit in an indoor space.

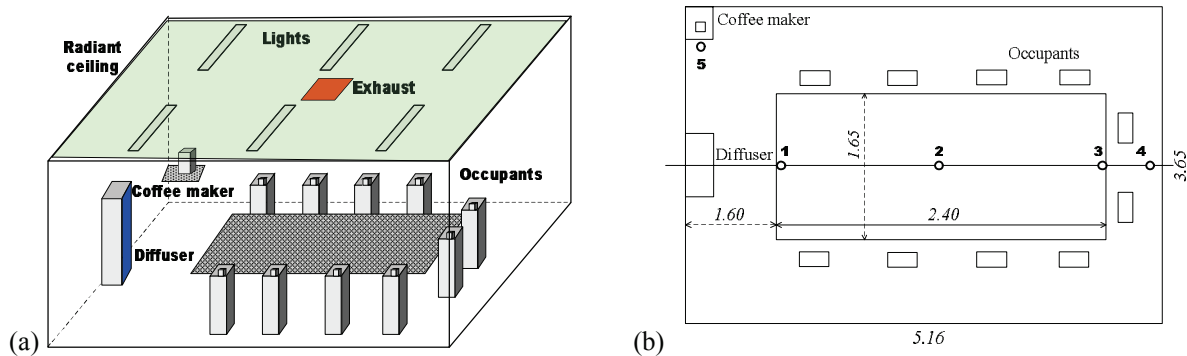

Fig.2 Conference room model for analysis: (a) conference room layout; (b) plan view of the conference room.

This study used a hypothesis conference room as shown in Fig. 2. The room dimension was 5.16 m long, 3.65 m wide and 2.43 m high with 10 occupants and a coffee maker. Each occupant produced 0.0236 g/s water vapor and the coffee maker 0.028 g/s (Novoselac and Srebric 2002). The sensible heat load in the room was from the six lights (30W each), the coffee maker (160W), the occupants (75W each) and the walls (6 W/m<sup>2</sup>). The room used displacement ventilation that supplied conditioned air through the diffuser at the floor level and exhausted air from the ceiling. The flow rate of the supply air was 188.1m<sup>3</sup>/h at 20°C (4 ACH). Radiant ceiling panels covered the entire ceiling. The radiant ceiling temperature was 18°C. Due to high occupant density and moisture generated from the coffee maker, the conference room has a very high risk of condensation in hot and humid climate. The risk is particularly severe if the conference room uses radiant cooling panels.

This study used a CFD program to determine the condensation risk because it provides very detailed distribution of moisture in the room. Since the room airflow is turbulent, the CFD program used the RNG k-ε model, and Zhang et al. (2007) found that the model was robust and accurate. The CFD program solved the following governing equation:

$$\frac{\partial}{\partial t}(\rho\phi) + \frac{\partial}{\partial x_i}(\rho u_i \phi) = \frac{\partial}{\partial x_i} \left( \Gamma_\phi \frac{\partial \phi}{\partial x_i} \right) + S_\phi \quad (1)$$

More detailed information on the CFD model could be referred to the paper from Zhang et al. (2007). Our grid refinement study found that this conference room would need 69 by 53 by 41 cells. Fig. 3 shows the grid distribution.

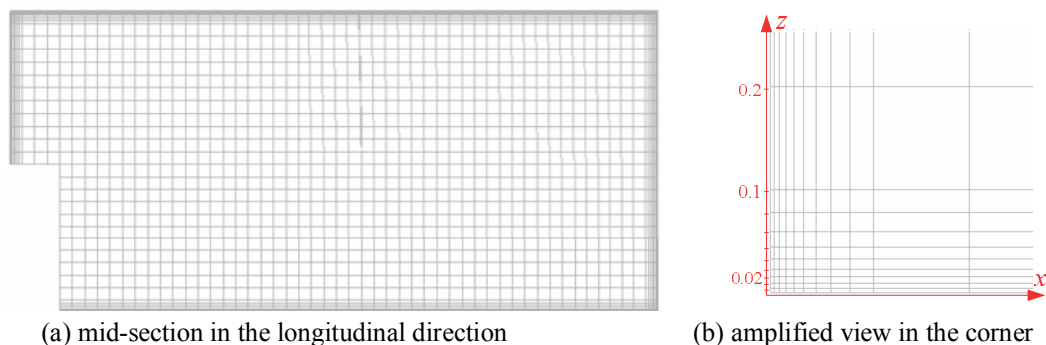

(a) mid-section in the longitudinal direction

(b) amplified view in the corner

Fig.3 Grid distribution used for the conference room

This study also used standard BS EN ISO7730 (Moderate thermal environments-determination of PMV and PPD indices) to evaluate thermal comfort. The PMV stands for Predicted Mean Vote and PPD for Predicted Percentage Dissatisfied. The PMV is a function of air temperature, environmental temperature, relative humidity, air velocity, clothing level, and metabolism. The CFD can calculate air temperature, environmental temperature, relative humidity, and air velocity for the PMV model. Loveday (2002) studied thermal comfort for sedentary workers in offices with displacement ventilation and chilled ceiling by using the PMV model and found that the model is good for such a system.

#### 4. RESULTS AND DISCUSSION

##### Condensation Risk Analysis

The new liquid desiccant dehumidification and radiant cooling system (hereafter “desiccant system”) supplies air to an indoor space with a humidity ratio as low as  $6.2 \text{ g}_v/\text{kg}_a$  for the displacement ventilation. However in conventional radiant cooling system (hereafter “conventional system”) using cooling with dehumidification, the humidity ratio of the supply air is around  $8.3 \text{ g}_v/\text{kg}_a$  in hot and humid climate, which is higher than that in the new system. The two humidity ratios have been used in our study to investigate condensation risk on the ceiling panels.

Fig.6 illustrates the relative humidity contours on the radiant ceiling panels for the conventional and desiccant systems. In the conventional system, condensation would occur on the upper-left corner of the panels since the relative humidity in the area reached 100%. The relative humidity on the panels was mostly higher than 90%, which implies a very high risk of condensation. In the desiccant system, the relative humidity on the ceiling panels was lower than 90% so that the risk of condensation was minimal. Note that the high relative humidity regions on the ceiling panels were either above the coffeemaker or above the occupants due to their thermal plumes. Fig.7 shows the thermal plumes through the section of the occupants. The results clearly conclude that the condensation risk of the desiccant system is much lower than that of the conventional system.

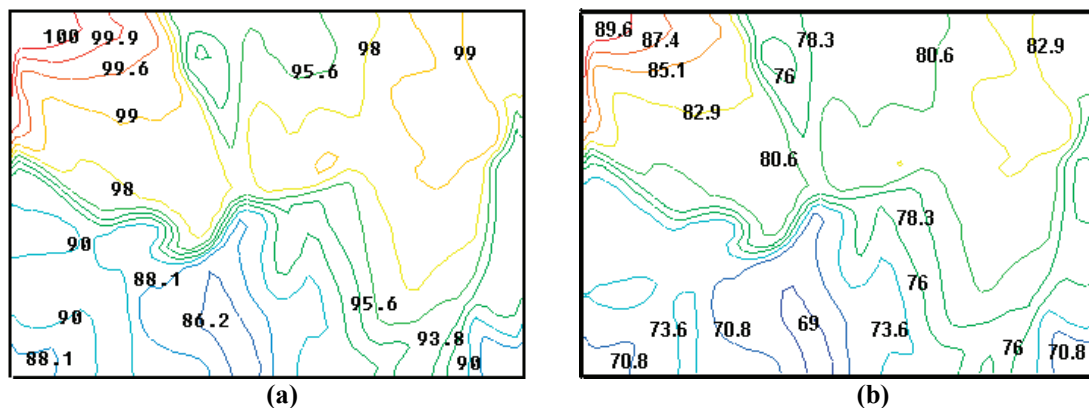

Fig.6 Relative humidity distributions on the ceiling panels: (a) Conventional system; (b) Desiccant system

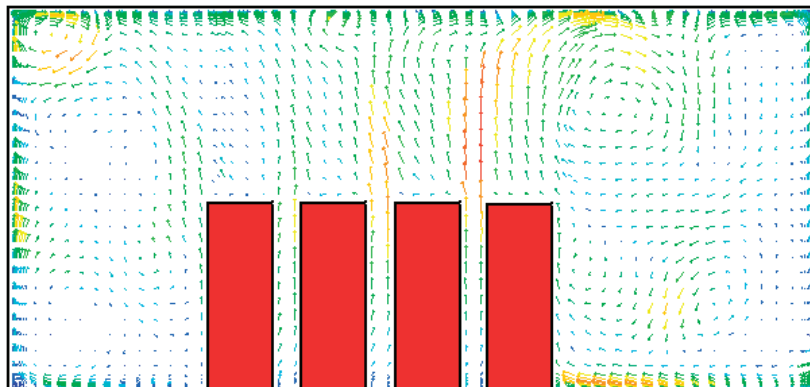

Fig.7 Thermal plumes generated by occupants in the conference room.

Fig.8 compares the humidity ratio distribution of the conventional system with that of the desiccant system at three positions indicated in Fig. 2(b). Humidity ratio in the room was about  $2 \text{ g/kg}_a$  lower because the supply air from the desiccant system was  $2.1 \text{ g/kg}_a$  drier than that from the conventional system. Pole 2 represents typical humidity ratio distribution in the room that shows a small gradient of humidity ratio in the lower part. In the upper part of the room, the humidity ratio was nearly uniform. The distribution was different from that in displacement ventilation without radiant cooling panels as measured by Yuan et al. (1999) with tracer-gas. The main reason is likely caused by the downward airflow from the ceiling panels due to negative buoyancy. The higher humidity in the mid-height at pole 3 was caused by local recirculation that brought moisture to the region. The airflow pattern in the room was very complex. Pole 5 depicts a higher humidity near the ceiling because of the thermal plume from the coffee maker.

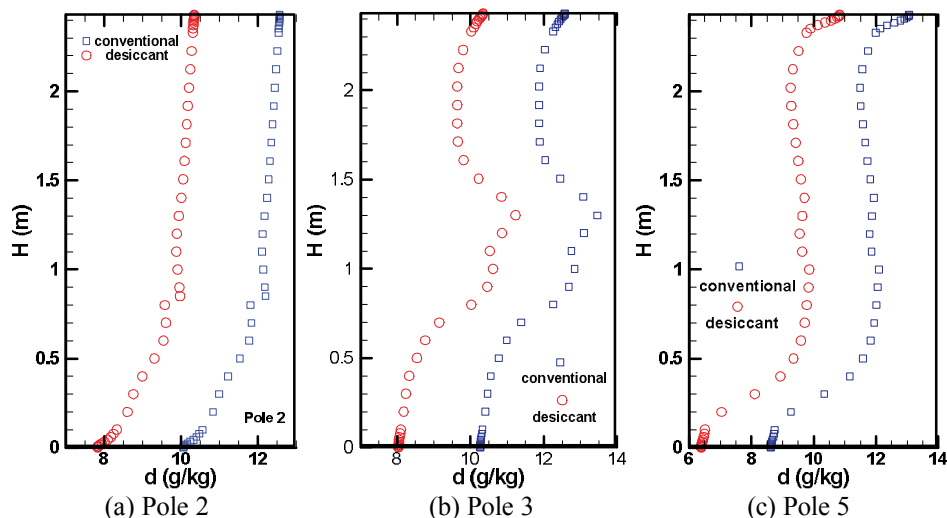

Fig.8 Vertical profiles of humidity ratio in several representative locations of the room.

### Thermal Comfort Analysis

As mentioned previously, air temperature, environmental temperature, air velocity and air humidity are important parameters to indoor thermal comfort. Also vertical gradient of air temperature around the occupants has also impact on thermal comfort (ASHRAE 2005). Fig.9 shows the vertical profiles of air temperature at those representative locations in the conference room. This study controlled the average air temperature in the room to be  $25^\circ\text{C}$ . Both the desiccant and conventional systems had a vertical temperature gradient in the lower part of the room. The temperature gradient in the occupied zone was less than  $2^\circ\text{C/m}$ , which was within the limit for thermal comfort. The upper part appeared to be well mixed due to the strong convection from the thermal plumes from the coffee maker and the occupants and the downward flow from the radiant panels.

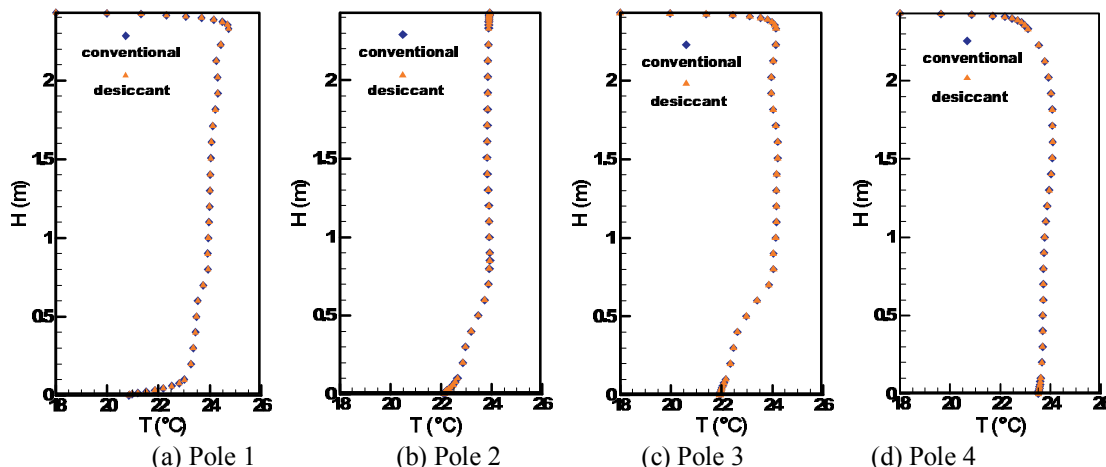

Fig.9 Vertical profiles of air temperature in several representative locations of the room.

Fig.10 shows the relative humidity profiles in the conference room. The relative humidity in the room for the conventional system varied from 60% to 70%, while that for the desiccant system from 50% to 60%. In hot and humid climates, the 10% difference offers a significant benefit in removing excessive humidity. The exhaust relative humidity in the desiccant system is 55%, but 70% in the conventional system.

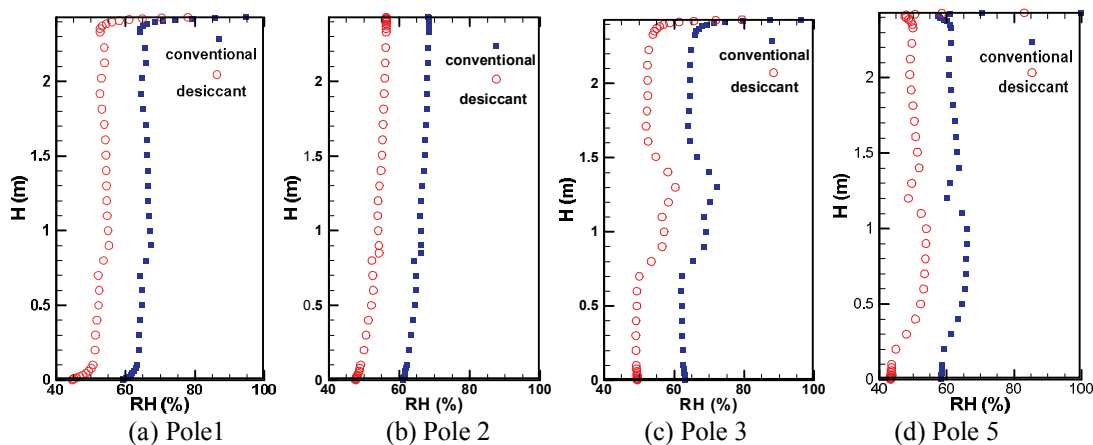

Fig.10 Vertical profiles of relative humidity in several representative locations of the room.

Fig.11 shows vertical profiles of airflow velocity in the room. Since humidity played little role in air distribution, the airflows in the two systems were identical. Near the ceiling panel, the air velocity was generally higher due to downward flow from the ceiling panel and also due to impinging of the thermal plumes from the coffee maker and the occupants. The high velocity near the floor in poles 1 and 2 was caused by the flow from the diffuser. Nonetheless, the air velocity in the occupied zone was lower than 0.1 m/s so that draft should not be a concern.

With the air temperature, environmental temperature, air velocity, relative humidity, and the assumed clothing level of 0.8 clo and metabolism of 1.2 Met, this investigation used the PMV model to calculate the thermal comfort level in the room. Fig.12 illustrates the PMV values at 1.1 m above the floor in the five poles in the room. In the occupants area (pole 1 through 3), better thermal comfort is showed in the new desiccant system since PMVs at pole 1 to 3 seem close to zero, which is on account of low humidity air supply by the new system. At pole 4, it feels a bit cool because of the downward airflow from the cooled ceiling, where higher air velocity is illustrated in Fig.11. Therefore, appropriate design and operation parameters are significant to gain good thermal comfort for the new system. Pole 5 is very close to the coffee maker, which means that there is high temperature and humidity at that location, and therefore pole 5 shows very high PMV and indicates worst thermal comfort.

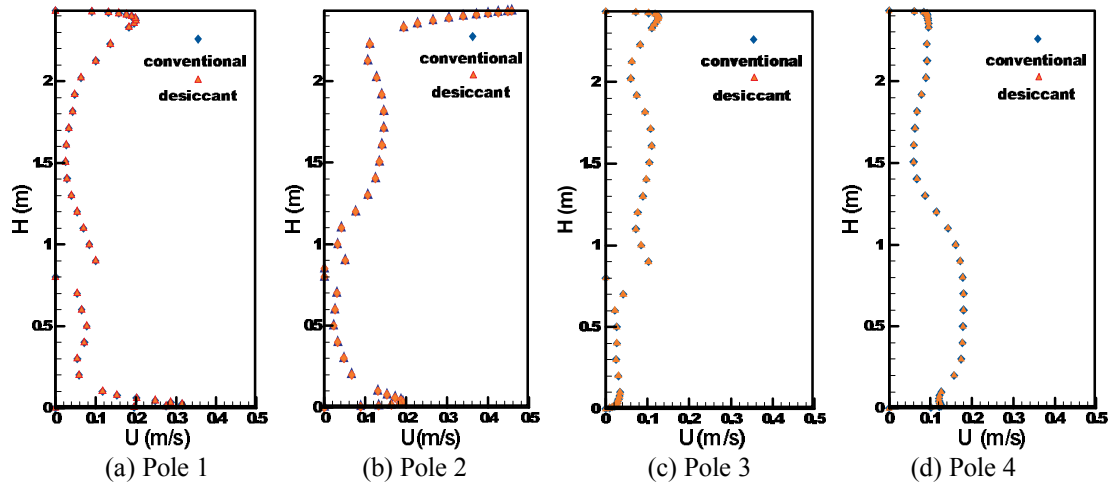

Fig.11 Vertical profiles of air velocity in several representative locations of the room.

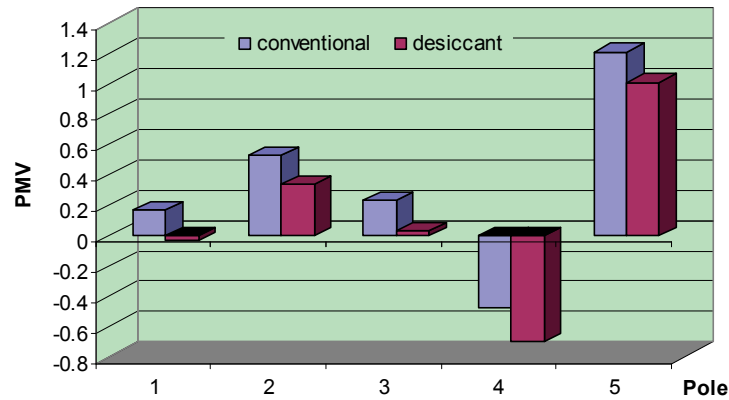

Fig.12 PMV at 1.1 m above the floor in the five locations in the room

## 5. CONCLUSIONS

This study presented a new ventilation system with radiant cooling by using liquid desiccant dehumidification. The new system, which uses a low-grade heat source like solar energy, provides both very dry air for the ventilation and cooled water for the radiant cooling. The system does not require a water chiller and demands less electricity, compared with a conventional system using a water chiller.

The new system can reduce the risk of condensation in air-conditioned spaces with high latent load, such as auditoria. The system also creates a slightly better thermal comfort level compared with a conventional system. Thus, the new system could be better for hot and humid climate regions.

## NOMENCLATURE

C	concentration	U	velocity
d	absolute humidity	$u_i$	velocity component in i direction
H	height	$x, y$	Cartesian coordinates
RH	relative humidity	Z	dimensionless height
$S_\phi$	source	<b>Greek Symbols</b>	
T	temperature	$\Gamma_\phi$	effective diffusion coefficient
t	time	$\rho$	air density
		$\Phi$	a general variable in Equation 1



## REFERENCES

- Ameen, A., Mahmud, K., 2005, Desiccant dehumidification with hydronic radiant cooling system for air-conditioning applications in humid tropic climates, *ASHRAE Transactions*, vol. 111, no. 2: p225-237.
- ASHRAE, 2005, ASHRAE Handbook, Chapter 8.
- Behne, M., 1999, Indoor air quality in rooms with cooled ceilings. Mixing ventilation or rather displacement? *Energy and Buildings*, vol. 30, no. 2: p155-166.
- Feustel, H.E., Stetiu, C., 1995, Hydronic radiant cooling-preliminary assessment, *Energy and Buildings*, vol. 22, no. 3: p193-205.
- Givoni, B., 1991, Performance and applicability of passive and low-energy cooling systems, *Energy and Buildings*, vol. 17, no. 3: p177-199.
- Hao, X., Zhang, G., Chen, Y., Zou, S., Moschandreas, D., 2007, A combined system of chilled ceiling, displacement ventilation and desiccant dehumidification, *Building and Environment*, vol. 42: p3298-3308.
- IEA Annex 35, 1998, Hybrid ventilation in new and retrofitted office and educational buildings, *Annex Text, International Energy Agency*.
- Imanari, T., Omori, T., Bogaki, K., 1999, Thermal comfort and energy consumption of the radiant ceiling panel system: comparison with the conventional all-air system, *Energy and Buildings*, vol. 30, no. 2: p167-175.
- Li, Z., Chen, W., Deng, S.M., Lin, Z., 2006, The characteristics of space cooling load and indoor humidity control for residences in the subtropics, *Building and Environment*, vol. 41, no. 9: p1137-1147.
- Loveday, D.L., Parsons, K.C., Taki, A.H., Hodder, S.G., 2002, Displacement ventilation environments with chilled ceilings: thermal comfort design within the context of the BS EN ISO 7730 versus adaptive debate, *Energy and Buildings*, vol. 34, no. 6: p573-579.
- Niu, J.L., 1994, Modelling of cooled-ceiling air-conditioning systems-Influences on indoor environment and energy consumption, *Ph.D. thesis, Delft University of Technology*, Netherland. ISBN 90-370-0105-X.
- Niu, J.L., Zhang, L.Z., Zuo, H., 2002, Energy savings potential of chilled-ceiling combined with desiccant cooling in hot and humid climates, *Energy and Buildings*, vol. 34, no. 5: p487-495.
- Novoselac, A., Srebric, J., 2002, A critical review on the performance and design of combined cooled ceiling and displacement ventilation systems, *Energy and Buildings*, vol. 34, no. 5: p497-509.
- Sodec, F., 1999, Economic viability of cooling ceiling systems, *Energy and Buildings*, vol. 30, no. 2: p195-201.
- Srebric, J., Chen, Q., 2002, An example of verification, validation, and reporting of Indoor environment CFD analyses, *ASHRAE Transactions*, vol. 108, no.2, 4569(RP-1133).
- Tsay, Y., Kato, S., Ooka, R., 2006, Study on applicability of combining a desiccant cooling system with a heat pump in a hot and humid climate, *ASHRAE Transactions*, vol. 112, no. 1: p189-194.
- Vangtook, P., Chirarattananon, S., 2006, An experimental investigation of application of radiant cooling in hot humid climate, *Energy and Buildings*, vol. 38, no. 4: p273-285.
- Yin, Y., Zhang, X., Jiang, Y., 2006, Construction and research on a refrigeration system based on liquid desiccant potential discharging, *Chinese Journal of Refrigeration*, vol. 27, no. 5: p26-30.
- Yin, Y., Zhang, X., Chen, Z., 2007, Experimental study on dehumidifier and regenerator of liquid desiccant cooling air conditioning system, *Building and Environment*, vol.42, no. 7: p2505-2511.
- Yin, Y., Zhang, X., 2008, A new method for determining coupled heat and mass transfer coefficients between air and liquid desiccant, *Int. J. Heat Mass Transfer*, doi: 10.1016/j.ijheatmasstransfer.2007.11.040.
- Yuan, X., Chen, Q., Glicksman, L., Hu, Y., Yang, X., 1999, Measurements and computations of room airflow with displacement ventilation, *ASHRAE Transactions*, vol. 105, no. 1: p340-352.
- Zhang, L.Z., Niu, J.L., 2003, Indoor humidity behaviors associated with decoupled cooling in hot and humid climates, *Building and Environment*, vol.38, no.1: p99-107.
- Zhang, Z., Zhang, W., Zhai Z., Chen, Q., 2007, Evaluation of various turbulence models in predicting airflow and turbulence in enclosed environments by CFD: Part 2 - Comparison with experimental data from literature, *HVAC&R Research*, vol. 13, no. 6: p871-886.

## ACKNOWLEDGEMENT

This research was supported by China Scholarship Council, National Natural Science Foundation of China (Grant No.50676018), and the Foundation for Excellent Doctoral Dissertation of the Southeast University in China.