



Summer School

Sustainability: a new field related to RES

(Efforts of research and didactics in Apulia region)

© Prof. Ing. Michele DASSISTI

Politecnico di Bari – DMMM – V.le Japigia 182 – 70126 BARI
Tel. 080 – 596.2747; fax 080-5962.788; mobile: 329 650 6022; m.dassisti@poliba.it

Prof. Ing. Michele Dassisti



July 2, 2013
T.E.I. of Patras



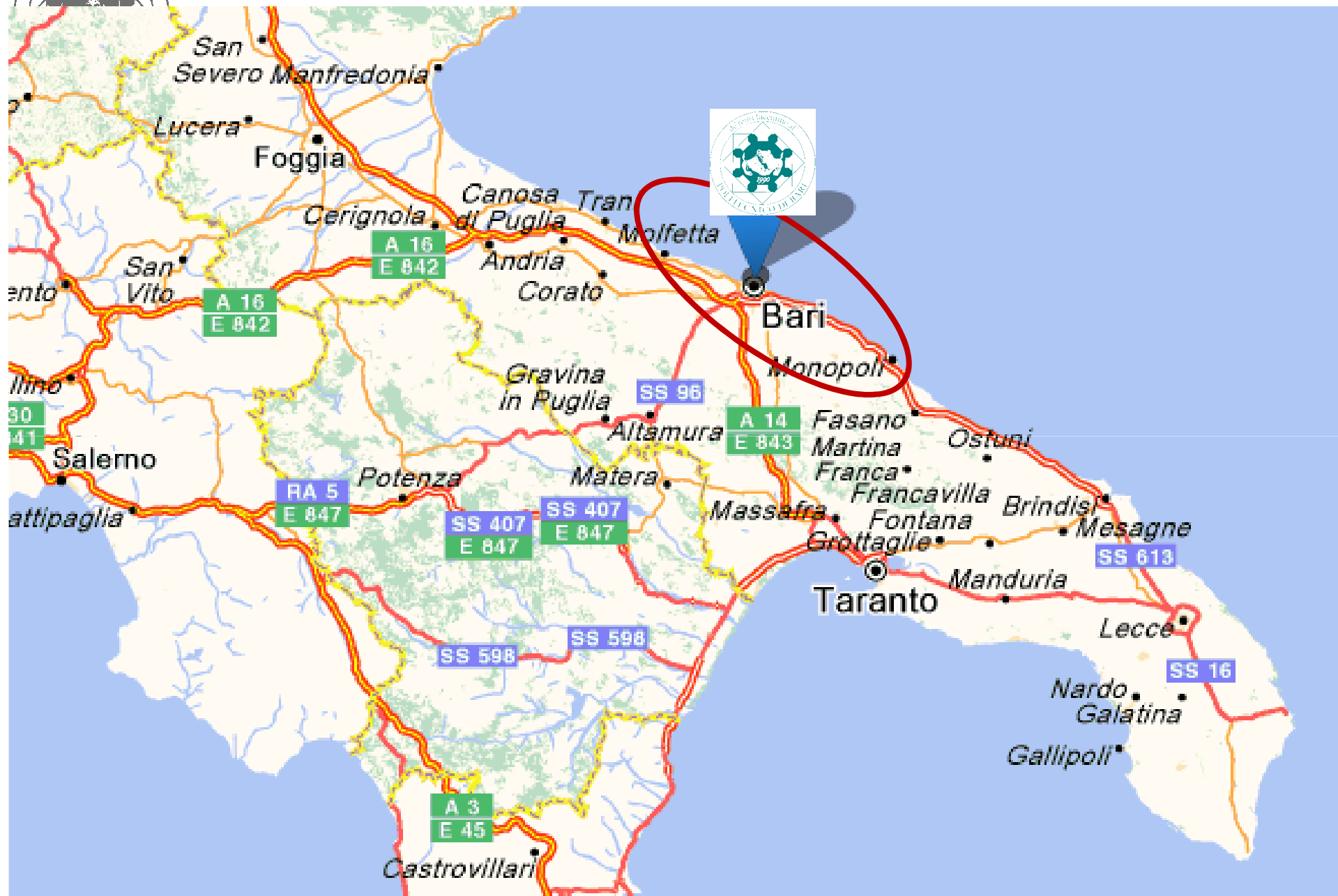

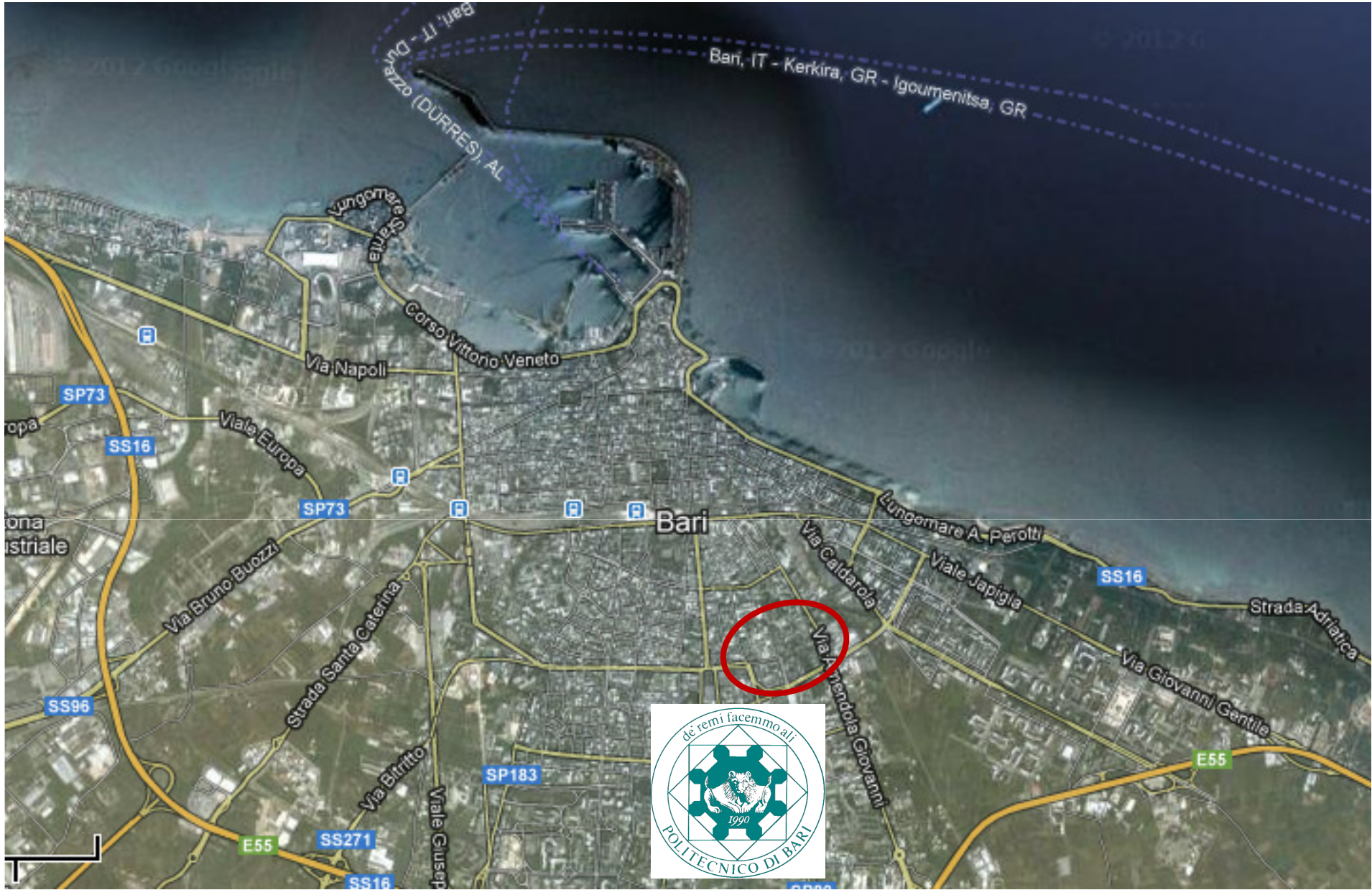



5 Departments,
- 3 for Engineering fields
- one for Architecture
- one Physics
32 Courses (3 and 5 ys)
several Masters and PhD.

Around 12.500 undergraduate and postgraduate students
132 researchers
84 professors
304 members as administrative services.



© Prof. Ing. Michele DASSISTI

Politecnico di Bari – DMMM – V.le Japigia 182 – 70126 BARI
Tel. 080 – 596.2747; fax 080-5962.788; mobile: 329 650 6022; m.dassisti@poliba.it

Firefox Welcome to HyChange-Lab

http://hychange-lab.poliba.it/

AVIRA POLIBA_mail PolIBA MIUR CINECA CASPUR_biblio Borsa della Ricerca CLIMEG Google EN-IT EN-DE FR_IT MAM Wetter CSA Bookmarks

HyChange-Lab

MAIN MENU

- Home
- Research
- Projects
- VLab
- QLab
- Velante
- Events

Welcome to HyChange-Lab

HyChange-Lab

HyChange-Lab model ©

**Welcome to the Hybrid-Change Laboratory for
Continuous Process Improvement & Innovation of manufacturing processes**

SCIENTIFIC RESPONSIBLE: Michele DASSISTI

THE SCOPE: Hy-change lab born from an idea of Michele DASSISTI to spread the culture of continuous improvement and innovation (CI&I) throughout manufacturing enterprises. Deriving from his long-lasting experience on applied research in a number of manufacturing companies, Michele DASSISTI decided to affiliate experts and aggregate initiatives within the common umbrella of a net-laboratory.

HyChange -Lab is thus an evolving reality of ideas and experiences with the same aim of promoting sustainability in manufacturing by CI&I.

All the activities will be encompassed in three main directions: Education, research and external services: have a look through the web-site!

STRUCTURE: a network of people and laboratories Q-Lab; V-LAB; VELANTE;

WHO'S ONLINE

We have 1 guest online



Rationale

© Prof. Ing. Michele DASSISTI

Politecnico di Bari – DMMM – V.le Japigia 182 – 70126 BARI
Tel. 080 – 596.2747; fax 080-5962.788; mobile: 329 650 6022; m.dassisti@poliba.it

- I. WHAT**
- II. WHY**
- III. WHO**
- IV. WHERE**
- V. HOW (1- 10)**
- VI. WHEN**
- VII. CONCLUSION**



© Prof. Ing. Michele DASSISTI

Politecnico di Bari – DMMM – V.le Japigia 182 – 70126 BARI

Tel. 080 – 596.2747; fax 080-5962.788; mobile: 329 650 6022; m.dassisti@poliba.it

WHAT



The problem....

© Prof. Ing. Michele DASSISTI

Politecnico di Bari – DMMM – V.le Japigia 182 – 70126 BARI

Tel. 080 – 596.2747; fax 080-5962.788; mobile: 329 650 6022; m.dassisti@poliba.it



<http://www.clubofrome.org/eng/home/>

<<If the actual line of development continues unchanged ..., humanity is destined to reach the natural limits of development within the next 100 years.-The application of technological solutions can extend the period of industrial development/growth and of demographic increase, but cannot eliminate the fundamental limits of development.>> Club of Rome, 1972



Sustainability struggle: tangible signs

© Prof. Ing. Michele DASSISTI

Politecnico di Bari – DMMM – V.le Japigia 182 – 70126 BARI
Tel. 080 – 596.2747; fax 080-5962.788; mobile: 329 650 6022; m.dassisti@poliba.it

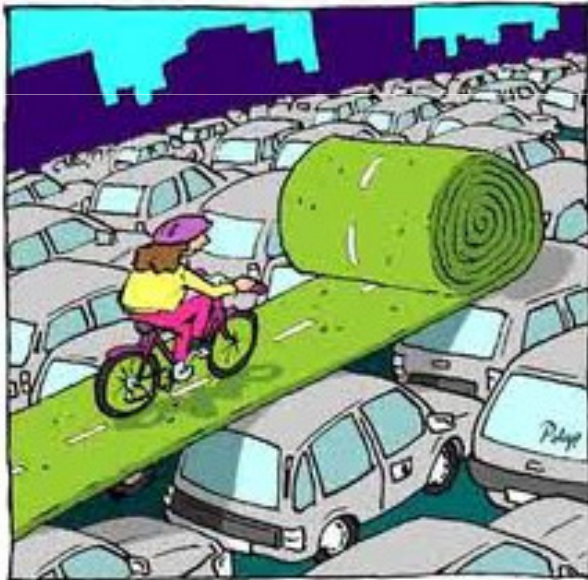

Climate changes



- Crisis of complex systems



SUSTAINABILITY: too general level

- <<Development that meets the needs of the present without compromising the ability of future generations to meet their own needs>>
[the Brundtland Commission, 1987]

© Prof. Ing. Michele DASSISTI

Politecnico di Bari – DMMM – V.le Japigia 182 – 70126 BARI

Tel. 080 – 596.2747; fax 080-5962.788; mobile: 329 650 6022; m.dassisti@poliba.it



*It is just a matter of
RESOURCES??*





Sustainability

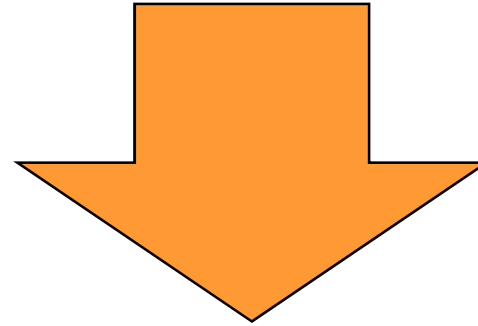

*SUSTAINABILITY WAS ADOPTED BY UNEP IN
RIO DE JANEIRO (1992) AS THE MAIN
POLITICAL GOAL FOR THE FUTURE
DEVELOPMENT OF HUMANKIND.*

*IT SHOULD ALSO BE THE ULTIMATE AIM OF
PRODUCT DEVELOPMENT.*

“The beauty in our inability to define it means that we cannot prescribe it.” [Fricker,1998]

© Prof. Ing. Michele DASSISTI
Politecnico di Bari – DMMM – V.le Japigia 182 – 70126 BARI
Tel. 080 – 596.2747; fax 080-5962.788; mobile: 329 650 6022; m.dassisti@poliba.it

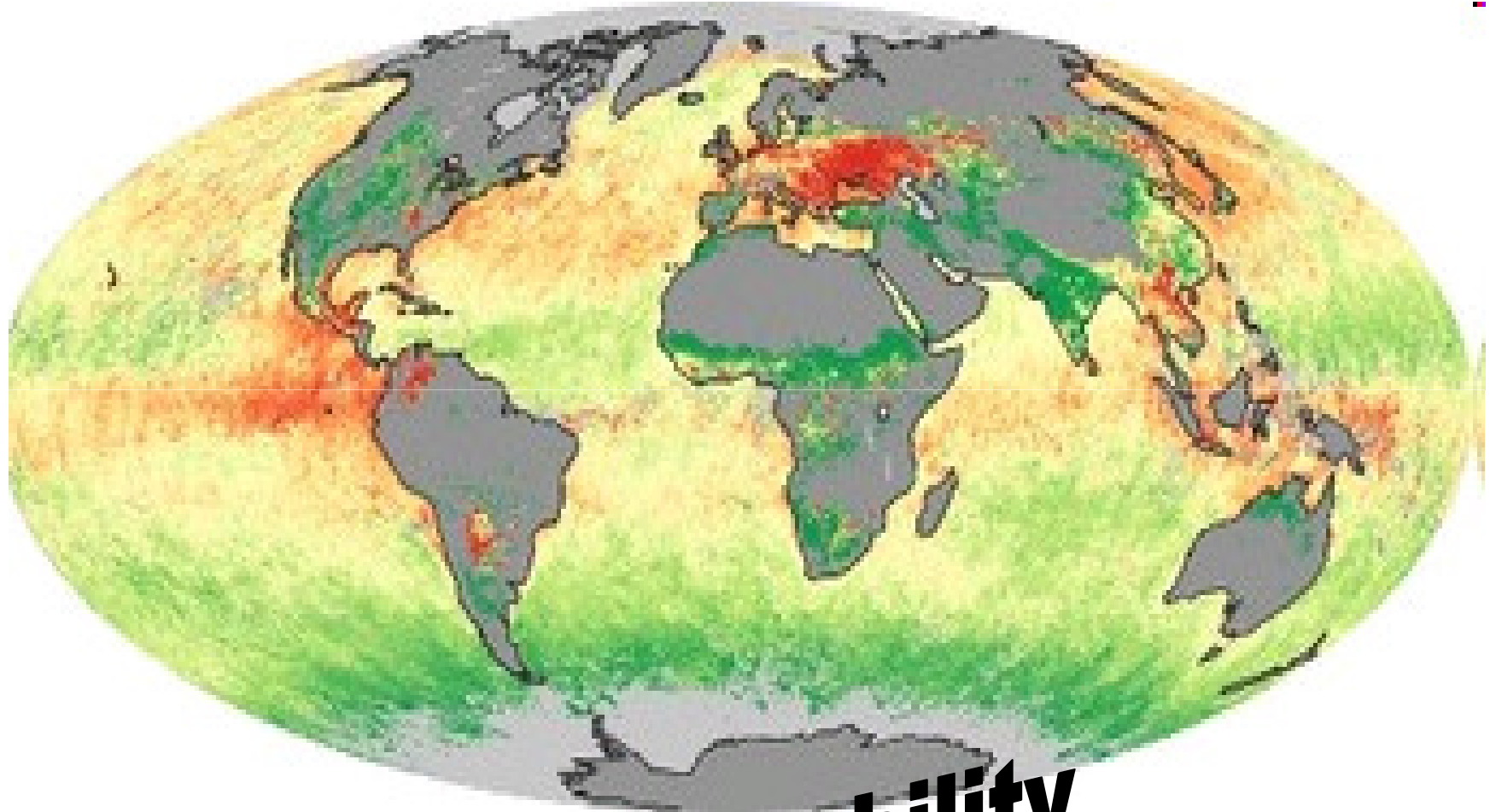

Sustainability

THE SWIMMING FROG.....



(-)



Tiniest Vertebrate On Earth *Paedophryne amauensis* is the smallest vertebrate, discovered in a village in Papua New Guinea. Adults are just 7.0 to 8.0 millimeters. [Click here to embiggen the photo.](#) Rittmeyer EN, Allison A, Grundler MC, Thompson DK, Austin CC/PLoS ONE

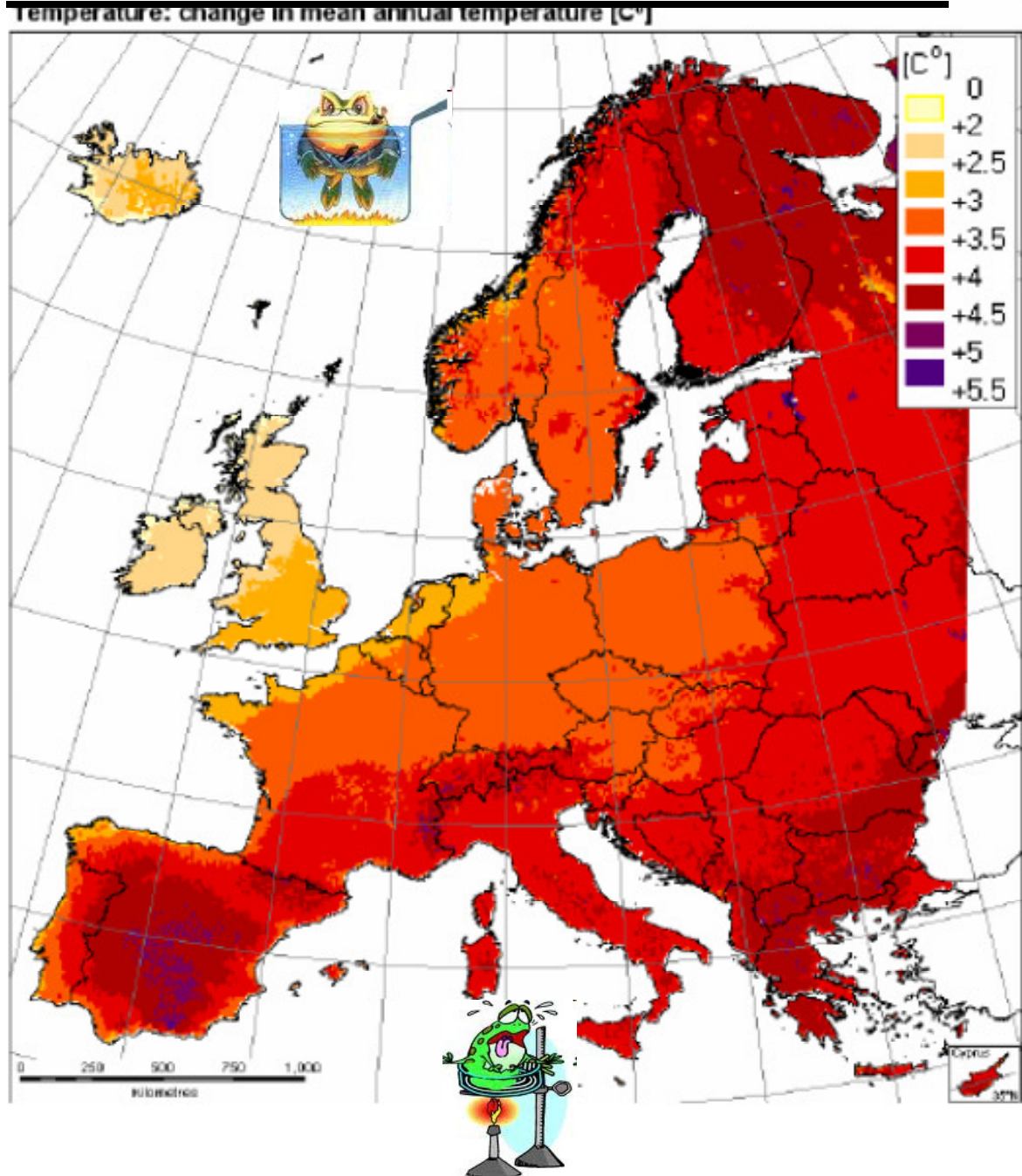



The three pillars of sustainability

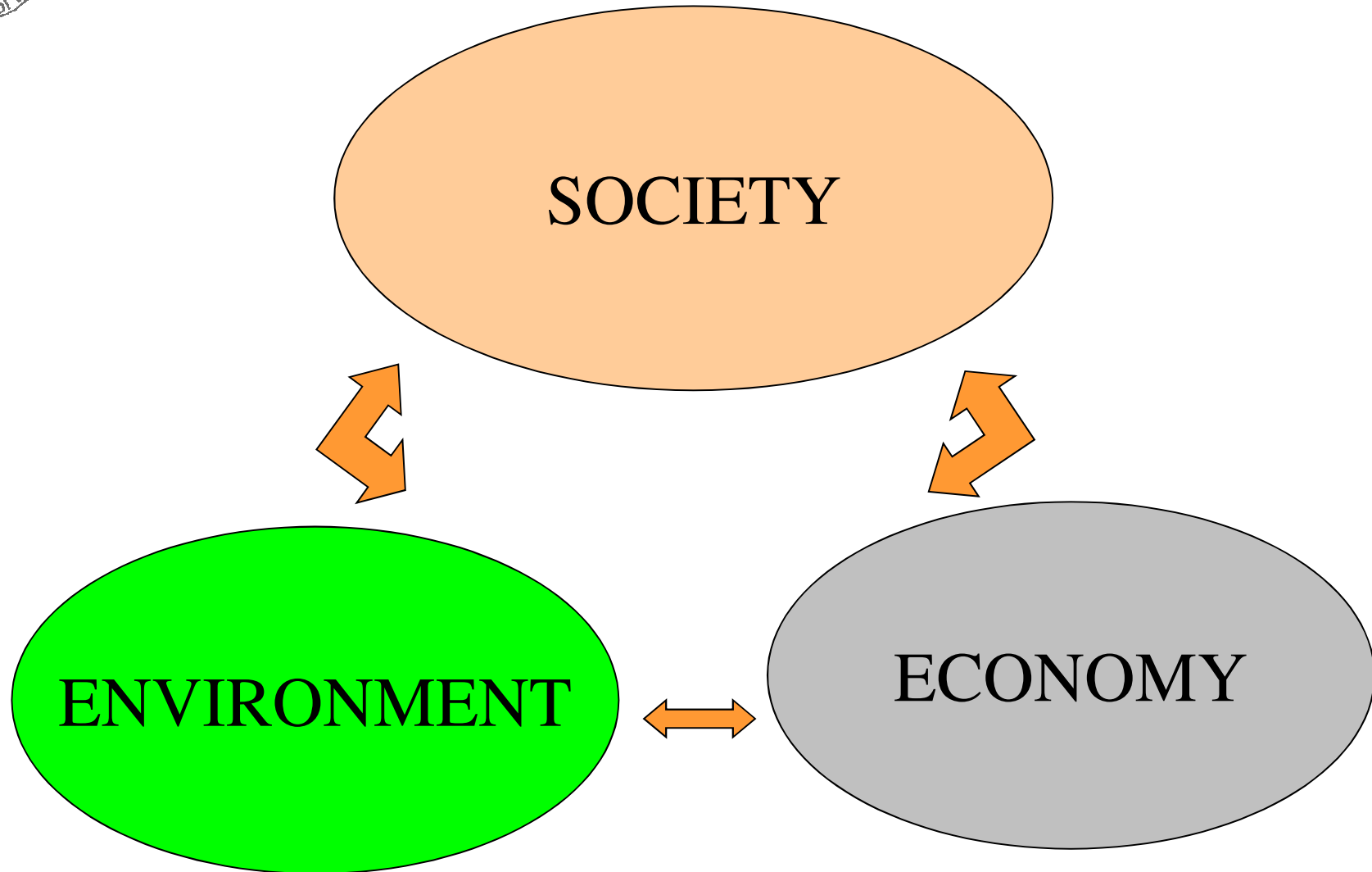

© Prof. Ing. Michele DASSISTI

Politecnico di Bari – DMMM – V.le Japigia 182 – 70126 BARI

Tel. 080 – 596.2747; fax 080-5962.788; mobile: 329 650 6022; m.dassisti@poliba.it

“The triple bottom line”



© Prof. Ing. Michele DASSISTI

Politecnico di Bari – DMMM – V.le Japigia 182 – 70126 BARI

Tel. 080 – 596.2747; fax 080-5962.788; mobile: 329 650 6022; m.dassisti@poliba.it

WHY



Finitedness of resources

© Prof. Ing. Michele DASSISTI

Politecnico di Bari – DMMM – V.le Japigia 182 – 70126 BARI

Tel. 080 – 596.2747; fax 080-5962.788; mobile: 329 650 6022; m.dassisti@poliba.it

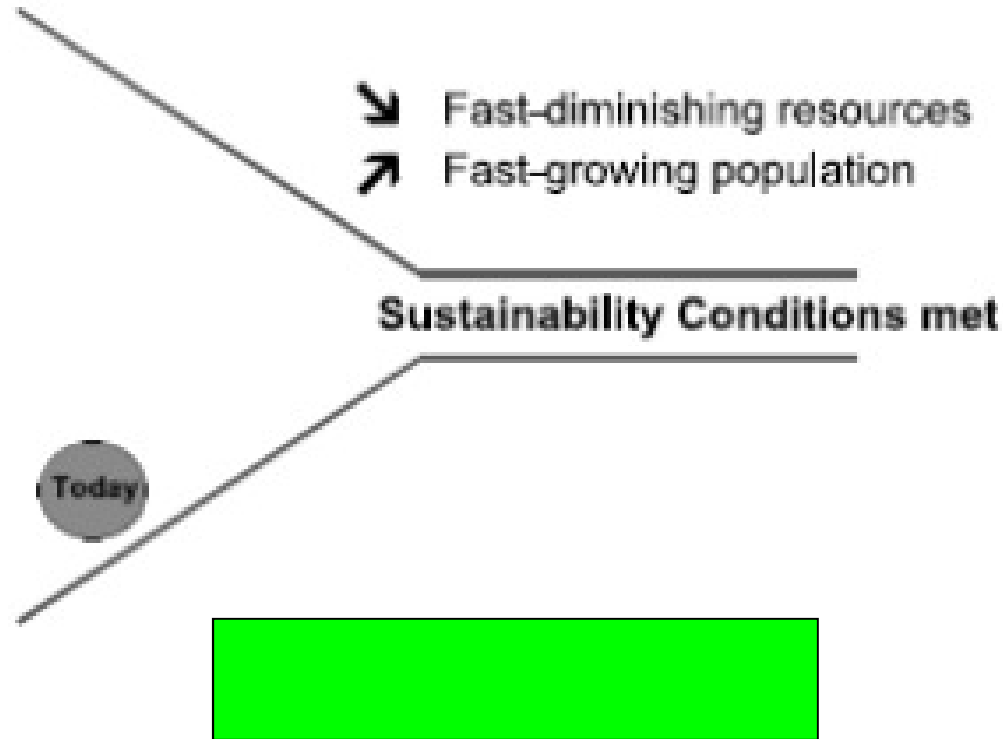



Some digit...

1900

POPULATION:
c.a. 1500 Million

2000

POPULATION:
c.a. 6600 Million

- ❑ ENERGY: 6 barrels/day
- ❑ METALS: 20Mton
- ❑ PAPER: 4 Mton
- ❑ PLASTICS: ----
- ❑ CHEMICALS El.: 20

- ❑ ENERGY: 80.000.000 barrels/day
- ❑ METALS: 1200Mton
- ❑ PAPER: 160 Mton
- ❑ PLASTICS: 160 Mton
- ❑ CHEMICAL: all (92)



Finitedness of resources

© Prof. Ing. Michele DASSISTI

Politecnico di Bari – DMMM – V.le Japigia 182 – 70126 BARI

Tel. 080 – 596.2747; fax 080-5962.788; mobile: 329 650 6022; m.dassisti@poliba.it

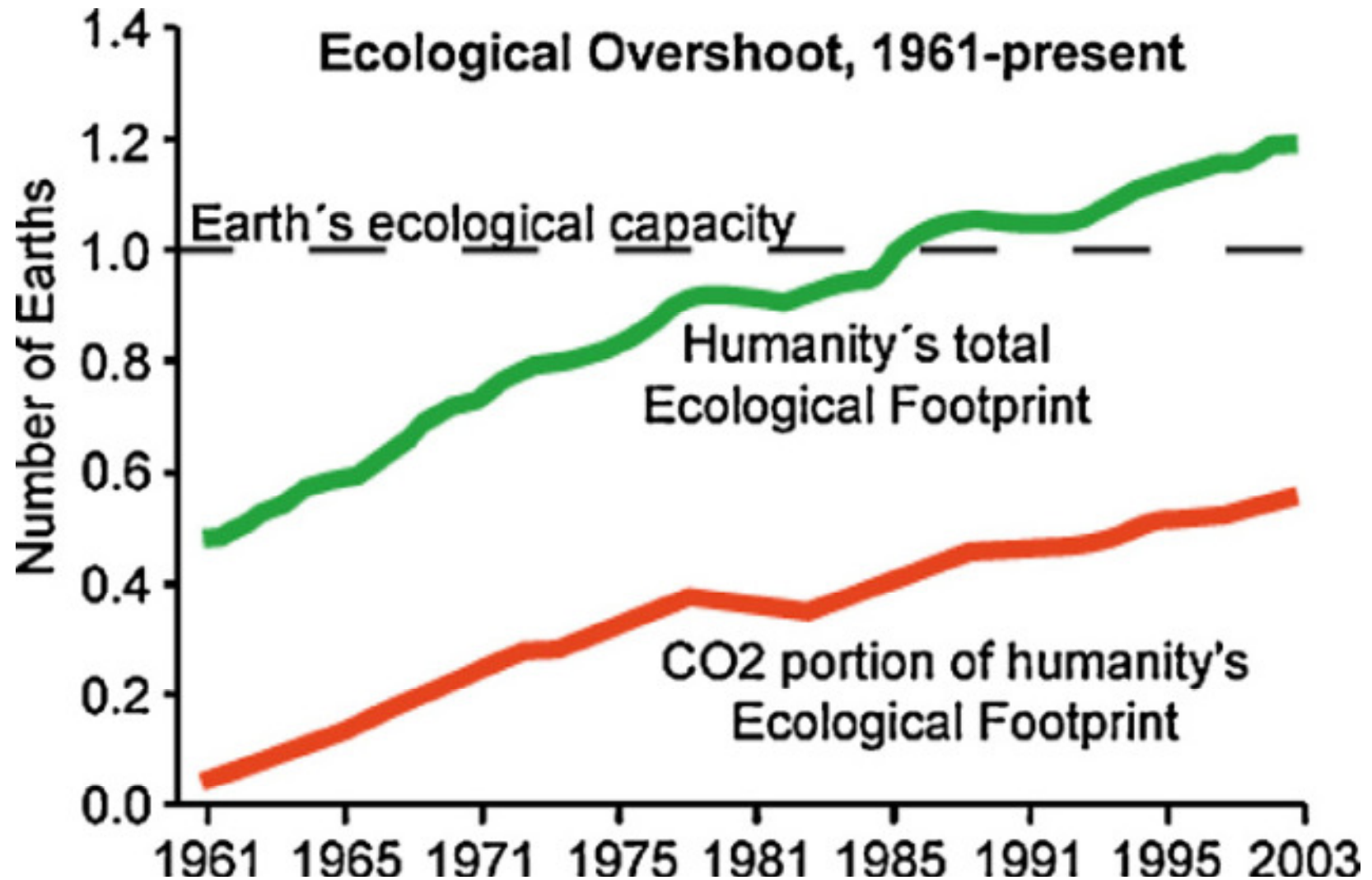



Earth's digit...

© Prof. Ing. Michele DASSISTI

Politecnico di Bari – DMMM – V.le Japigia 182 – 70126 BARI

Tel. 080 – 596.2747; fax 080-5962.788; mobile: 329 650 6022; m.dassisti@poliba.it

Date	End of element	End of element
2012	End of terbium	2040 End of uranium
2018	End of hafnium	2048 End of nickel
2021	End of silver	2050 End of oil
2022	End of antimony	2064 End of platinum
2023	End of palladium	2072 End of natural gas
2025	End of gold	2087 End of iron
2028	End of tin	2120 End of cobalt
2030	End of lead	2139 End of aluminium
2038	End of tantalum	2158 End of coal
2039	End of copper	



It is threatened of disappearance.



As copper !



As zinc and other metals.



Panta rei....

© Prof. Ing. Michele DASSISTI

Politecnico di Bari – DMMM – V.le Japigia 182 – 70126 BARI

Tel. 080 – 596.2747; fax 080-5962.788; mobile: 329 650 6022; m.dassisti@poliba.it

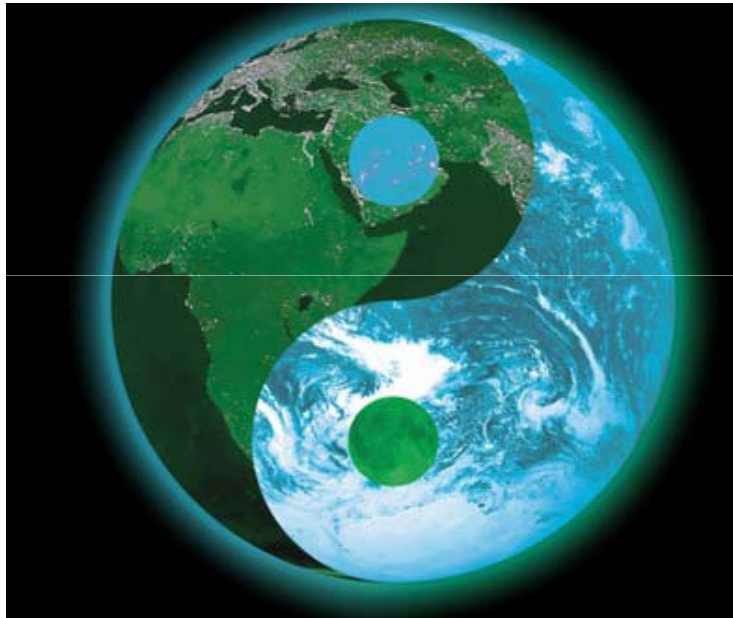

“World changes while we walk in it.

Man experiments big upsetting of his life”

(R. Oppenheimer)

WE ARE THE INTERESTED OBSERVER OF THE EVOLUTION OF OUR EARTH



A philosophical matter: equilibrium.....

- The concept of “sustain-ability” implies the concept of “ability to sustain” a status of a system: let’s call it a (status of) equilibrium thus means to have a reference point of observation, an interested observer with respect to whom all concepts will hold

- *«United Nations Brundtland Commission called for sustainable development, ‘that which meets all the needs of the present ...’» Appleton, 2006*



Sustainability vs Growth?!

- <<The concept of environmental sustainability presents a major challenge to the “growth paradigm” of contemporary industrial culture. It is a concept fundamentally rooted in ethics and philosophy, but one which has strong technological ramifications >>[Pacham,2009]

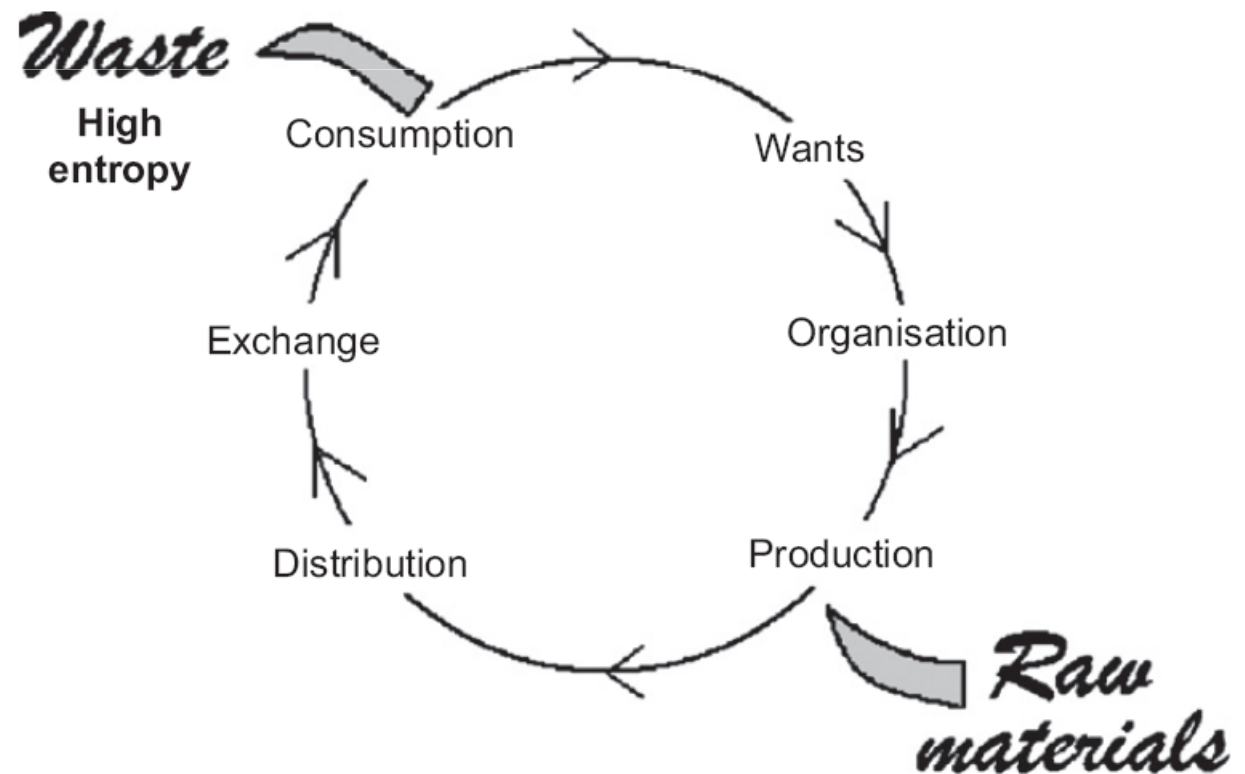



© Prof. Ing. Michele DASSISTI

Politecnico di Bari – DMMM – V.le Japigia 182 – 70126 BARI

Tel. 080 – 596.2747; fax 080-5962.788; mobile: 329 650 6022; m.dassisti@poliba.it

WHO



The three challenges for enterprises

© Prof. Ing. Michele DASSISTI

Politecnico di Bari – DMMM – V.le Japigia 182 – 70126 BARI

Tel. 080 – 596.2747; fax 080-5962.788; mobile: 329 650 6022; m.dassisti@poliba.it

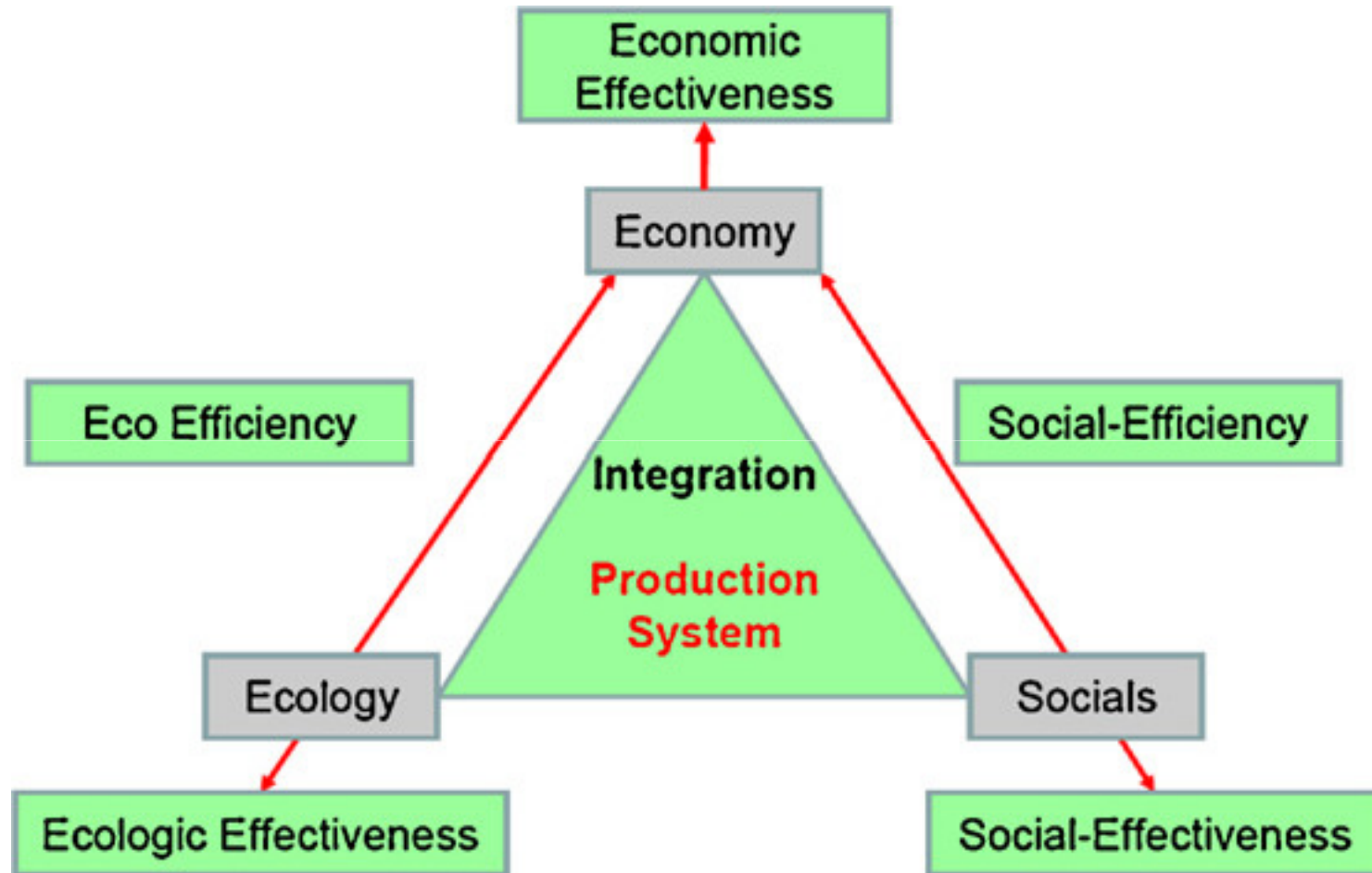



TOWARD WHAT?

- Paradox: how can we (mankind) define the right direction if we are the same actor in the system we are trying to measure?
- What means “the right direction” for influencing the future equilibrium state?
 - PRESERVATION SEEMS TO BE
THE ONLY REASONABLE ANSWER UP TO NOW

ele DASSISTI

i – DMMM – V.le Japigia 182 – 70126 BARI
47; fax 080-5962.788; mobile: 329 650 6022; m.dassisti@poliba.it

• *« Now the phrase ‘the environment’ evokes in the mind of any reasonably informed person a panoply of images and adjective references such as the environmental movement, environmental issues, the environmental crisis, etc. And in hearing it, that same person will recognize that these terms are evoking something that intrinsically affects the shape of his or her life... »* Appleton, 2006



Stakeholder's responsibility

Are all the needs necessary?

© Prof. Ing. Michele DASSISTI
Politecnico di Bari – DMMM – V.le Japigia 182 – 70126 BARI
Tel. 080 – 596.2747; fax 080-5962.788; mobile: 329 650 6022; m.dassisti@poliba.it

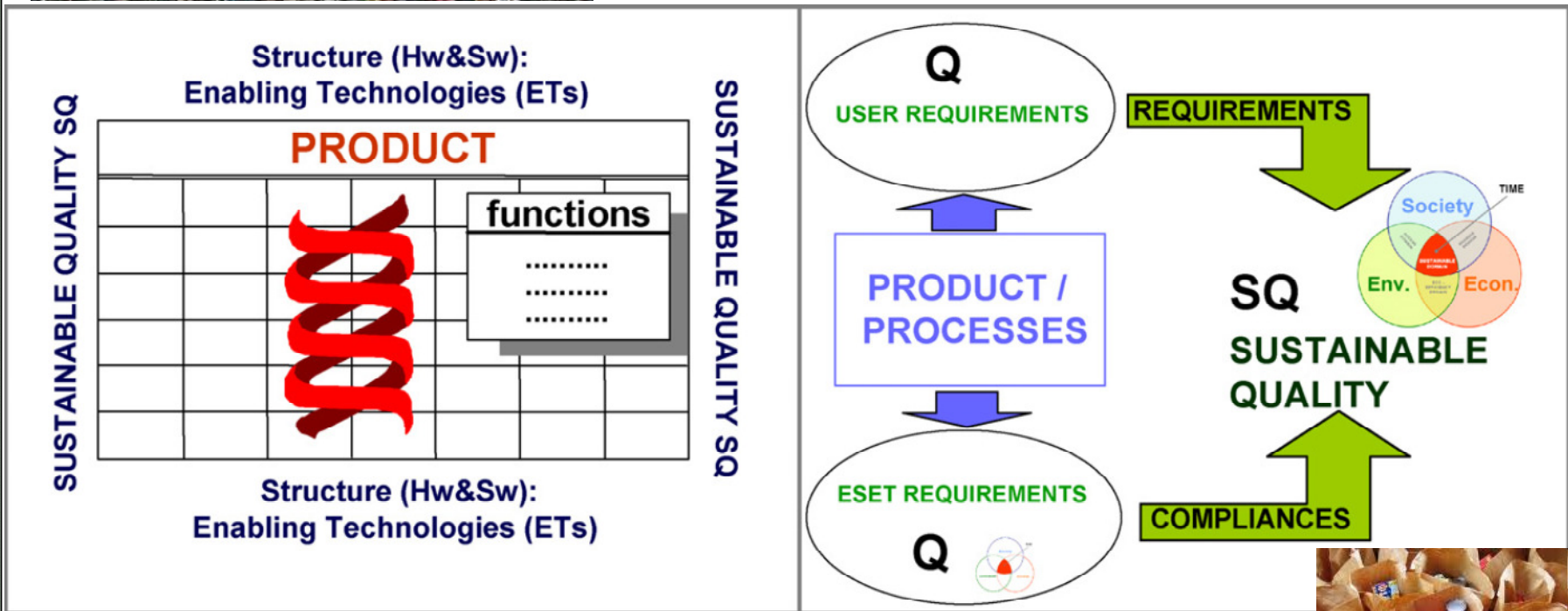

FUNCTION:
the capability to satisfy needs





Sustainability and growth....

Development Paradigms Matrix

	Economic growth	Economic development	Sustainable development	Sustainable Growth
ECONOMY				
SOCIETY				
ENVIRONMENT				
TECHNOLOGY				



© Prof. Ing. Michele DASSISTI
 Politecnico di Bari – DMMM – V.le Japigia 182 – 70126 BARI
 Tel. 080 – 596.2747; fax 080-5962.788; mobile: 329 650 6022; m.dassisti@poliba.it

“sustainable development is a process of change in which the exploitation of resources, the direction of investments, the orientation of technological development, and institutional change are made consistent with the future as well as present needs”.



Open mind to a different view...

© Prof. Ing. Michele DASSISTI
 Politecnico di Bari – DMMM – V.le Japigia 182 – 70126 BARI
 Tel. 080 – 596.2747; fax 080-5962.788; mobile: 329 650 6022; m.dassisti@poliba.it

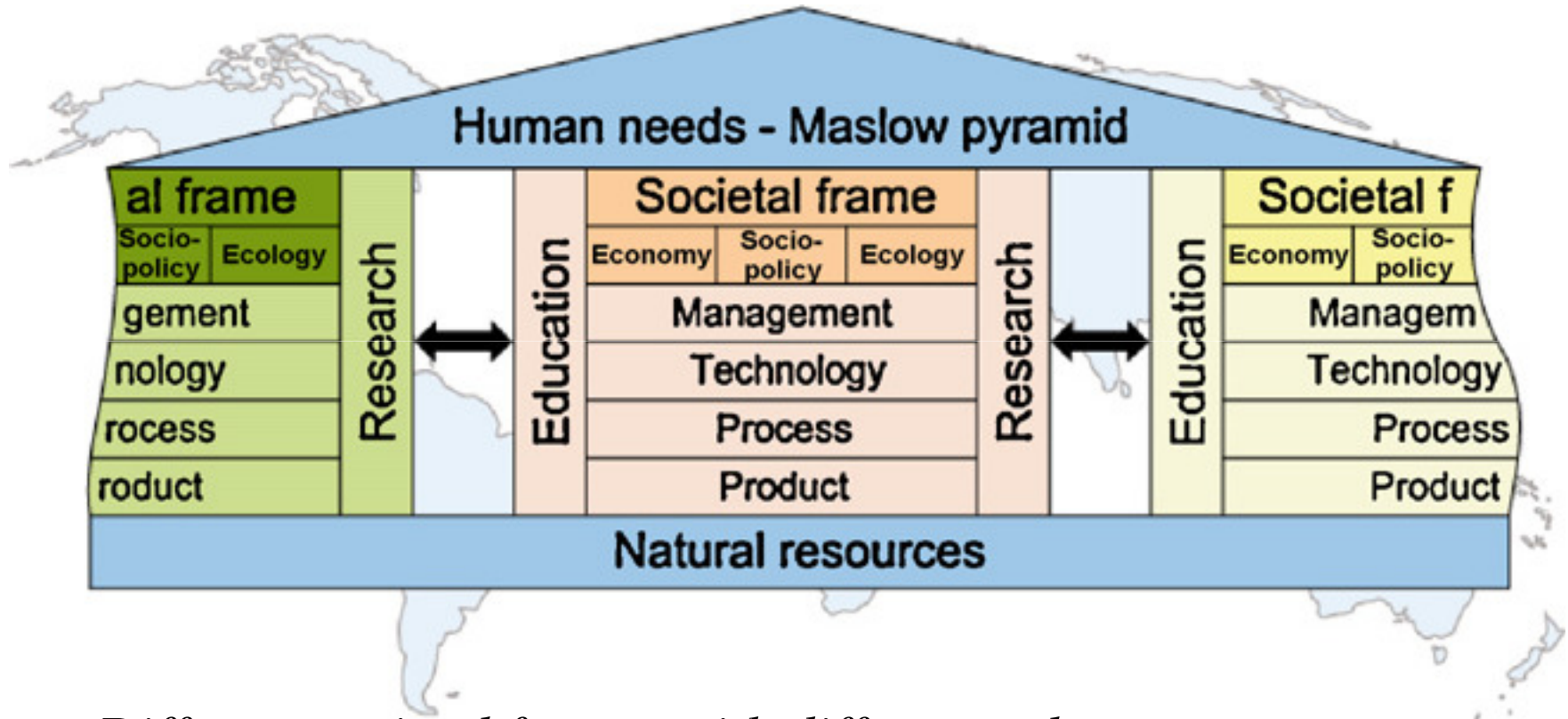

Different societal frames with different value systems – considering economic, ecological and sociopolitical issues in different regions of the globe – have to be taken into account

STAKEHOLDER'S RESPONSIBILITY

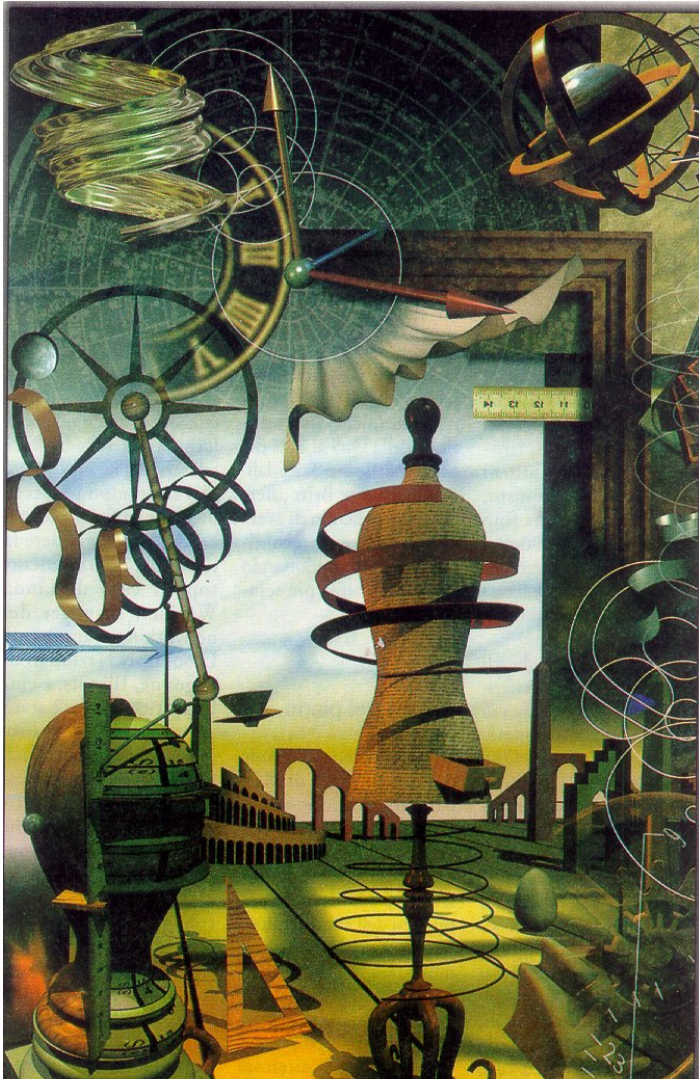

***There is a time when we must firmly
chose the course we will follow
or relentless drift of events will make
decision for us***

- « If environmental accounting works with the grain of business and business continues to encourage desecration of the planet (albeit at a reduced rate) then, ceteris paribus, we need to conclude that our environmental accounting may, perhaps, be doing more harm than good. . . . »* Young, 2006



SEEP 2010 - 4th International Conference on Sustainable Energy & Environmental Protection - Politecnico di Bari - Mozilla Firefox

File Modifica Visualizza Cronologia Segnalibri Strumenti Aiuto

http://seep2010.polba.it/ Google

Più visitati Come iniziare Ultime notizie VELANTE

SEEP 2010 - 4th Internati... Iva Taranto

SEEP2010 Conference Proceedings, June 29th – July 2nd, Bari, ITALY



Completato

Start

SUSTAINABLE ENERGY IN THE NEW ERA:

McAfee

18.55



© Prof. Ing. Michele DASSISTI

Politecnico di Bari – DMMM – V.le Japigia 182 – 70126 BARI

Tel. 080 – 596.2747; fax 080-5962.788; mobile: 329 650 6022; m.dassisti@poliba.it

WHERE



Systemic thinking

© Prof. Ing. Michele DASSISTI

Politecnico di Bari – DMIM – V.le Japigia 182 – 70126 BARI

Tel. 080 – 596.2747; fax 080-5962.788; mobile: 329 650 6022; m.dassisti@poliba.it

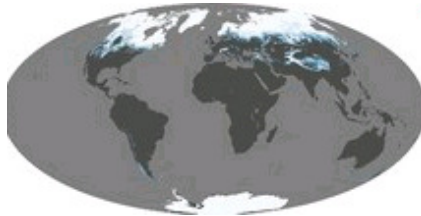
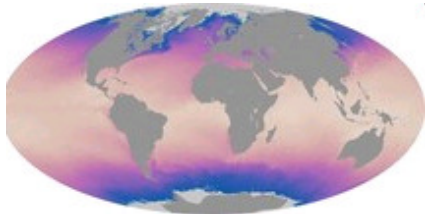
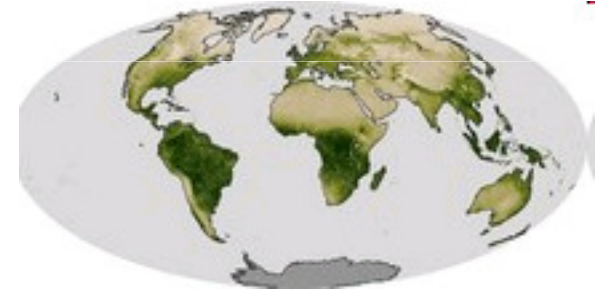
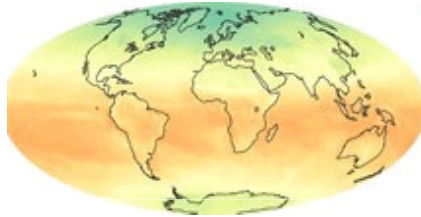
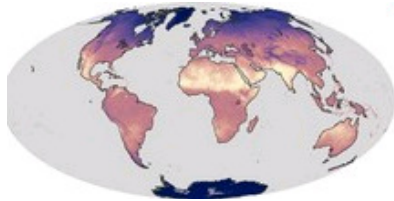
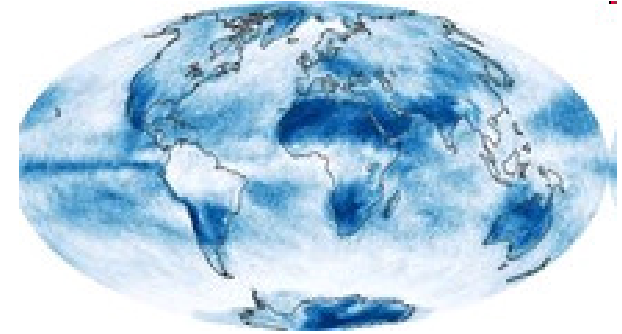
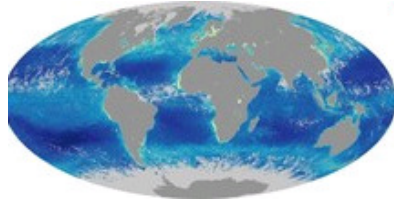
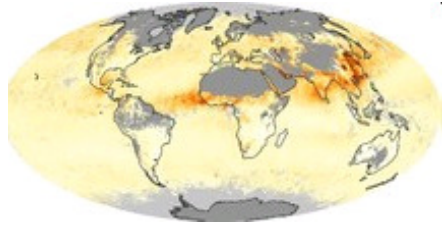

<http://earthobservatory.nasa.gov/GlobalMaps/>



Industrial ecology

Robert White, the former president of the US National Academy of Engineering (1994):

'the study of the flows of materials and energy in industrial and consumer activities, of the effects of these flows on the environment, and of the influences of economic, political, regulatory, and social factors on the flow, use, and transformation of resources'



Industrial ecology

It is ecological in at least two senses :

- Industrial ecology looks to **non-human ‘natural’ ecosystems as models** for industrial activity.(ex. *The Industrial Symbiosis at Kalundborg*: <http://indigodev.com/Kal.html>)
- Industrial ecology places human technological activity in the context of the larger ecosystems that support it. This sense of ‘ecological’ links to questions of **carrying capacity** and **ecological resilience**, asking whether, how and to what degree technological society is perturbing or undermining the ecosystems that provide critical services to humanity.

4th International Conference on Sustainable Energy & Environmental Protection

June 29/July 02, 2010
Politecnico di Bari, BARI - ITALY

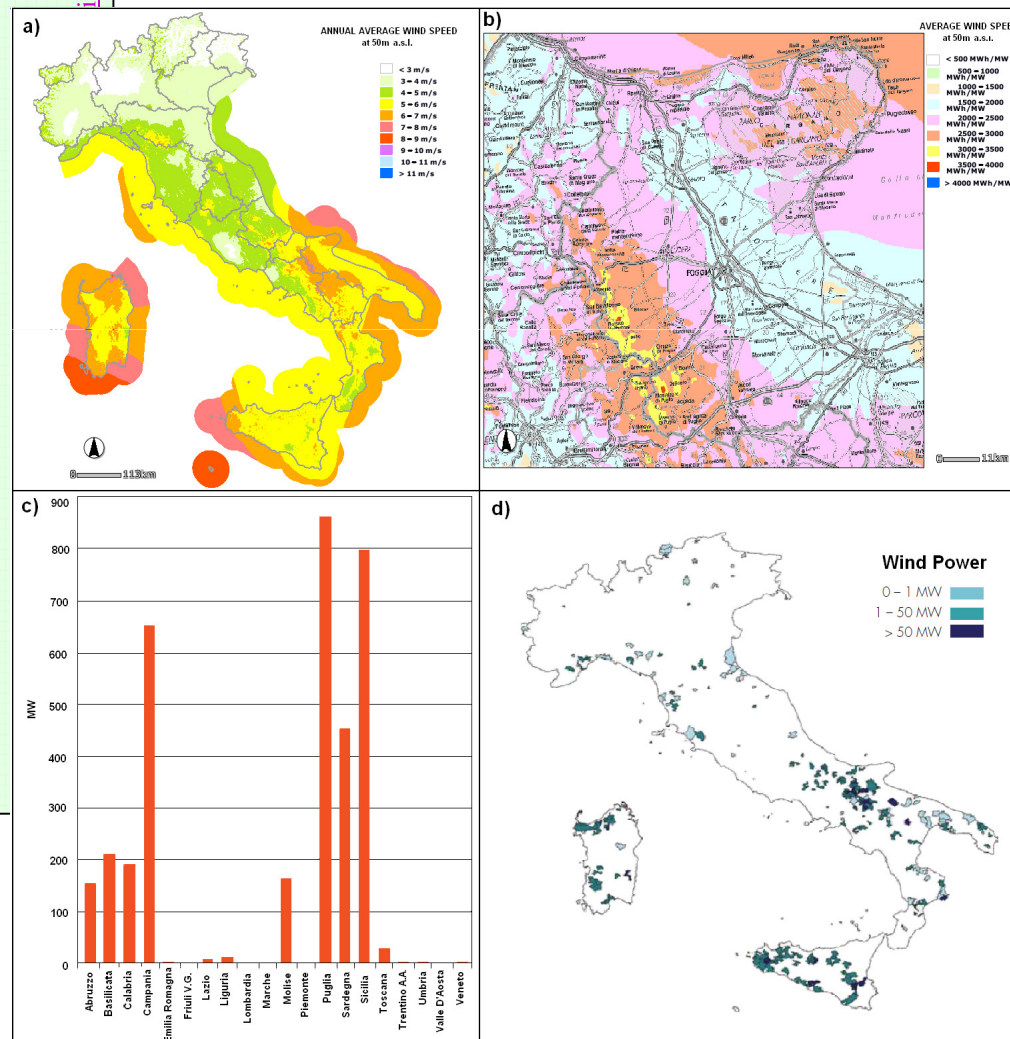

PEAR (2007),
Energetic
Environmental
regional Plan, Italy,
AFORIS

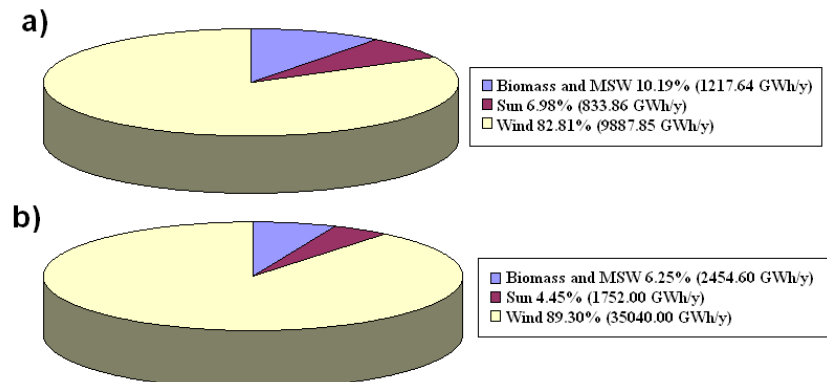



Resilience.

The capacity of a system to absorb disturbance and reorganize while undergoing change so as to still retain essentially the same function, structure, identity, and feedbacks—in other words, stay in the same basin of attraction.

Aspects critical :

- **Latitude:** the maximum amount the system can be changed before losing its ability to recover
- **Precariousness:** the current trajectory of the system, and how close it currently is to a limit or “threshold” which, if breached, makes recovery difficult or impossible
- **Panarchy:** how the above three attributes are influenced by the states and dynamics of the (sub)systems at scales above and below the scale of interest



Networks of small enterprises

© Prof. Ing. Michele DASSISTI

Politecnico di Bari – DMIMM – V.le Japigia 182 – 70126 BARI

Tel. 080 – 596.2747; fax 080-5962.788; mobile: 329 650 6022; m.dassisti@poliba.it

Laboratorio kad3

Organismo di Ricerca

Research

kad3

Engineering

ALI

Products development

HORUS

sostenibilità e sviluppo

Realization

HPM Service

Operation & Maintenance

Service

WPS

IT e Multimedia



Photovoltaic Plants

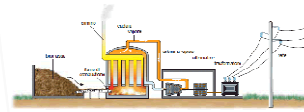

Wind Farms



Biomass and Biogas Plants

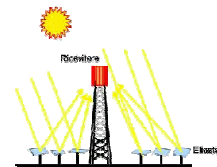
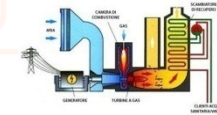

Cogeneration and Trigenation Plants

Solar Thermal and Solar Cooling Plants

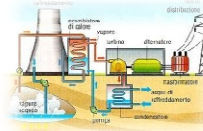
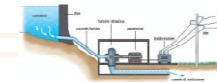

Micro-hydraulic Plants

Geothermal Plants



Hybrid Plants

kad3

ALI

HORUS

KAD3 GROUP



Networks of small enterprises

© Prof. Ing. Michele DASSISTI

Politecnico di Bari – DMMM – V.le Japigia 182 – 70126 BARI

Tel. 080 – 596.2747; fax 080-5962.788; mobile: 329 650 6022; m.dassisti@poliba.it

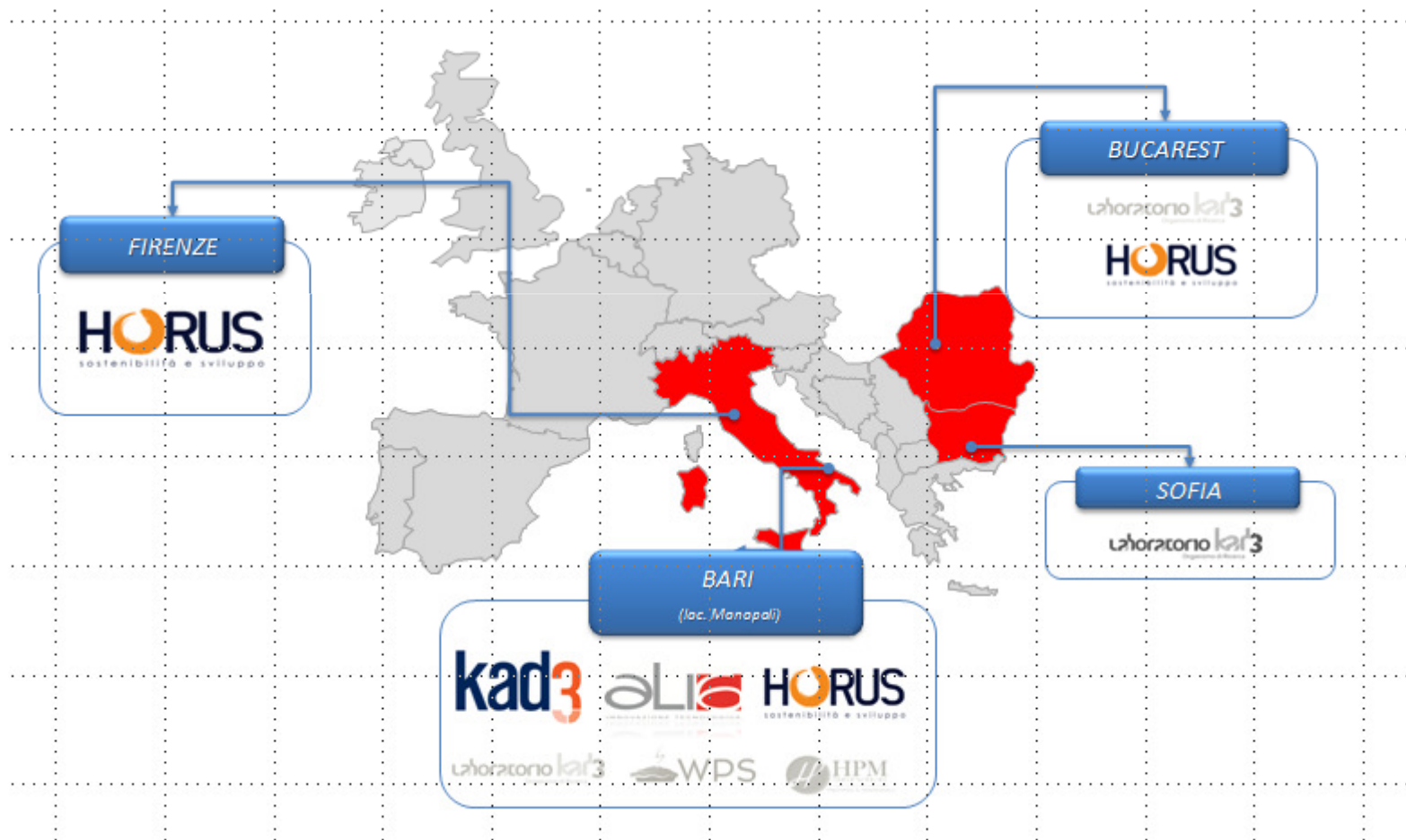



© Prof. Ing. Michele DASSISTI

Politecnico di Bari – DMMM – V.le Japigia 182 – 70126 BARI

Tel. 080 – 596.2747; fax 080-5962.788; mobile: 329 650 6022; m.dassisti@poliba.it

HOW'S



Number of different approaches.....

- Analyse (ORGANISATIONAL; ENVIRONMENTAL PERFORMANCE)
- Reduce (WATER; LUBRICATION; POLLUTION; WASTE; ENERGY CONSUMPTION; WASTE)
- Reuse (WASTE)
- Recycle (SYSTEMIC APPROACH)
- ReDesign (DECISION SUPPORT; GREENING PROCESS)
- Remanufacturing
- Eco-efficiency (OPTIMISE)
- Improve (MATERIALS)

• =56/250
contribution



NO UNIQUE SOLUTION \Leftrightarrow NO SOLUTION?

- Can be so many solution a sign of no solutions?
 - Is this a paradox?

The difficulty in finding a common roots in the frame of eco-approaches developed so far reflects the huge number of unknown potential influencing factors

- *«In the last decade significant progress has been made in recognising and understanding the issues in sustainability. Much remains to be done because the science that underlies sustainability is still far from exact...» Butterham, 2005*



Green chemistry: 12 principles

- mass and energy in and outputs should be as inherently non-hazardous as possible
- prevention of waste is better than clean up
- minimize energy in separation/purification processes
- maximize mass, energy, volume and time efficiency in product/process
- output-pulled is preferred to input-pushed
- energy is main criterion for choice between recycle, reuse or disposal



Green chemistry: 12 principles/2

- durability must be targeted (no eternal life)
- avoid one-size-fits-all, minimize excess
- minimize material diversity in multicomponent products
- integration & interconnectivity are a way to industrial ecology
- design for performance in a commercial “after-life”
- favour mass and energy inputs from renewable sources



REGULATION

© Prof. Ing. Michele DASSISTI

Politecnico di Bari – DMMM – V.le Japigia 182 – 70126 BARI

Tel. 080 – 596.2747; fax 080-5962.788; mobile: 329 650 6022; m.dassisti@poliba.it

1



Regulations on M.S.

Sustainability is inherently normative!

- There should be an overall goal and vision toward which policy and management programs and designs are directed.

Those environmental public goods that are defined through science and participatory decision-making processes as valuable enough to limit individual freedom of choice for sake of the common good can be influenced



EUROPE 20%

© Prof. Ing. Michele DASSISTI

Politecnico di Bari – DMMM – V.le Japigia 182 – 70126 BARI
Tel. 080 – 596.2747; fax 080-5962.788; mobile: 329 650 6022; m.dassisti@poliba.it



GAS
-20%
Vs 1990



RENOVATE:
+20%



REDUCE:
-20%



After 38 years.....
-20% revolution.....
On 2020!!!!!!!!!!!!!!

<http://ec.europa.eu/climateaction>

U.S.A. 25%

© Prof. Ing. Michele D'Alagni
Politecnico di Bari - DIMM - V.le Japigia 182 - 70126 BARI
Tel. 080 596.2747; fax 080-5962.788; mobile: 329 650 6022; m.dasisti@poliba.it

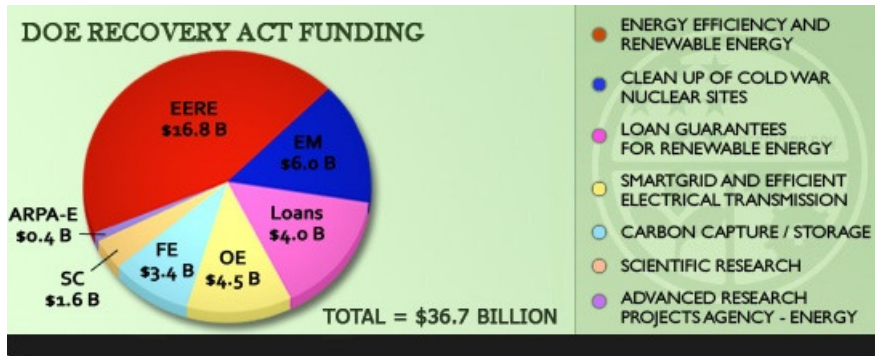

150M\$ x
10years

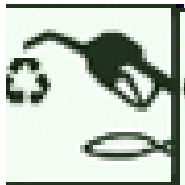

Ater 38 anni.....
To beat EUrope for 2025!!!!!!!!!!!!!!

<http://www.barakobama.com>



New initiatives

© Prof. Ing. Michele DASSISTI

Politecnico di Bari – DMMM – V.le Japigia 182 – 70126 BARI

Tel. 080 – 596.2747; fax 080-5962.788; mobile: 329 650 6022; m.dassisti@poliba.it

Firefox | NIST Prototypes Framework Fo... | NIST Sustainability Standards Portal | NIST What is sustainability? | YAHOO!

http://www.mel.nist.gov/msid/SSP/introduction/what_is_sustainability.html

AVIRA | POLIBA_mail | PolIBA | MIUR | CINECA | CASPUR_biblio | Borsa della Ricerca | CLIMEG | Google | EN-IT | EN-DE | FR_IT | MAM | Wetterzent | Bookmarks

Engineering Laboratory
Sustainability Standards Portal NIST
... a comprehensive understanding and analysis of sustainability-related standards

Introduction + Standards Landscape Search Standard Contribute Resources + Contact Us

Sustainability Standards Portal > Introduction > What is sustainability

What is sustainability?

We are witnessing an increased interest in ensuring that future generations have adequate resources to maintain a high standard of living. The World Commission on Environment and Development [1] defines sustainable development as:

“development that meets the needs of the present without compromising the needs of future generations to meet their own needs.”

According to the US National Research Council [2], sustainability is:

“the level of human consumption and activity, which can continue into the foreseeable future, so that the system that provides goods and services to the humans persists indefinitely.”

Others have argued that any definition of sustainability:

- should include dynamic efficiency throughout the life cycle of a product, process, and service
- should consist of total welfare (accounting for intergenerational equity)

Start | Terahertz Se... | Microsoft Wi... | What is sus... | COrso_SUST... | Microsoft Po... | IT | 17.54



European Foundation for Quality Management

© Prof. Ing. Michele DASSISTI

Politecnico di Bari – DMMM – V.le Japigia 182 – 70126 BARI

Tel. 080 – 596.2747; fax 080-5962.788; mobile: 329 650 6022; m.dassisti@poliba.it

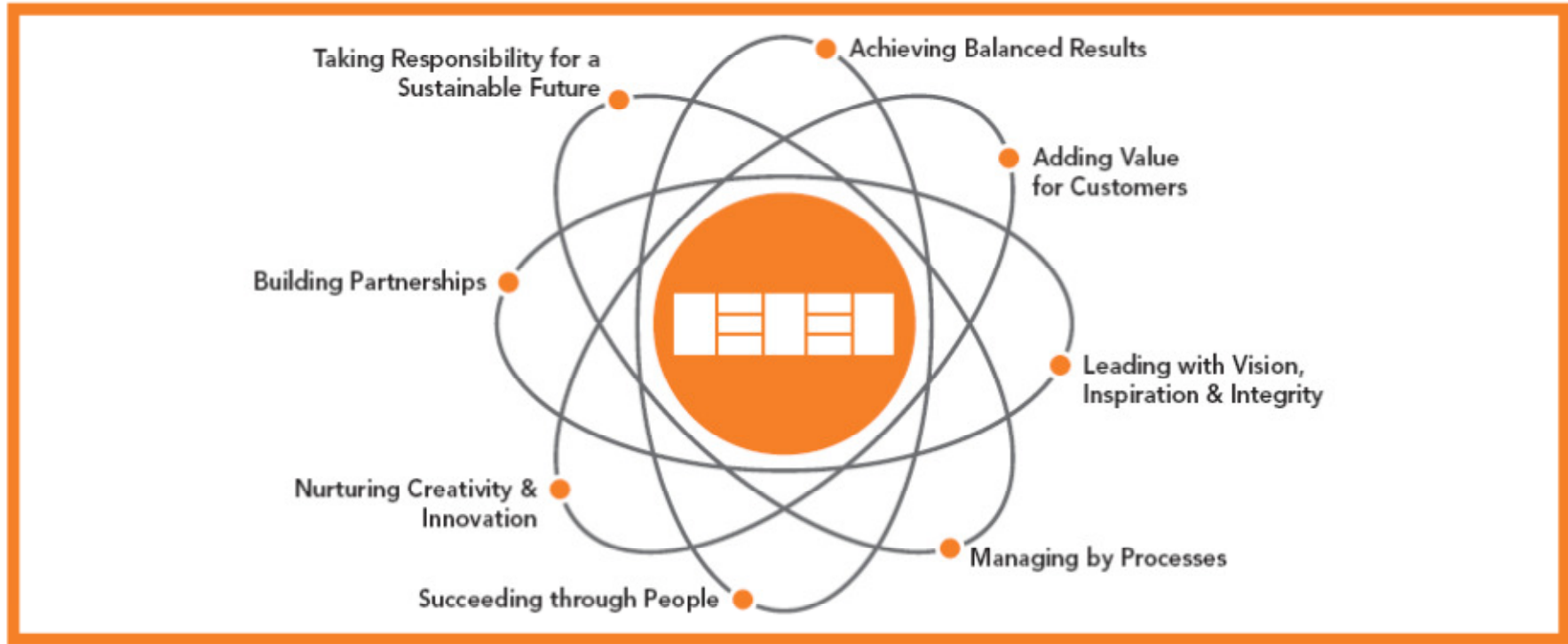



European Foundation for Quality Management

© Prof. Ing. Michele DASSISTI
 Politecnico di Bari – DMMM – V.le Japigia 182 – 70126 BARI
 Tel. 080 – 506 7747 - fax 080-5067 788 - mobile: 329 650 6077 - m.dassisti@poliba.it

CONCEPT	START UP	ON THE WAY	MATURE
<i>Succeeding through People</i>	Approaches are in place to involve people and their talents are recognised	The full potential of people is increasingly enabled, to the benefit of the people and the organisation	A culture of trust and empowerment exists and the full potential of people is released
<i>Nurturing Creativity and Innovation</i>	Although new ideas and innovations are sometimes encouraged, the approach to acting on them is ad hoc	Innovation is seen as essential to creating distinctive value and is increasingly evident in some aspects of the organisation	There is a systematic approach to innovation, throughout the organisation, creating distinctive value for stakeholders
<i>Building Partnerships</i>	A process exists for selecting and working with partners	The relationships with partners are based on shared goals and more effective ways of working	The organisation and its key partners are interdependent. A trusting relationship exists. Plans and policies are co-developed on the basis of shared knowledge
<i>Taking Responsibility for a Sustainable Future</i>	Legal and regulatory requirements are understood and met	The organisation's approaches positively support the aims of economic, social and ecological sustainability	Sustainable corporate behaviour is an integral part of the organisation's purpose. Societal expectations are measured and actioned



European Foundation for Quality Management

© Prof. Ing. Michele DASSISTI
 Politecnico di Bari – DMMM – V.le Japigia 182 – 70126 BARI
 Tel. 080 – 596.2747; fax 080-5962.788; mobile: 329 650 6022; m.dassisti@poliba.it

Criterion	1 Leadership					2 Strategy					3 People					4 Partnerships & Resources					5 Processes, Products and Services					6 Customer Results		7 People Results		8 Society Results		9 Key Results	
	A	B	C	D	E	A	B	C	D	E	A	B	C	D	E	A	B	C	D	E	A	B	A	B	A	B	A	B					
Achieving Balanced Results		X	X			X		X	X							X	X			X			X	X	X	X	X	X	X	X			
Adding Value for Customers			X				X											X	X	X	X	X	X		X								
Leading with Vision, Inspiration and Integrity	X			X	X		X							X												X		X		X			
Managing by Process		X					X	X				X	X	X	X	X	X	X	X	X		X		X		X		X		X			
Succeeding through People	X			X							X	X	X	X	X								X	X	X	X	X						
Nurturing Creativity & Innovation			X				X	X					X					X	X	X	X		X	X	X	X	X	X	X	X	X		
Building Partnerships			X			X	X									X						X	X	X	X	X	X	X	X	X			
Taking Responsibility for a Sustainable Future	X	X	X		X	X	X	X				X	X			X					X		X	X			X	X	X				



European Foundation for Quality Management

© Prof. Ing. Michele DASSISTI

Politecnico di Bari – DMMM – V.le Japigia 182 – 70126 BARI
Tel. 080 – 596.2747; fax 080-5962.788; mobile: 329 650 6022; m.dassisti@poliba.it

RADAR

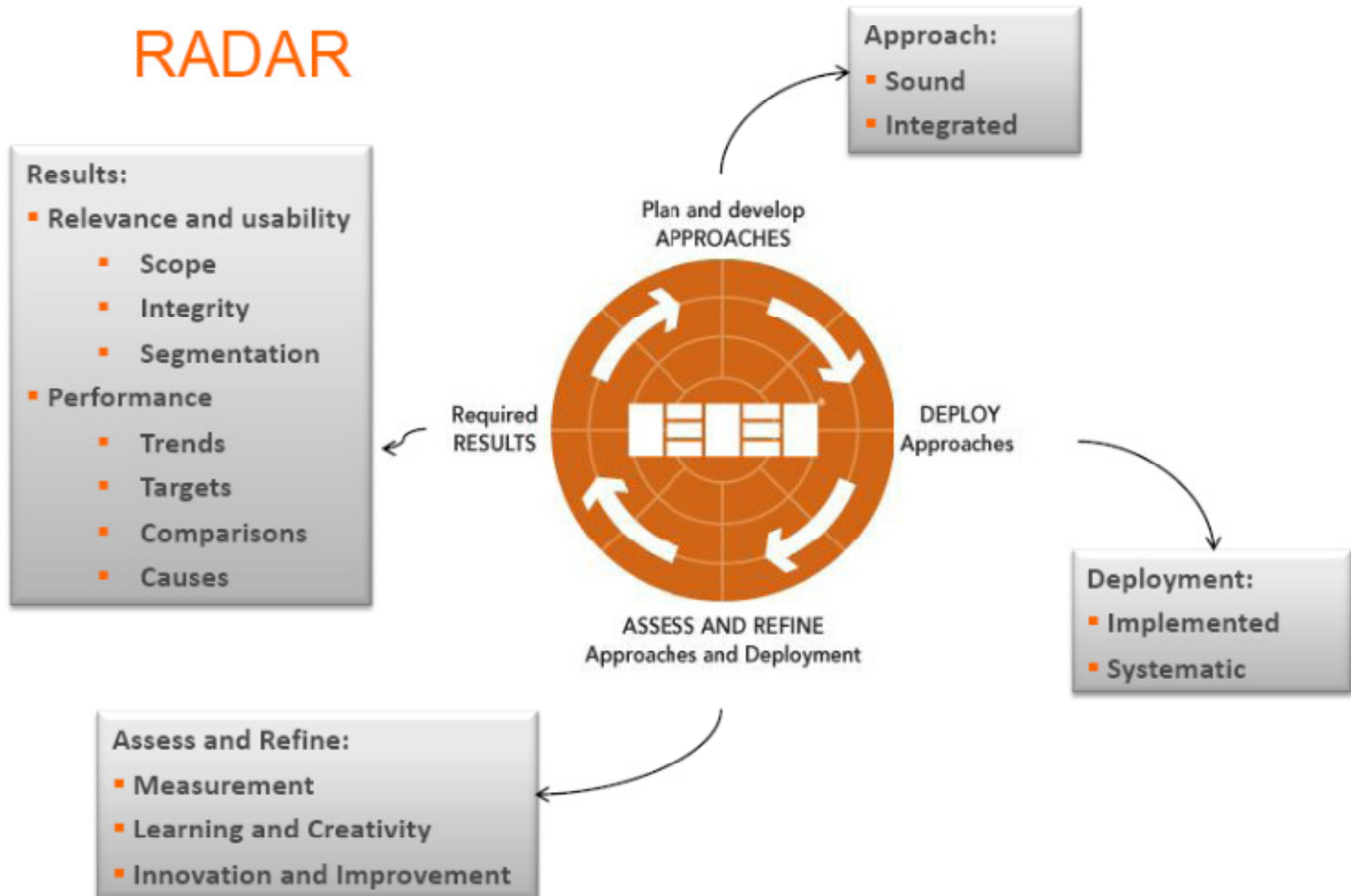



Total Quality & Environmental Mgmt

Total Quality Management (TQM) is widely recognized as an effective strategy for improving corporate performance.

The basic elements of TQM are as follows:

- Primacy of the customer
- Measurement systems that provide continuous feedback
- More extensive use of external information (benchmarking)
- * A focus on processes rather than departments or events
- Strong emphasis on training
- Extensive use of teams
- Suggestions systems designed to promote continuous improvement
- A robust program of recognition and reward
- CEO commitment and involvement



Total Quality & Environmental Mgmt

Environmental issues are increasingly seen as an integral component of continuous improvement in both the corporate and environmental fields.

This has led to a movement called Total Quality Environmental Management (TQEM).

TQEM extends traditional quality tenets to the management of corporate environmental matters as well as those of process efficiency and product performance.



TQEM: Performance Measures: Environmental Metrics

The progress of design projects should be clearly assessed with appropriate measures to help members of the design team achieve environmental goals. Consistent measures of impact reduction in all phases of design provide valuable information for design analysis and decision making.

It is important to establish measures that cover resource efficiency, waste generation in all media, ecosystem sustainability, and human health.

Life cycle design is likely to be more successful when environmental aspects are part of a firm's incentive and reward system.



Human principles

© Prof. Ing. Michele DASSISTI

Politecnico di Bari – DMMM – V.le Japigia 182 – 70126 BARI

Tel. 080 – 596.2747; fax 080-5962.788; mobile: 329 650 6022; m.dassisti@poliba.it

2



The Natural step: a framework

© Prof. Ing. Michele DASSISTI
Politecnico di Bari – DMIMM – V.le Japigia 182 – 70126 BARI
Tel. 080 – 596.2747; fax 080-5962.788; mobile: 329 650 6022; m.dassisti@poliba.it

The screenshot shows a web browser displaying the website 'the NATURAL STEP'. The page features a navigation menu with links for 'OUR PROGRAMS', 'OUR APPROACH', 'SOCIAL MEDIA', 'NEWS AND EVENTS', 'RESOURCES', and 'ABOUT US'. A 'Newsletter' sign-up box is visible, along with a 'FREE WEBINAR: Introduction to The Natural Step' registration button. The main content area is titled 'The Four System Conditions' and contains a paragraph of text, four circular icons representing different aspects of sustainability, and a list of events including 'The Natural Step Canada Sustainability-TEA (Edmonton, AB) Wednesday, July 20, 2011' and 'The Natural Step Framework and Other Approaches to Sustainability: A 5-Level Framework (Webinar) Thursday, August 18, 2011'. The browser's address bar shows the URL 'http://www.thenaturalstep.org/en/canada/the-system-conditions'.

Karl-Henrik Robèrt, M.D., Ph.D. (born 1947), is one of Sweden's leading cancer scientists and an important figure in the worldwide sustainability movement.



The Natural step framework

© Prof. Ing. Michele DASSISTI
 Politecnico di Bari – DMMM – V.le Japigia 182 – 70126 BARI
 Tel. 080 – 596.2747; fax 080-5962.788; mobile: 329 650 6022; m.dassisti@poliba.it

Firefox | electrolux and sustainability - Ce... | interface and sustainability - Cer... | W Karl-Henrik Røbert - Wikipedia, t... | The Four System Conditions, FT... | x

http://www.thenaturalstep.org/en/canada/the-system-conditions

AVIRA | POLIBA_mail | PolIBA | MIUR | CINECA | CASPUR_biblio | Borsa della Ricerca | CLIMEG | Google | EN-IT | EN-DE | FR_IT | MAM | Wetterzent | Bookmarks

The Four System Conditions...	... Reworded as The Four Principles of Sustainability
In a sustainable society, nature is not subject to systematically increasing:	To become a sustainable society we must...
1. concentrations of substances extracted from the earth's crust	1. eliminate our contribution to the progressive buildup of substances extracted from the Earth's crust (for example, heavy metals and fossil fuels)
2. concentrations of substances produced by society	2. eliminate our contribution to the progressive buildup of chemicals and compounds produced by society (for example, dioxins, PCBs, and DDT)
3. degradation by physical means	3. eliminate our contribution to the progressive physical degradation and destruction of nature and natural processes (for example, over harvesting forests and paving over critical wildlife habitat); and
4. and, in that society, people are not subject to conditions that systemically undermine their capacity to meet their needs	4. eliminate our contribution to conditions that undermine people's capacity to meet their basic human needs (for example, unsafe working conditions and not enough pay to live on).

more: (Montreal, QC)
 Monday, August 22, 2011

[Open House at The Natural Step Canada](#)
 Monday, September 12, 2011

[IMPACT! Youth Conference for Sustainability Leadership \(Guelph, ON\)](#)
 Thursday, September 15, 2011

[Introduction to The Natural Step \(Webinar\)](#)
 Thursday, September 22, 2011

At first reading, the system conditions and basic principles might



Finitedness of resources

© Prof. Ing. Michele DASSISTI

Politecnico di Bari – DMMM – V.le Japigia 182 – 70126 BARI

Tel. 080 – 596.2747; fax 080-5962.788; mobile: 329 650 6022; m.dassisti@poliba.it

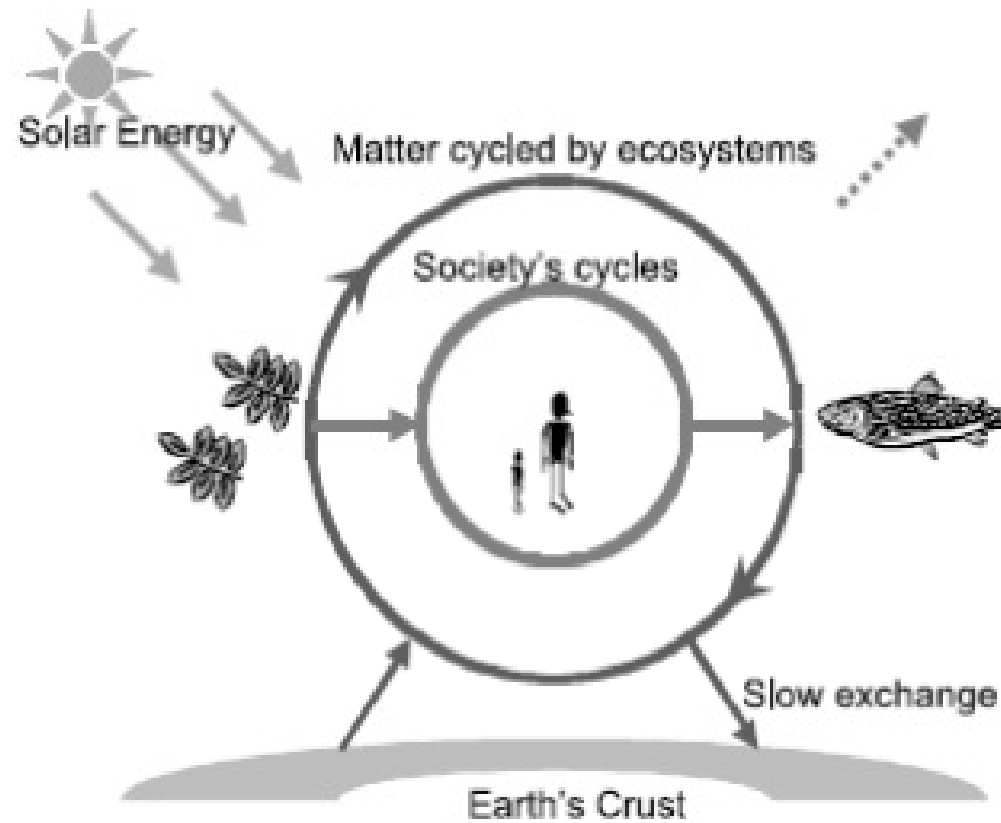

Fig. 2. The TNS systems model of resource cycles.



TNS framework

Fundamental human needs that are consistent across time and cultures:

**1.subsistence, 2.protection, 3.affection, 4.understanding, 5. participation,
6. leisure, 7.creation, 8.identity, 9.freedom.**

© Prof. Ing. Michele DASSISTI

Politecnico di Bari – DMIM – V.le Japigia 182 – 70126 BARI
Tel. 080 – 596.2747; fax 080-5962.788; mobile: 329 650 6022; m.dassisti@poliba.it

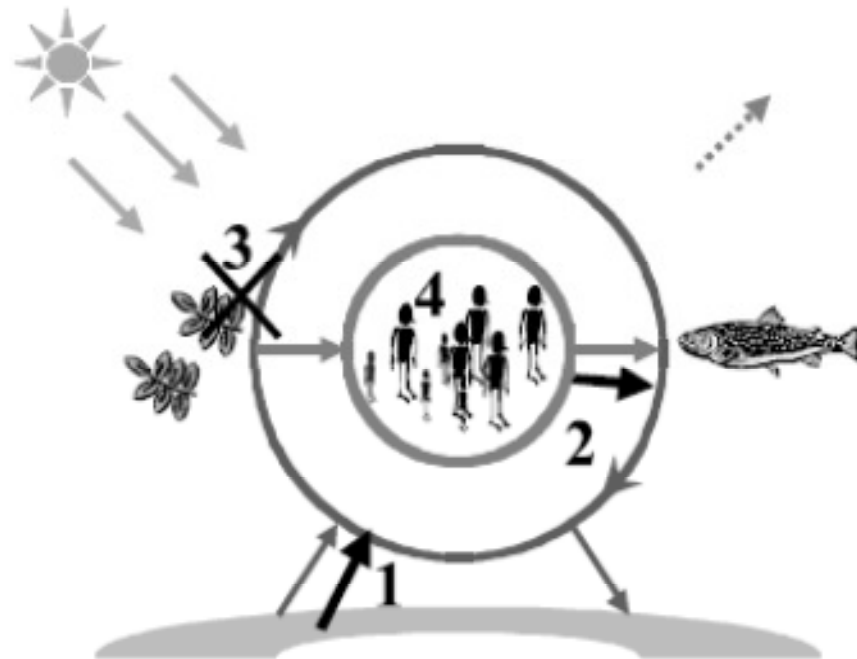
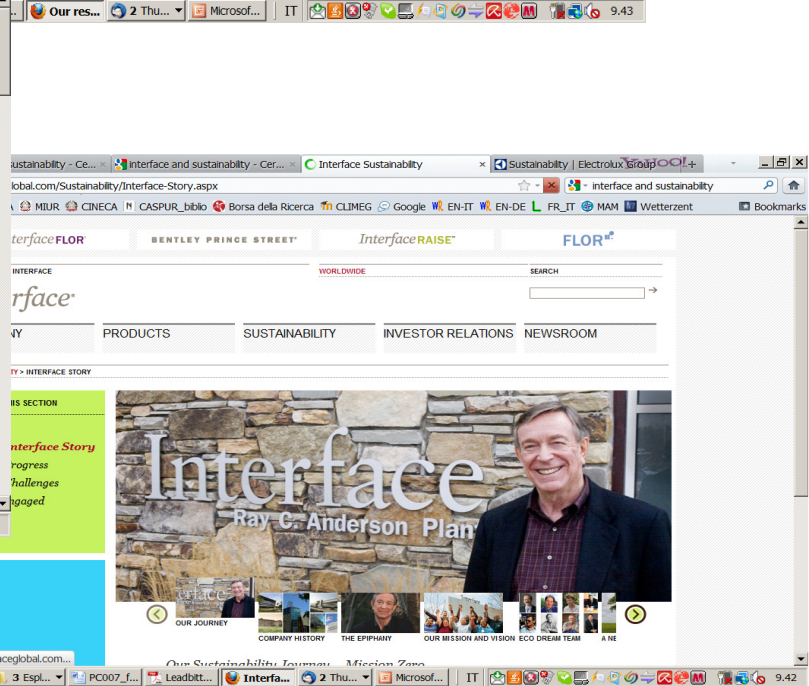
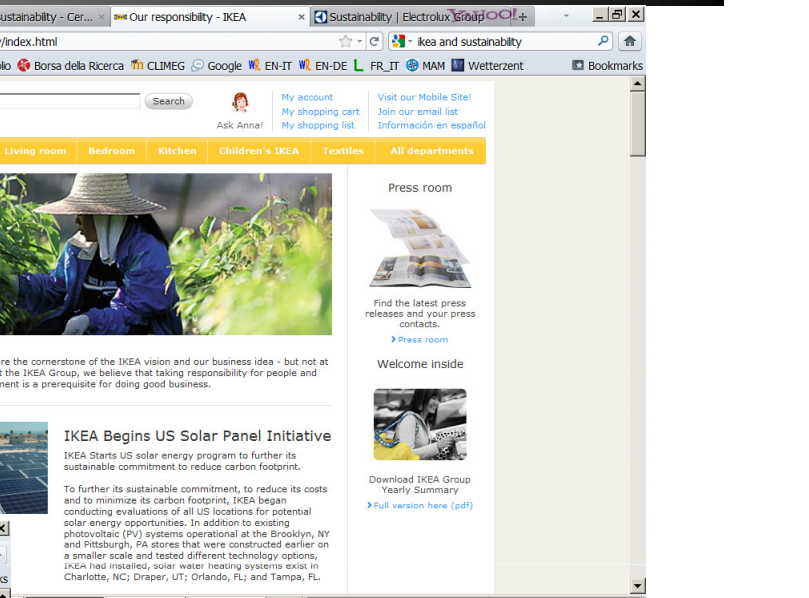
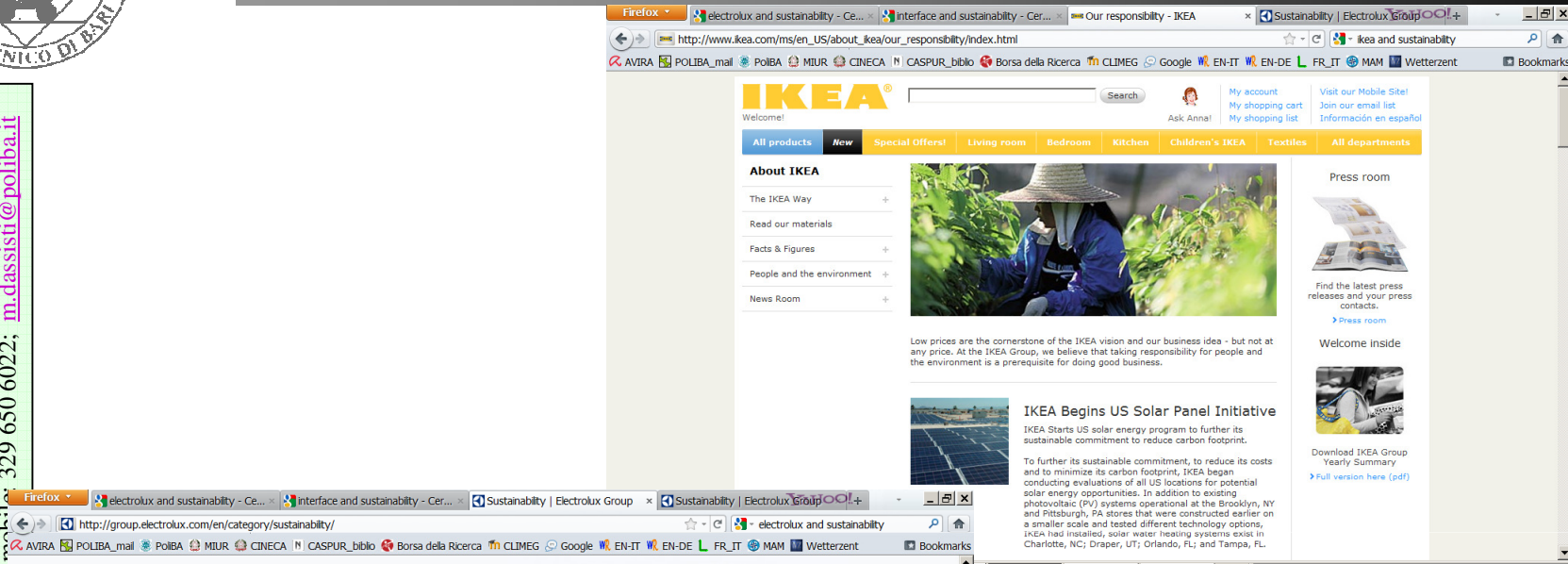

Fig. 3. The four TNS system conditions.



The Natural step: the brave companies

© Prof. Ing. Michele DASSISTI
Politecnico di Bari – DMMM – V.le Japigia 182 – 70126 BARI
Tel. 080 50607747 - Fax. 080 5060780 - E-mail: m.dassisti@poliba.it





TNS: The case of PVC production

© Prof. Ing. Michele DASSISTI

Politecnico di Bari – DMMM – V.le Japigia 182 – 70126 BARI

Tel. 080 – 596.2747; fax 080-5962.788; mobile: 329 650 6022; m.dassisti@poliba.it

No.1: The industry should commit itself long-term to becoming carbon-neutral

- Achieve major improvements in energy efficiency in manufacturing plants
- Improve generation efficiency, for example by increased use of Combine Heat and Power systems
- Develop programmes for a progressive increase in the use of renewable energy sources for generation of electricity
- Set targets for substantial reductions in transport energy use by improved efficiency, backloading, rationalisation and selection of optimum mode
- Analyse the feasibility and carry out a life-cycle analysis (LCA) of changing feedstocks from hydrocarbons to biomass or other sources



TNS: The case of PVC production

© Prof. Ing. Michele DASSISTI

Politecnico di Bari – DMMM – V.le Japigia 182 – 70126 BARI

Tel. 080 – 596.2747; fax 080-5962.788; mobile: 329 650 6022; m.dassisti@poliba.it

No.1: The industry should commit itself long-term to becoming carbon-neutral

- Achieve major improvements in energy efficiency in manufacturing plants
- Improve generation efficiency, for example by increased use of Combine Heat and Power systems
- Develop programmes for a progressive increase in the use of renewable energy sources for generation of electricity
- Set targets for substantial reductions in transport energy use by improved efficiency, backloading, rationalisation and selection of optimum mode
- Analyse the feasibility and carry out a life-cycle analysis (LCA) of changing feedstocks from hydrocarbons to biomass or other sources
- Develop co-operative programmes to substantially increase the recycling of waste products including a major effort to work with other agencies and users
- Agree specific targets for adopting carbon sequestration schemes



TNS: The case of PVC production

No.2: The industry should commit itself long term to a closed-loop system of PVC waste management

Design for recycling

- Enhance joint efforts with stakeholders to increase the amount of recycling and reuse of PVC
- Set specific targets for the above increasing progressively over time
- Continue investigations into the potential toxicity problems arising from PVC in landfill and, where required, ban substances from landfill
- Analyse the sustainability implications of the extent of continued use of landfill and alternative waste disposal routes, including incineration
- Develop the pilot plant for PVC feedstock recycling to full-scale production



TNS: The case of PVC production

© Prof. Ing. Michele DASSISTI

Politecnico di Bari – DMMM – V.le Japigia 182 – 70126 BARI
Tel. 080 – 596.2747; fax 080-5962.788; mobile: 329 650 6022; m.dassisti@poliba.it

No.3: The industry should commit itself long-term to ensuring that releases of persistent organic compounds from the whole life-cycle do not result in systematic increases in concentration in nature.

- Identify sources and emission/leakage levels of persistent organic pollutants across the whole life-cycle
- Define mechanisms for achieving emissions to a level that results in no systematic accumulation in nature
- Refrigerants and fire fighting chemicals
- Mercury emissions



TNS: The case of PVC production

© Prof. Ing. Michele DASSISTI

Politecnico di Bari – DMMM – V.le Japigia 182 – 70126 BARI
Tel. 080 – 596.2747; fax 080-5962.788; mobile: 329 650 6022; m.dassisti@poliba.it

- No.4: The industry should review the use of all additives consistent with attaining full sustainability, and especially commit to phasing out all persistent compounds foreign to nature, as well as chemicals for which there is reasonable doubt regarding toxic effects.**
- determine in which applications it would be prudent to review the use of plasticised PVC, and other potentially problematic additives
 - where there is reasonable doubt about the safety of phthalates, research alternative plasticisers and other additives that do not result in systematic accumulation in nature or toxic effects. It is important to note that alternatives should not be assumed to be more sustainable than known problematic substances in the absence of a sustainability analysis.



TNS: The case of PVC production

No.5: The industry should commit to the raising of awareness about sustainable development across the industry, and the inclusion of all participants in its achievement.

- **Engaging stakeholders** (*setting priorities with main interest groups*)
- **Socially beneficial products** (*Future attention to products in the market will also be measured by their social contribution to society*)



Product design criteria

© Prof. Ing. Michele DASSISTI

Politecnico di Bari – DMMM – V.le Japigia 182 – 70126 BARI

Tel. 080 – 596.2747; fax 080-5962.788; mobile: 329 650 6022; m.dassisti@poliba.it

3



ACT: what will be done?

- As a consequence, long before devoting efforts in eco-design, the first questions should be if we need those functions we are asking from products; then to search the best way to design it and manufacture under the sustainable capabilities constraints.

DASSISTI

DMMM - V.le Japigia 182 - 70126 BARI
; fax 080-5962.788; mobile: 329 650 6022; m.dassisti@poliba.it

- *<< Eco-redesigns (E-) consist of short-term, low-functional-change...*
- *Eco-innovations (E+) are a longer-term, high-functional change group of approaches that focus on reinventing...*
- *Sustainable technology innovations (E++) utilize emerging/ unproven technology to provide customer benefits ... >>* Appleton, 2006

SEEP 2010



The infinite cycle of materials



4th International Conference on Sustainable Energy & Environmental Protection **June 29/July 02, 2010**
Politecnico di Bari, BARI - ITALY

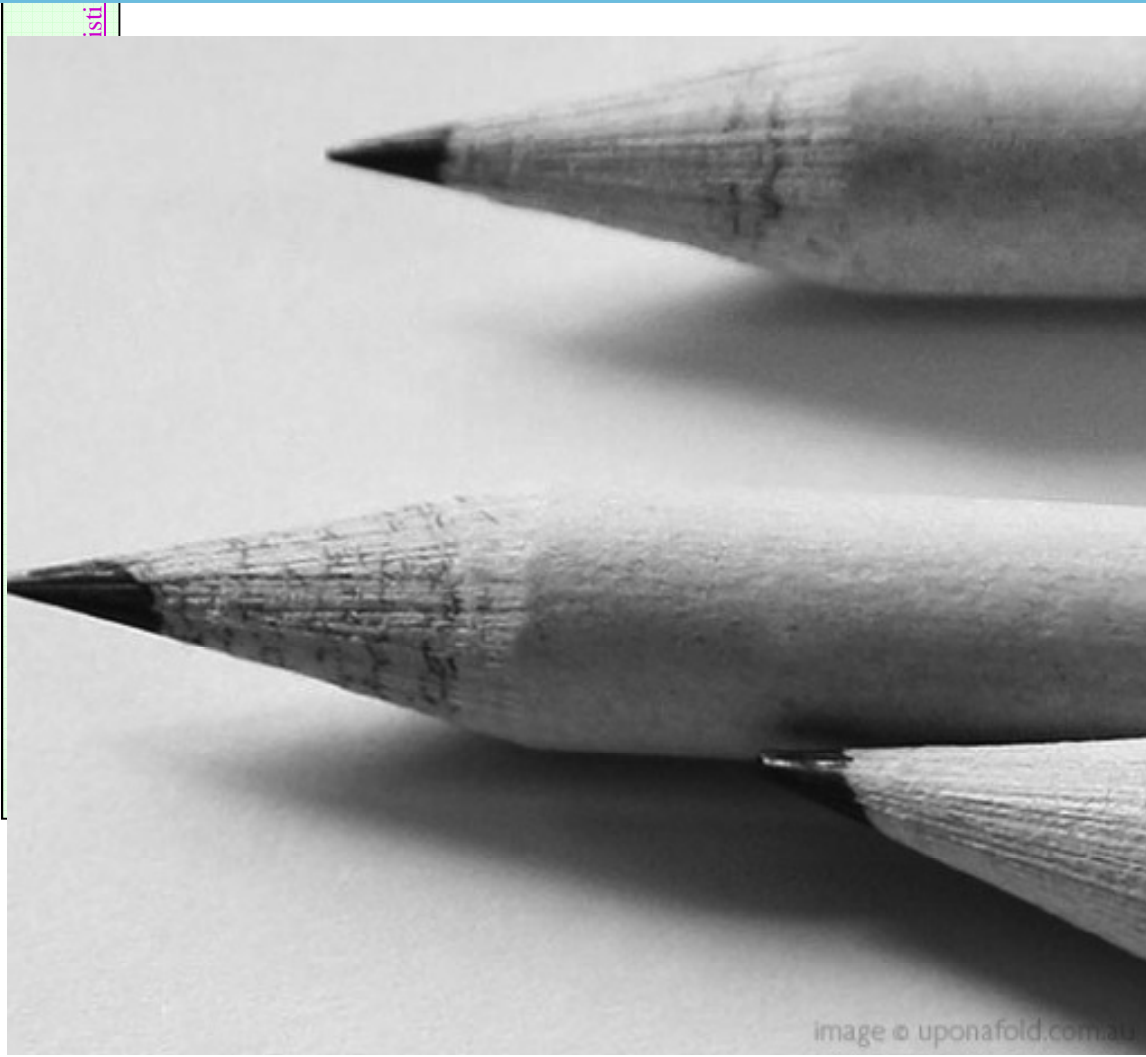

“Stop Global Warming”
paper
pencils set

.....

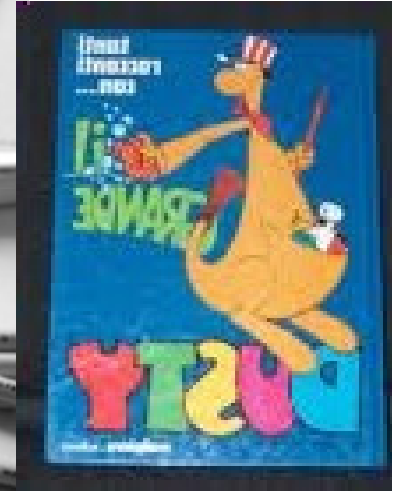

image © uponafold.com.au



4th International Conference on
Sustainable Energy & Environmental Protection

June 29/July 02, 2010
Politecnico di Bari, BARI - ITALY

© Prof. Ing. Michele DASSISTI
Politecnico di Bari – DMMM – V.le Japigia 182 – 70126 BARI
Tel. 080 – 596.2747; fax 080-5962.788; mobile: 329 650 6022; m.dassisi



Misapor [16] is produced from recycled glass and pure mineral additives in a thermal process: this is a 100% natural material

4th International Conference on Sustainable Energy & Environmental Protection

June 29/July 02, 2010
Politecnico di Bari, BARI - ITALY

THE 5 STEP PLAYBACK PROCESS

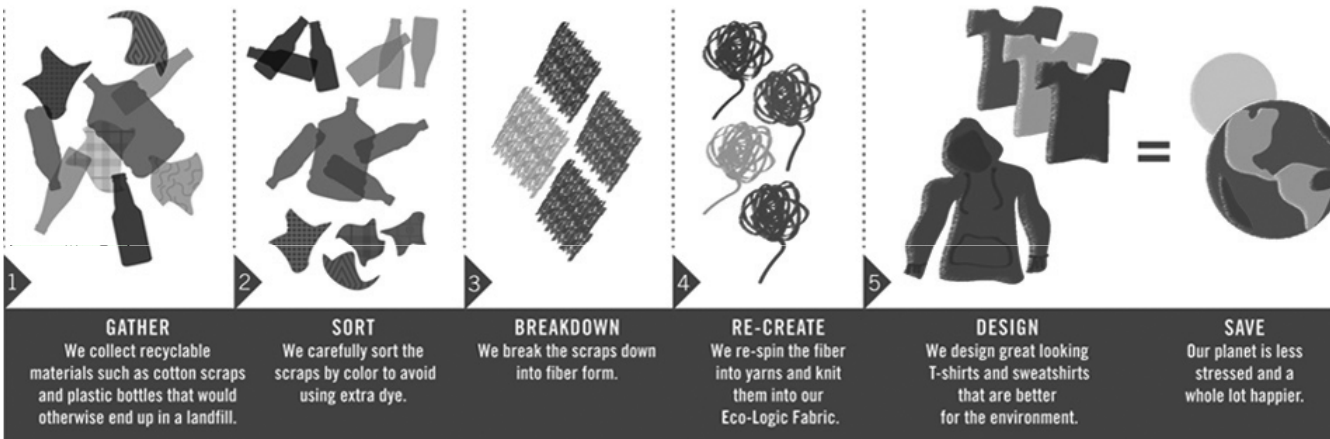

Plastic shirt?
SI GRAZIE

© Prof. Ing. Michele DA
Politecnico di Bari – DM
Tel. 080 – 596.2747; fax

From sewage.....

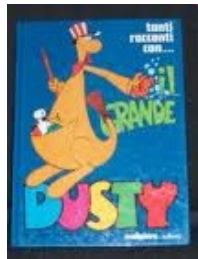



PRODUCT-SERVICE SYSTEMS:

“A marketable set of products and services capable of jointly fulfilling a user’s need.

The product/service ratio in this set can vary, either in terms of function fulfillment or economic value”

© Prof. Ing. Michele DASSISTI

Politecnico di Bari – DMMM – V.le Japigia 182 – 70126 BARI
Tel. 080 – 596.2747; fax 080-5962.788; mobile: 329 650 6022; m.dassisti@poliba.it



Fig. 3 Iceberg model of service business



PSS: to understand!

Designed and marketed to provide customers with a particular result or function—clean clothes, mobility, warmth, etc.—without them necessarily having to own or buy physical products

Behavioural change!



FUNCTION:

i.e. the capability to satisfy needs

- Manufacture a good: Are all its functions necessary?



- Volume
- Insulate
- Glossy aspect
- Hygienic
- Non-toxic
- Easy to handle
- “Sip oriented”
-



PSS: good rules!

- the sale of the use of the product instead of the product itself;
- the change to a 'leasing society'
- the substitution of goods by means of service machines
- a repair-society instead of a throw-away society
- the change in consumer attitudes from sales to service orientation.



Closed loop manufacturing!

As for the products, Yoshikawa states that

- what people value is not a product itself, but its functionality;
 - functionality of a product is service embedded in the product. (People receive the service someone embedded in the product when they use the product);
 - latent functionality appears as service when the product is used;
 - functionality of a product decreases when it is used.
- Functionality = SUM services (life of a product terminates when services embedded are exhausted).



Axiomatic Quality

From “Customer’s attribute” to
“Functional Requirements” to “Design
Parameters” to “Process Variables”

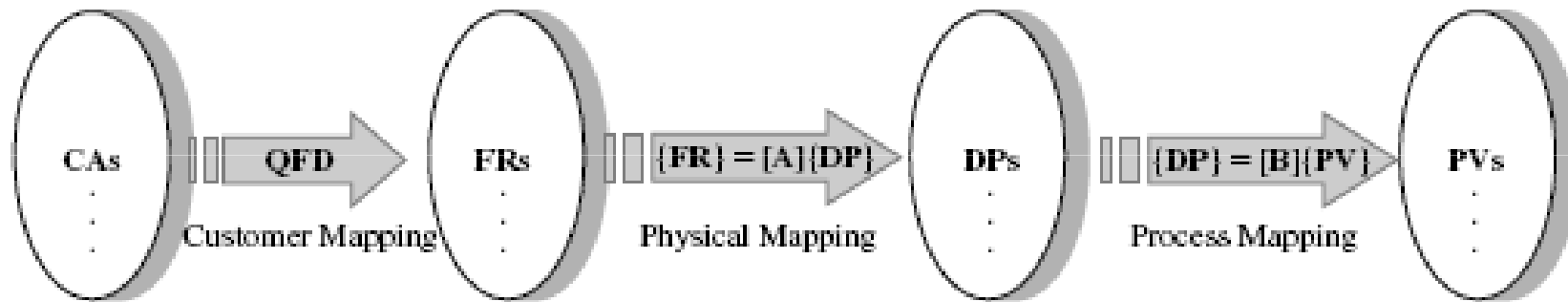

Figure 1.1 Design mapping process.

© Prof. Ing. Michele DASSISTI

Politecnico di Bari – DMMM – V.le Japigia 182 – 70126 BARI
Tel. 080 – 596.2747; fax 080-5962.788; mobile: 329 650 6022; m.dassisti@poliba.it

Acclaro DFSS Light®, a limited version of Acclaro Designer® software provided by Axiomatic Design Solutions, Inc., via free download from the Wiley ftp site ftp://ftp.wiley.com/public/sci_tech_med/axiomatic_quality/



Axiomatic Quality

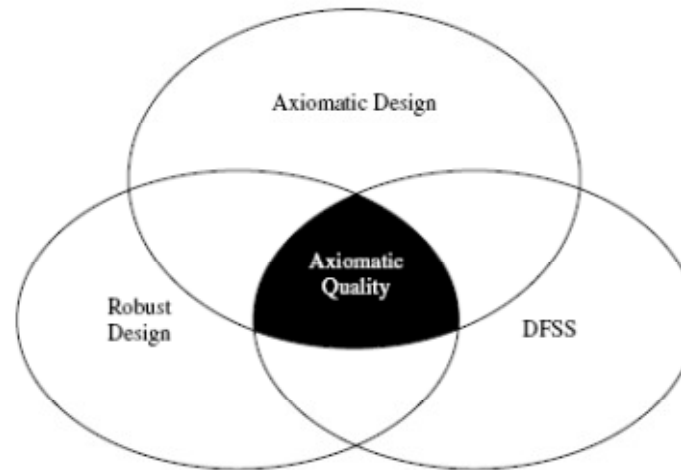

Figure P.1 Axiomatic quality ingredients.

*Starting with the voice of the customer, axiomatic quality focuses on establishing a **comprehensive design process** that utilizes ingredients of Axiomatic Design, Robust Design and Design for Six Sigma from comparative tools: quality engineering, axiomatic design, theory of inventive problem solving, deterministic optimization, and in the absence of quantitative data, fuzzy set theory.*



Axiomatic Quality

Coupling /incoupling desing: how to arrange sustianable constraints

© Prof. Ing. Michele DASSISTI
 Politecnico di Bari – DMMM – V.le Japigia 182 – 70126 BARI
 Tel. 080 – 596.2747; fax 080-5962.788; mobile: 329 650 6022; m.dassisti@poliba.it

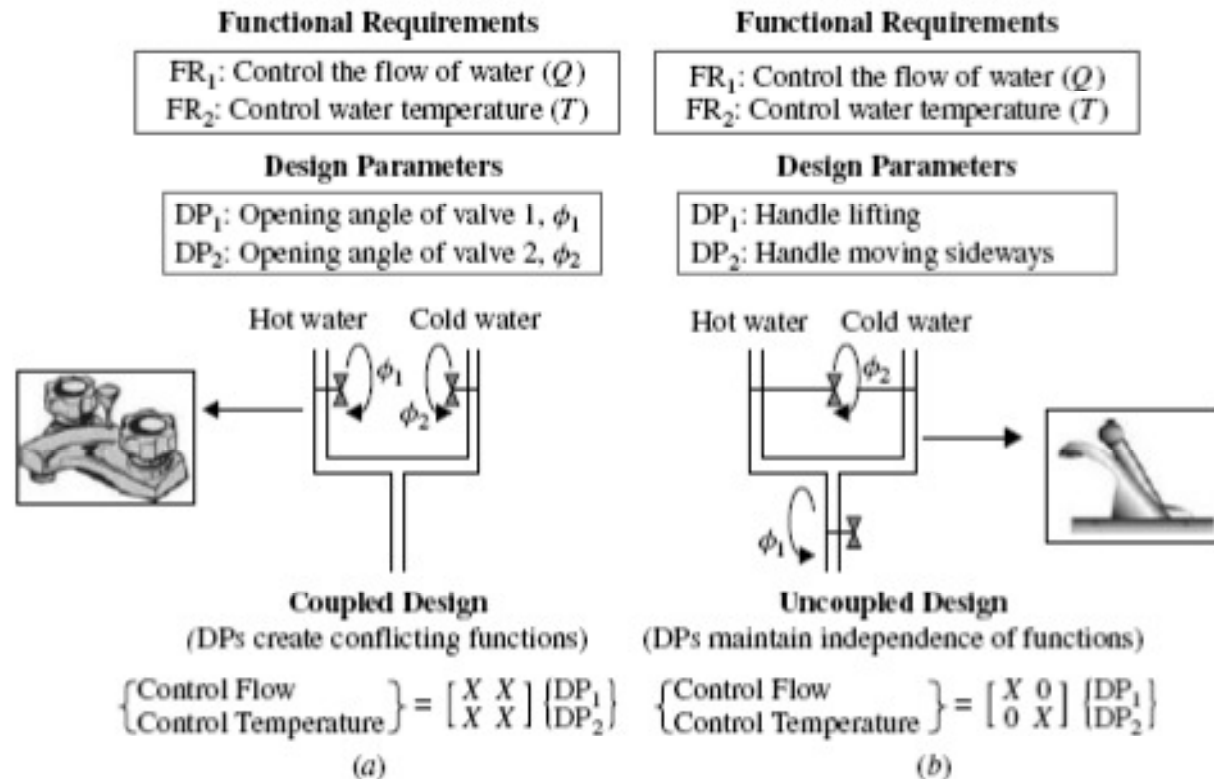

Figure 1.3 Faucet coupling example.

El-Haik, Basem. Axiomatic quality: integrating axiomatic design with six-sigma, reliability, and quality engineering / by Basem Said El-Haik. p. cm. "Wiley-Interscience publication." Includes bibliographical references and index. ISBN 0-471-68273-X (cloth : alk. paper)



Life-cycle perspective

© Prof. Ing. Michele DASSISTI

Politecnico di Bari – DMMM – V.le Japigia 182 – 70126 BARI

Tel. 080 – 596.2747; fax 080-5962.788; mobile: 329 650 6022; m.dassisti@poliba.it

4



Life cycle approach

© Prof. Ing. Michele DASSISTI
Politecnico di Bari – DMMM – V.le Japigia 182 – 70126 BARI
Tel. 080 – 596.2747; fax 080-5962.788; mobile: 329 650 6022; m.dassisti@poliba.it

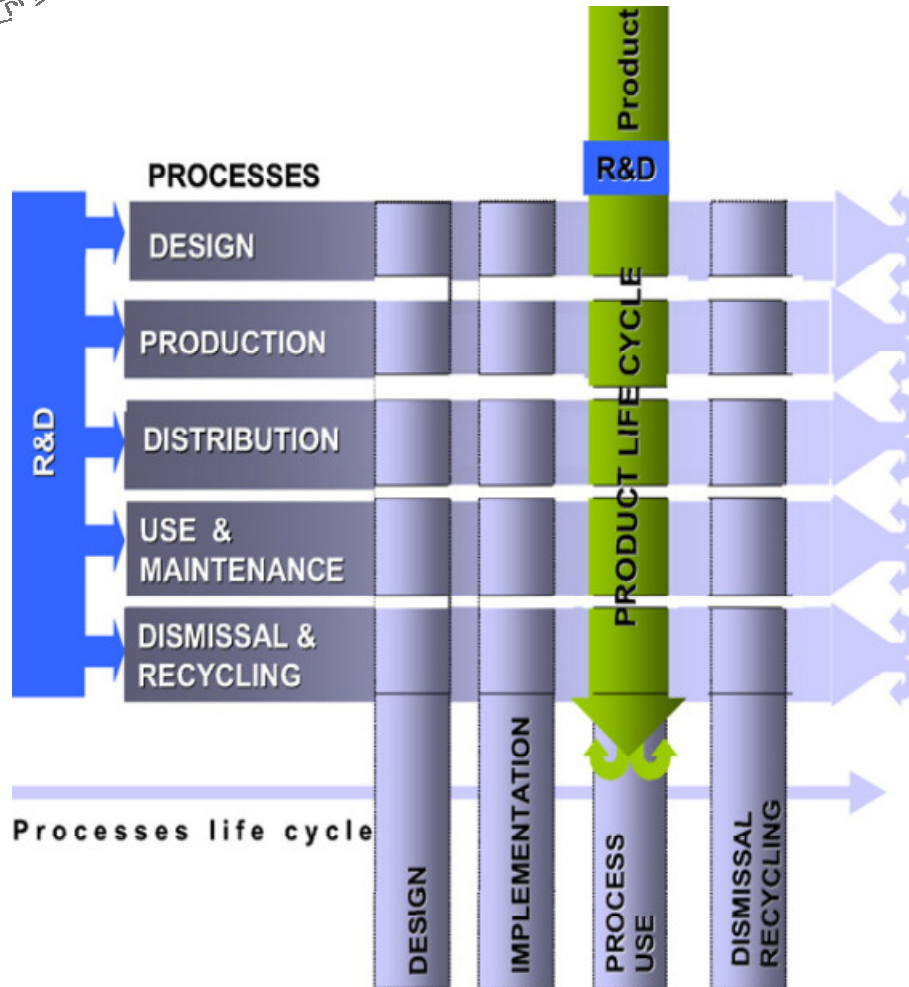

- Processes must be designed and operated so that wastes and ecologically incompatible by-products are continuously reduced, eliminated or recycled on-site;
- chemical substances or physical agents and conditions that present hazards to human health or the environment are continuously eliminated;
- energy and materials are conserved, and the forms of energy and materials used are most appropriate for the desired ends;
- work spaces are designed to continuously minimize or eliminate chemical, ergonomic and physical hazards.



LCA: the third tool

© Prof. Ing. Michele DASSISTI

Politecnico di Bari – DMIM – V.le Japigia 182 – 70126 BARI

Tel. 080 – 596.2747; fax 080-5962.788; mobile: 329 650 6022; m.dassisti@poliba.it

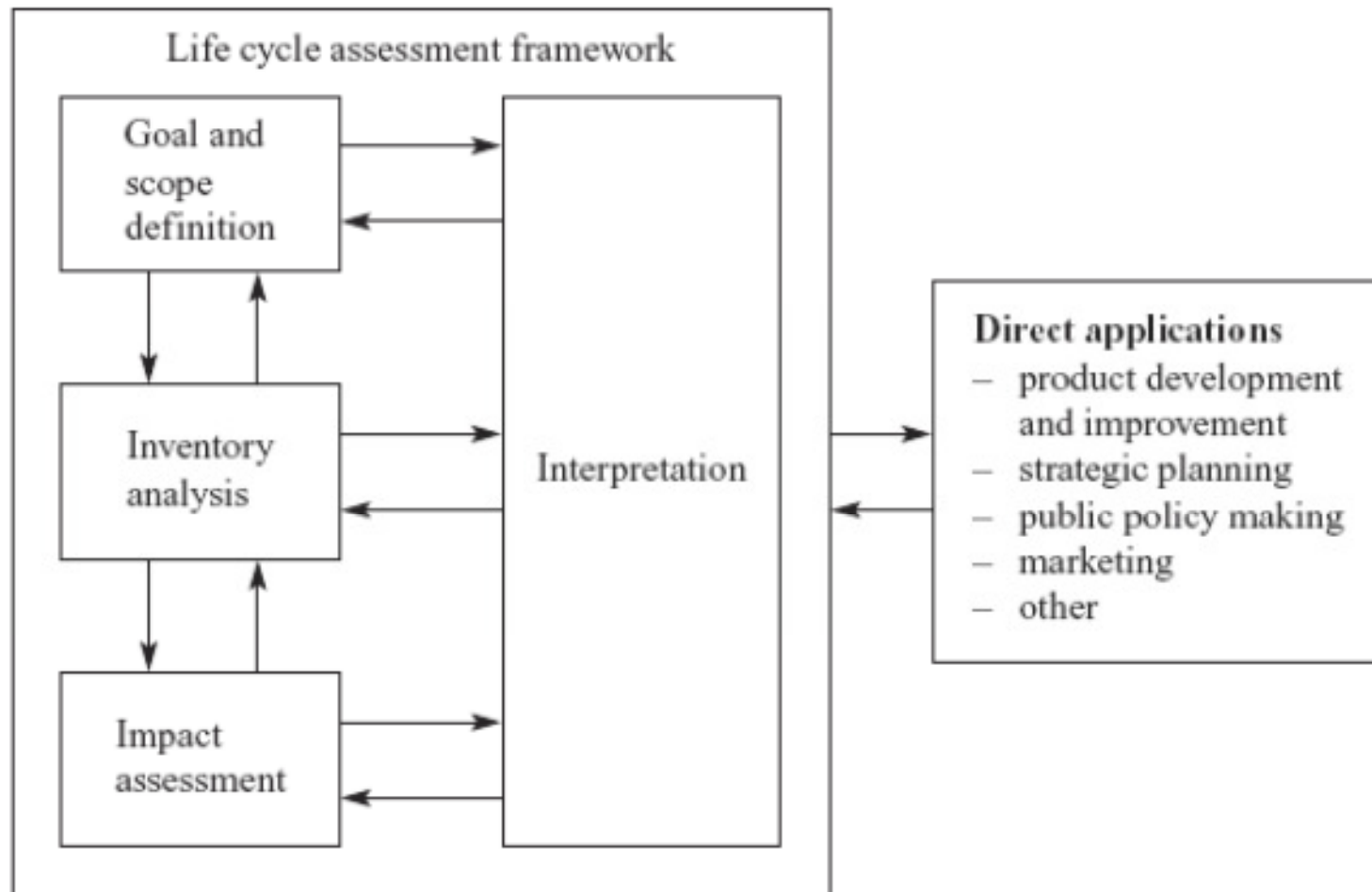

Source: ISO (1996).



System boundaries

© Prof. Ing. Michele DASSISTI

Politecnico di Bari – DMMM – V.le Japigia 182 – 70126 BARI

Tel. 080 – 596.2747; fax 080-5962.788; mobile: 329 650 6022; m.dassisti@poliba.it

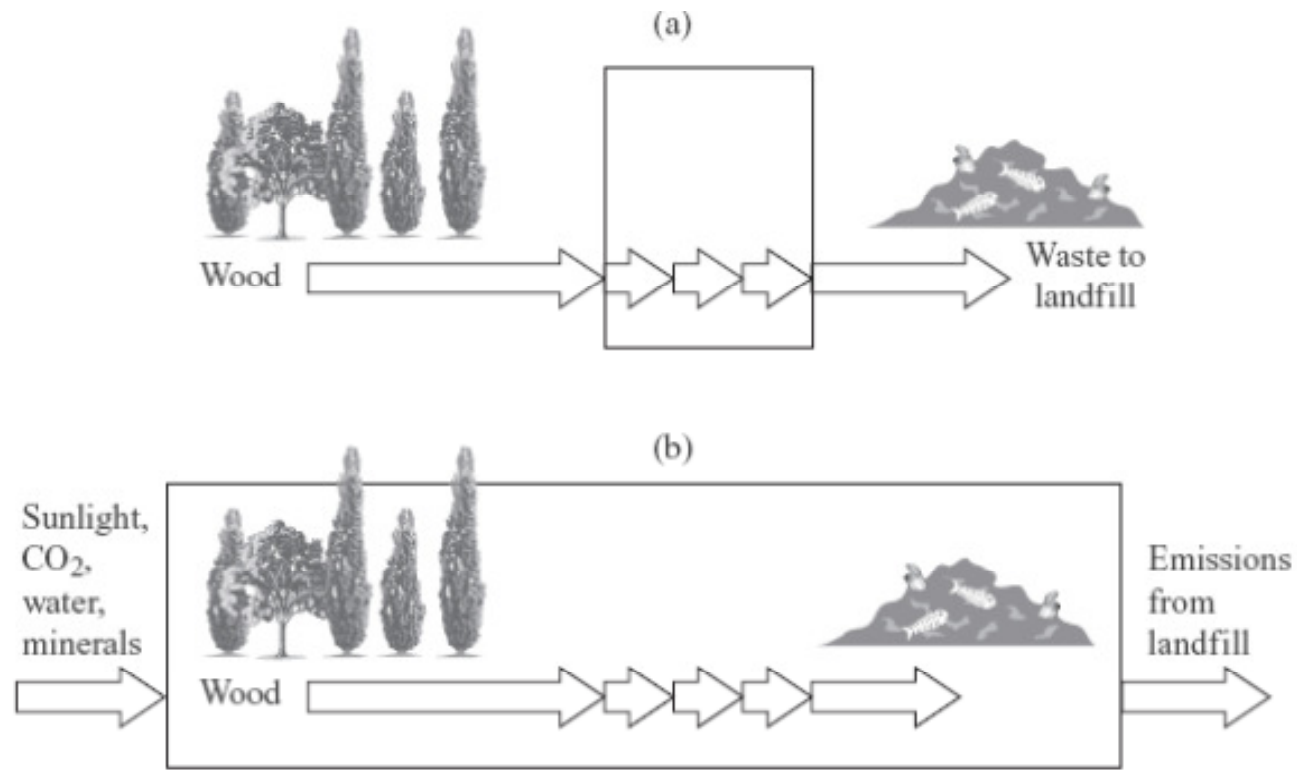
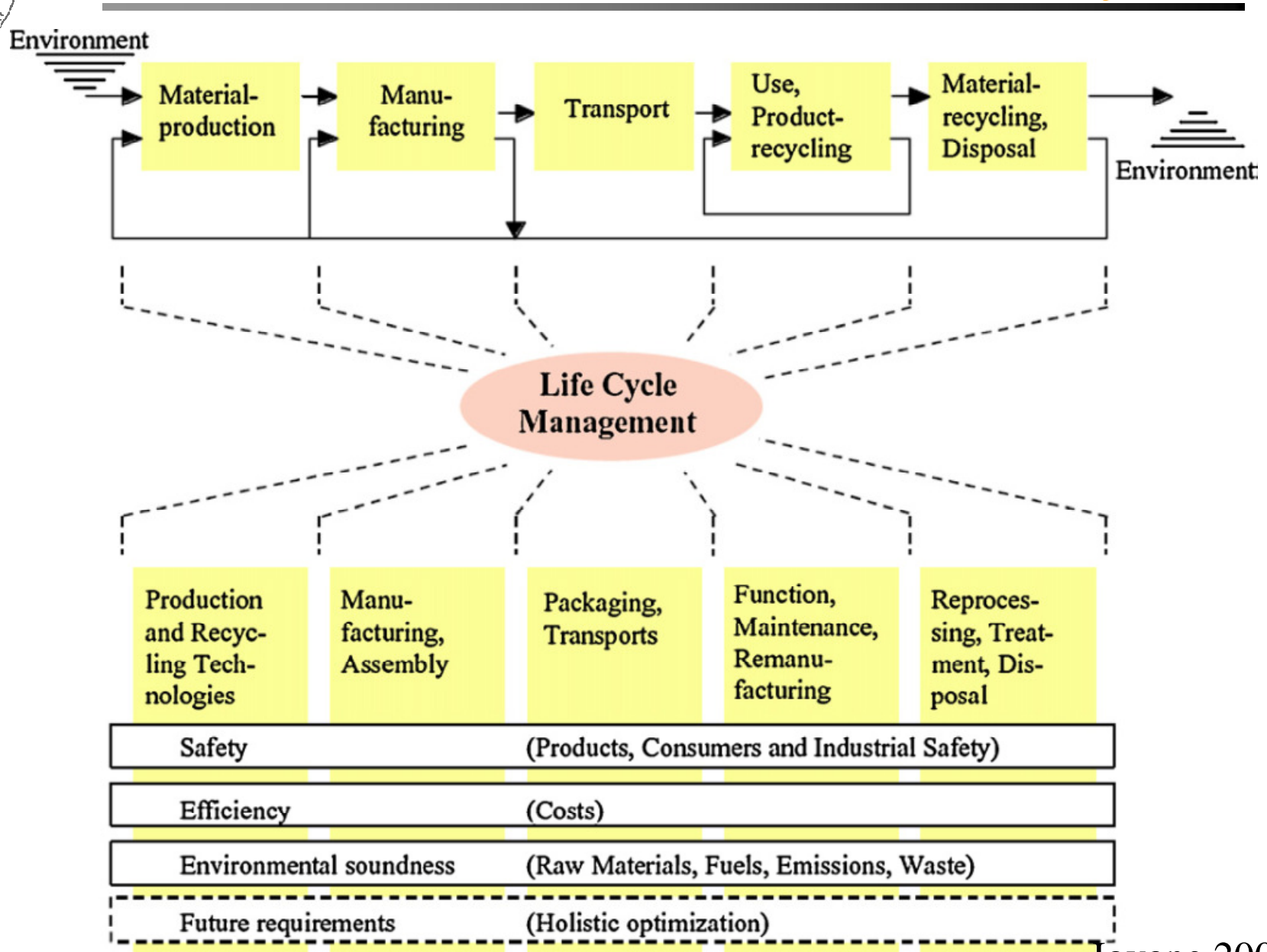

Figure 12.2 Two ways of defining system boundaries between physical economy and environment in LCA: (a) with narrow system boundaries, (b) with extended boundaries



Product life cycle

© Prof. Ing. Michele DASSISTI
 Politecnico di Bari – DMMM – V.le Japigia 182 – 70126 BARI
 Tel. 080 – 596.2747; fax 080-5962.788; mobile: 329 650 6022; m.dassisti@poliba.it





LCA: Eco_efficiency

- Eco-efficiency (EE) is among the most commonly used concepts in sustainability policies and management discussions.

© Prof. Ing. Michele DASSISTI

Politecnico di Bari – DMIMM – V.le Japigia 182 – 70126 BARI
Tel. 080 – 596.2747; fax 080-5962.788; mobile: 329 650 6022; m.dassisti@poliba.it



By definition, eco-efficiency does not include a vision, a goal or a direction.



Life-Cycle Sustainability Assessment

L-C Assessment: addresses analytically the environmental impacts relating to the whole production chain of a good >>

Planet

L-C Costing: summarizes all costs associated with the life cycle of a good that are directly covered in that life cycle

Profit

<< L-C Societal Assessment: societal impacts but from different aspects: S-responsible investments; product improvement potentials >>

People



Benchmarking

*Comparing solutions according to
a given context
and for a given scope
based on the best practices and/or
performances*



The benchmarking frame

RULE 1:

SPECIFICATION on PHYSICAL TRANSFORMATIONS

RULE 3:

DATA SOUNDNESS

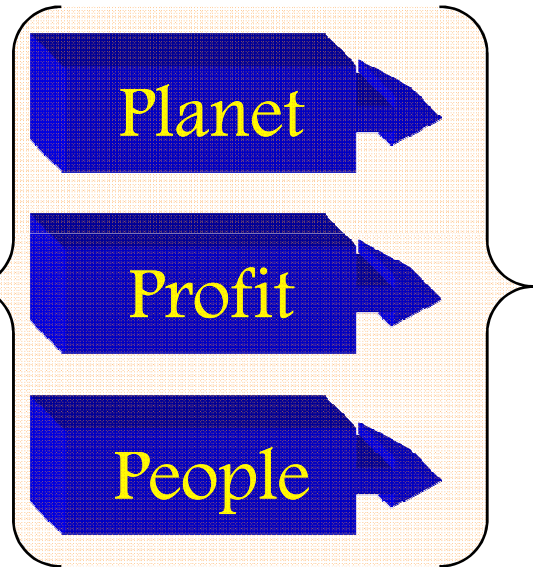

RULE 2:

SPATIAL and TEMPORAL CONSISTENCY



Renewable is sustainable?

- III. Renewable energy sources are often presented as “clean”. A more correct definition hopefully is that they are “cleaner” than ones based on fossil fuel conversion.
- IV. If it is agreed that humankind has no chance to survive on this planet (and, thus, nowhere else), unless a sustainable development is achieved, sustainability has to be established at all levels.
- V.



LCA: PV panels

© Prof. Ing. Michele DASSISTI

Politecnico di Bari – DMIM – V.le Japigia 182 – 70126 BARI

Tel. 080 – 596.2747; fax 080-5962.788; mobile: 329 650 6022; m.dassisti@poliba.it

- First generation:
crystalline (mono- / poly-) silicon and ribbon silicon
- Second generation :
amorphous silicon (a-Si), Cadmium Telluride (CdTe), CIS, CIGS
- Third generation :
organic cells (DSSC), solar concentrators, ecc.

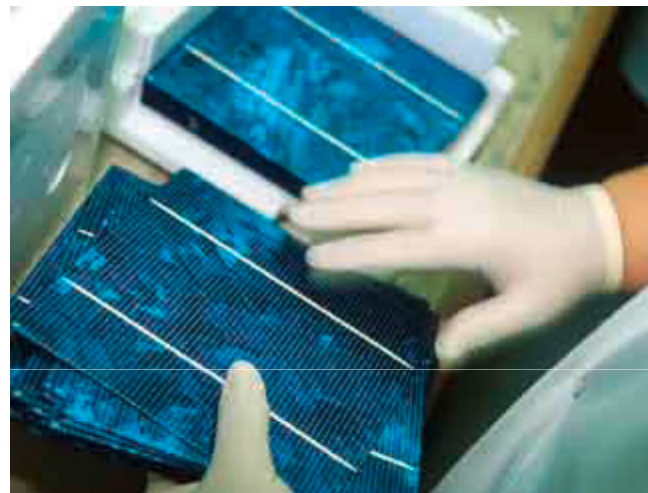



© Prof. Ing. Michele DASSISTI

Politecnico di Bari – DMMM – V.le Japigia 182 – 70126 BARI

Tel. 080 – 596.2747; fax 080-5962.788; mobile: 329 650 6022; m.dassisti@poliba.it

ASSOCIATION
PV CYCLE

Operator	Procedure	Size/Stage of development	PV technology
Deutsche Solar AG	Thermal separation, processing	Pilot production ecological consideration	Crystalline, Thin film in laboratory
First Solar	Thermal decomposition in Inert Gas	Laboratory	Crystalline
Isofoton	Cell recycling Swelling Shredding Reparable module	Laboratory	Crystalline
AIST, Sharp, Asahi	Wafer recycling with mineral acids Solvent swelling Reparable module	Laboratory	Crystalline
Photovoltech	Reparable module	Laboratory	Crystalline
BP Solar, Soltech, Seghers	Wafer recycling with mineral acids Wafer recycling in fluidized bed	Laboratory/technical college	Crystalline
Pilkington Solar International	Thermal separation	Laboratory	Crystalline
Siemens Solar, Shell Solar, Showa Shell	Ferro silicon production High pressure water jet	Laboratory	Crystalline, Thin film
Other	Module shredder Mechanical separation Acid treatment Smelter MWI Concrete aggregates Road construction	Laboratory	Crystalline, Thin film
Disposer	Removal of frame and cable	Production	all

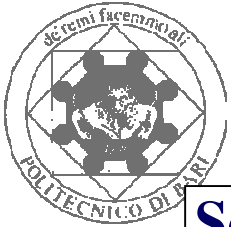

Schematic process of recycling of PV modules in Si-C

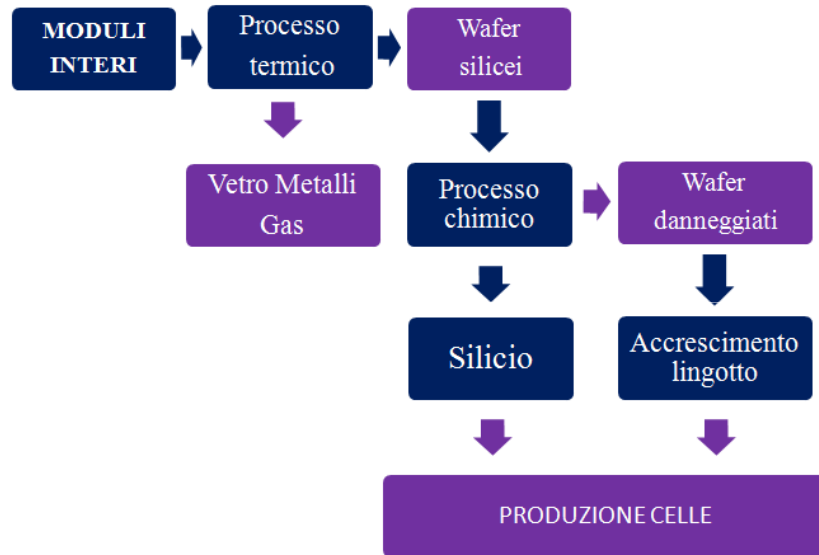

© Prof. Ing. Michele DASSISTI
 Politecnico di Bari – DMM – V.le Japigia 182 – 70126 BARI
 Tel. 080 – 596.2747; fax 080-5962.788; mobile: 329 650 6022; m.dassisti@poliba.it

Schematic process of recycling Deutsche Solar AG

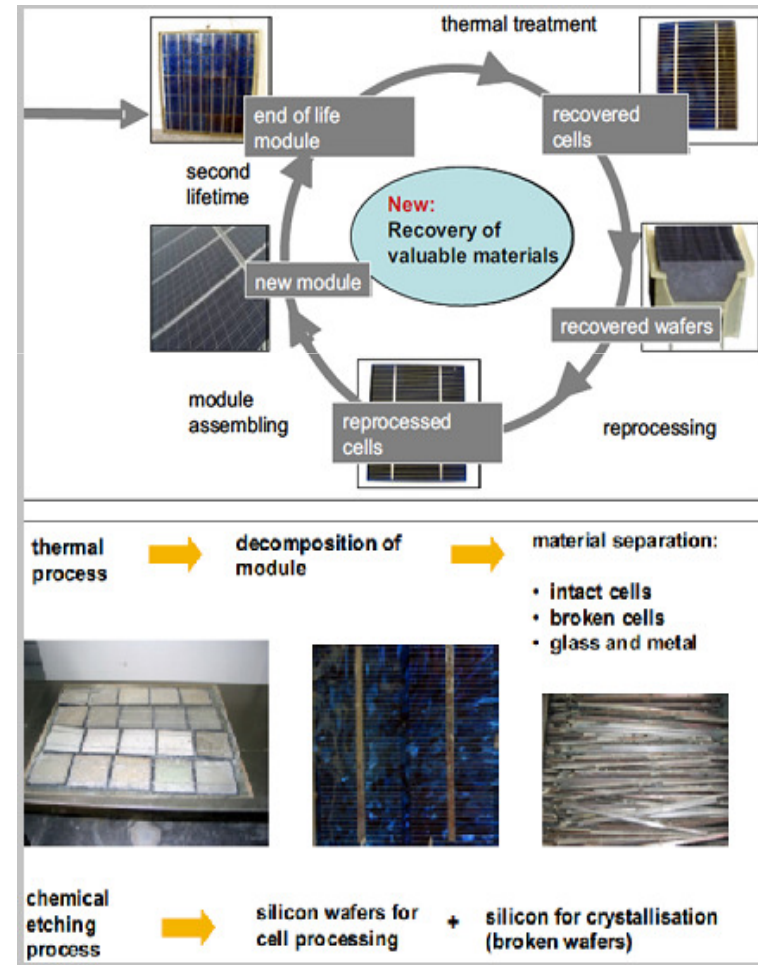



Structure of PV panels

© Prof. Ing. Michele DASSISTI

Politecnico di Bari – DMM – V.le Japigia 182 – 70126 BARI

Tel. 080 – 596.2747; fax 080-5962.788; mobile: 329 650 6022; m.dassisti@poliba.it

➤ 1[^] generation:

- 1) Al;
- 2) Glass;
- 3) EVA;
- 4) Tedlar;
- 5) Solar cells;

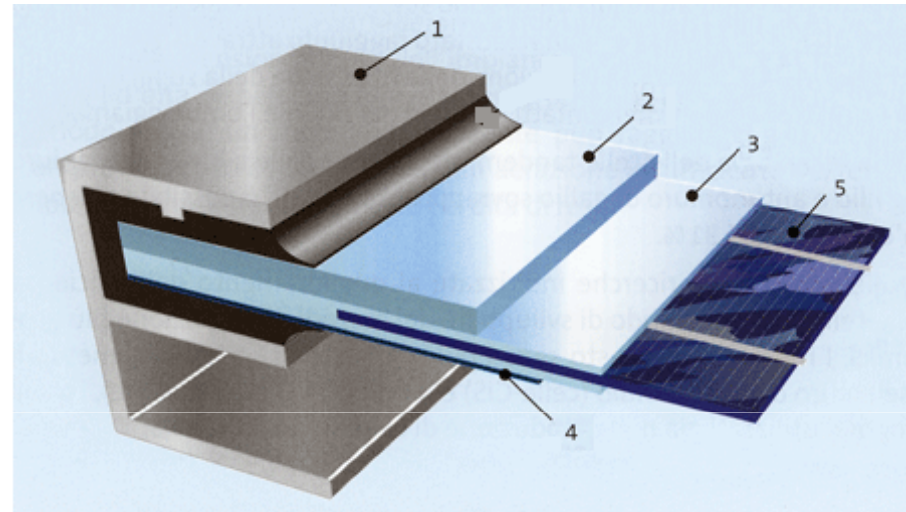

➤ 2[^] generation:

- 1) ZnO;
- 2) CdS;
- 3) CIS;
- 4) Rear metallic contact;
- 5) Glass;

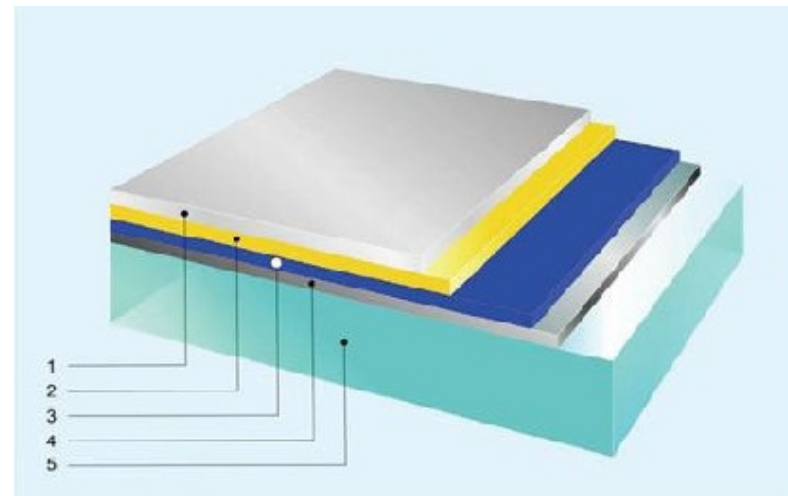



PV's_: End of Life

- Operative end-of-life after 25-30 years:
 - *Physical degradation of Balance of System*
 - *Delamination, degradation of interconnections, semiconductors...*



BENCHMARKING RECYCLING SOLUTIONS



Benchmarking EOL

FIRST SOLAR

- Mechanical-chemical process
- CdTe Modules
- Recycle **crunched materials**
- Yield: 90-95%



DEUTSCHE SOLAR

- Thermo-chemical process
- SiC modules
- Wafer as good as news
- **High Temperatures** →



© Prof. Ing. Michele DASSISTI

Politecnico di Bari – DMMM – V.le Japigia 182 – 70126 BARI
Tel. 080 – 596.2747; fax 080-5962.788; mobile: 329 650 6022; m.dassisti@poliba.it



Benchmarking EOL

LCA = Life Cycle Assessment → *Impact Assessment*

© Prof. Ing. Michele DASSISTI
 Politecnico di Bari – DMMM – V.le Japigia 182 – 70126 BARI
 Tel. 080 – 596.2747; fax 080-5962.788; mobile: 329 650 6022; m.dassisti@poliba.it

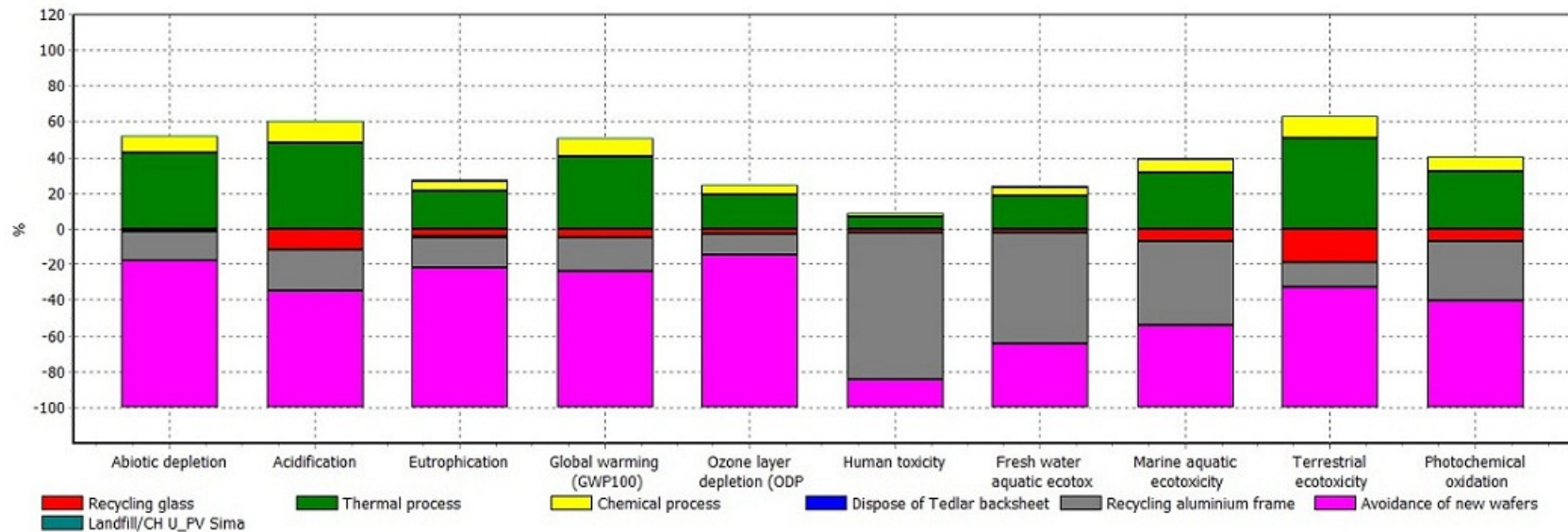

Recycling phase and disassembly Deutsche Solar
 [CML 2 baseline 2000 / West Europe 1995]



Cryogenic disassembly patent

Disassembly with the like-new material extraction

© Prof. Ing. Michele DASSISTI

Politecnico di Bari – DMMM – V.le Japigia 182 – 70126 BARI
Tel. 080 – 596.2747; fax 080-5962.788; mobile: 329 650 6022; m.dassisti@poliba.it

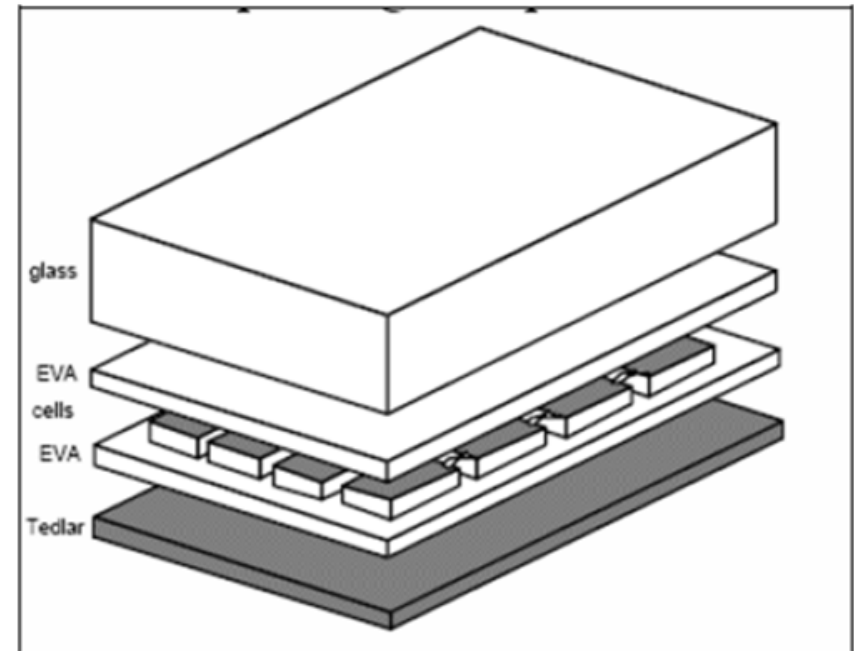



Comparing two EOL scenarios

Deutsche Solar (high value) vs landfill scenarios for
1 Sic monocrystalline modulus:
RECYCLING CONVENIENCE

© Prof. Ing. Michele DASSISTI

Politecnico di Bari – DMMM – V.le Japigia 182 – 70126 BARI

Tel. 080 – 596.2747; fax 080-5962.788; mobile: 329 650 6022; m.dassisti@poliba.it

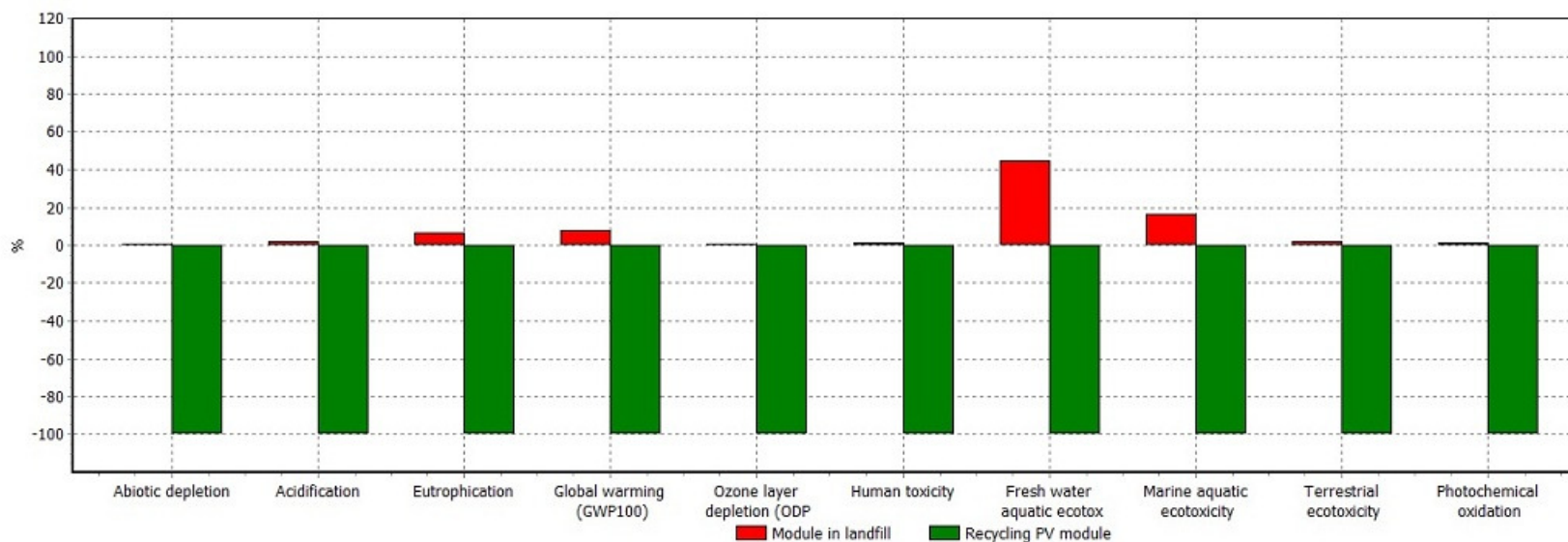

SEEP 2010



Infinite cycle of energy



4th International Conference on
Sustainable Energy & Environmental Protection

June 29/July 02, 2010
Politecnico di Bari, BARI - ITALY

© Prof. Ing. Michele DASSISTI
Politecnico di Bari – DMMM – V.le Japigia 182 – 70126 BARI
Tel. 080 – 596.2747; fax 080-5962.788; mobile: 329 650 6022; m.dassisti



Does
DON CHISCIOTTE
Be in the truth????



LCA: An example from literature

**CONTEXT: on-shore;
20 year scenario**

**SCOPE: assess sustainability
of electricity production**

850 kW

➤ a rotor diameter of 52 m

3 MW

➤ rotor diameter of 90 m

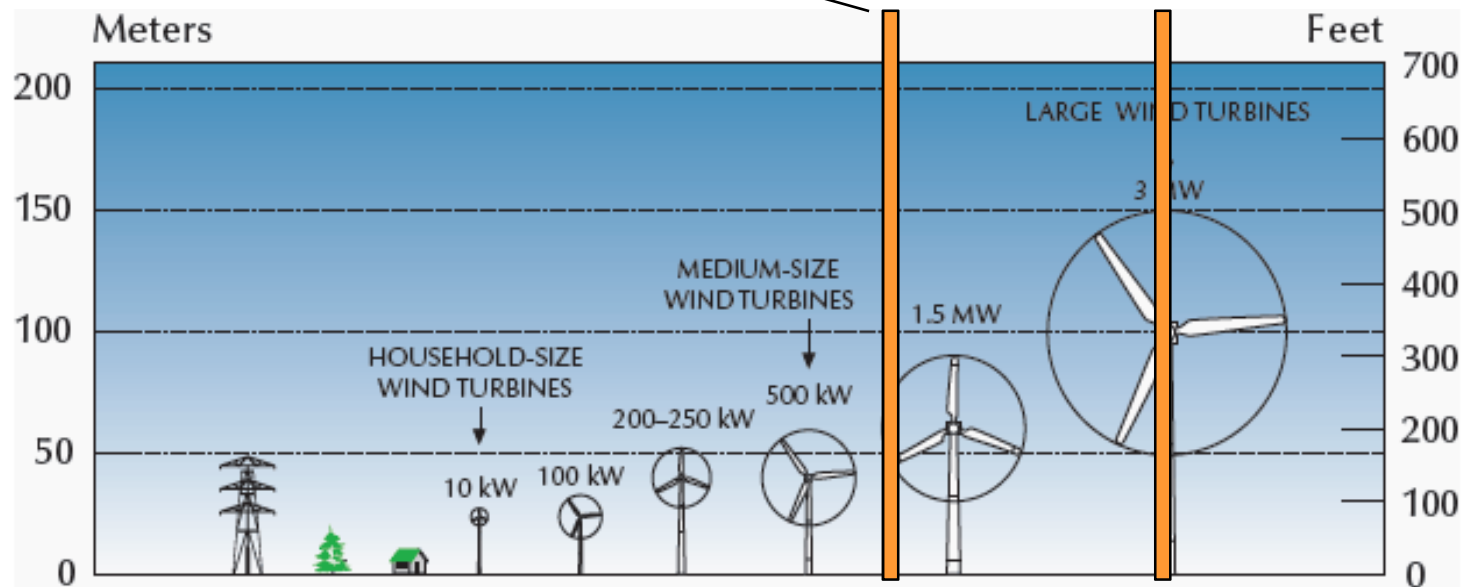



The benchmarked turbines

© Prof. Ing. Michele DASSISTI

Politecnico di Bari – DMMM – V.le Japigia 182 – 70126 BARI

Tel. 080 – 596.2747; fax 080-5962.788; mobile: 329 650 6022; m.dassisti@poliba.it

Component	Item	Wind turbine (3.0 MW)		Wind turbine (850 kW)	
		WEIGHT	MATERIALS	WEIGHT	MATERIALS
Foundation	Reinforced concrete	1220 t	1200 t concrete	495 t	480 t concrete
			20 t steel		15 t steel
Tower	Painted steel	276 t	275 t steel	70 t	69.07 t steel
			1 t paint		0.93 t paint
Nacelle	Generator	8,5 t	5,525 t steel	1.84 t	1.47 t steel
	Gearbox		2,975 t copper		0.37 t copper
23 t		22,54 t steel	6.2 t	6.08 t steel	
		0,23 t copper		0.062 t copper	
		0,23 t aluminium		0.062 t aluminium	
Rotor	Frame, Machinery & Shell	37 t	31,45 t steel	13,9 t	12,644 t steel
			2,96 t aluminium		0,6 t aluminium
			1,258 t copper		0,537 t copper
			0,011 t glass fibre		0,18 t glass fibre
Rotor	Hub	8,5 t	8,5 t cast iron	4.8 t	4.8 t steel
	Nose cone	11,5 t	11,5 t glass fibre	5,6 t	5,6 t glass fibre
	Blade (3 per rotor)	6,6 t	4,35 t glass fibre	5.02 t	3.01 t glass fibre
		2,25 t epoxy		2.01 t epoxy	



Application of the frame

RULE 1:

**SPECIFICATION on PHYSICAL
TRANSFORMATIONS**

RULE 3:

**DATA
SOUNDNESS**



RULE 2:

**SPATIAL AND TEMPORAL
CONSISTENCY**



PLANET: LCA (Ecoinvent Database): R1 & R2&R3

© Prof. Ing. Michele DASSISTI
 Politecnico di Bari – DMMM – V.le Japigia 182 – 70126 BARI
 Tel. 080 – 596.2747; fax 080-5962.788; mobile: 329 650 6022; m.dassisti@poliba.it

Manufacturing and erection

(‘Environmental Statement 2004’ of Vestas

and from the Australian National Accounts) + mainly fuel (diesel) [24]. Transportation distances have been considered equal to 100 km.

Operation and maintenance

(personnel is transported by diesel car)+ (Gear and gearbox are assumed to be replaced once during this period)

Disposal scenario

(90% of steel, cast iron and copper are recycled while the remaining parts are sent to landfill) + (Transportation distances are assumed to be, in average, equal to 200 km.)

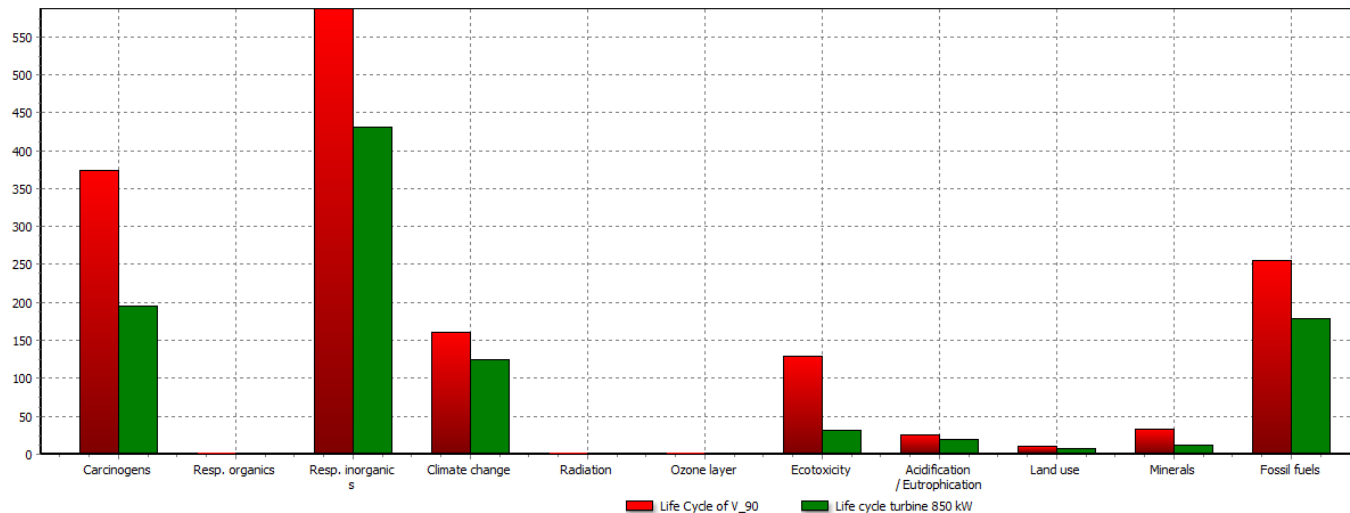

Comparing 1 p 'Life Cycle of V_90' with 1 p 'Life cycle turbine 850 kW';
 Method: Eco-indicator 99 (h) V2.08 / Europe EI 99 H/H / Normalization

Normalized comparison between 3MW wind turbine and a 850 kW wind turbine life cycles (SIMA-PRO(R) v.7.3 - Eco Indicator 99)



LCA: Life cycle of the wind turbine in SimaPro 7.3

© Prof. Ing. Michele DASSISTI

Politecnico di Bari – DMMM – V.le Japigia 182 – 70126 BARI

Tel. 080 – 596.2747; fax 080-5962.788; mobile: 329 650 6022; m.dassisti@poliba.it

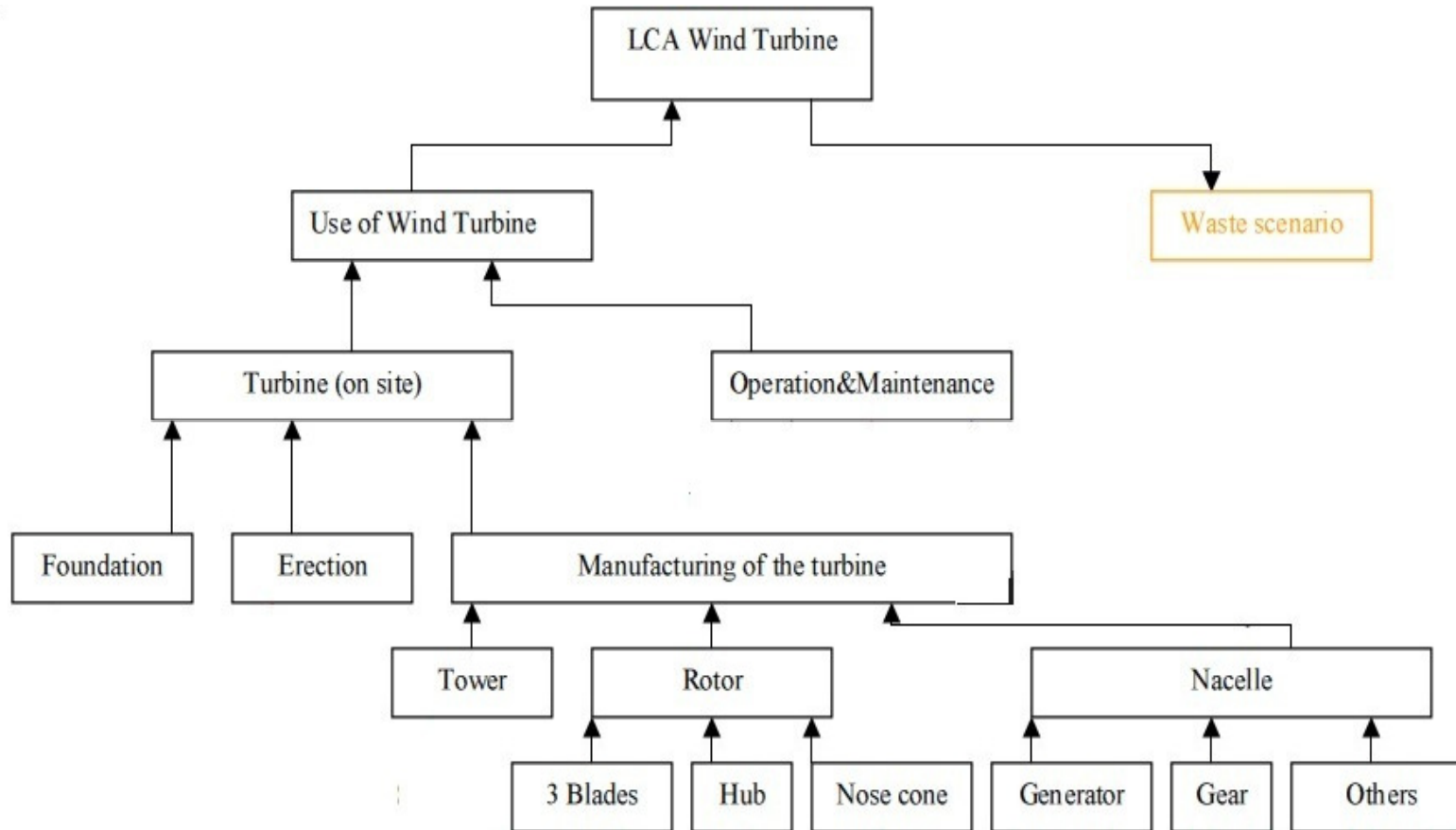



LCA: Network of the life cycle of the 3MW turbine

© Prof. Ing. Michele DASSISTI

Politecnico di Bari – DMMM – V.le Japigia 182 – 70126 BARI

Tel. 080 – 596.2747; fax 080-5962.788; mobile: 329 650 6022; m.dassisti@poliba.it

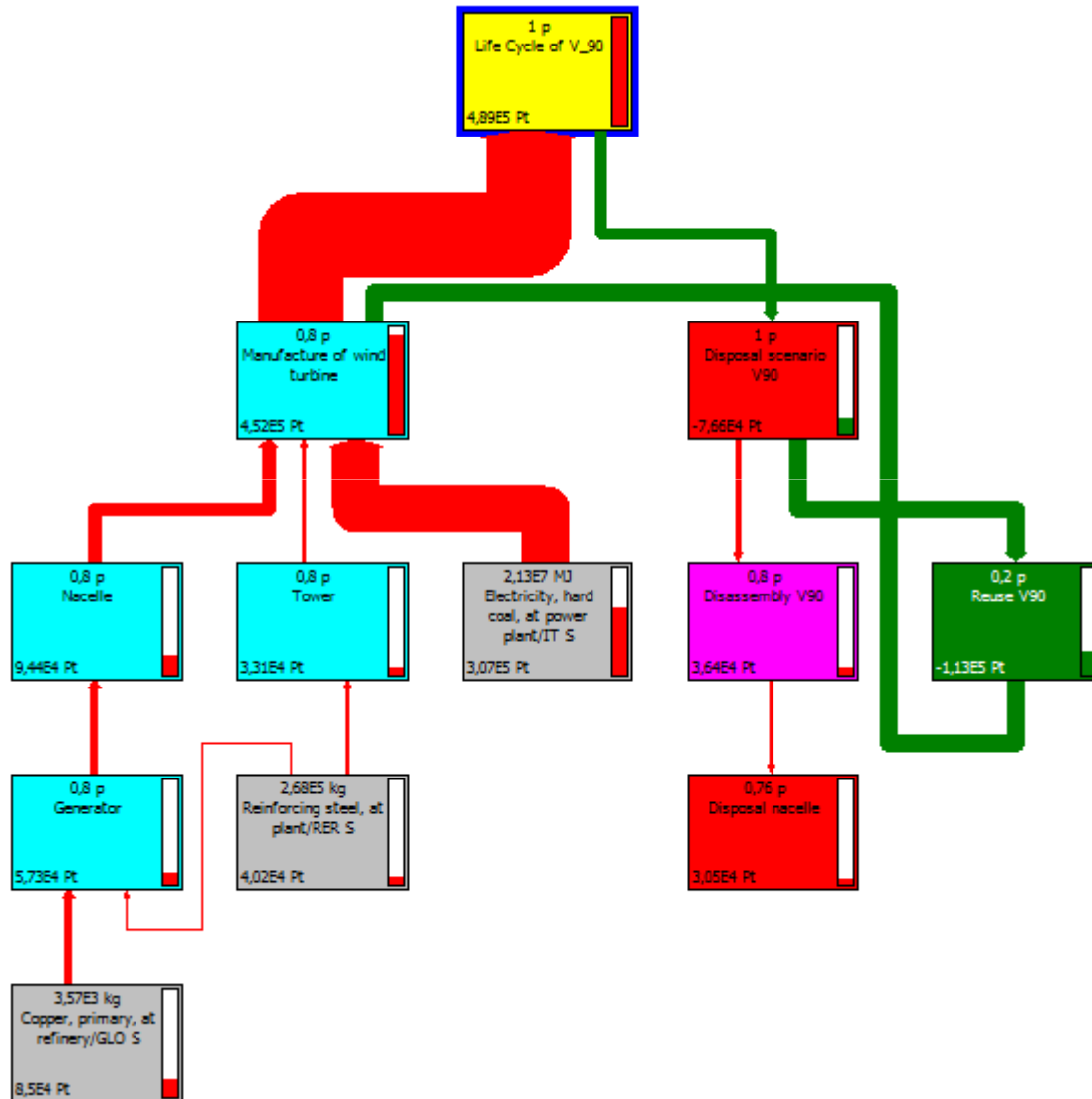



PROFIT & PEOPLE: missing!

© Prof. Ing. Michele DASSISTI

Politecnico di Bari – DMMM – V.le Japigia 182 – 70126 BARI
Tel. 080 – 596.2747; fax 080-5962.788; mobile: 329 650 6022; m.dassisti@poliba.it

❑ Vestas, “General Specification V90 – 3.0 MW 60 Hz Variable Speed Turbine.” 2004

As well as in

❑ G. Stonge, “Energy Development.” 2011.



Partial Conclusions: missings

- The 850 kW has a lower negative influence on the environment. (Nevertheless, it must be also taken into account that in favorable weather and wind conditions the output energy of the turbine of 3 MW is greater than that of the turbine of 850 kW.)
- The waste scenario is very important to the environmental profile of the wind power (The benefits come, above all, from the almost complete recycling of the steel (90%), the cast iron (90%) and the copper (90%))
- The most sensitive scenario is the manufacturing phase, in particular the use of the electricity mix used for the production of the materials



Why a frame...

- I. The frame needs to be applied to have a wider view of problems: more data and efforts are thus required to do so otherwise.....
- II. Benchmarking frame is easy to use and congruent



Assessing sustainability

© Prof. Ing. Michele DASSISTI

Politecnico di Bari – DMMM – V.le Japigia 182 – 70126 BARI

Tel. 080 – 596.2747; fax 080-5962.788; mobile: 329 650 6022; m.dassisti@poliba.it

5



Paradox :

Uniqueness of measurement

- When searching for the uniformity of views about eco-approaches (UNIVOCAL UNDERSTANDING) , i.e. by adopting a top-down approach
- We are (NOT UNDERSTANDING) the system which is characterised by variety

- *«Any attempt to impose uniform solutions of global environmental problems will threaten the diversity of the earth's regions and cultures in the same way that economic globalization does now..»*

Komiyama, 2006



OFFICIAL PERFORMANCES

By Electrolux – Sustainability Report, 2006

© Prof. Ing. Michele DASSISTI

Politecnico di Bari – DMMM – V.le Japigia 182 – 70126 BARI

Tel. 080 – 596.2747; fax 080-5962.788; mobile: 329 650 6022; m.dassisti@poliba.it

Investors rank Electrolux

Several socially responsible investment indices include the Electrolux Group as a constituent company, including Dow Jones STOXX Sustainability Index and the FTSE4Good Series. The Group is also ranked highly by Oekom Research in Germany, KLD Research and Analytics Inc. which has ranked Electrolux among its Global Climate 100 Index. In 2006 Electrolux topped an environmental performance review of the companies listed on the Stockholm Stock Exchange that was conducted by one of Sweden's most prominent sustainability fund managers, Banco Fonder. Electrolux was recognized for integrating environmental thinking in all aspects of operations, for reporting practices and striving to be transparent about performance.





PLAN: the analysis of sustainability

© Prof. Ing. Michele DASSISTI

Politecnico di Bari – DMMM – V.le Japigia 182 – 70126 BARI
Tel. 080 – 596.2747; fax 080-5962.788; mobile: 329 650 6022; m.dassisti@poliba.it

This practice is relatively new, so that there is a lack of commonly accepted or mandated eco-measurement standards

SUSTAINABILITY INDEXES

COST

TECHNOLOGY

PRODUCTIVITY

ORGANISATIONAL

?

- *<<there appears to be a view that any move towards sustainability assessment will axiomatically be a 'good thing' ... >> Popea, 2004*



PLAN: the measures

© Prof. Ing. Michele DASSISTI

Politecnico di Bari – DMMM – V.le Japigia 182 – 70126 BARI

Tel. 080 – 596.2747; fax 080-5962.788; mobile: 329 650 6022; m.dassisti@poliba.it

ECO-INDICATORS
based on:

- Provided we do not have an unique definition of sustainability and that hopefully it is multifaceted because of diversity of world, what does then it means to measure sustainability?

MODEL

LIFE-CYCLE

STANDARDS

ORGANISATIONAL

?

- *«...while these criteria and indicators (related to sustainability) must conform to scientific standards of objectivity, they must not be expected to yield a singular solution to any given problem. ...» Komiyama, 2006*



Sensitivity analysis

- In SETAC's 'Code of practice' (1993) sensitivity and uncertainty analysis are recommended, but the methodology is not very well developed.
- In the ISO 14040 sensitivity analysis is requested (ISO 1997a).



Sensitivity analysis

Analysis of uncertainty and sensitivity is important but too seldom carried out. Life cycle assessments are normally made without quantitative estimations of accuracy or precision.

© Prof. Ing. Michele DASSISTI
 Politecnico di Bari – DMIM – V.le Japigia 182 – 70126 BARI
 Tel. 080 – 596.2747; fax 080-5962.788; mobile: 329 650 6022; m.dassisti@poliba.it

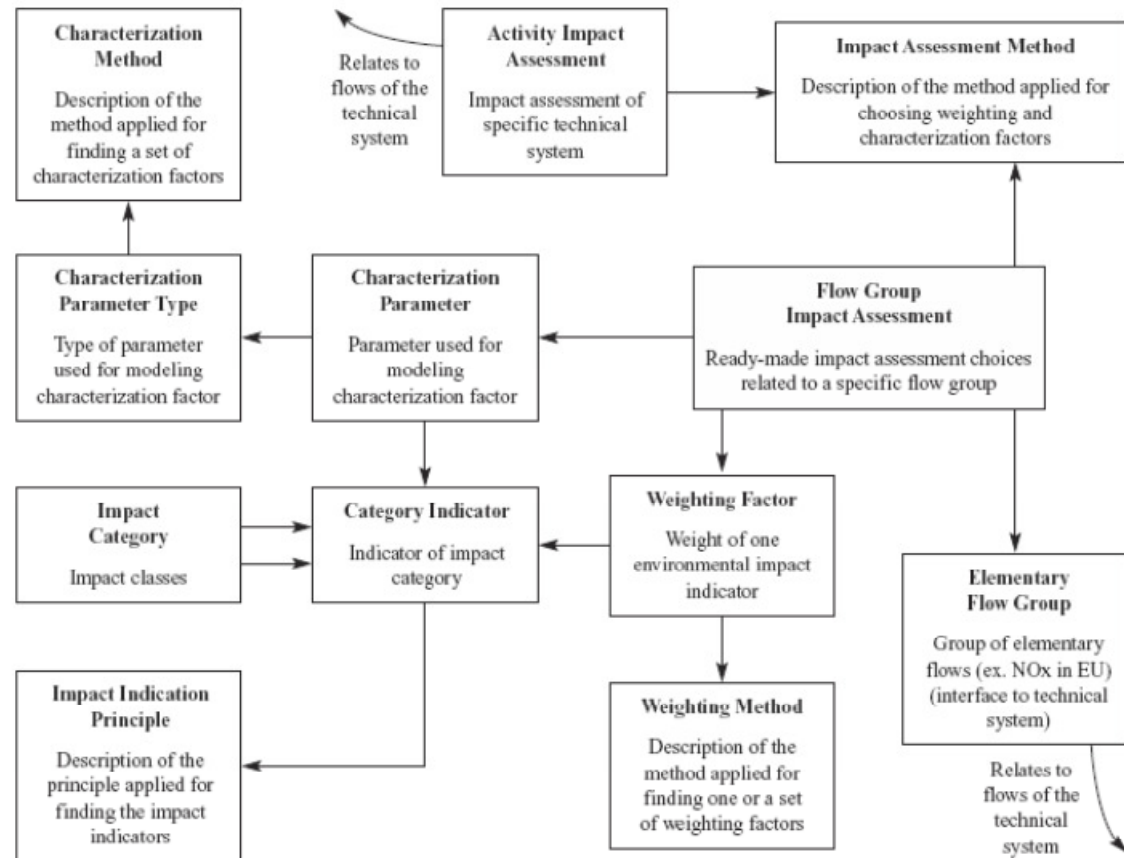



Eco_efficiency: criticisms

- One cannot use efficiency or the conventional Pareto optimal efficiency as the goal or overall vision of sustainable development.

1. because of path dependency and technological lock-in, inefficient technologies and management practices may become the dominant ones

2. efficiency in production reduces costs and eventually prices of end-products. This can boost up demand and eventually the overall macroeconomic growth environmental impacts

3. even if the most efficient environmental solution is known, it risks the space needed for future sustainability. Due to uncertainty, it is impossible to know what will be required in the future



Eco_efficiency

- Eco-efficiency (EE) EE is defined as reduced resource use and/or waste and emission generation per unit of output of production
- Or as Brattebo puts it “units of value generation per unit of environmental influence”

The basic notion of efficiency has been and continues to be central for the dominant economics theory of neoclassical economics.
In neoclassical economics, efficiency is applied in the 'maximum power' sense



Sustainable Manufacturing

© Prof. Ing. Michele DASSISTI

Politecnico di Bari – DMMM – V.le Japigia 182 – 70126 BARI

Tel. 080 – 596.2747; fax 080-5962.788; mobile: 329 650 6022; m.dassisti@poliba.it

6



Manufacturing

© Prof. Ing. Michele DASSISTI

Politecnico di Bari – DMM – V.le Japigia 182 – 70126 BARI
Tel. 080 – 596.2747; fax 080-5962.788; mobile: 329 650 6022; m.dassisti@poliba.it

- Manufacturing industry has great relevance in modern history.
- The first industrial revolution – based on the manufacturing industry – was a divide between “ancient and new worlds”.
- And, as such, it is a fundamental part of the first Kondratiev long wave that depicts economic development related, but not exclusively, to technological innovations.



Manufacturing

© Prof. Ing. Michele DASSISTI

Politecnico di Bari – DMMM – V.le Japigia 182 – 70126 BARI

Tel. 080 – 596.2747; fax 080-5962.788; mobile: 329 650 6022; m.dassisti@poliba.it

Science Based Industry

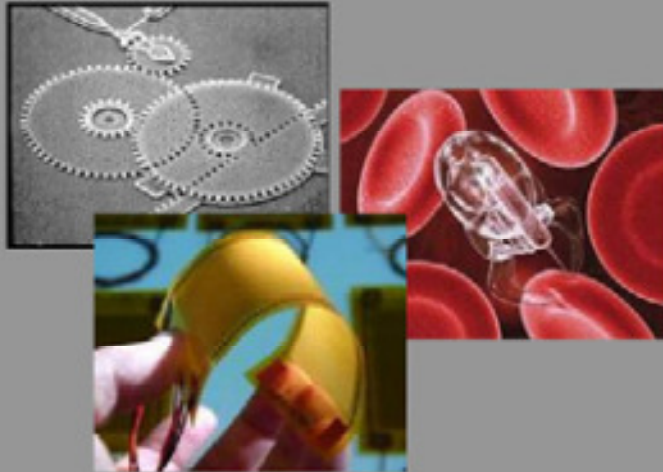

Specialized Supplier Industry



Scale Intensive Industry



Traditional Industry





Finitedness of resources

© Prof. Ing. Michele DASSISTI

Politecnico di Bari – DMMM – V.le Japigia 182 – 70126 BARI

Tel. 080 – 596.2747; fax 080-5962.788; mobile: 329 650 6022; m.dassisti@poliba.it

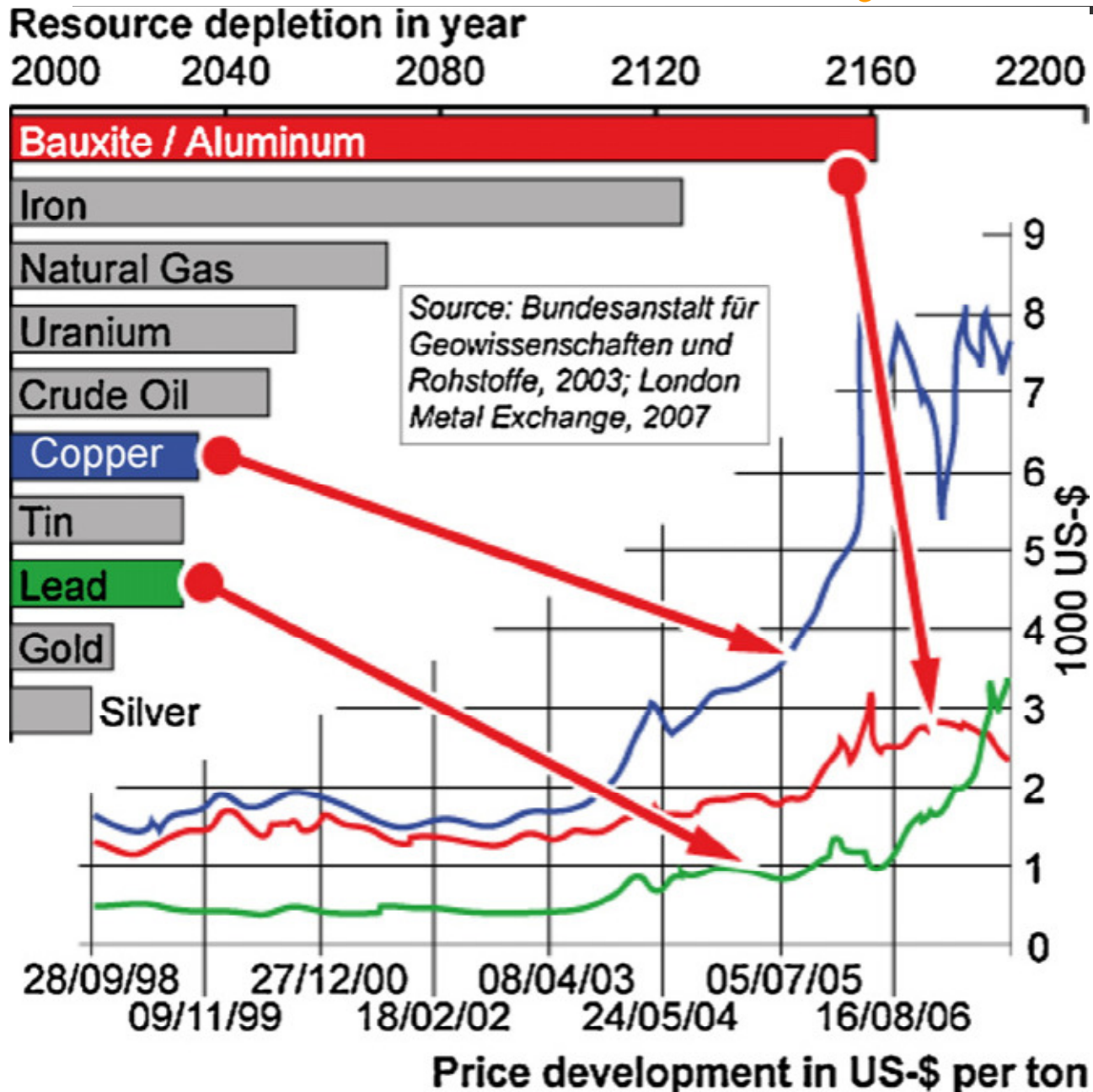

Jovane, 2008



Manufacturing Sustainability

© Prof. Ing. Michele DASSISTI

Politecnico di Bari – DMMM – V.le Japigia 182 – 70126 BARI

Tel. 080 – 596.2747; fax 080-5962.788; mobile: 329 650 6022; m.dassisti@poliba.it

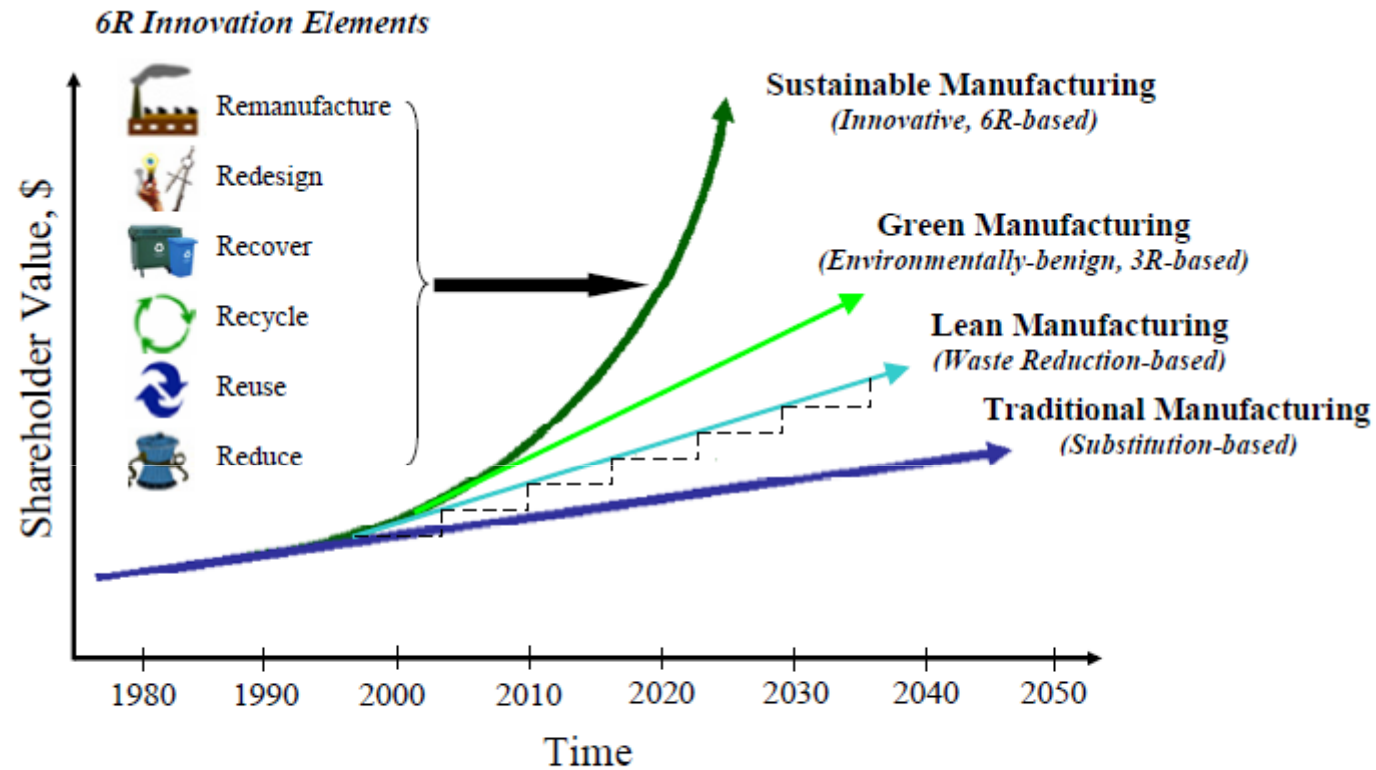

Figure 2 The evolution of sustainable manufacturing for the 21st century

I.S. Jawahir, 2007



Sustainable manufacturing

- *Creation of manufactured products that use processes that are non-polluting, conserve energy and natural resources, and are economically sound and safe for employees, communities, and consumers.”* USA- Dept. Of Commerce

© Prof. Ing. Michele DASSISTI

Politecnico di Bari – DMMM – V.le Japigia 182 – 70126 BARI
Tel. 080 – 596.2747; fax 080-5962.788; mobile: 329 650 6022; m.dassisti@poliba.it

The lesser the better??
LINEAR THINKING





Competitive Sustainable Manufacturing

© Prof. Ing. Michele DASSISTI
Politecnico di Bari – DMMM – V.le Japigia 182 – 70126 BARI
Tel. 080 – 596.2747; fax 080-5962.788; mobile: 329 650 6022; m.dassisti@poliba.it

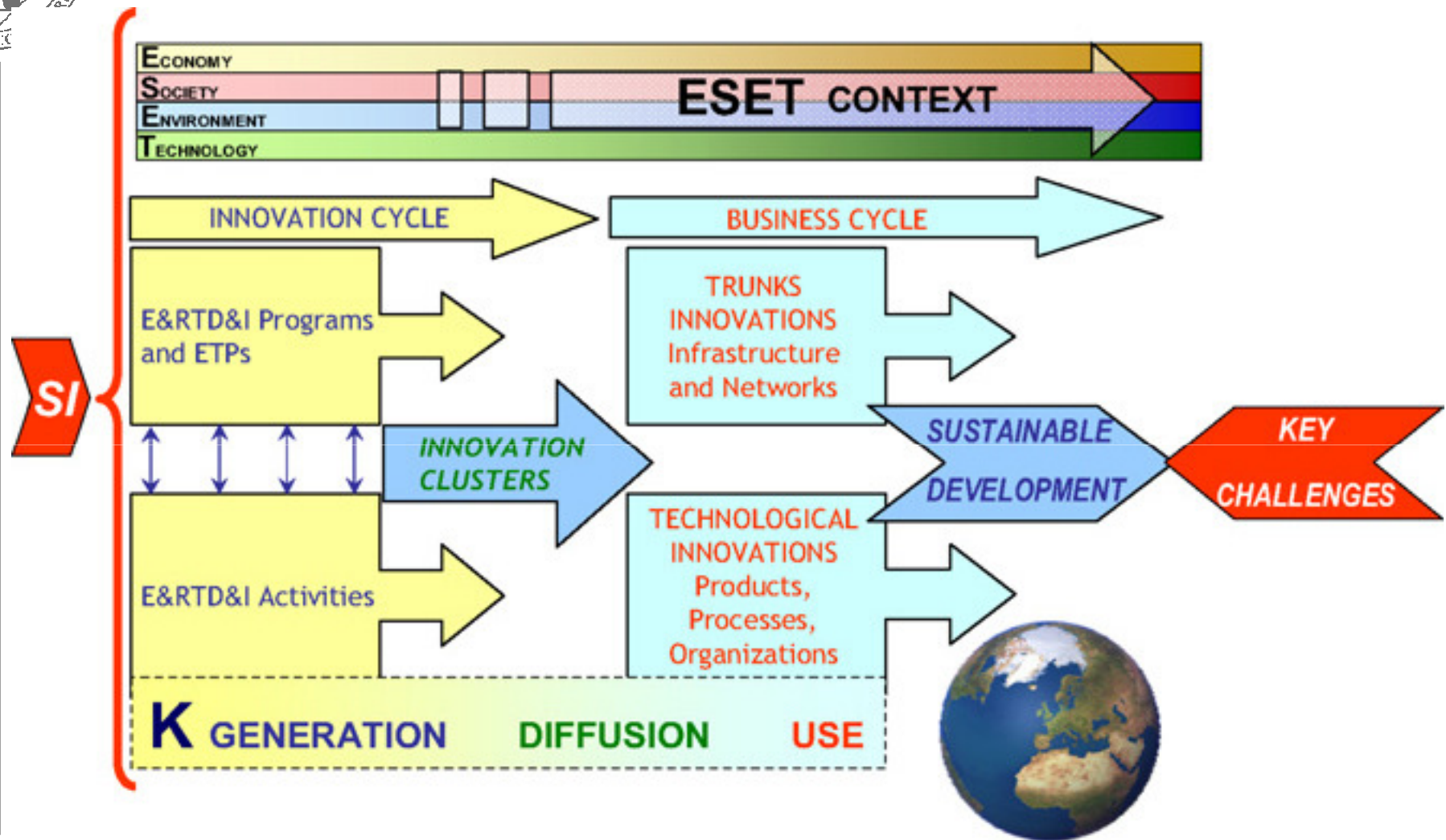

education, research and technological development and innovation (E&RTD&I) [Jovane,2008]



Function: the main issues

sustainability requires integration of manufacturing and inverse manufacturing, i.e. closed loop manufacturing

Integration of Information and Substance Loops into a Unique Loop

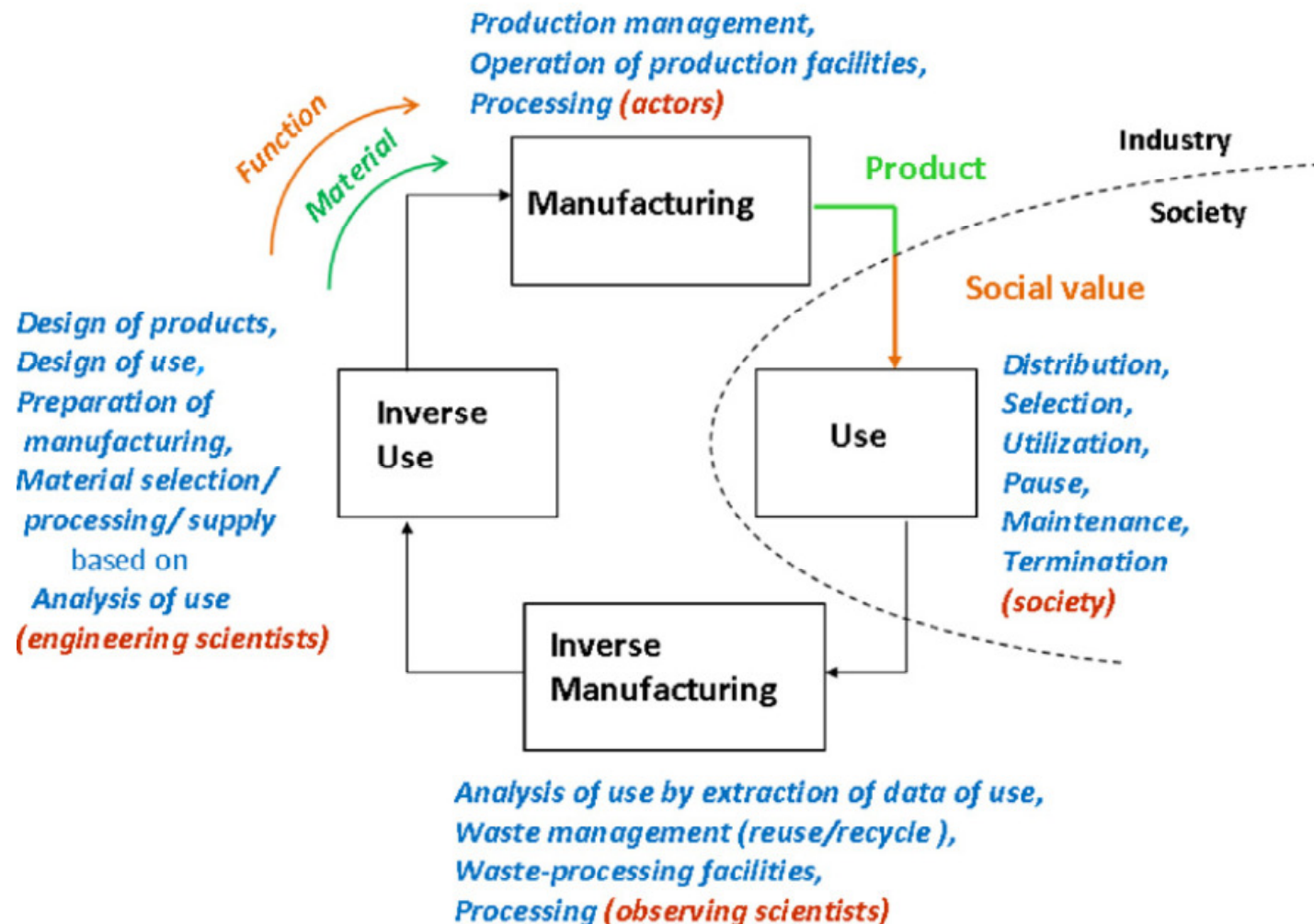



Closed-loop manufacturing

Yoshikawa introduces the minimal manufacturing and maximal servicing paradigm for sustainability

Minimal Manufacturing and Maximal Servicing for Sustainable Society

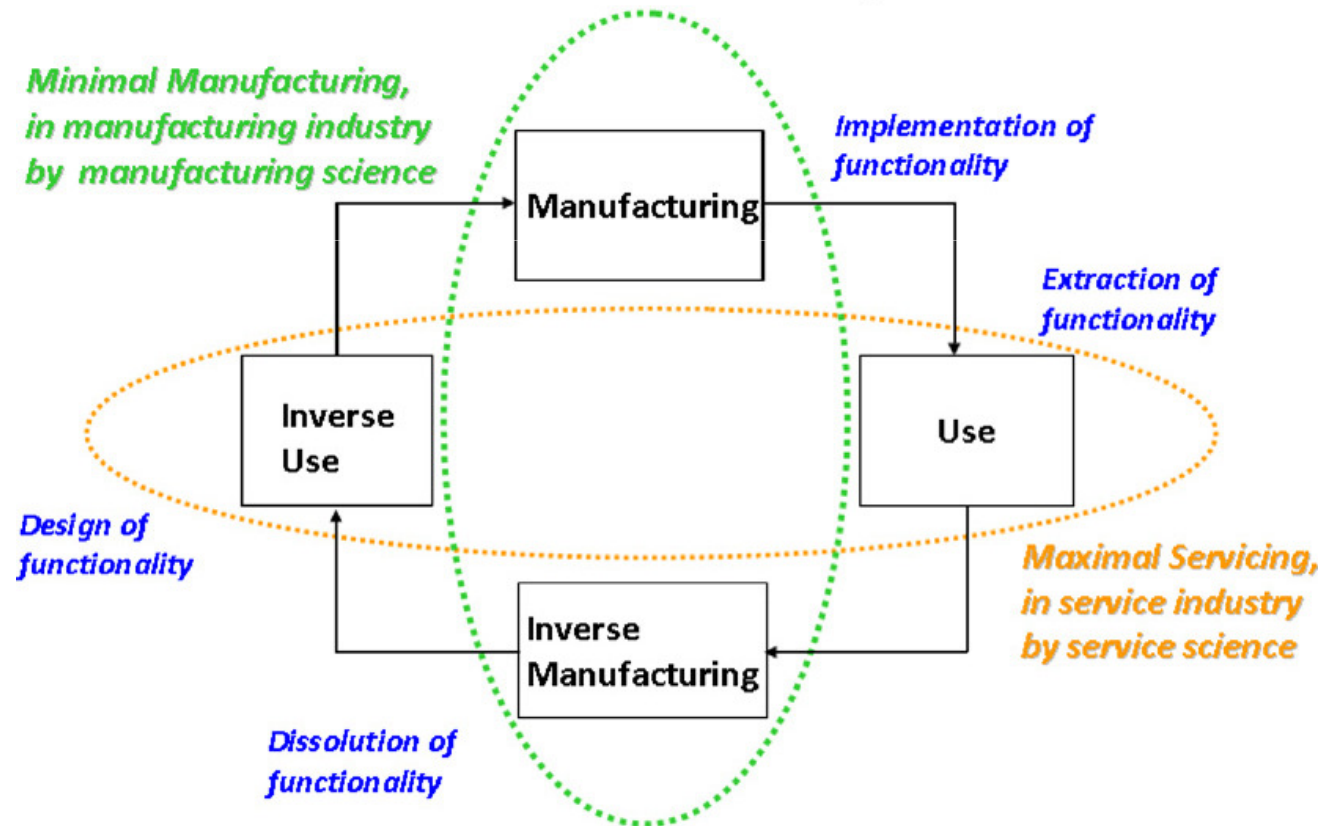

Because manufacturing industry and service industry are mutually closely connected, they must be dealt with together.



Sustainable value-creating modules in a global network

© Prof. Ing. Michele DASSISTI

Politecnico di Bari – DMMM – V.le Japigia 182 – 70126 BARI

Tel. 080 – 596.2747; fax 080-5962.788; mobile: 329 650 6022; m.dassisti@poliba.it

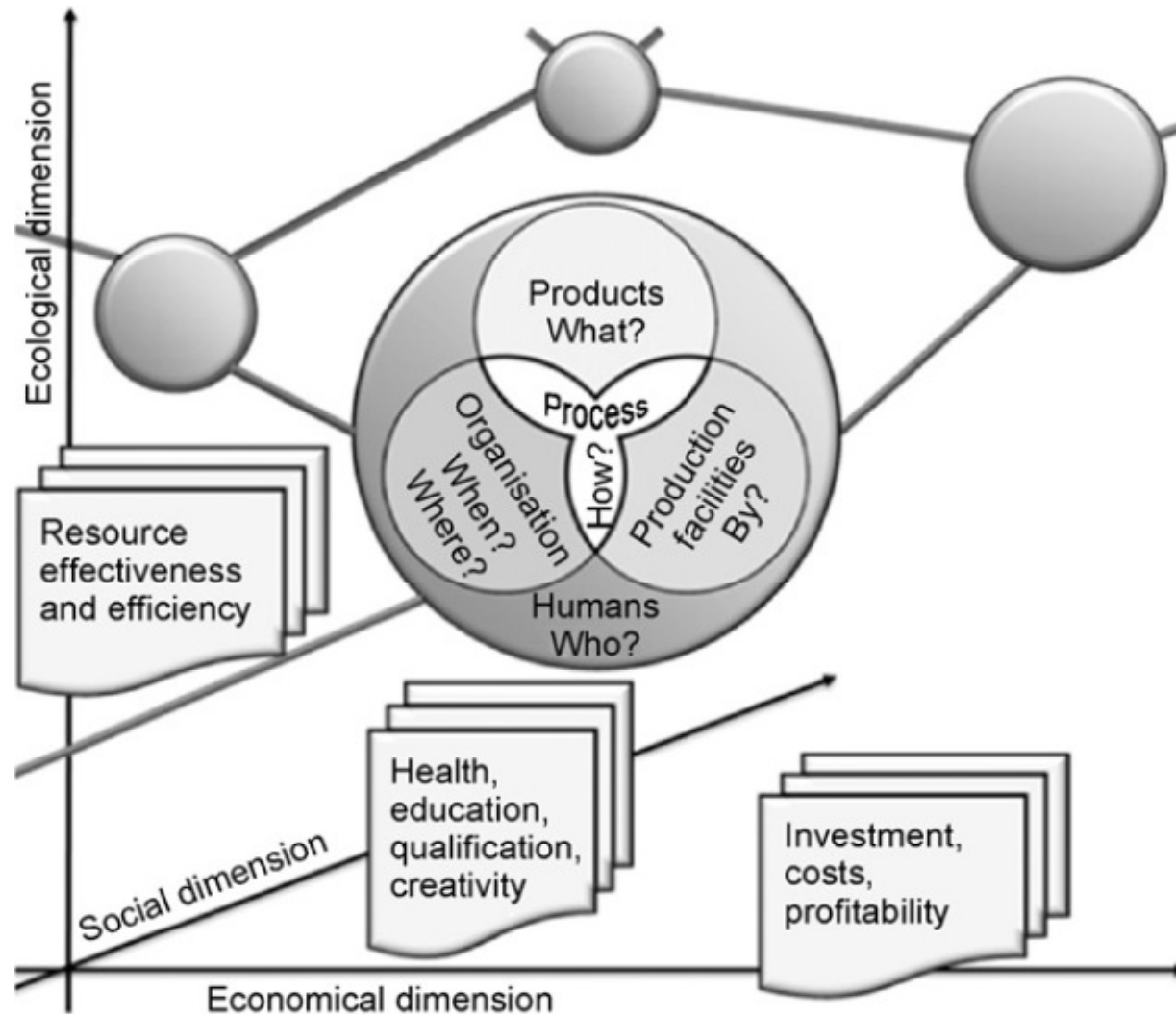



Sustainable Manufacturing

“Sustainable manufacturing adds value to materials, components, or products while maintaining the availability of natural resources and environmental quality for future generations. “

© Prof. Ing. Michele DASSISTI

Politecnico di Bari – DMMM – V.le Japigia 182 – 70126 BARI

Tel. 080 – 596.2747; fax 080-5962.788; mobile: 329 650 6022; m.dassisti@poliba.it



MANUFUTURE framework®

Strategic Intelligence & Competitive Sustainable Manufacturing

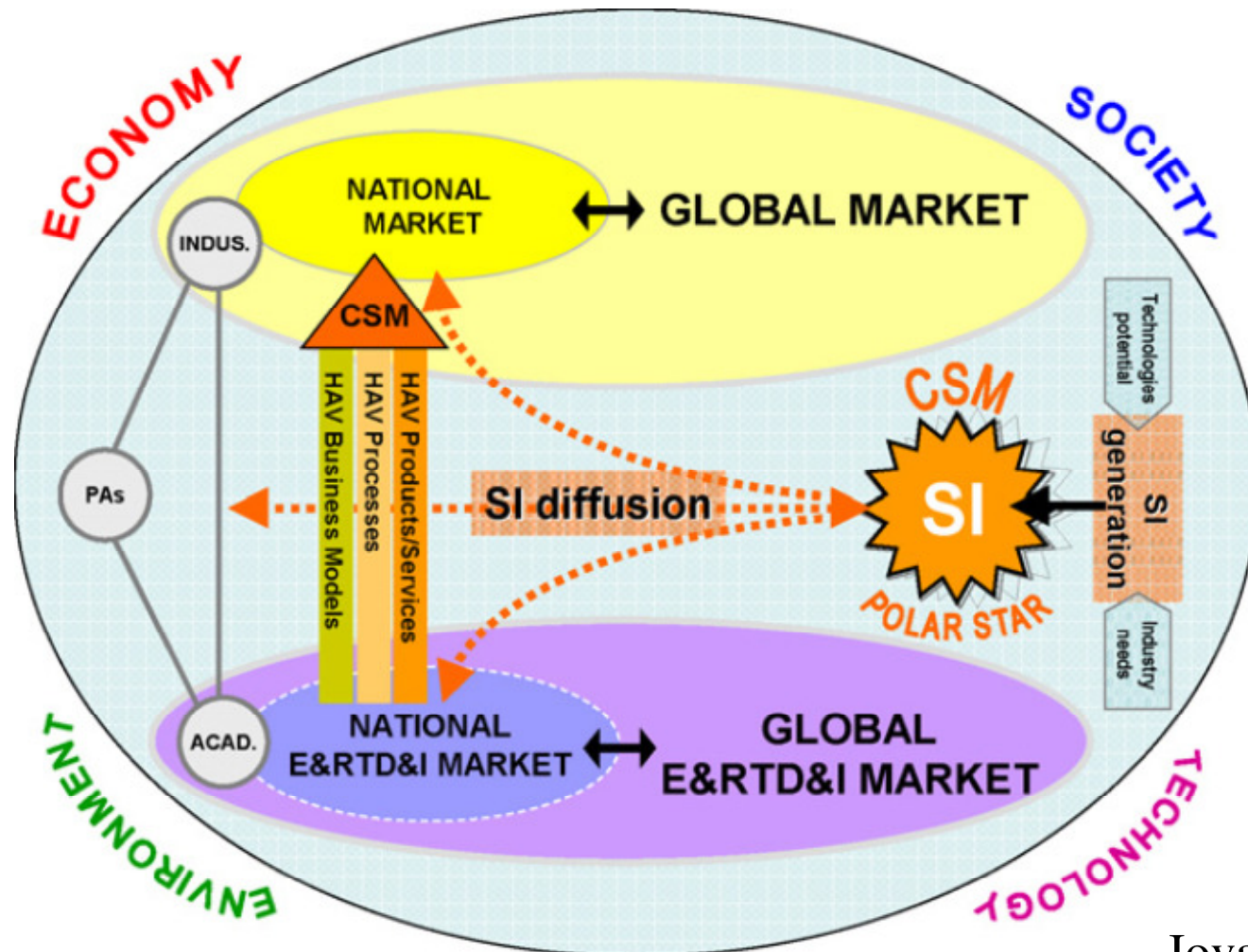



Technologies for sustainability

© Prof. Ing. Michele DASSISTI

Politecnico di Bari – DMMM – V.le Japigia 182 – 70126 BARI
Tel. 080 – 596.2747; fax 080-5962.788; mobile: 329 650 6022; m.dassisti@poliba.it

Technologies for Sustainability

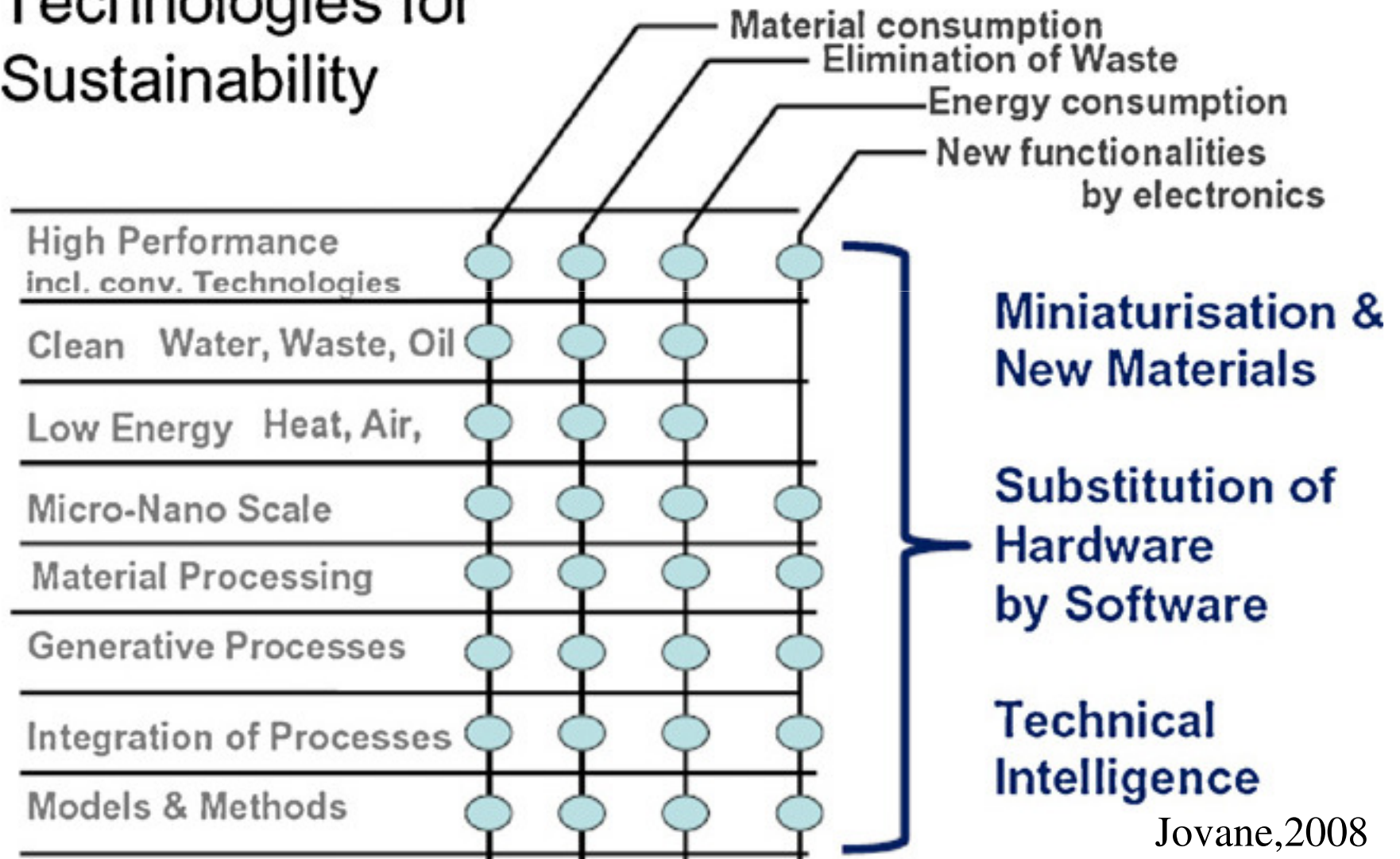

Jovane, 2008



Technologies for sustainability

© Prof. Ing. Michele DASSISTI
 Politecnico di Bari – DMMM – V.le Japigia 182 – 70126 BARI
 Tel. 080 – 596.2747; fax 080-5962.788; mobile: 329 650 6022; m.dassisti@poliba.it

Years	~ 17c	18c ~ 20c		21c ~	
Name of Age	Age of survival	Age of development		Age of sustainability	
	Manual works	Mechanization	Intelligent mechanization	Green IT (A)	Green IT (B)
Works in factory	Muscle works by human	Muscle works by power machinery		Energy conservation of power machines	
	Brain works by human		Brain works by information machinery		Energy conservation of information machinery
Technology	Manual tools	Power machinery	IT control	Energy conserving design of machine and systems with IT control	Energy conserving element, device and systems
Energy consumption					



DO: the Re-X wave

© Prof. Ing. Michele DASSISTI

Politecnico di Bari – DMMM – V.le Japigia 182 – 70126 BARI
Tel. 080 – 596.2747; fax 080-5962.788; mobile: 329 650 6022; m.dassisti@poliba.it

- 6 R's: Reduce, Reuse, Recycle, Redesign (or Rethinking), Recover and Remanufacture
- The 7th R: Regulation (systemic view..)

- *« Sustainable manufacturing processes are those which*
 - *demonstrate improved energy efficiency, and environmental*
 - *impact, reduced manufacturing cost, producing minimum*
 - *wastes and providing enhanced personal health and*
- *operational safety. »» Jawahir, 2007*



© Prof. Ing. Michele DASSISTI

Politecnico di Bari – DMMM – V.le Japigia 182 – 70126 BARI

Tel. 080 – 596.2747; fax 080-5962.788; mobile: 329 650 6022; m.dassisti@poliba.it

objectif: zéro émission

Nous pensons qu'il est possible de préserver l'équilibre entre l'homme et la nature.

Pour cela, la réduction des émissions de gaz d'échappement n'est pas notre seul objectif. En effet, Toyota conçoit déjà des moteurs Hybrides et des moteurs Diesels propres, à la pointe du progrès, mais il faut aller encore plus loin. D'un bout à l'autre du cycle de vie du véhicule, de la conception initiale au recyclage en passant par la fabrication, nous appliquons des solutions innovantes pour préserver l'environnement. C'est la seule manière d'espérer atteindre notre objectif ultime : zéro émission.

www.aimzeroemissions.eu

TOYOTA



Paradox: zero limit

- when extending this idea of minimization (ACTION) according also to the input/output analysis applied to manufacture up to its extreme consequences: it is obvious to think it is possible to have a zero-waste industrial cycle (NOT ACTION), hopefully by creating symbiotic chains between industries (null negative gradient).

- *<<many well-meaning environmentalists seem to imagine that the biosphere is a perfect recycler ... i.e., to achieve `zero emissions´ in the industrial landscape by recycling all wastes.. The idea of `zero emissions´ is based on the (false) idea that every biological waste is `food´ for some other organism... >>*



Sustainability & Automotive

© Prof. Ing. Michele DASSISTI

Politecnico di Bari – DMMM – V.le Japigia 182 – 70126 BARI

Tel. 080 – 596.2747; fax 080-5962.788; mobile: 329 650 6022; m.dassisti@poliba.it

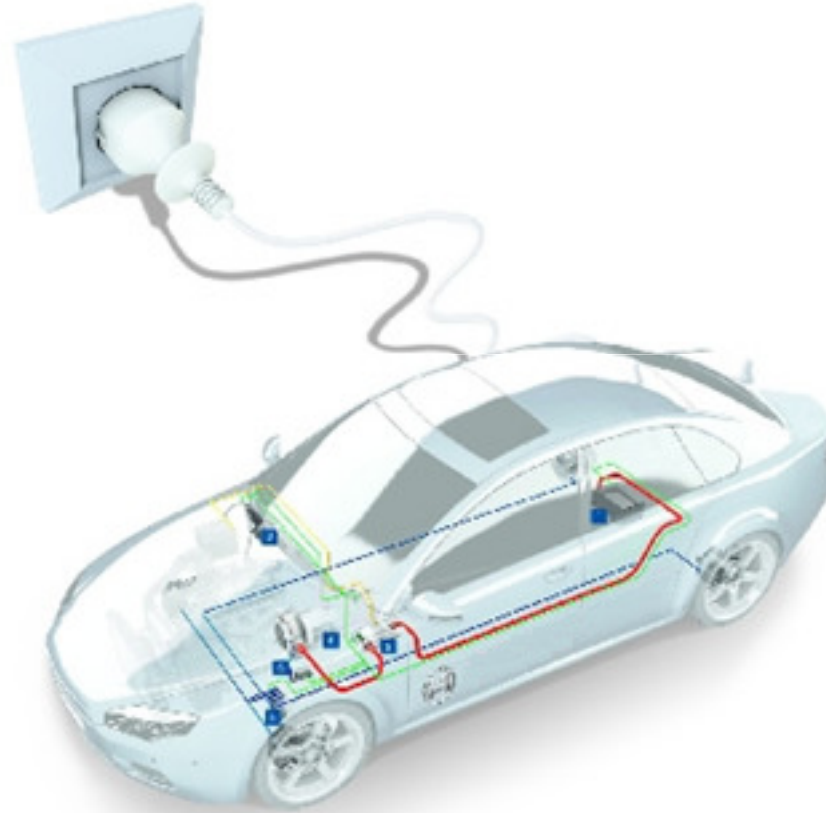



Main tendency in the automotive design: environment

Vehicles are an important source of pollution:

- Pollutant exhaust (NO_x , CO, HC, PM_x)
- CO_2 emission: a key priority
- Recycling at the end of life
- Noise

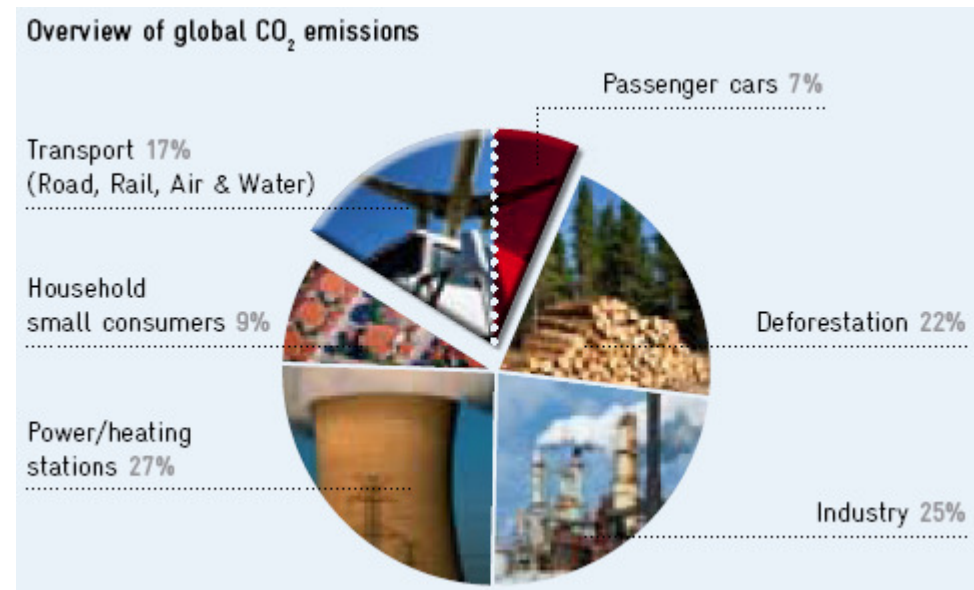
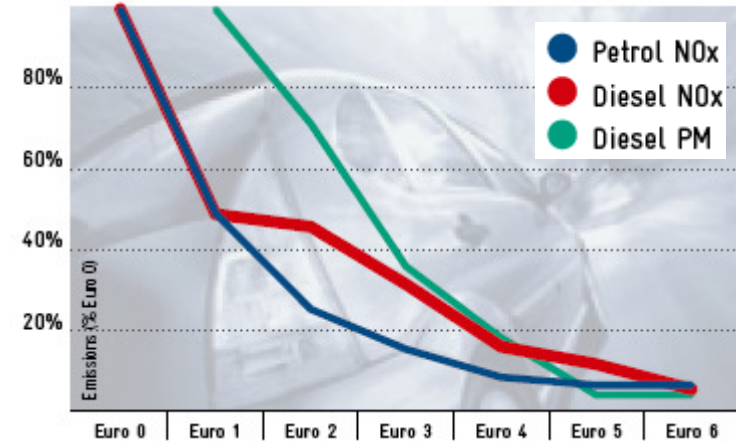



Light recyclable materials



Bumpers

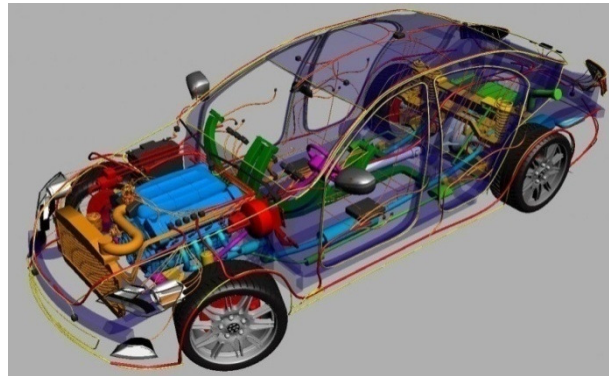

Chassis

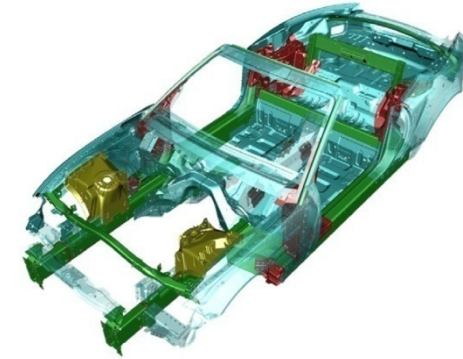

Plastics

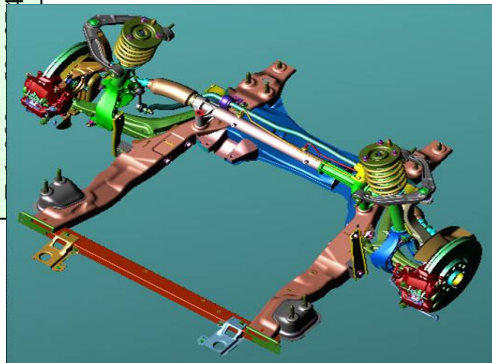

Springs

© Prof. Ing. Michele DASSISTI
Politecnico di Bari – DMMM – V.le Japigia 182 – 70126 BARI
77; fax 080-5962.788; mobile: 329 650 6022; m.dassisti@poliba.it



Chassis

- *Hybrid architecture*
multi-material approach , internal
body in thermoplastics (PA,PP) ,
metallic structure outside
(Al,steel)



- ✓ Weight reduction 30%
- ✓ Cost reduction 5,3%
- ✓ Modular Design

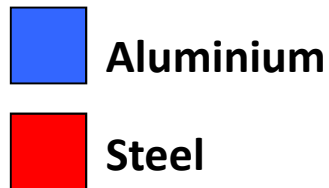
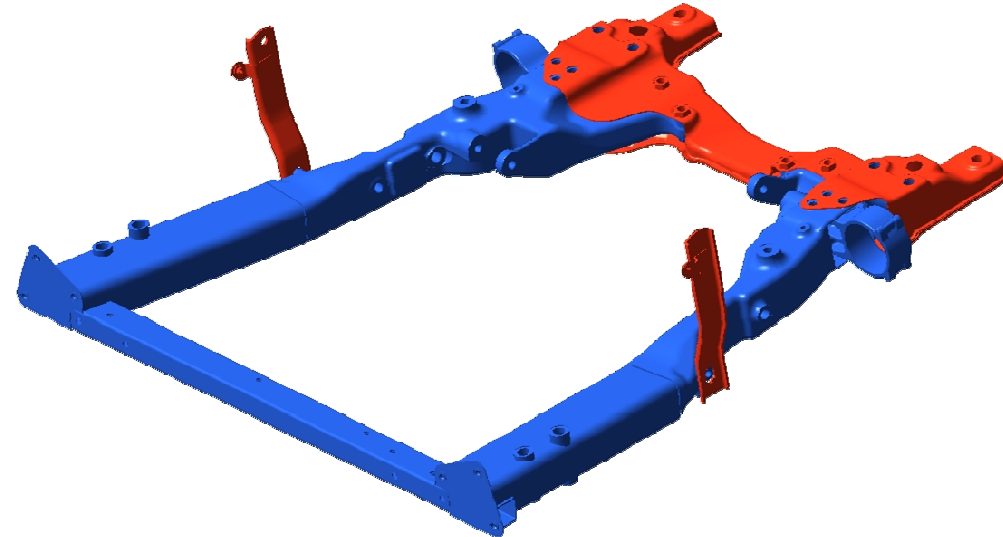



Lightweight engine subframe: Thickness optimization

Thickness optimization on the current stamped sheet frame, the existing die could be maintained using tailored blanks

Results:

+ Weight reduction of 8%

+ Low investments

- Technological feasibility is still to be assessed

© Prof. Ing. Michele DASSISTI
Politecnico di Bari – DMIMM – V.le Japigia 182 – 70126 BARI
Tel. 080 – 596.2747; fax 080-5962.788; mobile: 329 650 6022; m.dassisti@poliba.it

THICKNESS VARIATION

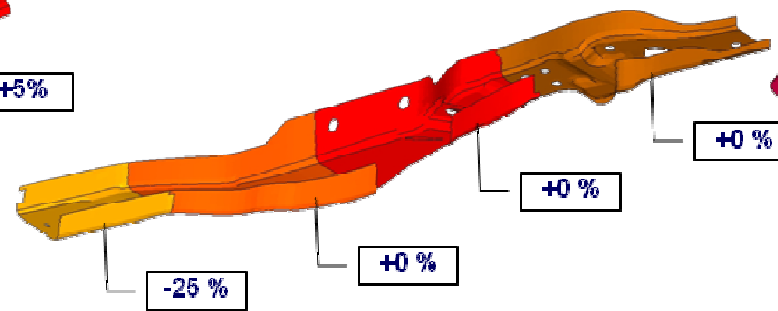
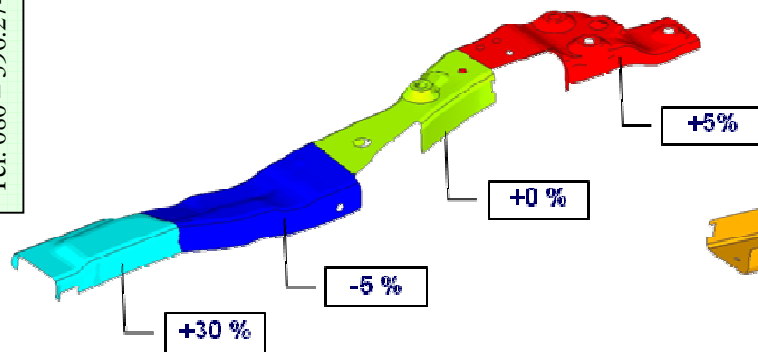

Rear cross member

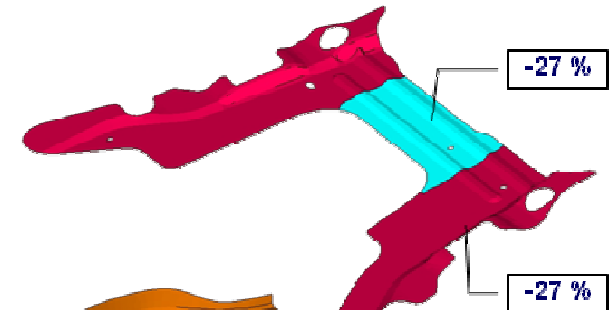
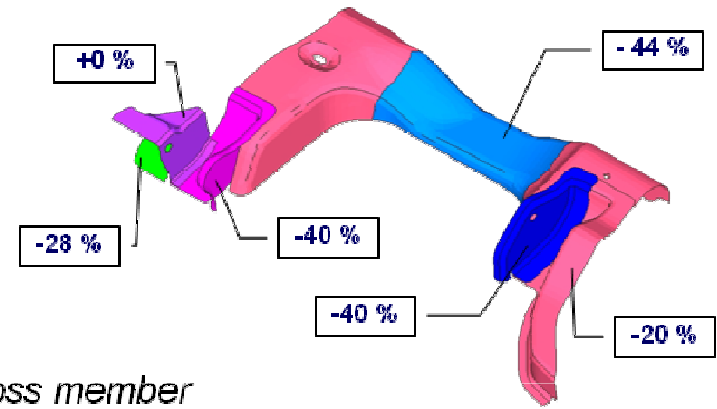



Lightweight engine subframe

Target: to develop a front engine subframe with the same performance (static and dynamic stiffness, crash behaviour) but lighter (30%) than the existing one; the lightening cost efficiency is required to be better than those typical of “full aluminium” solution

© Prof. Ing. Michele DASSISTI

Politecnico di Bari – DMIM – V.le Japigia 182 – 70126 BARI
Tel. 080 – 596.2747; fax 080-5962.788; mobile: 329 650 6022; m.dassisti@poliba.it

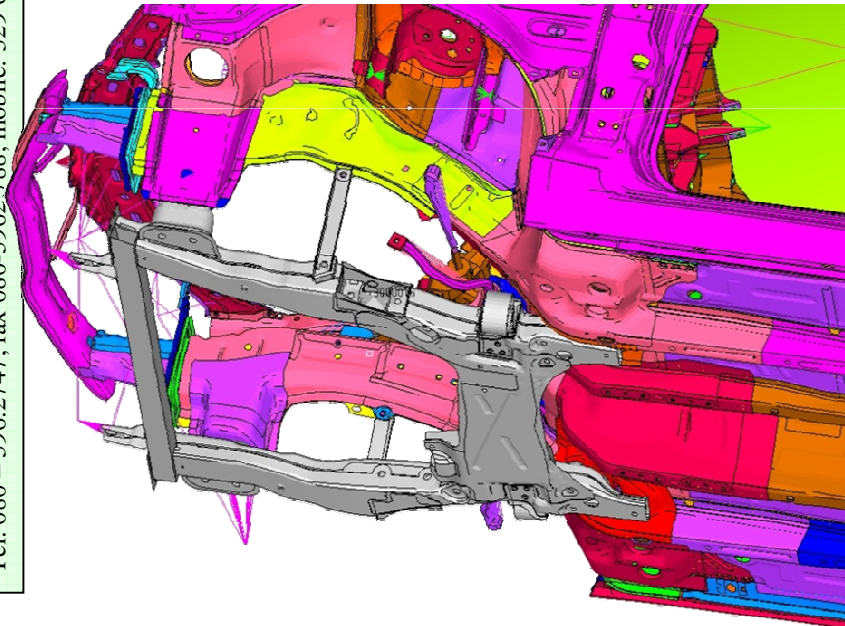



How it is possible to make the lightweight

© Prof. Ing. Michele DASSISTI

Politecnico di Bari – DMIM – V.le Japigia 182 – 70126 BARI
Tel. 080 – 596.2747; fax 080-5962.788; mobile: 329 650 6022; m.dassisti@poliba.it

■ Materials

- Ultra High Strength Steel
- Lightweight metal: **Aluminium**, Magnesium
- **Plastics**, Composites, Nanoreinforced materials, Biomaterials

■ Joining technology

- Laser welding
- Riveting, clinching
- Adhesive bonding

■ Optimization

- Topology optimization
- Space frame structures

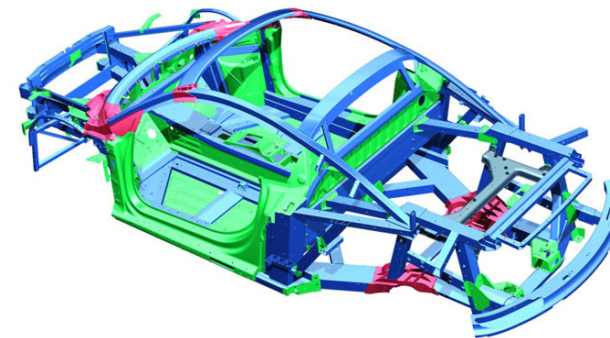
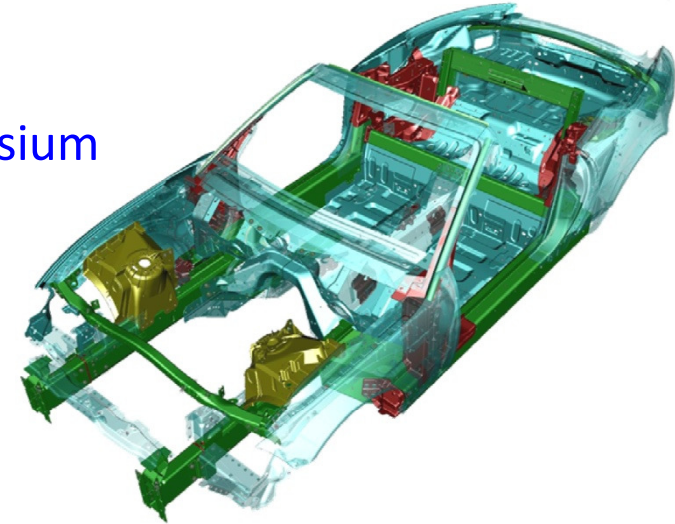



Eco-design for Solving Recycling Problems

© Prof. Ing. Michele DASSISTI

Politecnico di Bari – DMMM – V.le Japigia 182 – 70126 BARI
Tel. 080 – 596.2747; fax 080-5962.788; mobile: 329 650 6022; m.dassisti@poliba.it

Automotive steel/copper contamination on automotive shredder residues –ARS-affects the quality of recycled steel and do not to allow the reuse of this material on new automotive parts.

There are many ways of dealing with the problem:

1. diluting the recycled scrap with virgin metal;
2. treating Cu-bearing steel in the furnace to remove the Cu;
3. Increasing the tolerance of sheet steel for Cu by adding P;
4. Upgrading Cu-bearing steel severely into new mill shapes;
5. Using the scrap for other possible applications;
6. Hot roll in a reducing atmosphere to avoid the oxide formation;
7. Divert the steel scrap to iron casting, where the Cu content can be used as a graphitizer ...and so on.



Environmental Innovations on products and process

© Prof. Ing. Michele DASSISTI

Politecnico di Bari – DMMM – V.le Japigia 182 – 70126 BARI
Tel. 080 – 596.2747; fax 080-5962.788; mobile: 329 650 6022; m.dassisti@poliba.it

The expected technological developments are:

Nanomaterials & nanotechnologies promoting:

dematerialization, cleaner superficial treatment, and new treatments for industrial residues and effluents as well.

Near net shape techniques, in which the initial production of the item is very close to the final :

superplastic forming for plastics and composites;

sintering for metals and metals composites molded injection;

rapid prototyping to simulate by computer aided design (CAD) and to produce by computer aided manufacture (CAM) complex shapes in a melting-pot of materials.

Ecomaterials for structural uses (bodyshop) - more recyclable and free from toxic substances



Eco-design fostering cars recyclability: The case of Renault Modus

© Prof. Ing. Michele DASSISTI

Politecnico di Bari – DMMM – V.le Japigia 182 – 70126 BARI
Tel. 080 – 596.2747; fax 080-5962.788; mobile: 329 650 6022; m.dassisti@poliba.it

- **Modus** inaugurated a new segment of the compact mono-space., **95 % recyclable**, and was the first Renault model totally **eco-designed by the software OPERA** -Overseas Program for Economic Recycling Analyses-.
- Its interior has numerous storage compartments in the dashboard, the front floor and doors, where we can find the environmental thought of eco-designed parts.
- **Its dashboard incorporates around 50% of recycled PP corresponding to almost 5 kg.**
- The OPERA is expected to be speeded the recycled PP evolution in Renault vehicles helping them to reach their goal of 50 Kg per vehicle in 2016.

- ① Déflecteur central
Central deflector
- ② Convergençs façade avant
Front end deflectors
- ③ Ski sous moteur
Engine skidplate
- ④ Absorbeurs
Shock absorbers
- ⑤ Déflecteur de boîte à eau
Radiator tank deflector
- ⑥ Feutre de la boîte à air
Airbox felt
- ⑦ Ecrans de passage de roue
Wheel arch guard
- ⑧ Planche de bord
Dashboard

© Prof. Ing. Michele DASSISTI

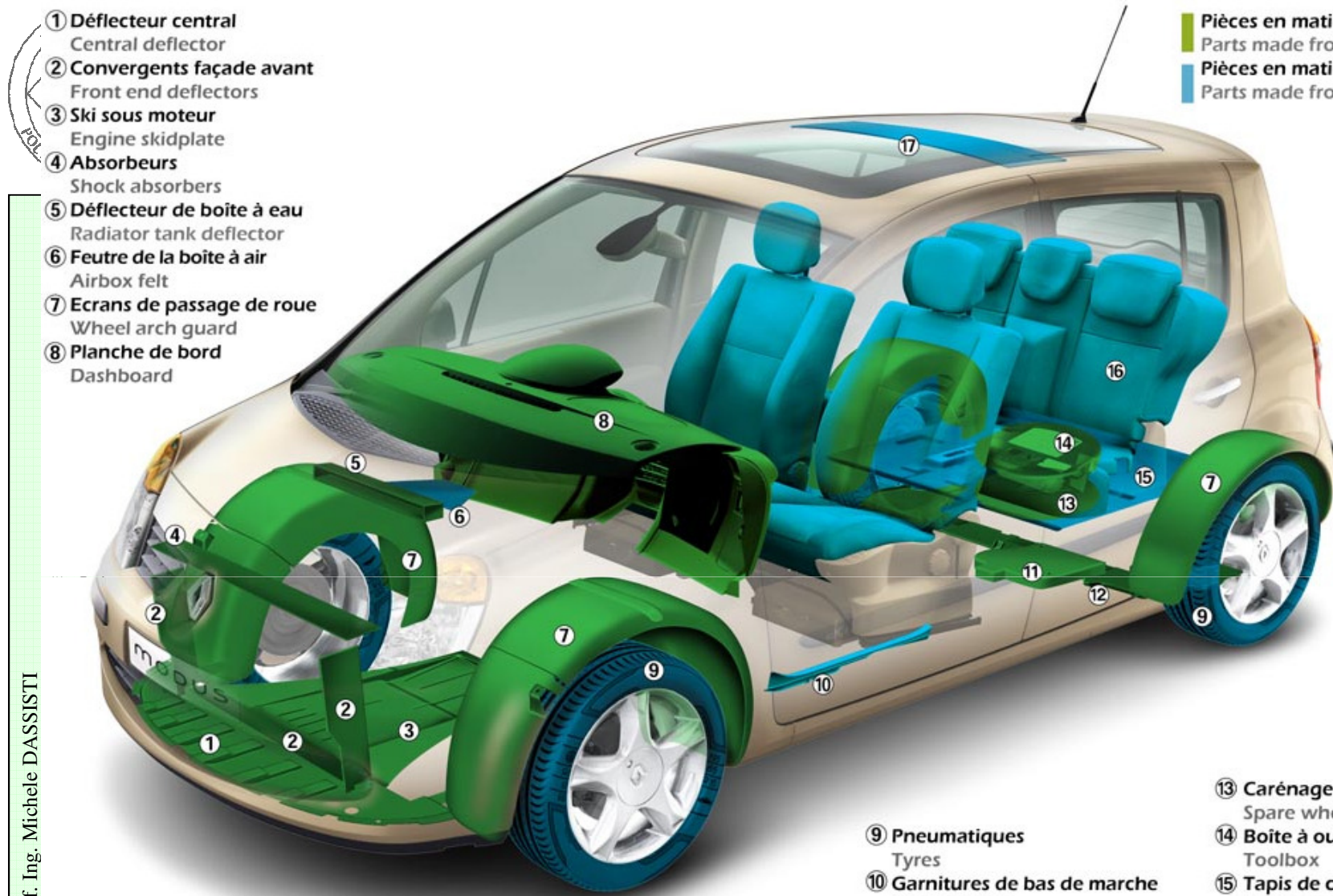

- Pièces en matière plastique recyclée
Parts made from recycled plastic
- Pièces en matière renouvelable
Parts made from recyclable material

- ⑨ Pneumatiques
Tyres
- ⑩ Garnitures de bas de marche
Door sill trim
- ⑪ Cache canister
Canister cover
- ⑫ Carénage train
Rear suspension fairing
- ⑬ Carénage sous roue de secours
Spare wheel undertray
- ⑭ Boîte à outils
Toolbox
- ⑮ Tapis de coffre
Boot carpet
- ⑯ Sellerie cuir (option)
Leather trim (option)
- ⑰ Raidisseur de pavillon
Roof stiffener



Closing Life Cycle Materials loop by Recycling

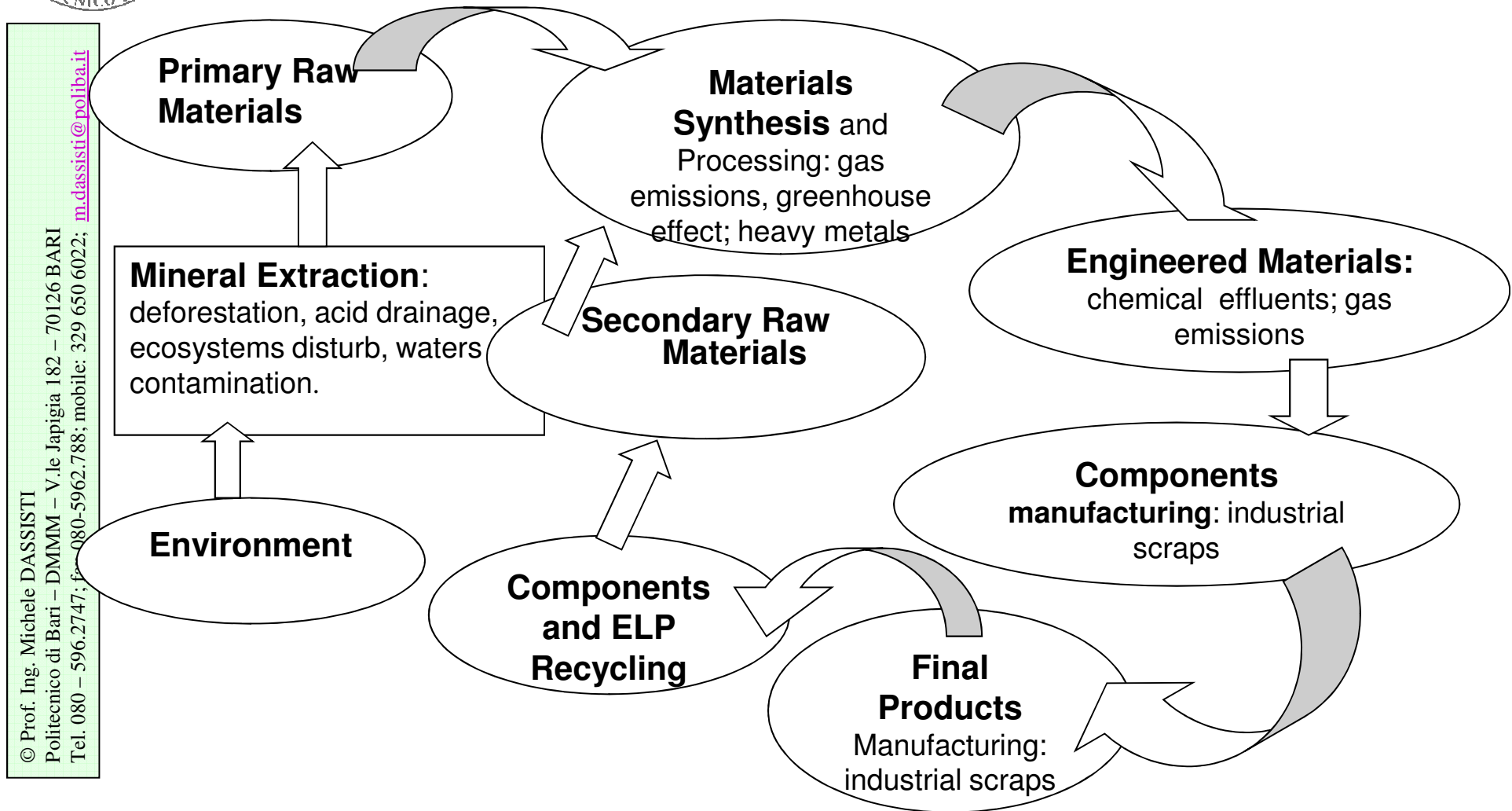

© Prof. Ing. Michele DASSISTI

Politecnico di Bari – DMMM – V.le Japigia 182 – 70126 BARI
Tel. 080 – 596.2747; fax 080-5962.788; mobile: 329 650 6022; m.dassisti@poliba.it



An example...

Metalworking Fluids (MWFs) have a history of harming the environment and the health of workers, resulting in pressures to re-design them in accordance with sustainable manufacturing principles.

© Prof. Ing. Michele DASSISTI
Politecnico di Bari – DMMM – V.le Japigia 182 – 70126 BARI
Tel. 080 – 596.2747; fax 080-5962.788; mobile: 329 650 6022; m.dassisti@poliba.it

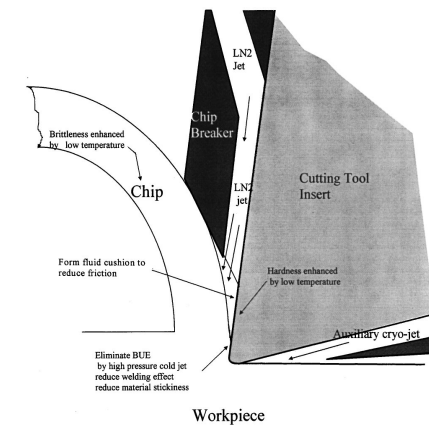



Another research example: unusual working conditions?

- Politecnico di Bari
- University of Kentucky

© Prof. Ing. Michele DASSISTI

Politecnico di Bari – DMMM – V.le Japigia 182 – 70126 BARI
Tel: 080-596.2747; fax 080-5962.788; mobile: 329.650.6022; m.dassisti@poliba.it

Cryogenic

With the ICEFLY™ machining system, you can cut up to 3 times more material at the same tool wear rate you currently experience. Or you can maintain your current material removal rate but increase tool life up to 5 times.

tool: CNMG-432 PVD-TiN
coated hard carbide insert
material: titanium 6AL-4V
depth of cut: 0.030 in.
feed rate: 0.008 in./rev

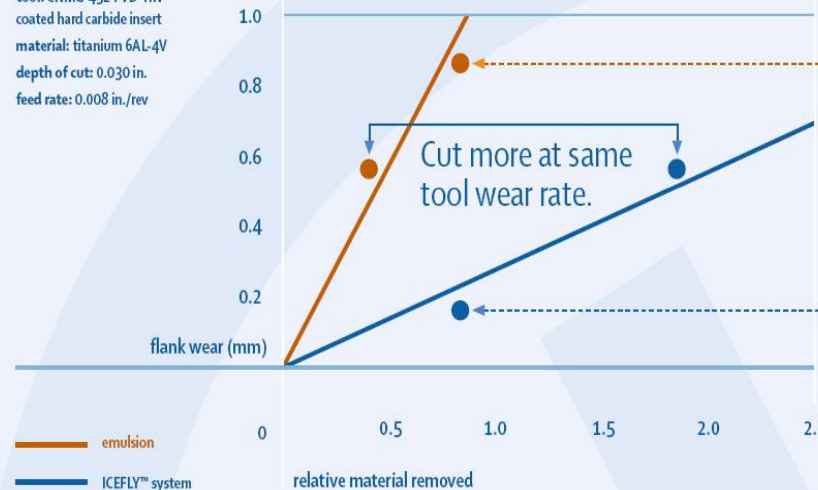

SEM micrographs of cutting tool insert (actual magnification 12x)



Increase tool life at same removal rate.



- *«To achieve this goal, scientists and engineers cooperate in international and multidisciplinary groups and organisations. They utilise imagination, judgement and take initiative to apply science, technologies and practical experience to shape competitive processes and products.» Seliger, 2008*



Cryo-cutting

- Freezing process (-)
- Setting (--)

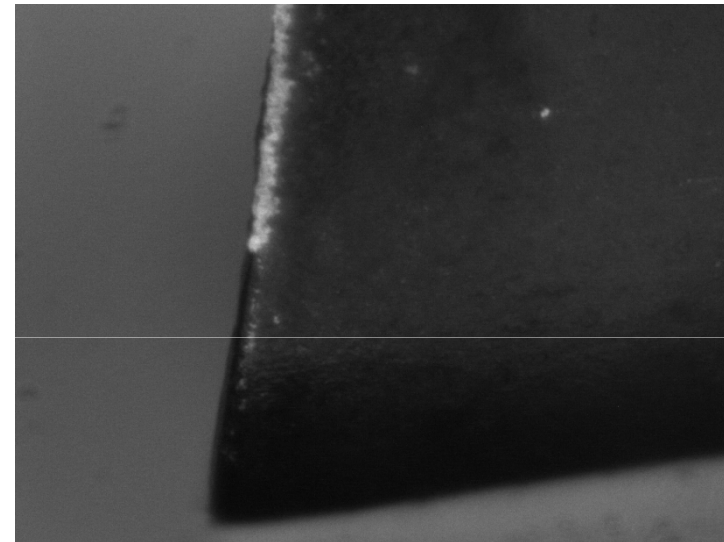

- Manufacturing process (+)
- Material processing (++)

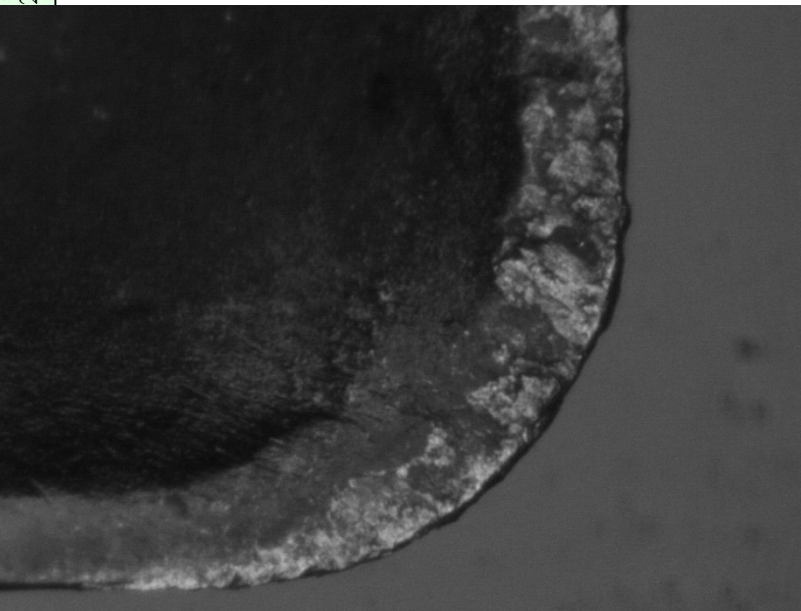



Virtualisation

© Prof. Ing. Michele DASSISTI

Politecnico di Bari – DMMM – V.le Japigia 182 – 70126 BARI

Tel. 080 – 596.2747; fax 080-5962.788; mobile: 329 650 6022; m.dassisti@poliba.it

7



New opportunities for synergies?"

ICT

vs

Sustainability

© Prof. Ing. Michele DASSISTI

Politecnico di Bari – DMMM – V.le Japigia 182 – 70126 BARI

Tel. 080 – 596.2747; fax 080-5962.788; mobile: 329 650 6022; m.dassisti@poliba.it





ONTOLOGY: *setting our common model*

© Prof. Ing. Michele DASSISTI

Politecnico di Bari – DMMM – V.le Japigia 182 – 70126 BARI

Tel. 080 – 596.2747; fax 080-5962.788; mobile: 329 650 6022; m.dassisti@poliba.it





Knowledge main issues

Objective:

to realize a common reference for the meaning of terms (semantics) adopted by different systems in order to allow them to interoperate



Ontology

(e.g., for business and enterprises: *Enterprise Ontology*)



SUSTAINABILITY AS A PART OF THE GOAL...

© Prof. Ing. Michele DASSISTI
Politecnico di Bari – DMMM – V.le Japigia 182 – 70126 BARI
Tel. 080 – 596.2747; fax 080-5962.788; mobile: 329 650 6022; m.dassisti@poliba.it

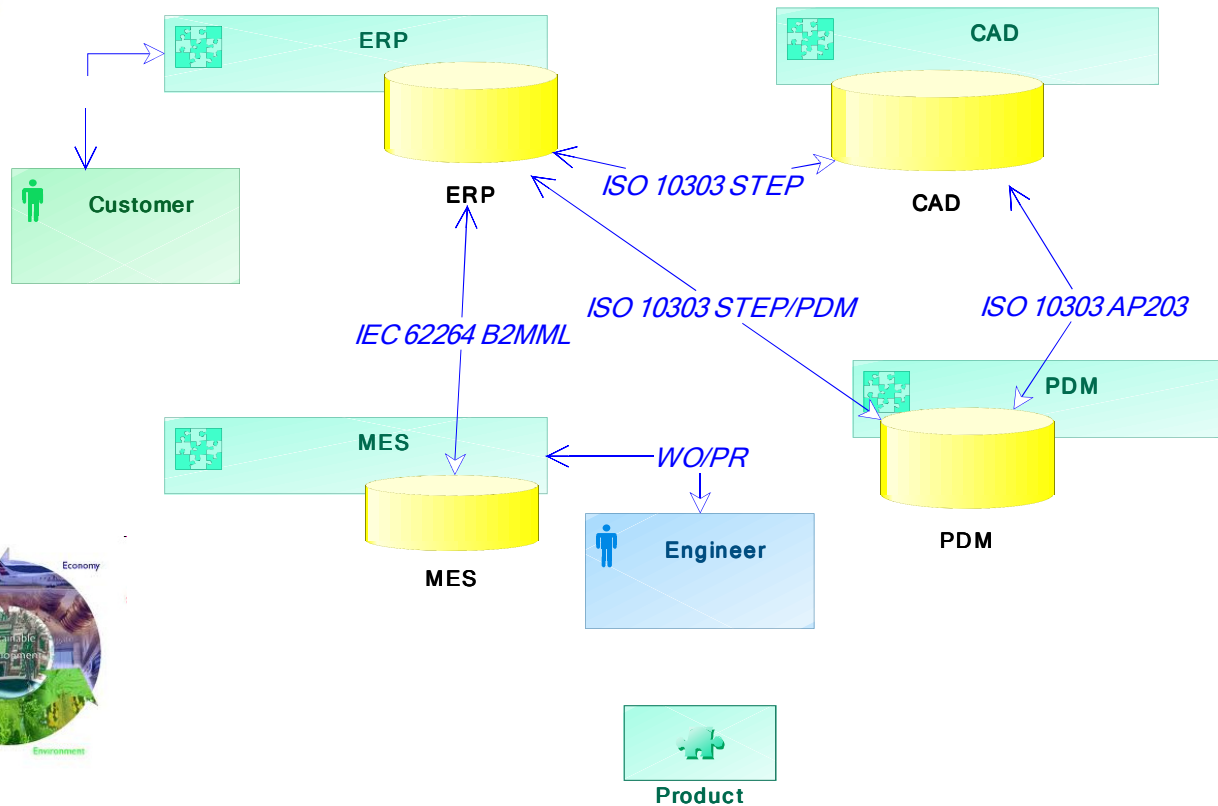



Sustainability & ontology

- To share *common understanding* of the structure of information among people or software agents
- To enable *reuse* of domain knowledge
- To make *domain assumptions* explicit
- To *analyze* domain knowledge
- To *separate* domain knowledge from the operational knowledge

[Noy&McGuinness 2001]



DISAMBIGUATION: a common widget

- What is a spinde, without a context?

© Prof. Ing. Michele DASSISTI

Politecnico di Bari – DMMM – V.le Japigia 182 – 70126 BARI
Tel. 080 – 596.2747; fax 080-5962.788; mobile: 329 650 6022; m.dassisti@poliba.it



From Computer Desktop Encyclopedia
© 2005 The Computer Language Co., Inc.

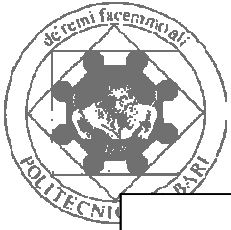

© Prof. Ing. Michele DASSISTI
 Politecnico di Bari – DMMM – V.le Japigia 182 – 70126 BARI
 Tel. 080 – 596.2747; fax 080-5962.788; mobile: 329 650 6022; m.dassisti@poliba.it

“Babel tower” effect

Sketch it in the USA
 Design in India

Feed materials from Australia
 Produce components in China
 soft components in Singapore
 Assemble in Europe

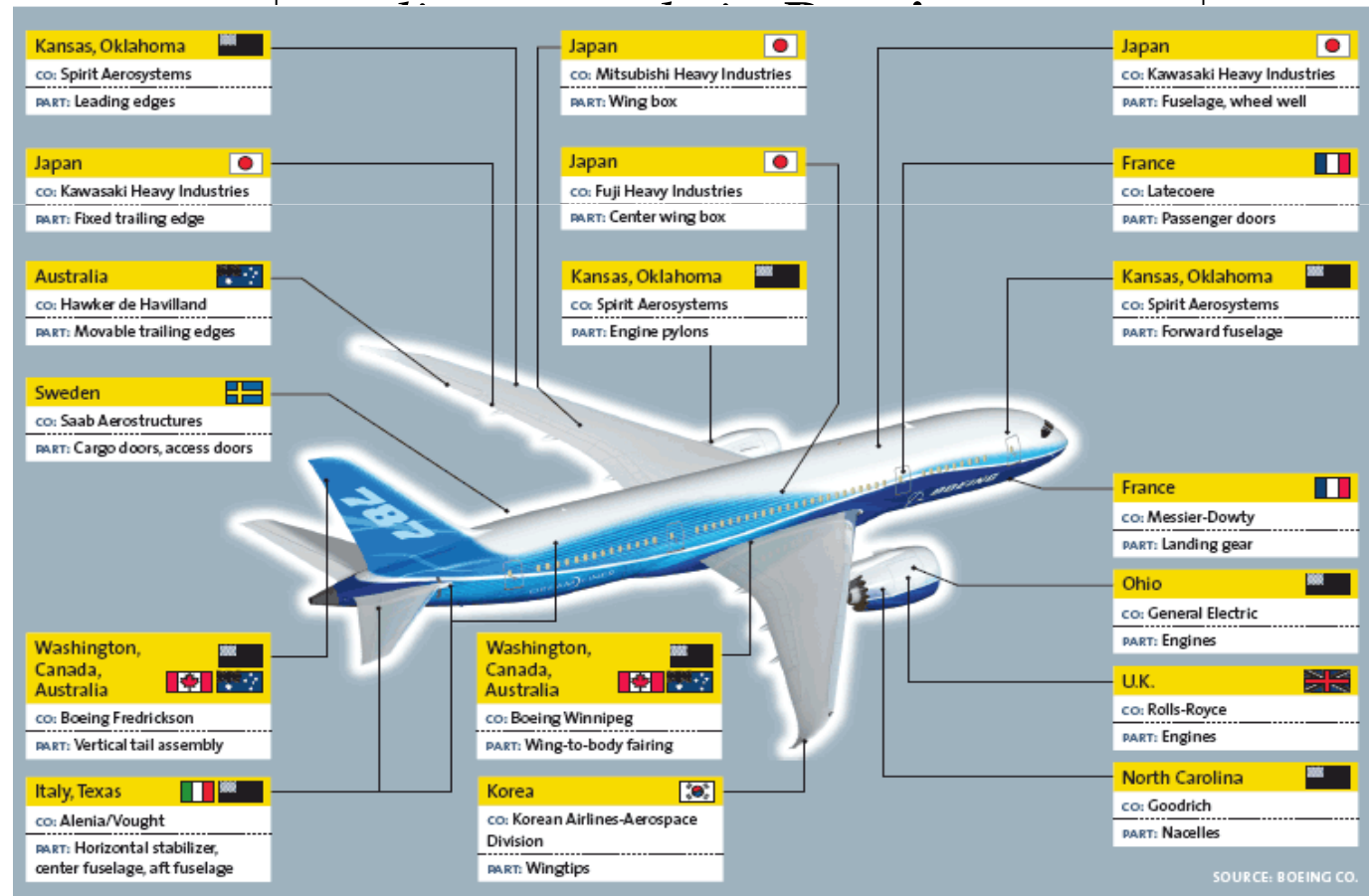



Interoperability:



- from Oxford Dictionary: “...*able to operate in conjunction*”
- from the IEEE Std 610.12 “...*is the ability of two or more systems or components to exchange and use information*” [IEEE 1990]
- From software point of view “... *is the ability of different types of computers, networks, operating systems, and applications to work together effectively, without prior communication, in order to exchange information in a useful and meaningful manner*”. [Panetto 2007]

Interoperability ≠ Cloning

Interoperability ≠ Compatibility



Profitability of interoperability!

© Prof. Ing. Michele DASSISTI

Politecnico di Bari – DMMM – V.le Japigia 182 – 70126 BARI
Tel. 080 – 596.2747; fax 080-5962.788; mobile: 329 650 6022; m.dassisti@poliba.it

- It is expected Iop Increases profitabilit
-<<we estimate that imperfect interoperability costs the US automobile industry approx. \$1billion per year and delays in itrnoduction of new models by at least two months>>

Brunneimer, 2002

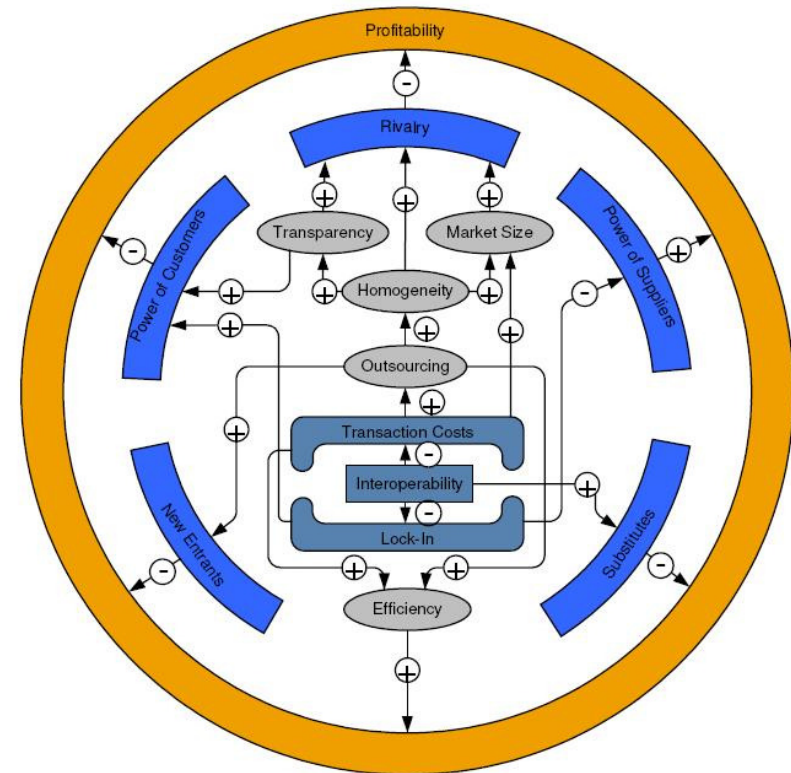

Source: Athena, 2006



Interoperability → Sustainability?

© Prof. Ing. Michele DASSISTI
Politecnico di Bari – DMIM – V.le Japigia 182 – 70126 BARI
Tel. 080 – 596.2747; fax 080-5962.788; mobile: 329 650 6022; m.dassisti@poliba.it

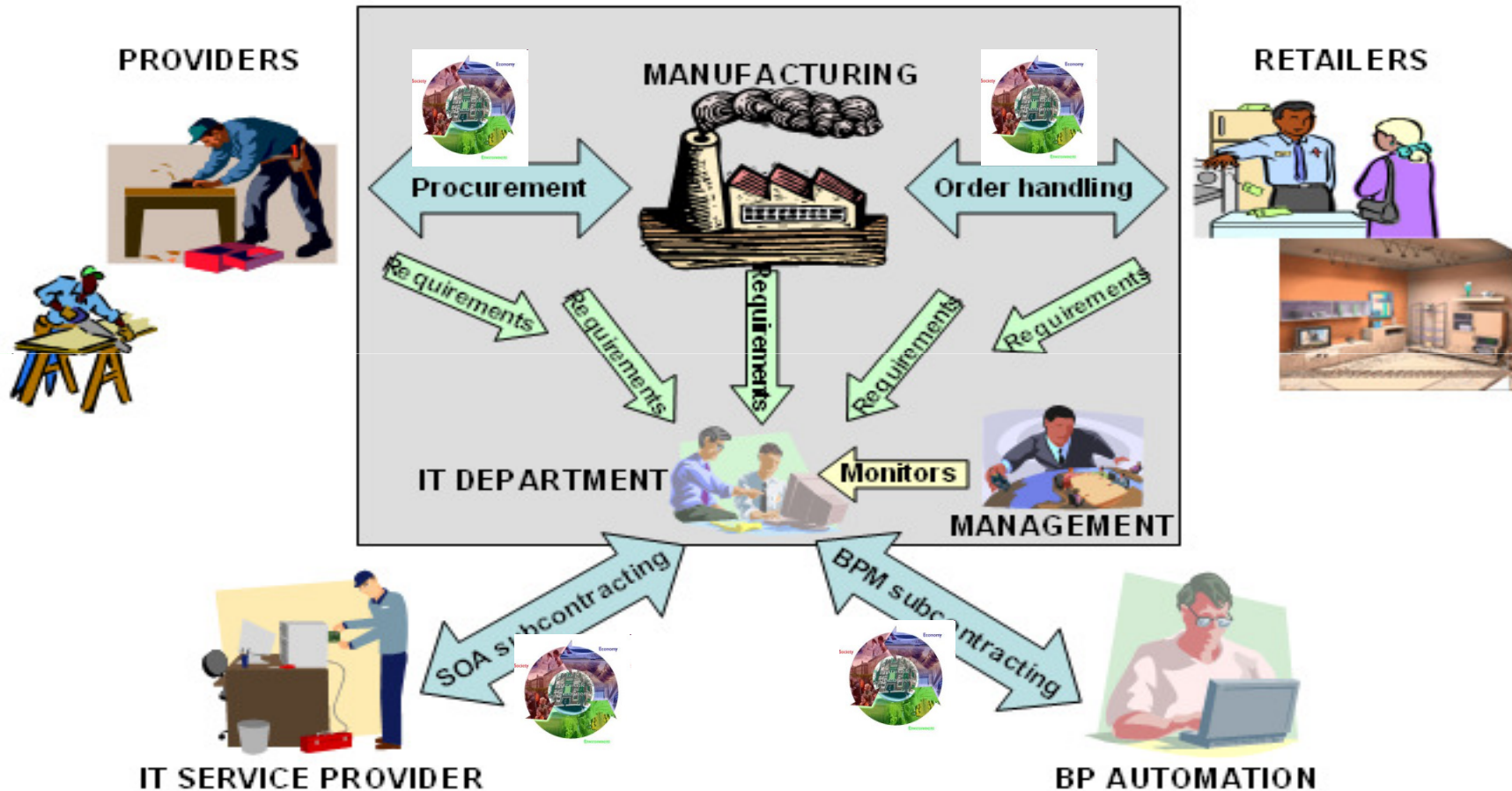



Interoperability & Sustainability: knowledge sharing

© Prof. Ing. Michele DASSISTI
Politecnico di Bari – DMIM – V.le Japigia 182 – 70126 BARI
Tel. 080 – 596.2747; fax 080-5962.788; mobile: 329 650 6022; m.dassisti@poliba.it

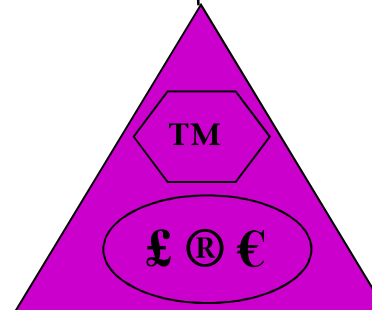
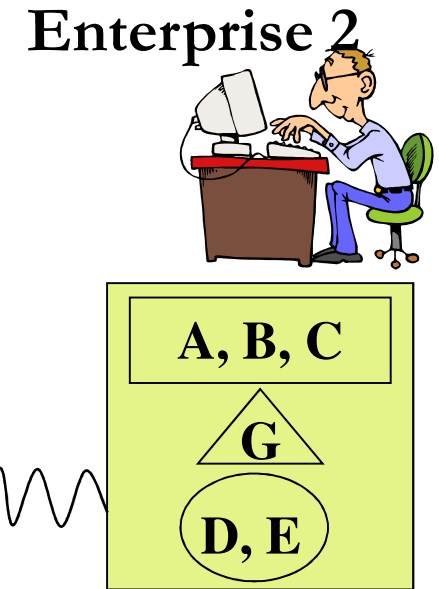
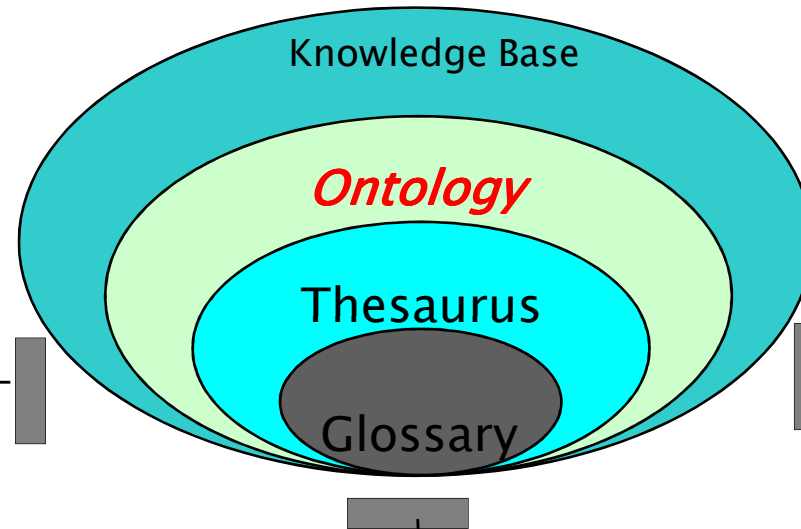
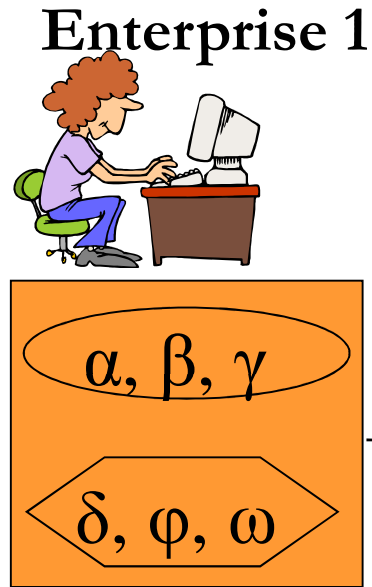

Enterprise 3



Interoperability: recomposing the fragmentation!

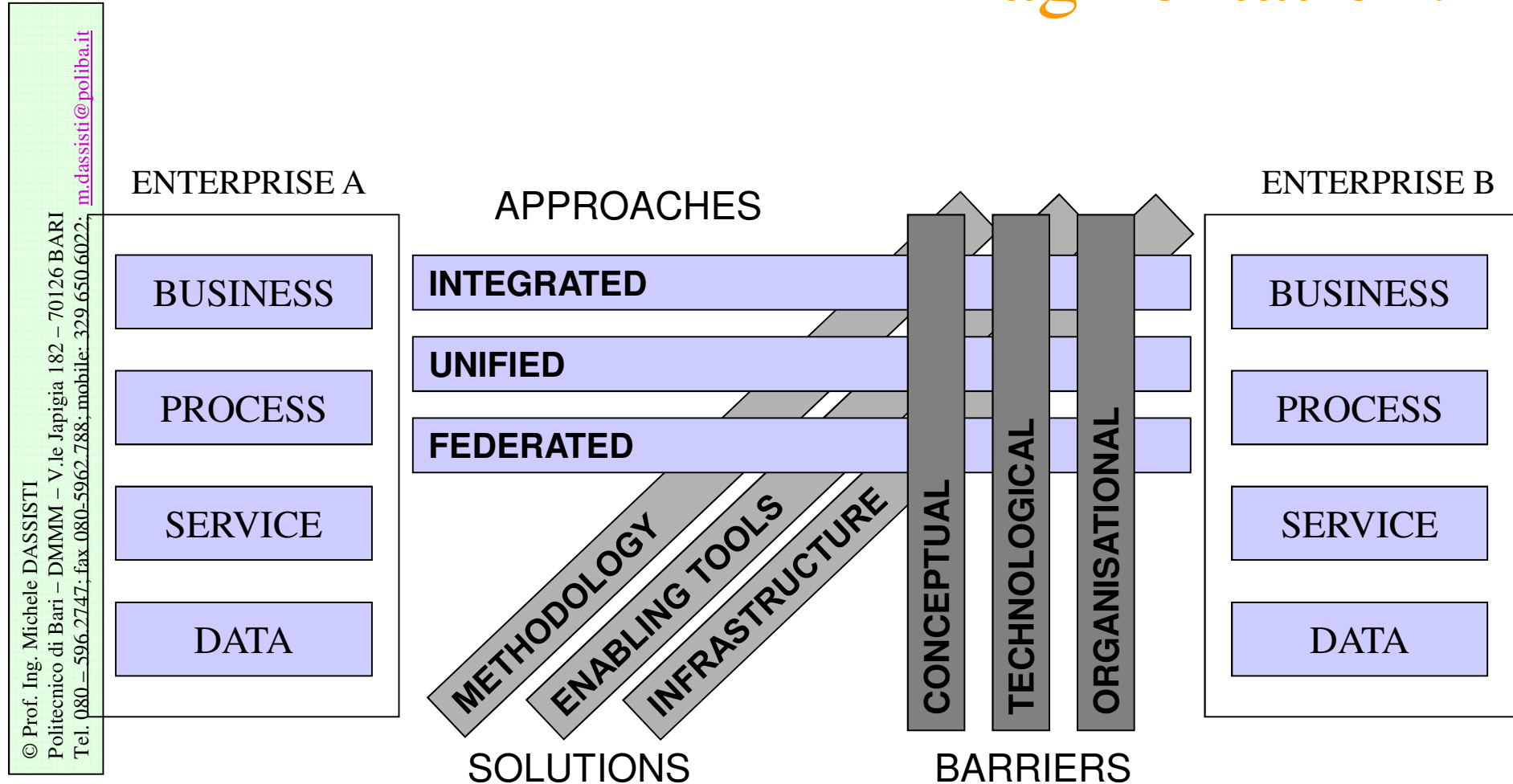

© Prof. Ing. Michele DASSISTI
Politecnico di Bari – DMIMM – V.le Japigia 182 – 70126 BARI
Tel. 080 – 596.2747; fax 080-5962.788; mobile: 329.650.6022.
m.dassisti@poliba.it

Source: **Enterprise Interoperability Framework (EIF)** Interop Network



SHARE THE SAME GOAL

2nd level cooperation goal - CG2

EXTERNAL CONSTRAINTS (EXCO)

EXTERNAL CONSTRAINTS (EXCO)

[Io1(t)] Entity 1
Goal E1 (1st level)

Δt

[Io2(t)] Entity 2
Goal E1 (1st level)

$$CG2 = f$$

$$[Io1(\Delta t), Io2(\Delta t), EXCO, G_{E1}(\Delta t), G_{E2}(\Delta t)]$$

Ing. Michele DASSISTI
Politecnico di Bari - DMMM - V.le Japigia 182 - 70126 BARI
Tel. 080-596.2747; fax 080-5962.788; mobile 080-596.2747; e-mail: m.dassisti@poliba.it



Intercultural merging

Enterprise 1

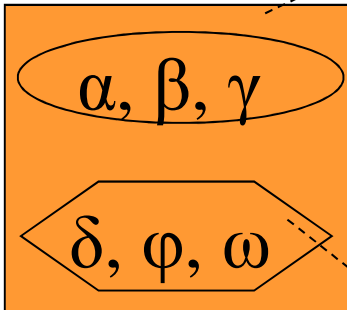

Enterprise 2

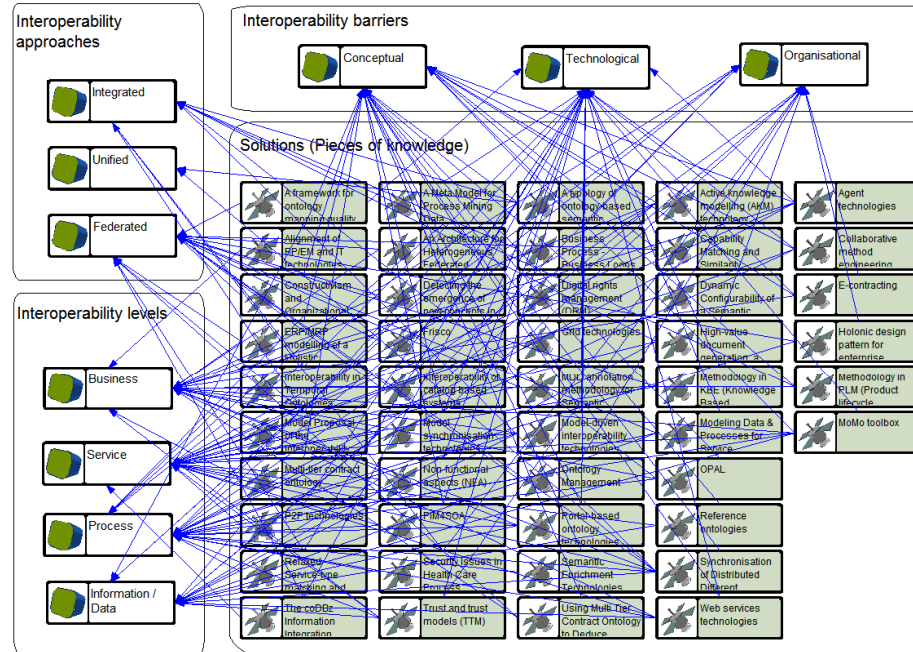
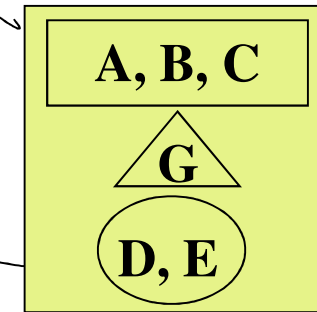

© Prof. Ing. Michele DASSISTI
 Politecnico di Bari – DMMM – V.le Japigia 182 – 70126 BARI
 Tel. 080 – 596.2747; fax 080-5962.788; mobile: 329 650 6022; m.dassisti@poliba.it

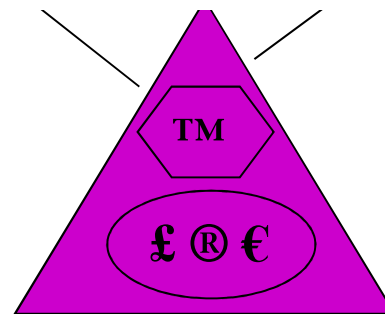

Enterprise 3



© Prof. Ing. Michele DASSISTI
Politecnico di Bari – DMM –

• << epistemology has to be included explicitly in the description of natural phenomena...>> F. Capra





Continuous Improvement

© Prof. Ing. Michele DASSISTI

Politecnico di Bari – DMMM – V.le Japigia 182 – 70126 BARI

Tel. 080 – 596.2747; fax 080-5962.788; mobile: 329 650 6022; m.dassisti@poliba.it

8



Always optimising

© Prof. Ing. Michele DASSISTI
Politecnico di Bari – DMMM – V.le Japigia 182 – 70126 BARI
Tel. 080 – 596.2747; fax 080-5962.788; mobile: 329 650 6022; m.dassisti@poliba.it

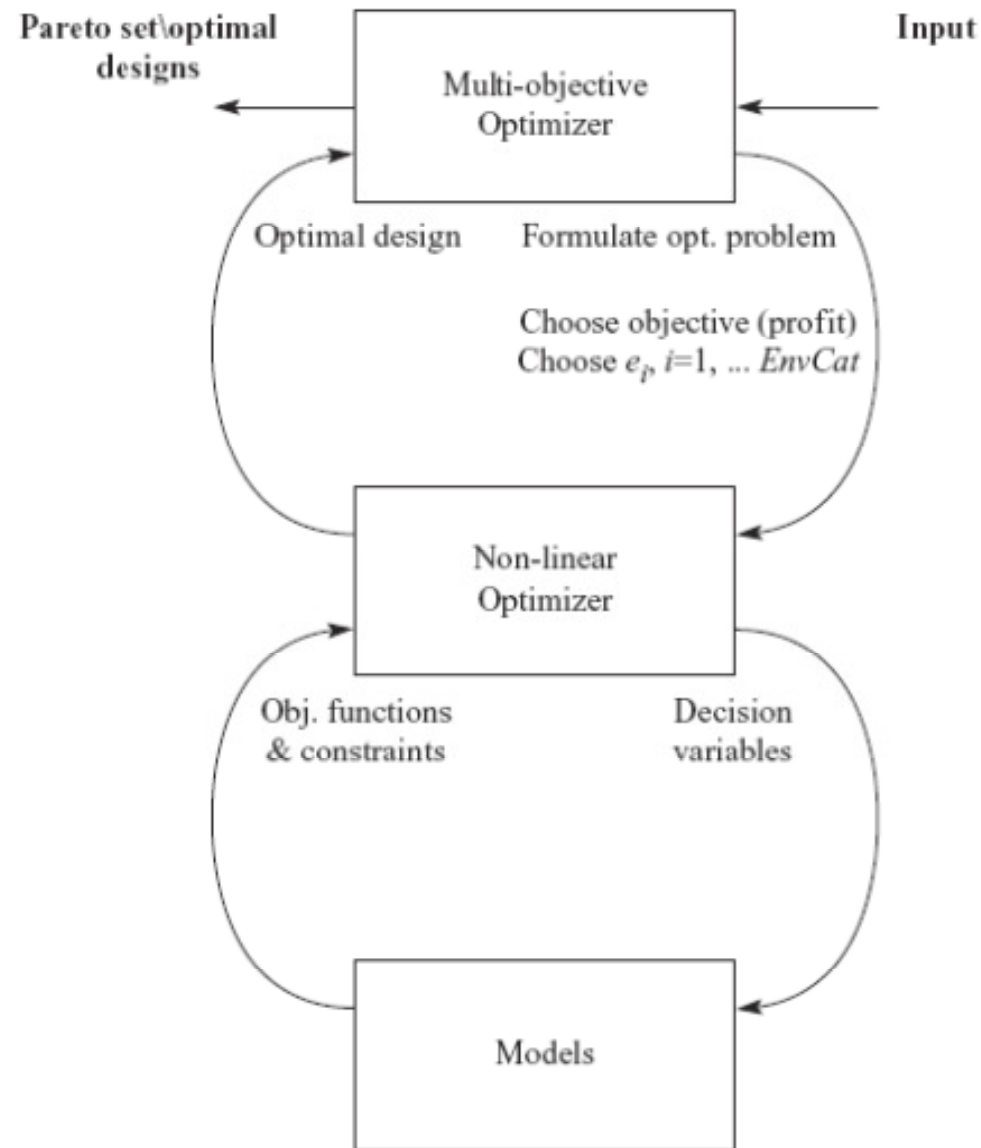

Figure 11.4 A generalized multi-objective optimization framework



Process analysis approach

© Prof. Ing. Michele DASSISTI
 Politecnico di Bari – DMMM – V.le Japigia 182 – 70126 BARI
 Tel. 080 – 596.2747; fax 080-5962.788; mobile: 329 650 6022; m.dassisti@poliba.it

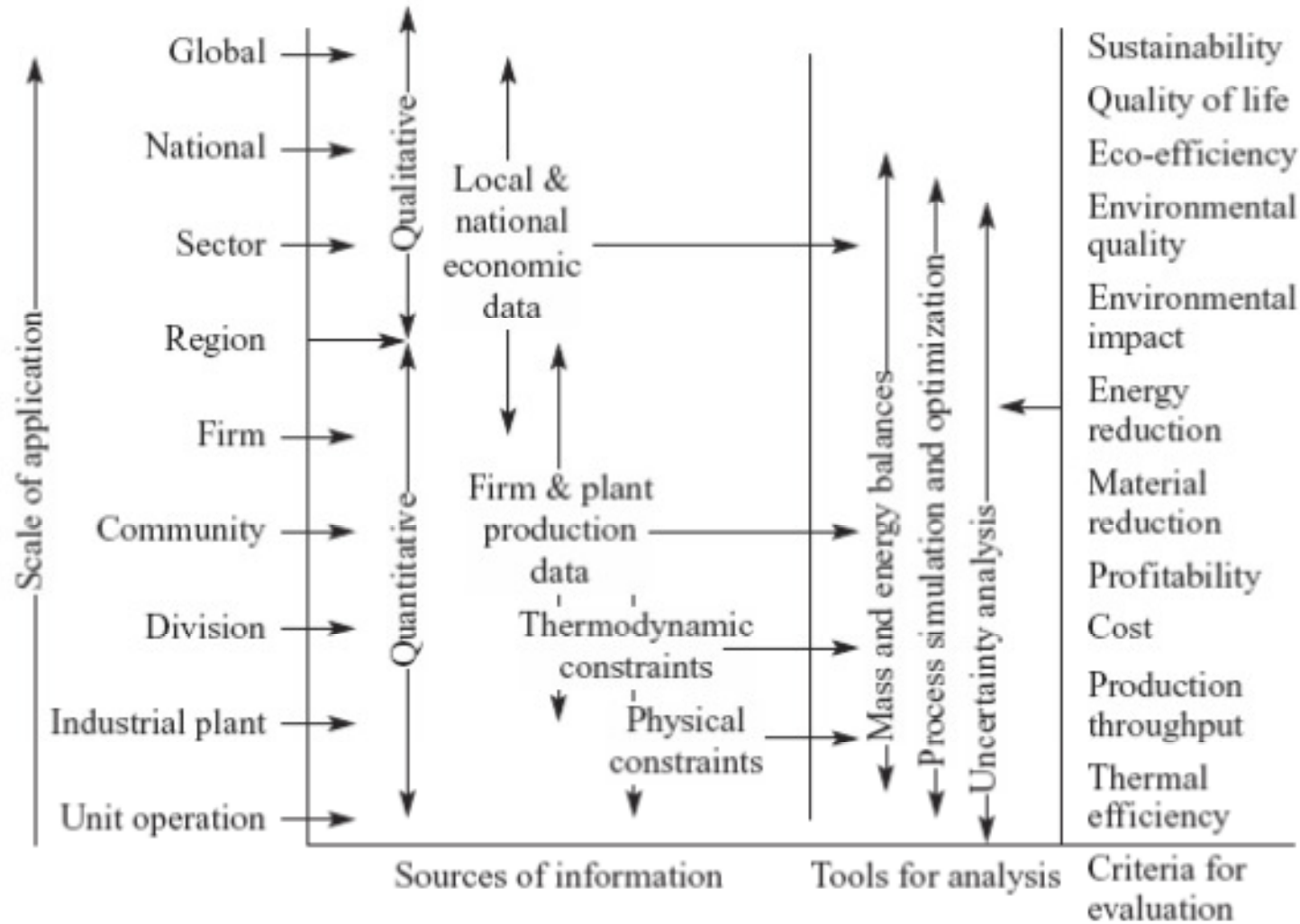

Figure 11.1 A conceptual framework for a process analysis approach to industrial ecology



Process simulation approach

© Prof. Ing. Michele DASSISTI

Politecnico di Bari – DMMM – V.le Japigia 182 – 70126 BARI

Tel. 080 – 596.2747; fax 080-5962.788; mobile: 329 650 6022; m.dassisti@poliba.it

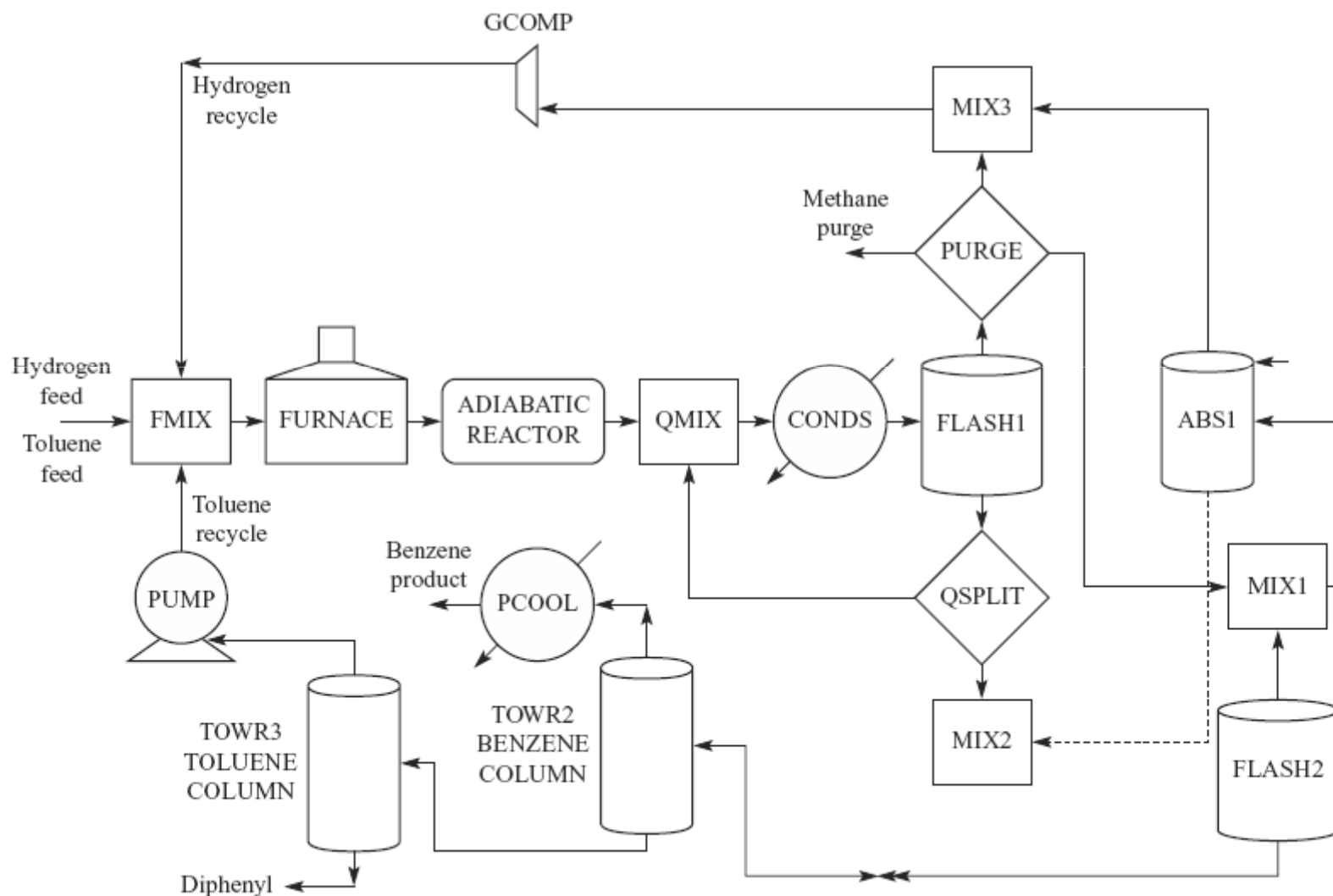

Figure 11.2 The process flowsheet for the production of benzene through the hydrodealkylation of toluene



Process simulation approach

© Prof. Ing. Michele DASSISTI

Politecnico di Bari – DMMM – V.le Japigia 182 – 70126 BARI

Tel. 080 – 596.2747; fax 080-5962.788; mobile: 329 650 6022; m.dassisti@poliba.it

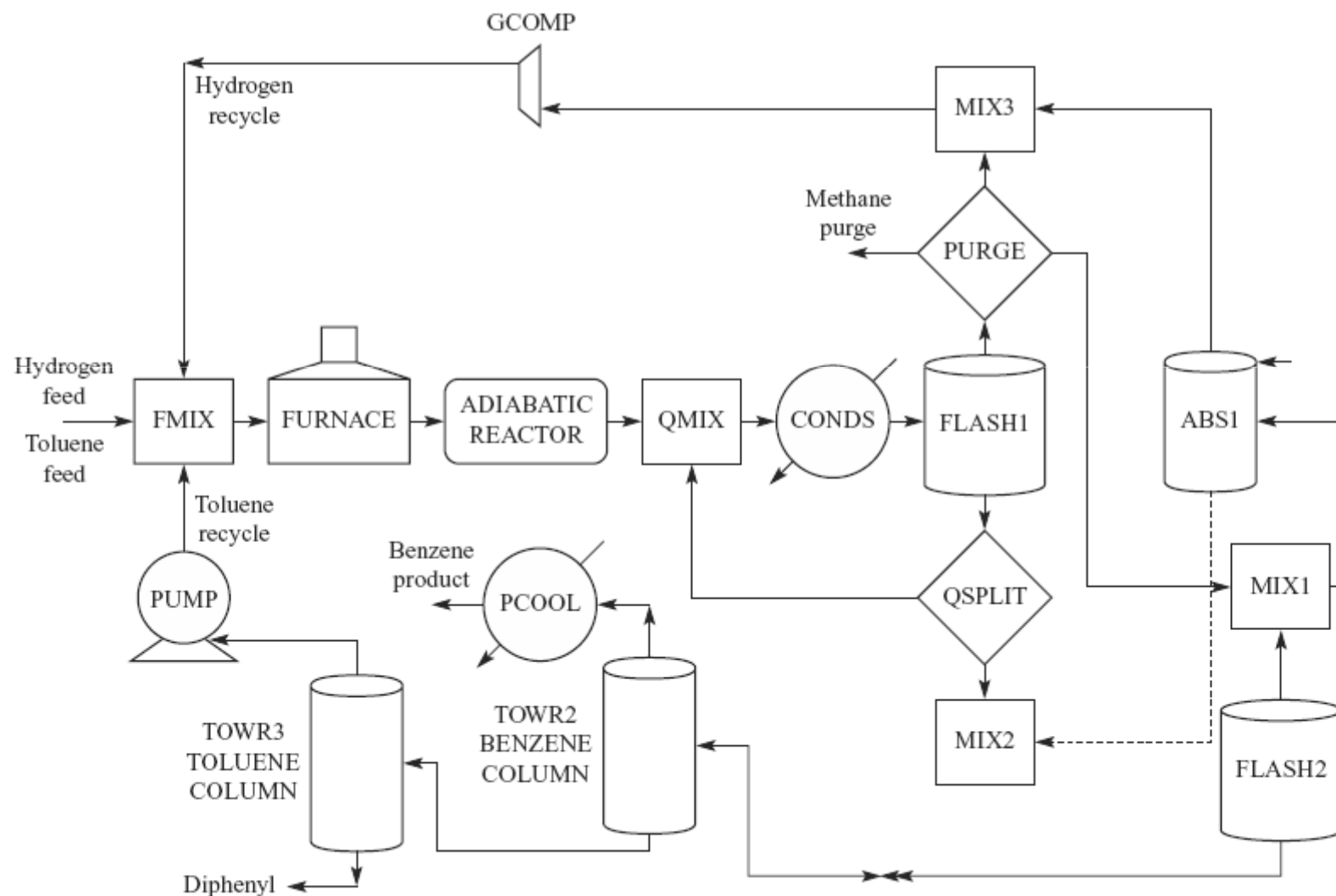

Figure 11.2 The process flowsheet for the production of benzene through the hydrodealkylation of toluene



Process simulation approach

© Prof. Ing. Michele DASSISTI

Politecnico di Bari – DMMM – V.le Japigia 182 – 70126 BARI

Tel. 080 – 596.2747; fax 080-5962.788; mobile: 329 650 6022; m.dassisti@poliba.it

Conventional components		Mass and Energy Balance		
		In	Out	Relative diff.
H ₂	LBMOL/HR	2047.48	2047.41	3.66387e-05
CH ₄	LBMOL/HR	2414.51	2414.54	-1.39574e-05
C ₆ H ₆	LBMOL/HR	374.131	374.139	-2.16750e-05
C ₇ H ₈	LBMOL/HR	227.842	227.837	2.21647e-05
C ₁₂ H ₁₀	LBMOL/HR	16.8401	16.8394	4.22304e-05
Total balance				
MOLE	LBMOL/HR	5080.8	5080.76	7.66967e-06
MASS	LB/HR	95679.1	95679.5	-4.68125e-06
ENTHALPY	BTU/HR	-6.60813e+07	-6.60813e+07	1.48284e-05
Stream results				
Stream ID		S01	S02	S03
From:		CONDS	FLASH	FLASH
To:		FLASH	PURGE	QSPLIT
H ₂	LBMOLE/HR	2047.4828	2046.7644	0.6433
CH ₄	LBMOLE/HR	2414.5081	2390.8028	23.7389
C ₆ H ₆	LBMOLE/HR	374.1306	17.8004	356.3382
C ₇ H ₈	LBMOLE/HR	227.8422	3.5885	224.2486
C ₁₂ H ₁₀	LBMOLE/HR	16.84	0.096816	16.8336
TOTAL	LBMOLE/HR	5080.8038	4458.9569	621.8079
TEMP	DEGREES F	100	100	100
PRES	PSIA	465	465	465
ENTHALPY	BTU/LBMOLE	-13006	-16927	15105
V	FRACTION	0.8776	1.0	0.0
L	FRACTION	0.1223	0.0	1.0
ENTROPY	BTU/LBMOLE-R	-21.6285	-15.6219	-64.704
DENSITY	LBMOLE/CUFT	0.0463	0.0774	0.6473
AVG MW		18.8314	9.9133	82.785



MODELLING THE REALITY

© Prof. Ing. Michele DASSISTI
 Politecnico di Bari – DMMM – V.le Japigia 182 – 70126 BARI
 Tel. 080 – 596.2747; fax 080-5962.788; mobile: 329 650 6022; m.dassisti@poliba.it

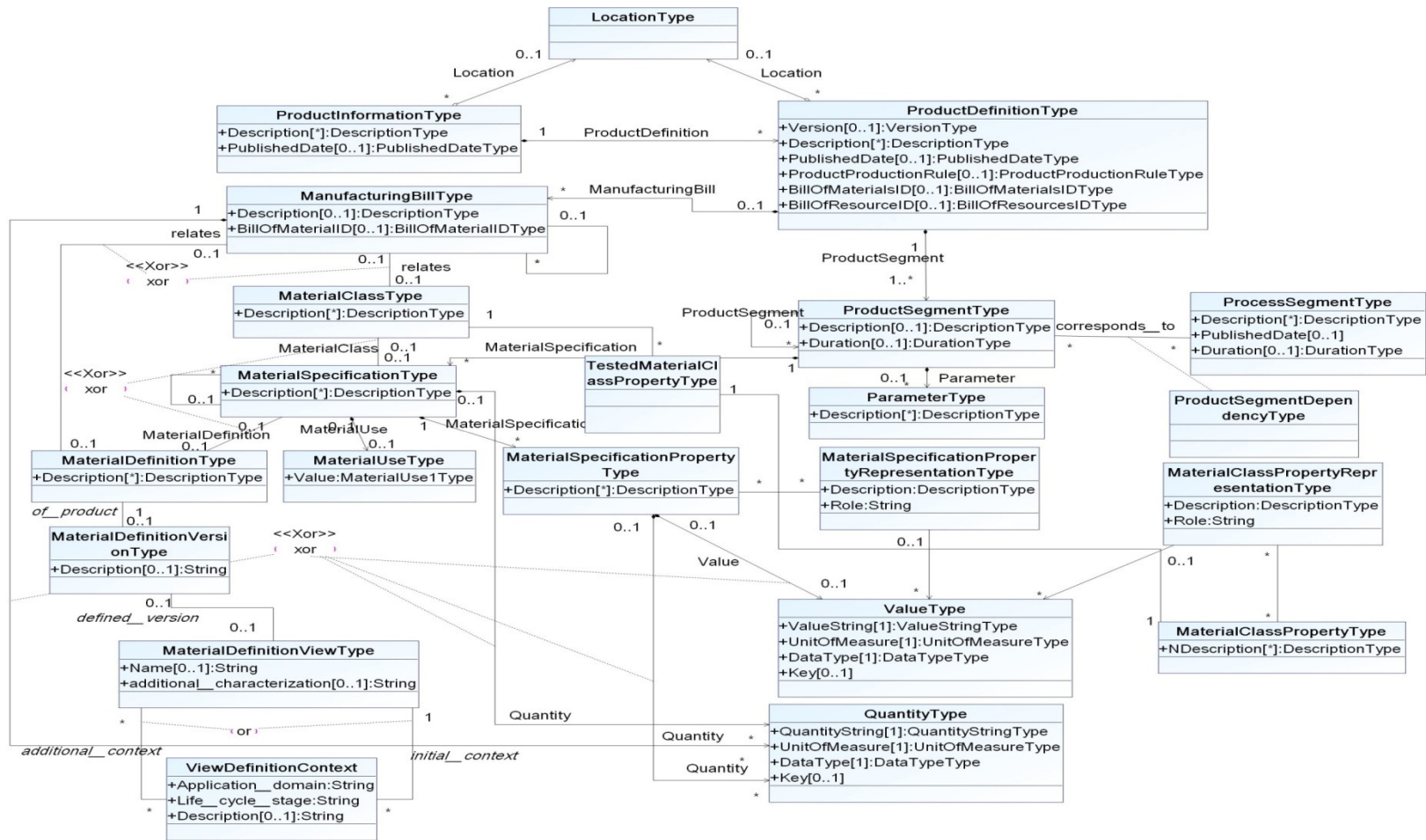

*“There is no a better model of a cat than the cat,
 better if it is the same cat “*





Product as information system

*Product-centric
Interoperability in
manufacturing systems*

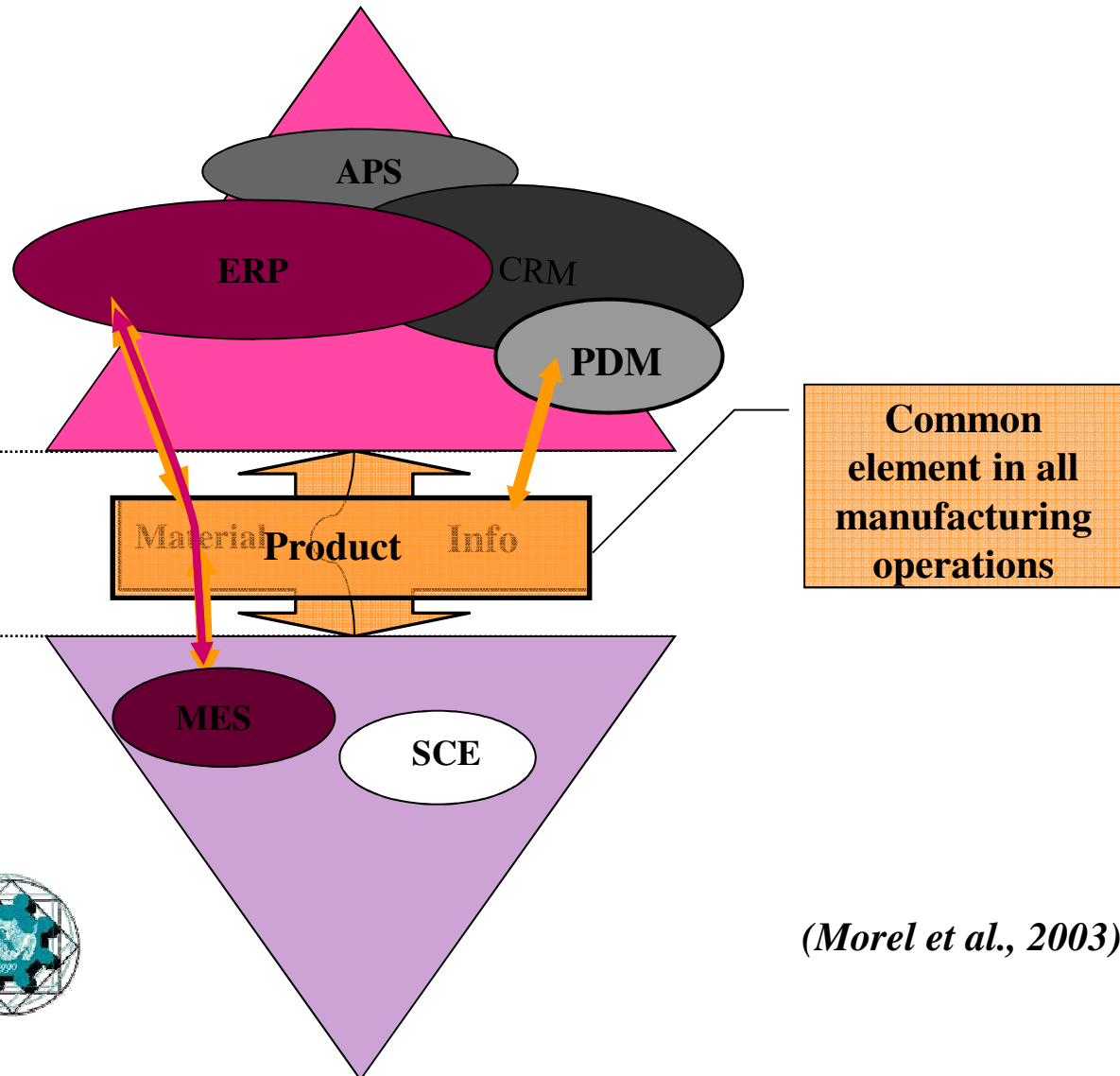

© Prof. Ing. Michele DASSISTI

Politecnico di Bari – DMMM – V.le Japigia 182 – 70126 BARI

Tel. 080 – 596.2747; fax 080-5962.788; mobile: 329 650 6022; m.dassisti@poliba.it

Nancy-Université

Université
Henri Poincaré



(Morel et al., 2003)



1. PRODUCT-DRIVEN INTEROPERABILITY FOR MANUFACTURING SYSTEMS

© Prof. Ing. Michele DASSISTI
 Politecnico di Bari – DMM – V.le Japigia 182 – 70126 BARI
 Tel. 080 – 596.2747; fax 080-5962.788; mobile: 329 650 6022; m.dassisti@poliba.it

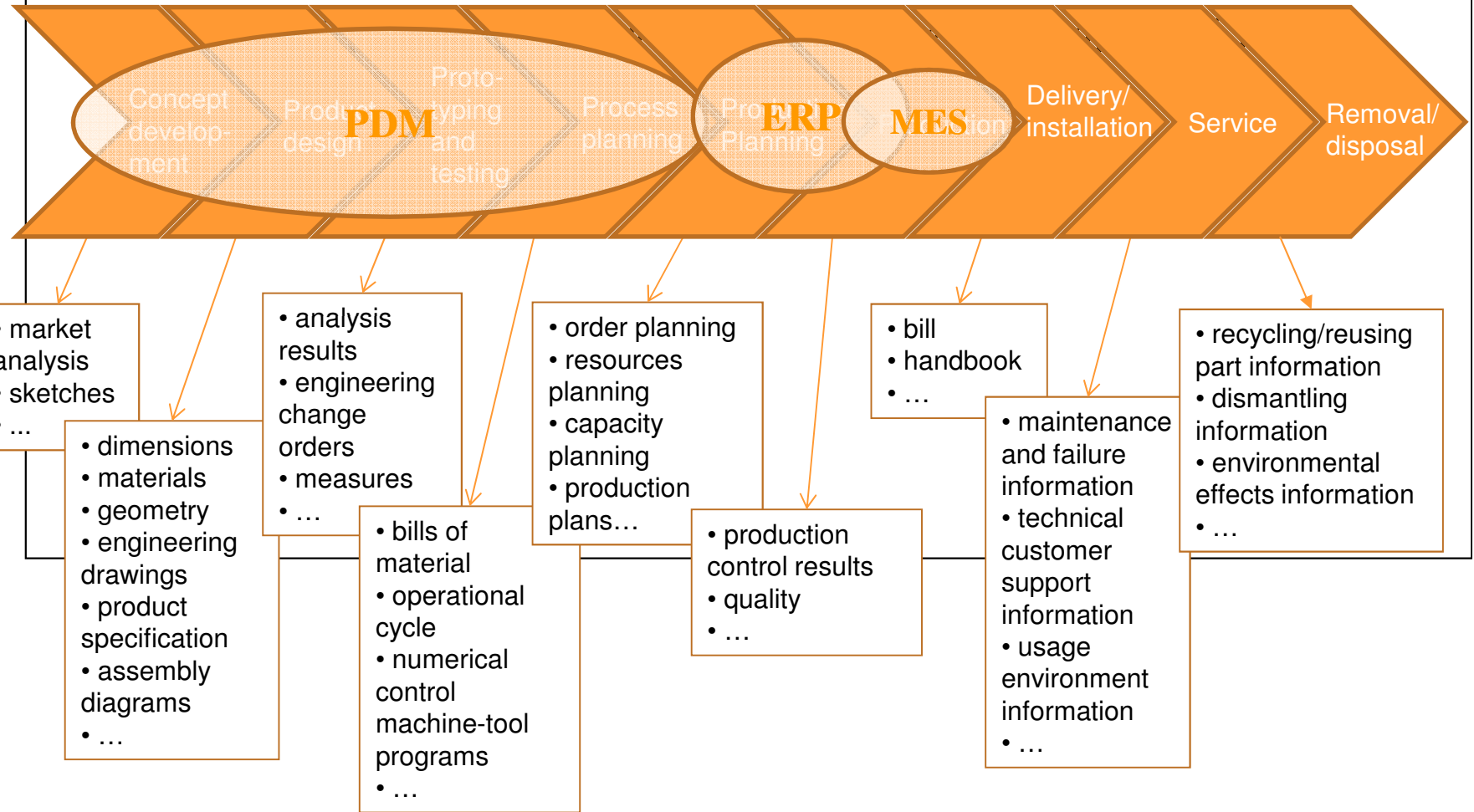

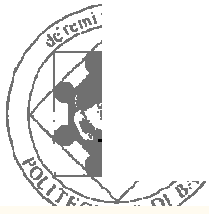

Sustainable signature (footprint?)

3D S

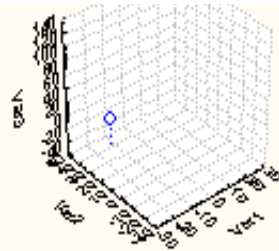

Var3: ≤ -20

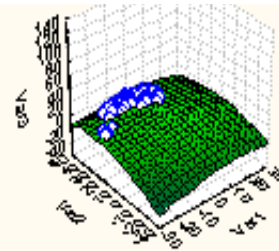

Var3: $(-20;0]$

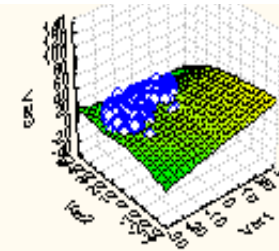

Var3: $(0;20]$

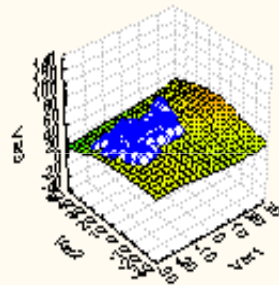

Var3: $(20;40]$

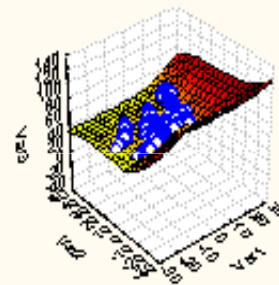

Var3: $(40;60]$

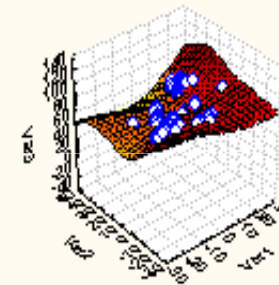

Var3: $(60;80]$

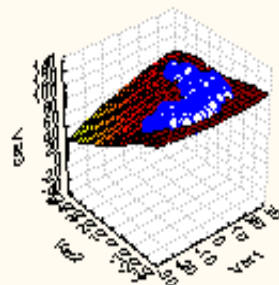

Var3: $(80;100]$

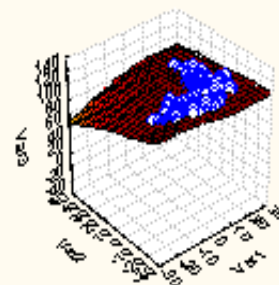

Var3: $(100;120]$

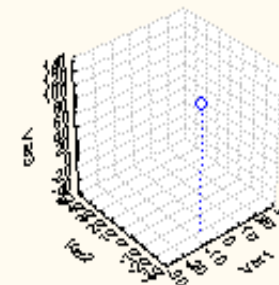

Var3: > 120

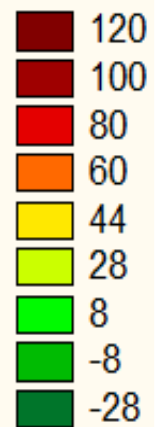

© Prof. Ing. Michela
Politecnico di Bari
Tel. 080 - 596.274



METRICS CAN BE IMPROVED

Tool Management System Model

Complete product traceability by technological cycle formal structure

Improvement Model

© Prof. Ing. Michele DASSISTI
 Politecnico di Bari – DMIMM – V.le Japigia 182 – 70126 BARI
 Tel. 080 – 596.2747; fax 080-5962.788; mobile: 329 650 6022; m.dassisti@poliba.it

DIMES POLITECNICO di BARI		FOGLIO ANALISI OPERAZIONE		Operazione: N°	OP29.2	Ciclo: N°
STUDI DI FABBRICAZIONE		Denominazione elemento: Dopo Pompe CP111 versione: P5A1 acce				
DESCRIZIONE OPERAZIONE						
N	Utensili / Attrezzi	Critico (anni)	vita (anni)	Miscelato	Completato	Data revisione 2007
10	Fresa Ø 32	F3 70070	15			
20	Fresa Ø 50	F5 70071	300			
30	Fresa Ø 100	F10 70076	1000			
40	Fresa rifinitura Ø 12	F12 70081	120			
50	Pila a più diametri Ø21, Ø21, Ø2	B3 70313	500			
60	Pila Ø6, N (quadro M8)	B3 70254	1000			
70	Pila Ø 4	B4 70270	3000			
80	Fresa Ø 9,35	B1 70271	3000			
90	Alcanta Ø 6,06/11	B1 70281	1000			
100	Trasa cilindrica Ø3,Ø6	B3 70095	1000			
110	Contrafiletto Ø3, Ø2	B3 70092	1000			
120	Pila Ø3	B4 70293	1500			
130	Pila Ø7,5/7,50	B4 70225	1000			
140	Pila a più diametri Ø 4, 20	B3 70300	1000			
150	Miscelato M5	GE 70048	1200			
160	Miscelato M6	GE 70047	1200			
170	Fresa Ø 17	B4 70028	1000			

DESCRIZIONE DELLE FASI	CONDIZIONI DI TAGLIO						TEMPI (min)		
	S	v	f	a	mm	°	100-RALE	100-RALE	100-RALE
10.0 Sigresatura superficie #7 100 (larghezza)	3000				2100				
10.1 Sigresatura superficie #8000	3000				2100				
10.2 Sigresatura superficie #8000	3000				2100	21			
10.3 Sigresatura superficie #8000	2000				2100				
10.4 Sigresatura superficie #8000	3000				2100				
10.5 Sigresatura superficie #5000	3000				2100				
20.1 Sigresatura superficie #7 000	3000				3000	88			
20.2 Sigresatura superficie #7 000	3000				2700	257,6			
20.3 Sigresatura superficie #2 100	2500				2500	27			
30.1 Finitura di finitura #2000	305				2500				
30.1 Finitura superficie #4000	2100				2500/5000				
30.2 Finitura superficie #3000	2100				2500/5000				
30.3 Finitura superficie #5000	2100				2500/5000				
40.1 Finitura sede pistoncina #5001	2000	18			2500				
40.2 Finitura sede pistoncina #5001	2000	18			2500				
40.3 Finitura sede pistoncina #4001	2000	18			2500				
50.1 Profilo #4002	6000	10,3			1500			0,435	
50.2 Profilo #4003	6000	10,3			1500			0,435	

Tool Management system Model using a BPR approach IDEF0-based

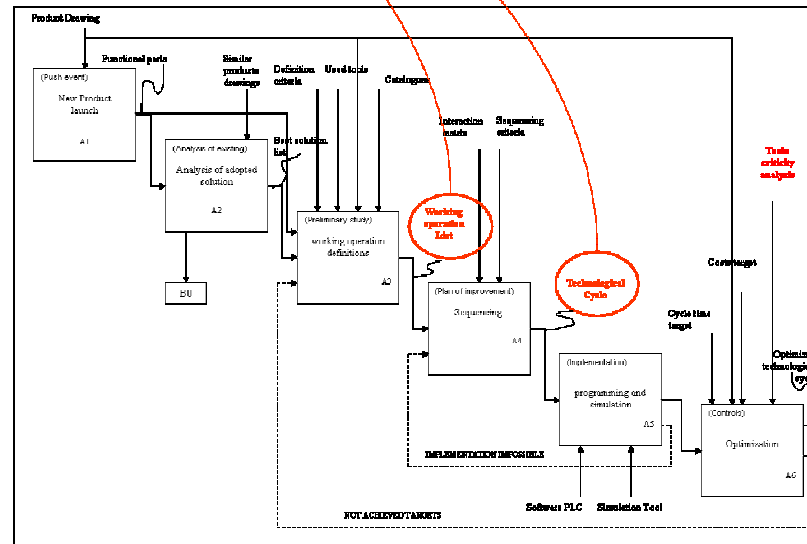

BOSCH



Renewable Energy systems tech....

© Prof. Ing. Michele DASSISTI

Politecnico di Bari – DMMM – V.le Japigia 182 – 70126 BARI

Tel. 080 – 596.2747; fax 080-5962.788; mobile: 329 650 6022; m.dassisti@poliba.it

9

4th International Conference on Sustainable Energy & Environmental Protection

June 29/July 02, 2010
Politecnico di Bari, BARI - ITALY

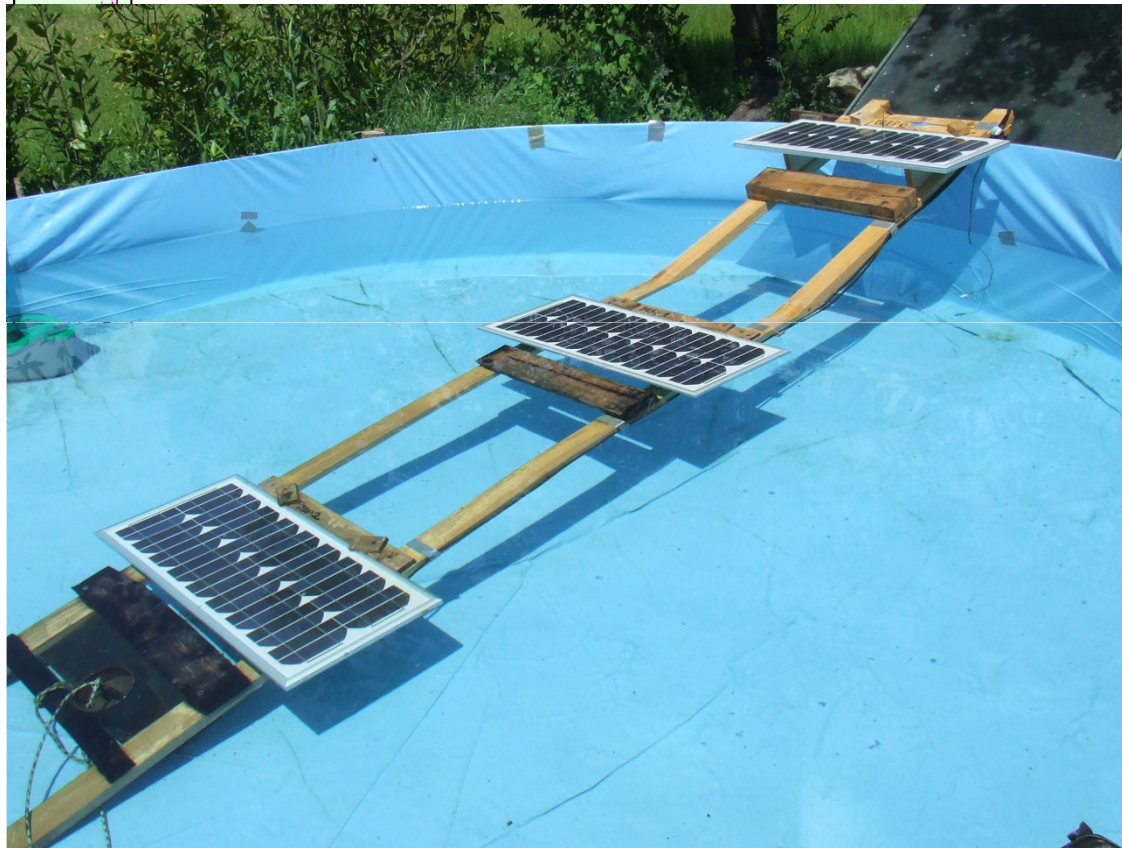

New solutions

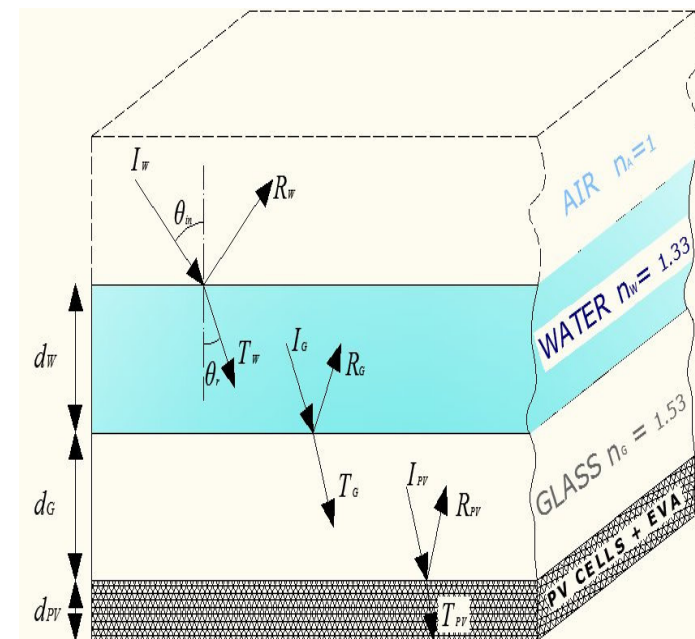

4th International Conference on Sustainable Energy & Environmental Protection

June 29/July 02, 2010
Politecnico di Bari, BARI - ITALY

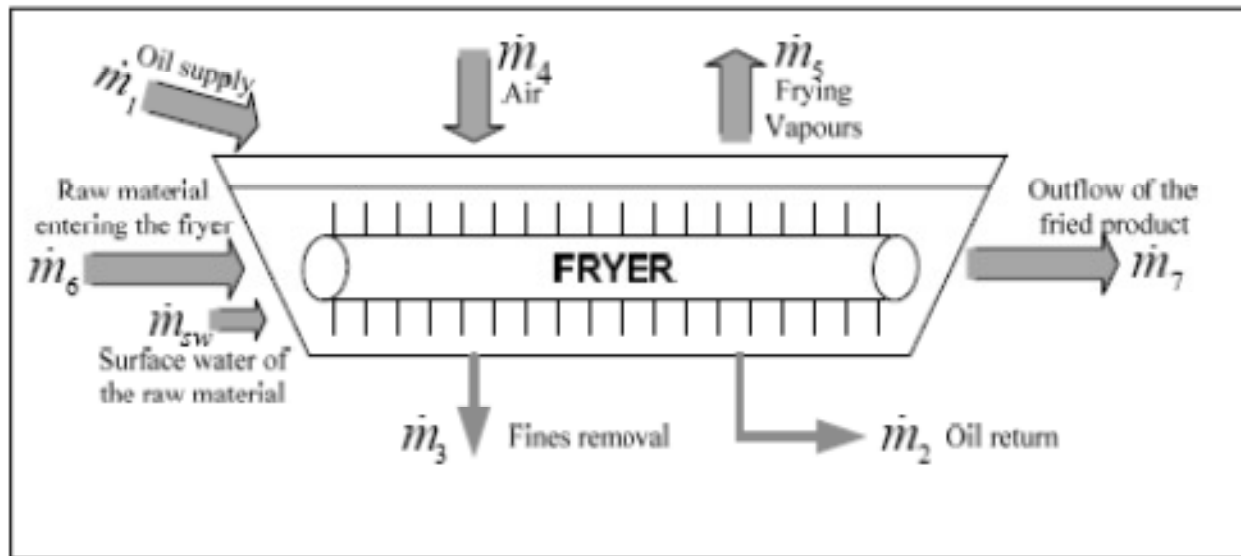

From kitchen.....

Figure 2. Mass flow balance in the industrial frying process.





4th International Conference on
Sustainable Energy & Environmental Protection

June 29/July 02, 2010
Politecnico di Bari, BARI - ITALY



Water flows.....

Gravity forces

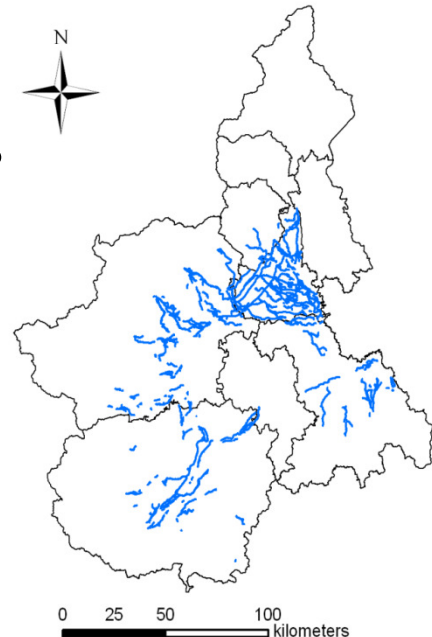

But not only in Italy



PLANTS AND STRUCTURES – Photovoltaic Roofs

© Prof. Ing. Michele DASSISTI

Politecnico di Bari – DMIMM – V.le Japigia 182 – 70126 BARI
Tel. 080 – 596.2747; fax 080-5962.788; mobile: 329 650 6022; m.dassisti@poliba.it



The conceived fixing systems allow acquiring the total integration for the almost totality of the roofs and obtaining so a best tariff.

Our structures for the **photovoltaic roofs** allow exploiting completely the coverings, even if in presence of skylights and obstacles of various kinds.



kad3

ALI
INNOVAZIONE TECNOLOGICA

HORUS
sostenibilità e sviluppo

KAD3 GROUP



PLANTS AND STRUCTURES – Photovoltaic Canopies

The **photovoltaic** parking canopies allow carrying out at the same time the requalification of parking areas and the production of electric energy.

Our canopies have been developed in various dimensions to comply with the particular requirements of the already built parking areas, by being so, extremely versatile for the realization of coverings for parking surfaces to be carried ex-novo.



We also make wooden shelters.



© Prof. Ing. Michele DASSISTI
Politecnico di Bari – DMIM – V.le Japigia 182 – 70126 BARI
Tel. 080 – 596.2747; fax 080-5962.788; mobile: 329 650 6022; m.dassisti@poliba.it

kad3

ALI
INNOVAZIONE TECNOLOGICA

HORUS
sostenibilità e sviluppo

KAD3 GROUP



COGENERATION AND TRIGENERATION

The **cogeneration** is the joint and contemporary production of electric energy and heat starting from a single energy source, actuated in a unique integrated system, with consequent economical and environmental benefits for the Client with respect to the separated electricity and heat production.

The **trigeneration** is the contemporary production of electric energy, heat and cooling power.

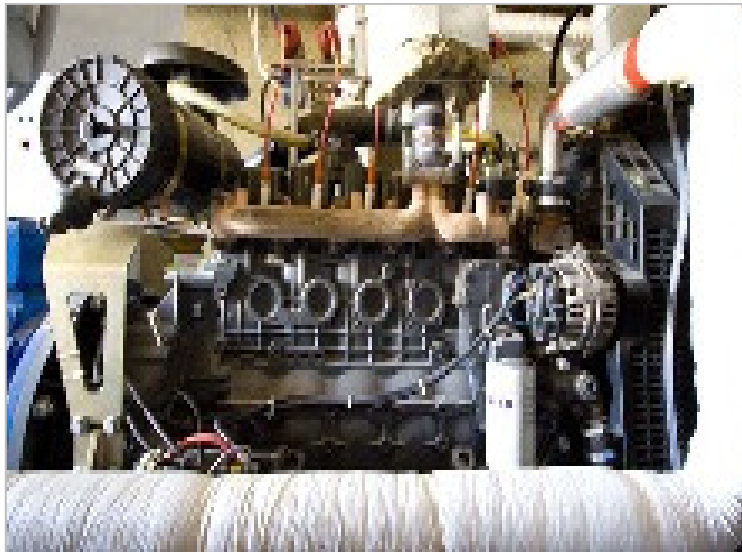

© Prof. Ing. Michele DASSISTI

Politecnico di Bari – DMIM – V.le Japigia 182 – 70126 BARI

Tel. 080 – 596.2747; fax 080-5962.788; mobile: 329 650 6022; m.dassisti@poliba.it

kad3

ALI
INNOVAZIONE TECNOLOGICA

HORUS
sostenibilità e sviluppo

KAD3 GROUP



Hybrid RE systems: research networks

© Prof. Ing. Michele DASSISTI
Politecnico di Bari – DMMM – V.le Japigia 182 – 70126 BARI
Tel. 080 – 596.2747; fax 080-5962.788; mobile: 329 650 6022;
m.dassisti@poliba.it

Reliable Modular Hybrid System for Off-Grid or Grid Supported application

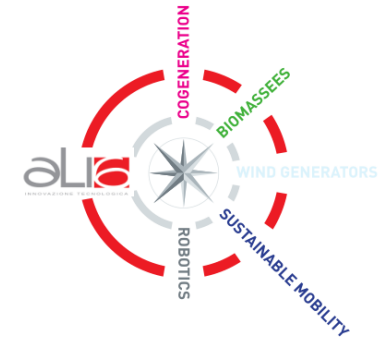
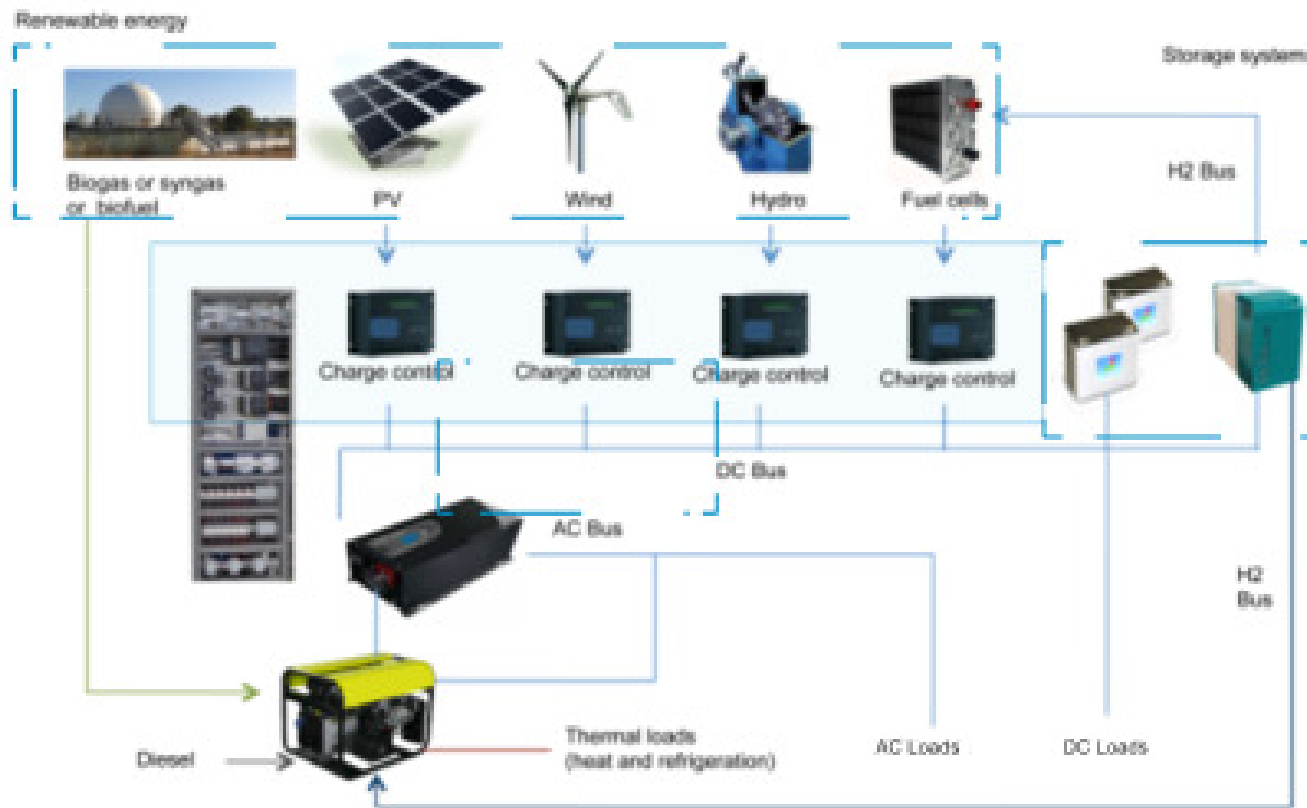



Hybrid RE systems

© Prof. Ing. Michele DASSISTI

Politecnico di Bari – DMMM – V.le Japigia 182 – 70126 BARI

Tel. 080 – 596.2747; fax 080-5962.788; mobile: 329 650 6022; m.dassisti@poliba.it



DATA SHEET 5 kW

Leonardo Smart Control Unit is a Hybrid Energy System born to satisfy the needs of Off-Grid of even Grid Supported loads

The main skills of **Leonardo** are:

- | | |
|--|---|
| • Continuous power AC (not interruptible loads): | 5 kW (2 kW); |
| • Peak power AC: | 10 kW; |
| • Continuous power DC: | 2 kW; |
| • Peak power DC: | 5 kW; |
| • Available RE sources (max Power): | PV (5 kWp);
Wind (5 kWp);
Hydro (10 kWp);
Fuel cells (2 kW); |
| • Genset power: | 13 kVA; |
| • Cogenerator (as optional) thermal power: | 10 kW; |
| • Multifuel genset (as optional): | Biogas
Syngas
Vegetable oil
Bioethanol |



Hybrid RE systems

© Prof. Ing. Michele DASSISTI
Politecnico di Bari – DMMM – V.le Japigia 182 – 70126 BARI
Tel. 080 – 596.2747; fax 080-5962.788; mobile: 329 650 6022; m.dassisti@poliba.it



Configuration 5
Hybrid Renewable Hydro
Cogeneration Island
(HyREI-H2c)

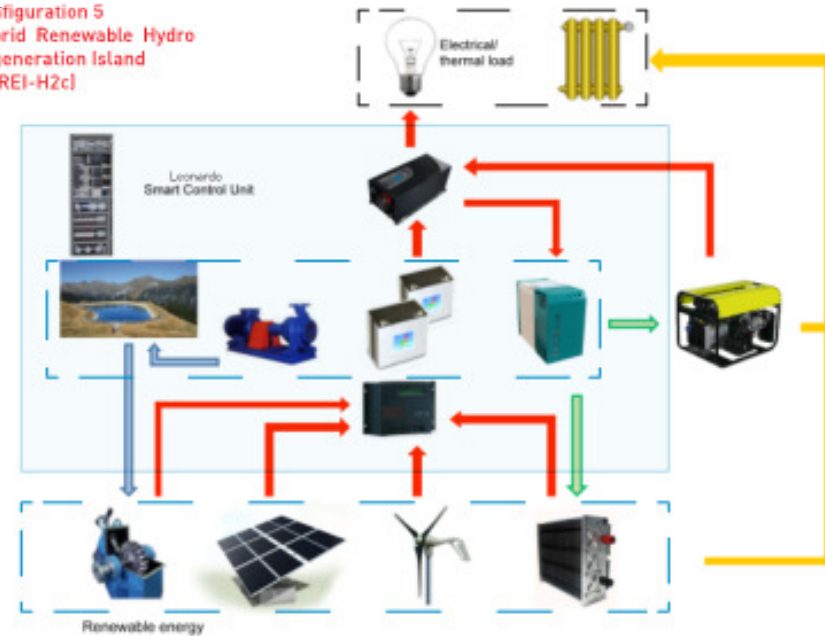



Woodchips

© Prof. Ing. Michele DASSISTI

Politecnico di Bari – DMMM – V.le Japigia 182 – 70126 BARI

Tel. 080 – 596.2747; fax 080-5962.788; mobile: 329 650 6022; m.dassisti@poliba.it





Gasifier from woodchips

© Prof. Ing. Michele DASSISTI

Politecnico di Bari – DMMM – V.le Japigia 182 – 70126 BARI

Tel. 080 – 596.2747; fax 080-5962.788; mobile: 329 650 6022; m.dassisti@poliba.it





© Prof. Ing. Michele DASSISTI

Politecnico di Bari – DMMM – V.le Japigia 182 – 70126 BARI

Tel. 080 – 596.2747; fax 080-5962.788; mobile: 329 650 6022; m.dassisti@poliba.it



Gasifier from woodchips



Combustion Engine

© Prof. Ing. Michele DASSISTI

Politecnico di Bari – DMMM – V.le Japigia 182 – 70126 BARI

Tel. 080 – 596.2747; fax 080-5962.788; mobile: 329 650 6022; m.dassisti@poliba.it





Innovation in tradition....

© Prof. Ing. Michele DASSISTI

Politecnico di Bari – DMMM – V.le Japigia 182 – 70126 BARI

Tel. 080 – 596.2747; fax 080-5962.788; mobile: 329 650 6022; m.dassisti@poliba.it

10



Innovation in tradition

© Prof. Ing. Michele DASSISTI
Politecnico di Bari – DMMM – V.le Japigia 182 – 70126 BARI
Tel. 080 – 596.2747; fax 080-5962.788; mobile: 329 650 6022; m.dassisti@poliba.it



Michele DASSISTI

m.dassisti@poliba.it

<http://hychange-lab.poliba.it/>



.Fronteer Research at Politecnico di Bari.

© Prof. Ing. Michele DASSISTI

Politecnico di Bari – DMIM – V.le Japigia 182 – 70126 BARI

Tel. 080 – 596.2747; fax 080-5962.788; mobile: 329 650 6022; m.dassisti@poliba.it

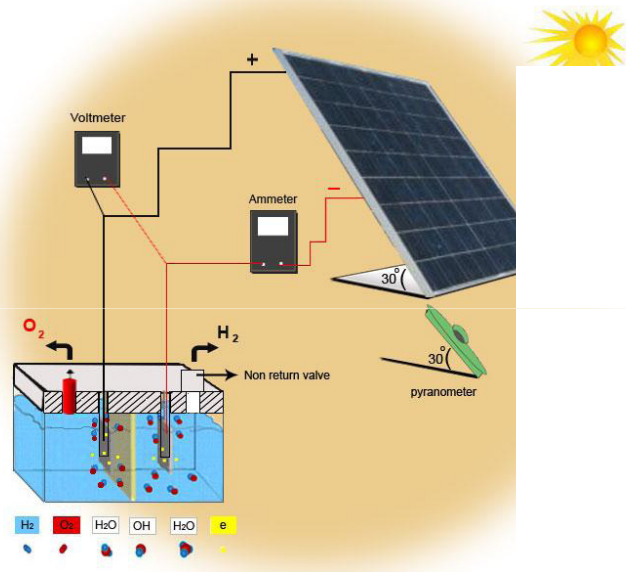

HYDROGEN

Concentrated Solar Radiation

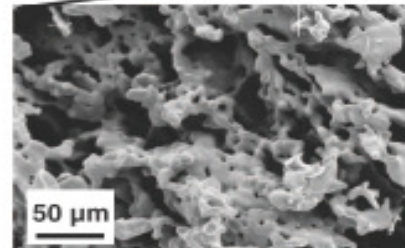
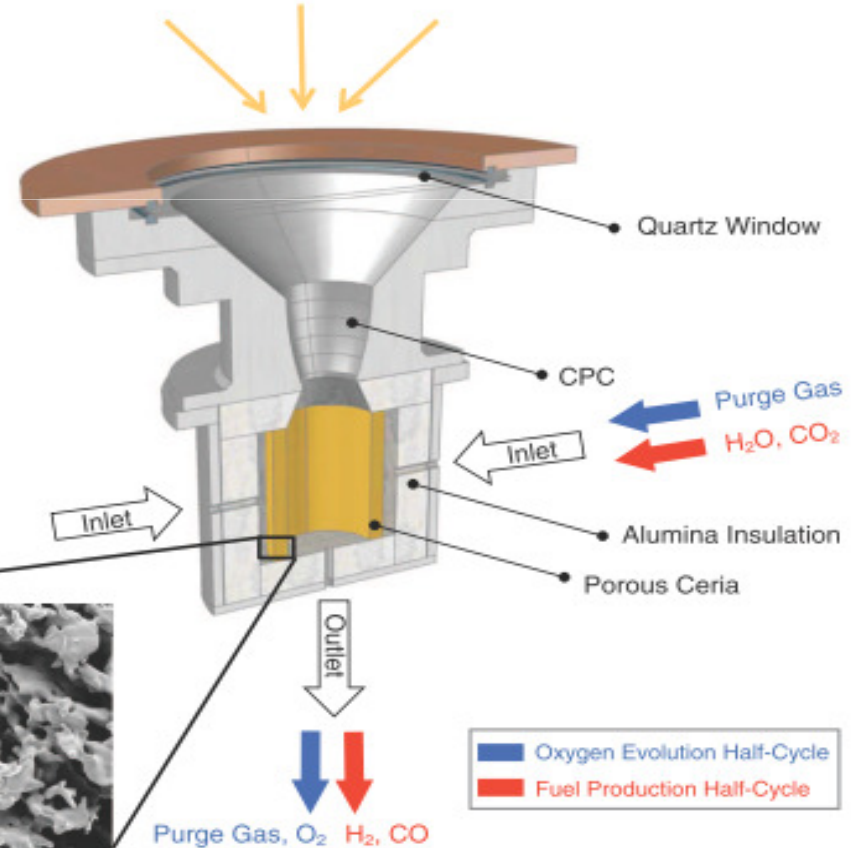

4th International Conference on Sustainable Energy & Environmental Protection

June 29/July 02, 2010
Politecnico di Bari, BARI - ITALY

© Prof. Ing. Michele DASSISTI
Politecnico di Bari – DMM – V.le Japigia 182 – 70126 BARI
Tel. 080 – 596.2747; fax 080-5962.788; mobile: 329 650 6022; m.dassisti

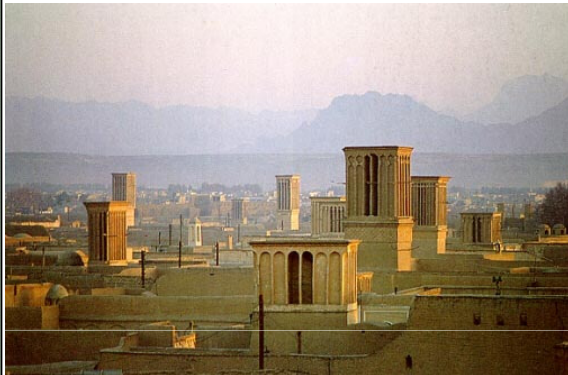

Yadz (Iran):
At desert border's
Wind catcher: natural
thermoregulation



*<<Home design was different in past for many cities,
but new architects and engineers have not been
using passive solar issues for their designs>>*



Natural refrigeration:
from water

Old walls : oltre 1m di thickness,,,

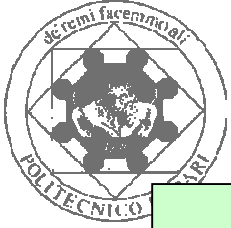

SUSTAINABILITY: it is a business?

- New approach with old habits?
- Attempt to preserve the present?



6-R's:

*Reduce, Reuse, Recycle,
Redesign (or
Rethinking), Recover,
Remanufacture,*

LINEAR THINKING!

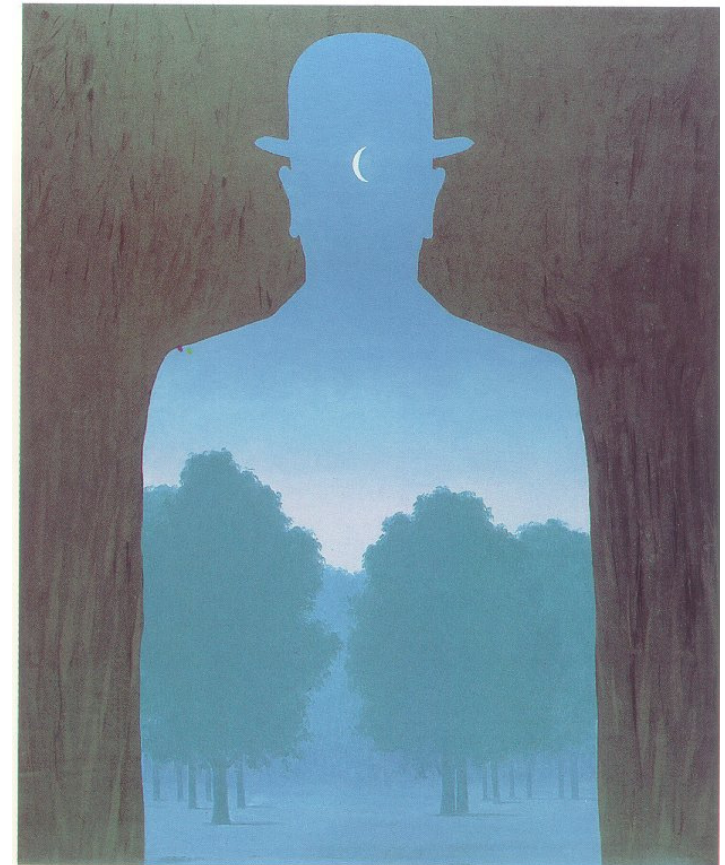



4th International Conference on
Sustainable Energy & Environmental Protection

June 29/July 02, 2010
Politecnico di Bari, BARI - ITALY

© Prof. Ing. Michele DASSISTI
Politecnico di Bari – DMMM – V.le Japigia 182 – 70126 BARI
Tel. 080 – 596.2747; fax 080-5962.788; mobile: 329 650 6022; m.dassisti



Recycled Aluminum

Optimise, minimize, ...but is
is always resource tranf.!!

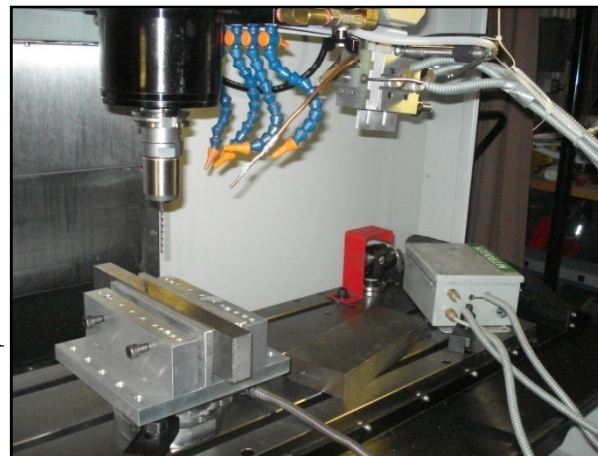

Drilling of Ti-6Al-4V with 3mm
diameter carbide uncoated drills and
aspect ratio of 15



Minimum quantity lubrication



Eco-X syntagms: codification or real solutions?

- X= design, redesign, innovation, conception, QFD, labelling, optimization, balance, centric sustainability, development planning, advantage strategy, magination, tracking, technology, restructuring,.. .

- *<<the eco-support system for life on the planet (e. g. biodiversity), a factor of recognising the regional carrying-*
- *capacity of nature with regard to human populations*
- *and human lifestyles, going back to Jean-Jacques Rousseau (1712-1778)... >> Stabel 2007*



7th R's rule: Regulation

- ISO14040
- SETAC
- UNEP
- OECD
- US Department of Commerce
- ...

- *« Nearly all governments have committed themselves to sustainable development by integrating economic welfare, environmental quality and social coherence »» Boringer & Jochem, 2007*



8th R's rule: Reversibility

- This principle brings to the extreme the idea of recycle, reuse, recover and remanufacture., all sharing the idea of prolonging the useful functions of artifacts as longer as possible in the future, by introducing the challenge to avoid the losses of cycling effects that is intrinsic in the other R's

- *«The law of entropy should be replaced by the law of regeneration. The present law does not make sense for the world we need to create. ' ' .. >> Cohen-Rosenthal, 2004*

4th International Conference on Sustainable Energy & Environmental Protection

June 29/July 02, 2010
Politecnico di Bari, BARI - ITALY

isi

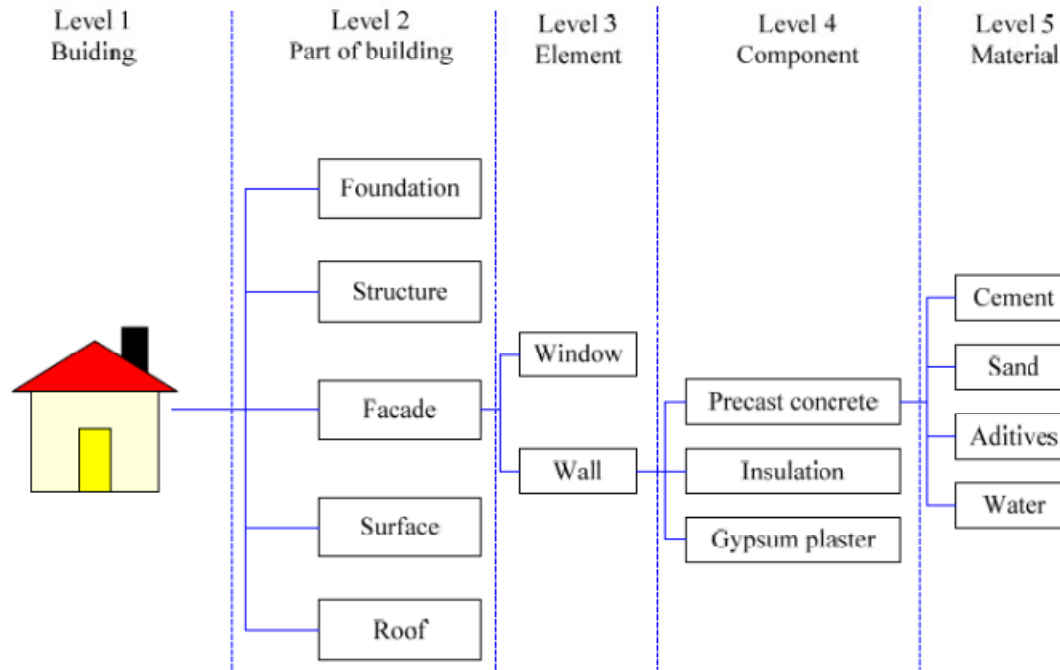

Figure 1. Levels of the construction product life cycle

Ventilated Trombe wall adapted to the site of the town of Bechar (south-west of Algeria)



Sustainable Buildings: LCA



Culture and training

© Prof. Ing. Michele DASSISTI

Politecnico di Bari – DMMM – V.le Japigia 182 – 70126 BARI

Tel. 080 – 596.2747; fax 080-5962.788; mobile: 329 650 6022; m.dassisti@poliba.it

10



Cultural struggle...

- <<Sustainability is in our own responsibility either as perception (as IO) or as actors (inducing transformations): it is strictly related to our needs.
- The best eco-design strategy cannot afford a crazy need!>> Dassisti, 2009

© Prof. Ing. Michele DASSISTI
Politecnico di Bari – DMMM – V.le Japigia 182 – 70126 BARI
Tel. 080 – 596.2747; fax 080-5962.788; mobile: 329 650 6022; m.dassisti@poliba.it





Alternatives to our current wasteful product paradigm

© Prof. Ing. Michele DASSISTI
Politecnico di Bari – DMMM – V.le Japigia 182 – 70126 BARI
Tel. 080 – 596.2747; fax 080-5962.788; mobile: 329 650 6022; m.dassisti@poliba.it

Firefox

http://www.agencyofdesign.co.uk/

AVIRA POLIBA_mail PolIBA MIUR CINECA CASPUR_biblio Borsa della Ricerca CLIMEG Google EN-IT EN-DE FR_IT MAM Wetterzent Bookmarks

The Agency of Design

The Agency of Design

Translating sustainable theory into practice.

The *agency* of design represents our capacity to affect change through design choices and understand the impact of these choices on the world.

Having worked together at the Royal College of Art and Imperial College London; Rich Gilbert, Adam Paterson and Matthew Laws joined forces to form the agency in 2009.

Current

Home

Projects

- Design Out Waste
- Embodied
- The Climate Machine
- Manufacturer to Consumer
- Previous Projects

Information

- About Us
- Exhibitions and Awards
- Contact Us

Start | Skype... | Micros... | sourc... | 4 Es... | ebook... | Th... | Micros... | IT | 18.02

SEEP 2010



..knowledge is the key..



4th International Conference on
Sustainable Energy & Environmental Protection

June 29/July 02, 2010
Politecnico di Bari, BARI - ITALY

© Prof. Inno. Michela D'ASSISI
Politecnico di Bari
Tel. 080

La conoscenza e la
formazione sono
efficacia

MATto

The material library of the Course of Industrial Design Studies at the Politecnico di Torino, which, today, stores approximately 500 samples of innovative material particularly used in the field of design and architecture.

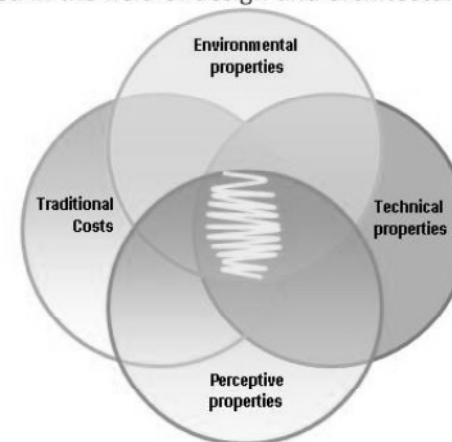



One didactical example: new generations challenges

© Prof. Ing. Michele DASSISTI

Politecnico di Bari – DMMM – V.le Japigia 182 – 70126 BARI

Tel. 080 – 596.2747; fax 080-5962.788; mobile: 329 650 6022; m.dassisti@poliba.it

- Wood sail boats at Politecnico di Bari



MilleUnaVela



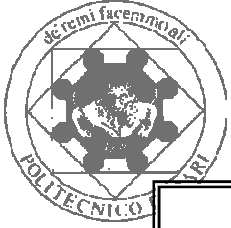

One didactical example: ecological materials

- Challenge: at least 85% in weight of wood

© Prof. Ing. Michele DASSISTI

Politecnico di Bari – DMMM – V.le Japigia 182 – 70126 BARI
Tel. 080 – 596.2747; fax 080-5962.788; mobile: 329 650 6022; m.dassisti@poliba.it





One didactical example: ecological materials

- Wood processing
(-)
- Adhesives (--)



- Wood end-of-life (+)
- Propulsion
(++)



© Prof. Ing. Michele DASSISTI

Politecnico di Bari – DMMM – V.le Japigia 182 – 70126 BARI

Tel. 080 – 596.2747; fax 080-5962.788; mobile: 329 650 6022; m.dassisti@poliba.it

WHEN'S



Can we change abruptly?

The manufacturing industry has generated wealth, jobs and quality of life, while promoting and sustaining services, education, research and development



Another pillar?

Sustainable development / growth

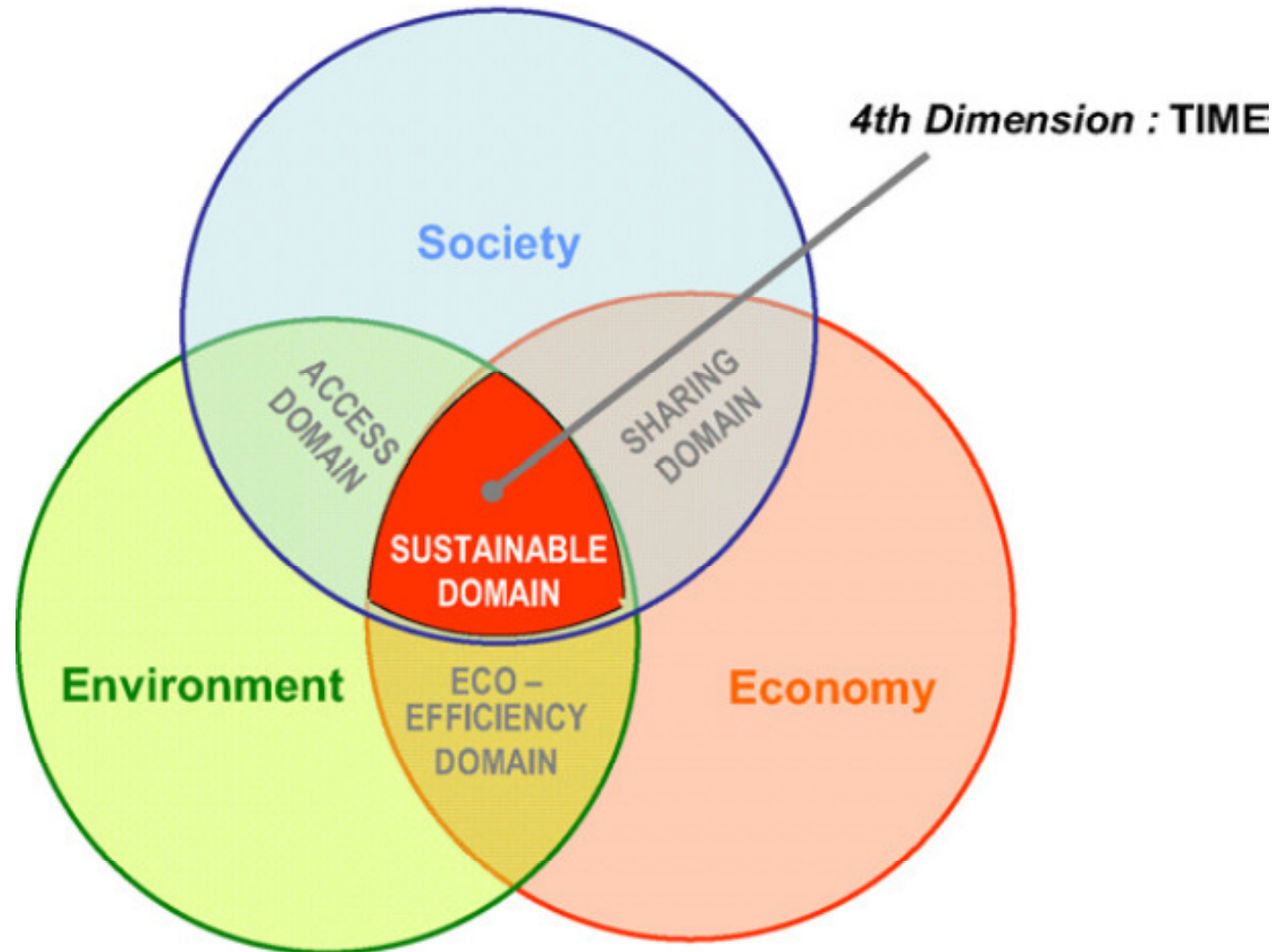

© Prof. Ing. Michele DASSISTI

Politecnico di Bari – DMMM – V.le Japigia 182 – 70126 BARI

Tel. 080 – 596.2747; fax 080-5962.788; mobile: 329 650 6022; m.dassisti@poliba.it



Finitedness of resources

© Prof. Ing. Michele DASSISTI
Politecnico di Bari – DMMM – V.le Japigia 182 – 70126 BARI
Tel. 080 – 596.2747; fax 080-5962.788; mobile: 329 650 6022; m.dassisti@poliba.it

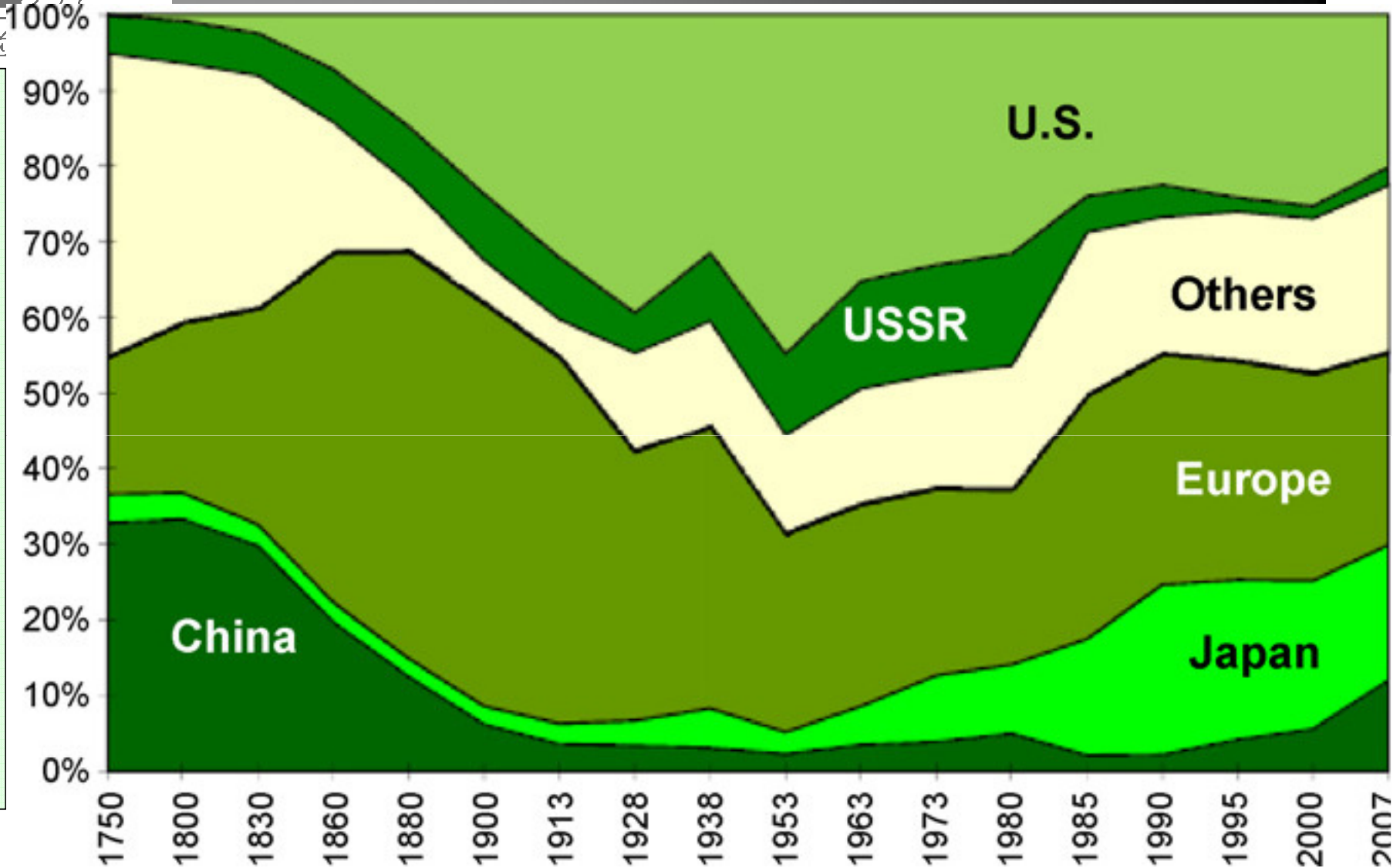

A different perspective of industrial outputs....



MANUFACTURING: its non-reversible effects on the world

- So we humankind have an hysteresis in behavioral changes while experiencing almost immediate reactions in the mutations of our world.

© Prof. Ing. Michele DASSISTI

Politecnico di Bari – DMMM – V.le Japigia 182 – 70126 BARI

Tel. 080 – 596.2747; fax 080-5962.788; mobile: 329 650 6022; m.dassisti@poliba.it

*Manufacturing might
have non-linear
effects on our way
of living*

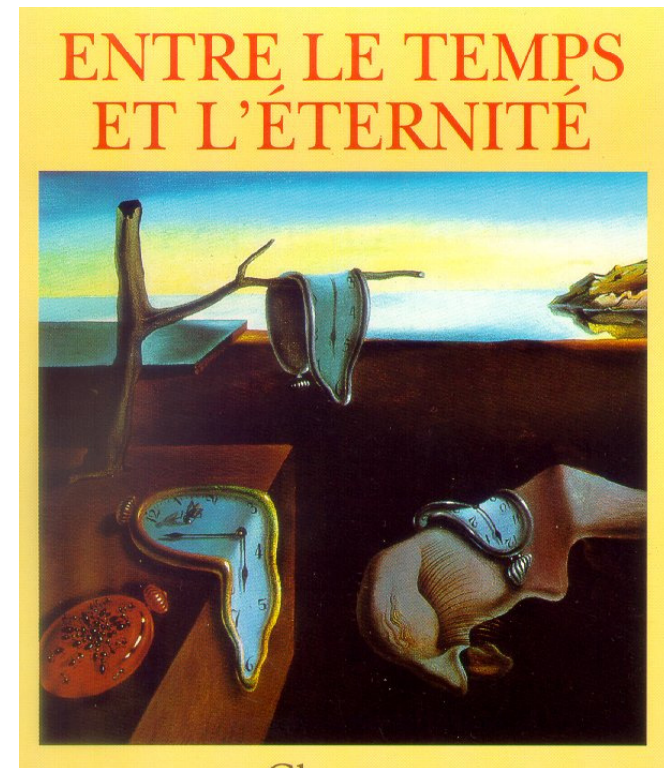



© Prof. Ing. Michele DASSISTI

Politecnico di Bari – DMMM – V.le Japigia 182 – 70126 BARI

Tel. 080 – 596.2747; fax 080-5962.788; mobile: 329 650 6022; m.dassisti@poliba.it

CONCLUSIONS



Oximoros?

- **Innovation in tradition**
- **Chaos and harmony**
- **Industrial ecology**
- **Sustainability and production**

• *<<The ideal ecosystem, in which the use of energy and materials is optimized, wastes and pollution are minimized and there is an economically viable role for every product of a manufacturing process, will not be attained soon. >> Frosch, 1989*



Best practice diffusion

poliba.it

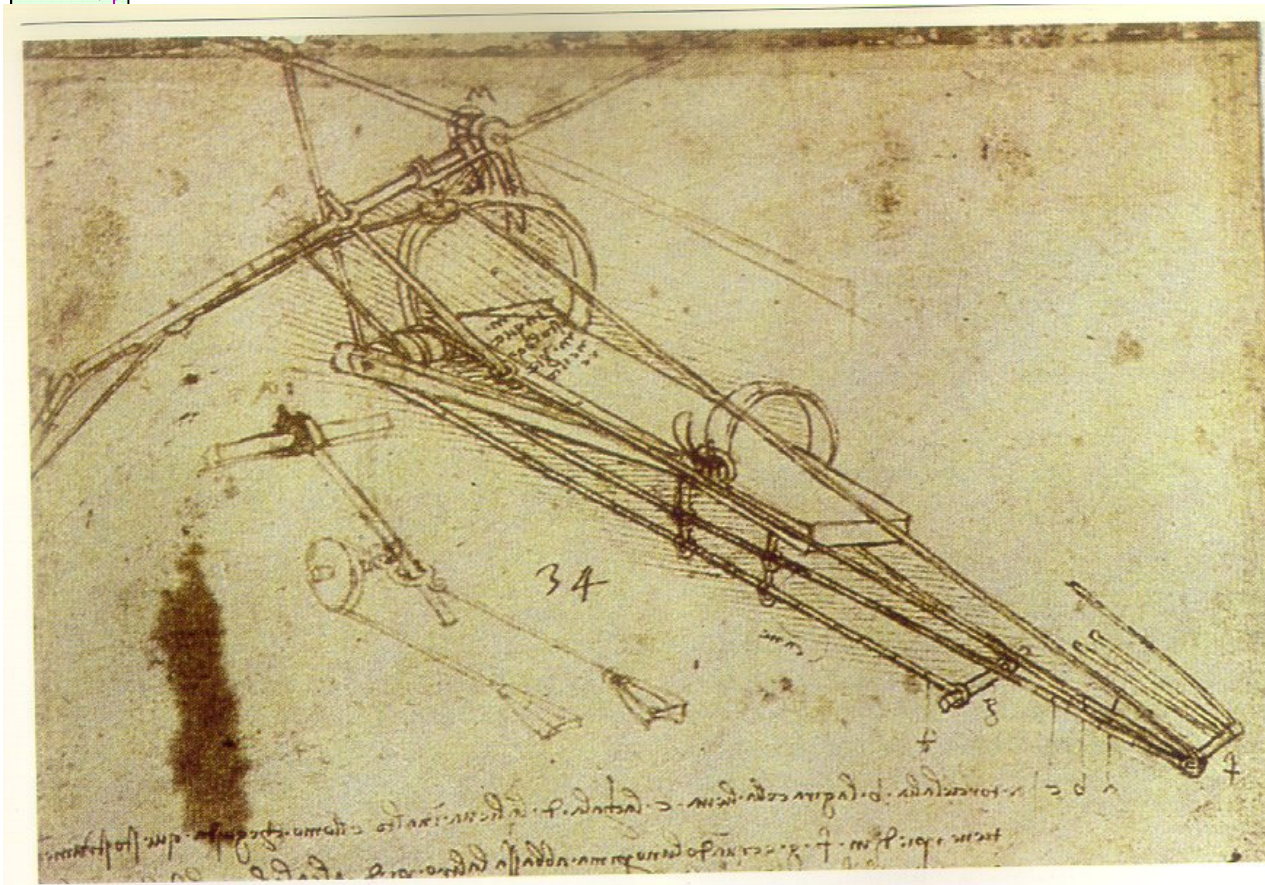



New Job Opportunities

© Prof. Ing. Michele DASSISTI

Politecnico di Bari – DMMM – V.le Japigia 182 – 70126 BARI
Tel. 080 – 596.2747; fax 080-5962.788; mobile: 329 650 6022; m.dassisti@poliba.it

CAREER

Graduated Industrial Ecologists will be able to analyse sustainability dilemmas in real life, to create and initiate innovative technological solutions, and to come up with tools and strategies for management and policy in the field of Industrial Ecology. Industrial Ecology is a new scientific field that provide graduates promising opportunities in different fields:

- **Intermediate functions in large companies considering sustainability issues**
- **System design functions in companies and governments**
- **Initiators of innovation in industry and (non) governmental organizations**
- **Scientific research in the field of industrial ecology or related fields like green engineering, environmental sciences, or innovation and transition management.**

Until now almost all graduates of the programme find a suitable job within a year after graduation. Alumni of the programme can be found in industry, consultancy firms and governmental agencies. A small fraction ends up as Industrial Ecology scientists working at universities and research institutes, developing the field.



New Job Opportunities

© Prof. Ing. Michele DASSISTI
Politecnico di Bari – DMMM – V.le Japigia 182 – 70126 BARI
Tel. 080 – 596.2747; fax 080-5962.788; mobile: 329 650 6022; m.dassisti@poliba.it

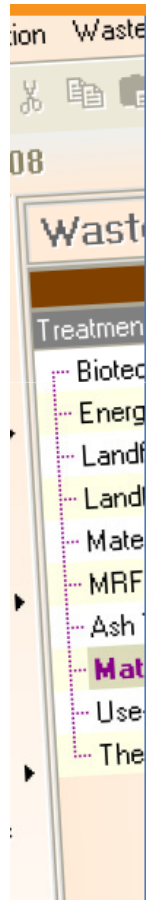

Training course 6th - 10th of June, 2011
For PhD students (5 ECTS) and consultants

EASEWASTE

Life cycle assessment tool for integrated solid waste management

EASEWASTE – The DTU LCA-model for waste management – now available for consultants, contractors, technology developers, public authorities and academia.

EASEWASTE quantifies resources and potential environmental impacts from waste management - including loads and savings in greenhouse gas emission.



New Job Opportunities

© Prof. Ing. Michele DASSISTI
Politecnico di Bari – DMMM – V.le Japigia 182 – 70126 BARI
Tel. 080 – 596.2747; fax 080-5962.788; mobile: 329 650 6022; m.dassisti@poliba.it

Waste-to-Energykursus2011.pdf (PROTETTO) - Adobe Reader

File Modifica Vista Documento Strumenti Finestra ?

68,2% Trova

PhD Course 07th-11th November, 2011

Advanced Environmental Assessment of Waste-to-Energy Technologies

DTU DTU Environment
Department of Environmental Engineering

Access to the course

- Application should be sent to 3r@env.dtu.dk. Application form is available at www.3r.env.dtu.dk.
- Deadline for applications is August 21st 2011.
- The course is restricted to 25 participants. In case more than 25 applications are received, participants will be selected based on relevance, participant diversity, and according to the application submitted.
- Acceptance will be communicated by September 10th, 2011.
- For more information, please visit www.3r.env.dtu.dk or write an e-mail to 3r@env.dtu.dk.

Course prerequisites:

Participants should document intermediate/advanced knowledge about waste management and LCA (preferably if related to waste management). Basic information about LCA and/or waste management is not provided during the course.

Fee:

Academic participants: 100€.

The course includes:

- 5 days of intensive course (9-18) with lectures, group work, discussion sessions, exercises, presentation by the participants.
- Materials, lunches, coffee, refreshments during the day.
- Consultation on research activities regarding LCA of WtE systems.
- Social dinner

The course does not include:

- Hotels/accommodation
- Transportation from and to the hotel

Course evaluation:

The participant is evaluated on a pass/fail basis. The course requires full participation in the five days programme with active contribution in the discussion. Completion of reading material prior to the course is evaluated by delivery of two pre-assignments and completion of exercises in the class during the course.

PhD Course – 4 ECTS

ADVANCED ENVIRONMENTAL ASSESSMENT OF WASTE-TO-ENERGY TECHNOLOGIES

07th - 11th November, 2011

Waste incineration is a well established technology and an important component of modern waste management systems. Incineration is currently used to treat about 20% of the waste in Europe and represents the most commonly employed WtE technology. However, a variety of different thermal treatment technologies are available and even more will arrive in the near future because of the rapidly evolving research in the field.

The course consists of an overview of the most important waste-to-energy technologies, with special focus on operative conditions and feedstock to the different technologies. The course will highlight important issues to focus on during data collection and system boundary definitions. A broad range of case studies will be presented covering many of the important aspects.

At the end of the course, participants will have a broader understanding of different thermal treatment options and how they are integrated into the energy system. Furthermore, participants will be able to assess and discuss critical assumptions made in LCA studies on waste-to-energy technologies.

DTU Environment
Department of Environmental Engineering

3R
Waste-to-Energy
Research



Thank you



Michele DASSISTI

m.dassisti@poliba.it

<http://hychange-lab.poliba.it/>

Most of the images have been taken from free access on Google the Sept.16, 2010



DEBATES

© Prof. Ing. Michele DASSISTI

Politecnico di Bari – DMMM – V.le Japigia 182 – 70126 BARI

Tel. 080 – 596.2747; fax 080-5962.788; mobile: 329 650 6022; m.dassisti@poliba.it

1. _____
2. _____
3. _____
4. _____
5. _____



What is sustainability?

© Prof. Ing. Michele DASSISTI

Politecnico di Bari – DMM – V.le Japigia 182 – 70126 BARI
Tel. 080 – 596.2747; fax 080-5962.788; mobile: 329 650 6022; m.dassisti@poliba.it

- <<To maintain the quality. All the machines that are producing nowadays to be asable after a longtome after that.>> **Ilia Stanchev**.
- <<Way to protect the quality of life for humanity in the time>> **Alexander Ecanomau**.
- <<Ability to save the balance nature and technical progress, as long as we can>> **Emil Mihaglov**
- <<Ability or property of a system to be optimised in a beginning of project and this will save the idea, the same system in time>> **Nedko Perchemliev**
- <<It has to do with a balaced life>> **Denise Beskou**
- <<TO assure to our children and grandchildren good life. We have to save the balance in nature>> **Mirela Georgieva**
- <<Don't know>> **Mourtzikou Argyroula & Andigoni Aposfolopoulou & Mirto Micholou**
- <<Petrouleum man will die>> **Francesco Del Vecchio**
- <<Wel development from every point of view: environmental, economical and political>> **A. Penchev**
- <<The way to make Earth a better place to be. Change the way we live and consume in a most ECO-friendly way>> **Dimosthenis Boeklagis**
- <<Property of a product to preserve highest quality of itself through longest possible period of time>> **Dobromora Lekova**
- <<Ability to maintain a certain level of rate, for example, conserving balance by avoiding depletion of natural resources>> **Vareli Styliani**
- <<It is the same timng as life. We must protect our environment for life>> **Alexopullous Argyrios**